



U.S. DEPARTMENT OF
ENERGY

DOE/EIS-0486

Final

PLAINS & EASTERN CLEAN LINE TRANSMISSION PROJECT
ENVIRONMENTAL IMPACT STATEMENT

Volume IV of VIII

U.S. DEPARTMENT OF ENERGY
Office of Electricity Delivery and Energy Reliability
Washington, DC

October 2015

This page intentionally left blank.

APPENDIX B

PRIMARY CORRESPONDENCE BETWEEN DOE AND FEDERAL AGENCIES



This page intentionally left blank

Primary Correspondence between DOE and Federal Agencies

Correspondence from and to federal agencies is presented in this appendix as listed below:

LETTERS TO FEDERAL AGENCIES	
AGENCY	DATE
Advisory Council on Historic Preservation	
To: J. Fowler, Office of the Executive Director, ACHP	November 20, 2012
To: J. Loichinger, ACHP	January 17, 2014
To: J. Loichinger, ACHP	March 11, 2014
To: ACHP—email	November 13, 2014
Bureau of Indian Affairs	
Cherokee Nation	November 6, 2012
Eastern Oklahoma Region	November 6, 2012
Horton Agency	November 6, 2012
Pawnee Agency (Pawnee Nation)	November 6, 2012
Southern Plains Region	November 6, 2012
Environmental Protection Agency	
Region 4 NEPA Program Office	November 6, 2012
Region 6 Office of Planning and Coordination	November 6, 2012
Tennessee Valley Authority	
Tennessee Valley Authority	November 6, 2012
Natural Resources Conservation Service	
Arkansas	November 6, 2012
Easement Programs Division	November 6, 2012
Oklahoma	November 6, 2012
Tennessee	November 6, 2012
U.S. Army Corps of Engineers	
Regulatory Office—Tulsa	November 6, 2012
Little Rock District	November 6, 2012
Memphis District	November 6, 2012
Tulsa District	November 6, 2012
U.S. Department of Agriculture—Forest Service	
Ozark St. Francis National Forest	October 31, 2013
U.S. Department of Interior—National Park Service	
National Park Service	February 10, 2015
U.S. Fish and Wildlife Service	

Arkansas Ecological Field Services Field Office	November 6, 2012
Central Arkansas National Wildlife Refuge	November 6, 2012
Oklahoma Ecological Services Field Office	November 6, 2012
Oklahoma Ecological Services Field Office	January 17, 2013
Tennessee Ecological Services (Cookeville) Field Office	November 6, 2012

LETTERS FROM FEDERAL AGENCIES	
AGENCY	DATE
Advisory Council on Historic Preservation	
From: J. Fowler, Office of the Executive Director, ACHP	February 12, 2014
From: C.D. Vaughn, Office of Federal Agency Programs, Federal Permitting, Licensing, and Assistance Section	February 19, 2014
From: C.D. Vaughn, Office of Federal Agency Programs, Federal Permitting, Licensing, and Assistance Section	September 18, 2014
From: C.D. Vaughn, Office of Federal Agency Programs, Federal Permitting, Licensing, and Assistance Section	January 27, 2015
From: J. Loichinger, ACHP—email	April 7, 2015
From: C.D. Vaughn, Office of Federal Agency Programs, Federal Permitting, Licensing, and Assistance Section	April 20, 2015
From: J. Loichinger, ACHP—email	April 29, 2015
From: C.D. Vaughn, Office of Federal Agency Programs, Federal Permitting, Licensing, and Assistance Section	June 22, 2015
Environmental Protection Agency	
Region 6—Compliance Assurance and Enforcement Division	December 19, 2012
Natural Resources Conservation Service	
Little Rock, Arkansas	No date
U.S. Department of Agriculture—Forest Service	
Ozark St. Francis National Forest	September 30, 2013
U.S. Environmental Protection Agency	
Region 6	April 15, 2015
U.S. Department of Interior—National Park Service	
National Trails—Intermountain Region	February 20, 2015
National Trails—Intermountain Region	March 14, 2015
National Trails—Intermountain Region	March 19, 2013
Intermountain Region	April 1, 2015
Office of Environmental Policy and Compliance	April 20, 2015

U.S. Fish and Wildlife Service	
Region 2	March 21, 2013
Region 2	April 10, 2013
Region 2	July 9, 2013
Region 2	August 5, 2013
U.S. Army Corps of Engineers	
Little Rock District	December 6, 2012
Memphis District	March 12, 2013
Little Rock District	March 29, 2013
Little Rock District	April 20, 2015

This page intentionally left blank.

LETTERS TO FEDERAL AGENCIES

APPENDIX B
PRIMARY CORRESPONDENCE BETWEEN DOE AND FEDERAL AGENCIES

This page intentionally left blank.



Department of Energy
Washington, DC 20585

November 20, 2012

Mr. J. Fowler, Executive Director
Office of the Executive Director
Advisory Council on Historic Preservation
1100 Pennsylvania Ave., NW, Ste. 803
Washington, DC 20004

RE: Notice of National Historic Preservation Act (NHPA) and National Environmental Policy Act (NEPA) Integration for the Upcoming Plains & Eastern Clean Line Project Environmental Impact Statement (DOE/EIS-0486)

Dear Mr. Fowler:

Pursuant to the NHPA implementing regulations 36 CFR §800.8(c), the U.S. Department of Energy (DOE) is informing your office that the DOE intends to use the NEPA process and documentation required for the preparation of the EIS for the Plains & Eastern Clean Line Project (DOE/EIS-0486) to comply with Section 106 of the NHPA in lieu of the procedures set forth in §800.3 through §800.6 of the NHPA regulations.

This is in keeping with the NHPA's implementing regulations that "federal agencies are encouraged to coordinate compliance with Section 106 . . . with any steps taken to meet the requirements of the National Environmental Policy Act." (36 CFR §800.8(a)(1)).

By way of brief project description, Clean Line Energy Partners, LLC (Clean Line) applied to the DOE under Section 1222(b) of the Energy Policy Act of 2005, to work with and provide funds to DOE to develop a new +/- 600 kV high voltage direct current (HVDC) electric transmission line capable of transmitting over 3,500 MW of renewable energy generation from facilities in the Oklahoma panhandle region to load-serving entities in the southeastern United States via an interconnection with the Tennessee Valley Authority in western Tennessee near Memphis.

The HVDC transmission line would utilize two Alternating Current/Direct Current (AC/DC) converter stations, one at each end of the transmission line. The converter stations are proposed to be located in Texas County, Oklahoma, and Shelby County or Tipton County, Tennessee. Each converter station would be approximately 30 to 50 acres and would be located on private land. Right-of-way easements would be required for the transmission line and would have a typical width of approximately 150 to 200 feet. Tubular or lattice steel structures would be used to support the transmission line. Each structure would have a typical height from 120 to 200 feet, depending on site-specific conditions. Other limited quantities of larger specialty structures may be necessary to address engineering constraints in some locations.

Additionally, access roads, improvements to existing roads, new overland access, and new unpaved temporary roads would be required to access the transmission line and related facilities during the construction, operation and maintenance phases. Finally, ancillary facilities such as communication facilities for control and protection would be required.

I am looking forward to working with you during this consultation process. I welcome any questions or comments you may have and I can be reached at 720-356-1566 or via email at melissa.ardis@go.doe.gov.

Sincerely,

A handwritten signature in black ink, appearing to read 'MA', with a long horizontal flourish extending to the right.

Melissa Ardis
DOE NEPA Deputy Document Manager

cc: Jane Summerson, Ph.D., DOE NEPA Document Manager
Lee Webb, Program Analyst and Liaison to DOE



Department of Energy
Washington, DC 20585

January 17, 2014

Jaime Loichinger
Advisory Council on Historic Preservation
1100 Pennsylvania Ave., NW, Ste. 803
Washington, DC 20004

RE: Plains & Eastern Clean Line Environmental Impact Statement (DOE/EIS-0486)

Dear Jaime:

Thank you for meeting with me to discuss the Plains & Eastern Clean Line (Plains & Eastern) Environmental Impact Statement (EIS; DOE/EIS-0486) and consultation under Section 106 of the National Historic Preservation Act (NHPA). As we discussed, below I have provided a brief project background, summarized the National Environmental Policy Act (NEPA) process for the EIS thus far, and summarized the U.S. Department of Energy's (DOE) Section 106 consultation process to date. I am further seeking guidance from the Advisory Council on Historic Preservation (ACHP) on how best to integrate NEPA and NHPA while using a Programmatic Agreement (PA) as the mechanism for concluding consultation under Section 106.

Project Description

In 2010, Clean Line Energy Partners, LLC (Clean Line) proposed to construct a new +/- 600 kV high voltage direct current (HVDC) electric transmission line capable of transmitting over 3,500 MW of renewable energy generation from facilities in the Oklahoma panhandle region to load-serving entities in the southeastern United States via an interconnection with the Tennessee Valley Authority in western Tennessee near Memphis (the Project). Pursuant to Section 1222(b) of EPCA 2005, DOE is proposing to participate in that project. Participation in the project is the undertaking under NHPA. Potential environmental impacts are among several factors that will inform DOE's decision on whether and under what conditions to participate.

In the proposal set forth in the Notice of Intent (NOI) and presented during the public scoping period, the Project consists of three main components: the HVDC transmission line; two converter stations, one at each end of the HVDC transmission line; and the AC collection system, to collect and transport wind energy to the western end converter station. The proposed project crosses mostly private and state land; it does not appear to cross tribal lands. As set forth in the NOI, the converter stations are proposed to be located in Texas County, Oklahoma, and Shelby County or Tipton County, Tennessee. In response to scoping comments, DOE is also analyzing the alternative of a proposed third converter

station in Pope County, Arkansas. In the NOI, DOE identified alternative routes for the transmission line. Since then, Clean Line and DOE have continued to refine these alternatives and in December, DOE identified the range of route alternatives that it intends to evaluate in the Draft Environmental Impact Statement (DEIS). DOE is currently drafting the DEIS.

NEPA Process to Date

DOE published in December 2012 the NOI (attached) to prepare an EIS to analyze the potential environmental impacts of the proposed Plains & Eastern Project. The public scoping period ran from December 21, 2012 until March 21, 2013. During that time, DOE hosted 13 public scoping meetings and met with the federal and state agencies that could be involved in the project. Public and agency comments and information were compiled into the "Scoping Summary Report," which I have attached for your convenience. These comments and information are still being reviewed as part of the development of alternatives to the transmission line's proposed route and to inform the site selection process for potential converter stations. In the Draft EIS DOE will identify and analyze the alternative routes for the transmission line, the alternative sites for the converter stations, and the potential routes for the AC collection system.

Prior to the start of the public scoping period, in November 2012, pursuant to the Council on Environmental Quality's NEPA implementing regulations (40 CFR §1501.6), DOE invited a number of federal agencies to participate as cooperating agencies in the preparation of an EIS for the Plains & Eastern Project. As of the date of this letter, the following agencies are participating as cooperating agencies: the U.S. Environmental Protection Agency, the U.S. Bureau of Indian Affairs, the U.S. Natural Resources Conservation Service, the U.S. Fish and Wildlife Service, the U.S. Army Corps of Engineers, and the Tennessee Valley Authority. It is anticipated that the U.S. Forest Service will also participate as a cooperating agency. As we discussed when we met, I have attached a copy of the Memorandum of Understanding executed between DOE and the Tennessee Valley Authority for your reference.

NHPA Process to Date

Pursuant to the NHPA implementing regulations 36 CFR §800.8(c), and as announced in the NOI, DOE is using the NEPA process and documentation required for the preparation of the EIS for the Plains & Eastern Project to comply with Section 106 of the NHPA in lieu of the procedures set forth in §800.3 through §800.6 of the NHPA regulations. This is in keeping with the NHPA's implementing regulations that "federal agencies are encouraged to coordinate compliance with Section 106 . . . with any steps taken to meet the requirements of the National Environmental Policy Act." (36 CFR §800.8(a)(1)). DOE's core goal is to integrate the NEPA and NHPA Section 106 processes in order to streamline review of the relevant effects of the proposed Project.

At our meeting, you requested a brief history of DOE's Section 106 consultation to date. DOE initially contacted the Oklahoma, Arkansas, and Tennessee State Historic Preservation Offices (collectively, SHPOs) in November 2012 to inform the SHPOs of DOE's involvement in the proposed Plains & Eastern project and about the integration of NEPA and NHPA Section 106 consultation. In January 2013, DOE

designated Clean Line as a non-federal consulting party to initiate the Section 106 consultation. At that time, DOE notified the SHPOs of Clean Line's status and reaffirmed that DOE would remain responsible for government-to-government consultation with potentially affected Indian tribes. After the NEPA public scoping period ended in March 2013, DOE sent a letter to all SHPOs in April 2013, updating them on status of DOE's public scoping process and tribal consultation. DOE met with all three SHPOs in June 2013 and with the Osage Nation in late June 2013 (notes from those meetings are attached). Based on additional information, DOE will also be contacting the Texas State Historic Preservation Office.

Regarding DOE's consultation with Indian tribes, DOE identified tribes that may attach religious and cultural significance to historic properties that may be affected by the proposed Plains & Eastern Project and initiated consultation with them in January 2013. In April 2013, following the NEPA public scoping period, DOE sent a second letter to tribes to provide updates on the status of the NEPA process and consultation. In July 2013, DOE sent a third letter to tribes in which DOE requested a meeting to discuss the potential development of a Programmatic Agreement for the Plains & Eastern project. On September 9-10, 2013, DOE held a meeting at the University of Tulsa Law School for consulting party tribes, three SHPOs, and cooperating agencies. Notes from that meeting are attached. During that meeting, the tribes caucused and agreed that they were comfortable with the "Osage Draft Keystone Programmatic Agreement" as a starting point for a Programmatic Agreement. As we discussed at our meeting, the DOE is requesting that the ACHP review and provide feedback on this document. (I have enclosed another copy for your review.) As of the date of this letter, the following tribes are participating as consulting party tribes: Absentee-Shawnee Tribe of Oklahoma, the Chickasaw Nation, the Choctaw Nation, the Iowa Tribe of Oklahoma, the Osage Nation, the Quapaw Tribe of Oklahoma, the Sac and Fox Nation, the United Keetowah Band of Cherokee, and the Wichita.

In addition to seeking information on historic properties or cultural resources of concern from other federal agencies, tribal governments from Indian tribes that might attach religious and cultural significance to potentially affected historic properties, SHPOs, and other interested parties, identification efforts to date have included investigation of the appropriate repositories of each state involved. In its capacity as a non-federal representative, the applicant and its cultural resources consultant (SWCA) have been searching for cultural resource information regarding previously documented archaeological sites, historic-age structures, NRHP-listed resources, prehistoric or historic districts, resource surveys, and other cultural resources of concern within a 0.5-mile area surrounding potential siting areas for the Project. Further efforts focused on information related to the general routes of linear features such as historic trails and other historic or tribal resources not yet documented within the existing state cultural preservation records. Identification remains on-going.

Based upon the information gathered to date from the consultation process, DOE has determined that the undertaking has the potential to have adverse effects on historic properties. DOE is currently working with the SHPOs and tribes to determine an appropriate Area of Potential Effects and welcomes ACHP's input in conversations on this issue. Furthermore, DOE intends to develop a PA to address the potential adverse effects of this undertaking. As you and I discussed during our meeting, DOE seeks clarification from ACHP about the appropriateness of using a PA to fulfill DOE's Section 106 consultation obligations under a substitution framework (36 CFR §800.8(c)). If it is not possible to conclude Section

106 consultation with a PA under a substitution framework, please advise how DOE could use a PA to conclude consultation under a coordination framework (36 CFR §800.8(a)).

I am looking forward to working with you during this consultation process. I welcome any questions or comments you may have. You can reach me at 720-356-1566 or via email at melissa.ardis@go.doe.gov.

Sincerely,



Melissa Ardis

DOE NEPA Deputy Document Manager

Enclosures



Department of Energy
Washington, DC 20585

March 11, 2014

Jaime Loichinger
Advisory Council on Historic Preservation
1100 Pennsylvania Ave., NW, Ste. 803
Washington, DC 20004

RE: Plains & Eastern Clean Line Environmental Impact Statement (DOE/EIS-0486)

Dear Jaime:

The U.S. Department of Energy (DOE) is in receipt of the Advisory Council on Historic Preservation's (ACHP) letter dated February 19, 2014, reiterating that the ACHP will formally participate in the consultation process to develop a Programmatic Agreement (PA) for the undertaking that is the subject of the Environmental Impact Statement (EIS) identified above. The purpose of this letter is to respond to the questions raised in your letter. Below please find responses to your questions:

- What is the proposed schedule and major milestones for this undertaking?
 - The Draft Environmental Impact Statement (DEIS) is projected to be released in September 2014. DOE hopes to release a draft PA with the DEIS for public review and comment.
 - Other major milestones include the final PA, the final EIS, and a Record of Decision. Potential environmental impacts are among several factors that will inform DOE's decision on whether and under what conditions DOE should participate in the proposed Plains and Eastern transmission line project.
- Given the large geographic area, how will DOE engage diverse consulting parties?
 - As DOE explained in its prior letter, dated January 17, 2014, DOE has been engaging diverse consulting parties since issuing the Notice of Intent to prepare the EIS in December 2012, and will continue doing so throughout the consultation process.
 - DOE has contacted four State Historic Preservation Offices (SHPO) – Oklahoma, Arkansas, Tennessee, and Texas. These SHPOs represent the states with historic properties that could be affected by the proposed undertaking.
 - DOE initiated government-to-government consultation with thirty Indian tribes, which DOE identified as potentially attaching religious and cultural significance to historic properties that may be affected by the proposed undertaking. As of February 2014, nine tribes will continue to consult on this undertaking: Absentee-Shawnee Tribe of Oklahoma, the Chickasaw Nation, the Choctaw Nation, the Iowa Tribe of Oklahoma, the

- Osage Nation, the Quapaw Tribe of Oklahoma, the Sac and Fox Nation, the United Keetowah Band of Cherokee, and the Wichita.
- Clean Line’s cultural resources consultant, SWCA, is reaching out to local governments and historical societies on behalf of Clean Line, which is a non-federal representative pursuant to 36 C.F.R. §800.2(c)(4). This outreach to additional consulting parties is intended to identify individuals and organizations with a demonstrated interest in the undertaking pursuant to 36 C.F.R. §800.2(c)(5), and includes local organizations identified specifically through discussions with SHPOs.
 - DOE has hosted conference calls and one Section 106 consultation meeting to date with cooperating agencies, participating tribes, and Oklahoma, Arkansas and Tennessee SHPO staff. DOE will continue its outreach in the course of the consultation process.
 - Do you intend to convene meetings in different States and regional areas?
 - DOE hosted an initial Section 106 meeting in Tulsa, Oklahoma. A satellite location was set up in Little Rock, Arkansas, where parties participated via webinar. Other consulting parties called into a conference line. Additional regional meetings are anticipated for PA development, as are additional teleconferences. To the extent feasible, DOE will continue to work with the consulting parties to convene meetings at locations generally acceptable to them.
 - Does DOE have a proposed meeting schedule at this juncture?
 - DOE is in the process of developing a meeting schedule consistent with the timeline set forth above. As an immediate next step, DOE is planning a conference call in mid-March with the SHPOs and a meeting later in March with all of the consulting parties and cooperating agencies. Due to the constraints on travel for most federal and state agencies, these “meetings” will likely take place using conference lines and/or webinars. At these meetings, DOE intends to identify the schedule for additional meetings and teleconferences, including determining whether periodic (e.g., monthly or other interval) conferencing is preferable. Other meetings are to-be-determined, based on specific groups or issues that may be identified as the consultation process continues to unfold.
 - What are the roles of the various cooperating agencies that DOE identified in its background information?
 - The following agencies are participating as cooperating agencies: the U.S. Environmental Protection Agency, the U.S. Bureau of Indian Affairs, the U.S. Natural Resources Conservation Service, the U.S. Fish and Wildlife Service, the U.S. Army Corps of Engineers, and the Tennessee Valley Authority. It is anticipated that the U.S. Forest Service will also participate as a cooperating agency. Each agency has distinct reasons for participating as a cooperating agency. These are summarized as follows:
 - U.S. Environmental Protection Agency (EPA) – Under Section 309 of the Clean Air Act, the EPA is required to review and publicly comment on the environmental effects of major federal actions, including actions that are the subject of EIS documents.

- U.S. Bureau of Indian Affairs (BIA) – BIA has jurisdiction by law and/or has special expertise in the issuance of Rights-of-Way over Indian Lands (25 CFR Part 169).
 - U.S. Natural Resources Conservation Service (NRCS) – The NRCS is a federal agency within the Department of Agriculture. Its mission is to improve, protect, and conserve natural resources on private lands through cooperative partnerships with private land owners and state and local agencies.
 - U.S. Fish and Wildlife Service (FWS) – FWS’s mission is to conserve, protect, and enhance fish, wildlife, and plants and their natural habitats and is recognized to have jurisdiction by law and/or has special expertise in the following areas: Endangered Species Act (16 USC §1536 et seq.); Migratory Bird Treaty Act (16 USC §703 et seq.); Bald and Golden Eagle Protection Act (16 USC §668 et seq.); The National Wildlife Refuge System Administration Act (16 USC §§668dd-668ee); Executive Order 13186; and the DOE/USFWS Memorandum of Understanding (DOE/USFWS 2006).
 - U.S. Army Corps of Engineers (USACE) – USACE is the federal agency charged with permitting for project features that cross over, through, or under navigable waters as defined under Section 10 of the Rivers and Harbors Act of 1899 (33 USC §401 et seq.). Further, authorization from the USACE is also required for any activity that would result in discharges of dredged or fill material into waters of the United States as defined under Section 404 of the Clean Water Act (33 USC §404) and any activity that crosses certain levees (33 USC §408).
 - Tennessee Valley Authority (TVA) – TVA’s purpose and need for agency action is to respond to Clean Line’s request to connect the proposed Project to the TVA transmission system.
- Has DOE been formally identified as the lead agency for Section 106? If so, by which agencies?
 - Yes, DOE has been identified as the lead agency for Section 106 consultation process by all cooperating agencies. This is recorded in DOE’s Memoranda of Understanding with each cooperating agency. As one example, please see the DOE TVA MOU enclosed in our January 17, 2014 letter.
- How will this project be coordinated with related state environmental reviews? Has DOE outlined steps it will take to coordinate the review processes?
 - DOE is investigating the related state environmental reviews.
- What comments have stakeholders submitted to DOE regarding the project’s potential to affect historic properties?
 - DOE issued the Notice of Intent to Prepare an Environmental Impact Statement for the Plains and Eastern Clean Line Transmission Project (“NOI”) on December 13, 2012. That NOI also identified compliance with the Section 106 process as an agency responsibility.
 - Several scoping comments received in response to the December 2012 NOI addressed potential effects of the proposed project on cultural resources and/or historic properties. Some specific examples include (but are not limited to) concerns for burial sites and a ceremonial ground that is important to two tribes. Honey Springs Battlefield

National Historic Landmark was identified in consultation with Oklahoma SHPO. DOE also received comments from the National Park Service regarding the potential for effects to portions of the Trail of Tears.

- DOE received general comments on the project's potential to affect cultural resources and/or historic properties during the Section 106 meeting held September 9 and 10, 2013. Notes from that meeting were included in our January 17, 2014 correspondence.
- DOE is currently consulting with the nine Indian tribes listed above on identification of historic properties or cultural resources.
- Who has requested consulting party status for this undertaking pursuant to Section 800.3(f)?
 - DOE has, in consultation with the SHPOs, made the following efforts to identify other consulting parties:
 - DOE has requested information from the SHPOs regarding the local governments or historical societies that should be contacted as part of the consultation process.
 - SWCA has contacted a number of local governments and historical societies to inquire regarding their interest in participating in the Section 106 consultation and PA development process (if appropriate). This outreach effort is continuing.
 - As stated above, DOE has made a reasonable and good faith effort to identify Indian tribes that may attach religious and cultural significance to historic properties in the area of potential effects. SHPOs and other consulting tribes and agencies have also been asked about additional parties to contact for consultation. As previously noted, to date nine tribes have requested consulting party status.
 - To date, no individuals or organizations have requested consulting party status under Section 800.3(f).

DOE believes that a PA is the most appropriate vehicle for completing the Section 106 process for the undertaking, and we look forward to hearing back about the ACHP's perspective on the materials enclosed with our e-mail correspondence dated January 17, 2014. DOE is working with the SHPOs to set up a conference call/webinar in mid-March to discuss moving forward with development of this PA. DOE will also host a larger conference call/webinar in mid to late March with the other consulting parties and cooperating agencies to discuss the same. The ACHP will be invited to participate in all of these calls.

Again, I am looking forward to working with you during this consultation process. I welcome any questions or comments you may have. You can reach me at 720-356-1566 or via email at melissa.ardis@go.doe.gov.

Sincerely,



Melissa Ardis

DOE NEPA Deputy Document Manager

Joanne Stover

From: Summerson, Jane <Jane.Summerson01@nnsa.doe.gov>
Sent: Thursday, November 13, 2014 11:45 AM
To: 'Jaime Loichinger'; Conrad, David; Nicholson, Charles P; 'Blansett, Cynthia W SWL'; Robert Dunn; Timothy Hartsfield; 'Anderson, David'; 'Burge, Vanessa'; Terry Krasko; 'michael.taylor@nps.gov'; Steve Elsener; J. Eric Gilliland; Melvena Thurman Heisch; Joe Garrison; Mark Wolfe; 'joseph.blanchard@astribe.com'; 'bill-baker@cherokee.org'; 'timothy.baugh@chickasaw.net'; 'ithompson@choctawnation.com'; 'rfields@iowanation.org'; 'kbellmard@bellmardlaw.com'; Emman Spain; 'ahunter@osagenation-nsn.gov'; 'ebandy@quapawtribe.com'; 'smassey@sacandfoxnation-nsn.gov'; 'Charles Coleman'; 'UKBTHPO-larue@yahoo.com'; 'gary.mcadams@wichitatribe.com'; 'Jason Thomas'; Turner, Chris (SWPA); Marlina Delisa (marlina.delisa@swpa.gov); 'angela.mchphee@swpa.gov'; Love, Michael; Yost, Mistie; 'sierra.mandelko@bia.gov'; 'jonna.polk@bia.gov'; 'Masters, Anita E'; 'bdtill@tva.gov'; 'Ezell, Patricia Bernard'; 'gerald.l.treadwell@usace.army.mil'; 'jimmy.d.mcneil@mvm02.usace.army.mil'; 'kim.d.hewitt@usace.army.mil'; 'micheal.p.bauman@usace.army.mil'; 'michelle.c.horn@usace.army.mil'; Reggie Wuornos; Christine Willis; 'chris_tanner@fws.gov'; Darrin Unruh; Keith Weaver; Ken Collins; Kenneth Mcdonald; Richard Stark ; Thomas Inebnit; Craig Weeks ; Mike Jansky; Rhonda Smith; Frances; Lane; Martha; Lynda Ozan; Cate Wood; Bob Brooks; Tiffany ; 'richard-allen@cherokee.org'; 'joel-bean@cherokee.org'; 'amber.hood@chickasaw.net'; 'lbilyeu@choctawnation.com'; 'broush@iowanation.org'; 'dmoss@mcn-nsn.gov'; 'davidp@mcn-nsn.gov'; 'dbeaver@mcm-nsn.gov'; Eddie LaGrone; 'gperez@mcn-nsn.gov'; James Williams; Jeff Fife; Johnnie Jacobs; 'Judith Ausmus'; 'ofreeman@mcn-nsn.gov'; Sonya McIntosh; 'rsoweka@mcn-nsn.gov'; 'tthompson@mcn-nsn.gov'; 'bfariss@osagenation-nsn.gov'; 'bwelborn@sbcglobal.net'; 'tgoodvoice@unitedkeetoowahband.org'; Charles Tippeconnic ; 'commissioner@woodwardcounty.org'; Scott Phillips (SPhillips@swca.com); Kevin Miller
Cc: 'Farmer, Constance'; Chavez, Allie; Joanne Stover (jstover@jrwriters.com); Rosenthal, Rachel; Amerasinghe, Felix
Subject: Plains and Eastern DOE response to ACHP comments
Attachments: tx-ok-ar-tn.doe.plains and eastern clean line.draft PA.achp edits.enclos....pdf; tx-ok-ar-tn.doe.plains & eastern clean line transmission.con.18sept14.pdf

Dear Jaime and Kelly:

Thank you for taking the time to meet with Felix Amerasinghe, Rachel Rosenthal, and me on November 3, 2014. At that meeting, we discussed your letter dated September 28, 2014 transmitting comments on the August 6, 2014 draft Programmatic Agreement (PA) for the proposed Plains and Eastern Clean Line Transmission Project. I am writing today to summarize what we discussed.

Your letter asked DOE to consider scheduling regular meetings for consultation and for negotiation of the PA. You should have received a draft communication plan from Jane Summerson that proposes regular meetings and provides a process for setting up points of contact to facilitate better communication between the Consulting Parties.

Your letter also proposed that DOE pursue a Programmatic Environmental Impact Statement and utilize a tiered NEPA review for the proposed Plains and Eastern Clean Line Transmission Project. DOE explained that an Environmental Impact Statement (EIS) is the appropriate NEPA document here because the proposed Plains and Eastern Clean Line Transmission Line is a site-specific, particular project and no future NEPA review for this project is contemplated. Thus, there is unlikely to be any future NEPA document that would tier from the document that DOE is currently preparing.

Further, EIS is not meant to provide NEPA coverage for any DOE program related to transmission lines. In fact, DOE cannot speculate about what other projects might be developed under its Section 1222 authorities. We appreciate that, after DOE provided you with this explanation, you agreed that an EIS is adequate and appropriate in this circumstance.

We discussed ACHP's comments on the draft PA in order of the comment numbers in the comment bubbles on the sides of the relevant pages.

For comment c8, we discussed options for public participation in the Section 106 process. DOE agreed to send notices about the EIS to groups that DOE previously contacted to notify them about the Section 106 process, even if those groups have not responded to DOE's notifications. DOE will also add those groups to our mailing list for the EIS. You explained that if those groups decide to join the Section 106 consultation at this late stage, DOE could allow them to join; however, the Consulting Parties would not need to restart the process.

For comment c10, we agreed that the subject of long-term cumulative effects under 106 is an appropriate topic for discussion with the Consulting Parties. We agreed that we would return to this topic once you have had the opportunity to read the sections of the EIS on the wind development zones, which do not at this point have any federal nexus but are treated as "connected actions" to the proposed Plains and Eastern Clean Line Transmission Project in the EIS. Although ACHP would like cumulative impacts under Section 106 to be coextensive with cumulative impacts under NEPA, we discussed how it would be premature and nearly impossible to resolve those impacts at this stage under Section 106. We discussed language such as the following for the PA: "if in the future there is a proposed federal role in the wind development zones, then the relevant federal agency would comply with Section 106 at an appropriate time."

For comment c13, we agreed that we would revisit this topic (about defining the scope of the PA) after you have had an opportunity to review the EIS. The NEPA and NHPA are not aligned, and so it is difficult to figure out the scope.

For comment c14, we agreed that we would revisit this topic about adding a clause on roles and responsibilities after we get further along in development of the PA.

For comment c19, you explained Section 110(f) and 36 CFR 800.10 and pointed us to the Secretary of the Interior's Standards and Guidelines on Section 110 for more information. We discussed language such as the following for the PA: "should National Historic Landmarks be identified, then DOE shall, to the maximum extent possible, undertake such planning . . ." DOE agreed to put a placeholder in the PA for now, and we will revisit this topic after you have had an opportunity to review the relevant information in the EIS.

For comment c20, DOE stated this has been addressed in the latest draft of the PA dated October 20, 2014.

For comment c21, DOE will ask the US Forest Service for an answer to ACHP's question about the manual. Also, DOE explained that the alternative involving Forest Service lands is a non-preferred alternative.

For comment c26, DOE confirmed that this draft PA already contains relevant language that has been tweaked somewhat in the draft of the PA dated October 20, 2014.

For comment c27, c28, and c30, DOE stated that these comments have been addressed in the latest draft of the PA dated October 20, 2014.

For comment c32, DOE explained that this provision has been completely rewritten in the latest draft of the PA dated October 20, 2014.

For comment c33 and c34, DOE stated this has been addressed in the latest draft of the PA dated October 20, 2014.

For comment c36, we agreed that the language on public objections in Section IX.D. in the latest draft of the PA dated October 20, 2014 addresses your concern. You also stated that you would provide language for "final discussion and close-out" for the resolution of public objections.

For comment c37, DOE explained that this provision has been completely rewritten in the latest draft of the PA dated October 20, 2014. You recommended that DOE consider a solid end date for the term of the agreement, i.e. 10 or 20 years and not the end of construction.

For comments C39 and c40, DOE explained that this provision has been completely rewritten in the latest draft of the PA dated October 20, 2014.

For comment c41, we discussed the reasoning behind this provision, i.e., what happens if DOE decides not to participate in the transmission line. You agreed to review and comment on this language in the draft of the PA dated October 20, 2014.

For comment c43, we explained that the project does not cross tribal land as that is defined in the Section 106 regulations.

For comment c45 and c46, DOE stated this has been addressed in the latest draft of the PA dated October 20, 2014.

Apart from these comments, we also discussed the issues related to signatories, invited signatories, and termination. The discussion covered the rights of invited signatories to amend or terminate a PA. You advised us of ACHP's view that signatories, including invited signatories, could unilaterally terminate the PA. However, the PA could provide that consulting parties only need to stop work "to the extent feasible" in the event of termination. As such, work on the Plains and Eastern Clean Line Transmission Project could in certain circumstances continue while the relevant parties enter into a new Memorandum of Agreement or PA as appropriate. It is our understanding that the PA's condition regarding work stoppage after termination would continue to be binding even if the other provisions of the PA are terminated.

Thank you again for meeting with us, and we look forward to receiving your comments on the October 20 draft of the PA. If you have questions or comments, please feel free to contact us in the meantime.

Jane Summerson, PhD
Document Manager
Plains and Eastern EIS
505 845 4091



DEPARTMENT OF ENERGY
Washington, DC 20585

OFFICE OF THE SECRETARY

November 6, 2012

Bureau of Indian Affairs
Cherokee Nation
Linda Donelson, Director
Cherokee Nation Real Estate Services
PO Box 948
Tahlequah, OK 74465-0948

Dear Ms. Donelson:

SUBJECT: United State Department of Energy Invitation to Participate in the Plains & Eastern Clean Line Project Environmental Impact Statement (DOE/EIS-0486)

Pursuant to the Council on Environmental Quality's regulations (40 CFR 1501.6) that implement the National Environmental Policy Act of 1969 (NEPA) (42 USC 4321-4370(h)) the Department of Energy (DOE) invites the participation of your agency as a cooperating agency in the preparation of an environmental impact statement (EIS) for the Plains & Eastern Clean Line (Plains & Eastern) Project. In the EIS, DOE intends to analyze the potential environmental impacts of a project proposed by Plains & Eastern, to construct an overhead transmission line from western Oklahoma to the Tennessee Valley Authority in the southeastern United States. DOE is planning to publish, in December 2012, a Notice of Intent (NOI) to prepare the EIS. In keeping with the Administration's goal of moving transmission infrastructure projects expeditiously through the permitting and environmental review processes, DOE is requesting that you promptly notify DOE of your interest in participating in the EIS as a cooperating agency.

By way of background, Section 1222 (b) of the Energy Policy Act of 2005, provides that the Secretary of Energy, acting in consultation with the Western Area Power Administration (WAPA) or the Southwestern Power Administration (SWPA), or both, may design, develop, construct, operate, maintain or own, or participate with other entities in designing, developing, constructing, operating or owning, a new electric power transmission facility and related facilities.

In response to DOE's June 10, 2010 Request for Proposals, Clean Line Energy Partners, LLC (Clean Line) applied to the DOE under Section 1222(b) to work with and provide funds to DOE to develop a new +/- 600 kV high voltage direct current (HVDC) electric transmission line capable of transmitting over 3,500 MW of renewable energy generation from facilities in the Oklahoma panhandle region to load-serving entities in the southeastern United States via an interconnection with the Tennessee Valley Authority in western Tennessee near Memphis.

Pursuant to Section 1222(b), DOE's proposed action is to participate with Clean Line in executing the Project. DOE has not yet made any final determination with respect to whether the Project satisfies the requirements of Section 1222(b).

The HVDC transmission line would utilize two Alternating Current/Direct Current (AC/DC) converter stations, one at each end of the transmission line. The converter stations are proposed to be located in Texas County, Oklahoma, and Shelby County or Tipton County, Tennessee. Each converter station would be approximately 30 to 50 acres and would be located on private land. Right-of-way easements would be required for the transmission line and would have a typical width of approximately 150 to 200 feet. Tubular or lattice steel structures would be used to support the transmission line. Each structure would have a typical height from 120 to 200 feet, depending on site-specific conditions. Other limited quantities of larger specialty structures may be necessary to address engineering constraints in some locations. Additionally, access roads, improvements to existing roads, new overland access, and new unpaved temporary roads would be required to access the transmission line and related facilities during the construction, operation and maintenance phases. Finally, ancillary facilities such as communication facilities for control and protection would be required.

The Plains & Eastern Project would traverse several hundreds of miles of terrain prior to spanning the Mississippi River. The Plains & Eastern Project would require numerous Federal permits and authorizations. In part because of DOE's involvement, it will also be subject to consultation and environmental review requirements. Given the scope of all these requirements and the number of agencies involved in them, DOE is particularly interested in identifying cooperating agencies early in the NEPA process. DOE requests that each agency that may have a role in the Plains & Eastern Project, required or otherwise, help define the specific requirements which must be met to fulfill that agency's NEPA obligations and participate as a cooperating agency. This is in support of CEQ's guidance to ensure that Federal agencies actively participate as cooperating agencies in other agency's NEPA processes and to avoid duplication and unnecessary delays in the NEPA process. If your agency has multiple offices or regions that may participate as a cooperating agency in the EIS, please identify a lead office or region.

Should your agency agree to be a cooperating agency, DOE will endeavor to ensure that the information and analyses of the EIS would support any agency decision relative to their NEPA obligations. To that end, DOE anticipates that your agency will participate with DOE in:

- Reviewing technical approaches for analyzing impacts;
- Reviewing preliminary versions of the draft and final EIS;
- Representing your agency's interests, if timing allows, at the public scoping meetings; and
- Engaging in activities associated with publication of the draft EIS, such as public hearings.

DOE may request that your agency respond to comments on the Draft EIS in a timely manner relating to subject matter specific to your agency's mission and goals.

DOE looks forward to the participation of your agency as a cooperating agency during the development of the Plains and Eastern EIS. In particular, we encourage input and suggestions from your agency on the scope of the EIS to ensure that all relevant environmental issues are addressed. Should your agency elect not to participate as a cooperating agency, DOE hopes that your agency still participates as a consulting or commenting agency to allow the EIS to benefit from your specific expertise.

Do not hesitate to contact us if you, or your staff, have any questions or concerns. The primary point of contact for this effort is DOE's EIS Deputy Document Manager, Ms. Melissa Ardis. She may be reached at 720-356-1566 or 720-291-1602 or via email at melissa.ardis@go.doe.gov. The Federal Document Manager, Dr. Jane Summerson, may be reached at (505) 845-4091 or via email at jane.summerson@ee.doe.gov.

Sincerely,

A handwritten signature in cursive script, appearing to read "Jane K. Summerson".

Jane Summerson, Ph.D.
Federal Document Manager
Office of Electricity Delivery and
Energy Reliability



DEPARTMENT OF ENERGY
Washington, DC 20585

OFFICE OF THE SECRETARY

November 6, 2012

Bureau of Indian Affairs
Eastern Oklahoma Region
Attn: Kelly Harjo, Superintendent
P.O. Box 370
Muskogee, OK 74447

Dear Kelly Harjo:

SUBJECT: United State Department of Energy Invitation to Participate in the Plains & Eastern Clean Line Project Environmental Impact Statement (DOE/EIS-0486)

Pursuant to the Council on Environmental Quality's regulations (40 CFR 1501.6) that implement the National Environmental Policy Act of 1969 (NEPA) (42 USC 4321-4370(h)) the Department of Energy (DOE) invites the participation of your agency as a cooperating agency in the preparation of an environmental impact statement (EIS) for the Plains & Eastern Clean Line (Plains & Eastern) Project. In the EIS, DOE intends to analyze the potential environmental impacts of a project proposed by Plains & Eastern, to construct an overhead transmission line from western Oklahoma to the Tennessee Valley Authority in the southeastern United States. DOE is planning to publish, in December 2012, a Notice of Intent (NOI) to prepare the EIS. In keeping with the Administration's goal of moving transmission infrastructure projects expeditiously through the permitting and environmental review processes, DOE is requesting that you promptly notify DOE of your interest in participating in the EIS as a cooperating agency.

By way of background, Section 1222 (b) of the Energy Policy Act of 2005, provides that the Secretary of Energy, acting in consultation with the Western Area Power Administration (WAPA) or the Southwestern Power Administration (SWPA), or both, may design, develop, construct, operate, maintain or own, or participate with other entities in designing, developing, constructing, operating or owning, a new electric power transmission facility and related facilities.

In response to DOE's June 10, 2010 Request for Proposals, Clean Line Energy Partners, LLC (Clean Line) applied to the DOE under Section 1222(b) to work with and provide funds to DOE to develop a new +/- 600 kV high voltage direct current (HVDC) electric transmission line capable of transmitting over 3,500 MW of renewable energy generation from facilities in the Oklahoma panhandle region to load-serving entities in the southeastern United States via an interconnection with the Tennessee Valley Authority in western Tennessee near Memphis. Pursuant to Section 1222(b), DOE's proposed action is to participate with Clean Line in

executing the Project. DOE has not yet made any final determination with respect to whether the Project satisfies the requirements of Section 1222(b).

The HVDC transmission line would utilize two Alternating Current/Direct Current (AC/DC) converter stations, one at each end of the transmission line. The converter stations are proposed to be located in Texas County, Oklahoma, and Shelby County or Tipton County, Tennessee. Each converter station would be approximately 30 to 50 acres and would be located on private land. Right-of-way easements would be required for the transmission line and would have a typical width of approximately 150 to 200 feet. Tubular or lattice steel structures would be used to support the transmission line. Each structure would have a typical height from 120 to 200 feet, depending on site-specific conditions. Other limited quantities of larger specialty structures may be necessary to address engineering constraints in some locations. Additionally, access roads, improvements to existing roads, new overland access, and new unpaved temporary roads would be required to access the transmission line and related facilities during the construction, operation and maintenance phases. Finally, ancillary facilities such as communication facilities for control and protection would be required.

The Plains & Eastern Project would traverse several hundreds of miles of terrain prior to spanning the Mississippi River. The Plains & Eastern Project would require numerous Federal permits and authorizations. In part because of DOE's involvement, it will also be subject to consultation and environmental review requirements. Given the scope of all these requirements and the number of agencies involved in them, DOE is particularly interested in identifying cooperating agencies early in the NEPA process. DOE requests that each agency that may have a role in the Plains & Eastern Project, required or otherwise, help define the specific requirements which must be met to fulfill that agency's NEPA obligations and participate as a cooperating agency. This is in support of CEQ's guidance to ensure that Federal agencies actively participate as cooperating agencies in other agency's NEPA processes and to avoid duplication and unnecessary delays in the NEPA process. If your agency has multiple offices or regions that may participate as a cooperating agency in the EIS, please identify a lead office or region.

Should your agency agree to be a cooperating agency, DOE will endeavor to ensure that the information and analyses of the EIS would support any agency decision relative to their NEPA obligations. To that end, DOE anticipates that your agency will participate with DOE in:

- Reviewing technical approaches for analyzing impacts;
- Reviewing preliminary versions of the draft and final EIS;
- Representing your agency's interests, if timing allows, at the public scoping meetings; and
- Engaging in activities associated with publication of the draft EIS, such as public hearings.

DOE may request that your agency respond to comments on the Draft EIS in a timely manner relating to subject matter specific to your agency's mission and goals.

DOE looks forward to the participation of your agency as a cooperating agency during the development of the Plains and Eastern EIS. In particular, we encourage input and suggestions from your agency on the scope of the EIS to ensure that all relevant environmental issues are addressed. Should your agency elect not to participate as a cooperating agency, DOE hopes that your agency still participates as a consulting or commenting agency to allow the EIS to benefit from your specific expertise.

Do not hesitate to contact us if you, or your staff, have any questions or concerns. The primary point of contact for this effort is DOE's EIS Deputy Document Manager, Ms. Melissa Ardis. She may be reached at 720-356-1566 or 720-291-1602 or via email at melissa.ardis@go.doe.gov. The Federal Document Manager, Dr. Jane Summerson, may be reached at (505) 845-4091 or via email at jane.summerson@ee.doe.gov.

Sincerely,

A handwritten signature in black ink, appearing to read "Jane K. Summerson". The signature is fluid and cursive, with a long horizontal stroke at the end.

Jane Summerson, Ph.D.
Federal Document Manager
Office of Electricity Delivery and
Energy Reliability



DEPARTMENT OF ENERGY
Washington, DC 20585

OFFICE OF THE SECRETARY

November 6, 2012

Bureau of Indian Affairs
Horton Agency
Attn: Robin R. Bellmard
P.O. Box 31
Horton, KS 66439

Dear Ms. Bellmard:

SUBJECT: United State Department of Energy Invitation to Participate in the Plains & Eastern Clean Line Project Environmental Impact Statement (DOE/EIS-0486)

Pursuant to the Council on Environmental Quality's regulations (40 CFR 1501.6) that implement the National Environmental Policy Act of 1969 (NEPA) (42 USC 4321-4370(h)) the Department of Energy (DOE) invites the participation of your agency as a cooperating agency in the preparation of an environmental impact statement (EIS) for the Plains & Eastern Clean Line (Plains & Eastern) Project. In the EIS, DOE intends to analyze the potential environmental impacts of a project proposed by Plains & Eastern, to construct an overhead transmission line from western Oklahoma to the Tennessee Valley Authority in the southeastern United States. DOE is planning to publish, in December 2012, a Notice of Intent (NOI) to prepare the EIS. In keeping with the Administration's goal of moving transmission infrastructure projects expeditiously through the permitting and environmental review processes, DOE is requesting that you promptly notify DOE of your interest in participating in the EIS as a cooperating agency.

By way of background, Section 1222 (b) of the Energy Policy Act of 2005, provides that the Secretary of Energy, acting in consultation with the Western Area Power Administration (WAPA) or the Southwestern Power Administration (SWPA), or both, may design, develop, construct, operate, maintain or own, or participate with other entities in designing, developing, constructing, operating or owning, a new electric power transmission facility and related facilities.

In response to DOE's June 10, 2010 Request for Proposals, Clean Line Energy Partners, LLC (Clean Line) applied to the DOE under Section 1222(b) to work with and provide funds to DOE to develop a new +/- 600 kV high voltage direct current (HVDC) electric transmission line capable of transmitting over 3,500 MW of renewable energy generation from facilities in the Oklahoma panhandle region to load-serving entities in the southeastern United States via an interconnection with the Tennessee Valley Authority in western Tennessee near Memphis. Pursuant to Section 1222(b), DOE's proposed action is to participate with Clean Line in

executing the Project. DOE has not yet made any final determination with respect to whether the Project satisfies the requirements of Section 1222(b).

The HVDC transmission line would utilize two Alternating Current/Direct Current (AC/DC) converter stations, one at each end of the transmission line. The converter stations are proposed to be located in Texas County, Oklahoma, and Shelby County or Tipton County, Tennessee. Each converter station would be approximately 30 to 50 acres and would be located on private land. Right-of-way easements would be required for the transmission line and would have a typical width of approximately 150 to 200 feet. Tubular or lattice steel structures would be used to support the transmission line. Each structure would have a typical height from 120 to 200 feet, depending on site-specific conditions. Other limited quantities of larger specialty structures may be necessary to address engineering constraints in some locations. Additionally, access roads, improvements to existing roads, new overland access, and new unpaved temporary roads would be required to access the transmission line and related facilities during the construction, operation and maintenance phases. Finally, ancillary facilities such as communication facilities for control and protection would be required.

The Plains & Eastern Project would traverse several hundreds of miles of terrain prior to spanning the Mississippi River. The Plains & Eastern Project would require numerous Federal permits and authorizations. In part because of DOE's involvement, it will also be subject to consultation and environmental review requirements. Given the scope of all these requirements and the number of agencies involved in them, DOE is particularly interested in identifying cooperating agencies early in the NEPA process. DOE requests that each agency that may have a role in the Plains & Eastern Project, required or otherwise, help define the specific requirements which must be met to fulfill that agency's NEPA obligations and participate as a cooperating agency. This is in support of CEQ's guidance to ensure that Federal agencies actively participate as cooperating agencies in other agency's NEPA processes and to avoid duplication and unnecessary delays in the NEPA process. If your agency has multiple offices or regions that may participate as a cooperating agency in the EIS, please identify a lead office or region.

Should your agency agree to be a cooperating agency, DOE will endeavor to ensure that the information and analyses of the EIS would support any agency decision relative to their NEPA obligations. To that end, DOE anticipates that your agency will participate with DOE in:

- Reviewing technical approaches for analyzing impacts;
- Reviewing preliminary versions of the draft and final EIS;
- Representing your agency's interests, if timing allows, at the public scoping meetings; and
- Engaging in activities associated with publication of the draft EIS, such as public hearings.

DOE may request that your agency respond to comments on the Draft EIS in a timely manner relating to subject matter specific to your agency's mission and goals.

DOE looks forward to the participation of your agency as a cooperating agency during the development of the Plains and Eastern EIS. In particular, we encourage input and suggestions from your agency on the scope of the EIS to ensure that all relevant environmental issues are addressed. Should your agency elect not to participate as a cooperating agency, DOE hopes that your agency still participates as a consulting or commenting agency to allow the EIS to benefit from your specific expertise.

Do not hesitate to contact us if you, or your staff, have any questions or concerns. The primary point of contact for this effort is DOE's EIS Deputy Document Manager, Ms. Melissa Ardis. She may be reached at 720-356-1566 or 720-291-1602 or via email at melissa.ardis@go.doe.gov. The Federal Document Manager, Dr. Jane Summerson, may be reached at (505) 845-4091 or via email at jane.summerson@ee.doe.gov.

Sincerely,

A handwritten signature in cursive script, appearing to read "Jane K. Summerson".

Jane Summerson, Ph.D.
Federal Document Manager
Office of Electricity Delivery and
Energy Reliability



DEPARTMENT OF ENERGY
Washington, DC 20585

OFFICE OF THE SECRETARY

November 6, 2012

Bureau of Indian Affairs
Pawnee Agency (Pawnee Nation)
Attn: Julia Langan
P.O. Box 440
Pawnee, OK 74058

Dear Ms. Langan:

SUBJECT: United State Department of Energy Invitation to Participate in the Plains & Eastern Clean Line Project Environmental Impact Statement (DOE/EIS-0486)

Pursuant to the Council on Environmental Quality's regulations (40 CFR 1501.6) that implement the National Environmental Policy Act of 1969 (NEPA) (42 USC 4321-4370(h)) the Department of Energy (DOE) invites the participation of your agency as a cooperating agency in the preparation of an environmental impact statement (EIS) for the Plains & Eastern Clean Line (Plains & Eastern) Project. In the EIS, DOE intends to analyze the potential environmental impacts of a project proposed by Plains & Eastern, to construct an overhead transmission line from western Oklahoma to the Tennessee Valley Authority in the southeastern United States. DOE is planning to publish, in December 2012, a Notice of Intent (NOI) to prepare the EIS. In keeping with the Administration's goal of moving transmission infrastructure projects expeditiously through the permitting and environmental review processes, DOE is requesting that you promptly notify DOE of your interest in participating in the EIS as a cooperating agency.

By way of background, Section 1222 (b) of the Energy Policy Act of 2005, provides that the Secretary of Energy, acting in consultation with the Western Area Power Administration (WAPA) or the Southwestern Power Administration (SWPA), or both, may design, develop, construct, operate, maintain or own, or participate with other entities in designing, developing, constructing, operating or owning, a new electric power transmission facility and related facilities.

In response to DOE's June 10, 2010 Request for Proposals, Clean Line Energy Partners, LLC (Clean Line) applied to the DOE under Section 1222(b) to work with and provide funds to DOE to develop a new +/- 600 kV high voltage direct current (HVDC) electric transmission line capable of transmitting over 3,500 MW of renewable energy generation from facilities in the Oklahoma panhandle region to load-serving entities in the southeastern United States via an interconnection with the Tennessee Valley Authority in western Tennessee near Memphis. Pursuant to Section 1222(b), DOE's proposed action is to participate with Clean Line in

executing the Project. DOE has not yet made any final determination with respect to whether the Project satisfies the requirements of Section 1222(b).

The HVDC transmission line would utilize two Alternating Current/Direct Current (AC/DC) converter stations, one at each end of the transmission line. The converter stations are proposed to be located in Texas County, Oklahoma, and Shelby County or Tipton County, Tennessee. Each converter station would be approximately 30 to 50 acres and would be located on private land. Right-of-way easements would be required for the transmission line and would have a typical width of approximately 150 to 200 feet. Tubular or lattice steel structures would be used to support the transmission line. Each structure would have a typical height from 120 to 200 feet, depending on site-specific conditions. Other limited quantities of larger specialty structures may be necessary to address engineering constraints in some locations. Additionally, access roads, improvements to existing roads, new overland access, and new unpaved temporary roads would be required to access the transmission line and related facilities during the construction, operation and maintenance phases. Finally, ancillary facilities such as communication facilities for control and protection would be required.

The Plains & Eastern Project would traverse several hundreds of miles of terrain prior to spanning the Mississippi River. The Plains & Eastern Project would require numerous Federal permits and authorizations. In part because of DOE's involvement, it will also be subject to consultation and environmental review requirements. Given the scope of all these requirements and the number of agencies involved in them, DOE is particularly interested in identifying cooperating agencies early in the NEPA process. DOE requests that each agency that may have a role in the Plains & Eastern Project, required or otherwise, help define the specific requirements which must be met to fulfill that agency's NEPA obligations and participate as a cooperating agency. This is in support of CEQ's guidance to ensure that Federal agencies actively participate as cooperating agencies in other agency's NEPA processes and to avoid duplication and unnecessary delays in the NEPA process. If your agency has multiple offices or regions that may participate as a cooperating agency in the EIS, please identify a lead office or region.

Should your agency agree to be a cooperating agency, DOE will endeavor to ensure that the information and analyses of the EIS would support any agency decision relative to their NEPA obligations. To that end, DOE anticipates that your agency will participate with DOE in:

- Reviewing technical approaches for analyzing impacts;
- Reviewing preliminary versions of the draft and final EIS;
- Representing your agency's interests, if timing allows, at the public scoping meetings; and
- Engaging in activities associated with publication of the draft EIS, such as public hearings.

DOE may request that your agency respond to comments on the Draft EIS in a timely manner relating to subject matter specific to your agency's mission and goals.

DOE looks forward to the participation of your agency as a cooperating agency during the development of the Plains and Eastern EIS. In particular, we encourage input and suggestions from your agency on the scope of the EIS to ensure that all relevant environmental issues are addressed. Should your agency elect not to participate as a cooperating agency, DOE hopes that your agency still participates as a consulting or commenting agency to allow the EIS to benefit from your specific expertise.

Do not hesitate to contact us if you, or your staff, have any questions or concerns. The primary point of contact for this effort is DOE's EIS Deputy Document Manager, Ms. Melissa Ardis. She may be reached at 720-356-1566 or 720-291-1602 or via email at melissa.ardis@go.doe.gov. The Federal Document Manager, Dr. Jane Summerson, may be reached at (505) 845-4091 or via email at jane.summerson@ee.doe.gov.

Sincerely,

A handwritten signature in black ink, appearing to read "Jane K. Summerson". The signature is fluid and cursive, written in a professional style.

Jane Summerson, Ph.D.
Federal Document Manager
Office of Electricity Delivery and
Energy Reliability



DEPARTMENT OF ENERGY
Washington, DC 20585

OFFICE OF THE SECRETARY

November 6, 2012

Bureau of Indian Affairs
Southern Plains Region
Attn: Dan Deerinwater, Regional Director
Southern Plains Regional Office,
WCD Office Complex
P.O. Box 368
Anadarko, OK 73005

Dear Mr. Deerinwater:

SUBJECT: United State Department of Energy Invitation to Participate in the Plains & Eastern Clean Line Project Environmental Impact Statement (DOE/EIS-0486)

Pursuant to the Council on Environmental Quality's regulations (40 CFR 1501.6) that implement the National Environmental Policy Act of 1969 (NEPA) (42 USC 4321-4370(h)) the Department of Energy (DOE) invites the participation of your agency as a cooperating agency in the preparation of an environmental impact statement (EIS) for the Plains & Eastern Clean Line (Plains & Eastern) Project. In the EIS, DOE intends to analyze the potential environmental impacts of a project proposed by Plains & Eastern, to construct an overhead transmission line from western Oklahoma to the Tennessee Valley Authority in the southeastern United States. DOE is planning to publish, in December 2012, a Notice of Intent (NOI) to prepare the EIS. In keeping with the Administration's goal of moving transmission infrastructure projects expeditiously through the permitting and environmental review processes, DOE is requesting that you promptly notify DOE of your interest in participating in the EIS as a cooperating agency.

By way of background, Section 1222 (b) of the Energy Policy Act of 2005, provides that the Secretary of Energy, acting in consultation with the Western Area Power Administration (WAPA) or the Southwestern Power Administration (SWPA), or both, may design, develop, construct, operate, maintain or own, or participate with other entities in designing, developing, constructing, operating or owning, a new electric power transmission facility and related facilities.

In response to DOE's June 10, 2010 Request for Proposals, Clean Line Energy Partners, LLC (Clean Line) applied to the DOE under Section 1222(b) to work with and provide funds to DOE to develop a new +/- 600 kV high voltage direct current (HVDC) electric transmission line capable of transmitting over 3,500 MW of renewable energy generation from facilities in the Oklahoma panhandle region to load-serving entities in the southeastern United States via an

interconnection with the Tennessee Valley Authority in western Tennessee near Memphis. Pursuant to Section 1222(b), DOE's proposed action is to participate with Clean Line in executing the Project. DOE has not yet made any final determination with respect to whether the Project satisfies the requirements of Section 1222(b).

The HVDC transmission line would utilize two Alternating Current/Direct Current (AC/DC) converter stations, one at each end of the transmission line. The converter stations are proposed to be located in Texas County, Oklahoma, and Shelby County or Tipton County, Tennessee. Each converter station would be approximately 30 to 50 acres and would be located on private land. Right-of-way easements would be required for the transmission line and would have a typical width of approximately 150 to 200 feet. Tubular or lattice steel structures would be used to support the transmission line. Each structure would have a typical height from 120 to 200 feet, depending on site-specific conditions. Other limited quantities of larger specialty structures may be necessary to address engineering constraints in some locations. Additionally, access roads, improvements to existing roads, new overland access, and new unpaved temporary roads would be required to access the transmission line and related facilities during the construction, operation and maintenance phases. Finally, ancillary facilities such as communication facilities for control and protection would be required.

The Plains & Eastern Project would traverse several hundreds of miles of terrain prior to spanning the Mississippi River. The Plains & Eastern Project would require numerous Federal permits and authorizations. In part because of DOE's involvement, it will also be subject to consultation and environmental review requirements. Given the scope of all these requirements and the number of agencies involved in them, DOE is particularly interested in identifying cooperating agencies early in the NEPA process. DOE requests that each agency that may have a role in the Plains & Eastern Project, required or otherwise, help define the specific requirements which must be met to fulfill that agency's NEPA obligations and participate as a cooperating agency. This is in support of CEQ's guidance to ensure that Federal agencies actively participate as cooperating agencies in other agency's NEPA processes and to avoid duplication and unnecessary delays in the NEPA process. If your agency has multiple offices or regions that may participate as a cooperating agency in the EIS, please identify a lead office or region.

Should your agency agree to be a cooperating agency, DOE will endeavor to ensure that the information and analyses of the EIS would support any agency decision relative to their NEPA obligations. To that end, DOE anticipates that your agency will participate with DOE in:

- Reviewing technical approaches for analyzing impacts;
- Reviewing preliminary versions of the draft and final EIS;
- Representing your agency's interests, if timing allows, at the public scoping meetings;
and
- Engaging in activities associated with publication of the draft EIS, such as public hearings.

DOE may request that your agency respond to comments on the Draft EIS in a timely manner relating to subject matter specific to your agency's mission and goals.

DOE looks forward to the participation of your agency as a cooperating agency during the development of the Plains and Eastern EIS. In particular, we encourage input and suggestions from your agency on the scope of the EIS to ensure that all relevant environmental issues are addressed. Should your agency elect not to participate as a cooperating agency, DOE hopes that your agency still participates as a consulting or commenting agency to allow the EIS to benefit from your specific expertise.

Do not hesitate to contact us if you, or your staff, have any questions or concerns. The primary point of contact for this effort is DOE's EIS Deputy Document Manager, Ms. Melissa Ardis. She may be reached at 720-356-1566 or 720-291-1602 or via email at melissa.ardis@go.doe.gov. The Federal Document Manager, Dr. Jane Summerson, may be reached at (505) 845-4091 or via email at jane.summerson@ee.doe.gov.

Sincerely,

A handwritten signature in black ink that reads "Jane K. Summerson". The signature is written in a cursive style with a long horizontal flourish at the end.

Jane Summerson, Ph.D.
Federal Document Manager
Office of Electricity Delivery and
Energy Reliability



DEPARTMENT OF ENERGY
Washington, DC 20585

OFFICE OF THE SECRETARY

November 6, 2012

U.S. Environmental Protection Agency
Region 4 NEPA Program Office
Attn: Beth Walls
Sam Nunn AFC, 61 Forsyth Street
Atlanta, GA 30303-8960

Dear Ms. Walls:

SUBJECT: United State Department of Energy Invitation to Participate in the Plains & Eastern Clean Line Project Environmental Impact Statement (DOE/EIS-0486)

Pursuant to the Council on Environmental Quality's regulations (40 CFR 1501.6) that implement the National Environmental Policy Act of 1969 (NEPA) (42 USC 4321-4370(h)) the Department of Energy (DOE) invites the participation of your agency as a cooperating agency in the preparation of an environmental impact statement (EIS) for the Plains & Eastern Clean Line (Plains & Eastern) Project. In the EIS, DOE intends to analyze the potential environmental impacts of a project proposed by Plains & Eastern, to construct an overhead transmission line from western Oklahoma to the Tennessee Valley Authority in the southeastern United States. DOE is planning to publish, in December 2012, a Notice of Intent (NOI) to prepare the EIS. In keeping with the Administration's goal of moving transmission infrastructure projects expeditiously through the permitting and environmental review processes, DOE is requesting that you promptly notify DOE of your interest in participating in the EIS as a cooperating agency.

By way of background, Section 1222 (b) of the Energy Policy Act of 2005, provides that the Secretary of Energy, acting in consultation with the Western Area Power Administration (WAPA) or the Southwestern Power Administration (SWPA), or both, may design, develop, construct, operate, maintain or own, or participate with other entities in designing, developing, constructing, operating or owning, a new electric power transmission facility and related facilities.

In response to DOE's June 10, 2010 Request for Proposals, Clean Line Energy Partners, LLC (Clean Line) applied to the DOE under Section 1222(b) to work with and provide funds to DOE to develop a new +/- 600 kV high voltage direct current (HVDC) electric transmission line capable of transmitting over 3,500 MW of renewable energy generation from facilities in the Oklahoma panhandle region to load-serving entities in the southeastern United States via an interconnection with the Tennessee Valley Authority in western Tennessee near Memphis. Pursuant to Section 1222(b), DOE's proposed action is to participate with Clean Line in

executing the Project. DOE has not yet made any final determination with respect to whether the Project satisfies the requirements of Section 1222(b).

The HVDC transmission line would utilize two Alternating Current/Direct Current (AC/DC) converter stations, one at each end of the transmission line. The converter stations are proposed to be located in Texas County, Oklahoma, and Shelby County or Tipton County, Tennessee. Each converter station would be approximately 30 to 50 acres and would be located on private land. Right-of-way easements would be required for the transmission line and would have a typical width of approximately 150 to 200 feet. Tubular or lattice steel structures would be used to support the transmission line. Each structure would have a typical height from 120 to 200 feet, depending on site-specific conditions. Other limited quantities of larger specialty structures may be necessary to address engineering constraints in some locations. Additionally, access roads, improvements to existing roads, new overland access, and new unpaved temporary roads would be required to access the transmission line and related facilities during the construction, operation and maintenance phases. Finally, ancillary facilities such as communication facilities for control and protection would be required.

The Plains & Eastern Project would traverse several hundreds of miles of terrain prior to spanning the Mississippi River. The Plains & Eastern Project would require numerous Federal permits and authorizations. In part because of DOE's involvement, it will also be subject to consultation and environmental review requirements. Given the scope of all these requirements and the number of agencies involved in them, DOE is particularly interested in identifying cooperating agencies early in the NEPA process. DOE requests that each agency that may have a role in the Plains & Eastern Project, required or otherwise, help define the specific requirements which must be met to fulfill that agency's NEPA obligations and participate as a cooperating agency. This is in support of CEQ's guidance to ensure that Federal agencies actively participate as cooperating agencies in other agency's NEPA processes and to avoid duplication and unnecessary delays in the NEPA process. If your agency has multiple offices or regions that may participate as a cooperating agency in the EIS, please identify a lead office or region.

Should your agency agree to be a cooperating agency, DOE will endeavor to ensure that the information and analyses of the EIS would support any agency decision relative to their NEPA obligations. To that end, DOE anticipates that your agency will participate with DOE in:

- Reviewing technical approaches for analyzing impacts;
- Reviewing preliminary versions of the draft and final EIS;
- Representing your agency's interests, if timing allows, at the public scoping meetings; and
- Engaging in activities associated with publication of the draft EIS, such as public hearings.

DOE may request that your agency respond to comments on the Draft EIS in a timely manner relating to subject matter specific to your agency's mission and goals.

DOE looks forward to the participation of your agency as a cooperating agency during the development of the Plains and Eastern EIS. In particular, we encourage input and suggestions from your agency on the scope of the EIS to ensure that all relevant environmental issues are addressed. Should your agency elect not to participate as a cooperating agency, DOE hopes that your agency still participates as a consulting or commenting agency to allow the EIS to benefit from your specific expertise.

Do not hesitate to contact us if you, or your staff, have any questions or concerns. The primary point of contact for this effort is DOE's EIS Deputy Document Manager, Ms. Melissa Ardis. She may be reached at 720-356-1566 or 720-291-1602 or via email at melissa.ardis@go.doe.gov. The Federal Document Manager, Dr. Jane Summerson, may be reached at (505) 845-4091 or via email at jane.summerson@ee.doe.gov.

Sincerely,

A handwritten signature in cursive script, appearing to read "Jane K. Summerson".

Jane Summerson, Ph.D.
Federal Document Manager
Office of Electricity Delivery and
Energy Reliability



DEPARTMENT OF ENERGY
Washington, DC 20585

OFFICE OF THE SECRETARY

November 6, 2012

U.S. Environmental Protection Agency
Region 6 Office of Planning and Coordination
Attn: Cathy Gilmore
1445 Ross Ave., 12th Floor, Suite 1200
Dallas, TX 75202-2733

Dear Ms. Gilmore:

SUBJECT: United State Department of Energy Invitation to Participate in the Plains & Eastern Clean Line Project Environmental Impact Statement (DOE/EIS-0486)

Pursuant to the Council on Environmental Quality's regulations (40 CFR 1501.6) that implement the National Environmental Policy Act of 1969 (NEPA) (42 USC 4321-4370(h)) the Department of Energy (DOE) invites the participation of your agency as a cooperating agency in the preparation of an environmental impact statement (EIS) for the Plains & Eastern Clean Line (Plains & Eastern) Project. In the EIS, DOE intends to analyze the potential environmental impacts of a project proposed by Plains & Eastern, to construct an overhead transmission line from western Oklahoma to the Tennessee Valley Authority in the southeastern United States. DOE is planning to publish, in December 2012, a Notice of Intent (NOI) to prepare the EIS. In keeping with the Administration's goal of moving transmission infrastructure projects expeditiously through the permitting and environmental review processes, DOE is requesting that you promptly notify DOE of your interest in participating in the EIS as a cooperating agency.

By way of background, Section 1222 (b) of the Energy Policy Act of 2005, provides that the Secretary of Energy, acting in consultation with the Western Area Power Administration (WAPA) or the Southwestern Power Administration (SWPA), or both, may design, develop, construct, operate, maintain or own, or participate with other entities in designing, developing, constructing, operating or owning, a new electric power transmission facility and related facilities.

In response to DOE's June 10, 2010 Request for Proposals, Clean Line Energy Partners, LLC (Clean Line) applied to the DOE under Section 1222(b) to work with and provide funds to DOE to develop a new +/- 600 kV high voltage direct current (HVDC) electric transmission line capable of transmitting over 3,500 MW of renewable energy generation from facilities in the Oklahoma panhandle region to load-serving entities in the southeastern United States via an interconnection with the Tennessee Valley Authority in western Tennessee near Memphis. Pursuant to Section 1222(b), DOE's proposed action is to participate with Clean Line in

executing the Project. DOE has not yet made any final determination with respect to whether the Project satisfies the requirements of Section 1222(b).

The HVDC transmission line would utilize two Alternating Current/Direct Current (AC/DC) converter stations, one at each end of the transmission line. The converter stations are proposed to be located in Texas County, Oklahoma, and Shelby County or Tipton County, Tennessee. Each converter station would be approximately 30 to 50 acres and would be located on private land. Right-of-way easements would be required for the transmission line and would have a typical width of approximately 150 to 200 feet. Tubular or lattice steel structures would be used to support the transmission line. Each structure would have a typical height from 120 to 200 feet, depending on site-specific conditions. Other limited quantities of larger specialty structures may be necessary to address engineering constraints in some locations. Additionally, access roads, improvements to existing roads, new overland access, and new unpaved temporary roads would be required to access the transmission line and related facilities during the construction, operation and maintenance phases. Finally, ancillary facilities such as communication facilities for control and protection would be required.

The Plains & Eastern Project would traverse several hundreds of miles of terrain prior to spanning the Mississippi River. The Plains & Eastern Project would require numerous Federal permits and authorizations. In part because of DOE's involvement, it will also be subject to consultation and environmental review requirements. Given the scope of all these requirements and the number of agencies involved in them, DOE is particularly interested in identifying cooperating agencies early in the NEPA process. DOE requests that each agency that may have a role in the Plains & Eastern Project, required or otherwise, help define the specific requirements which must be met to fulfill that agency's NEPA obligations and participate as a cooperating agency. This is in support of CEQ's guidance to ensure that Federal agencies actively participate as cooperating agencies in other agency's NEPA processes and to avoid duplication and unnecessary delays in the NEPA process. If your agency has multiple offices or regions that may participate as a cooperating agency in the EIS, please identify a lead office or region.

Should your agency agree to be a cooperating agency, DOE will endeavor to ensure that the information and analyses of the EIS would support any agency decision relative to their NEPA obligations. To that end, DOE anticipates that your agency will participate with DOE in:

- Reviewing technical approaches for analyzing impacts;
- Reviewing preliminary versions of the draft and final EIS;
- Representing your agency's interests, if timing allows, at the public scoping meetings; and
- Engaging in activities associated with publication of the draft EIS, such as public hearings.

DOE may request that your agency respond to comments on the Draft EIS in a timely manner relating to subject matter specific to your agency's mission and goals.

DOE looks forward to the participation of your agency as a cooperating agency during the development of the Plains and Eastern EIS. In particular, we encourage input and suggestions from your agency on the scope of the EIS to ensure that all relevant environmental issues are addressed. Should your agency elect not to participate as a cooperating agency, DOE hopes that your agency still participates as a consulting or commenting agency to allow the EIS to benefit from your specific expertise.

Do not hesitate to contact us if you, or your staff, have any questions or concerns. The primary point of contact for this effort is DOE's EIS Deputy Document Manager, Ms. Melissa Ardis. She may be reached at 720-356-1566 or 720-291-1602 or via email at melissa.ardis@go.doe.gov. The Federal Document Manager, Dr. Jane Summerson, may be reached at (505) 845-4091 or via email at jane.summerson@ee.doe.gov.

Sincerely,

A handwritten signature in cursive script, appearing to read "Jane K. Summerson".

Jane Summerson, Ph.D.
Federal Document Manager
Office of Electricity Delivery and
Energy Reliability



DEPARTMENT OF ENERGY
Washington, DC 20585

OFFICE OF THE SECRETARY

November 6, 2012

Tennessee Valley Authority
Attn: Chuck Nicholson
400 W. Summit Hill Drive
WT 11D
Knoxville, TN 37902

Dear Mr. Nicholson:

SUBJECT: United State Department of Energy Invitation to Participate in the Plains & Eastern Clean Line Project Environmental Impact Statement (DOE/EIS-0486)

Pursuant to the Council on Environmental Quality's regulations (40 CFR 1501.6) that implement the National Environmental Policy Act of 1969 (NEPA) (42 USC 4321-4370(h)) the Department of Energy (DOE) invites the participation of your agency as a cooperating agency in the preparation of an environmental impact statement (EIS) for the Plains & Eastern Clean Line (Plains & Eastern) Project. In the EIS, DOE intends to analyze the potential environmental impacts of a project proposed by Plains & Eastern, to construct an overhead transmission line from western Oklahoma to the Tennessee Valley Authority in the southeastern United States. DOE is planning to publish, in December 2012, a Notice of Intent (NOI) to prepare the EIS. In keeping with the Administration's goal of moving transmission infrastructure projects expeditiously through the permitting and environmental review processes, DOE is requesting that you promptly notify DOE of your interest in participating in the EIS as a cooperating agency.

By way of background, Section 1222 (b) of the Energy Policy Act of 2005, provides that the Secretary of Energy, acting in consultation with the Western Area Power Administration (WAPA) or the Southwestern Power Administration (SWPA), or both, may design, develop, construct, operate, maintain or own, or participate with other entities in designing, developing, constructing, operating or owning, a new electric power transmission facility and related facilities.

In response to DOE's June 10, 2010 Request for Proposals, Clean Line Energy Partners, LLC (Clean Line) applied to the DOE under Section 1222(b) to work with and provide funds to DOE to develop a new +/- 600 kV high voltage direct current (HVDC) electric transmission line capable of transmitting over 3,500 MW of renewable energy generation from facilities in the Oklahoma panhandle region to load-serving entities in the southeastern United States via an interconnection with the Tennessee Valley Authority in western Tennessee near Memphis. Pursuant to Section 1222(b), DOE's proposed action is to participate with Clean Line in

executing the Project. DOE has not yet made any final determination with respect to whether the Project satisfies the requirements of Section 1222(b).

The HVDC transmission line would utilize two Alternating Current/Direct Current (AC/DC) converter stations, one at each end of the transmission line. The converter stations are proposed to be located in Texas County, Oklahoma, and Shelby County or Tipton County, Tennessee. Each converter station would be approximately 30 to 50 acres and would be located on private land. Right-of-way easements would be required for the transmission line and would have a typical width of approximately 150 to 200 feet. Tubular or lattice steel structures would be used to support the transmission line. Each structure would have a typical height from 120 to 200 feet, depending on site-specific conditions. Other limited quantities of larger specialty structures may be necessary to address engineering constraints in some locations. Additionally, access roads, improvements to existing roads, new overland access, and new unpaved temporary roads would be required to access the transmission line and related facilities during the construction, operation and maintenance phases. Finally, ancillary facilities such as communication facilities for control and protection would be required.

The Plains & Eastern Project would traverse several hundreds of miles of terrain prior to spanning the Mississippi River. The Plains & Eastern Project would require numerous Federal permits and authorizations. In part because of DOE's involvement, it will also be subject to consultation and environmental review requirements. Given the scope of all these requirements and the number of agencies involved in them, DOE is particularly interested in identifying cooperating agencies early in the NEPA process. DOE requests that each agency that may have a role in the Plains & Eastern Project, required or otherwise, help define the specific requirements which must be met to fulfill that agency's NEPA obligations and participate as a cooperating agency. This is in support of CEQ's guidance to ensure that Federal agencies actively participate as cooperating agencies in other agency's NEPA processes and to avoid duplication and unnecessary delays in the NEPA process. If your agency has multiple offices or regions that may participate as a cooperating agency in the EIS, please identify a lead office or region.

Should your agency agree to be a cooperating agency, DOE will endeavor to ensure that the information and analyses of the EIS would support any agency decision relative to their NEPA obligations. To that end, DOE anticipates that your agency will participate with DOE in:

- Reviewing technical approaches for analyzing impacts;
- Reviewing preliminary versions of the draft and final EIS;
- Representing your agency's interests, if timing allows, at the public scoping meetings; and
- Engaging in activities associated with publication of the draft EIS, such as public hearings.

DOE may request that your agency respond to comments on the Draft EIS in a timely manner relating to subject matter specific to your agency's mission and goals.

DOE looks forward to the participation of your agency as a cooperating agency during the development of the Plains and Eastern EIS. In particular, we encourage input and suggestions from your agency on the scope of the EIS to ensure that all relevant environmental issues are addressed. Should your agency elect not to participate as a cooperating agency, DOE hopes that your agency still participates as a consulting or commenting agency to allow the EIS to benefit from your specific expertise.

Do not hesitate to contact us if you, or your staff, have any questions or concerns. The primary point of contact for this effort is DOE's EIS Deputy Document Manager, Ms. Melissa Ardis. She may be reached at 720-356-1566 or 720-291-1602 or via email at melissa.ardis@go.doe.gov. The Federal Document Manager, Dr. Jane Summerson, may be reached at (505) 845-4091 or via email at jane.summerson@ee.doe.gov.

Sincerely,

A handwritten signature in black ink, appearing to read "Jane K. Summerson". The signature is fluid and cursive, written over a light blue vertical line that runs down the page.

Jane Summerson, Ph.D.
Federal Document Manager
Office of Electricity Delivery and
Energy Reliability



DEPARTMENT OF ENERGY
Washington, DC 20585

OFFICE OF THE SECRETARY

November 6, 2012

USDA Natural Resources Conservation Service
Arkansas
Attn: Edgar Mersiovsky
Room 3416, Federal Building 700 West Capitol Ave
Little Rock, AR 72201-3225

Dear Mr. Mersiovsky:

SUBJECT: United State Department of Energy Invitation to Participate in the Plains & Eastern Clean Line Project Environmental Impact Statement (DOE/EIS-0486)

Pursuant to the Council on Environmental Quality's regulations (40 CFR 1501.6) that implement the National Environmental Policy Act of 1969 (NEPA) (42 USC 4321-4370(h)) the Department of Energy (DOE) invites the participation of your agency as a cooperating agency in the preparation of an environmental impact statement (EIS) for the Plains & Eastern Clean Line (Plains & Eastern) Project. In the EIS, DOE intends to analyze the potential environmental impacts of a project proposed by Plains & Eastern, to construct an overhead transmission line from western Oklahoma to the Tennessee Valley Authority in the southeastern United States. DOE is planning to publish, in December 2012, a Notice of Intent (NOI) to prepare the EIS. In keeping with the Administration's goal of moving transmission infrastructure projects expeditiously through the permitting and environmental review processes, DOE is requesting that you promptly notify DOE of your interest in participating in the EIS as a cooperating agency.

By way of background, Section 1222 (b) of the Energy Policy Act of 2005, provides that the Secretary of Energy, acting in consultation with the Western Area Power Administration (WAPA) or the Southwestern Power Administration (SWPA), or both, may design, develop, construct, operate, maintain or own, or participate with other entities in designing, developing, constructing, operating or owning, a new electric power transmission facility and related facilities.

In response to DOE's June 10, 2010 Request for Proposals, Clean Line Energy Partners, LLC (Clean Line) applied to the DOE under Section 1222(b) to work with and provide funds to DOE to develop a new +/- 600 kV high voltage direct current (HVDC) electric transmission line capable of transmitting over 3,500 MW of renewable energy generation from facilities in the Oklahoma panhandle region to load-serving entities in the southeastern United States via an interconnection with the Tennessee Valley Authority in western Tennessee near Memphis. Pursuant to Section 1222(b), DOE's proposed action is to participate with Clean Line in

executing the Project. DOE has not yet made any final determination with respect to whether the Project satisfies the requirements of Section 1222(b).

The HVDC transmission line would utilize two Alternating Current/Direct Current (AC/DC) converter stations, one at each end of the transmission line. The converter stations are proposed to be located in Texas County, Oklahoma, and Shelby County or Tipton County, Tennessee. Each converter station would be approximately 30 to 50 acres and would be located on private land. Right-of-way easements would be required for the transmission line and would have a typical width of approximately 150 to 200 feet. Tubular or lattice steel structures would be used to support the transmission line. Each structure would have a typical height from 120 to 200 feet, depending on site-specific conditions. Other limited quantities of larger specialty structures may be necessary to address engineering constraints in some locations. Additionally, access roads, improvements to existing roads, new overland access, and new unpaved temporary roads would be required to access the transmission line and related facilities during the construction, operation and maintenance phases. Finally, ancillary facilities such as communication facilities for control and protection would be required.

The Plains & Eastern Project would traverse several hundreds of miles of terrain prior to spanning the Mississippi River. The Plains & Eastern Project would require numerous Federal permits and authorizations. In part because of DOE's involvement, it will also be subject to consultation and environmental review requirements. Given the scope of all these requirements and the number of agencies involved in them, DOE is particularly interested in identifying cooperating agencies early in the NEPA process. DOE requests that each agency that may have a role in the Plains & Eastern Project, required or otherwise, help define the specific requirements which must be met to fulfill that agency's NEPA obligations and participate as a cooperating agency. This is in support of CEQ's guidance to ensure that Federal agencies actively participate as cooperating agencies in other agency's NEPA processes and to avoid duplication and unnecessary delays in the NEPA process. If your agency has multiple offices or regions that may participate as a cooperating agency in the EIS, please identify a lead office or region.

Should your agency agree to be a cooperating agency, DOE will endeavor to ensure that the information and analyses of the EIS would support any agency decision relative to their NEPA obligations. To that end, DOE anticipates that your agency will participate with DOE in:

- Reviewing technical approaches for analyzing impacts;
- Reviewing preliminary versions of the draft and final EIS;
- Representing your agency's interests, if timing allows, at the public scoping meetings; and
- Engaging in activities associated with publication of the draft EIS, such as public hearings.

DOE may request that your agency respond to comments on the Draft EIS in a timely manner relating to subject matter specific to your agency's mission and goals.

DOE looks forward to the participation of your agency as a cooperating agency during the development of the Plains and Eastern EIS. In particular, we encourage input and suggestions from your agency on the scope of the EIS to ensure that all relevant environmental issues are addressed. Should your agency elect not to participate as a cooperating agency, DOE hopes that your agency still participates as a consulting or commenting agency to allow the EIS to benefit from your specific expertise.

Do not hesitate to contact us if you, or your staff, have any questions or concerns. The primary point of contact for this effort is DOE's EIS Deputy Document Manager, Ms. Melissa Ardis. She may be reached at 720-356-1566 or 720-291-1602 or via email at melissa.ardis@go.doe.gov. The Federal Document Manager, Dr. Jane Summerson, may be reached at (505) 845-4091 or via email at jane.summerson@ee.doe.gov.

Sincerely,

A handwritten signature in cursive script that reads "Jane K. Summerson".

Jane Summerson, Ph.D.
Federal Document Manager
Office of Electricity Delivery and
Energy Reliability



DEPARTMENT OF ENERGY
Washington, DC 20585

OFFICE OF THE SECRETARY

November 6, 2012

Natural Resources Conservation Service
Easement Programs Division
Attn: Jessica Groves
14th and Independence Ave., SW.
Washington D.C. 20250

Dear Ms. Groves:

SUBJECT: United State Department of Energy Invitation to Participate in the Plains & Eastern Clean Line Project Environmental Impact Statement (DOE/EIS-0486)

Pursuant to the Council on Environmental Quality's regulations (40 CFR 1501.6) that implement the National Environmental Policy Act of 1969 (NEPA) (42 USC 4321-4370(h)) the Department of Energy (DOE) invites the participation of your agency as a cooperating agency in the preparation of an environmental impact statement (EIS) for the Plains & Eastern Clean Line (Plains & Eastern) Project. In the EIS, DOE intends to analyze the potential environmental impacts of a project proposed by Plains & Eastern, to construct an overhead transmission line from western Oklahoma to the Tennessee Valley Authority in the southeastern United States. DOE is planning to publish, in December 2012, a Notice of Intent (NOI) to prepare the EIS. In keeping with the Administration's goal of moving transmission infrastructure projects expeditiously through the permitting and environmental review processes, DOE is requesting that you promptly notify DOE of your interest in participating in the EIS as a cooperating agency.

By way of background, Section 1222 (b) of the Energy Policy Act of 2005, provides that the Secretary of Energy, acting in consultation with the Western Area Power Administration (WAPA) or the Southwestern Power Administration (SWPA), or both, may design, develop, construct, operate, maintain or own, or participate with other entities in designing, developing, constructing, operating or owning, a new electric power transmission facility and related facilities.

In response to DOE's June 10, 2010 Request for Proposals, Clean Line Energy Partners, LLC (Clean Line) applied to the DOE under Section 1222(b) to work with and provide funds to DOE to develop a new +/- 600 kV high voltage direct current (HVDC) electric transmission line capable of transmitting over 3,500 MW of renewable energy generation from facilities in the Oklahoma panhandle region to load-serving entities in the southeastern United States via an interconnection with the Tennessee Valley Authority in western Tennessee near Memphis. Pursuant to Section 1222(b), DOE's proposed action is to participate with Clean Line in

executing the Project. DOE has not yet made any final determination with respect to whether the Project satisfies the requirements of Section 1222(b).

The HVDC transmission line would utilize two Alternating Current/Direct Current (AC/DC) converter stations, one at each end of the transmission line. The converter stations are proposed to be located in Texas County, Oklahoma, and Shelby County or Tipton County, Tennessee. Each converter station would be approximately 30 to 50 acres and would be located on private land. Right-of-way easements would be required for the transmission line and would have a typical width of approximately 150 to 200 feet. Tubular or lattice steel structures would be used to support the transmission line. Each structure would have a typical height from 120 to 200 feet, depending on site-specific conditions. Other limited quantities of larger specialty structures may be necessary to address engineering constraints in some locations. Additionally, access roads, improvements to existing roads, new overland access, and new unpaved temporary roads would be required to access the transmission line and related facilities during the construction, operation and maintenance phases. Finally, ancillary facilities such as communication facilities for control and protection would be required.

The Plains & Eastern Project would traverse several hundreds of miles of terrain prior to spanning the Mississippi River. The Plains & Eastern Project would require numerous Federal permits and authorizations. In part because of DOE's involvement, it will also be subject to consultation and environmental review requirements. Given the scope of all these requirements and the number of agencies involved in them, DOE is particularly interested in identifying cooperating agencies early in the NEPA process. DOE requests that each agency that may have a role in the Plains & Eastern Project, required or otherwise, help define the specific requirements which must be met to fulfill that agency's NEPA obligations and participate as a cooperating agency. This is in support of CEQ's guidance to ensure that Federal agencies actively participate as cooperating agencies in other agency's NEPA processes and to avoid duplication and unnecessary delays in the NEPA process. If your agency has multiple offices or regions that may participate as a cooperating agency in the EIS, please identify a lead office or region.

Should your agency agree to be a cooperating agency, DOE will endeavor to ensure that the information and analyses of the EIS would support any agency decision relative to their NEPA obligations. To that end, DOE anticipates that your agency will participate with DOE in:

- Reviewing technical approaches for analyzing impacts;
- Reviewing preliminary versions of the draft and final EIS;
- Representing your agency's interests, if timing allows, at the public scoping meetings; and
- Engaging in activities associated with publication of the draft EIS, such as public hearings.

DOE may request that your agency respond to comments on the Draft EIS in a timely manner relating to subject matter specific to your agency's mission and goals.

DOE looks forward to the participation of your agency as a cooperating agency during the development of the Plains and Eastern EIS. In particular, we encourage input and suggestions from your agency on the scope of the EIS to ensure that all relevant environmental issues are addressed. Should your agency elect not to participate as a cooperating agency, DOE hopes that your agency still participates as a consulting or commenting agency to allow the EIS to benefit from your specific expertise.

Do not hesitate to contact us if you, or your staff, have any questions or concerns. The primary point of contact for this effort is DOE's EIS Deputy Document Manager, Ms. Melissa Ardis. She may be reached at 720-356-1566 or 720-291-1602 or via email at melissa.ardis@go.doe.gov. The Federal Document Manager, Dr. Jane Summerson, may be reached at (505) 845-4091 or via email at jane.summerson@ee.doe.gov.

Sincerely,

A handwritten signature in cursive script that reads "Jane K. Summerson". The signature is written in black ink and is positioned below the word "Sincerely,".

Jane Summerson, Ph.D.
Federal Document Manager
Office of Electricity Delivery and
Energy Reliability



DEPARTMENT OF ENERGY
Washington, DC 20585

OFFICE OF THE SECRETARY

November 6, 2012

USDA Natural Resources Conservation Service
Oklahoma
Attn: Suzanne Collier
100 USDA Suite 206
Stillwater, OK 74047

Dear Ms. Collier:

SUBJECT: United State Department of Energy Invitation to Participate in the Plains & Eastern Clean Line Project Environmental Impact Statement (DOE/EIS-0486)

Pursuant to the Council on Environmental Quality's regulations (40 CFR 1501.6) that implement the National Environmental Policy Act of 1969 (NEPA) (42 USC 4321-4370(h)) the Department of Energy (DOE) invites the participation of your agency as a cooperating agency in the preparation of an environmental impact statement (EIS) for the Plains & Eastern Clean Line (Plains & Eastern) Project. In the EIS, DOE intends to analyze the potential environmental impacts of a project proposed by Plains & Eastern, to construct an overhead transmission line from western Oklahoma to the Tennessee Valley Authority in the southeastern United States. DOE is planning to publish, in December 2012, a Notice of Intent (NOI) to prepare the EIS. In keeping with the Administration's goal of moving transmission infrastructure projects expeditiously through the permitting and environmental review processes, DOE is requesting that you promptly notify DOE of your interest in participating in the EIS as a cooperating agency.

By way of background, Section 1222 (b) of the Energy Policy Act of 2005, provides that the Secretary of Energy, acting in consultation with the Western Area Power Administration (WAPA) or the Southwestern Power Administration (SWPA), or both, may design, develop, construct, operate, maintain or own, or participate with other entities in designing, developing, constructing, operating or owning, a new electric power transmission facility and related facilities.

In response to DOE's June 10, 2010 Request for Proposals, Clean Line Energy Partners, LLC (Clean Line) applied to the DOE under Section 1222(b) to work with and provide funds to DOE to develop a new +/- 600 kV high voltage direct current (HVDC) electric transmission line capable of transmitting over 3,500 MW of renewable energy generation from facilities in the Oklahoma panhandle region to load-serving entities in the southeastern United States via an interconnection with the Tennessee Valley Authority in western Tennessee near Memphis. Pursuant to Section 1222(b), DOE's proposed action is to participate with Clean Line in

executing the Project. DOE has not yet made any final determination with respect to whether the Project satisfies the requirements of Section 1222(b).

The HVDC transmission line would utilize two Alternating Current/Direct Current (AC/DC) converter stations, one at each end of the transmission line. The converter stations are proposed to be located in Texas County, Oklahoma, and Shelby County or Tipton County, Tennessee. Each converter station would be approximately 30 to 50 acres and would be located on private land. Right-of-way easements would be required for the transmission line and would have a typical width of approximately 150 to 200 feet. Tubular or lattice steel structures would be used to support the transmission line. Each structure would have a typical height from 120 to 200 feet, depending on site-specific conditions. Other limited quantities of larger specialty structures may be necessary to address engineering constraints in some locations. Additionally, access roads, improvements to existing roads, new overland access, and new unpaved temporary roads would be required to access the transmission line and related facilities during the construction, operation and maintenance phases. Finally, ancillary facilities such as communication facilities for control and protection would be required.

The Plains & Eastern Project would traverse several hundreds of miles of terrain prior to spanning the Mississippi River. The Plains & Eastern Project would require numerous Federal permits and authorizations. In part because of DOE's involvement, it will also be subject to consultation and environmental review requirements. Given the scope of all these requirements and the number of agencies involved in them, DOE is particularly interested in identifying cooperating agencies early in the NEPA process. DOE requests that each agency that may have a role in the Plains & Eastern Project, required or otherwise, help define the specific requirements which must be met to fulfill that agency's NEPA obligations and participate as a cooperating agency. This is in support of CEQ's guidance to ensure that Federal agencies actively participate as cooperating agencies in other agency's NEPA processes and to avoid duplication and unnecessary delays in the NEPA process. If your agency has multiple offices or regions that may participate as a cooperating agency in the EIS, please identify a lead office or region.

Should your agency agree to be a cooperating agency, DOE will endeavor to ensure that the information and analyses of the EIS would support any agency decision relative to their NEPA obligations. To that end, DOE anticipates that your agency will participate with DOE in:

- Reviewing technical approaches for analyzing impacts;
- Reviewing preliminary versions of the draft and final EIS;
- Representing your agency's interests, if timing allows, at the public scoping meetings; and
- Engaging in activities associated with publication of the draft EIS, such as public hearings.

DOE may request that your agency respond to comments on the Draft EIS in a timely manner relating to subject matter specific to your agency's mission and goals.

DOE looks forward to the participation of your agency as a cooperating agency during the development of the Plains and Eastern EIS. In particular, we encourage input and suggestions from your agency on the scope of the EIS to ensure that all relevant environmental issues are addressed. Should your agency elect not to participate as a cooperating agency, DOE hopes that your agency still participates as a consulting or commenting agency to allow the EIS to benefit from your specific expertise.

Do not hesitate to contact us if you, or your staff, have any questions or concerns. The primary point of contact for this effort is DOE's EIS Deputy Document Manager, Ms. Melissa Ardis. She may be reached at 720-356-1566 or 720-291-1602 or via email at melissa.ardis@go.doe.gov. The Federal Document Manager, Dr. Jane Summerson, may be reached at (505) 845-4091 or via email at jane.summerson@ee.doe.gov.

Sincerely,

A handwritten signature in cursive script that reads "Jane K. Summerson".

Jane Summerson, Ph.D.
Federal Document Manager
Office of Electricity Delivery and
Energy Reliability



DEPARTMENT OF ENERGY
Washington, DC 20585

OFFICE OF THE SECRETARY

November 6, 2012

Natural Resources Conservation Service
Tennessee
Attn: Craig Ellis
675 U.S. Courthouse, 801 Broadway
Nashville, TN 37203

Dear Mr. Ellis:

SUBJECT: United State Department of Energy Invitation to Participate in the Plains & Eastern Clean Line Project Environmental Impact Statement (DOE/EIS-0486)

Pursuant to the Council on Environmental Quality's regulations (40 CFR 1501.6) that implement the National Environmental Policy Act of 1969 (NEPA) (42 USC 4321-4370(h)) the Department of Energy (DOE) invites the participation of your agency as a cooperating agency in the preparation of an environmental impact statement (EIS) for the Plains & Eastern Clean Line (Plains & Eastern) Project. In the EIS, DOE intends to analyze the potential environmental impacts of a project proposed by Plains & Eastern, to construct an overhead transmission line from western Oklahoma to the Tennessee Valley Authority in the southeastern United States. DOE is planning to publish, in December 2012, a Notice of Intent (NOI) to prepare the EIS. In keeping with the Administration's goal of moving transmission infrastructure projects expeditiously through the permitting and environmental review processes, DOE is requesting that you promptly notify DOE of your interest in participating in the EIS as a cooperating agency.

By way of background, Section 1222 (b) of the Energy Policy Act of 2005, provides that the Secretary of Energy, acting in consultation with the Western Area Power Administration (WAPA) or the Southwestern Power Administration (SWPA), or both, may design, develop, construct, operate, maintain or own, or participate with other entities in designing, developing, constructing, operating or owning, a new electric power transmission facility and related facilities.

In response to DOE's June 10, 2010 Request for Proposals, Clean Line Energy Partners, LLC (Clean Line) applied to the DOE under Section 1222(b) to work with and provide funds to DOE to develop a new +/- 600 kV high voltage direct current (HVDC) electric transmission line capable of transmitting over 3,500 MW of renewable energy generation from facilities in the Oklahoma panhandle region to load-serving entities in the southeastern United States via an interconnection with the Tennessee Valley Authority in western Tennessee near Memphis. Pursuant to Section 1222(b), DOE's proposed action is to participate with Clean Line in

executing the Project. DOE has not yet made any final determination with respect to whether the Project satisfies the requirements of Section 1222(b).

The HVDC transmission line would utilize two Alternating Current/Direct Current (AC/DC) converter stations, one at each end of the transmission line. The converter stations are proposed to be located in Texas County, Oklahoma, and Shelby County or Tipton County, Tennessee. Each converter station would be approximately 30 to 50 acres and would be located on private land. Right-of-way easements would be required for the transmission line and would have a typical width of approximately 150 to 200 feet. Tubular or lattice steel structures would be used to support the transmission line. Each structure would have a typical height from 120 to 200 feet, depending on site-specific conditions. Other limited quantities of larger specialty structures may be necessary to address engineering constraints in some locations. Additionally, access roads, improvements to existing roads, new overland access, and new unpaved temporary roads would be required to access the transmission line and related facilities during the construction, operation and maintenance phases. Finally, ancillary facilities such as communication facilities for control and protection would be required.

The Plains & Eastern Project would traverse several hundreds of miles of terrain prior to spanning the Mississippi River. The Plains & Eastern Project would require numerous Federal permits and authorizations. In part because of DOE's involvement, it will also be subject to consultation and environmental review requirements. Given the scope of all these requirements and the number of agencies involved in them, DOE is particularly interested in identifying cooperating agencies early in the NEPA process. DOE requests that each agency that may have a role in the Plains & Eastern Project, required or otherwise, help define the specific requirements which must be met to fulfill that agency's NEPA obligations and participate as a cooperating agency. This is in support of CEQ's guidance to ensure that Federal agencies actively participate as cooperating agencies in other agency's NEPA processes and to avoid duplication and unnecessary delays in the NEPA process. If your agency has multiple offices or regions that may participate as a cooperating agency in the EIS, please identify a lead office or region.

Should your agency agree to be a cooperating agency, DOE will endeavor to ensure that the information and analyses of the EIS would support any agency decision relative to their NEPA obligations. To that end, DOE anticipates that your agency will participate with DOE in:

- Reviewing technical approaches for analyzing impacts;
- Reviewing preliminary versions of the draft and final EIS;
- Representing your agency's interests, if timing allows, at the public scoping meetings; and
- Engaging in activities associated with publication of the draft EIS, such as public hearings.

DOE may request that your agency respond to comments on the Draft EIS in a timely manner relating to subject matter specific to your agency's mission and goals.

DOE looks forward to the participation of your agency as a cooperating agency during the development of the Plains and Eastern EIS. In particular, we encourage input and suggestions from your agency on the scope of the EIS to ensure that all relevant environmental issues are addressed. Should your agency elect not to participate as a cooperating agency, DOE hopes that your agency still participates as a consulting or commenting agency to allow the EIS to benefit from your specific expertise.

Do not hesitate to contact us if you, or your staff, have any questions or concerns. The primary point of contact for this effort is DOE's EIS Deputy Document Manager, Ms. Melissa Ardis. She may be reached at 720-356-1566 or 720-291-1602 or via email at melissa.ardis@go.doe.gov. The Federal Document Manager, Dr. Jane Summerson, may be reached at (505) 845-4091 or via email at jane.summerson@ee.doe.gov.

Sincerely,

A handwritten signature in cursive script, appearing to read "Jane K. Summerson".

Jane Summerson, Ph.D.
Federal Document Manager
Office of Electricity Delivery and
Energy Reliability



DEPARTMENT OF ENERGY
Washington, DC 20585

OFFICE OF THE SECRETARY

November 6, 2012

U.S. Army Corps of Engineers
Attn: Timothy Hartsfield
Regulatory Office
1645 S 101 E Ave
Tulsa, OK 74128-4609

Dear Mr. Hartsfield:

SUBJECT: United State Department of Energy Invitation to Participate in the Plains & Eastern Clean Line Project Environmental Impact Statement (DOE/EIS-0486)

Pursuant to the Council on Environmental Quality's regulations (40 CFR 1501.6) that implement the National Environmental Policy Act of 1969 (NEPA) (42 USC 4321-4370(h)) the Department of Energy (DOE) invites the participation of your agency as a cooperating agency in the preparation of an environmental impact statement (EIS) for the Plains & Eastern Clean Line (Plains & Eastern) Project. In the EIS, DOE intends to analyze the potential environmental impacts of a project proposed by Plains & Eastern, to construct an overhead transmission line from western Oklahoma to the Tennessee Valley Authority in the southeastern United States. DOE is planning to publish, in December 2012, a Notice of Intent (NOI) to prepare the EIS. In keeping with the Administration's goal of moving transmission infrastructure projects expeditiously through the permitting and environmental review processes, DOE is requesting that you promptly notify DOE of your interest in participating in the EIS as a cooperating agency.

By way of background, Section 1222 (b) of the Energy Policy Act of 2005, provides that the Secretary of Energy, acting in consultation with the Western Area Power Administration (WAPA) or the Southwestern Power Administration (SWPA), or both, may design, develop, construct, operate, maintain or own, or participate with other entities in designing, developing, constructing, operating or owning, a new electric power transmission facility and related facilities.

In response to DOE's June 10, 2010 Request for Proposals, Clean Line Energy Partners, LLC (Clean Line) applied to the DOE under Section 1222(b) to work with and provide funds to DOE to develop a new +/- 600 kV high voltage direct current (HVDC) electric transmission line capable of transmitting over 3,500 MW of renewable energy generation from facilities in the Oklahoma panhandle region to load-serving entities in the southeastern United States via an interconnection with the Tennessee Valley Authority in western Tennessee near Memphis. Pursuant to Section 1222(b), DOE's proposed action is to participate with Clean Line in

executing the Project. DOE has not yet made any final determination with respect to whether the Project satisfies the requirements of Section 1222(b).

The HVDC transmission line would utilize two Alternating Current/Direct Current (AC/DC) converter stations, one at each end of the transmission line. The converter stations are proposed to be located in Texas County, Oklahoma, and Shelby County or Tipton County, Tennessee. Each converter station would be approximately 30 to 50 acres and would be located on private land. Right-of-way easements would be required for the transmission line and would have a typical width of approximately 150 to 200 feet. Tubular or lattice steel structures would be used to support the transmission line. Each structure would have a typical height from 120 to 200 feet, depending on site-specific conditions. Other limited quantities of larger specialty structures may be necessary to address engineering constraints in some locations. Additionally, access roads, improvements to existing roads, new overland access, and new unpaved temporary roads would be required to access the transmission line and related facilities during the construction, operation and maintenance phases. Finally, ancillary facilities such as communication facilities for control and protection would be required.

The Plains & Eastern Project would traverse several hundreds of miles of terrain prior to spanning the Mississippi River. The Plains & Eastern Project would require numerous Federal permits and authorizations. In part because of DOE's involvement, it will also be subject to consultation and environmental review requirements. Given the scope of all these requirements and the number of agencies involved in them, DOE is particularly interested in identifying cooperating agencies early in the NEPA process. DOE requests that each agency that may have a role in the Plains & Eastern Project, required or otherwise, help define the specific requirements which must be met to fulfill that agency's NEPA obligations and participate as a cooperating agency. This is in support of CEQ's guidance to ensure that Federal agencies actively participate as cooperating agencies in other agency's NEPA processes and to avoid duplication and unnecessary delays in the NEPA process. If your agency has multiple offices or regions that may participate as a cooperating agency in the EIS, please identify a lead office or region.

Should your agency agree to be a cooperating agency, DOE will endeavor to ensure that the information and analyses of the EIS would support any agency decision relative to their NEPA obligations. To that end, DOE anticipates that your agency will participate with DOE in:

- Reviewing technical approaches for analyzing impacts;
- Reviewing preliminary versions of the draft and final EIS;
- Representing your agency's interests, if timing allows, at the public scoping meetings; and
- Engaging in activities associated with publication of the draft EIS, such as public hearings.

DOE may request that your agency respond to comments on the Draft EIS in a timely manner relating to subject matter specific to your agency's mission and goals.

DOE looks forward to the participation of your agency as a cooperating agency during the development of the Plains and Eastern EIS. In particular, we encourage input and suggestions from your agency on the scope of the EIS to ensure that all relevant environmental issues are addressed. Should your agency elect not to participate as a cooperating agency, DOE hopes that your agency still participates as a consulting or commenting agency to allow the EIS to benefit from your specific expertise.

Do not hesitate to contact us if you, or your staff, have any questions or concerns. The primary point of contact for this effort is DOE's EIS Deputy Document Manager, Ms. Melissa Ardis. She may be reached at 720-356-1566 or 720-291-1602 or via email at melissa.ardis@go.doe.gov. The Federal Document Manager, Dr. Jane Summerson, may be reached at (505) 845-4091 or via email at jane.summerson@ee.doe.gov.

Sincerely,

A handwritten signature in black ink, appearing to read "Jane K. Summerson". The signature is fluid and cursive, with a long horizontal stroke at the end.

Jane Summerson, Ph.D.
Federal Document Manager
Office of Electricity Delivery and
Energy Reliability



DEPARTMENT OF ENERGY
Washington, DC 20585

OFFICE OF THE SECRETARY

November 6, 2012

U.S. Army Corps of Engineers
Little Rock District
Attn: Sarah Chitwood
PO Box 867
Little Rock, AR 72203

Dear Ms. Chitwood:

SUBJECT: United State Department of Energy Invitation to Participate in the Plains & Eastern Clean Line Project Environmental Impact Statement (DOE/EIS-0486)

Pursuant to the Council on Environmental Quality's regulations (40 CFR 1501.6) that implement the National Environmental Policy Act of 1969 (NEPA) (42 USC 4321-4370(h)) the Department of Energy (DOE) invites the participation of your agency as a cooperating agency in the preparation of an environmental impact statement (EIS) for the Plains & Eastern Clean Line (Plains & Eastern) Project. In the EIS, DOE intends to analyze the potential environmental impacts of a project proposed by Plains & Eastern, to construct an overhead transmission line from western Oklahoma to the Tennessee Valley Authority in the southeastern United States. DOE is planning to publish, in December 2012, a Notice of Intent (NOI) to prepare the EIS. In keeping with the Administration's goal of moving transmission infrastructure projects expeditiously through the permitting and environmental review processes, DOE is requesting that you promptly notify DOE of your interest in participating in the EIS as a cooperating agency.

By way of background, Section 1222 (b) of the Energy Policy Act of 2005, provides that the Secretary of Energy, acting in consultation with the Western Area Power Administration (WAPA) or the Southwestern Power Administration (SWPA), or both, may design, develop, construct, operate, maintain or own, or participate with other entities in designing, developing, constructing, operating or owning, a new electric power transmission facility and related facilities.

In response to DOE's June 10, 2010 Request for Proposals, Clean Line Energy Partners, LLC (Clean Line) applied to the DOE under Section 1222(b) to work with and provide funds to DOE to develop a new +/- 600 kV high voltage direct current (HVDC) electric transmission line capable of transmitting over 3,500 MW of renewable energy generation from facilities in the Oklahoma panhandle region to load-serving entities in the southeastern United States via an interconnection with the Tennessee Valley Authority in western Tennessee near Memphis. Pursuant to Section 1222(b), DOE's proposed action is to participate with Clean Line in

executing the Project. DOE has not yet made any final determination with respect to whether the Project satisfies the requirements of Section 1222(b).

The HVDC transmission line would utilize two Alternating Current/Direct Current (AC/DC) converter stations, one at each end of the transmission line. The converter stations are proposed to be located in Texas County, Oklahoma, and Shelby County or Tipton County, Tennessee. Each converter station would be approximately 30 to 50 acres and would be located on private land. Right-of-way easements would be required for the transmission line and would have a typical width of approximately 150 to 200 feet. Tubular or lattice steel structures would be used to support the transmission line. Each structure would have a typical height from 120 to 200 feet, depending on site-specific conditions. Other limited quantities of larger specialty structures may be necessary to address engineering constraints in some locations. Additionally, access roads, improvements to existing roads, new overland access, and new unpaved temporary roads would be required to access the transmission line and related facilities during the construction, operation and maintenance phases. Finally, ancillary facilities such as communication facilities for control and protection would be required.

The Plains & Eastern Project would traverse several hundreds of miles of terrain prior to spanning the Mississippi River. The Plains & Eastern Project would require numerous Federal permits and authorizations. In part because of DOE's involvement, it will also be subject to consultation and environmental review requirements. Given the scope of all these requirements and the number of agencies involved in them, DOE is particularly interested in identifying cooperating agencies early in the NEPA process. DOE requests that each agency that may have a role in the Plains & Eastern Project, required or otherwise, help define the specific requirements which must be met to fulfill that agency's NEPA obligations and participate as a cooperating agency. This is in support of CEQ's guidance to ensure that Federal agencies actively participate as cooperating agencies in other agency's NEPA processes and to avoid duplication and unnecessary delays in the NEPA process. If your agency has multiple offices or regions that may participate as a cooperating agency in the EIS, please identify a lead office or region.

Should your agency agree to be a cooperating agency, DOE will endeavor to ensure that the information and analyses of the EIS would support any agency decision relative to their NEPA obligations. To that end, DOE anticipates that your agency will participate with DOE in:

- Reviewing technical approaches for analyzing impacts;
- Reviewing preliminary versions of the draft and final EIS;
- Representing your agency's interests, if timing allows, at the public scoping meetings; and
- Engaging in activities associated with publication of the draft EIS, such as public hearings.

DOE may request that your agency respond to comments on the Draft EIS in a timely manner relating to subject matter specific to your agency's mission and goals.

DOE looks forward to the participation of your agency as a cooperating agency during the development of the Plains and Eastern EIS. In particular, we encourage input and suggestions from your agency on the scope of the EIS to ensure that all relevant environmental issues are addressed. Should your agency elect not to participate as a cooperating agency, DOE hopes that your agency still participates as a consulting or commenting agency to allow the EIS to benefit from your specific expertise.

Do not hesitate to contact us if you, or your staff, have any questions or concerns. The primary point of contact for this effort is DOE's EIS Deputy Document Manager, Ms. Melissa Ardis. She may be reached at 720-356-1566 or 720-291-1602 or via email at melissa.ardis@go.doe.gov. The Federal Document Manager, Dr. Jane Summerson, may be reached at (505) 845-4091 or via email at jane.summerson@ee.doe.gov.

Sincerely,

A handwritten signature in cursive script, appearing to read "Jane K. Summerson".

Jane Summerson, Ph.D.
Federal Document Manager
Office of Electricity Delivery and
Energy Reliability



DEPARTMENT OF ENERGY
Washington, DC 20585

OFFICE OF THE SECRETARY

November 6, 2012

U.S. Army Corps of Engineers
Memphis District
Attn: Reggie Wuornos
167 North Main St., B-202
Memphis, TN 38003

Dear Mr. Wuornos:

SUBJECT: United State Department of Energy Invitation to Participate in the Plains & Eastern Clean Line Project Environmental Impact Statement (DOE/EIS-0486)

Pursuant to the Council on Environmental Quality's regulations (40 CFR 1501.6) that implement the National Environmental Policy Act of 1969 (NEPA) (42 USC 4321-4370(h)) the Department of Energy (DOE) invites the participation of your agency as a cooperating agency in the preparation of an environmental impact statement (EIS) for the Plains & Eastern Clean Line (Plains & Eastern) Project. In the EIS, DOE intends to analyze the potential environmental impacts of a project proposed by Plains & Eastern, to construct an overhead transmission line from western Oklahoma to the Tennessee Valley Authority in the southeastern United States. DOE is planning to publish, in December 2012, a Notice of Intent (NOI) to prepare the EIS. In keeping with the Administration's goal of moving transmission infrastructure projects expeditiously through the permitting and environmental review processes, DOE is requesting that you promptly notify DOE of your interest in participating in the EIS as a cooperating agency.

By way of background, Section 1222 (b) of the Energy Policy Act of 2005, provides that the Secretary of Energy, acting in consultation with the Western Area Power Administration (WAPA) or the Southwestern Power Administration (SWPA), or both, may design, develop, construct, operate, maintain or own, or participate with other entities in designing, developing, constructing, operating or owning, a new electric power transmission facility and related facilities.

In response to DOE's June 10, 2010 Request for Proposals, Clean Line Energy Partners, LLC (Clean Line) applied to the DOE under Section 1222(b) to work with and provide funds to DOE to develop a new +/- 600 kV high voltage direct current (HVDC) electric transmission line capable of transmitting over 3,500 MW of renewable energy generation from facilities in the Oklahoma panhandle region to load-serving entities in the southeastern United States via an interconnection with the Tennessee Valley Authority in western Tennessee near Memphis. Pursuant to Section 1222(b), DOE's proposed action is to participate with Clean Line in

executing the Project. DOE has not yet made any final determination with respect to whether the Project satisfies the requirements of Section 1222(b).

The HVDC transmission line would utilize two Alternating Current/Direct Current (AC/DC) converter stations, one at each end of the transmission line. The converter stations are proposed to be located in Texas County, Oklahoma, and Shelby County or Tipton County, Tennessee. Each converter station would be approximately 30 to 50 acres and would be located on private land. Right-of-way easements would be required for the transmission line and would have a typical width of approximately 150 to 200 feet. Tubular or lattice steel structures would be used to support the transmission line. Each structure would have a typical height from 120 to 200 feet, depending on site-specific conditions. Other limited quantities of larger specialty structures may be necessary to address engineering constraints in some locations. Additionally, access roads, improvements to existing roads, new overland access, and new unpaved temporary roads would be required to access the transmission line and related facilities during the construction, operation and maintenance phases. Finally, ancillary facilities such as communication facilities for control and protection would be required.

The Plains & Eastern Project would traverse several hundreds of miles of terrain prior to spanning the Mississippi River. The Plains & Eastern Project would require numerous Federal permits and authorizations. In part because of DOE's involvement, it will also be subject to consultation and environmental review requirements. Given the scope of all these requirements and the number of agencies involved in them, DOE is particularly interested in identifying cooperating agencies early in the NEPA process. DOE requests that each agency that may have a role in the Plains & Eastern Project, required or otherwise, help define the specific requirements which must be met to fulfill that agency's NEPA obligations and participate as a cooperating agency. This is in support of CEQ's guidance to ensure that Federal agencies actively participate as cooperating agencies in other agency's NEPA processes and to avoid duplication and unnecessary delays in the NEPA process. If your agency has multiple offices or regions that may participate as a cooperating agency in the EIS, please identify a lead office or region.

Should your agency agree to be a cooperating agency, DOE will endeavor to ensure that the information and analyses of the EIS would support any agency decision relative to their NEPA obligations. To that end, DOE anticipates that your agency will participate with DOE in:

- Reviewing technical approaches for analyzing impacts;
- Reviewing preliminary versions of the draft and final EIS;
- Representing your agency's interests, if timing allows, at the public scoping meetings; and
- Engaging in activities associated with publication of the draft EIS, such as public hearings.

DOE may request that your agency respond to comments on the Draft EIS in a timely manner relating to subject matter specific to your agency's mission and goals.

DOE looks forward to the participation of your agency as a cooperating agency during the development of the Plains and Eastern EIS. In particular, we encourage input and suggestions from your agency on the scope of the EIS to ensure that all relevant environmental issues are addressed. Should your agency elect not to participate as a cooperating agency, DOE hopes that your agency still participates as a consulting or commenting agency to allow the EIS to benefit from your specific expertise.

Do not hesitate to contact us if you, or your staff, have any questions or concerns. The primary point of contact for this effort is DOE's EIS Deputy Document Manager, Ms. Melissa Ardis. She may be reached at 720-356-1566 or 720-291-1602 or via email at melissa.ardis@go.doe.gov. The Federal Document Manager, Dr. Jane Summerson, may be reached at (505) 845-4091 or via email at jane.summerson@ee.doe.gov.

Sincerely,

A handwritten signature in cursive script, appearing to read "Jane K. Summerson".

Jane Summerson, Ph.D.
Federal Document Manager
Office of Electricity Delivery and
Energy Reliability



DEPARTMENT OF ENERGY
Washington, DC 20585

OFFICE OF THE SECRETARY

November 6, 2012

U.S. Army Corps of Engineers
Tulsa District
Attn: Charles Schrodtt
Operations Division
102 E BK 20C Rd
Stiglor, OK 74462

Dear Mr. Schrodtt:

SUBJECT: United State Department of Energy Invitation to Participate in the Plains & Eastern Clean Line Project Environmental Impact Statement (DOE/EIS-0486)

Pursuant to the Council on Environmental Quality's regulations (40 CFR 1501.6) that implement the National Environmental Policy Act of 1969 (NEPA) (42 USC 4321-4370(h)) the Department of Energy (DOE) invites the participation of your agency as a cooperating agency in the preparation of an environmental impact statement (EIS) for the Plains & Eastern Clean Line (Plains & Eastern) Project. In the EIS, DOE intends to analyze the potential environmental impacts of a project proposed by Plains & Eastern, to construct an overhead transmission line from western Oklahoma to the Tennessee Valley Authority in the southeastern United States. DOE is planning to publish, in December 2012, a Notice of Intent (NOI) to prepare the EIS. In keeping with the Administration's goal of moving transmission infrastructure projects expeditiously through the permitting and environmental review processes, DOE is requesting that you promptly notify DOE of your interest in participating in the EIS as a cooperating agency.

By way of background, Section 1222 (b) of the Energy Policy Act of 2005, provides that the Secretary of Energy, acting in consultation with the Western Area Power Administration (WAPA) or the Southwestern Power Administration (SWPA), or both, may design, develop, construct, operate, maintain or own, or participate with other entities in designing, developing, constructing, operating or owning, a new electric power transmission facility and related facilities.

In response to DOE's June 10, 2010 Request for Proposals, Clean Line Energy Partners, LLC (Clean Line) applied to the DOE under Section 1222(b) to work with and provide funds to DOE to develop a new +/- 600 kV high voltage direct current (HVDC) electric transmission line capable of transmitting over 3,500 MW of renewable energy generation from facilities in the Oklahoma panhandle region to load-serving entities in the southeastern United States via an interconnection with the Tennessee Valley Authority in western Tennessee near Memphis.

Pursuant to Section 1222(b), DOE's proposed action is to participate with Clean Line in executing the Project. DOE has not yet made any final determination with respect to whether the Project satisfies the requirements of Section 1222(b).

The HVDC transmission line would utilize two Alternating Current/Direct Current (AC/DC) converter stations, one at each end of the transmission line. The converter stations are proposed to be located in Texas County, Oklahoma, and Shelby County or Tipton County, Tennessee. Each converter station would be approximately 30 to 50 acres and would be located on private land. Right-of-way easements would be required for the transmission line and would have a typical width of approximately 150 to 200 feet. Tubular or lattice steel structures would be used to support the transmission line. Each structure would have a typical height from 120 to 200 feet, depending on site-specific conditions. Other limited quantities of larger specialty structures may be necessary to address engineering constraints in some locations. Additionally, access roads, improvements to existing roads, new overland access, and new unpaved temporary roads would be required to access the transmission line and related facilities during the construction, operation and maintenance phases. Finally, ancillary facilities such as communication facilities for control and protection would be required.

The Plains & Eastern Project would traverse several hundreds of miles of terrain prior to spanning the Mississippi River. The Plains & Eastern Project would require numerous Federal permits and authorizations. In part because of DOE's involvement, it will also be subject to consultation and environmental review requirements. Given the scope of all these requirements and the number of agencies involved in them, DOE is particularly interested in identifying cooperating agencies early in the NEPA process. DOE requests that each agency that may have a role in the Plains & Eastern Project, required or otherwise, help define the specific requirements which must be met to fulfill that agency's NEPA obligations and participate as a cooperating agency. This is in support of CEQ's guidance to ensure that Federal agencies actively participate as cooperating agencies in other agency's NEPA processes and to avoid duplication and unnecessary delays in the NEPA process. If your agency has multiple offices or regions that may participate as a cooperating agency in the EIS, please identify a lead office or region.

Should your agency agree to be a cooperating agency, DOE will endeavor to ensure that the information and analyses of the EIS would support any agency decision relative to their NEPA obligations. To that end, DOE anticipates that your agency will participate with DOE in:

- Reviewing technical approaches for analyzing impacts;
- Reviewing preliminary versions of the draft and final EIS;
- Representing your agency's interests, if timing allows, at the public scoping meetings; and
- Engaging in activities associated with publication of the draft EIS, such as public hearings.

DOE may request that your agency respond to comments on the Draft EIS in a timely manner relating to subject matter specific to your agency's mission and goals.

DOE looks forward to the participation of your agency as a cooperating agency during the development of the Plains and Eastern EIS. In particular, we encourage input and suggestions from your agency on the scope of the EIS to ensure that all relevant environmental issues are addressed. Should your agency elect not to participate as a cooperating agency, DOE hopes that your agency still participates as a consulting or commenting agency to allow the EIS to benefit from your specific expertise.

Do not hesitate to contact us if you, or your staff, have any questions or concerns. The primary point of contact for this effort is DOE's EIS Deputy Document Manager, Ms. Melissa Ardis. She may be reached at 720-356-1566 or 720-291-1602 or via email at melissa.ardis@go.doe.gov. The Federal Document Manager, Dr. Jane Summerson, may be reached at (505) 845-4091 or via email at jane.summerson@ee.doe.gov.

Sincerely,

A handwritten signature in cursive script that reads "Jane K. Summerson". The signature is written in black ink and is positioned below the word "Sincerely,".

Jane Summerson, Ph.D.
Federal Document Manager
Office of Electricity Delivery and
Energy Reliability



Department of Energy
Washington, DC 20585

October 31, 2013

United States Department of Agriculture
Forest Service, Ozark St. Francis National Forest
Attn: Reggie L. Blackwell, Acting Forest Supervisor
605 W. Main St.
Russellville, AR 72801-3614

RE: United State Department of Energy Invitation to Participate in the Plains & Eastern Clean Line Project Environmental Impact Statement (DOE/EIS-0486)

Dear Mr. Blackwell:

Pursuant to the Council on Environmental Quality's regulations (40 CFR 1501.6) that implement the National Environmental Policy Act of 1969 (NEPA) (42 USC 4321-4370(h)) and in response to your letter dated September 30, 2013, the Department of Energy (DOE) invites the participation of the U.S. Department of Agriculture, Forest Service (Forest Service) as a cooperating agency in the preparation of the environmental impact statement (EIS) for the Plains & Eastern Clean Line (Plains & Eastern) Project. In the EIS, DOE intends to analyze the potential environmental impacts of a project proposed by Plains & Eastern, to construct an overhead transmission line from western Oklahoma to the Tennessee Valley Authority in the southeastern United States. DOE published a Notice of Intent (NOI) to prepare the EIS on December 21, 2012.

By way of background, Section 1222 (b) of the Energy Policy Act of 2005, provides that the Secretary of Energy, acting in consultation with the Western Area Power Administration (WAPA) or the Southwestern Power Administration (SWPA), or both, may design, develop, construct, operate, maintain or own, or participate with other entities in designing, developing, constructing, operating or owning, a new electric power transmission facility and related facilities.

In response to DOE's June 10, 2010 Request for Proposals, Clean Line Energy Partners, LLC (Clean Line) applied to the DOE under Section 1222(b) to work with and provide funds to DOE to develop a new +/- 600 kV high voltage direct current (HVDC) electric transmission line capable of transmitting over 3,500 MW of renewable energy generation from facilities in the Oklahoma panhandle region to load-serving entities in the southeastern United States via an interconnection with the Tennessee Valley Authority in western Tennessee near Memphis. Pursuant to Section 1222(b), DOE's proposed action is to participate with Clean Line in executing the Project. DOE has not yet made any final determination with respect to whether the Project satisfies the requirements of Section 1222(b).

In the initial proposal, the HVDC transmission line would have utilized two Alternating Current/Direct Current (AC/DC) converter stations, one at each end of the transmission line. The converter stations are proposed to be located in Texas County, Oklahoma, and Shelby County or Tipton County, Tennessee. In

response to scoping comments, DOE is also analyzing the alternative of a proposed third converter station in Pope County, Arkansas. Each converter station would be approximately 30 to 50 acres and would be located on private land. Right-of-way easements would be required for the transmission line and would have a typical width of approximately 150 to 200 feet. Tubular or lattice steel structures would be used to support the transmission line. Each structure would have a typical height from 120 to 200 feet, depending on site-specific conditions. Other limited quantities of larger specialty structures may be necessary to address engineering constraints in some locations. Additionally, access roads, improvements to existing roads, new overland access, and new unpaved temporary roads would be required to access the transmission line and related facilities during the construction, operation and maintenance phases. Finally, ancillary facilities such as communication facilities for control and protection would be required.

The Plains & Eastern Project would traverse several hundreds of miles of terrain prior to spanning the Mississippi River. The Plains & Eastern Project would require numerous Federal permits and authorizations. Because of DOE's involvement, it is subject to consultation and environmental review requirements. The Notice of Intent was issued in December 2012 and DOE has been involved in the NEPA process since that date. As noted in your letter, the alternative route that would cross the Ozark-St. Francis National Forests was not part of the original "Network of Potential Routes." This route may be added as a potential alternative in direct response to many scoping comments that requested a route through the National Forest be analyzed in the EIS.

In order to inform the environmental review process, DOE requests that you help define the specific requirements which must be met to fulfill your agency's NEPA obligations and participate as a cooperating agency. This is in support of CEQ's guidance to ensure that Federal agencies actively participate as cooperating agencies in other agency's NEPA processes and to avoid duplication and unnecessary delays in the NEPA process.

DOE will endeavor to ensure that the information and analyses in the EIS would support any agency decision relative to your NEPA obligations. To that end, DOE anticipates that your agency will participate with DOE in:

- Reviewing technical approaches for analyzing impacts;
- Reviewing preliminary versions of the draft and final EIS; and
- Engaging in activities associated with publication of the draft EIS, such as public hearings.

DOE may request that your agency respond to comments on the Draft EIS in a timely manner relating to subject matter specific to your agency's mission and goals. Specifically, in the event that an alternative is considered in the EIS that involves the Ozark-St. Francis National Forest, please describe the decision(s) that will be required by the Forest Service (for example, these decisions may include changes to the forest management plan or require a special use permit).

DOE looks forward to the participation of your agency as a cooperating agency during the development of the Plains and Eastern EIS. In particular, we encourage input and suggestions from your agency on the scope of the EIS to ensure that all relevant environmental issues are addressed.

Do not hesitate to contact us if you, or your staff, have any questions or concerns. The primary point of contact for this effort is DOE's EIS Deputy Document Manager, Ms. Melissa Ardis. She may be reached at 720-356-1566 or 720-291-1602 or via email at melissa.ardis@go.doe.gov. The Federal Document Manager, Dr. Jane Summerson, may be reached at (505) 845-4091 or via email at jane.summerson01@nnsa.doe.gov.

Sincerely,

A handwritten signature in black ink that reads "Jane K. Summerson". The signature is written in a cursive style with a long horizontal flourish at the end.

Jane Summerson, Ph.D.
Federal Document Manager
Office of Electricity Delivery and Energy Reliability

cc: Terry Krasko

Joanne Stover

From: Farmer, Constance <Connie.Farmer@tetrattech.com>
Sent: Tuesday, February 10, 2015 11:45 AM
To: Michael_Taylor@nps.gov
Cc: Summerson, Jane (Jane.Summerson01@nnsa.doe.gov); MacDonald, John; Chavez, Allie; 'jstover@jwdrivers.com' (jstover@jwdrivers.com)
Subject: Plains & Eastern Clean Line Transmission Line Project

Mr. Taylor:

I am writing on behalf of Jane Summerson, DOE Document Manager and Section 106 lead for the Plains & Eastern Clean Line Transmission Project. Jane has asked me to reach out to you regarding the Trail of Tears as it relates to this proposed project. We are in the process of developing the Cultural Resources Identification Plan for spring 2015 surveys. If there is information that would be useful in developing this plan, I would appreciate it if you would provide that to me and cc Jane.

Jane is on the road for the next couple of weeks conducting public hearings on the draft EIS all along the proposed route. If you think a conference call would be helpful, she suggests that we wait until the public hearings are complete. She could also meet with you in Santa Fe when she returns to Albuquerque from the meetings. In the meantime, I am available if needed. Any information or insight you can provide to DOE would be greatly appreciated.

Regards,

Connie Farmer | Senior Environmental Program Manager
Direct: 303.980.3653 | Fax: 303.980.3539 | Cell: 303.918.2501
connie.farmer@tetrattech.com

Tetra Tech, Inc. |
350 Indiana Street, Suite 500 | Golden, CO 80401 | www.tetrattech.com

PLEASE NOTE: This message, including any attachments, may include confidential and/or inside information. Any distribution or use of this communication by anyone other than the intended recipient is strictly prohibited and may be unlawful. If you are not the intended recipient, please notify the sender by replying to this message and then delete it from your system.



Department of Energy

Golden Field Office
1617 Cole Boulevard
Golden, Colorado 80401-3393

November 6, 2012

U.S. Fish and Wildlife Service
Arkansas Ecological Services Field Office
Attn: Lindsey Lewis
110 S. Amity Rd Suite 300
Conway, AR 72032

Dear Ms. Lewis:

SUBJECT: United State Department of Energy Invitation to Participate in the Plains & Eastern Clean Line Project Environmental Impact Statement (DOE/EIS-0486)

Pursuant to the Council on Environmental Quality's regulations (40 CFR 1501.6) that implement the National Environmental Policy Act of 1969 (NEPA) (42 USC 4321-4370(h)) the Department of Energy (DOE) invites the participation of your agency as a cooperating agency in the preparation of an environmental impact statement (EIS) for the Plains & Eastern Clean Line (Plains & Eastern) Project. In the EIS, DOE intends to analyze the potential environmental impacts of a project proposed by Plains & Eastern, to construct an overhead transmission line from western Oklahoma to the Tennessee Valley Authority in the southeastern United States. DOE is planning to publish, in December 2012, a Notice of Intent (NOI) to prepare the EIS. In keeping with the Administration's goal of moving transmission infrastructure projects expeditiously through the permitting and environmental review processes, DOE is requesting that you promptly notify DOE of your interest in participating in the EIS as a cooperating agency.

By way of background, Section 1222 (b) of the Energy Policy Act of 2005, provides that the Secretary of Energy, acting in consultation with the Western Area Power Administration (WAPA) or the Southwestern Power Administration (SWPA), or both, may design, develop, construct, operate, maintain or own, or participate with other entities in designing, developing, constructing, operating or owning, a new electric power transmission facility and related facilities.

In response to DOE's June 10, 2010 Request for Proposals, Clean Line Energy Partners, LLC (Clean Line) applied to the DOE under Section 1222(b) to work with and provide funds to DOE to develop a new +/- 600 kV high voltage direct current (HVDC) electric transmission line capable of transmitting over 3,500 MW of renewable energy generation from facilities in the Oklahoma panhandle region to load-serving entities in the southeastern United States via an interconnection with the Tennessee Valley Authority in western Tennessee near Memphis. Pursuant to Section 1222(b), DOE's proposed action is to participate with Clean Line in



executing the Project. DOE has not yet made any final determination with respect to whether the Project satisfies the requirements of Section 1222(b).

The HVDC transmission line would utilize two Alternating Current/Direct Current (AC/DC) converter stations, one at each end of the transmission line. The converter stations are proposed to be located in Texas County, Oklahoma, and Shelby County or Tipton County, Tennessee. Each converter station would be approximately 30 to 50 acres and would be located on private land. Right-of-way easements would be required for the transmission line and would have a typical width of approximately 150 to 200 feet. Tubular or lattice steel structures would be used to support the transmission line. Each structure would have a typical height from 120 to 200 feet, depending on site-specific conditions. Other limited quantities of larger specialty structures may be necessary to address engineering constraints in some locations. Additionally, access roads, improvements to existing roads, new overland access, and new unpaved temporary roads would be required to access the transmission line and related facilities during the construction, operation and maintenance phases. Finally, ancillary facilities such as communication facilities for control and protection would be required.

The Plains & Eastern Project would traverse several hundreds of miles of terrain prior to spanning the Mississippi River. The Plains & Eastern Project would require numerous Federal permits and authorizations. In part because of DOE's involvement, it will also be subject to consultation and environmental review requirements. Given the scope of all these requirements and the number of agencies involved in them, DOE is particularly interested in identifying cooperating agencies early in the NEPA process. DOE requests that each agency that may have a role in the Plains & Eastern Project, required or otherwise, help define the specific requirements which must be met to fulfill that agency's NEPA obligations and participate as a cooperating agency. This is in support of CEQ's guidance to ensure that Federal agencies actively participate as cooperating agencies in other agency's NEPA processes and to avoid duplication and unnecessary delays in the NEPA process. If your agency has multiple offices or regions that may participate as a cooperating agency in the EIS, please identify a lead office or region.

Should your agency agree to be a cooperating agency, DOE will endeavor to ensure that the information and analyses of the EIS would support any agency decision relative to their NEPA obligations. To that end, DOE anticipates that your agency will participate with DOE in:

- Reviewing technical approaches for analyzing impacts;
- Reviewing preliminary versions of the draft and final EIS;
- Representing your agency's interests, if timing allows, at the public scoping meetings; and
- Engaging in activities associated with publication of the draft EIS, such as public hearings.

DOE may request that your agency respond to comments on the Draft EIS in a timely manner relating to subject matter specific to your agency's mission and goals.

DOE looks forward to the participation of your agency as a cooperating agency during the development of the Plains and Eastern EIS. In particular, we encourage input and suggestions from your agency on the scope of the EIS to ensure that all relevant environmental issues are addressed. Should your agency elect not to participate as a cooperating agency, DOE hopes that your agency still participates as a consulting or commenting agency to allow the EIS to benefit from your specific expertise.

Do not hesitate to contact us if you, or your staff, have any questions or concerns. The primary point of contact for this effort is DOE's EIS Deputy Document Manager, Ms. Melissa Ardis. She may be reached at 720-356-1566 or 720-291-1602 or via email at melissa.ardis@go.doe.gov. The Federal Document Manager, Dr. Jane Summerson, may be reached at (505) 845-4091 or via email at jane.summerson@ee.doe.gov.

Sincerely,

A handwritten signature in cursive script that reads "Jane K. Summerson".

Jane Summerson, Ph.D.
Federal Document Manager
Office of Electricity Delivery and
Energy Reliability



DEPARTMENT OF ENERGY
Washington, DC 20585

OFFICE OF THE SECRETARY

November 6, 2012

U.S. Fish and Wildlife Service
Central Arkansas National Wildlife Refuge
(Central AR NWR) Complex
Attn: Keith M. Weaver
26320 Hwy 33 South
Augusta, AR 72006

Dear Mr. Weaver:

SUBJECT: United State Department of Energy Invitation to Participate in the Plains & Eastern Clean Line Project Environmental Impact Statement (DOE/EIS-0486)

Pursuant to the Council on Environmental Quality's regulations (40 CFR 1501.6) that implement the National Environmental Policy Act of 1969 (NEPA) (42 USC 4321-4370(h)) the Department of Energy (DOE) invites the participation of your agency as a cooperating agency in the preparation of an environmental impact statement (EIS) for the Plains & Eastern Clean Line (Plains & Eastern) Project. In the EIS, DOE intends to analyze the potential environmental impacts of a project proposed by Plains & Eastern, to construct an overhead transmission line from western Oklahoma to the Tennessee Valley Authority in the southeastern United States. DOE is planning to publish, in December 2012, a Notice of Intent (NOI) to prepare the EIS. In keeping with the Administration's goal of moving transmission infrastructure projects expeditiously through the permitting and environmental review processes, DOE is requesting that you promptly notify DOE of your interest in participating in the EIS as a cooperating agency.

By way of background, Section 1222 (b) of the Energy Policy Act of 2005, provides that the Secretary of Energy, acting in consultation with the Western Area Power Administration (WAPA) or the Southwestern Power Administration (SWPA), or both, may design, develop, construct, operate, maintain or own, or participate with other entities in designing, developing, constructing, operating or owning, a new electric power transmission facility and related facilities.

In response to DOE's June 10, 2010 Request for Proposals, Clean Line Energy Partners, LLC (Clean Line) applied to the DOE under Section 1222(b) to work with and provide funds to DOE to develop a new +/- 600 kV high voltage direct current (HVDC) electric transmission line capable of transmitting over 3,500 MW of renewable energy generation from facilities in the Oklahoma panhandle region to load-serving entities in the southeastern United States via an interconnection with the Tennessee Valley Authority in western Tennessee near Memphis. Pursuant to Section 1222(b), DOE's proposed action is to participate with Clean Line in

executing the Project. DOE has not yet made any final determination with respect to whether the Project satisfies the requirements of Section 1222(b).

The HVDC transmission line would utilize two Alternating Current/Direct Current (AC/DC) converter stations, one at each end of the transmission line. The converter stations are proposed to be located in Texas County, Oklahoma, and Shelby County or Tipton County, Tennessee. Each converter station would be approximately 30 to 50 acres and would be located on private land. Right-of-way easements would be required for the transmission line and would have a typical width of approximately 150 to 200 feet. Tubular or lattice steel structures would be used to support the transmission line. Each structure would have a typical height from 120 to 200 feet, depending on site-specific conditions. Other limited quantities of larger specialty structures may be necessary to address engineering constraints in some locations. Additionally, access roads, improvements to existing roads, new overland access, and new unpaved temporary roads would be required to access the transmission line and related facilities during the construction, operation and maintenance phases. Finally, ancillary facilities such as communication facilities for control and protection would be required.

The Plains & Eastern Project would traverse several hundreds of miles of terrain prior to spanning the Mississippi River. The Plains & Eastern Project would require numerous Federal permits and authorizations. In part because of DOE's involvement, it will also be subject to consultation and environmental review requirements. Given the scope of all these requirements and the number of agencies involved in them, DOE is particularly interested in identifying cooperating agencies early in the NEPA process. DOE requests that each agency that may have a role in the Plains & Eastern Project, required or otherwise, help define the specific requirements which must be met to fulfill that agency's NEPA obligations and participate as a cooperating agency. This is in support of CEQ's guidance to ensure that Federal agencies actively participate as cooperating agencies in other agency's NEPA processes and to avoid duplication and unnecessary delays in the NEPA process. If your agency has multiple offices or regions that may participate as a cooperating agency in the EIS, please identify a lead office or region.

Should your agency agree to be a cooperating agency, DOE will endeavor to ensure that the information and analyses of the EIS would support any agency decision relative to their NEPA obligations. To that end, DOE anticipates that your agency will participate with DOE in:

- Reviewing technical approaches for analyzing impacts;
- Reviewing preliminary versions of the draft and final EIS;
- Representing your agency's interests, if timing allows, at the public scoping meetings; and
- Engaging in activities associated with publication of the draft EIS, such as public hearings.

DOE may request that your agency respond to comments on the Draft EIS in a timely manner relating to subject matter specific to your agency's mission and goals.

DOE looks forward to the participation of your agency as a cooperating agency during the development of the Plains and Eastern EIS. In particular, we encourage input and suggestions from your agency on the scope of the EIS to ensure that all relevant environmental issues are addressed. Should your agency elect not to participate as a cooperating agency, DOE hopes that your agency still participates as a consulting or commenting agency to allow the EIS to benefit from your specific expertise.

Do not hesitate to contact us if you, or your staff, have any questions or concerns. The primary point of contact for this effort is DOE's EIS Deputy Document Manager, Ms. Melissa Ardis. She may be reached at 720-356-1566 or 720-291-1602 or via email at melissa.ardis@go.doe.gov. The Federal Document Manager, Dr. Jane Summerson, may be reached at (505) 845-4091 or via email at jane.summerson@ee.doe.gov.

Sincerely,

A handwritten signature in black ink, appearing to read "Jane K. Summerson". The signature is fluid and cursive, with a long horizontal flourish at the end.

Jane Summerson, Ph.D.
Federal Document Manager
Office of Electricity Delivery and
Energy Reliability



Department of Energy

Washington, DC 20585

November 6, 2012

U.S. Fish and Wildlife Service (USFWS)
Oklahoma Ecological Services Field Office
Attn: Angela Burgess
9014 E 21st St
Tulsa, OK 74070

Dear Ms. Burgess:

SUBJECT: United State Department of Energy Invitation to Participate in the Plains & Eastern Clean Line Project Environmental Impact Statement (DOE/EIS-0486)

Pursuant to the Council on Environmental Quality's regulations (40 CFR 1501.6) that implement the National Environmental Policy Act of 1969(NEPA) (42 USC 4321-4370(h)) the Department of Energy (DOE) invites the participation of your agency as a cooperating agency in the preparation of an environmental impact statement (EIS) for the Plains & Eastern Clean Line (Plains & Eastern) Project. In the EIS, DOE intends to analyze the potential environmental impacts of a project proposed by Plains & Eastern, to construct an overhead transmission line from western Oklahoma to the Tennessee Valley Authority in the southeastern United States. DOE is planning to publish, in December 2012, a Notice of Intent (NOI) to prepare the EIS. In keeping with the Administration's goal of moving transmission infrastructure projects expeditiously through the permitting and environmental review processes, DOE is requesting that you promptly notify DOE of your interest in participating in the EIS as a cooperating agency.

By way of background, Section 1222 (b) of the Energy Policy Act of 2005, provides that the Secretary of Energy, acting in consultation with the Western Area Power Administration (WAPA) or the Southwestern Power Administration (SWPA), or both, may design, develop, construct, operate, maintain or own, or participate with other entities in designing, developing, constructing, operating or owning, a new electric power transmission facility and related facilities.

In response to DOE's June 10, 2010 Request for Proposals, Clean Line Energy Partners, LLC (Clean Line) applied to the DOE under Section 1222(b) to work with and provide funds to DOE to develop a new +/- 600 kV high voltage direct current (HVDC) electric transmission line capable of transmitting over 3,500 MW of renewable energy generation from facilities in the Oklahoma panhandle region to load-serving entities in the southeastern United States via an interconnection with the Tennessee Valley Authority in western Tennessee near Memphis. Pursuant to Section 1222(b), DOE's proposed action is to participate with Clean Line in



executing the Project. DOE has not yet made any final determination with respect to whether the Project satisfies the requirements of Section 1222(b).

The HVDC transmission line would utilize two Alternating Current/Direct Current (AC/DC) converter stations, one at each end of the transmission line. The converter stations are proposed to be located in Texas County, Oklahoma, and Shelby County or Tipton County, Tennessee. Each converter station would be approximately 30 to 50 acres and would be located on private land. Right-of-way easements would be required for the transmission line and would have a typical width of approximately 150 to 200 feet. Tubular or lattice steel structures would be used to support the transmission line. Each structure would have a typical height from 120 to 200 feet, depending on site-specific conditions. Other limited quantities of larger specialty structures may be necessary to address engineering constraints in some locations. Additionally, access roads, improvements to existing roads, new overland access, and new unpaved temporary roads would be required to access the transmission line and related facilities during the construction, operation and maintenance phases. Finally, ancillary facilities such as communication facilities for control and protection would be required.

The Plains & Eastern Project would traverse several hundreds of miles of terrain prior to spanning the Mississippi River. The Plains & Eastern Project would require numerous Federal permits and authorizations. In part because of DOE's involvement, it will also be subject to consultation and environmental review requirements. Given the scope of all these requirements and the number of agencies involved in them, DOE is particularly interested in identifying cooperating agencies early in the NEPA process. DOE requests that each agency that may have a role in the Plains & Eastern Project, required or otherwise, help define the specific requirements which must be met to fulfill that agency's NEPA obligations and participate as a cooperating agency. This is in support of CEQ's guidance to ensure that Federal agencies actively participate as cooperating agencies in other agency's NEPA processes and to avoid duplication and unnecessary delays in the NEPA process. If your agency has multiple offices or regions that may participate as a cooperating agency in the EIS, please identify a lead office or region.

Should your agency agree to be a cooperating agency, DOE will endeavor to ensure that the information and analyses of the EIS would support any agency decision relative to their NEPA obligations. To that end, DOE anticipates that your agency will participate with DOE in:

- Reviewing technical approaches for analyzing impacts;
- Reviewing preliminary versions of the draft and final EIS;
- Representing your agency's interests, if timing allows, at the public scoping meetings; and
- Engaging in activities associated with publication of the draft EIS, such as public hearings.

DOE may request that your agency respond to comments on the Draft EIS in a timely manner relating to subject matter specific to your agency's mission and goals.

DOE looks forward to the participation of your agency as a cooperating agency during the development of the Plains and Eastern EIS. In particular, we encourage input and suggestions from your agency on the scope of the EIS to ensure that all relevant environmental issues are addressed. Should your agency elect not to participate as a cooperating agency, DOE hopes that your agency still participates as a consulting or commenting agency to allow the EIS to benefit from your specific expertise.

Do not hesitate to contact us if you, or your staff, have any questions or concerns. The primary point of contact for this effort is DOE's EIS Deputy Document Manager, Ms. Melissa Ardis. She may be reached at 720-356-1566 or 720-291-1602 or via email at melissa.ardis@go.doe.gov. The Federal Document Manager, Dr. Jane Summerson, may be reached at (505) 845-4091 or via email at jane.summerson@ee.doe.gov.

Sincerely,

A handwritten signature in cursive script, appearing to read "Jane K. Summerson".

Jane Summerson, Ph.D.
Federal Document Manager
Office of Electricity Delivery and
Energy Reliability



Department of Energy
Washington, DC 20585

January 17, 2013

Chris Tanner
SCEP Fish & Wildlife Biologist
U.S. Fish and Wildlife Services
Oklahoma Ecological Services Field Office
9014 E. 21st Street
Tulsa, OK 74129

RE: Designation of Clean Line Energy Partners, LLC as a Non-Federal Representative

Dear Mr. Tanner:

In a letter of November 29, 2012, Clean Line Energy Partners LLC (Clean Line) asked the Department of Energy (DOE) to designate Clean Line as the non-Federal representative for the purpose of consultation with the U.S. Fish & Wildlife Service pursuant to section 7(a)(2) of the Endangered Species Act (ESA) for the Plains & Eastern Clean Line Project. The role of the non-Federal representative includes conducting studies, developing and supplying information, attending meetings, ensuring that pertinent endangered and threatened species information is maintained in a project file, developing a draft biological assessment, participating in informal consultation with the Service, and keeping DOE apprised of its actions.

By this letter, DOE designates Clean Line as DOE's non-Federal representative for the ESA consultation with your agency on the Plains & Eastern Clean Line Project. The Clean Line representative for this consultation process will be Jason Thomas. He can be reached at 832-319-6357 or 713-805-6840 or via email at jthomas@cleanlineenergy.com.

As DOE retains ultimate responsibility for compliance with section 7 consultation requirements, please insure that all ESA Section 7 communications from FWS regarding the Plains & Eastern Project are provided to both Clean Line and DOE. The primary DOE contact is the EIS Deputy Document Manager, Ms. Melissa Ardis. She may be reached at 720-356-1566 or 720-291-1602 or via email at melissa.ardis@go.doe.gov.

Sincerely,

A handwritten signature in cursive script, appearing to read "Jane K. Summerson". The signature is written in dark ink and is positioned below the word "Sincerely,".

Jane Summerson, Ph.D.
NEPA Document Manager
Office of Energy Efficiency and Renewable Energy
cc: Jason Thomas, Clean Line Energy Partners, LLC



Department of Energy

Washington, DC 20585

November 6, 2012

U.S. Fish and Wildlife Service
Tennessee Ecological Services (Cookeville) Field Office
Attn: Robbie Sykes
446 Neal St.
Cookeville, TN 38501

Dear Mr. Sykes:

SUBJECT: United State Department of Energy Invitation to Participate in the Plains & Eastern Clean Line Project Environmental Impact Statement (DOE/EIS-0486)

Pursuant to the Council on Environmental Quality's regulations (40 CFR 1501.6) that implement the National Environmental Policy Act of 1969 (NEPA) (42 USC 4321-4370(h)) the Department of Energy (DOE) invites the participation of your agency as a cooperating agency in the preparation of an environmental impact statement (EIS) for the Plains & Eastern Clean Line (Plains & Eastern) Project. In the EIS, DOE intends to analyze the potential environmental impacts of a project proposed by Plains & Eastern, to construct an overhead transmission line from western Oklahoma to the Tennessee Valley Authority in the southeastern United States. DOE is planning to publish, in December 2012, a Notice of Intent (NOI) to prepare the EIS. In keeping with the Administration's goal of moving transmission infrastructure projects expeditiously through the permitting and environmental review processes, DOE is requesting that you promptly notify DOE of your interest in participating in the EIS as a cooperating agency.

By way of background, Section 1222 (b) of the Energy Policy Act of 2005, provides that the Secretary of Energy, acting in consultation with the Western Area Power Administration (WAPA) or the Southwestern Power Administration (SWPA), or both, may design, develop, construct, operate, maintain or own, or participate with other entities in designing, developing, constructing, operating or owning, a new electric power transmission facility and related facilities.

In response to DOE's June 10, 2010 Request for Proposals, Clean Line Energy Partners, LLC (Clean Line) applied to the DOE under Section 1222(b) to work with and provide funds to DOE to develop a new +/- 600 kV high voltage direct current (HVDC) electric transmission line capable of transmitting over 3,500 MW of renewable energy generation from facilities in the Oklahoma panhandle region to load-serving entities in the southeastern United States via an interconnection with the Tennessee Valley Authority in western Tennessee near Memphis. Pursuant to Section 1222(b), DOE's proposed action is to participate with Clean Line in



executing the Project. DOE has not yet made any final determination with respect to whether the Project satisfies the requirements of Section 1222(b).

The HVDC transmission line would utilize two Alternating Current/Direct Current (AC/DC) converter stations, one at each end of the transmission line. The converter stations are proposed to be located in Texas County, Oklahoma, and Shelby County or Tipton County, Tennessee. Each converter station would be approximately 30 to 50 acres and would be located on private land. Right-of-way easements would be required for the transmission line and would have a typical width of approximately 150 to 200 feet. Tubular or lattice steel structures would be used to support the transmission line. Each structure would have a typical height from 120 to 200 feet, depending on site-specific conditions. Other limited quantities of larger specialty structures may be necessary to address engineering constraints in some locations. Additionally, access roads, improvements to existing roads, new overland access, and new unpaved temporary roads would be required to access the transmission line and related facilities during the construction, operation and maintenance phases. Finally, ancillary facilities such as communication facilities for control and protection would be required.

The Plains & Eastern Project would traverse several hundreds of miles of terrain prior to spanning the Mississippi River. The Plains & Eastern Project would require numerous Federal permits and authorizations. In part because of DOE's involvement, it will also be subject to consultation and environmental review requirements. Given the scope of all these requirements and the number of agencies involved in them, DOE is particularly interested in identifying cooperating agencies early in the NEPA process. DOE requests that each agency that may have a role in the Plains & Eastern Project, required or otherwise, help define the specific requirements which must be met to fulfill that agency's NEPA obligations and participate as a cooperating agency. This is in support of CEQ's guidance to ensure that Federal agencies actively participate as cooperating agencies in other agency's NEPA processes and to avoid duplication and unnecessary delays in the NEPA process. If your agency has multiple offices or regions that may participate as a cooperating agency in the EIS, please identify a lead office or region.

Should your agency agree to be a cooperating agency, DOE will endeavor to ensure that the information and analyses of the EIS would support any agency decision relative to their NEPA obligations. To that end, DOE anticipates that your agency will participate with DOE in:

- Reviewing technical approaches for analyzing impacts;
- Reviewing preliminary versions of the draft and final EIS;
- Representing your agency's interests, if timing allows, at the public scoping meetings; and
- Engaging in activities associated with publication of the draft EIS, such as public hearings.

DOE may request that your agency respond to comments on the Draft EIS in a timely manner relating to subject matter specific to your agency's mission and goals.

DOE looks forward to the participation of your agency as a cooperating agency during the development of the Plains and Eastern EIS. In particular, we encourage input and suggestions from your agency on the scope of the EIS to ensure that all relevant environmental issues are addressed. Should your agency elect not to participate as a cooperating agency, DOE hopes that your agency still participates as a consulting or commenting agency to allow the EIS to benefit from your specific expertise.

Do not hesitate to contact us if you, or your staff, have any questions or concerns. The primary point of contact for this effort is DOE's EIS Deputy Document Manager, Ms. Melissa Ardis. She may be reached at 720-356-1566 or 720-291-1602 or via email at melissa.ardis@go.doe.gov. The Federal Document Manager, Dr. Jane Summerson, may be reached at (505) 845-4091 or via email at jane.summerson@ee.doe.gov.

Sincerely,

A handwritten signature in black ink, appearing to read "Jane K. Summerson". The signature is fluid and cursive, with a long horizontal stroke at the end.

Jane Summerson, Ph.D.
Federal Document Manager
Office of Electricity Delivery and
Energy Reliability

LETTERS FROM FEDERAL AGENCIES

APPENDIX B
PRIMARY CORRESPONDENCE BETWEEN DOE AND FEDERAL AGENCIES

This page intentionally left blank.

Milford Wayne Donaldson, FAIA
Chairman

Clement A. Price, Ph.D.
Vice Chairman

John M. Fowler
Executive Director



Preserving America's Heritage

February 12, 2014

The Honorable Ernest J. Moniz
Secretary
Department of Energy
Forrestal Building
1000 Independence Ave, SW
Room 7A-257
Washington, DC 20585-1000

Ref: *Proposed Plains and Eastern Clean Line Transmission Project
Oklahoma, Arkansas and Tennessee*

Dear Secretary Moniz:

In response to a notification by the Department of Energy, the Advisory Council on Historic Preservation (ACHP) will participate in consultation to develop a Programmatic Agreement for the proposed Plains and Eastern Clean Line Transmission Project in Oklahoma, Arkansas and Tennessee. Our decision to participate in this consultation is based on the *Criteria for Council Involvement in Reviewing Individual Section 106 Cases*, contained within our regulations. The criteria are met for this proposed undertaking because the undertaking has the potential to have substantial impacts on historic properties and may present procedural questions.

Section 800.6(a)(1)(iii) of our regulations requires that we notify you, as the head of the agency, of our decision to participate in consultation. By copy of this letter, we are also notifying Ms. Melissa Ardis, Environmental Protection Specialist, of this decision.

Our participation in this consultation will be handled by Ms. Jaime Loichinger, who can be reached at (202) 606-8529 or via e-mail at jloichinger@achp.gov. We look forward to working with your agency and other consulting parties to consider alternatives to this undertaking that could avoid, minimize, or mitigate potential adverse effects on historic properties and to reach a Programmatic Agreement.

Sincerely,

John M. Fowler
Executive Director

ADVISORY COUNCIL ON HISTORIC PRESERVATION

1100 Pennsylvania Avenue NW, Suite 803 • Washington, DC 20004
Phone: 202-606-8503 • Fax: 202-606-8647 • achp@achp.gov • www.achp.gov



Preserving America's Heritage

February 19, 2014

Ms. Melissa Ardis
Environmental Protection Specialist
U.S. Department of Energy
Golden Field Office
1617 Cole Boulevard
Golden, CO 80401-3393

Ref: *Proposed Plains and Eastern Clean Line Transmission Project
Oklahoma, Arkansas and Tennessee*

Dear Ms. Ardis:

On February 12, 2014, the Advisory Council on Historic Preservation (ACHP) notified the U.S. Department of Energy (DOE) that it would participate in consultation to develop a Programmatic Agreement (PA) for the referenced undertaking due to the undertaking's potential to substantially impact historic properties and the potential for procedural questions. As we understand, DOE proposes to use the substitution process in our regulations, "Protection of Historic Properties" (36 CFR Part 800) to meet its obligations under both the National Historic Preservation Act (NHPA) and the National Environmental Policy Act (NEPA). We welcome the opportunity to consult with DOE and other consulting parties to adhere to 36 CFR 800.8(c) of our regulations.

As we initiate the consultation process, it would be helpful if DOE would consider the following questions to augment the background information you have already submitted.

- What is the proposed schedule and major milestones for this undertaking? Given the project's large geographic area, how will DOE engage diverse consulting parties? Do you intend to convene meetings in different States and regional areas? Does DOE have a proposed meeting schedule at this juncture?
- What are the roles of the various cooperating agencies that DOE identified in its background information? Has DOE been formally identified as the lead agency for Section 106? If so, by what agencies?
- How will this project be coordinated with related state environmental reviews? Has DOE outlined steps it will take to coordinate the review processes?
- What comments have stakeholders submitted to DOE regarding the project's potential to affect historic properties?
- Who has requested consulting party status for this undertaking pursuant to Section 800.3(f)?

ADVISORY COUNCIL ON HISTORIC PRESERVATION

1100 Pennsylvania Avenue NW, Suite 803 • Washington, DC 20004
Phone: 202-606-8503 • Fax: 202-606-8647 • achp@achp.gov • www.achp.gov

We would appreciate receiving this information so that the consultation process can continue moving forward. If you have any questions about our comments, please contact Ms. Jaime Loichinger at (202) 606-8529 or via email at jloichinger@achp.gov. Thank you for your cooperation in this matter.

Sincerely,

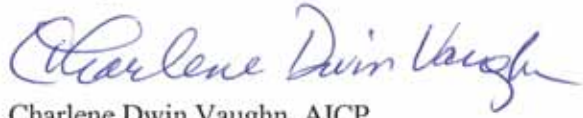
A handwritten signature in blue ink that reads "Charlene Dwin Vaughn". The signature is fluid and cursive, with the first name "Charlene" being the most prominent.

Charlene Dwin Vaughn, AICP
Assistant Director
Office of Federal Agency Programs
Federal Permitting, Licensing and Assistance Section



Preserving America's Heritage

September 18, 2014

Ms. Jane Summerson
NEPA Document Manager
U.S. Department of Energy
1000 Independence Ave, SW
Washington, DC 20585

Ref: *Proposed Plains and Eastern Clean Line Transmission Project
States of Texas, Oklahoma, Arkansas, and Tennessee*

Dear Ms. Summerson:

On September 4, 2014, the Advisory Council on Historic Preservation (ACHP) participated via teleconference in a consulting parties meeting for the referenced undertaking. As you know, the ACHP is participating in consultation with the Department of Energy (DOE) to develop a programmatic agreement (PA) which will include phased identification and evaluation of historic properties along the transmission line's route.

The draft PA that was discussed during the recent meeting is a good start. However, we suggest that DOE consider developing a consultation schedule aligned with the planning schedule that will allow the consulting parties to regularly meet to discuss the preamble and stipulations individually or in small groups, rather than addressing the document as a whole during a day-long meeting. If we were limited to one meeting to consult about the drafting of this PA, it could be overwhelming as well as time-consuming for consulting parties. On the contrary, a regularly scheduled meeting would provide consistency and transparency in this process, and allow consulting parties to adequately prepare for future meetings. DOE may also benefit from focused comments from the larger group depending on the status of the PA negotiations. Finally, the consultation schedule will allow DOE to address concerns raised by consulting parties who find that the significant time lapses in between DOE correspondence and consultation meetings interferes with the continuing of the Section 106 review.

We have also taken the opportunity to provide substantive comments on the draft PA (please see enclosed). We raised a number of questions and made several comments that will have to be addressed before we are in a position to provide further input. We are particularly curious about whether DOE has consulted with the Council on Environmental Quality (CEQ) about the feasibility of using a Programmatic Environmental Impact Statement (PEIS) for this action, since related activities or funding sources have yet to be identified. We are also interested in whether a tiered PEIS is being developed in which this PA can be utilized to comply with the National Environmental Policy Act (NEPA) and Section 106.

ADVISORY COUNCIL ON HISTORIC PRESERVATION

401 F Street NW, Suite 308 • Washington, DC 20001-2637
Phone: 202-517-0200 • Fax: 202-517-6381 • achp@achp.gov • www.achp.gov

Thank you for the opportunity to provide follow-up comments to our meeting, and we look forward to working with DOE in drafting an appropriate PA. If you have any questions, please contact Ms. Jaime Loichinger at (202) 517-0219 or via email at jloichinger@achp.gov.

Sincerely,

for 

Charlene Dwin Vaughn, AICP
Assistant Director
Office of Federal Agency Programs
Federal Permitting, Licensing and Assistance Section

Enclosure



Preserving America's Heritage

January 27, 2015

Ms. Jane Summerson
NEPA Document Manager
U.S. Department of Energy
1000 Independence Ave, SW
Washington, DC 20585

Ref: *Proposed Plains and Eastern Clean Line Transmission Project
States of Texas, Oklahoma, Arkansas, and Tennessee*

Dear Ms. Summerson:

The Advisory Council on Historic Preservation (ACHP) recently participated in a consultation meeting in Norman, Oklahoma, for the referenced undertaking. As you know, the ACHP is participating in this consultation with the DOE to develop a draft Programmatic Agreement (PA) for phased identification and evaluation of historic properties along the transmission line's route.

We appreciate DOE's efforts to facilitate a meaningful Section 106 consultation process. The meeting provided an opportunity for consulting parties to discuss the draft PA in detail, and to discuss next steps. Based on the conversations during the meeting, it appears that the most appropriate next step is for DOE to merge its draft PA with the version presented by the Osage Nation. The Osage Nation's PA included all of the stipulations that should be included in a final PA in a clear, concise manner.

In addition to merging the two PAs, we also request that DOE consider the following general comments prepared by the ACHP.

- The confidentiality stipulation of the draft PA needs additional work although it was not discussed during the meeting. We suggest a follow-up consultation call to discuss how to revise this stipulation.
- The stipulation for identification and evaluation of historic properties should be preceded by a section defining the Area of Potential Effects (APE) for both direct and indirect effects.
- The inclusion of a communication plan with timeframes and commenting procedures should be included in the relevant stipulations or clarified as a distinct stipulation in the PA.
- The Tribal Monitoring stipulation is very detailed. It would be helpful to understand whether or not the project proponent, Clean Line, can implement this approach. Further, DOE should consider whether this approach is adequate for consulting tribes.
- When does DOE envision its involvement in the implementation of the PA to be complete? Will operation and maintenance of the transmission be considered part of this undertaking?
- An annual reporting stipulation should be included in the reporting section so that the consulting parties are regularly made aware of the PA's implementation and construction status.

ADVISORY COUNCIL ON HISTORIC PRESERVATION

401 F Street NW, Suite 308 • Washington, DC 20001-2637
Phone: 202-517-0200 • Fax: 202-517-6381 • achp@achp.gov • www.achp.gov

- The PA's duration should be long enough to cover all aspects of the undertaking. It was determined during the meeting that seven years would be an appropriate length of time. This revision that was endorsed by consulting parties should be included.
- A withdrawal stipulation, as included in the draft DOE PA, should also be included in the revised PA. This specific provision would be helpful for a project of this scope and size.

During the meeting, the tribes asked that the ACHP provide a formal advisory opinion on the signatory and invited signatory status of tribes. We are reviewing this matter further, and will send a letter to DOE and consulting parties soon.

We look forward to continuing our work with DOE in drafting an appropriate PA. If you have any questions, please contact Ms. Jaime Loichinger at (202) 517-0219 or via email at jloichinger@achp.gov.

Sincerely,

A handwritten signature in cursive script that reads "Charlene Dwin Vaughn".

Charlene Dwin Vaughn, AICP
Assistant Director
Office of Federal Agency Programs
Federal Permitting, Licensing and Assistance Section

Joanne Stover

From: Jaime Loichinger <jloichinger@achp.gov>
Sent: Tuesday, April 07, 2015 1:58 PM
To: Farmer, Constance; Jane.Summerson01@nnsa.doe.gov; David.Conrad@Hq.Doe.Gov; chris.turner@swpa.gov; cpnicholson@tva.gov; Cynthia.W.Blansett@usace.army.mil; robert.a.dunn@usace.army.mil; Timothy.Hartsfield@USACE.Army.Mil; david.anderson@bia.gov; vanessa_burge@fws.gov; tkrasko@fs.fed.us; Michael_taylor@nps.gov; steven.elsener@ok.usda.gov; J. Eric Gilliland; Melvena Thurman Heisch; Joe Garrison; Mark Wolfe; Joseph Blanchard; Bill John Baker; Robert Cast; timothy.baugh@chickasaw.net; Ian Thompson; rfields@iowanation.org; kbellmard@bellmardlaw.com; Espain@mcn-nsn.gov; Andrea Hunter; Everett Bandy; Sandra Massey; Colemanhascoleman75@yahoo.com; Lisa Baker; gary.mcadams@wichitatribe.com; JThomas@cleanlineenergy.com; cemcrew@mcn-nsn.gov; delb@mcn-nsn.gov; jeremy.rogers@swpa.gov; ian.richardson@swpa.gov; kim.jackson@swpa.gov; marlina.delisa@swpa.gov; mike.love@swpa.gov; angela.mcphee@swpa.gov; misti.pilcher@swpa.gov; sierra.mandelko@bia.gov; jonna.polk@bia.gov; aemasters@tva.gov; bdtill@tva.gov; Patricia Bernard Ezzell; gerald.l.treadwell@usace.army.mil; Jimmy.d.mcneil@mvm02.usace.army.mil; kim.d.hewitt@usace.army.mil; michael.p.bauman@usace.army.mil; Michelle.C.Horn@usace.army.mil; reginald.c.wuornos@usace.army.mil; christine_willis@fws.gov; darrin_unruh@fws.gov; keith_weaver@fws.gov; ken_collins@fws.gov; kenneth_mcdonald@fws.gov; richard_stark@fws.gov; Thomas_inebnit@fws.gov; weeks.craig@epa.gov; Jansky.michael@epa.gov; smith.rhonda@epa.gov; Frances McSwain; lane@arkansasheritage.org; martha@arkansasheritage.org; lozan@okhistory.org; cwood@okhistory.org; Robert Brooks; Tiffany Osburn; joel-bean@cherokee.org; tom-elkins@cherokee.org; Amber Hood; lbilyeu@choctawnation.com; broush@iowanation.org; dmoss@mcn-nsn.gov; Davidp@MCN-NSN.gov; delb@mcn-nsn.gov; elagrone@mcn-nsn.gov; gperez@mcn-nsn.gov; jwilliams@mcn-nsn.gov; jfife@mcn-nsn.gov; Johnnie Jacobs; jausmus@mcn-nsn.gov; ofreeman@mcn-nsn.gov; sjmcintosh@mcn-nsn.gov; cemcrew@mcn-nsn.gov; tthompson@mcn.nsn.gov; bwellborn@sbcglobal.net; tgoodvoice@unitedkeetoowahband.org; sphillips@swca.com; kmiller@swca.com; charles.tippeconnic@wichitatribe.com; rwiley@mcnag.com; kdellinger@mcnag.com; jack-baker@cherokee.org
Cc: MacDonald, John; Phippen, Stephanie; Chavez, Allie; 'jstover@jwdrivers.com' (jstover@jwdrivers.com)
Subject: #006511 - Plains & Eastern Clean Line Transmission Line Project - ACHP Correspondence
Attachments: tx-ok-ar-tn.doe.plains & eastern clean line transmission.con.07apr15.pdf

Dear consulting parties:

During January's consultation meeting, the Advisory Council on Historic Preservation (ACHP) was asked to clarify our regulations regarding invited signatories and signatories for agreement documents executed pursuant to Section 106 of the National Historic Preservation Act (NHPA). Please see the attached letter that was sent to the Department of Energy today.

If you have any questions, please call or email me.

Sincerely,

Jaime Loichinger

Advisory Council on Historic Preservation

(202) 517-0219

jloichinger@achp.gov

New ACHP **Guidance on Agreement Documents** now available at:

<http://www.achp.gov/agreementdocguidance.html>



Preserving America's Heritage

April 7, 2015

Ms. Jane Summerson
NEPA Document Manager
U.S. Department of Energy
1000 Independence Ave, SW
Washington, DC 20585

Ref: *Proposed Plains and Eastern Clean Line Transmission Project
States of Texas, Oklahoma, Arkansas, and Tennessee*

Dear Ms. Summerson:

During the January consultation meeting for the referenced undertaking, several representatives of Indian tribes asked the ACHP to clarify whether tribes should be “signatories” or “invited signatories” to the Programmatic Agreement (PA) currently being developed in accordance with Section 106 of the National Historic Preservation Act (NHPA) [54 U.S.C. § 306108] and its implementing regulations, “Protection of Historic Properties” (36 CFR Part 800). The ACHP would like to provide this guidance to the U.S. Department of Energy (DOE) to move the consultation process forward.

The PA for this undertaking is being developed in accordance with 36 CFR § 800.14(b)(3), as a complex undertaking. That section of the regulations specifically states that “[c]onsultation to develop a programmatic agreement for dealing with the potential adverse effects of complex projects or multiple undertakings shall follow § 800.6.” Accordingly, the provisions of Section 800.6, including those regarding how agreements are executed, and what parties are “signatories,” “invited signatories,” and “concurring parties,” govern this PA.

As specified in 36 CFR § 800.6(c)(1-2), “signatories” have the sole authority to execute, amend or terminate an agreement document. “Invited signatories” who sign an agreement have the same rights to amendment or termination as “signatories,” but their signature is not needed to execute the agreement.

The “signatories” for an agreement like this PA, when the ACHP is participating, are “the agency official, the SHPO/THPO, and the Council.” 36 CFR § 800.6(c)(1)(ii). The term “SHPO/THPO” relates to the state and/or tribal preservation officer identified by the agency official per 36 CFR § 800.3(c). A “THPO” is so identified when “the undertaking may occur on or affect historic properties on any tribal lands.” When the undertaking will not take place on tribal land, or affect a historic property on tribal land, the term “SHPO/THPO” only means the State Historic Preservation Officer.

ADVISORY COUNCIL ON HISTORIC PRESERVATION

401 F Street NW, Suite 308 • Washington, DC 20001-2637
Phone: 202-517-0200 • Fax: 202-517-6381 • achp@achp.gov • www.achp.gov

If such an undertaking may still affect historic properties of significance to tribes, but located off tribal lands, any tribe that ascribes cultural or religious significance to these historic properties are consulting parties by right, but are not required signatories as referenced by the term "SHPO/THPO." The federal agency, at its discretion, may choose to invite those tribes to be an "invited signatory," but their signature on a complex undertaking PA in this circumstance is not required for its execution. 36 CFR § 800.6(c)(2)(ii).

Based on the current undertaking's route, DOE believes the undertaking will not occur on tribal lands or affect historic properties on tribal lands. Accordingly, consulting tribes would be recognized as "invited signatories" should the DOE extend such an invitation to those tribes. When this was discussed during the consultation meeting, some tribal representatives indicated this distinction between "signatory" and "invited signatory" status diminished their rights in the Section 106 process. We acknowledge this concern and note that the Section 106 regulations recognize tribal sovereignty on tribal lands and reflect the scope of tribal involvement necessary depending on the project's location.

At this time, unless DOE determines that the undertaking will occur on tribal lands, or affect historic properties on tribal lands, as defined by 36 CFR § 800.16(x), tribes would not be "signatories" to the PA. Their signatures on the PA would not be required for the PA to be fully executed. Should the undertaking be found to occur, or affect historic properties, on a tribe's land, then that tribe would be a "signatory" to the PA. Currently, DOE has invited the consulting tribes to be "invited signatories" pursuant to 36 CFR Part 800.6(c)(2)(ii), recognizing that historic properties of religious and cultural significance off tribal lands may be affected by the proposed undertaking. We strongly encourage DOE to consult with the Bureau of Indian Affairs to identify tribal lands, if any, that may be affected by this undertaking. As appropriate, the ACHP is available to discuss with DOE how the PA can best reflect the special expertise tribes have in identifying tribal historic properties.

We look forward to continuing our work with DOE and the consulting parties in drafting an appropriate PA. If you have any questions, please contact Ms. Jaime Loichinger at (202) 517-0219 or via email at jloichinger@achp.gov.

Sincerely,



Charlene Dwin Vaughn, AICP
Assistant Director
Office of Federal Agency Programs
Federal Permitting, Licensing and Assistance Section



Preserving America's Heritage

April 20, 2015

Ms. Jane Summerson
NEPA Document Manager
U.S. Department of Energy
1000 Independence Ave, SW
Washington, DC 20585

Ref: *Proposed Plains and Eastern Clean Line Transmission Project
States of Texas, Oklahoma, Arkansas, and Tennessee*

Dear Ms. Summerson:

On March 26, 2015, the Advisory Council on Historic Preservation (ACHP) received a request from the U.S. Department of Energy (DOE) to provide comments on a draft PA for the referenced undertaking. We understand that the draft PA has been revised following comments received during our last consultation meeting in January.

Overall, the PA is improved and addresses many of the concerns heard during our last consultation meeting. DOE will need to ensure consistency in the use of acronyms, such as State Historic Preservation Officers (SHPOs, rather than Historical Commissions). Each stipulation should also have an alphanumeric identifier. Cross-references to other stipulations should be checked to ensure accuracy. Further, the National Historic Preservation Act (NHPA) was moved in the U.S. Code, and references to it in the PA's whereas clauses should have its new statutory reference (54 U.S.C. §306108).

Specific comments on the draft PA include the following:

- 5th whereas clause: this should read "...makes the project an undertaking subject to Section 106...", not "triggers review."
- 11th whereas clause: this should be separated to show how SHPOs, tribes and Tribal Historic Preservation Officers (THPOs), local governments and the public were all consulted in the PA's development
- 25th and 26th whereas clauses: suggest merging these and include reference to 36 CFR Part 800.4(b)(3)
- 27th whereas clause: this is unnecessary and can be removed
- 28th whereas clause: could DOE clarify the 1222(b) decision making process?
- Preamble to the Stipulations: The preamble should read, "DOE, in coordination with SWPA and other coordinating agencies, will ensure that the following measures are implemented." DOE should clarify that the definitions contained in 36 CFR Part 800.16 apply to the PA's terms in Stipulation II (Standards and Permits).

ADVISORY COUNCIL ON HISTORIC PRESERVATION

401 F Street NW, Suite 308 • Washington, DC 20001-2637
Phone: 202-517-0200 • Fax: 202-517-6381 • achp@achp.gov • www.achp.gov

- Stipulation I (Roles/Responsibilities): rather than listing each party individually, this stipulation could include lead agency, consulting agencies, the ACHP, SHPOs, tribes/THPOs, and other consulting parties. Further, it should summarize the major responsibilities of each party.
- Stipulation III (Confidentiality): the “need to know” approach can be difficult to enforce; the ACHP would like to offer its assistance in crafting a more appropriate stipulation following a consultation meeting to discuss this topic.
- Stipulation IV (Area of Potential Effect): disputes regarding modifications to the Area of Potential Effect should utilize the dispute resolution stipulation.
- Stipulation V (Phased Process to Address Historic Properties): some information seems as if it would be contained within the Identification Plan; the treatment of historic properties is not addressed beyond monitoring (stipulation V.B). The process should also note that disputes regarding National Register eligibility will be resolved by the Keeper of the National Register.
- Plan and Report Commenting Procedures: this needs an alphanumeric identifier. The stipulation references the “HPTP”, which was not previously defined and should reference the confidentiality stipulation, not Section 304 of the NHPA.
- Stipulation VI (Unanticipated Discoveries): Does this stipulation also apply to unanticipated effects to known historic properties? “EI” has not been previously defined. What is an “exclusion zone?”
- Stipulation VII (Human Remains): DOE needs to ensure that the language for state/private lands is consistent for each of the four states. This stipulation could also reference ACHP’s *Policy Statement on Human Remains*.
- Stipulation X (Operations and Maintenance): DOE needs to determine the scope of its undertaking. Will it include operations and maintenance? This is likely not an undertaking under DOE’s purview in perpetuity.
- Stipulation XII (Dispute Resolution): the stipulation name should be kept as dispute, not conflict. Stipulation XII.G should be moved to the reporting stipulation.
- Stipulation XIII (Duration): a concrete date should be used, not “completion of activities,” to ensure clarity.
- Stipulation XV (Withdrawal and Termination): If a SHPO withdraws, ACHP should be notified and we will determine if we will act on their behalf. Prior to the reference of 36 CFR Part 800.7, it should be clear that DOE will respond to the ACHP’s comments regarding the basis of termination.
- Stipulation XIX (Execution): The first sentence should read, “This PA shall be effective on the date of the last signatory” to ensure consistency with the ACHP’s *Guidance on Agreement Documents*.

We understand that the comment period for the project’s Draft Environmental Impact Statement (DEIS) will be ending soon. Has DOE developed a schedule for consultation while it is addressing the DEIS’s comments? If so, it would be helpful to know the dates for upcoming meetings to ensure the participation of all consulting parties.

We look forward to continuing to work with DOE and the consulting parties. If you have any questions about our comments, please contact Ms. Jaime Loichinger at (202) 517-0219 or via email at jloichinger@achp.gov.

Sincerely,



for Charlene Dwin Vaughn, AICP
 Assistant Director
 Office of Federal Agency Programs
 Federal Permitting, Licensing and Assistance Section

Joanne Stover

From: Jaime Loichinger <jloichinger@achp.gov>
Sent: Wednesday, April 29, 2015 8:19 AM
To: Summerson, Jane; Farmer, Constance
Subject: Confidentiality stip

Hi Jane and Connie –

Here are two stipulations that were used in previous PAs that were useful; I think they might be helpful here as well. Take a look and let me know what you think!

Thanks,
jaime

Protection of confidential information

Confidentiality. Because the federal agency and the signatories agree that it is important to withhold from disclosure sensitive information such as that which is protected by NHPA Section 304 (16 U.S.C. §470w-3) (e.g., the location, character, and ownership of an historic resource, if disclosure would cause a significant invasion of privacy, risk harm to the historic resources, or impede the use of a traditional religious site by practitioners), the federal agency shall:

1. Request that each signatory inform the other signatories if, by law or policy, it is unable to withhold sensitive data from public release.
2. Arrange for the signatories to consult as needed on how to protect such information collected or generated under this Agreement.
3. Follow, as appropriate, 36 CFR §800.11(c) for authorization to withhold information pursuant to NHPA Section 304, and otherwise withhold sensitive information to the extent allowable by laws including the Freedom of Information Act, 5 U.S.C. §552, through the Department of the Interior regulations at 43 CFR Part 2.
4. Request that the signatories agree that materials generated during consultation be treated by the signatories as internal and pre-decisional until they are formally released, although the signatories understand that they may need to be released by one of the signatories if required by law.

Withholding of sensitive information

The PA's signatories and concurring parties agree to maintain the confidentiality of all archaeological site and reburial site locations and other information pertaining to historic properties where possible, but limited to the boundaries of applicable law. Because this information and documentation was generated by the federal agency, the permission of that agency is required for any dissemination by any signatory or concurring party to this PA. Should a conflict arise, or a party be unable to maintain confidentially, the federal agency shall contact the National Park Service and institute the provisions set forth at Section 304 of the NHPA (16 U.S.C. 4702-3) and Section 800.11(c) of the ACHP's Section 106 regulations.



Preserving America's Heritage

June 22, 2015

Ms. Jane Summerson
NEPA Document Manager
U.S. Department of Energy
1000 Independence Ave, SW
Washington, DC 20585

Ref: *Proposed Plains and Eastern Clean Line Transmission Project
States of Texas, Oklahoma, Arkansas, and Tennessee*

Dear Ms. Summerson:

On May 7, 2015, the Advisory Council on Historic Preservation (ACHP) received a request from the U.S. Department of Energy (DOE) to provide comments on a draft PA for the referenced undertaking. We understand that the draft PA has been revised following our comments sent in April.

Overall, the PA is much improved and addresses many of the earlier concerns raised by the ACHP and the consulting parties. DOE will need to continue to ensure consistency in the use of acronyms and cross-references to other stipulations. We remind DOE that the National Historic Preservation Act (NHPA) was moved in the U.S. Code, and references to it in the PA's whereas clauses should have its new statutory reference (54 U.S.C. §306108).

In addition, we have specific questions regarding the draft PA which will need to be addressed as you finalize the document. These include the following:

1. In Stipulation II.A, is the expectation that tribes also meet these professional standards? If not, that should be clearly stated within the stipulation.
2. While a number of federal agencies are involved in this undertaking, should the PA include a stipulation that allows other federal agencies to sign onto the PA in the future, should they have a connected action to the undertaking?
3. We understand that DOE has been responding to comments received on the project's Draft Environmental Impact Statement (EIS). Has DOE developed a schedule for continuing consultation as the Final EIS is being developed? It is important for all consulting parties to understand DOE's proposed schedule for completion. Please provide this information as soon as it is available.

We look forward to continuing to work with DOE and the consulting parties. If you have any questions about our comments, please contact Ms. Jaime Loichinger at (202) 517-0219 or via email at jloichinger@achp.gov.

Sincerely,

A handwritten signature in cursive script that reads "Charlene Dwin Vaughn". The signature is written in black ink and is positioned above the printed name.

Charlene Dwin Vaughn, AICP
Assistant Director
Office of Federal Agency Programs
Federal Permitting, Licensing and Assistance Section



UNITED STATES ENVIRONMENTAL PROTECTION AGENCY

REGION 6

1445 ROSS AVENUE, SUITE 1200

DALLAS, TX 75202-2733

December 19, 2012

Jane Summerson, Ph.D.
Federal Document Manager
Office of Electricity Delivery
and Energy Reliability
U.S. Department of Energy
Washington, DC 20585

RE: DOE/EIS-0486

Dear Dr. Summerson:

This is in response to the U.S. Department of Energy's (DOE) invitation to the U.S. Environmental Protection Agency (EPA), Regions 4 and 6, to become a cooperating agency for the development of a National Environmental Policy Act (NEPA) Environmental Impact Statement (EIS) for the proposed Plains & Eastern Clean Line Project located in the states of Oklahoma and Tennessee. The EIS will analyze the impacts of the proposed project to the human and natural environment.

The EPA offers to participate in this proposed project as a cooperating agency. As a cooperating agency, the EPA will:

- provide expertise on NEPA compliance and other subject matter such as wetlands, water quality, air quality, and environmental justice, during EIS planning and development;
- provide timely technical reviews and comments on preliminary documents, reports, analyses, and sections of the Draft and Final EIS;
- participate in meetings and provide information as requested by DOE, as resources allow;
- provide sources for information or support in the analysis of such information, when known, during preparation of the Draft and Final EIS in areas in which EPA has expertise;
- review and comment on the Draft and Final EIS pursuant to our regulatory responsibilities under Section 309 of the Clean Air Act.

Re: EPA as Cooperating Agency for the
Proposed Plains & Eastern Clean Line Project

The EPA anticipates that a cooperative team approach will streamline the environmental process and result in a high quality EIS. We look forward to continued involvement and cooperation in the EIS development for the Plains & Eastern Clean Line Project. If you have any further questions, please contact Michael Jansky, our primary agency representative for this project, at (214) 665-7491 or jansky.michael@epa.gov.

Sincerely,

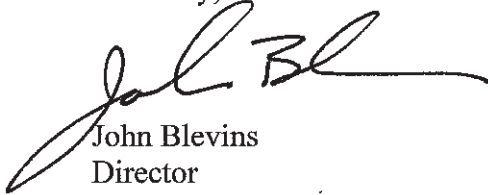
A handwritten signature in black ink, appearing to read "John Blevins". The signature is stylized with a large, sweeping initial "J" and a long horizontal line extending to the right.

John Blevins
Director
Compliance Assurance and
Enforcement Division

cc: Ramona K. McConney
U.S. EPA, Region 4



Natural Resources Conservation Service
Room 3416, Federal Building
700 West Capitol Avenue
Little Rock, Arkansas 72201-3215

Ms. Melissa Ardis
Environmental Impact Statement
Deputy Document Manager
Department of Energy
1000 Independence Avenue, SW
Washington, D.C. 20585

Ms. Ardis,

Thank you for your letter dated November 6, 2012, inviting Natural Resources Conservation Services' (NRCS) participation as a cooperating agency in the preparation of an environmental impact statement (EIS) for the Plains & Eastern Clean Line Project. Arkansas NRCS agrees to cooperate on the assessment of agricultural land affected by the project. NRCS developed the Agricultural Land Evaluation and Site Assessment (LESA) system to meet the requirements of the Farmland Protection Policy Act. LESA determines the quality of land for agricultural uses and assesses sites or land areas for their agricultural economic viability.

LESA evaluation is based on maps with 1: 24,000 scales. To expedite your request in Arkansas, please send us the proposed project information on electronic file (shape file) or 7.5 minutes topographic hard copies.

Should you have any questions or need additional information, please call Nelson A. Rolong, Assistant State Soil Scientist, at (501) 301-3172 or email at nelson.rolong@ar.usda.gov.

Sincerely,

A handwritten signature in black ink, appearing to read "Luis Hernández".

LUIS HERNÁNDEZ
State Soil Scientist

cc:

Michael E. Sullivan, State Conservationist, Natural Resources Conservation Service,
Room 3416, Federal Building, 700 West Capitol, Little Rock, Arkansas 72201
Nelson A. Rolong, Assistant State Soil Scientist, Natural Resources Conservation Service,
Room 3416, Federal Building, 700 West Capitol, Little Rock, Arkansas 72201



File Code: 1950

Date: September 30, 2013

Melissa Ardis
Department of Energy
1099 18th Street
Suite 580
Denver, CO 80202

Dear Ms. Ardis,

Thank you for sending scoping and route information through your contractor Tetra Tech. This letter is in response to the Plains and Eastern alternative route that would cross Ozark-St. Francis National Forests on the Lee Creek Unit. We noted that the proposed route did not come close to the National Forest in your original proposal. Since you are considering an alternate route across the Forest, it may be appropriate for the Forest Service to be a cooperator on this Environmental Impact Statement (EIS).

One of the obvious considerations for crossing National Forest lands is the fact that you have listed compatible uses for power line right-of-way (ROW), and forested condition is not one of them. It appears that other routes do not contain the percentage of forested land as the proposed National Forest route. Other concerns with the National Forest route include rough mountain terrain that may be more susceptible to erosion and more problematic and costly to maintain. Construction and maintaining these "rougher" routes could become a safety concern for workers having to work in these conditions.

One challenge the National Forest faces is illegal off-highway vehicle (OHV) use. Power lines are often used by OHV enthusiasts even though this is not authorized. Power line ROW not only serve as illegal OHV trails but they compound the problem by serving as access arteries for other illegal routes that spur off the ROW. Other resource concerns include impacts to a municipal water supply that is fed by Lee Creek, potential archeological impacts, and impacts to visual quality on the National Forest. Endangered species to evaluate include Ozark big-eared bat and Indiana bat. As you narrow down your proposed route location, we can help you analyze potential impacts and help identify any avoidance needed to protect archeological sites and endangered species as well as try to mitigate Scenery Integrity Objectives.



By adding a National Forest route after scoping is completed, you may have missed legitimate comments that should be considered. We can supply you a mail list of individuals and organizations that may have input about the route across Ozark-St. Francis National Forests. For more information, contact Terry Krasko, Planning and Public Services Staff Officer, tkrasko@fs.fed.us, or call 479-964-7234.

Sincerely,

A handwritten signature in blue ink that reads "Reggie L. Blackwell". The signature is written in a cursive style with a large, stylized "R" and "B".

REGGIE L. BLACKWELL
Acting Forest Supervisor

cc: Terry Krasko, Steve Duzan, William Dunk



RECEIVED APR 24 2015
UNITED STATES ENVIRONMENTAL PROTECTION AGENCY
Region 6
1445 Ross Avenue, Suite 1200
Dallas, TX 75202-2733

April 15, 2015

Dr. Jane Summerson
NEPA Document Manager
Plains and Eastern EIS
216 16th Street, Suite 1500
Denver, Colorado 80202

Dear Dr. Summerson:

In accordance with our responsibilities under Section 309 of the Clean Air Act (CAA), the National Environmental Policy Act (NEPA), and the Council on Environmental Quality (CEQ) regulations for implementing NEPA, the U.S. Environmental Protection Agency (EPA) Region 6 office in Dallas, Texas, has completed its review of the Draft Environmental Impact Statement (DEIS) prepared by the Department of Energy (DOE) for the Plains and Eastern Clean Line Transmission Line Project.

The Draft EIS analyzes potential environmental impacts of a No Action Alternative and several alternatives to the Applicant Proposed Project, including alternative routes for the HVDC transmission line and adding a converter station in Arkansas. The Applicant's Proposed Project would include an overhead 600-kilovolt (kV) high voltage direct current (HVDC) electric transmission system and associated facilities with the capacity to deliver approximately 3,500 megawatts primarily from renewable energy generation facilities in the Oklahoma and Texas Panhandle regions to the Mid-South and Southeast United States via an interconnection with the Tennessee Valley Authority in Tennessee.

EPA has rated the DEIS as **LO "Lack of Objections"**. The EPA's Rating System Criteria can be found here: <http://www.epa.gov/oecaerth/nepa/comments/ratings.html>. We have also enclosed detailed comments for your consideration which we believe will strengthen the Final EIS.

EPA appreciates the opportunity to review the DEIS. Our classification will be published on the EPA website, <http://www.epa.gov/compliance/nepa/eisdata.html>, according to our responsibility under Section 309 of the CAA to inform the public of our views on the proposed Federal action. Please send our office one copy of the Final EIS (FEIS). If you have any questions or concerns, please contact Michael Jansky of my staff at jansky.michael@epa.gov or 214-665-7451 for assistance.

Sincerely,

A handwritten signature in black ink that reads "Marie Stucky".

Marie Stucky, Acting Chief
Office of Planning and Coordination
Office of Strategic Planning and Analyses

Enclosure:

**DETAILED COMMENTS
ON THE
DRAFT ENVIRONMENTAL IMPACT STATEMENT
PREPARED BY
THE DEPARTMENT OF ENERGY
FOR THE
PLAINS AND EASTERN CLEAN LINES TRANSMISSION PROJECT
OKLAHOMA, TENNESSEE, AND ARKANSAS**

Environmental Justice

DOE has done a thorough assessment and has been inclusive and transparent in accordance to the regulations. EPA believes the communication strategy goes beyond the Federal Register requirements.

Recommendation:

Due to number of communities impacted, EPA recommends continued implementation of the on-going communication strategy to meet with land holders to discuss their options. EPA believes the public meetings are advantageous and will benefit the impacted communities.

Air Quality

The DEIS (Chapter 3, Section 3.3 and/or Appendix H) appears to be lacking detailed discussion of mitigation measures for construction-related and fugitive dust emissions. EPA suggests the Final EIS provide the following information and statements as appropriate:

- EPA acknowledges that as the project(s) are developed, analyzed and constructed, the potential environmental impacts will be addressed by the applicable permitting authorities (ADEQ and/or Oklahoma DEQ, DOE) and EPA Region 6 through the various permitting actions, approvals and studies as required by law.
- Any project involving prescribed burning should be done in accordance with all local, state and federal requirements and consistent with applicable Smoke Management Guidelines for each state.
- EPA asks that the following suggested mitigation measures be included to reduce impacts associated with emissions of fugitive dust, PM, and other pollutants from any planned construction-related activities. Our recommendations are as follows:

Recommendations:

Fugitive Dust Source Controls:

- Stabilize open storage piles and disturbed areas by covering and/or applying water or chemical/organic dust palliative where appropriate at active and inactive sites during workdays, weekends, holidays, and windy conditions;

- Install wind fencing and phase grading operations where appropriate, and operate water trucks for stabilization of surfaces under windy conditions; and
- Prevent spillage when hauling material and operating non-earthmoving equipment and limit speeds to 15 miles per hour. Limit speed of earth-moving equipment to 10 mph.

Mobile and Stationary Source Controls:

- Plan construction scheduling to minimize vehicle trips;
- Limit idling of heavy equipment to less than 5 minutes and verify through unscheduled inspections;
- Maintain and tune engines per manufacturer's specifications to perform at EPA certification levels, prevent tampering, and conduct unscheduled inspections to ensure these measures are followed.

Joanne Stover

From: Taylor, Michael <michael_taylor@nps.gov>
Sent: Friday, February 20, 2015 11:04 AM
To: Farmer, Constance
Cc: Summerson, Jane (Jane.Summerson01@nnsa.doe.gov); MacDonald, John; Chavez, Allie; 'jstover@jwdrivers.com' (jstover@jwdrivers.com); Bryan Faehner
Subject: Re: Plains & Eastern Clean Line Transmission Line Project
Attachments: NTIR comment letter 20130320.pdf; TRTE Plains and Eastern transmission 3.14.13.pdf

Ms. Farmer:

I apologize for not getting back to you sooner regarding potential impacts to the Trail of Tears National Historic Trail by the proposed Plains & Eastern Clean Line Transmission Line Project. Our office submitted a preliminary letter and map showing the Trail of Tears in relation to the proposed transmission line in 2013 (see attached). Our GIS specialist has also developed some more detailed maps that I can send you as well. I would be glad to meet with Ms. Summerson here in Santa Fe when it would be convenient for her. Please let me know if you would like to talk by phone in the meantime.

Mike

Michael Romero Taylor
Cultural Resources Specialist
National Trails Intermountain Region
National Park Service
P.O. Box 728
Santa Fe, NM 87504-0728

Phone: 505 988-6742
Fax: 505-986-5214

Working with you to protect, develop, and promote national historic trails.

Please see our web site: <http://www.nps.gov/orgs/1453/index.htm>

On Tue, Feb 10, 2015 at 11:45 AM, Farmer, Constance <Connie.Farmer@tetrattech.com> wrote:

Mr. Taylor:

I am writing on behalf of Jane Summerson, DOE Document Manager and Section 106 lead for the Plains & Eastern Clean Line Transmission Project. Jane has asked me to reach out to you regarding the Trail of Tears as it relates to this proposed project. We are in the process of developing the Cultural Resources Identification Plan for spring 2015 surveys. If there is information that would be useful in developing this plan, I would appreciate it if you would provide that to me and cc Jane.

Jane is on the road for the next couple of weeks conducting public hearings on the draft EIS all along the proposed route. If you think a conference call would be helpful, she suggests that we wait until the public hearings are complete. She could also meet with you in Santa Fe when she returns to Albuquerque from the meetings. In the meantime, I am available if needed. Any information or insight you can provide to DOE would be greatly appreciated.

Regards,

Connie Farmer | Senior Environmental Program Manager

Direct: 303.980.3653 | Fax: 303.980.3539 | Cell: 303.918.2501

connie.farmer@tetratech.com

Tetra Tech, Inc. |

350 Indiana Street, Suite 500 | Golden, CO 80401 | www.tetratech.com

PLEASE NOTE: This message, including any attachments, may include confidential and/or inside information. Any distribution or use of this communication by anyone other than the intended recipient is strictly prohibited and may be unlawful. If you are not the intended recipient, please notify the sender by replying to this message and then delete it from your system.



Plains and Eastern Transmission Line and the Trail of Tears National Historic Trail

DRAFT

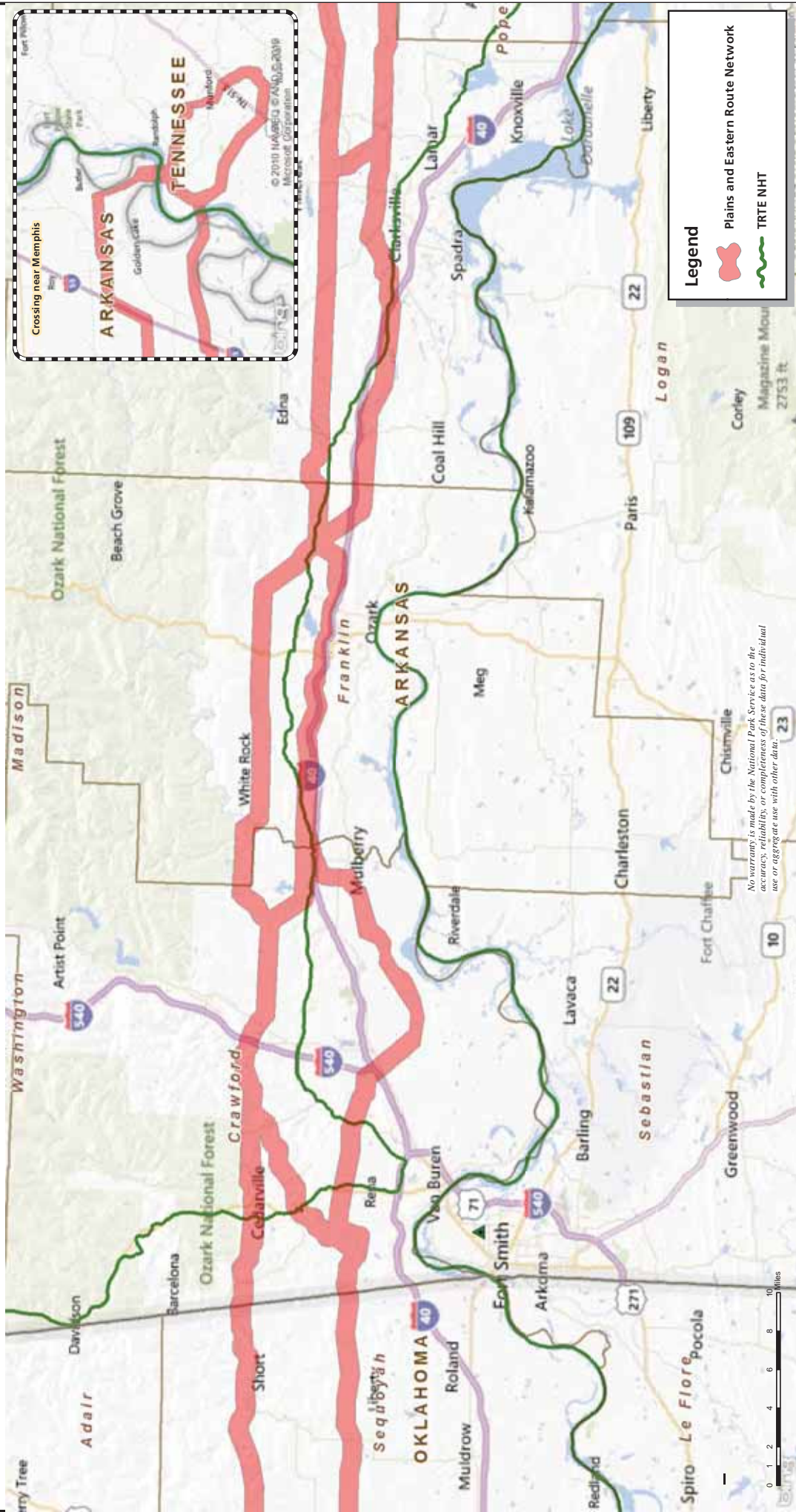



United States Department of the Interior
NATIONAL PARK SERVICE
National Trails – Intermountain Region
P.O. Box 728
Santa Fe, New Mexico 87504-0728



IN REPLY REFER TO: Plains and Eastern Transmission Line Compliance Letter

March 19, 2013

Jane Summerson, Ph.D.
DOE NEPA Document Manager
Office of Energy Efficiency and Renewable Energy
U.S. Department of Energy
1000 Independence Avenue SW.
Washington, DC 20585

Dear Dr. Summerson:

We are writing to express our concerns regarding some of the potential alignments of the Plains and Eastern Transmission Line Project, which runs from Oklahoma to Tennessee. We administer the Trail of Tears National Historic Trail (NHT), designated as an NHT by Congress in December 1987. The trail commemorates the tragic story of the forced removal of the Cherokee and other American Indian tribes from their homelands during 1838-1839, and subsequent relocation in eastern Oklahoma. The trail consists of over 2,200 miles of overland and water routes in nine Southeastern and Midwestern States. The trail has great cultural significance to the Cherokee and other tribes.

When our staff asked for and received GIS shapefiles for the potential route of the Plains and Eastern Transmission Line, and created a map showing the location of the transmission line corridor in relation to the location of the Trail of Tears NHT, we became quite concerned. Some of the alternative alignments in northwest Arkansas would result in the construction of a huge transmission line on top, nearby, or within view of as much as 50 miles of the Congressionally designated route of the Trail of Tears NHT, and a crossing of a water route of the trail near Memphis, Tennessee. We believe that, if these alternatives are selected, the transmission line construction will create irreversible permanent direct, indirect, and cumulative adverse effects to the Trail of Tears NHT, associated resources, and its setting. We therefore request to be a consulting party with you on all phases of the siting process for this project, including the National Environmental Policy Act, and for the National Historic Preservation Act Section 106 consultations.

I have attached a map made by staff that shows the correlation between the proposed transmission line corridors and the Trail of Tears NHT. Please contact Michael Elliott of my staff at 505-988-6092 or michael_elliott@nps.gov if you have any questions. Thank you for your consideration of our request.

Sincerely,

A handwritten signature in dark ink, appearing to read "Aaron Mahr Yañez".

Aaron Mahr Yañez
Superintendent



United States Department of the Interior



NATIONAL PARK SERVICE
INTERMOUNTAIN REGION
12795 West Alameda Parkway
P.O. Box 25287
Denver, Colorado 80225-0287

APR 01 2015

IN REPLY REFER TO:
IMR/NR
MAR-03/2015

Jane Summerson, Ph.D.
DOE NEPA Document Manager
DOE NNSA KAFB
PO Box 5400 Bldg. 391
Albuquerque, NM 87185-5400

Dear Dr. Summerson:

The National Park Service (NPS) has reviewed the Department of Energy's (DOE) Draft Environmental Impact Statement (DEIS) on the proposed Plains & Eastern Clean Line Transmission Project. We have identified two National Historic Landmarks (NHLs) that could be impacted by the project. Moreover, numerous segments of the Trail of Tears National Historic Trail (NHT) could be crossed by the project.

We encourage DOE to assess potential impacts to the Stamper Site National Historic Landmark (Texas County, Oklahoma), which is located in the vicinity of the proposed "Region 1" Wind Development Zone and AC Collection System route. The current DEIS has not identified this National Historic Landmark in the list of historic and cultural resources. Please send the results of this assessment to the IMR National Historic Landmarks Program.

Additionally, to the maximum extent possible, efforts should be made to avoid and minimize any potential impacts to the Honey Springs Battlefield National Historic Landmark (McIntosh & Muskogee counties, Oklahoma), which is located near the proposed area of potential effect for the alternative routes 3-C and 3-D. Visual impacts are identified in the DEIS for these proposed alternate routes; however, if these routes are selected DOE should consult directly with National Park Service's Intermountain Region National Historic Landmarks Program to minimize or mitigate any potential impacts to this nationally significant site. Section 110(f) of the National Historic Preservation Act requires that "prior to the approval of any Federal undertaking, which may directly and adversely affect any National Historic Landmark, the head of the responsible Federal agency shall, to the maximum extent possible, undertake such planning and actions as may be necessary to minimize harm to such landmark." Moreover, as stated in 36 CFR Part 800.10(c), federal agencies are required to notify the Secretary of the Interior (delegated to the NPS) of any consultation involving an undertaking at a NHL and invite the Secretary to participate in the consultation where there may be an adverse effect. Adverse effects are not limited to direct impacts and include visual effects. For more information regarding NHLs, please contact Christine Whitacre at 303-969-2882 or via email at christine_whitacre@nps.gov if you have further questions.

The NPS's National Trails Intermountain Region (NTIR) administers the Trail of Tears NHT, which was designated by Congress in December 1987. The trail commemorates the tragic story of the forced removal of the Cherokee and other American Indian tribes from their homelands during 1838-1839, and subsequent

relocation in eastern Oklahoma. The trail consists of over 2,200 miles of overland and water routes in nine Southeastern and Midwestern States. The trail has great cultural significance to the Cherokee and other tribes.

Some of the alternative alignments in northwest Arkansas would result in the construction of a very large transmission line on top, nearby, or within view of as much as 50 miles of the congressionally designated route of the Trail of Tears NHT, and two crossings of a water route of the trail north of Memphis, Tennessee as seen in the enclosed map. It appears that the alternative alignments presented show that the NHT will be crossed by land at least ten times from central Arkansas to the Arkansas/Oklahoma border. The alternative alignments also show a crossing of the NHT near Gore, Oklahoma. If these alternatives are selected, the transmission line construction will create irreversible permanent direct, indirect, and cumulative adverse effects to the Trail of Tears NHT, associated resources, and its setting. For the past fifteen years, the Arkansas State Historic Preservation Office (AR SHPO) has conducted extensive research, documentation, and mapping of Trail of Tear alignments in Arkansas.

In addition, the AR SHPO has listed a number of trail segments to the National Register of Historic Places. It is recommended that the AR SHPO especially be consulted early on in the review process. The Cherokee Nation, one of NPS's strongest partners in the preservation, protection, and interpretation of the Trail of Tears NHT, is also very concerned about potential impacts that can be caused by the transmission line construction.

The proposed transmission line alignment also crosses historic Route 66, a cultural route that NTIR administers through Route 66 Corridor Preservation Program. The crossing is just to the northwest of Depew, Oklahoma. This area could yield segments of the historic road that are determined eligible for the National Register of Historic Places.

The NPS is requesting to be a consulting party on all phases for this project, including the National Environmental Policy Act, and for the National Historic Preservation Act Section 106 consultations. The enclosed map shows the correlation between the proposed transmission line corridors and the Trail of Tears NHT. NTIR has additional GIS detailed maps showing points at which the proposed alignments cross the NHT. NTIR will be glad to share these with the DOE. Please contact Michael Taylor at 505-988-6742 or via email at michael_taylor@nps.gov if you have further questions.

We appreciate you contacting us to help ensure that NPS units and related sites are identified early in the planning process. If you have any questions about our comments, please contact Sarah Quinn, External Renewable Energy Program Coordinator, at 303-969-2094 or via email at sarah_quinn@nps.gov.

Sincerely,



Tammy Whittington
Associate Regional Director, Resource Stewardship & Science
Intermountain Region

Enclosures:

- 1) National Historic Landmarks Map (Oklahoma)
- 2) Trail of Tears Map

cc: Patrick Malone, Assistant Regional Director, Natural Resources, IMR

Vidal Davila, Acting Deputy Associate Regional Director, Resource Stewardship & Science, MWR
Ben West, Chief, Planning and Compliance Division, SER
Melissa Trenchik, Chief, Environmental Quality, IMR
Christine Whitacre, Manager, Heritage Partnerships Program, IMR
Christine Landrum, Director, Indian Affairs and American Culture, IMR
Aaron Mahr, Superintendent, National Trails Intermountain Region
Sarah Quinn, Renewable Energy Program Lead, NRSS-WASO
Andrew M. Montañó, Renewable Energy Specialist, IMR
Heidi Riddle, Renewable Energy Specialist, MWR
Bryan Fachner, Renewable Energy Specialist, SER
Truda Peters, Realty Specialist & Right-of-Way Coordinator, IMR
Michael Taylor, Cultural Resources Specialist, National Trails Program, IMR

National Historic Landmarks (NHL) Intermountain Region Oklahoma

National Park Service
U.S. Department of the Interior



Copyright © 2013 Esri

Legend

- National Park Unit
- National Historic Landmarks

- Interstates
- Major Highways

Cities

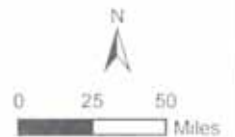

Landmarks

- | | |
|---|------------------------------|
| 1 101 Ranch Historic District | 12 Fort Washita |
| 2 Bizzell Library | 13 Guthrie Historic District |
| 3 Boley Historic District | 14 Honey Springs Battlefield |
| 4 Boston Avenue Methodist Episcopal Church, South | 15 McLemore Site |
| 5 Camp Nichols | 16 Murrell Home |
| 6 Cherokee National Capitol | 17 Platt National Park |
| 7 Creek National Capitol | 18 Price Tower |
| 8 Deer Creek Site | 19 Sequoyah's Cabin |
| 9 Earnest Whitworth Marland Mansion | 20 Stamper Site |
| 10 Fort Gibson | 21 Washita Battlefield |
| 11 Fort Sill | 22 Wheelock Academy |



Plains and Eastern Route Network

DRAFT

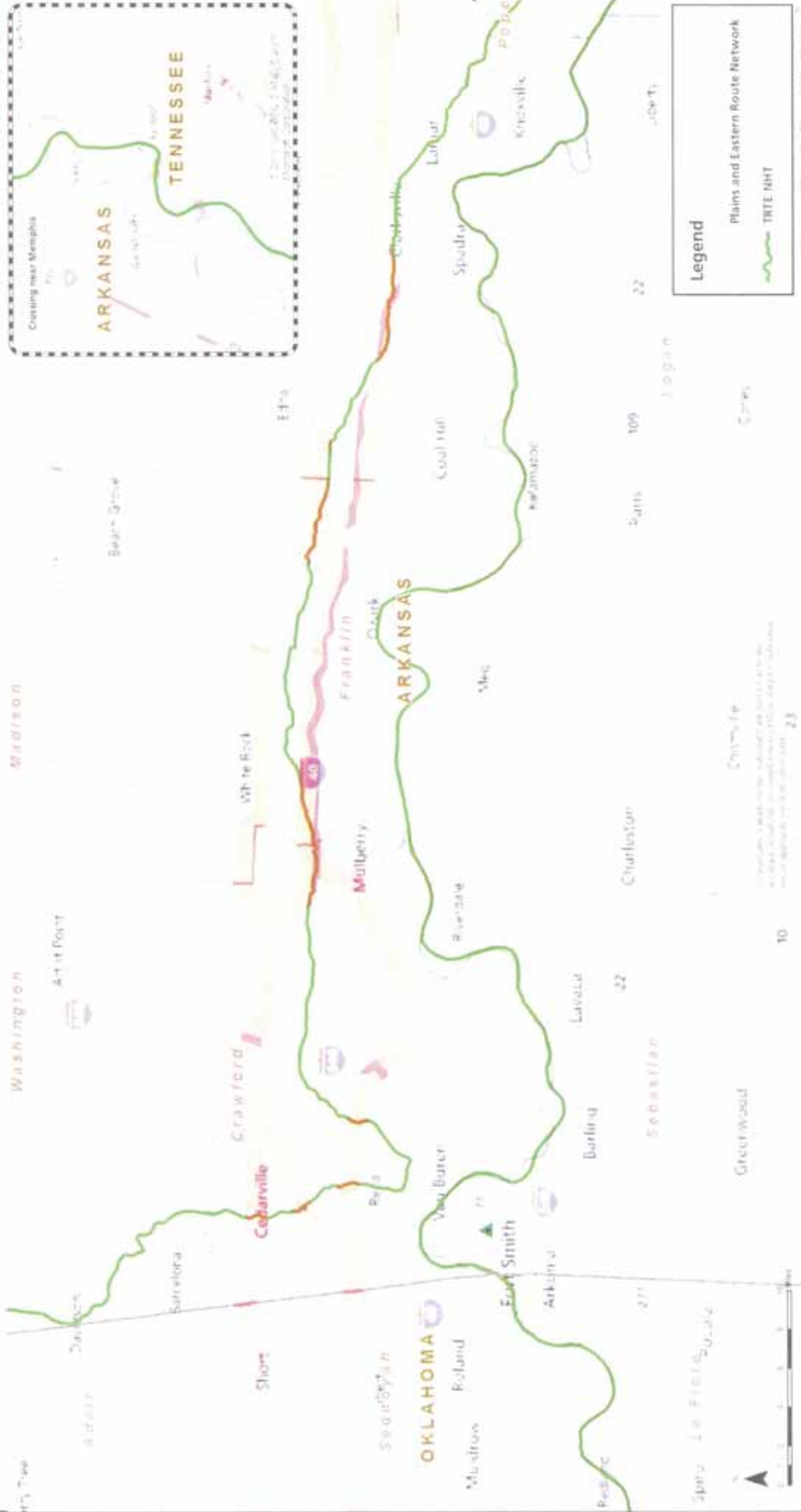

Legend

- Plains and Eastern Route Network
- TRTE RHT

Map data from Google Earth and other sources.

From: [Spencer, Stephen](#)
To: [CES.CommentsPlainSandEasternEIS](#)
Subject: Department of the Interior Comments, Plains and Eastern Clean Line Transmission Project
Date: Monday, April 20, 2015 2:01:34 PM
Attachments: [ER 14-0792 Plains and Eastern.pdf](#)

Please find the attached Department of the Interior comment letter on the subject project. I would appreciate receiving a confirmation indicating this letter has been received. Thank you.

Steve Spencer

--

Stephen R. Spencer, PhD
Regional Environmental Officer
Office of Environmental Policy and Compliance
U.S. Department of the Interior
1001 Indian School Road NW, Suite 348
Albuquerque, NM 87104
Phone: (505) 563-3572 Fax: (505) 563-3066 Cell: (505) 249-2462
Stephen_Spencer@ios.doi.gov
Web Site: www.doi.gov/oepec/albuquerque.html



United States Department of the Interior

OFFICE OF THE SECRETARY
Office of Environmental Policy and Compliance
1001 Indian School Road NW, Suite 348
Albuquerque, New Mexico 87104

ER 15/0122

File 9043.1

VIA ELECTRONIC MAIL ONLY

Jane Summerson, Ph.D.
Department of Energy
NEPA Document Manager
DOE NNSA Kirtland Air Force Base
P.O. Box 5400, Building 391
Albuquerque, New Mexico 87185-5400

Dear Dr. Summerson:

The U. S. Department of the Interior (Department) is providing comments on the Draft Environmental Impact Statement (DEIS) for the Plains and Eastern Clean Line Transmission Line Project in Texas, Oklahoma, Arkansas, and Tennessee. We are providing general comments on the document for your use as you prepared the Final EIS..

General Comments from FWS

Regarding routing, the U.S. Fish and Wildlife Service (FWS) recommends shifting the approximate 1.4-mile section of the Applicant Proposed Route (APR) that crosses Interstate 40 to the east side of Frog Bayou (Appendix A Figures Chapter1 Figure1.0-2 Aerial Region 4.pdf). By doing this, Clean Line would avoid crossing Frog Bayou twice and having to remove additional forested and wetland habitat. The APR should also avoid the following public and/or federally funded properties: Frog Bayou Wildlife Management Area (WMA), National Conservation Easements, and Cherokee WMA. We recommend avoiding these areas or ask that DOE provide a detailed explanation why a federally-backed private project would permit cutting a right-of-way (ROW) through public lands. In addition, FWS recommends Clean Line utilize Alternative Route 6-D (Appendix A Figures Chapter 1 Figure1.0-2 Aerial Regions 6-7.pdf) in order to avoid constructing and maintaining a permanent ROW directly adjacent to the Stringer Forest Natural Area.

In addition to “not placing structure foundations within the Ordinary High Water Mark of the United States,” FWS recommends spanning riparian zones at river and stream crossings when possible. The Avian Power Line Action Committee states, “Power lines located between feeding and roosting areas of flocking birds may present an increased collision risk. This is especially true for lines near rivers, lakes, or wetlands where fog may be common, making lines less visible” (www.aplic.org/Collisions.php). Clean Line should identify environmentally sensitive areas (e.g., Mississippi River, Arkansas River, Cache River, Singer Forest, Important Bird Areas (IBAs)) in their Avian Protection Plan (APP) that may pose higher risks of avian collisions and

work with the FWS and/or other resource agencies for guidance on conducting proactive avian collision surveys in these areas. The development of an APP is voluntary; however, it does provide the framework necessary for Clean Line to comply with bird protection laws. “Despite the fact that APPs are generally initiated by utilities, a cooperative dialog between the utility and the USFWS is encouraged during development and implementation” (Reducing Avian Collisions 2012). Therefore, FWS would like the opportunity to review and comment on Clean Line’s APP.

FWS understands that while there will be permanent habitat conversion (e.g., upland forest converted to managed ROW) in the ROW, there may be vegetation management strategies that could benefit certain species of ground nesting birds (i.e., northern bobwhite quail). Therefore, the FWS would like the opportunity to review and comment on Clean Line’s Transmission Vegetation Management Plan (TVMP).

New data exists regarding the presence of the federally-listed Ozark Big-eared Bat (OBEB) in or near the proposed ROW at Lee Creek Reservoir Park. On February 11, 2015, FWS shared the report documenting this new data with Clean Line via email. These data suggest OBEB use this cave during the winter as a hibernaculum. Therefore, we recommend further surveys be conducted during the summer and fall to document the use of this cave as a maternity roost and/or swarming site. Clean Line should consult with the FWS prior to conducting any additional surveys.

General Comments from NPS

The National Park Service (NPS) has identified two National Historic Landmarks (NHLs) that could be impacted by the proposed project. Numerous segments of the Trail of Tears National Historic Trail (NHT) could be crossed by the project. We encourage DOE to assess potential impacts to the Stamper Site National Historic Landmark (Texas County, Oklahoma), which is located in the vicinity of the proposed "Region 1" Wind Development Zone and AC Collection System route. The DEIS has not identified this National Historic Landmark in the list of historic and cultural resources. We request the results of this assessment be sent to NPS, Intermountain Region, National Historic Landmarks Program.

Additionally, to the maximum extent possible, efforts should be made to avoid and minimize any potential impacts to the Honey Springs Battlefield National Historic Landmark (McIntosh & Muskogee Counties, Oklahoma), which is located near the proposed area of potential effect for the alternative routes 3-C and 3-D. Visual impacts are identified in the DEIS for these proposed alternate routes; however, if these routes are selected DOE should consult directly with NPS’s Intermountain Region, National Historic Landmarks Program to minimize or mitigate any potential impacts to this nationally significant site. Section 110(f) of the National Historic Preservation Act requires, “prior to the approval of any Federal undertaking, which may directly and adversely affect any National Historic Landmark, the head of the responsible Federal agency shall, to the maximum extent possible, undertake such planning and actions as may be necessary to minimize harm to such landmark.” Moreover, as stated in 36 CFR Part 800.10(c), federal agencies are required to notify the Secretary of the Interior (delegated to the NPS) of any consultation involving an undertaking at a NHL and invite the Secretary to participate in the consultation where there may be an adverse effect. Adverse effects are not limited to direct impacts and include visual effects. For more information regarding NHLs, please contact Christine Whitacre at 303-969-2882 or via email at christine_whitacre@nps.gov, if you have further questions.

The NPS's National Trails Intermountain Region (NTIR) administers the Trail of Tears NHT, which was designated by Congress in December 1987. The trail commemorates the tragic story of the forced removal of the Cherokee and other American Indian tribes from their homelands during 1838-1839, and subsequent relocation in eastern Oklahoma. It consists of over 2,200 miles of overland and water routes in nine Southeastern and Midwestern States and has great cultural significance to the Cherokee and other tribes.

Some of the alternative alignments in northwest Arkansas would result in the construction of a very large transmission line on top, nearby, or within view of as much as 50 miles of the congressionally designated route of the Trail of Tears NHT, and two crossings of a water route of the trail north of Memphis, Tennessee, as seen in the enclosed map. It appears the alternative alignments presented show that the NHT will be crossed by land at least ten times from central Arkansas to the Arkansas/Oklahoma border. The alternative alignments also show a crossing of the NHT near Gore, Oklahoma. If these alternatives are selected, the proposed project will create irreversible permanent direct, indirect, and cumulative adverse effects to the Trail of Tears NHT, associated resources, and its setting. For the past fifteen years, the Arkansas State Historic Preservation Office (AR SHPO) has conducted extensive research, documentation, and mapping of Trail of Tears alignments in Arkansas.

In addition, the AR SHPO has listed a number of trail segments to the National Register of Historic Places. It is recommended that the AR SHPO be consulted early on in the review process. The Cherokee Nation, one of NPS's strongest partners in the preservation, protection, and interpretation of the Trail of Tears NHT, is also concerned about potential impacts from the proposed project.

The proposed transmission line alignment also crosses historic Route 66, a cultural route that NTIR administers through the Route 66 Corridor Preservation Program. The crossing is just to the northwest of Depew, Oklahoma. This area could yield segments of the historic road that are determined eligible for the National Register of Historic Places. The NPS is requesting to be a consulting party on all phases for this project, including the National Environmental Policy Act, and for the National Historic Preservation Act Section 106 consultations. The enclosed maps on pages 5 and 6 show the correlation between the proposed transmission line corridors and the Trail of Tears NHT and general locations of National Historic Landmarks. NTIR has additional GIS detailed maps showing points at which the proposed alignments cross the NHT. NTIR will be glad to share these with the DOE. Please contact Michael Taylor at 505-988-6742 or via email at michael_taylor@nps.gov if you have further questions.

We appreciate the opportunity to review and comment on the Draft EIS. If you have any questions or need additional information, please contact Jonna Polk, FWS Oklahoma Ecological Services Field Office, Tulsa, Oklahoma, at 918-382-4510, or Sarah Quinn, External Renewable Energy Program Coordinator, NPS, Intermountain Region, at 303-969-2094 or via email at sarah_quinn@nps.gov.

Sincerely,



Stephen R. Spencer, Ph.D.
Regional Environmental Officer



Plains and Eastern Transmission Line and the Trail of Tears National Historic Trail

DRAFT

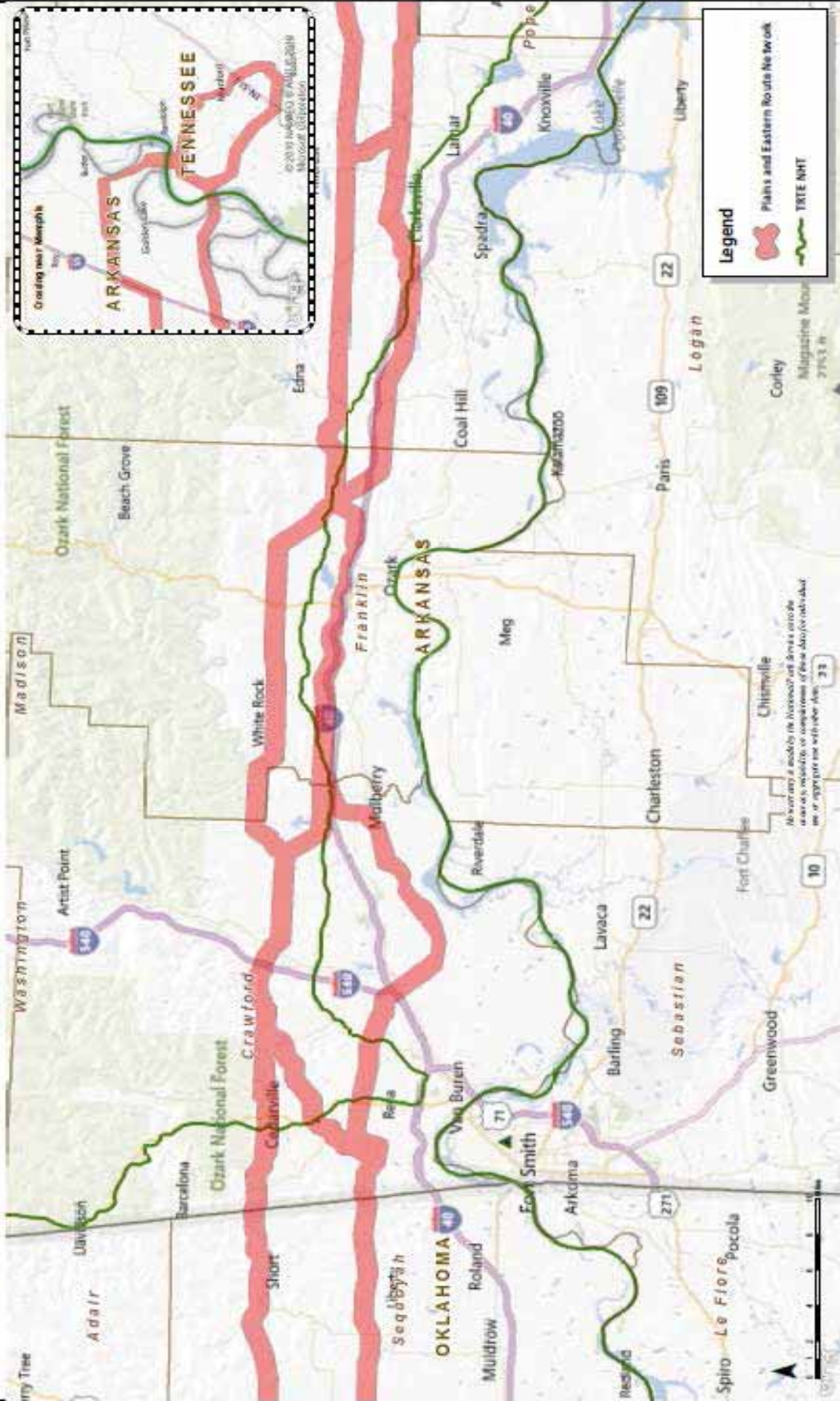

14 March 2013

Produced by National Trails Intermountain Region, Cultural Resources (MLE)

FILE: TRTE TRAIL AND TRANSMISSION

**National Historic Landmarks (NHL)
Intermountain Region
Oklahoma**

National Park Service
U.S. Department of the Interior

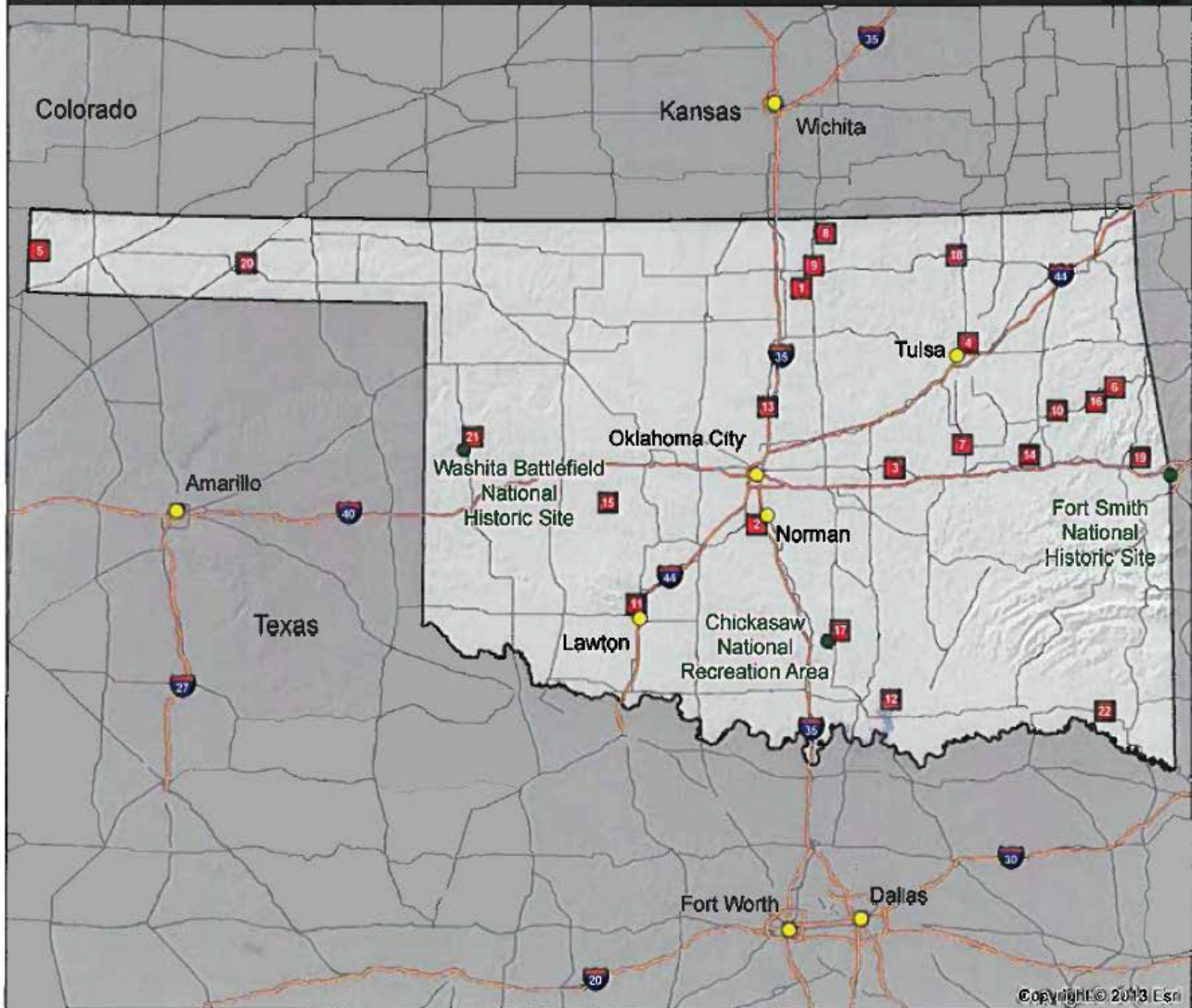

Legend

- National Park Unit
- National Historic Landmarks
- Interstates
- Major Highways
- Cities

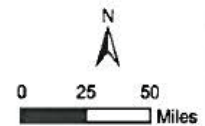

Landmarks

- | | |
|---|---|
| <ul style="list-style-type: none"> 1 101 Ranch Historic District 2 Bizzell Library 3 Boley Historic District 4 Boston Avenue Methodist Episcopal Church, South 5 Camp Nichols 6 Cherokee National Capitol 7 Creek National Capitol 8 Deer Creek Site 9 Earnest Whitworth Marland Mansion 10 Fort Gibson 11 Fort Sill | <ul style="list-style-type: none"> 12 Fort Washita 13 Guthrie Historic District 14 Honey Springs Battlefield 15 McLemore Site 16 Murrell Home 17 Platt National Park 18 Price Tower 19 Sequoyah's Cabin 20 Stamper Site 21 Washita Battlefield 22 Wheelock Academy |
|---|---|



United States Department of the Interior



FISH AND WILDLIFE SERVICE

Post Office Box 1306
Albuquerque, New Mexico 87103

In Reply Refer To:
FWS/R2/ES-HC/054026

MAR 21 2013

Ms. Melissa Ardis
Environment Impact Statement, Deputy Document Manager
U.S. Department of Energy
1617 Cole Boulevard
Golden, Colorado 80401

Dear Ms. Ardis:

By letter received November 6, 2012, you requested the participation of the U.S. Fish and Wildlife Service (Service) as a cooperating agency in the development and review of the National Environmental Policy Act (NEPA) process for the Plains and Eastern Clean Line Transmission Project Environmental Impact Statement (EIS). This memorandum confirms our interest in being a cooperating agency in the development of the proposed EIS. We would also invite the opportunity to develop a mutually agreeable Memorandum of Understanding (MOU) to formalize our specific roles and responsibilities.

The Service appreciates the opportunity to be a cooperating agency for this NEPA process. Our assistance will include analyzing effects of various proposed alternatives, identifying potential significant issues and developing alternatives as they pertain to our mission of working with the Department of Energy (DOE). Pursuant to the mission of the Service, our assistance as a cooperating agency will be directed to conserve, protect, and enhance fish, wildlife, plants, and their habitats for the continuing benefit of the American people. Our cooperation will be consistent with respective authorities of the Endangered Species Act, Fish and Wildlife Coordination Act, Migratory Bird Treaty Act, Bald and Golden Eagle Protection Act, the MOU with DOE regarding the implementation of Executive Order 13186, Avian Protection Plan Guidelines, and other appropriate laws and administrative guidance pertinent to the Department of the Interior.

As requested, the lead point of contact for this project is:

Vanessa Burge
Fish and Wildlife Biologist
U.S. Fish and Wildlife Service, Region 2
P.O. Box 1306
Albuquerque, New Mexico 87103-1306
505-248-6420
vanessa_burge@fws.gov

We look forward to cooperatively developing an MOU for the subject work. Collaboration on the proposed EIS is an opportunity for the Service to assist DOE in ensuring conservation of fish, wildlife, and their habitats while meeting project objectives. If you have any questions, please contact Vanessa Burge, Fish and Wildlife Biologist, Division of Ecological Services, at 505-248-6420, who is the primary contact for this project.

Sincerely,

Jay E. Nikolopoulos
ACTING Regional Director

Ms. Melissa Ardis

3

cc: Deputy Assistant Regional Director, Ecological Services, Region 4, Atlanta, GA,
(Attention: Christine Willis)
Regional Chief, National Wildlife Refuges, Region 2, Albuquerque NM,
(Attention: Kelly McDowell)
Chief, Migratory Bird Office, Region 2, Albuquerque, NM
Field Supervisor, Oklahoma Ecological Services Field Office, Tulsa, OK
Field Supervisor, Arkansas Ecological Services Field Office, Conway, AR
Field Supervisor, Tennessee Ecological Services Field Office, Cookville, TN



United States Department of the Interior



FISH AND WILDLIFE SERVICE

Post Office Box 1306
Albuquerque, New Mexico 87103

In Reply Refer To:
FWS/R2/ES-HC/054166

APR 10 2013

Melissa Ardis, Project Leader
Department of Energy
Plains and Eastern Clean Line EIS
1099 18th Street, Suite 580
Denver, Colorado 80202

Dear Ms. Ardis:

The U.S. Fish and Wildlife Service (Service) has reviewed the December 21, 2012, Notice of Intent to Prepare an Environmental Impact Statement for the Plains and Eastern Clean Line Transmission Project (Project) and Notice of Potential Floodplain and Wetland Involvement (77 FR 75623). The comments provided below are intended to provide technical assistance toward the development of the proposed action and draft Environmental Impact Statement (DEIS). The Project involves the construction of an overhead \pm 600 kilovolt high voltage direct current transmission line and its associated structures. The line would extend approximately 700 miles from Texas County, Oklahoma, to its terminus in Shelby County, Tennessee. All comments are submitted in accordance with Section 7 of the Endangered Species Act of 1973 (ESA), as amended (16 U.S.C. 1531 *et seq.*), the National Environmental Policy Act of 1969 (NEPA), (42 U.S.C. 4321 *et seq.*), the Migratory Bird Treaty Act of 1918 (MBTA) (16 U.S.C. 703 *et seq.*), and the Bald and Golden Eagle Protection Act of 1940 (BGEPA) (16 U.S.C. 668 *et seq.*). We offer comments based upon the December 2012, Federal Register notice.

Federally-Listed Species

Within the Oklahoma portion of the project area, there are occurrence records of 8 federally-listed species, as well as 2 candidate and 1 proposed species: the endangered American burying beetle (*Nicrophorus americanus*), the endangered gray bat (*Myotis grisescens*), the endangered Indiana bat (*Myotis sodalis*), the endangered interior least tern (ILT) (*Sterna antillarum*), the endangered Ozark big-eared bat (*Corynorhinus townsendii*), the endangered whooping crane (*Grus americana*), the threatened Arkansas River shiner (*Notropis girardi*), the threatened piping plover (*Charadrius melodus*), the proposed lesser prairie-chicken

(*Tympanuchus pallidicinctus*), candidate species Arkansas darter (*Etheostoma cragini*), and candidate species Sprague's pipit (*Anthus spragueii*). Within the Arkansas portion of the Project area, 18 federally-listed species, as well as 2 candidate species occur: the endangered yellowcheek darter (*Etheostoma moorei*), the endangered speckled pocketbook (*Lampsilis streckeri*), the endangered Indiana bat, the endangered gray bat, the endangered Florida panther (*Felis concolor coryi*), the endangered interior least tern, the endangered scaleshell (*Leptodea leptodon*), the endangered Ozark big-eared bat, the endangered American burying beetle, the endangered pink mucket (*Lampsilis abrupta*), the endangered pondberry (*Lindera melissifolia*), the endangered spectaclecase (*Cumberlandia monodonta*), the endangered pallid sturgeon (*Scaphirhynchus albus*), the endangered fat pocketbook (*Potamilus capax*), the threatened piping plover, the threatened geocarpon (*Geocarpon minimum*), the threatened rabbitsfoot (*Quadrula cylindrica cylindrica*), and candidate species Sprague's Pipit, and Rabbitsfoot (*Quadrula cylindrica*). Although candidate species are not afforded Federal protection under the ESA, we encourage efforts to avoid or minimize adverse impacts to these species and their habitats. Additionally, the Project could potentially affect federally-protected bald and golden eagles, as well as other migratory bird species.

For more information on federally-listed species known to occur within the Project area, please refer to the following websites and discussion below:

- www.fws.gov/arkansas-es/te_cty_list.html
- www.fws.gov/southwest/es/Oklahoma/species_fact_sheets.htm
- <http://www.fws.gov/cookeville/docs/endanger.html>

American burying beetle

The American burying beetle (ABB) is nocturnal (active only at night), has a life span of about 1 year, and is considered a feeding habitat generalist. American burying beetles enter an inactive period spent underground when nighttime low temperatures are consistently (at least 5 consecutive days) 60°F or below. In Oklahoma, this typically occurs from September 20 through May 20. Once nighttime low temperatures are consistently above 60°F, ABBs emerge and become active. The active period in Oklahoma typically occurs from May 20 through September 20.

The ABBs have been captured via baited pitfall traps in a variety of habitats including grasslands, grazed pasture, bottomland forest, riparian zones, and oak-hickory forest (Creighton et al. 1993; Lomolino and Creighton 1996; Lomolino et al. 1995; NatureServe Explorer 2003; and Service 1991). The ABB once occurred throughout the eastern United States. However, today the ABB's range is restricted to less than approximately 10 percent of its former range. The historic and current ranges of the ABB, and related ABB life history information can be found at:

www.fws.gov/southwest/es/Oklahoma/OKESFO%20Permit%20Home.htm.

The proposed routes for the Project spans 4 Oklahoma counties that are within the ABB's section 7 range: Sequoyah, Muskogee, Okmulgee, and Creek counties. While a scarcity of

ABB data exists for Creek and Okmulgee counties, Muskogee and Sequoyah counties have been shown to have a high percentage of positive ABB surveys (63.25 percent and 31.25 percent, respectively). Active season surveys conducted during 2011 revealed the presence of ABBs along the Project's proposed southern route through Muskogee County. More information concerning guidelines for conducting habitat assessments and presence/absence surveys can be found on our website at:

www.fws.gov/southwest/es/Oklahoma/species_fact_sheets.htm.

Additionally, eastern portions of Muskogee County and western portions of Sequoyah County have been designated as draft Conservation Priority Areas (CPAs). These areas have been given the CPA designation as they contain significant amounts of suitable habitat and have been shown to have positive ABB occurrence through presence/absence surveys. The Project's proposed route intersects portions of ABB CPAs within Sequoyah and Muskogee counties, Oklahoma. Currently, the Service recommends a higher offset or mitigation ratio for projects that occur within the boundaries of a designated ABB CPA.

In Arkansas, within the Project's proposed route, the ABB is known to occur in Crawford, Franklin, and Johnson counties. For these counties, we recommend conducting surveys for ABBs. The survey protocols are updated annually prior to the active season, and can be accessed at:

<http://www.fws.gov/arkansas-es/docs/ABB%20Rangewide%20Surveys%20Protocol%204-20-2011%20final.pdf>.

Interior least tern

Historically, interior least terns nested along the Colorado, Red, Rio Grande, Arkansas, Missouri, Ohio, and Mississippi river systems. Currently, the species nests in the Mississippi and Rio Grande river basins from Montana south to Texas and from eastern New Mexico and Colorado to Indiana and Louisiana. In Oklahoma, interior least terns nest on the larger rivers and salt flats, including Great Salt Plains, Arkansas River, Cimarron River, Canadian River, and Red River. During migration interior least terns can be found at ponds, reservoirs, and streams across all of Oklahoma and other portions of the Project area.

Interior least terns arrive at breeding areas from early April to early June, and spend 3 to 5 months on the breeding grounds. They can nest as individual pairs but typically nest in colonies having 2 to greater than 100 nests. The nest is a shallow depression in an open, sandy area, gravelly patch, or exposed flat on sand bars, islands and salt flats. Some have adapted to nest on large flat gravel roofs of buildings. Egg-laying begins in late May-June, with the female laying 1 to 3 eggs over a period of 3 to 5 days. Both sexes incubate the eggs, with incubation lasting about 20 to 22 days. The chicks hatch within 1 day of each other and remain in the nest for only a day or 2. Chicks are mobile and may seek shade and shelter in clumped vegetation and debris. Chicks are capable of flight within 3 weeks, but the parents continue to feed them until fall migration. Interior least terns will re-nest until mid-late July if clutches or broods are lost. The breeding season is usually complete by late August. The bird

migrates in small, loose groups, feeding en route and resting on sandbars, beaches, pilings, and docks (Thompson et al. 1997). The species often returns to the same breeding site, or one nearby, year after year.

Interior least terns are opportunistic foragers during the breeding season, and have been known to travel almost 12 km (7.5 mi) from the nesting area to feed (Schweitzer and Leslie 1996). The species feeds primarily on fish, feeding in shallow waters of rivers, streams, and lakes. The birds tend to select any small fish within a certain size range. Feeding behavior involves hovering and diving for small fish and aquatic crustaceans, and occasionally skimming the water surface for insects.

Migration routes and patterns of the species are not well understood. The species appears to migrate cross-country, as indicated by observations (1986 to 1993) in central Texas greater than 150 km from known nesting areas in major river drainages (Thompson et al. 1997). Some interior least tern populations appear to follow major river basins to the confluence of the Mississippi and then South to the Gulf of Mexico. Spring migration likely follows similar major routes along marine coasts and rivers, but such movements have not been extensively documented or monitored.

Within the Project area, interior least terns are found to nest on the Arkansas and Cimarron rivers. The routing alternatives proposed for the Project has this transmission line potentially crossing the Arkansas River near Robert S. Kerr Lock and Dam and approximately 7 miles downstream of a nesting site (Kerr Island) in Muskogee County, Oklahoma, and the Cimarron River at 2 potential locations in Major County, Oklahoma. Kerr Island is a small island within the Robert S. Kerr Lake or pool on the mainstem of the Arkansas River. Kerr Island can attract large numbers of nesting interior least terns.

There are 2 potential crossings of the Cimarron River proposed for the Cimarron River in Major County, Oklahoma. Nesting locations specific to interior least terns are not well documented near these sites, but ILTs are known to forage and migrate through the area. The proposed southern route bisects the Cimarron River at an approximately 90° angle; while the northern route roughly parallels the river before and after crossing. Running parallel to the river and its associated riparian corridor increases the risk to the species and their associated habitat.

Interior least terns migrate and forage in the area of all the proposed crossings. Overhead lines create potential collision risks and could preclude nesting near the lines. The species will not nest near tall vertical structures and these structures create perches for avian predators. We recommend all aquatic crossings incorporate a perpendicular bisection, and avoid routes that parallel water bodies, avoid any work or entry in river beds or salt flats supporting ILT nesting during the nesting season, and avoid the placement of overhead power lines, drilling equipment or any other tall vertical structures within 200 yards of ILT nesting areas. We also recommend avoiding crossings near nesting sites and entry to the river beds or salt flats during the nesting. Only qualified individuals may conduct ILT surveys to determine if the species is nesting near the proposed crossings or other sites with activity.

Additionally, the U.S. Army Corps of Engineers (Corps) continues to construct and manage ILT breeding islands in navigable waters throughout the species range in Oklahoma. Therefore, we highly encourage discussions with the Corps throughout the planning and construction process for this Project.

Ozark big-eared bat

The Ozark big-eared bat is an insectivorous bat that occurs in the Ozark Highlands and Boston Mountains ecoregions (Omernik 1987) of northeastern Oklahoma, and northwestern and north-central Arkansas. The species inhabits caves year-round; caves are typically located in oak-hickory hardwood forests.

Colonies begin to form at hibernacula in October and November (Clark et al. 1996 and 2002). Both sexes hibernate together in clusters that typically range from 2 to 135 individuals (Clark et al. 1993, 1997, and 2002). The species mates during fall and winter. Females store sperm in their reproductive tract during the winter hibernation period (Kunz and Martin 1982, Service 1995).

Hibernating colonies gradually begin to break up in spring from April through May (Clark et al. 2002). Females also become pregnant during this time (Kunz and Martin 1982) and slowly begin to congregate at warm maternity caves to give birth and rear their young over the summer (Clark et al., 1993, 1996, and 2002). Distances between hibernacula and summer caves are known to range from 6.5 to 65 km (4 to 40 mi). The exact timing of the formation of maternity colonies varies between years, but usually occurs between late April and early June (Clark et al. 2002, Service 1995). Like other temperate bats, the species exhibits strong roost fidelity, returning to the same maternity sites and hibernacula year after year (Kunz and Martin 1982, Clark et al. 1996, Weyandt et al. 2005).

Ozark big-eared bats typically forage in edge and forested habitats. They primarily feed on moths, but also are known to eat beetles and other flying insects (Service 1995, Leslie and Clark 2002, Dodd and Lacki 2007, Dodd et al. 2008). Females forage relatively close to the maternity cave (about 1.0 to 2.0 km; 0.6 to 1.2 mi) during the early and middle portions of the maternity season. Female bats likely forage only short distances from the cave in order to return several times during the night to take care of flightless young. As the season progresses, average distance to foraging sites increases (up to about 7.3 km; 4.5 mi) (Clark et al. 1993, Harvey 1992). Foraging farther distances from the cave later in the summer may reduce competition with newly volant young (young capable of flying) that have begun to forage.

The species utilizes caves in Oklahoma year round, and forages in close proximity to these caves during the spring and summer when insects are active. Potential impacts to the species should be considered for proposed projects in Adair, Cherokee, Delaware, Sequoyah, and Ottawa counties. Its current range may be obtained from the Service's Information, Planning, and Consultation System (IPaC) website at: <http://ecos.fws.gov/ipac/>.

Northern portions of Sequoyah County contain areas of sandstone talus that receives limited use by Ozark big-eared bats as roosting habitat. The Project's proposed northern route alternative crosses areas containing sandstone talus that could result in increased impacts to the Ozark big-eared bat. If the north alternative is chosen, the Service recommends conducting visual bat surveys and avoiding all areas of sandstone talus.

Whooping Crane

The whooping crane is a bi-annual migrant, traveling between its summer habitat in central Canada, and its wintering grounds on the Texas coast, across the Great Plains of the United States in the spring and fall of each year. Autumn migration normally begins in mid-September, with most birds arriving on the Texas wintering grounds between late October and mid-November. Spring migration departure dates are normally between late March and mid-April, with the last birds usually leaving by May 1.

The species passes through central Oklahoma each spring and fall during migration. The Salt Plains National Wildlife Refuge (NWR), near Jet, Oklahoma, is a very important migration stopover area and is designated critical habitat. During migration, whooping cranes are occasionally sighted elsewhere in Oklahoma along rivers, in grain fields, or in shallow wetlands. The species primarily use shallow, seasonally and semi permanently flooded palustrine wetlands and various cropland and emergent wetlands.

The Project's proposed route crosses several freshwater emergent wetlands as well as streams and rivers that could provide foraging and stop-over habitat for the whooping crane. We recommend avoiding constructing overhead power lines over or near these habitats within the whooping crane migration corridor. More information on the whooping crane and its migration corridor can be found at: www.fws.gov/southwest/es/Oklahoma/windpower.htm.

Arkansas River Shiner

The Arkansas River shiner (ARS) historically inhabited the main channels of wide, shallow, sandy bottomed rivers and larger streams of the Arkansas River basin (Gilbert 1980). Adults prefer to orient into the current just downstream of sand ridges and feed upon organisms washed downstream (Cross 1967). Adults are uncommon in quiet pools or backwaters, and rarely occur in tributaries having deep water and bottoms of mud or stone (Cross 1967). Juvenile ARS typically inhabit backwater and island habitat types, including tributaries (Polivka and Matthews 1997).

The ARS was widespread and abundant throughout the western portion of the Arkansas River basin in Kansas, New Mexico, Oklahoma, and Texas (Gilbert 1980). This species has subsequently disappeared from over 80 percent of its historical range, and as of October 2012, is almost entirely restricted to approximately 508 miles of the South Canadian (Canadian) River in Oklahoma, Texas, and New Mexico, from Ute Reservoir in New Mexico downstream to the Indian Nation Turnpike Bridge northwest of McAlester, Oklahoma. An

extremely small population may still persist in the Cimarron River in Oklahoma and Kansas extending from U.S. Highway 54 Bridge in Seward County, Kansas, downstream to U.S. Highway 77 Bridge in Logan County, Oklahoma.

Additionally, critical habitat has been designated for the ARS, which includes the Canadian River extending from State Highway 33 Bridge near Thomas, Oklahoma, downstream to the Indian Nation Turnpike bridge located northwest of McAlester, Oklahoma, and the Cimarron River from the U.S. Highway 54 Bridge in Seward County, Kansas, downstream to the U.S. Highway 77 Bridge in Logan County, Oklahoma. Critical habitat includes the river channels within the identified river reaches mentioned above, and includes a lateral distance of 91.4 m (300 ft) on each side of the stream width at bankfull discharge.

Both of the Project's proposed routes through Major County, Oklahoma, has the potential to impact the ARS and its critical habitat where it crosses the Cimarron River. While the southern route simply bisects the Cimarron River, the northern route runs parallel to the river and its corresponding critical habitat prior to and after its crossing. This parallel alignment can potentially result in additional impacts to ARS critical habitat and is discouraged by the Service.

To avoid incidental take of the ARS, we recommend the Project proponent develop in areas that will not impact the Cimarron River and its riparian area, designated critical habitat for the ARS, or associated tributaries. Impacts that would result in incidental take include water withdrawals from the river, modification to hydrology (increased or decreased runoff due to modifications to topography) increased sedimentation, chemical releases (fuel spills, herbicides) or other detrimental effect to water quality, use of low-water crossings, and construction of new bridges that require in-channel work. Water necessary for construction activities (concrete mixing, equipment cleaning) must not be pumped from the Cimarron River. Therefore, we recommend consultation with the Service prior to any construction within designated critical habitat to avoid effects to the species or its habitat.

Piping plover

Piping plovers in the Northern Great Plains population are threatened and the Great Lakes population is endangered. The species makes its nests on open, sparsely vegetated sand or gravel beaches adjacent to alkali wetlands, and on beaches, sand bars, and dredged material islands of major river systems. Piping plovers arrive on the breeding grounds during mid-March through mid-May and remain for 3 to 4 months per year. They lay 3 to 4 eggs in shallow scraped depressions lined with light colored pebbles and shell fragments. The eggs are well camouflaged and blend extremely well with their surroundings. Both sexes incubate the eggs which hatch within 30 days, and both sexes feed the young until they can fly, about 30 days after hatching.

Piping plovers begin arriving on the wintering grounds in Texas as early as July with some late nesting birds arriving in September. A few can be found on the wintering grounds throughout the year, but sightings are rare in late May, June, and early July. Knowledge of PPL migration routes, flight altitude, and stopover sites is incomplete. Inland populations appear to migrate nonstop from breeding sites to the Gulf of Mexico. Birds from the Northern Plains are rarely seen at inland stopover locations such as the great Salt Plains NWR, Oklahoma, and Cheyenne Bottoms NWR, Kansas (Elliott-Smith and Haig 2004). Spring migration patterns appear to be similar with few inland breeders stopping on the flight north. In late February, piping plovers begin leaving the wintering grounds to migrate north to breeding sites. Northward migration peaks in late March, and by late May most birds have left the wintering grounds.

The piping plover is a wide-ranging species and could migrate through areas within the proposed route of the Project. The species has been documented at rivers, wetlands, and reservoirs in many areas of Oklahoma during migration and have nested at Optima Lake in Texas County, Oklahoma. Therefore, we recommend any power lines that would cross large rivers or reservoirs be buried underground or overhead lines be marked to avoid potential collisions with piping plovers along with other migratory birds.

Lesser prairie-chicken

The historical range of the lesser prairie-chicken (LEPC) encompassed portions of Colorado, Kansas, New Mexico, Oklahoma and Texas. Although LEPC still occur in portions of their historical range, that range has been drastically reduced following decades of habitat alteration and encroachment from human activities. The LEPC's mating grounds, called leks, are often on wind-swept ridges in the few remaining parcels of large-scale, untilled rangeland. The primary threats to survival of the LEPC include habitat loss, degradation and habitat fragmentation, and the subsequent displacement of LEPC from the remaining habitat patches. The challenges facing LEPC conservation include incompatible grazing management, tree encroachment, conversion of rangeland to crop and non-native forage production, energy development, and increased disturbance. Habitat alteration and loss contribute to increased edge effects, fragmentation of habitat into smaller, less desirable patches, reduced habitat quality, reduced recruitment, increased predation, isolated populations, and possible genetic effects. These factors and others, such as disease, weather and climate change can exert a significant influence on LEPC distribution, particularly as population levels continue to decline. Maintaining large tracts of open, well-managed grassland is essential to the conservation of the LEPC.

Human development, including energy development, adjacent to or within LEPC habitat often contributes to further reductions in LEPC range and population size (Pruett et al. 2009a). Recent research in Kansas on radio-collared LEPC documented clear avoidance of certain man-made structures, such as roads and power lines, as well as natural vertical structures like trees (Robel 2002). Specifically, LEPC avoided areas of otherwise suitable habitat within 0.5 mile of human residences, well-traveled roads, and compressor stations, based on evidence from 6 years of data and over 45,000 radio locations of collared LPC on two 10,000-acre study sites. LEPCs were never located within 1 mile of a coal-fired generating station, and no

nesting attempts occurred with 0.5 miles of a human residence, well-traveled road, or compressor station (Robel 2002). This behavioral trait, the avoidance of vertical structures, also has been observed in several other species of prairie grouse. These vertical structures are likely perceived as vantage points for avian predators and can render otherwise suitable LEPC habitat as unusable. Based on recent LEPC research in Kansas, New Mexico and Oklahoma, electrical transmission lines do pose a legitimate threat via collision, habitat displacement, and a barrier to movement (Pruett et al. 2009b).

Therefore, we recommend the proposed routes avoid LEPC leks and nesting habitat. Priority or high quality habitats for the LEPC have been identified and should also be avoided. The Oklahoma Department of Wildlife Conservation and the Kansas Department of Wildlife, Parks, and Tourism have developed and maintain a model that allows project proponents to identify habitat that is crucial to continued existence of the LEPC. The Southern Great Plains Crucial Habitat Assessment Tool can be accessed at:

<http://kars.ku.edu/geodata/maps/sgpchat/>.

Arkansas Darter

The Arkansas darter is endemic to the Arkansas River basin of Colorado, Kansas, Oklahoma, Missouri and Arkansas. It typically occurs in small tributary streams in the vicinity of springs or groundwater seeps. Preferred habitat is usually found in pools or near-shore areas with low (but not zero) flow. The species is usually associated with broad-leaved aquatic vegetation. Primary food for is aquatic insects and other arthropods. Current populations are believed to exist in Kansas, Oklahoma, and Missouri.

The Arkansas darter occurs widely across the Arkansas River basin between southeastern Colorado and the Illinois River in Arkansas (Krieger et al. 2001, Service 2011). Within the Project area, known habitat for the AD exists in the Cimarron, Neosho, and Spring rivers and tributaries of these rivers across northern Oklahoma. The current range of the Arkansas darter may be obtained from the Service's Information, Planning, and Consultation System (IPaC) website at: <http://ecos.fws.gov/ipac/>.

The Project's proposed routes through Woodward and Harper counties, Oklahoma, have the potential to impact the Arkansas darter. The proposed northern route through Harper County, Oklahoma, crosses substantially more habitat than the proposed southern route, potentially causing a greater impact to the Arkansas darter. To avoid effects to the Arkansas darter, the project proponent should site the Project outside of the species' current known range (as obtained from IPaC). If an energy project must be located within the Arkansas darter's current range, then we recommend it be sited in an upland area away from stream channels. Additionally, we recommend co-locating projects in areas where previous disturbance exists, and use existing roads and bridges for access. For example, new distribution lines should be located within or immediately adjacent to existing road, transmission/distribution line, or pipeline corridors. Surface runoff from construction areas should be contained so that it does not flow over land into streams, springs, wetlands, or drainage ways. We recommend avoiding any water withdrawals, other modifications to hydrology (increased or decreased

runoff due to topographic grade changes), altered channel configurations and alignment (in riffle-pool-run sequence), altered substrate characteristics (composition, stability, permeability), increased sedimentation, chemical releases (fuel spills, herbicides), other water quality degradation, riparian area disturbance, construction or use of low-water crossings, and new bridge construction that requires in-channel work. If such effects cannot be avoided, then take is likely to occur and we recommend formal consultation as provided by the ESA.

Sprague's pipit

The Sprague's pipit is a grassland-obligate species, using native, untilled prairie almost exclusively throughout its life cycle (Owens and Myres 1973, Davis 2004, Dechant *et al.* 1998, Dieni *et al.* 2003, McMaster *et al.* 2005). The pipit is known to be very secretive around the nest, often refusing to flush until a searcher or similar disturbance is extremely close to the nest (Jones and Dieni 2007). The species is thought to be an area-sensitive species, preferring relatively large areas of native prairie to establish breeding territories. Although it has been documented to nest in planted, non-native grasslands, fledging success may be lower in these habitats (Higgins *et al.* 2002, Dechant *et al.* 1998, Dohms 2009, Fisher and Davis 2011). The pipit prefers larger grassland patches (preferred range 69 to 314 ha [170 to 776 ac]), with a low edge-to-area ratio (Davis 2004, Koper *et al.* 2009). However, smaller patches occasionally may be utilized during the breeding season (Davis 2004). Migration and wintering ecology are poorly known. Typically it is solitary during migration but occasionally may occur in loosely associated groups. Migration occurs primarily during the day. Occurrence and abundance of pipit during migration likely is largely influenced by local habitat conditions, with rainfall during the previous year being a particularly important factor influencing vegetation condition in these grasslands.

The breeding range of the Sprague's pipit includes parts of North Dakota, South Dakota, Montana, and Minnesota. The species wintering range in the United States includes portions of Arkansas, Arizona, Louisiana, Mississippi, Oklahoma and Texas, with most of the wintering concentrated in Texas and Louisiana (Robbins and Dale 1999), along with portions of northern and central Mexico. The migration corridor likely includes Texas, Oklahoma, Kansas, Nebraska, South Dakota, and North Dakota. In Oklahoma, specimen records are known from 11 counties: Canadian, Cleveland, Grady, Jefferson, Kiowa, Latimer, Mayes, McClain, Murray, Payne and Pittsburg (Wood and Schnell 1984). Sight or photographic records exist for another 13 counties: Alfalfa, Beaver, Beckham, Cimarron, Custer, Greer, Marshall, Noble, Oklahoma, Osage, Sequoyah, Tulsa and Washington (Wood and Schnell 1984). Consequently, the species likely occurs throughout Oklahoma during both spring and fall migration. In Oklahoma, the wintering range is largely confined to the southern half of the state. The migration corridor and wintering range overlaps all of Texas, including Lamar and Red River Counties. However, we have no documented occurrence records for the pipit in either county.

In our September 15, 2010, 12-Month Finding to List the Sprague's pipit (75 FR 56028), we identified habitat fragmentation as a major cause for the species' current and continued decline (Service 2010). Energy development is specifically known to cause fragmentation of pipit habitat. Fragmentation can be particularly detrimental in nesting areas, as fragmentation facilitates nest parasitism by brown-headed cowbirds (*Molothrus ater*). To avoid or minimize impacts on Sprague's pipit, projects should be sited in areas that lack suitable habitat and that are rarely, if ever, used by pipits such as heavily grazed pastures, agricultural fields, and forested areas, provided other species would not be impacted. Pastures composed predominantly of exotic, non-native grasses may be used by pipits but their densities in these pastures are much lower than those observed in native prairies. Consequently, siting projects in non-native grasslands is preferred over areas having predominantly native vegetation. Project sites should be co-located in areas where previous disturbance exists to minimize fragmentation and reduce edge effects. For example, existing road, pipeline and electrical transmission corridors should be used whenever possible. Placement of energy facilities and related developments in suitable stopover or wintering habitat could prevent pipits from using these areas. Similarly energy development projects that further divide (fragment) native grassland habitat into smaller and more isolated parcels may reduce or eliminate the suitability of these sites as stopover or wintering habitat.

Bald eagles and golden eagles

Bald eagles require large trees or cliffs, for nesting, located near water with abundant fish. They winter along oceans, rivers, lakes, or in areas where carrion is present. The bald eagle is found throughout North America. In Oklahoma, wintering bald eagles are most common between December and March. During this time, bald eagles congregate around reservoirs and larger rivers. Bald eagles also nest in Oklahoma and have increased to over 100 nesting pairs in recent years. Most nesting bald eagles are in eastern portions of the state, but new nesting pairs are discovered every year. Nesting eagles have expanded their range to include western Oklahoma and the panhandle. Suitable nesting habitat is provided by reservoirs and rivers with large trees nearby for nesting and perching.

The bald eagle is a delisted species and is no longer protected under the ESA. However, bald and golden eagles continue to be protected by BGEPA and by MBTA. BGEPA contains prohibitions in addition to those found within the MBTA; the BGEPA prohibits the take, possession, sale, purchase, barter, offer to sell, purchase, or barter, transport, export or import, of any bald or golden eagle, alive or dead, including any part, nest, or egg, unless allowed by permit. Further, activities that would disturb bald or golden eagles are prohibited under BGEPA. "Disturb" means to agitate or bother a bald or golden eagle to a degree that causes, or is likely to cause, based on the best scientific information available, (1) injury to an eagle, (2) a decrease in its productivity, by substantially interfering with normal breeding, feeding, or sheltering behavior, or (3) nest abandonment, by substantially interfering with normal breeding, feeding, or sheltering behavior. If a proposed project or action would occur in areas where nesting, feeding, or roosting eagles occur, then project proponents may need to take additional conservation measures to achieve compliance with BGEPA. Regulations (50 CFR § 22.26 and § 22.27) allow for the Service to issue permits for take of bald and golden eagles and their nests. However, consultation with the Migratory Bird and Ecological Services programs of the Service will be required before a permit may be considered.

Golden eagles occur primarily in western Oklahoma, mostly as migrants and wintering birds but include a few breeding pairs in the Oklahoma panhandle. If incidental take of bald or golden eagles is anticipated for any project, the responsible party should develop an Eagle Conservation Plan and apply for a permit under the BGEPA. Please refer to our recommendations in the National Bald Eagle Management Guidelines, at: www.fws.gov/migratorybirds/CurrentBirdIssues/Management/BaldEagle/NationalBaldEagleManagementGuidelines.pdf. Other materials on the Bald and Golden Eagle Management page can be accessed at: www.fws.gov/migratorybirds/BaldAndGoldenEagleManagement.htm. Please contact the Service's Regional Division of Migratory Birds, at 505-248-6639, for additional guidance in development of an Eagle Conservation Plan.

Migratory Birds

The Service is the principal Federal agency charged with protecting and enhancing populations and habitat of migratory bird species (waterfowl, waterbirds, shorebirds, raptors, and landbirds) that spend all or part of their lives in the United States. A list of the 1007 species of birds protected under the MBTA can be found at: www.fws.gov/migratorybirds/RegulationsPolicies/mbta/mbtintro.html, and at 50CFR 10.13. MBTA prohibits take of migratory birds except when specifically authorized by the Department of the Interior. Under the MBTA, "take" means to pursue, hunt, shoot, wound, kill, trap, capture, or collect, or attempt to pursue, hunt, shoot, wound, kill, trap, capture, or collect. Federal law enforcement officers and the Department of Justice need not prove that a taking was intentional to substantiate a violation.

The MBTA and its implementing regulations (50 CFR 21) do not provide for issuance of permits that authorize take of migratory birds that may be killed or injured by otherwise lawful activities, such as powerline construction. It is important for companies and their managers to ensure that their proposed activities have been fully coordinated in advance with the Service to avoid take of migratory birds to the greatest extent possible. Such coordination should occur as early in Project development as possible but certainly before final siting of transmission lines and associated infrastructure are constructed.

In addition to take of migratory birds through collision with powerlines, the greatest potential for illegal take of migratory birds by construction of a transmission line is clearing of habitats being used by actively-nesting birds. Destruction of nests containing eggs or nestlings constitutes a violation of the MBTA. Although most bird nesting activity occurs from early April through mid-August, depending on geographic location and elevation there may be some species nesting in nearly every month of the year. For example, Bald Eagles may initiate nesting in late fall; various owls and hawks may start breeding in January or February; and quite a few passerines will nest in March with some continuing into October. Contact the Service's regional Division of Migratory Birds to discuss which species to be aware of at a particular site as breeders outside the "core" nesting season of April through mid-August.

We recommend developing an Avian Protection Plan (APP) for the Project and utilizing the updates Service guidance document, "Reducing Avian Collisions with Power Lines: State of the Art in 2012." This document along with guidance for developing an APP can be found at: www.aplic.org.

The Service's Office of Law Enforcement carries out its mission to protect migratory birds through investigations and enforcement as well as through fostering relationships with individuals, companies and industries who have taken effective steps to avoid or minimize their negative impacts on migratory birds and through encouraging others to enact such programs. It is not possible to absolve individuals, corporations, or agencies from liability even if they implement avian mortality avoidance or similar conservation measures. There is no threshold as to the number of birds or other animals taken at Project sites beyond which the Service will initiate enforcement action. However, the Office of Law Enforcement focuses its resources on investigating and prosecuting individuals and companies that take migratory birds without regard for their actions or without taking effective steps to avoid or minimize take.

Wetlands

There are stream/wetland crossings included in the proposed Project. The placement of fill material in wetlands or waters of the United States associated with construction of this Project will require a Department of the Army Permit from the Corps. The Clean Water Act Section 404(b)(1) guidelines require applicants to first avoid, then minimize damage to the aquatic ecosystem, and finally mitigate for unavoidable adverse impacts to "obtain no overall net loss to wetlands," as agreed to within the 1990 Environmental Protection Agency/Corps Memorandum of Understanding Concerning the Determination of Mitigation. Additionally, the guidelines state when the proposed activities are not water dependent, "practicable alternatives...are presumed to be available unless clearly demonstrated otherwise" [Subpart B, Section 230.109(a) Section 404(b)(1)]. The Project is not dependent on the filling of wetlands, and therefore alternative alignments are available that would avoid and/or minimize impacts to wetlands and waters of the United States. Furthermore, the guidelines state, "...no discharge of dredged material shall be permitted if there is a practicable alternative to the proposed discharge which would have less adverse impact on the aquatic ecosystem, so long as the alternative does not have other significant adverse environmental consequences" and "An alternative is practicable if it is available and capable of being done after taking into consideration cost, existing technology, and logistics in light of overall project purposes." Unavoidable loss of wetland and waters of the United States requires mitigation through compensation. The amount required should be determined by a standard method, such as the Charleston Method, to ensure that the mitigation be appropriate to "obtain no overall net loss to wetland functions and values."

Therefore, we recommend impacts to wetland areas be avoided or minimized to the greatest extent practicable. Information on the occurrence of wetlands within the Project area may be obtained from the relevant National Wetlands Inventory (NWI) map. We encourage you to utilize the NWI maps in conjunction with ground-truthing to identify wetlands occurring within the proposed project area. Steps should be taken in determining the final location, extent, construction, and operation of project features to avoid any wetland impacts or loss, and provide for mitigation of any unavoidable wetland impacts. The Service's NWI provides many wetland resources on their website, at: www.fws.gov/wetlands.

We also recommend native species or non-persistent annual species should be used to revegetate work areas when needed, avoid use of aggressive, exotic species, and avoid the use of herbicides for pipeline maintenance, except where needed to control exotic species. We

encourage discussions with state natural resource agencies prior to performing stream crossings and work in other sensitive areas where state species of greatest conservation need or sensitive habitats may occur.

Grasslands (Mooney Ranch)

Intact grasslands are becoming increasingly rare in Oklahoma. Grasslands support many species within the State of Oklahoma, as well as several other declining migratory bird species. Preserving large tracts of prairie grasslands will be vital in ensuring the continuation of many species. The Mooney Ranch, located in western Muskogee County, Oklahoma, is a relatively un-fragmented ranch comprised of 5,080 acres of grassland, of which, 5,022 acres are enrolled under the Grassland Reserve Program administered by the Farm Services Agency of the U. S. Department of Agriculture. The size and un-fragmented nature of this ranch provides habitat to many prairie obligate species, such as the greater prairie chicken. We recommend Project proponents should avoid large tracts of intact grasslands, such as the Mooney Ranch.

Erosion and Sediment Control

We recommend best management practices (BMPs) be implemented for the Project. The BMPs should include filter fences, straw bales, interceptor dikes and swales, sediment traps, ditch checks, detention basins, mulching, seeding, and/or revegetation as appropriate. Mats or netting should be applied on steep slopes and stream banks. Erosion and sediment control measures should be sized to handle at least the 25 year flood and 24-hour storm event. Erosion and sediment control BMPs should be implemented to prevent sediment and contaminants from entering groundwater. On approaches to stream crossings, drainage control structures should be located at the top and base of the slope/bank. Runoff should be routed to stable slopes on either side of the right of way, or routed via temporary conveyance structures to the base of the approach slope where it can infiltrate into the stream bank and eventually seep back to the channel.

Additionally, we recommend the Project's construction plans reduce erosion and sediment by: 1) identifying areas with potential for erosion problems prior to construction initiation; 2) avoiding wetlands and low lying areas; 3) restoring steep embankments with seed, mulch, fertilizer, and implementing erosion control measures such as silt fences, straw bales, matting, and sediment traps; 4) stabilizing soil immediately after completing all earth work; and 5) restoring steep approaches to stream crossings by seeding, mulching, fertilizing, and implementing erosion control measures such as silt filter fences, ditch checks, straw bales, matting, and sediment traps. We stress it is critical that restoration be implemented immediately after Project construction.

Karst

Portions of the proposed route in Crawford, Franklin, Pope, Jackson, and White counties, Arkansas, will pass through a Service-recognized Karst Conservation Zone. The federally-listed gray bat, Indiana bat, and Ozark big-eared bat are known to occur in this area. The Service recommends avoiding these areas when possible. If these areas cannot be avoided, we recommend BMPs (as stated above in "Erosion and Sediment Control") be implemented for all construction project within the karst landscapes. Additionally, we recommend the

Project's construction plans reduce erosion and sedimentation into streams and karst features by identifying areas with potential erosion problems prior to initiating construction and avoiding wetlands and low lying areas.

The true extent of the underground environment is difficult to clearly delineate, and undiscovered karst features such as cave openings, sinkholes, and underground passages may occur on or near the Project site, even in previously developed areas. Therefore, we recommend the following precautionary measures be taken to avoid impacts to groundwater and sensitive or endangered species which may inhabit karst features not previously surveyed:

- Survey existing and any new right-of-ways for karst features such as caves, sinkholes, losing streams, and springs;
- Establish a natural area of 300 feet or greater around any cave, sinkhole, losing stream, or spring found during the survey (or during any aspect of project implementation). The Service should be contacted for further evaluation to determine if caves are used by sensitive or federally listed species;
- If a cave is used by sensitive or federally listed species, the Service may request that the cave be mapped to determine if additional openings or passages may be affected by the project. The Service may recommend modifications of the proposed Project to allow natural areas to be established. Incorporation of natural areas may be necessary to avoid impacts;
- If caves or other openings are encountered during construction, the Service requests that work efforts cease within 300 feet of the opening. The opening should be adequately marked and protected from work activities, and the Service should be contacted immediately. No fill materials should be placed into the opening until Service or Service approved personnel have the opportunity to inventory the site;
- The Service should assess caves located prior to or during construction for sensitive/endangered species and provide recommendations before activities proceed; and
- No blasting should be permitted in the vicinity of any known karst feature without previous consultation.

Additional measures may be required for construction near sensitive areas including stream channels and karst features. Care should be taken when working around streams and karst features to prevent unnecessary damage to or removal of vegetation. If a cave or fracture is breached or surface water is rerouted into a karst feature, all activities should cease and the Service should be contacted to assess the situation and provide further consultation before proceeding. Staging areas should be at least 300 feet away from streams, wetlands, and karst features. All streams, wetlands, and karst features adjacent to disturbed areas should be protected by the use of silt fence, straw bales, and other BMPs necessary to prevent sediment from entering water bodies. Streams and karst areas should be restored and stabilized immediately following construction activities. Native plants, mats, netting, and other BMPs should be used to stabilize banks. Instream deflectors and anchored logs should be used in high velocity streams to protect vulnerable banks and allow for reestablishment of vegetation. Riprap revetment should also be used, if necessary, to help stabilize slopes in areas of high

velocity stream flows. The use of riprap should, however, be minimized. Rock materials typical of the local geology should be used if available. Monitoring of BMP performance in critical areas, particularly at sensitive stream crossings and stream approach slopes should be conducted and documented on a routine basis prior to and after storms during construction and operation. Based on monitoring, additional BMPs, or other improvements may be necessary to insure minimization of impact. All efforts should be made to minimize stream alterations which could impact water quality and fish and wildlife resources. Construction along streams should not take place during fish spawning seasons if possible.

Indirect and Cumulative Effects under NEPA

The NEPA requires Federal agencies to evaluate not only direct impacts as a result of their action, but indirect and cumulative impacts as well. Indirect impacts are defined as impacts caused by their action and are later in time or further removed in distance, but are still reasonably foreseeable. Cumulative impacts differ in that they are defined as impacts that result from the incremental impact of the actions when added to other past, present, and reasonably foreseeable future. Since this action facilitates future development of additional power generating wind turbines within Texas County, Oklahoma, we recommend the Project proponent analyze the foreseeable adverse impact future wind power generation will have on the landscape within Texas County, Oklahoma.

We appreciate this opportunity to provide comments on the proposed Project, and we look forward to continuing our work with you in developing the proposed action and DEIS. If you have questions, please contact Michelle Shaughnessy, Assistant Regional Director, Ecological Services, Region 2, Albuquerque, New Mexico, at 505-248-6671.

Sincerely,

ACTING Regional Director

cc: Deputy Assistant Regional Director, Ecological Services, Region 4, Atlanta, GA,
(Attention: Christine Willis and Jerry Ziewitz)
Regional Chief, National Wildlife Refuges, Region 2, Albuquerque NM,
(Attention: Kelly McDowell)
Chief, Migratory Bird Office, Region 2, Albuquerque, NM
Chief, Migratory Bird Office, Region 4, Atlanta, GA
Field Supervisor, Oklahoma Ecological Services Field Office, Tulsa, OK
Field Supervisor, Arkansas Ecological Services Field Office, Conway, AR
Field Supervisor, Tennessee Ecological Services Field Office, Cookville, TN

Literature Cited

- Clark, B. S., B. K. Clark, and D. M. Leslie, Jr. 2002. Seasonal variation in activity patterns of the endangered Ozark big-eared bat (*Corynorhinus townsendii ingens*). *Journal of Mammalogy* 83(2):590-598.
- Clark, B. K., B. S. Clark, D. M. Leslie, Jr., and M. S. Gregory. 1996. Characteristics of caves used by the endangered Ozark big-eared bat. *Wildlife Society Bulletin* 24(1):8-14.
- Clark, B. S., D. M. Leslie Jr., and T. S. Carter. 1993. Foraging activity of adult female Ozark big-eared bats (*Corynorhinus townsendii ingens*). *Journal of Mammalogy* 74:422-427.
- Clark, B. S., W. L. Puckette, B. K. Clark, and D. M. Leslie, Jr. 1997. Status of the Ozark big-eared bat (*Corynorhinus townsendii ingens*) in Oklahoma, 1957 to 1995. *The Southwestern Naturalist* 42:20-24.
- Cross, F. B. 1967. Handbook of fishes of Kansas. Univ. Kans. Mus. Nat. Hist. Misc. Publ. No. 45. 357 pp.
- Davis, S.K. 2004. Area sensitivity in grassland passerines: effects of patch size, patch shape, and vegetation structure on bird abundance and occurrence in southern Saskatchewan. *The Auk* 121(4):1130-1145.
- Dechant, J.A., M.L. Sondreal, D.H. Johnson, L.D. Igl, C.M. Goldade, M.P. Nenneman, and B.R. Euliss. 1998 (revised 2001). Effects of management practices on grassland birds: Sprague's Pipit. Northern Prairie Wildlife Research Center, Jamestown, ND. Northern Prairie Wildlife Research Center Online. Available at <http://www.npwrc.usgs.gov/resource/literatr/grasbird/sppi/sppi.htm> (Version 28 MAY2004) (Accessed 25 February 2009).
- Dieni, J. S., W. H. Howe, S. L. Jones, P. Manzano-Fischer, and C. P. Melcher. 2003. New information on wintering birds of Northwestern Chihuahua. *American Birds* 103:26-31.
- Dodd, L. E. and M. J. Lacki. 2007. Prey consumed by *Corynorhinus townsendii ingens* in the Ozark Mountain region. *Acta Chirpterologica* 9:451-461.
- Dodd, L. E., M. J. Lacki, and L. K. Rieske. 2008. Variation in moth occurrence and implications for foraging habitat of Ozark big-eared bats. *Forest Ecology and Management* 255: 3866-3872.
- Dohms, K.M. 2009. Sprague's pipit (*Anthus spragueii*) nestling provisioning and growth rates in native and planted grasslands. Master's Thesis. University of Regina, Saskatchewan. 94 pp.
- Fisher, R.J. and S.K. Davis. 2011. Post-fledging dispersal, habitat use, and survival of Sprague's pipits: are planted grasslands a good substitute for native? *Biological Conservation* 144: 263-271

- Gilbert, C. R. 1980. *Notropis girardi* Hubbs and Ortenburger Artkansas River shiner. P. 268 in D.S. Lee *et al.* Atlas of North American freshwater fishes. N. Carolina Biol. Surv. Publ. No. 1980-12. N. Carolina State Mus. Nat. Hist., Raleigh. 854 pp.
- Harvey, M. J. 1992. Bats of the eastern United States. Arkansas Game and Fish Commission, Little Rock, Arkansas. 46 pp.
- Higgins, K.F., D.E. Naugle, and K.J. Forman. 2002. A case study of changing land use practices in the northern great Plains, USA: An uncertain future for waterbird conservation. *Waterbirds*. pp. 42-50.
- Jones, S. L., and J. S. Dieni. 2007. The relationship between predation and nest concealment in mixed-grass prairie passerines: an analysis using program MARK. *Studies in Avian Biology* 34: 117-123.
- Koper, N., D.J. Walker, and J. Champagne. 2009. Nonlinear effects of distance to habitat edge on Sprague's pipits in southern Alberta, Canada. *Landscape Ecology* 24(10): 1287-1297.
- Krieger, D., T. Nessler, C. Bennett, G. Dowler, and J. Melby. 2001. Arkansas darter (*Etheostoma cragini*) recovery plan. Colorado Division of Wildlife. 23 p.
- Kunz, T. H., and R. A. Martin. 1982. *Plecotus townsendii*. *Mammalian Species* 175:1-6.
- Leslie, D. M. and B. S. Clark. 2002. Feeding habits of the endangered Ozark big-eared bat (*Corynorhinus townsendii ingens*) relative to prey abundance. *Acta Chiropterologica* 4(2):173-182.
- McMaster, D.G., J.H. Devries, and S.K. Davis. 2005. Grassland birds nesting in haylands of southern Saskatchewan: landscape influences and conservation priorities. *Journal of Wildlife Management* 69(1): 211-221.
- Omernik, J.M. 1987. Ecoregions of the conterminous United States. Map (scale 1:7,500,000) revised August 2002. *Annals of the Association of American Geographers* 77:(1) 118-125.
- Owens, R.A., and M.T. Myres. 1973. Effects of agriculture upon populations of native passerine birds of an Alberta fescue grassland. *Canadian Journal of Zoology* 51:697-713.
- Polivka, K. M. and W. J. Matthews. 1997. Habitat requirements of the Arkansas River shiner, *Notropis girardi*: August 1, 1994 - August 7, 1997. Final Rept., Federal Aid Proj. No. E-33. Okla.Dept. Wildl. Cons., Oklahoma City, OK. 13 pp.
- Pruett, C.L., M. Patten, and D. Wolfe. 2009a. It's not easy being green: wind energy and a declining grassland bird. *BioScience* 59:257-262.
- Pruett, C.L., M. Patten, and D. Wolfe. 2009b. Avoidance behavior of prairie grouse: implications for wind and energy development. *Conservation Biology* 23:1253-1259.

- Robbins, M.B. 1998. Display behavior of male Sprague's pipits. *Wilson Bulletin* 110(3): 435-438.
- Robbins, M.B., and B.C. Dale. 1999. Sprague's Pipit (*Anthus spragueii*), *The Birds of North America Online* (A. Poole, Ed.). Ithaca: Cornell Lab of Ornithology. Available at <http://bna.birds.cornell.edu/bna/>. (Accessed June 19, 2009).
- Robel, R. J. 2002. Expected impacts on greater prairie-chickens of establishing a wind turbine facility near Rosalia, Kansas. Report to Zilkha Renewable Energy. 31 pp.
- Schweitzer, S.H., and Leslie, Jr. D.M. 1996. Foraging patterns of the Least Tern (*Sterna antillarum*) in North-Central Oklahoma. *The Southwestern Naturalist*, v41, No.3, pp. 307-314.
- Thompson, B.C., Jackson, J.A., Burger, J., Hill, L.A., Kirsch, E.M., and Atwood, J.L. 1997. Least Tern (*Sterna antillarum*), *The Birds of North America Online* (A. Poole, Ed.). Ithaca: Cornell Lab of Ornithology; Retrieved from the *Birds of North America Online*: <http://bna.birds.cornell.edu/bna/scpies/290>.
- U. S. Fish and Wildlife Service. 1995. Ozark Big-Eared Bat (*Corynorhinus townsendii ingens*) Revised Recovery Plan. Tulsa, OK. 50pp.
- U.S. Fish and Wildlife Service. 2008. Birds of Conservation Concern 2008. United States Department of Interior, Fish and Wildlife Service, Division of Migratory Bird Management, Arlington, Virginia. 85 pp. [Online version available at <<http://www.fws.gov/migratorybirds/>>]
- U.S. Fish and Wildlife Service. 2010. 12-Month Finding on a Petition to List Sprague's Pipit as Endangered or Threatened Throughout Its Range. *Federal Register* 75: 56028-56050.
- U.S. Fish and Wildlife Service. 2011. U.S. Fish and Wildlife Service species assessment and listing priority assignment form. *Etheostoma cragini*, Arkansas darter. USFWS. Available at http://ecos.fws.gov/docs/candidate/assessments/2012/r6/E06H_V01.pdf
- Weyandt, S. E., R. A. Van Den Bussche, M. J. Hamilton, and D. M. Leslie, Jr. 2005. Unraveling the effects of sex and dispersal: Ozark big-eared bat (*Corynorhinus townsendii ingens*) conservation genetics. *Journal of Mammalogy* 86:1136-1143.
- Wood, D.S. and G.D. Schnell. 1984. *Distributions of Oklahoma Birds*. University of Oklahoma Press, Norman. 209 pp.



United States Department of the Interior



FISH AND WILDLIFE SERVICE

Post Office Box 1306
Albuquerque, New Mexico 87103

In Reply Refer To:
FWS/R2/ES-HC/054889

JUL 09 2013

Melissa Ardis, Project Leader
Department of Energy
Plains and Eastern Clean Line EIS
1099 18th Street, Suite 580
Denver, Colorado 80202

Dear Ms. Ardis:

The U.S. Fish and Wildlife Service (Service) has reviewed the December 21, 2012, Notice of Intent to Prepare an Environmental Impact Statement for the Plains and Eastern Clean Line Transmission Project (Project) and Notice of Potential Floodplain and Wetland Involvement (77 FR 75623). We inadvertently missed including comments from our Region 4 Division of Refuges; however, we are providing these comments pursuant to the June 12, 2013, email communication between Vanessa Burge of my staff and you. The comments provided below are intended to provide technical assistance toward the development of the proposed action and draft Environmental Impact Statement (DEIS), and specifically discuss effects to the Cache River National Wildlife Refuge (NWR) in Arkansas.

The Cache River NWR was established in 1986 to protect significant wetland habitats and provide feeding and resting areas for migrating waterfowl. It is located in the ten-year flood plain of the Cache River from its confluence with the White River near Clarendon, Arkansas to Grubbs, Arkansas. Although the one-mile wide study corridors currently under consideration appear to avoid NWR lands, they do cross a 1,000-acre area directly adjacent to NWR lands where we are currently negotiating with landowners to acquire a conservation easement to become part of the NWR. In addition, in the southernmost corridor and even the middle corridor, there are off-refuge habitat resources for waterfowl, migratory birds, bald eagles, and potential endangered species (including Indiana bat). There are also off-refuge sites in these two corridors hosting birds that also use refuge grounds and travel back and forth between the NWR and these private lands. Therefore, the effects from the Project could degrade these habitats and in turn, could impact the Cache River NWR purposes as well. Further, all three proposed routes cross through the Cache River NWR's acquisition boundary where we hope to acquire lands in fee or via conservation easement, and we would prefer to acquire properties not crossed by the Project line. However, we have no jurisdiction/authority/control in those areas even though they are located within the Approved Acquisition Boundary.

Ms. Melissa Ardis

2

We appreciate this opportunity to provide comments on the proposed Project, and we look forward to continuing our work with you in developing the proposed action and DEIS. If you have any further questions, please contact Michelle Shaughnessy, Assistant Regional Director, Ecological Services, Region 2, Albuquerque, New Mexico, at 505-248-6671.

Sincerely,

A handwritten signature in black ink that reads "Jay E. Nikolopoulos". The signature is written in a cursive style with a large, prominent "J" and "N".

ACTING Regional Director

cc: Deputy Assistant Regional Director, Ecological Services, Region 4, Atlanta, GA,
(Attention: Christine Willis and Jerry Ziewitz)
Regional Chief, National Wildlife Refuges, Region 2, Albuquerque NM,
(Attention: Kelly McDowell)
Chief, Migratory Bird Office, Region 2, Albuquerque, NM
Chief, Migratory Bird Office, Region 4, Atlanta, GA
Field Supervisor, Oklahoma Ecological Services Field Office, Tulsa, OK
Field Supervisor, Arkansas Ecological Services Field Office, Conway, AR
Field Supervisor, Tennessee Ecological Services Field Office, Cookville, TN



United States Department of the Interior

FISH AND WILDLIFE SERVICE

Post Office Box 1306
Albuquerque, New Mexico 87103



In Reply Refer To:
FWS/R2/ES-HC/055205

AUG 05 2013

Melissa Ardis, Project Leader
Department of Energy
Plains and Eastern Clean Line EIS
1099 18th Street, Suite 580
Denver, Colorado 80202

Dear Ms. Ardis:

The U.S. Fish and Wildlife Service (Service) has reviewed the December 21, 2012, Notice of Intent to Prepare an Environmental Impact Statement for the Plains and Eastern Clean Line Transmission Project (Project) and Notice of Potential Floodplain and Wetland Involvement (77 FR 75623). The comments provided below are intended to provide technical assistance toward the development of the proposed action and draft Environmental Impact Statement (DEIS), and specifically discuss effects to the Ozark Plateau and Deep Fork National Wildlife Refuges (NWR) in Oklahoma.

The Ozark Plateau NWR was established in 1986 to prevent the extinction and aid in the recovery of federally-listed threatened and endangered Ozark cave species (including the endangered gray, Indiana, and Ozark big-eared bat; and the threatened Ozark cavefish); reduce the need for future listing of species of concern in the Ozarks; and to protect large continuous stands of Ozark forest essential to interior forest nesting migratory birds. The Ozark Plateau NWR currently consists of nine management units in Adair, Cherokee, Delaware, and Ottawa counties, Oklahoma. The Ozark Plateau NWR has been approved to acquire additional lands in Adair, Delaware, Ottawa, Cherokee, Craig, Mayes, and Sequoyah counties. The acquisition boundary of the Ozark Plateau NWR is based on geological formations where limestone and sandstone talus caves are likely to occur.

The Deep Fork NWR was established in 1993 to protect important wetlands and bottomland hardwood forests along the Deep Fork River, and provides habitat for both resident and migratory wildlife. The Deep Fork NWR is bounded on the northwest corner by the Okmulgee Wildlife Management Unit and on the southeast corner by the Eufaula Wildlife Management Unit both operated by the State of Oklahoma. The Deep Fork NWR continues to acquire land from willing sellers and will encompass 18,359 acres when all the lands within the acquisition boundary are purchased.

The proposed Project transmission line corridors do not cross existing lands of the Ozark Plateau or Deep Fork NWRs. However, both proposed routes of the Project pass north of Deep Fork NWR's proposed acquisition boundary. Areas in and around the Deep Fork NWR will have increased numbers of migratory and non-migratory birds, and power line strikes could be greater on the proposed route closer to the Deep Fork NWR.

Also, the two corridors in Sequoyah County occur with the approved acquisition boundary of the Ozark Plateau NWR. Two caves known to be used by the federally-listed endangered Ozark big-eared bat occur within the northern corridor. Undiscovered caves (limestone and/or sandstone talus caves) also may occur within the planning area. Summer roosting habitat of the Indiana bat and important migratory bird nesting and foraging habitat also may occur within the planning corridors.

Therefore, the Service provides the following recommendations to ensure unnecessary impacts to the Ozark big-eared bat, Indiana bat, and the purpose of the Ozark Plateau NWR would be avoided:

- 1) Seek additional coordination with the Ozark Plateau NWR and the Oklahoma Ecological Services Field Office should the northern corridor in Sequoyah County be further considered during future project planning so that impacts to known caves could be avoided.
- 2) Survey any proposed routes that would occur within the approved acquisition boundary of the Ozark Plateau NWR in Oklahoma where limestone or sandstone talus caves could occur and/or within karst areas of the planning area in Arkansas (Crawford, Franklin, Pope, Jackson, and White counties) for undiscovered cave habitat. Topographic and geological maps should be referenced to determine areas that should be surveyed. For example, surveys for caves should be conducted in areas where cave producing rock formations (e.g., limestone) occur; in areas that contain losing/sinking streams and/or springs; in areas of steep topographic relief; and in areas that contain outcrops of sandstone blocks. Should limestone or sandstone talus caves be located during surveys (or during any phase of the proposed project), the Service should be contacted for further evaluation to determine whether the feature is used by federally-listed species.
- 3) Conduct a habitat assessment of any proposed routes in Sequoyah County that contain wooded/forested habitat to determine whether the area provides suitable summer habitat for the Indiana bat following available current Summer Survey Guidance (<http://www.fws.gov/midwest/endangered/mammals/inba/inbasummersurveyguidance.html>).

We appreciate this opportunity to provide comments on the proposed Project, and we look forward to continuing our work with you in developing the proposed action and DEIS. If you have any further questions, please contact Michelle Shaughnessy, Assistant Regional Director, Ecological Services, Region 2, Albuquerque, New Mexico, at 505-248-6671.

Sincerely,



ACTING

Regional Director

Ms. Melissa Ardis

3

cc: Deputy Assistant Regional Director, Ecological Services, Region 4, Atlanta, GA,
(Attention: Christine Willis)
Regional Chief, National Wildlife Refuges, Region 2, Albuquerque NM
(Attention: Kelly McDowell)
Regional Chief, National Wildlife Refuges, Region 4, Atlanta, GA
Chief, Migratory Bird Office, Region 2, Albuquerque, NM
Chief, Migratory Bird Office, Region 4, Atlanta, GA
Field Supervisor, Oklahoma Ecological Services Field Office, Tulsa, OK (Attention:
Chris Tanner)
Field Supervisor, Arkansas Ecological Services Field Office, Conway, AR (Attention:
Thomas Inebnit)
Field Supervisor, Tennessee Ecological Services Field Office, Cookville, TN (Attention:
Kenneth McDonald)



REPLY TO
ATTENTION OF

DEPARTMENT OF THE ARMY
LITTLE ROCK DISTRICT, CORPS OF ENGINEERS
POST OFFICE BOX 867
LITTLE ROCK, ARKANSAS 72203-0867

DEC 06 2012

Regulatory Division

US Department of Energy
Golden Field Office
ATTN: Ms. Melissa Ardis, EIS Deputy Document Manager
Plains and Eastern Clean Line Project Environmental Impact Statement (DOE/EIS-0486)
1617 Cole Boulevard
Golden, Colorado 80401-3393

Dear Ms. Ardis:

Please reference Environmental Impact Statement (EIS) DOE/EIS-0486, on behalf of Clean Line Energy Partners, LLC, regarding Corps of Engineers permit requirements pursuant to Section 404 of the Clean Water Act and Section 10 of the Rivers and Harbors Act. The proposed project, referred to as the Plains and Eastern Clean Line Project, consists of the construction of a new +/- 600 kV high voltage direct current (HVDC) electric overhead transmission line, capable of transmitting over 3,500 MW of renewable energy generation from facilities in the western Oklahoma panhandle region to load-serving entities in the southeastern United States via an interconnection with the Tennessee Valley Authority in western Tennessee near Memphis. The proposed project would be located in several counties within the States of Oklahoma, Arkansas, and Tennessee. The request associated with the portion of the line within the Little Rock District boundaries has been assigned File No. **2011-00049**.

As requested within Department of Energy letter, dated November 6, 2012, the US Army Corps of Engineers, Little Rock District, agrees to participate in the EIS process as a cooperating agency, and as well, will act as Lead District for the State of Arkansas, working with the Memphis District, for the Plains and Eastern Clean Line Energy Project.

The Little Rock District has previously attended two pre-application meetings with Clean Line Energy Partners, LLC, along with other State of Arkansas and Federal agencies, to provide input into concerns of their route development. From the standpoint of the Corps of Engineers Little Rock District regulatory permit requirements, the EIS should include the impacts of each corridor to the aquatic environment. The aquatic environment encompasses all waters of the United States, which include Section 10 navigable waterways, tributary (perennial, intermittent, and ephemeral) streams, and wetlands. The EIS should address the measures taken to avoid or minimize impacts, such as the construction methods and erosion control measures. If the aquatic impact cannot be avoided or minimized, the EIS should specify how the impacts would be offset by compensatory mitigation.

Please be advised that due to the extent of the project, the transmission line alignment

appears to cross several areas defined as waters of the United States, which include Section 10 navigable waterways, tributary streams, and wetlands. Access roads, improvements to existing roads, new overland access, and new unpaved temporary roads may be required to access the transmission line and related facilities during the construction, operation and maintenance phases. Ancillary facilities such as communication facilities for control and protection would be required as well.

Any project or related construction activities as mentioned above that would result in the placement of fill material in wetlands or other waters of the United States requires a Section 404 Department of the Army Permit prior to commencing work. Typical Section 404 activities include filling, ditching, open-cut trenches, construction of access roads, or leveling. A determination should be conducted in the project area to delineate the exact boundaries of any wetlands or other waters of the United States along the transmission line alignment, and right-of-way area.

Additionally, activities that would involve the construction of any structure in, over, or under any navigable water of the United States require a Section 10 Department of the Army Permit prior to commencing work.

Clean Line Energy Partners, LLC, must identify any locations of the line that will cross or potentially impact levee projects. There will be specific requirements at these locations. Any proposed modifications or alterations to existing levees must be coordinated with the local levee boards.

Please be advised that jurisdictional determinations done by consultants are not official until approved by the Corps of Engineers; therefore, the determination will need to be submitted to this office for approval. As part of our permitting process, we will need identification of impact areas associated with streams and wetlands due to the proposed transmission line project.

If Clean Line Energy Partners, LLC, decides to proceed with the project proposal, a completed application including plan view and cross section drawings of the proposed project within the Little Rock District boundaries will need to be submitted to our office. The delineation/jurisdictional determination of waters of the United States can be submitted prior to a permit application or concurrent with the application.

You should be aware that the proposed transmission line traverses several Corps of Engineers District boundaries, specifically, Tulsa District, Little Rock District, and Memphis District. This letter is specific to the areas in Arkansas within the boundaries of the Little Rock District. For your reference, attached is a map depicting of the Little Rock District Corps of Engineers geographic boundaries.

As a part of the application process, Clean Line Energy Partners, LLC, should submit a sedimentation and erosion control plan. The plan must demonstrate that appropriate erosion and

siltation controls will be used during construction and that all exposed soil will be permanently stabilized.

If you have any questions, please contact Mrs. Cynthia Blansett or Mrs. Sarah L. Chitwood at 501-324-5295.

Sincerely,

for M. Elaine Edwards
Chief, Regulatory Division

CERTIFIED MAIL - RETURN RECEIPT REQUESTED

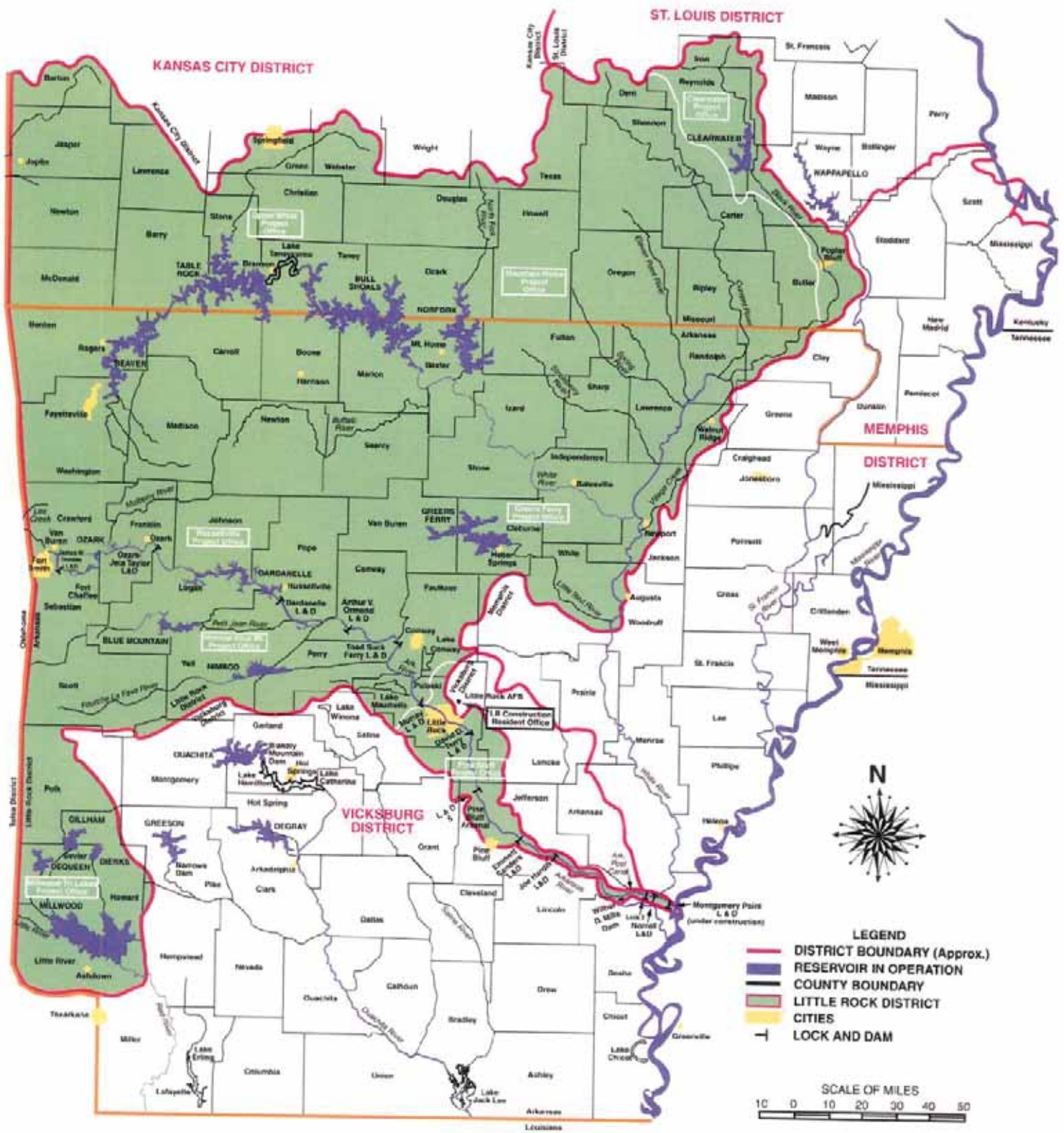

Points of Contact
U. S. ARMY CORPS OF ENGINEERS
Regulatory Activities – Little Rock District & Adjacent Districts

Little Rock District
 ATTN: CESWL-RD
 700 West Capitol Ave.
 Little Rock, AR 72201-3221
 (501) 324-5295

Memphis District
 ATTN: CEMVM-OD-R
 167 N. Main Street
 Room B-202
 Memphis, TN 38103-1894
 (901) 544-3471

Vicksburg District
 ATTN: CEMVK-OD-F
 4155 Clay Street
 Vicksburg, MS 39183-3435
 (601) 631-7660

Kansas City District
 ATTN: CENWK-OD-R
 635 Federal Bldg.
 Kansas City, MO
 64106-2824
 (816) 389-3990

St. Louis District
 ATTN: CEMVS-OD-F
 1222 Spruce Street
 St. Louis, MO
 63103-2833
 (314) 331-8575

Blansett, Cynthia W SWL

Subject: FW: Plains & Eastern EIS (UNCLASSIFIED)

-----Original Message-----

From: Wuornos, Reginald C MVM
Sent: Tuesday, March 12, 2013 11:09 AM
To: Blansett, Cynthia W SWL
Subject: Plains & Eastern EIS (UNCLASSIFIED)

I looked at the shape files for the potential ROW routes for the Clean Line Energy Project as it crosses through the Memphis District. We submit the following:

1. There are 3 navigable waters to cross, The White River, the St. Francis River and the Mississippi River.
 - a. They will require a Section 10 Permit.
 - b. It is our understanding that Clean Line Energy will not use horizontal directional drilling as a method of crossing any waters.
 - c. Line height over water must be high enough to not interfere with river traffic. Further guidance for minimum clearances can be found in 33 CFR Part 322 Permits for Structures or Work in or Affecting Navigable Waters of the United States, Section 322.5 (i)
- (2) Power transmission lines.
2. The White River -
 - a. The northern most route - approximately 800 feet crossing including approximately 300 feet of wetlands on the east side
 - b. The southern most route - approximately 2100 feet that could parallel US Highway 67, minimizing impacts
3. The St. Francis River -
 - a. One route - approximately 85 feet of open water crossing, approximately 300 feet combined wetland and open water crossing
4. Mississippi River crossing -
 - a. Northern most route - approximately, 2600 feet over open water at the proposed northern crossing option. Aerial photograph shows what appears to be a utility power line crossing at this location. Minimal wetlands at this location.
 - b. Southern most route - approximately 2700 feet over open water at the proposed southern crossing option. looks like wetlands on both sides.
 - c. Clean Line Energy will need authorization from the local levee board to cross the levee on the Arkansas side.
5. L'Anguille River crossing - Considered to be a navigable water downstream of the proposed Clean Line Energy Project. However, it may have a National Wildlife Refuge corridor.
 - a. Northern most route - approximately 100 feet to cross open water, wetlands on the east side except for the northern most portion of the northern route,
 - b. Southern most route - approximately 1380 feet to cross the river and wetlands, Wetlands on both sides
 - c. State Highway 214 is just north of the southern most route, this may be an opportunity to parallel the highway and minimize impacts.

6. Cache River crossing - Not considered a navigable water. There are wetlands on both sides at all 3 potential crossings. Clearing through wetlands will require a permit.
 - a. The northern most route - Highway 14 crosses the wetlands and river at this location. Potential to parallel the highway to minimize impacts. However, the northern most route turns south on the east side of the river where it runs into approximately 5800 feet of wetlands. Consideration should be given to alter route another direction.
 - b. The center route - approximately 1050 feet of wetlands to cross.
 - c. The southern most route - approximately 1100 feet of wetlands plus another 2400 feet of open water and wetlands to cross.
 - d. The Cache River at the 3 potential crossings maybe in a National Wildlife Refuge. Coordination with U.S. F&WS may be required.
 - e. There may be a crossing with less potential impacts to wetlands approximately 7.7 miles north of the northern most potential route; still in Poinsett County. Crossing is approximately 135 feet.
7. It appears consideration was given to avoid Wildlife Management Areas (WMA).
8. Avoid wetlands wherever feasible.
9. It is not known at this time if there may be Historical or Archeological issues within the potential routes. Coordination by the applicant with SHPO may be required; surveys may be required if near suspected areas of concern.
10. Recommend utilizing existing ROW corridors where feasible to minimize impacts.
11. It is likely there will be wetland impacts somewhere along the chosen ROW. There are no wetland mitigation banks in our district for Arkansas. Mitigation, if necessary, will be permittee responsible.

Please call me if you have any questions or wish to discuss.

Respectfully Submitted

Reggie

Reginald Wuornos
US Army Corps of Engineers
Memphis District, Regulatory Branch
167 N. Main St., B-202
Memphis, TN 38103
Office: (901) 544-0731
or toll free at
1-800-317-4156 ext. 0731
Fax Number: (901) 544-0211
Email: reginald.c.wuornos@usace.army.mil



REPLY TO
ATTENTION OF

DEPARTMENT OF THE ARMY
LITTLE ROCK DISTRICT, CORPS OF ENGINEERS
POST OFFICE BOX 867
LITTLE ROCK, ARKANSAS 72203-0867
www.swl.usace.mil/

Regulatory Division

MAR 29 2013

US Department of Energy
Golden Field Office
ATTN: Ms. Melissa Ardis, EIS Deputy Document Manager
Plains and Eastern Clean Line Project Environmental Impact Statement (DOE/EIS-0486)
1617 Cole Boulevard
Golden, Colorado 80401-3393

Dear Ms. Ardis:

Please reference Environmental Impact Statement (EIS) DOE/EIS-0486, on behalf of Clean Line Energy Partners, LLC, regarding Corps of Engineers permit requirements pursuant to Section 404 of the Clean Water Act and Section 10 of the Rivers and Harbors Act. The proposed project, referred to as the Plains and Eastern Clean Line Project, consists of the construction of a new +/- 600 kV high voltage direct current (HVDC) electric overhead transmission line, capable of transmitting over 3,500 MW of renewable energy generation from facilities in the western Oklahoma panhandle region to load-serving entities in the southeastern United States via an interconnection with the Tennessee Valley Authority in western Tennessee near Memphis. The proposed project would be located in several counties within the States of Oklahoma, Arkansas, and Tennessee. The request associated with the portion of the line within the Little Rock District boundaries has been assigned File No. **2011-00049**.

In a letter to Department of Energy, dated December 6, 2012 (copy enclosed), the US Army Corps of Engineers, Little Rock District, agreed to participate in the EIS process as a cooperating agency and act as Lead District for the State of Arkansas, working with the Memphis District. The letter also provided standard Regulatory requirements and concerns as part of the permit evaluation process.

The Little Rock District has attended two pre-application meetings with Clean Line Energy Partners, LLC, along with other State of Arkansas and Federal agencies, to provide input for route development. On January 24, 2013 and February 12, 2013, Memphis and Little Rock District representatives attended agency meetings in Atoka, Tennessee and Russellville, Arkansas, respectively, as preparation for the agency EIS scoping process.

The Little Rock and Memphis Districts have reviewed submitted material, shapefiles, Corps of Engineers mapping tools, and database information of the most current Clean Line Energy proposed route to provide comments for this EIS scoping process. It is not known at this time if there may be historical or archeological issues within the potential routes. Coordination by the applicant with the Arkansas State Historic Preservation Office (SHPO) may be required; surveys

may be required if the activity is near suspected areas of concern. This letter provides additional and supplemental information from the Little Rock District. Please see the enclosed comments from the Memphis District.

LITTLE ROCK DISTRICT COMMENTS:

There are two crossings of navigable waters of the United States, requiring Section 10 authorization, in the currently proposed Clean Line Energy route, Lee Creek and the Mulberry River. Guidance concerning height clearances is provided in the Memphis District comments.

The proposed route crosses the Little Red River in two locations; between miles 41.3 and 44.3 and between miles 45.1 and 46.9. The proposed route crosses the Mulberry River, Big Piney Creek, Illinois Bayou, and Cadron Creek, which are considered Extraordinary Resource Waters. The proposed route also crosses Departee Creek, which is considered an Ecologically Sensitive Stream. Large areas, which may be considered wetlands, are adjacent to Departee Creek.

Within the proposed routes are both State and Federal endangered species and species of concern, including the Longnose Darter (*Percina Nasuta*), Elktoe (*Alasmidonta Marginata*), Nearctic Paduniellan (*Paduniella Nearctica*), Early Saxifrage (*Saxifraga Virginiensis*), Lobed Spleenwort (*Asplenium Pinnatifidum*), and Pink Mucket (*Lampsilis Abrupta*).

The proposed route closely follows the rights-of-way of constructed interstate natural gas pipelines, Texas Gas Transmission, LLC and Fayetteville Express, LLC. These gas pipelines are within the Fayetteville Shale Play, a larger natural gas shale area, encompassing thirty-three counties within the central portion of the State of Arkansas.

Designated mitigation banks and mitigation areas are located along the route within the central portion of the state. Current information concerning mitigation banks within the Little Rock District in the State of Arkansas can be found at <http://geo.usace.army.mil/ribits>. There are no mitigation banks in the Little Rock District for the western portion of the state.

A portion of the proposed project crosses Corps of Engineers fee title property in Crawford County, Arkansas.

If you have any questions, please contact Mrs. Cynthia Blansett at 501-324-5295.

Sincerely,



M. Elaine Edwards
Chief, Regulatory Division

Enclosures

CERTIFIED MAIL - RETURN RECEIPT REQUESTED

From: [Blansett, Cynthia W SWL](#)
To: [CES.CommentsPlainSandEasternEIS](#)
Cc: [Wuornos, Reginald C MVM](#); [Hartsfield, J T \(Timothy\) SWT](#); [Blansett, Cynthia W SWL](#)
Subject: Clean Line Energy, Plains and Eastern Draft EIS Comments - DOE/EIS - 0486 (UNCLASSIFIED)
Date: Monday, April 20, 2015 3:26:13 PM

Classification: UNCLASSIFIED

Caveats: NONE

The Corps of Engineers submits the below comments for consideration concerning the draft EIS for Clean Line Energy, Plains and Eastern Project.

Table 3.9-1, there is an error in matching jurisdiction to statue column (Arkansas public and private lands and waters tied to Oklahoma statue).

Methodology for archaeological survey will need to comport with standards in areas where Section 404 or Section 10 permits may be required, and/or in areas that cross district lands. SWCA has previously indicated they believed 100 meter shovel testing spacing was adequate for site detection in all areas - including high probability areas in Oklahoma because, in short, Oklahoma has no published state standards. They were informed that they should always utilize guidelines that districts have been working on compiling for permit and fee lands, but short of that, should use best archaeological practices (at the least) and be consistent with requirements in surrounding states, where appropriate. Tulsa District requires 100% survey of any Tulsa District land being crossed, even if not being impacted directly by a tower or whatever they are proposing. ROWS, easements, access, temporary construction areas, borrow, disposal, staging areas, etc., are included in this requirement.

Section 2.1.3 on Easements and Property Rights: The discussion talks about the applicant to first offer landowner compensation for easement. Failing that, DOE, may try to work with the property owner through negotiated agreement to obtain property interests. Failing that, DOE may exercise Federal Government eminent domain authority. This is interpreted that this action may require DOE to become partners in the project.

Section 1.2.4 References should be corrected to read as:

Section 10 of the Rivers and Harbors Act of 1899 (33 U.S.C. 403)

Section 9 of the Rivers and Harbors Act of 1899 (33 U.S.C. 401); this reference is not applicable to the EIS.

Modifications to existing Corps of Engineers Projects (33 U.S.C. 408)

There is an update on the wording for a Section 408 review -

In addition to responsibilities identified above, the USACE is responsible for reviewing and granting permission for any work performed within the federal project boundaries as required by 33 USC § 408. Federal projects include structures such as the levees found along the Mississippi River and its tributaries. Additionally, work performed within 1,500 feet of Mississippi River levees has the potential to adversely affect the ability of the levee to perform as intended. Any excavation or sub grade construction within 1,500 feet of a levee should be coordinated with the USACE to ensure no negative impact to the level of flood risk reduction being provided.

Page 3.9-4, USACE is listed as a consulting agency in the Section 106 process. The Corps of Engineers will not participate as a signatory on a Section 106 Programmatic Agreement. Our process does not follow the Section 106 guidelines, but instead we comply with 33 CFR Appendix C.

Water EPMS, item W-5, - we recommend that all permanent and temporary crossings of waterbodies shall be suitably culverted, bridged, or otherwise designed and constructed to maintain low flows to sustain the movement of aquatic species. Furthermore, the crossings should be constructed to withstand expected high flows. Recommendation is found as a BPM at Table 2.7-1. Is it better listed as a BPM and not an EPM?

For Hazardous Materials Handling, we recommend - Recommend all hazardous material storage be placed in spill containment sites. This is also applicable to wastewater discharge from concrete batch plants.

On page 1-6, there is no need for Tulsa District Regulatory Office to be listed twice.

For the Arkansas Converter Station Siting area - "Siting area includes 96 acres of palustrine wetlands, 76 acres of lacustrine wetlands and 191 acres of riverine wetlands. Also listed are the a number of perennial and intermittent streams. But there are no major waterbodies. This appears to be misleading or confusing, at least it was for this reader.

There no waterbodies within "Resource - Wildlife and Fish Habitat" siting area.

Is Table 3.2-6 correct?

Water lines to converter station operation could possibly require permit verification.

Table 3.15-19 - This information should read as "Archey Creek" in HUC 11010014 and as "Greers Ferry Lake".

In 3.1.5.5.4, Oklahoma should not be included in this sentence as all Region 5 is in the state of Arkansas.

In Chapter 3.19, construction equipment within wetlands and use of construction matting would require permit verification with the Corps of Engineers.

Within Fayetteville Shale Play area, impacts to wetlands or Waters of the United States will require permit verification. Verification could be with the Nationwide Permits but also with other types of permits may be required, depending on the impacts. At this time, it would be pre-decisional to say impacts would verified by and issued under the Nationwide Permit Program until the impacts are further evaluated.

Thank you,

Cynthia Blansett

Cynthia Blansett
Environmental Protection Specialist
Corps of Engineers, Little Rock District
Regulatory Division
Little Rock, Arkansas 72203-0867
(501) 324-5295

Classification: UNCLASSIFIED

Caveats: NONE

APPENDIX C

POTENTIAL FEDERAL AND STATE PERMITS AND CONSULTATION REQUIRED FOR THE PROJECT



This page intentionally left blank.

Issue	Action Requiring Permit, Approval, or Review	Agency	Permit, License, Compliance, or Review	Relevant Laws and Regulations
Federal				
National Environmental Policy Act (NEPA) Compliance	2005 Energy Policy Act Section 1222 participation decision	U.S. Department of Energy	Environmental Impact Statement (EIS) and Record of Decision (ROD)	NEPA (42 USC 4321); CEQ (40 CFR 1500-1508); DOE NEPA implementing Regulations (10 CFR 1021)
ROW Across Land Under Federal Management	Preconstruction surveys; construction, operation, maintenance, and decommissioning	U.S. Forest Service (USFS)	Special Use authorization permit; Project-specific Forest Management Plan Amendment; lease or easement	36 CFR 251; 16 USC 518; 43 USC 1761-1771
	Preconstruction surveys; construction, operation, maintenance, and decommissioning on Tribal land	Bureau of Indian Affairs (BIA)	ROW Grant	25 CFR 169; 25 USC 323-328
	Right-of-way across USACE controlled real property	USACE	Realty Outgrant	Army Regulation 405-80; 32 CFR 643-644; 10 USC 2668-2668a
	Right-of-way crossing USACE-controlled levee	USACE	Section 408 Review and Determination	Rivers and Harbors Act of 1899 Section 14 (33 USC 408)
	Construction across water resources	USACE	General easement	10 USC 2668-2668a
Wildlife Resources	Potential impacts to federally protected species	USFWS NOAA (as applicable)	Endangered Species Act (ESA) consultation	Endangered Species Act of 1973 as amended (16 USC 1531 et seq.)
	Potential impacts to migratory birds	USFWS	Compliance	Migratory Bird Treaty Act of 1918, 16 USC 703-712; 50 CFR 1
	Potential impacts to bald and golden eagles	USFWS	Compliance	Bald and Golden Eagle Protection Act of 1972 (16 USC 668)
	Potential impacts to migratory birds	USFWS	Compliance	Executive Order 13186 and the Memoranda of Understanding (MOU) between the USFWS and the DOE.
Ground Disturbance and Water Quality Degradation	Discharge of dredge or fill material into waters of U.S.	USACE in coordination with states and U.S. Environmental Protection Agency (EPA)	Individual Permit or Nationwide Permit (Section 404); Water Quality Certification (Section 401)	Clean Water Act (33 USC 1344) (33 USC 1341)
	Construction of any structure in or over any navigable water of the U.S.	USACE	Rivers and Harbors Act Section 10 permit	Rivers and Harbors Act of 1899 (33 USC 403)

APPENDIX C
 POTENTIAL FEDERAL AND STATE PERMITS AND CONSULTATION REQUIRED FOR THE PROJECT

Issue	Action Requiring Permit, Approval, or Review	Agency	Permit, License, Compliance, or Review	Relevant Laws and Regulations
	Construction in or modification of floodplains or wetlands	USDOE	Compliance	42 USC 4321 Ex. Ord. Nos 11990 and 11988 Floodplains
	Impacts to rivers included in National Wild and Scenic Rivers Systems	NPS	Consultation	Wild and Scenic Rivers Act (PL 90-542) (16 USC 1271-1287)
Historical or Cultural Resources	Effects on historic properties	USDOE, in consultation with State Historic Preservation Officers (SHPO), Advisory Council on Historic Preservation, Indian Tribes, other Federal, state, and local agencies and consulting parties	NHPA Section 106 Consultation	National Historic Preservation Act of 1966, (54 USC 300101 et seq.) (36 CFR 800)
	Intentional removal from or excavation of Native American cultural items from Federal or tribal lands for purposes of discovery, study, or removal	USDOE in consultation with affected Native American group(s) regarding treatment of remains and objects	Consultation	Native American Graves Protection and Repatriation Act of 1990 (25 USC 3001-3002)
	Excavate, remove, damage, alter or deface archaeological resources on Federal or Tribal lands	Federal land management agency	Permit	Archaeological Resources Protection Act of 1979 (16 USC 470aa to 470ee) (43 CFR 7)
	Examine, excavate, or gather archaeological, historical or paleontological resources on Federal or Tribal lands	Federal land management agency	Permit	Antiquities Act of 1906 (16 USC 432-433)
Air Traffic	Structures greater than 200' tall	Federal Aviation Administration (FAA)	Review and "no-hazard determination"	FAA Act of 1958 (PL 85-726) (14 CFR 77)
	Structures in proximity to airport facilities and airspace	FAA	Section 1101 Air Space Permit	FAA Act of 1958 (PL 85-726) (14 CFR 77)
Agricultural Impacts	Impacts to agricultural lands, including prime, unique, and State and locally important farmland	Natural Resource Conservation Service (NRCS)	Farmland Site Assessment and Conversion Impact Ratings	Farmland Protection Policy Act (7 CFR 658; 7 USC 4201-4209)

Issue	Action Requiring Permit, Approval, or Review	Agency	Permit, License, Compliance, or Review	Relevant Laws and Regulations
States				
Oklahoma				
Electric Transmission Public Utility	The production, transmission, delivery or furnishing electric current for light, heat or power	Oklahoma Corporation Commission (OCC)	Certificate of Convenience and Necessity (issued October 28, 2011, by Order of OCC, Order #590530)	17 O.S. 151
ROW across state or federal highway	Right-of-way across state or federal ROW	Oklahoma Department of Transportation (ODOT)	Utility Permit	
Ground Disturbance and Water Quality Degradation	Construction activities resulting in greater than one acre of surface disturbance	Oklahoma Department of Environmental Quality (ODEQ)	OKR10 General Permit for Storm Water Discharges	Oklahoma Pollutant Discharge Elimination System Act (OPDES), 27A O.S. 2-6-201; 40 CFR 122.26 (b)(12)(x)
	Water use during construction	OWRB	Permit	Oklahoma Code, Waters and Water Rights; Chapter 82 O.S. 1020.1, et seq.
Wildlife Resources	Potential impacts to state listed threatened and endangered species and habitat	Oklahoma Department of Wildlife Conservation (ODWC) and Oklahoma Natural Heritage Inventory	Consultation	29 Okl. St. Ann. 5-402, 412, 412.1; 29 Okl. St. Ann. § 2-109, 135
Historical or Cultural Resources	Federal undertaking with the potential to affect historic properties	OK SHPO	Participation in NHPA Section 106 consultation (above)	National Historic Preservation Act of 1966, (54 USC 300101 et seq.) (36 CFR 800)
	Excavation and/or removal of archaeological resources	OK SHPO	Permit	Oklahoma Antiquities Law - Oklahoma Statute Chapter 20 (Section 361)
Arkansas				
Electric Transmission Public Utility	New transmission facilities constructed to connect the generating facility to the transmission grid	Arkansas Public Service Commission	Certificate of Public Convenience and Necessity (CCN) or Certificate of Environmental Compatibility and Public Need (CECPN)	See: http://www.apscservices.info/Rules/rules_of_practice_procedure2015.pdf , and Act 842 of Arkansas State Legislature
ROW across state or federal highway	Right-of-way across state or federal ROW	Arkansas State Highway and Transportation Department (AHTD)	Special Permit	
Wildlife Resources	Right-of-way across Wildlife Management Areas	Arkansas Game and Fish Commission (AGFC)	Easement or Special Use Permit	AR Code Ann. 15-20
	Potential impacts to state listed threatened and endangered species and habitat	AGFC	Consultation	AR ST § 15-45-301 to 306

APPENDIX C
 POTENTIAL FEDERAL AND STATE PERMITS AND CONSULTATION REQUIRED FOR THE PROJECT

Issue	Action Requiring Permit, Approval, or Review	Agency	Permit, License, Compliance, or Review	Relevant Laws and Regulations
Ground Disturbance and Water Quality Degradation	Non-point source discharges of storm water (delegated to state)	Arkansas Department of Environmental Quality (ADEQ)	Permit No. ARR150000 Authorization to Discharge Stormwater Under the National Pollutant Discharge Elimination System (NPDES) General Permit for Storm Water Discharges from Construction Activities	AR Water and Air Pollution Control Act (AR Code Ann. 8-4-101 et seq.)
Historic or Cultural Resources	Federal undertaking with the potential to affect historic properties	AR SHPO	Participation in NHPA Section 106 consultation (above)	National Historic Preservation Act of 1966, (54 USC 300101 et seq.) (36 CFR 800)
ROW Water Feature Crossings	Navigable Waters crossing by public service facility	Arkansas Public Service Commission	Navigable Waters Crossing petition	AR Code Ann. 23-3-500 et seq.
Tennessee				
Utility Franchise	Develop, construct, own, operate, manage and control electric transmission facilities and operate as a public utility providing electric transmission service	Tennessee Regulatory Authority (TRA)	Certificate of Public Convenience and Necessity	TN Code Ann. 65-4-208 and 65-4-201
ROW across state or federal highway	Right-of-way across state or federal ROW	Tennessee Department of Transportation (TDOT)	Overhead encroachments permit	
Wildlife Resources	Potential impacts to state listed threatened and endangered species and habitat	Tennessee Wildlife Resources Agency	Consultation	Tennessee Code Annotated, Sections 70-8-105 and 70-8-107
Ground Disturbance and Water Quality Degradation	Land-disturbance activities equal to or greater than 1 acre in size	TDEC–Division of Water Resources	Section 402 National Pollutant Discharge Elimination System (NPDES) General Permit for Storm Water Discharges from Construction Activities (TNR100000)	T.C.A. 69-3-108 and the Clean Water Act 33 USC 1251 et seq.
	Impacts to waters of the State	TDEC–Division of Water Resources	Aquatic Resource Alteration Permit (ARAP)	T.C.A. 69-3-108; Section 401 and 404 of the Clean Water Act
Historic or Cultural Resources	Federal undertaking with the potential to affect historic properties	Tennessee Historical Commission	Participation in NHPA Section 106 consultation (above)	National Historic Preservation Act of 1966, (54 USC 300101 et seq.) (36 CFR 800)

APPENDIX D

FEDERAL NOTICES



This page intentionally left blank

microsclerotia and can be used for aquatic plant control.

Brenda S. Bowen,

Army Federal Register Liaison Officer.

[FR Doc. 2012-30849 Filed 12-20-12; 8:45 am]

BILLING CODE 3720-58-P

DEPARTMENT OF ENERGY

Notice of Intent To Prepare an Environmental Impact Statement for the Plains and Eastern Clean Line Transmission Project and Notice of Potential Floodplain and Wetland Involvement

AGENCY: Department of Energy.

ACTION: Notice of Intent (NOI) To Prepare an Environmental Impact Statement and Notice of Potential Floodplain and Wetland Involvement.

SUMMARY: The U.S. Department of Energy (DOE) intends to prepare an *Environmental Impact Statement for the Plains & Eastern Clean Line Transmission Project* (DOE/EIS-0486; Plains & Eastern EIS or EIS) to assess the potential environmental impacts of participating with Clean Line Energy Partners LLC (Clean Line) in the proposed Plains & Eastern Project (the proposed project). The proposed project would include an overhead \pm 600 kilovolt (kV) high voltage direct current (HVDC) electric transmission system and associated facilities with the capacity to deliver approximately 3,500 megawatts (MW) primarily from renewable energy generation facilities in the Oklahoma Panhandle region to load-serving entities in the Mid-South and Southeast via an interconnection with the Tennessee Valley Authority (TVA). The proposed project would traverse Oklahoma, Arkansas, and Tennessee, a distance of approximately 700 miles between interconnection facilities in Texas County, Oklahoma, and Shelby County, Tennessee. The proposed project would require construction of a new alternating current (AC)/direct current (DC) converter station at each end of the transmission line.

Portions of the proposed project may affect floodplains and/or wetlands. This NOI, therefore, also serves as a notice of proposed floodplain or wetland action in accordance with DOE floodplain and wetland environmental review requirements (10 CFR part 1022). The Plains & Eastern EIS will include a floodplain and wetland assessment. DOE plans to coordinate the National Environmental Policy Act (NEPA) review and the Section 106 compliance process under the National Historic

Preservation Act (NHPA). DOE also intends to consult with the U.S. Fish and Wildlife Service (USFWS) and the National Marine Fisheries Service (NMFS), as appropriate, pursuant to Section 7 of the Endangered Species Act.

DATES: DOE invites public comment on the scope of the Plains & Eastern EIS during a 90-day public scoping period beginning with publication of this notice and ending on March 21, 2013. See *Public Participation* in the **SUPPLEMENTARY INFORMATION** section for public scoping meeting dates and locations. DOE will consider all comments received or postmarked by the end of the scoping period and will consider comments received or postmarked after the ending date to the extent practicable.

ADDRESSES: Written comments on the scope of the Plains & Eastern EIS and requests to be added to the EIS distribution list may be submitted by any of the following methods:

- Electronic comments via the project Web site at <http://PlainsandEasternEIS.com>.
- Email to info@PlainsandEasternEIS.com.
- U.S. Mail to Plains & Eastern Clean Line EIS, 1099 18th Street, Suite 580, Denver, CO 80202.

For additions to the distribution list, please specify the format of the Plains & Eastern EIS that you would prefer to receive (printed copy, CD, or DVD) and a preference for either the complete EIS document or "Summary Only." When completed, the EIS will be available for download at the project Web site (<http://PlainsandEasternEIS.com>) and at the DOE NEPA Web site (<http://energy.gov/nepa>).

FOR FURTHER INFORMATION CONTACT: For information on the Plains & Eastern EIS, contact Jane Summerson, Ph.D., DOE NEPA Document Manager, Office of Energy Efficiency and Renewable Energy, U.S. Department of Energy, 1000 Independence Avenue SW., Washington, DC 20585, or email at Jane.Summerson@ee.doe.gov.

For general information about the DOE NEPA process, contact Carol Borgstrom, Director, Office of NEPA Policy and Compliance (GC-54), U.S. Department of Energy, 1000 Independence Avenue SW., Washington, DC 20585, or phone at (202) 586-4600, voicemail at (800) 472-2756, or email at askNEPA@hq.doe.gov. Additional information regarding DOE's NEPA activities is available on the DOE NEPA Web site at <http://energy.gov/nepa>.

SUPPLEMENTARY INFORMATION:

1. Background

Section 1222(b) of the Energy Policy Act of 2005 (EPAct) authorizes the Secretary of Energy, acting through and in consultation with the Administrator of the Southwestern Power Administration (Southwestern) to participate with other entities in designing, developing, constructing, operating, maintaining, or owning new electric power transmission facilities and related facilities located within any state in which Southwestern operates, provided the Secretary determines that certain conditions have been met. Southwestern is one of four Power Marketing Administrations that operates within DOE. Southwestern is chartered to market and deliver power in the southwestern United States, including Arkansas and Oklahoma, to rural electric cooperatives and municipal utilities.

On June 10, 2010, DOE issued a Request for Proposals (RFP) for new or upgraded transmission projects pursuant to Section 1222 (75 FR 32940). Clean Line Energy Partners LLC of Houston, Texas, the parent company of Plains and Eastern Clean Line LLC and Plains and Eastern Clean Line Oklahoma LLC (collectively referred to as Clean Line), responded to the RFP on July 6, 2010, providing a description of the proposed project and supporting information. Clean Line's original proposal included two HVDC lines, each rated at 3,500 MW, together with the capacity to deliver 7,000 MW. Since the original proposal was submitted, Clean Line has modified its Section 1222 proposal to a single HVDC line with the capacity to deliver 3,500 MW. More information on the proposed project, including updates, can be found at <http://PlainsandEasternEIS.com>. DOE has concluded that Clean Line's proposal complied with and was responsive to the RFP.

Prior to making a determination whether to participate in the proposed project, DOE must fully evaluate the proposed project, in consultation with Southwestern, including reviewing the potential environmental impacts pursuant to NEPA and the requirements of Section 1222(b). DOE is preparing the Plains & Eastern EIS pursuant to NEPA, the Council on Environmental Quality (CEQ) NEPA regulations (40 CFR parts 1500 through 1508), and the DOE NEPA implementing regulations (10 CFR part 1021).

Portions of the proposed project may affect floodplains and/or wetlands. There are floodplains associated with the Cimarron River, North Canadian River, Arkansas River, White River,

Cache River, and Mississippi River, each of which would be crossed by the proposed transmission line, and potentially at other locations along the proposed routes. Similarly, wetlands could be present along the proposed routes, including near tributaries to rivers in the project area. This NOI, therefore, also serves as a notice of proposed floodplain or wetland action in accordance with DOE floodplain and wetland environmental review requirements (10 CFR part 1022). The Plains & Eastern EIS will include a floodplain and wetland assessment. DOE plans to coordinate the NEPA review and the NHPA Section 106 compliance process. DOE also intends to initiate consultation with USFWS and NMFS, as appropriate, pursuant to Section 7 of the Endangered Species Act.

2. Purpose and Need for Agency Action

DOE's purpose and need for agency action is to implement Section 1222(b) of the EPCA. To that end, DOE needs to decide whether and under what conditions to participate in Clean Line's proposed Plains & Eastern Project.

3. Proposed Action and Alternatives

The proposed project would include an overhead ± 600 kV HVDC electric transmission system with the capacity to deliver approximately 3,500 MW from the Oklahoma Panhandle region to load-serving entities in the Mid-South and Southeast. The proposed project would traverse Oklahoma, Arkansas, and Tennessee, a distance of approximately 700 miles. The western portion of the proposed project would interconnect to the transmission system operated by the Southwest Power Pool in Texas County, Oklahoma. The eastern portion of the proposed project would interconnect to the transmission system operated by TVA in Shelby County, Tennessee. TVA would make the necessary upgrades to its transmission system, which could include construction and operation of new transmission lines and substations and upgrades to existing transmission lines and substations.

A new AC/DC converter station would be built at each end of the transmission line. Each converter station would require the use of approximately 30 to 50 acres and would be located on private land. The converter stations are proposed to be located in Texas County, Oklahoma, and either Shelby County or Tipton County, Tennessee. The proposed project would include, in addition to the HVDC transmission line, four to six AC transmission lines of up to 345kV

interconnecting the western converter station with new wind generation facilities that would be located in parts of the Oklahoma panhandle, southwest Kansas, and Texas panhandle within approximately 40 miles of the western converter station. Clean Line anticipates that electricity generated by these facilities would constitute the majority of the transmission capacity of the transmission line.

The proposed project would also include the following major facilities and improvements:

- Right-of-way easements for the transmission lines with a typical width of approximately 150 to 200 feet for the HVDC line and potentially narrower for the AC transmission lines.
- Tubular or lattice steel structures used to support the transmission lines. For the HVDC line, structures typically would be between 120 and 200 feet tall depending on site-specific conditions. Limited quantities of taller structures may be required in some locations to address engineering constraints. Structures for the AC transmission lines may be shorter.
- Access roads, including improvements to existing roads, new overland access, and new unpaved temporary roads to access the proposed project facilities and work areas during the construction and operation phases.
- Ancillary facilities, such as communications facilities for access control and protection.

DOE's proposed action is to participate with Clean Line in the proposed project. In the Plains & Eastern EIS, DOE will analyze the potential environmental impacts of a range of reasonable alternative routes that could comprise the proposed project. DOE will also identify possible mitigation strategies for potential environmental impacts.

Clean Line identified the proposed location for the western converter station based on the presence of both an excellent wind resource (as classified by the DOE National Renewable Energy Laboratory) and adequate electrical interconnection facilities, including planned upgrades to existing facilities. Clean Line identified the proposed location for the eastern converter station based on the presence of high-voltage transmission facilities capable of interconnection and delivery of up to 3,500 MW of energy to portions of the Mid-South and Southeast.

As part of its planning process, Clean Line first identified several corridors within a broad study area. Clean Line evaluated the corridors for engineering and environmental issues and subsequently refined the corridors using

input from federal and state agencies, municipalities, non-governmental organizations, and various stakeholders. Clean Line then identified a study corridor approximately five to eight miles wide and held meetings with community leaders in counties intersected by the study corridor to solicit additional input. Clean Line then held open house meetings in fall 2012 to seek additional public input on potential routes. Using this information, Clean Line identified and submitted to DOE several potential routes.

In Oklahoma, the potential routes proposed by Clean Line begin in the central Oklahoma Panhandle and proceed in an east-southeasterly direction through generally rural areas between Oklahoma City and Tulsa, exiting the state in eastern Oklahoma near Sallisaw. The routes pass through the Central Flyway for migratory birds throughout Oklahoma. The proposed routes intersect the following counties in Oklahoma: Texas; Beaver; Harper; Woodward; Major; Garfield; Kingfisher; Logan; Payne; Lincoln; Creek; Okmulgee; Muskogee; and, Sequoyah. More specifically, from southern Texas County near Guymon, Oklahoma, to Harper County, routes are generally parallel to U.S. Highway 412 in an easterly direction through the Oklahoma Panhandle. They trend southeasterly in Woodward County, crossing the North Canadian River, and north of the city of Woodward and east of Boiling Springs State Park. From Woodward County, routes continue generally east and southeast in Major, Garfield, and Kingfisher counties, crossing the Cimarron River near Fairview and Glass Mountains State Park. In Payne County, routes cross the Cimarron River a second time and run near the Cushing Municipal Airport. The routes then trend in a southeasterly direction south of Cushing. The routes diverge around Bristow and run north of the city of Okmulgee. Routes continue a southeasterly trend in Muskogee County, crossing the Arkansas River at the Webbers Falls Reservoir near Gore. The routes then begin an easterly track, exiting Oklahoma northeast of Sallisaw in eastern Sequoyah County and entering Arkansas in western Crawford County.

In Arkansas, the routes proposed by Clean Line enter western Arkansas north of the city of Van Buren and proceed in an easterly direction through generally rural areas, exiting eastern Arkansas south of the city of Osceola, entering into Tennessee across the Mississippi River. The routes pass through the Mississippi Flyway for migratory birds throughout Arkansas

and Tennessee. The proposed routes intersect the following counties in Arkansas: Crawford; Franklin; Johnson; Pope; Conway; Van Buren; Faulkner; Cleburne; White; Jackson; Poinsett; and, Mississippi. More specifically, from Crawford County to eastern Pope County, the routes are south of the Ozark National Forest and generally follow the Arkansas River valley and Interstate Highway 40. Routes diverge around Alma and Dyer, but pass north of Ozark, Clarksville, and Dover, near the Cherokee Wildlife Management Area. In Conway County north of Morrilton, the routes continue in an easterly direction. The routes continue this easterly track north of Greenbrier, near Damascus and Quitman. North of Searcy, the routes turn northeast generally parallel to State Highway 67 north of Bradford, crossing the White River. The routes continue easterly along divergent paths across the Cache River and south of Marked Tree, cross Interstate Highway 55, to two proposed crossing locations of the Mississippi River. The proposed Mississippi River crossing locations are a north-south oriented crossing east of Wilson, Arkansas, at approximately river mile 768, and an east-west oriented crossing southeast of Joiner, Arkansas, at approximately river mile 762.

In Tennessee, the routes proposed by Clean Line enter western Tennessee from Arkansas at the two potential crossing locations described above and generally proceed in a southeasterly direction along separate paths through generally rural and suburban areas of Tipton County and Shelby County. The routes diverge around the community of Drummonds, with one route near Munford and Atoka and one route near Millington. The routes converge near the proposed interconnection point in Shelby County near Tipton, Tennessee.

DOE will analyze a range of reasonable alternatives. DOE has reviewed Clean Line's process and its proposed routes and determined that they provide a sufficient initial basis for the EIS. In addition, DOE will consider additional reasonable alternatives proposed in scoping comments and may expand or refine the range of alternatives based on those comments. Maps identifying the potential routes currently proposed for analysis are available on the EIS Web site at <http://PlainsandEasternEIS.com>. In addition to the facilities associated with the proposed project, the EIS will also analyze any facility additions and upgrades to third party systems to accommodate the proposed project.

The EIS also will analyze a No Action alternative, under which DOE would

not participate with Clean Line in the proposed project. DOE assumes for analytical purposes that the Plains & Eastern Project would not move forward and none of the potential environmental impacts associated with the proposed project would occur.

4. Preliminary Identification of Environmental Issues

DOE proposes to analyze potential short-term environmental impacts, such as those from construction, and potential long-term environmental impacts of operating and maintaining the transmission line. DOE's guidance for the preparation of an EIS recommends the use of the sliding-scale approach when evaluating environmental impacts. This approach would focus the analysis and discussion of impacts on significant environmental issues in proportion to the significance of the potential impacts. DOE has identified the following preliminary list of impact areas for evaluation in the EIS:

- Land Use, Recreation, and Visual Resources
- Water Use and Water Quality
- Surface Water Features including Rivers, Floodplains, and Wetlands
- Fish, Wildlife, and Vegetation, including Critical Habitat
- Socioeconomics
- Environmental Justice
- Historic and Cultural Resources
- Geology, Soil, and Mineral Resources
- Human Health and Electric and Magnetic Fields
- Air Quality and Climate Change
- Construction-Related Impacts, including Road Clearing, Traffic, and Noise
- Accidents, Intentional Destructive Acts, and Hazards, including Air Space Management
- Waste Management

This list is not intended to be all-inclusive or to imply any predetermination of impacts. DOE invites interested parties to suggest specific issues, including possible mitigation measures, within these general categories, or other categories not included above, to be considered in the EIS.

5. Agency Responsibilities

5.1 Stakeholder Involvement and Cooperating Agencies

DOE will prepare the EIS and will coordinate with appropriate federal, state, and tribal governments; local agencies; and interested members of the public during the preparation of the EIS. DOE will consult with Indian tribes on a government-to-government basis in accordance with Executive Order 13175

and other policies. Tribal concerns, including impacts on Indian trust assets and potential impacts on cultural resources, will be considered. DOE invites federal, state, tribal governments and local agencies with jurisdiction by law or with special expertise to be cooperating agencies on the EIS as defined in 40 CFR 1501.6. Such governments and/or agencies may also make a request to DOE to be a cooperating agency. As of this notice, TVA, and the Tulsa District and the Memphis District of the U.S. Army Corps of Engineers have committed to being cooperating agencies.

5.2 National Historic Preservation Act

Section 106 of the NHPA requires federal agencies to consider the effects of an undertaking on historic properties—historic structures and historic artifacts—before authorizing an undertaking (36 CFR part 800). Federal agencies are encouraged to coordinate compliance with Section 106 of the NHPA with any steps taken to meet the requirements of NEPA (36 CFR 800.8). In the interest of being comprehensive and less duplicative, DOE plans to coordinate the NEPA review and Section 106 compliance process for the preparation of the Plains & Eastern EIS to the greatest extent practicable. Further, DOE plans to invite federal, state, tribal governments, and members of the public to participate in this NEPA process for the purpose of ensuring the standards in 36 CFR 800.8(c)(1) through 800.8(c)(5), "Protection of Historic Properties," are met, including identifying mitigation actions that may be appropriate to address potential adverse effects that may result from implementing the proposed project.

5.3 Endangered Species Act

Section 7 of the Endangered Species Act requires an agency proposing to take an action to inquire of the USFWS and NMFS, as appropriate, whether any threatened or endangered species "may be present" in the area of the proposed action [see 16 U.S.C. 1536(c)(1)]. Accordingly, DOE intends to initiate consultation with these agencies.

6. Public Participation

The purpose of the scoping process is to identify alternatives and potential environmental impacts that DOE should analyze in the EIS. DOE will hold 12 public scoping meetings at the following locations and times in Oklahoma, Arkansas, and Tennessee to provide the public with an opportunity to present comments, ask questions, and discuss the scope of the Plains & Eastern EIS

with DOE and Clean Line representatives.

- January 22, 2013, 5:00–8:00 p.m. at Arkansas State University—Marked Tree Student Center, 33500 Highway 63 E, Marked Tree, AR 72365
- January 24, 2013, 5:00–8:00 p.m. at Gateway Baptist Church Center, 1915 Rosemark Road, Atoka, TN 38004
- January 28, 2013, 5:00–8:00 p.m. at Pickle Creek Center, 822 NE 6th Street, Guymon, OK 73942
- January 29, 2013, 5:00–8:00 p.m. at Beaver County Fairgrounds—Pavilion Building, 1107 Douglas Avenue, Beaver, OK 73932
- January 31, 2013, 5:00–8:00 p.m. at Woodward Convention Center—Meeting Room 1, 3401 Centennial Lane, Woodward, OK 73801
- February 4, 2013, 5:00–8:00 p.m. at Muskogee Civic Center Room D, 425 Boston Street, Muskogee, OK 74401
- February 5, 2013, 5:00–8:00 p.m. at Cushing Youth and Community Center, 700 South Little, Cushing, OK 74023
- February 7, 2013, 5:00–8:00 p.m. at Enid Convention Hall—Grand Ballroom, 301 South Independence, Enid, OK 73701
- February 11, 2013, 5:00–8:00 p.m. at Van Buren Public Library, 1409 Main Street, Van Buren, AR 72956
- February 12, 2013, 5:00–8:00 p.m. at Lake Point Conference Center—Event Center, 61 Lake Point Lane, Russellville, AR 72802
- February 19, 2013, 5:00–8:00 p.m. at Arkansas State University—Newport, Student Community Center—M&P I&I NEDC Room (First room on the left), 7648 Victory Boulevard, Newport, AR 72112
- February 21, 2013, 5:00–8:00 p.m. at Carmichael Community Center Auditorium, 801 S. Elm, Searcy, AR 72143

DOE will also announce the public scoping meetings via local news media, industry newsletters, and posting on the DOE NEPA Web site at <http://energy.gov/nepa/public-comment-opportunities> and on the Plains & Eastern EIS Web site at <http://PlainsandEasternEIS.com> at least 15 days prior to each meeting.

The scoping meetings will start with an informal open house to facilitate dialogue between project officials and the public. DOE will then provide an overview of the proposed project and lead a short, informal question-and-answer period to clarify the information presented and to answer questions about the NEPA process. The public will have an opportunity to view maps and project information and present

comments on the scope of the Plains & Eastern EIS. Representatives from DOE, Clean Line, and involved agencies will be available to answer questions and provide additional information to meeting attendees. A court reporter will be available at each scoping meeting to record oral comments from meeting attendees.

In addition to providing comments at the public scoping meetings, DOE will accept written comments as described in the **ADDRESSES** section. DOE will consider all comments postmarked or received during a 90-day public scoping period beginning with publication of this notice and ending on March 21, 2013. DOE will consider comments postmarked or received after that date to the extent practicable.

DOE expects to publish the draft EIS in the fall of 2013. The U.S. Environmental Protection Agency will publish a Notice of Availability of the draft EIS in the **Federal Register**, which will begin a minimum public comment period of 45 days. DOE will announce how to comment on the draft EIS and will hold public hearings during the public comment period. People who would like to receive a copy of the draft EIS when it is issued should submit a request as provided in the **ADDRESSES** section and specify their format preference.

Issued in Washington, DC, on December 14, 2012.

Patricia Hoffman.

Assistant Secretary for Electricity Delivery and Energy Reliability.

[FR Doc. 2012–30833 Filed 12–20–12; 8:45 am]

BILLING CODE 6450-01-P

DEPARTMENT OF ENERGY

Environmental Management Site-Specific Advisory Board, Portsmouth

AGENCY: Department of Energy (DOE).

ACTION: Notice of open meeting.

SUMMARY: This notice announces a meeting of the Environmental Management Site-Specific Advisory Board (EM SSAB), Portsmouth. The Federal Advisory Committee Act (Pub. L. 92–463, 86 Stat. 770) requires that public notice of this meeting be announced in the **Federal Register**.

DATES: Thursday, January 10, 2013, 6:00 p.m.

ADDRESSES: Ohio State University, Endeavor Center, 1862 Shyville Road, Piketon, Ohio 45661.

FOR FURTHER INFORMATION CONTACT: Greg Simonton, Alternate Deputy Designated Federal Officer, Department of Energy

Portsmouth/Paducah Project Office, Post Office Box 700, Piketon, Ohio 45661, (740) 897–3737, Greg.Simonton@lex.doe.gov.

SUPPLEMENTARY INFORMATION:

Purpose of the Board: The purpose of the Board is to make recommendations to DOE–EM and site management in the areas of environmental restoration, waste management and related activities.

Tentative Agenda

- Call to Order, Introductions, Review of Agenda
- Approval of November Minutes
- Deputy Designated Federal Officer's Comments
- Federal Coordinator's Comments
- Liaisons' Comments
- Presentations
- Administrative Issues
- Subcommittee Updates
- Public Comments
- Final Comments from the Board
- Adjourn

Public Participation: The meeting is open to the public. The EM SSAB, Portsmouth, welcomes the attendance of the public at its advisory committee meetings and will make every effort to accommodate persons with physical disabilities or special needs. If you require special accommodations due to a disability, please contact Greg Simonton at least seven days in advance of the meeting at the phone number listed above. Written statements may be filed with the Board either before or after the meeting. Individuals who wish to make oral statements pertaining to agenda items should contact Greg Simonton at the address or telephone number listed above. Requests must be received five days prior to the meeting and reasonable provision will be made to include the presentation in the agenda. The Deputy Designated Federal Officer is empowered to conduct the meeting in a fashion that will facilitate the orderly conduct of business. Individuals wishing to make public comments will be provided a maximum of five minutes to present their comments.

Minutes: Minutes will be available by writing or calling Greg Simonton at the address and phone number listed above. Minutes will also be available at the following Web site: <http://www.ports-sab.energy.gov/>.

Issued at Washington, DC, on December 17, 2012.

LaTanya R. Butler,

Deputy Committee Management Officer.

[FR Doc. 2012–30779 Filed 12–20–12; 8:45 am]

BILLING CODE 6450-01-P

The initial Department of Energy (DOE) notice of availability for this EIS (79 FR 75132, December 17, 2014; attached) incorrectly identified the close of the comment period as March 17, 2015. The correct date is March 19, 2015. DOE published a notice to correct the date (79 FR 78079, December 29, 2014; also attached).

Federal eRulemaking Portal at <http://www.regulations.gov> by selecting Docket ID number ED-2014-ICCD-0144 or via postal mail, commercial delivery, or hand delivery. If the regulations.gov site is not available to the public for any reason, ED will temporarily accept comments at ICDocketMgr@ed.gov. Please note that comments submitted by fax or email and those submitted after the comment period will not be accepted; ED will only accept comments during the comment period in this mailbox when the regulations.gov site is not available. Written requests for information or comments submitted by postal mail or delivery should be addressed to the Director of the Information Collection Clearance Division, U.S. Department of Education, 400 Maryland Avenue SW., LBJ, Mailstop L-OM-2-2E319, Room 2E105, Washington, DC 20202.

FOR FURTHER INFORMATION CONTACT: For specific questions related to collection activities, please contact Kashka Kubzdela 202-502-7411.

SUPPLEMENTARY INFORMATION: The Department of Education (ED), in accordance with the Paperwork Reduction Act of 1995 (PRA) (44 U.S.C. 3506(c)(2)(A)), provides the general public and Federal agencies with an opportunity to comment on proposed, revised, and continuing collections of information. This helps the Department assess the impact of its information collection requirements and minimize the public's reporting burden. It also helps the public understand the Department's information collection requirements and provide the requested data in the desired format. ED is soliciting comments on the proposed information collection request (ICR) that is described below. The Department of Education is especially interested in public comment addressing the following issues: (1) Is this collection necessary to the proper functions of the Department; (2) will this information be processed and used in a timely manner; (3) is the estimate of burden accurate; (4) how might the Department enhance the quality, utility, and clarity of the information to be collected; and (5) how might the Department minimize the burden of this collection on the respondents, including through the use of information technology. Please note that written comments received in response to this notice will be considered public records.

Title of Collection: Quick Response Information System (QRIS) 2015-2018 System Clearance.

OMB Control Number: 1850-0733.

Type of Review: An extension of an existing information collection.

Respondents/Affected Public: State, Local or Tribal Government.

Total Estimated Number of Annual Responses: 104,004.

Total Estimated Number of Annual Burden Hours: 31,704.

Abstract: The National Center for Education Statistics (NCES) Quick Response Information System (QRIS) consists of the Fast Response Survey System (FRSS) and the Postsecondary Education Quick Information System (PEQIS). The QRIS currently conducts surveys under OMB generic clearance 1850-0733, which expires in May 2015. This submission requests approval to continue the current clearance conditions through 2018. FRSS primarily conducts surveys of the elementary/secondary sector (districts, schools) and public libraries. PEQIS conducts surveys of the postsecondary education sector. FRSS and PEQIS surveys are cleared under the QRIS generic clearance. The QRIS clearance is subject to the regular clearance process at OMB with a 60-day notice and a 30-day notice as part of the 120-day review period. Each individual FRSS or PEQIS survey is then subject to clearance process with an abbreviated clearance package, justifying the particular content of the survey, describing the sample design, the timeline for the survey activities, and the questionnaire. The review period for each individual survey is 45 days, including a 30-day **Federal Register** notice period. OMB will provide comments as soon after the end of the 30-day notice period as possible. This generic clearance request is for surveys of surveys of state education agencies, school districts, schools, postsecondary institutions, and libraries.

Dated: December 12, 2014.

Stephanie Valentine,

Acting Director, Information Collection Clearance Division, Privacy, Information and Records Management Services, Office of Management.

[FR Doc. 2014-29559 Filed 12-16-14; 8:45 am]

BILLING CODE 4000-01-P

DEPARTMENT OF ENERGY

Plains & Eastern Clean Line Transmission Project Draft Environmental Impact Statement

AGENCY: Department of Energy.

ACTION: Notice of availability and public hearings.

SUMMARY: The U.S. Department of Energy (DOE) announces the availability

of the *Draft Environmental Impact Statement for the Plains & Eastern Clean Line Transmission Project* (DOE/EIS-0486; Draft EIS) for a 90-day public comment period. DOE also announces 15 public hearings to receive comments on the Draft EIS. In addition, DOE invites comments on the National Historic Preservation Act Section 106 process and any potential adverse impacts to historic properties from the proposed Project. Major facilities associated with the proposed Project include converter stations in Oklahoma and Tennessee; an approximately 720-mile high voltage direct current (HVDC) transmission line; an alternating current (AC) collection system; and access roads. This Draft EIS evaluates the potential environmental impacts of the proposed Project and alternatives to it.

DATES: DOE invites comments on this Draft EIS and on the National Historic Preservation Act Section 106 process and any potential adverse impacts to historic properties from the proposed Project and alternatives during a 90-day period, which ends on March 17, 2015. Comments submitted after the close of the comment period will be considered to the extent practicable. The Department will hold 15 public hearings at the locations, dates, and start times listed in **SUPPLEMENTARY INFORMATION** below.

ADDRESSES: Written comments on the Draft EIS may be provided on the EIS Web site at <http://www.plainsandeasterneis.com> (preferred) or addressed to: Plains & Eastern EIS, 216 16th Street, Suite 1500, Denver, Colorado 80202; via email to comments@PlainsandEasternEIS.com; or by facsimile to (303) 295-2818. Please mark envelopes and email subject lines as *Plains & Eastern Draft EIS Comments*. **FOR FURTHER INFORMATION CONTACT:** For information on the Plains & Eastern EIS or the Section 106 process, contact Jane Summerson, Ph.D., DOE NEPA Document Manager on behalf of the Office of Electricity Delivery and Energy Reliability, U.S. Department of Energy, NNSA, PO Box 391 Building 401, Kirtland Air Force Base East, Albuquerque, NM 87185; email at Jane.Summerson01@nnsa.doe.gov; or phone (505) 845-4091.

For general information regarding the DOE NEPA process, contact Carol Borgstrom, Director, Office of NEPA Policy and Compliance (GC-54), U.S. Department of Energy, 1000 Independence Avenue SW., Washington, DC 20585; or phone at (202) 586-4600; voicemail at (800) 472-2756; or email at askNEPA@hq.doe.gov. Additional information regarding DOE's

NEPA activities is available on the DOE NEPA Web site at <http://energy.gov/ nepa>.

SUPPLEMENTARY INFORMATION: In June 2010, DOE, acting through the Southwestern Power Administration and the Western Area Power Administration, both power marketing administrations within DOE, issued *Request for Proposals (RFP) for new or upgraded transmission line projects under Section 1222 of the Energy Policy Act of 2005* (75 FR 32940; June 10, 2010). In response to the RFP, Clean Line Energy Partners LLC of Houston, Texas, the parent company of Plains and Eastern Clean Line LLC and Plains and Eastern Clean Line Oklahoma LLC (collectively referred to as Clean Line or the Applicant) submitted a proposal to DOE in July 2010 for the Plains & Eastern Clean Line Project. In August 2011, Clean Line modified the proposal.

The Applicant Proposed Project would include an overhead ± 600-kilovolt (kV) HVDC electric transmission system and associated facilities with the capacity to deliver approximately 3,500 megawatts primarily from renewable energy generation facilities in the Oklahoma and Texas Panhandle regions to load-serving entities in the Mid-South and Southeast United States via an interconnection with the Tennessee Valley Authority (TVA) in Tennessee. Major facilities associated with the Applicant Proposed Project consist of converter stations in Oklahoma and Tennessee; an approximately 720-mile HVDC transmission line; an AC collection system; and access roads. Pursuant to NEPA, DOE has identified and analyzed potential environmental impacts for several alternatives in addition to the Applicant Proposed Project, including alternative routes for the HVDC transmission line and adding

a converter station in Arkansas (to deliver power to the Arkansas electrical grid).

DOE has prepared this Draft EIS in consultation with the following cooperating agencies: the Bureau of Indian Affairs, Natural Resources Conservation Service, TVA, U.S. Army Corps of Engineers, U.S. Environmental Protection Agency Regions 4 and 6, and the U.S. Fish and Wildlife Service. In the Draft EIS, DOE analyzes the potential environmental impacts of the Applicant Proposed Project, the range of reasonable alternatives, and a No Action Alternative. The potential environmental impacts resulting from connected actions (wind energy generation and substation and transmission upgrades related to the Project) are also analyzed in the Draft EIS.

DOE's purpose and need for agency action is to implement Section 1222 of the Energy Policy Act of 2005. To that end, DOE needs to decide whether and under what conditions it would participate in the Applicant Proposed Project. DOE has not identified a preference for whether to participate with Clean Line in the Project in some manner as prescribed by Section 1222. DOE will identify its preference for whether to participate with Clean Line in the Applicant Proposed Project and its preferred alternatives for each of the Project elements (including route alternatives) in the Final EIS after evaluating public comments and agency input received on the Draft EIS.

Public hearings. All public hearings will follow the same format. An open house will be held from 5:00 p.m.–5:45 p.m., during which DOE and its contractors will be available to answer questions in an informal setting. Clean Line personnel also will be available to answer technical questions regarding

the Project. The open house will be followed by a presentation at 5:45 p.m. by Dr. Summerson, DOE NEPA Document Manager, who will describe the Draft EIS, the NEPA and Section 106 processes, and the methods that can be used to submit comments. The formal public comment portion of the meeting will begin at 6:15 p.m. During this time, interested parties may present oral comments to DOE. A court reporter will transcribe the comments presented at each hearing. Individuals wishing to speak at a hearing should register when they arrive. DOE will initially allot three minutes to each commenter to ensure that as many people as possible have the opportunity to speak. More time may be provided, as circumstances permit. Written comments may be submitted at the hearing or by the other methods described in **ADDRESSES** above. It is DOE's practice to make comments, including names and addresses of respondents, available for public review. Before including your address, phone number, email address, or other personal identifying information with your comments, be advised that your entire comment, including your personal identifying information, may be made publicly available at any time. Although you may ask us in your comment to withhold your personal identifying information from public review, we cannot guarantee that we will be able to do so. All submissions from organizations and businesses, and from individuals identifying themselves as representatives or officials of organizations or businesses, will be available for public inspection in their entirety. DOE will give equal consideration to oral and written comments in preparing the Final EIS. The locations, dates, and starting times of the public hearings are listed in the table below:

Date and time	Location
Monday, January 26—5:00 pm	Woodward Convention Center, 3401 Centennial Lane, Woodward, OK 73801.
Tuesday, January 27—5:00 pm	Pickle Creek Center, 822 NE 6th Street, Guymon, OK 73942.
Wednesday, January 28—5:00 pm	Beaver County Fairgrounds, Pavilion Building, 1107 Douglas Avenue, Beaver, OK 73932.
Thursday, January 29—5:00 pm	Ochiltree County Exposition Center, 402 Expo Drive, Perryton, TX 79070.
Monday, February 2—5:00 pm	Muskogee Civic Center, Room D, 425 Boston Street, Muskogee, OK 74401.
Tuesday, February 3—5:00 pm	Cushing Youth and Community Center, 700 South Little, Cushing, OK 74023.
Wednesday, February 4—5:00 pm	The Wes Watkins Center, 207 Wes Watkins Center, Exhibit Hall 111/112, (Hall of Fame and Washington), Stillwater, OK 74078.
Thursday, February 5—5:00 pm	Enid Convention Hall, Nick Benson Memorial Ballroom, 301 South Independence, Enid, OK 73701.
Monday, February 9—5:00 pm	Arkansas State University-Newport, Student Community Center, 7648 Victory Boulevard, Newport, AR 72112.
Tuesday, February 10—5:00 pm	Carmichael Community Center Auditorium, 801 S. Elm, Searcy, AR 72143.
Wednesday, February 11—5:00 pm	Arkansas State University—Marked Tree Student Center, 33500 Highway 63 E, Marked Tree, AR 72365.
Thursday, February 12—5:00 pm	Harvell Civic Center Auditorium, 8077 Wilkinsville Rd., Millington, TN 38053.
Tuesday, February 17—5:00 pm	Lake Point Conference Center—Event Center, 61 Lake Point Lane, Russellville, AR 72802.

Date and time	Location
Wednesday, February 18—5:00 pm	Fort Smith Convention Center, Exhibit Hall A, 55 7th St, Fort Smith, AR 72901.
Thursday, February 19—5:00 pm	University of Arkansas Community College at Morrilton, Fine Arts Building Auditorium, 1537 University Blvd., Morrilton, AR 72110.

Availability of the Draft EIS. The Draft EIS is available on the EIS Web site at <http://www.plainsandeanernews.com> and on the DOE NEPA Web site at <http://nepa.energy.gov/>. A printed summary and CD of the complete document and, if preferred, a complete printed copy of the Draft EIS (approximately 3,700 pages), may be requested from info@PlainsandEasternEIS.com. Copies of the Draft EIS have been distributed to appropriate members of Congress, state and local government officials, American Indian tribal governments, and other federal agencies, groups, and interested parties. Copies of the complete Draft EIS and supporting documents are also available for inspection at the following locations:

Oklahoma

- Guymon Public Library—1718 N. Oklahoma St., Guymon, OK 73942
- Beaver County Pioneer Library—201 Douglas Ave., Beaver, OK 73932
- Woodward Public Library—1500 W. Main St., Woodward, OK 73801
- Muskogee Public Library—801 W. Okmulgee Ave., Muskogee, OK 74401
- Enid & Garfield County Public Library—120 W. Maine St., Enid, OK 73701
- Buffalo Public Library—11 E. Turner St., Buffalo, OK 73834
- Fairview City Library—115 S. 6th St., Fairview, OK 73737
- Guthrie Public Library—201 N. Division St., Guthrie, OK 73044
- Stillwater Public Library—1107 S. Duck St., Stillwater, OK 74955
- Chandler Public Library—1021 Manvel Ave., Chandler, OK 74834
- Montfort and Allie B. Jones Memorial Library—111 W. 7th Ave., Bristow, OK 74010
- Bartlett-Carnegie Sapulpa Public Library—27 W. Dewey Ave., Sapulpa, OK 74066
- Okmulgee Public Library—218 S. Okmulgee Ave., Okmulgee, OK 74447
- Stanley Tubbs Memorial Library—101 E. Cherokee Ave., Sallisaw, OK 74955

Arkansas

- Van Buren Public Library—1409 Main St., Van Buren, AR 72956
- Pope County Library—116 E. 3rd St., Russellville, AR 72801
- Jackson County/W.A. Billingsley Memorial Library—213 Walnut St., Newport, AR 72112

- Searcy Public Library—113 E. Pleasure Ave., Searcy, AR 72143
- Marked Tree Public Library—102 Locust St., Marked Tree, AR 72365
- Franklin County Library—120 S. 2nd St., Ozark, AR 72949
- Johnson County Library—2 Taylor Cir., Clarksville, AR 72830
- Conway County Library—101 W. Church St., Morrilton, AR 72110
- Conway Public Library—1900 W. Tyler St., Conway, AR 72034
- Mary I. Wold Cleburne County Library—1009 W. Main St., Heber Springs, AR 72543
- Poinsett County Library—200 N. East St., Harrisburg, AR 72432
- Blytheville Public Library—200 N. 5th St., Blytheville, AR 72315
- Osceola Public Library—320 W. Hale Ave., Osceola, AR 72370
- Cross County Library—410 E. Merriman Ave., Wynne, AR 72396

Tennessee

- Munford Memorial Library—1476 Munford Ave., Munford, TN 38058

Texas

- Hansford County Library—122 Main St., Spearman, TX 79081

Issued in Washington, DC, on December 11, 2014.

David S. Ortiz,

Deputy Assistant Secretary, Office of Electricity Delivery and Energy Reliability.

[FR Doc. 2014-29524 Filed 12-16-14; 8:45 am]

BILLING CODE 6450-01-P

DEPARTMENT OF ENERGY

Federal Energy Regulatory Commission

Combined Notice of Filings #1

Take notice that the Commission received the following electric corporate filings:

Docket Numbers: EC15-47-000.
Applicants: Entergy Gulf States Louisiana, L.L.C., Entergy Louisiana, LLC.

Description: Application of Entergy Gulf States Louisiana, L.L.C., and Entergy Louisiana, LLC, for FPA 203 Authorization.

Filed Date: 12/10/14.
Accession Number: 20141210-5199.
Comments Due: 5 p.m. ET 12/31/14.
Docket Numbers: EC15-48-000.

Applicants: Entergy Louisiana, LLC, Entergy New Orleans, Inc.

Description: Application of Entergy Louisiana, LLC and Entergy New Orleans, Inc., for FPA 203 Authorization.

Filed Date: 12/10/14.
Accession Number: 20141210-5201.
Comments Due: 5 p.m. ET 12/31/14.

Take notice that the Commission received the following electric rate filings:

Docket Numbers: ER14-2558-000.
Applicants: Puget Sound Energy, Inc.
Description: eTariff filing per 35.19a(b): Bellingham Cold Storage-Orchard NITSA No 709 Refund Report to be effective N/A.
Filed Date: 12/11/14.
Accession Number: 20141211-5149.
Comments Due: 5 p.m. ET 1/2/15.

Docket Numbers: ER14-2559-000.
Applicants: Puget Sound Energy, Inc.
Description: eTariff filing per 35.19a(b): Bellingham Cold Storage-Roeder NITSA No 706 Refund Report to be effective N/A.

Filed Date: 12/11/14.
Accession Number: 20141211-5148.
Comments Due: 5 p.m. ET 1/2/15.
Docket Numbers: ER14-2560-000.
Applicants: Puget Sound Energy, Inc.
Description: eTariff filing per 35.19a(b): Tesoro NITSA No 703 Refund Report to be effective N/A.

Filed Date: 12/11/14.
Accession Number: 20141211-5142.
Comments Due: 5 p.m. ET 1/2/15.
Docket Numbers: ER14-2850-002.
Applicants: Southwest Power Pool, Inc.

Description: Compliance filing per 35: Integrated System Open Access Transmission Tariff Revisions—Compliance Filing to be effective 10/1/2015.

Filed Date: 12/10/14.
Accession Number: 20141210-5157.
Comments Due: 5 p.m. ET 12/31/14.
Docket Numbers: ER14-2851-002.
Applicants: Southwest Power Pool, Inc.

Description: Compliance filing per 35: Integrated System Membership Agreement Amendments—Compliance Filing to be effective 11/10/2014.

Filed Date: 12/10/14.
Accession Number: 20141210-5155.
Comments Due: 5 p.m. ET 12/31/14.
Docket Numbers: ER15-522-001.

In addition, in making a competitive grant award, the Secretary also requires various assurances including those applicable to Federal civil rights laws that prohibit discrimination in programs or activities receiving Federal financial assistance from the Department of Education (34 CFR 100.4, 104.5, 106.4, 108.8, and 110.23).

3. *Special Conditions:* Under current 34 CFR 74.14 and, when grants are made under this NIA, 2 CFR 3474.10, the Secretary may impose special conditions and, in appropriate circumstances, high-risk conditions on a grant if the applicant or grantee is not financially stable; has a history of unsatisfactory performance; has a financial or other management system that does not meet the standards in 34 CFR part 74, as applicable or, when grants are awarded, the standards in 2 CFR 200, subpart D; has not fulfilled the conditions of a prior grant; or is otherwise not responsible.

VI. Award Administration Information

1. *Award Notices:* If your application is successful, we notify your U.S. Representative and U.S. Senators and send you a Grant Award Notification (GAN); or we may send you an email containing a link to access an electronic version of your GAN. We may notify you informally, also.

If your application is not evaluated or not selected for funding, we notify you.

2. *Administrative and National Policy Requirements:* We identify administrative and national policy requirements in the application package and reference these and other requirements in the *Applicable Regulations* section of this notice.

We reference the regulations outlining the terms and conditions of an award in the *Applicable Regulations* section of this notice and include these and other specific conditions in the GAN. The GAN also incorporates your approved application as part of your binding commitments under the grant.

3. *Reporting:* (a) If you apply for a grant under this competition, you must ensure that you have in place the necessary processes and systems to comply with the reporting requirements in 2 CFR part 170 should you receive funding under the competition. This does not apply if you have an exception under 2 CFR 170.110(b).

(b) At the end of your project period, you must submit a final performance report, including financial information, as directed by the Secretary. If you receive a multi-year award, you must submit an annual performance report that provides the most current performance and financial expenditure

information as directed by the Secretary under 34 CFR 75.118. The Secretary may also require more frequent performance reports under 34 CFR 75.720(c). For specific requirements on reporting, please go to www.ed.gov/fund/grant/apply/appforms/appforms.html.

4. *Performance Measures:* Under the Government Performance and Results Act of 1993 (GPRA), the Department developed the following performance measures to evaluate the overall effectiveness of CAMP: (1) the percentage of CAMP participants completing the first academic year of their postsecondary program, and (2) the percentage of CAMP participants who, after completing the first academic year of college, continue their postsecondary education.

Applicants must propose annual targets for these measures in their applications. The national target for GPRA measure 1 for FY 2015 is that 86 percent of CAMP participants will complete the first academic year of their postsecondary program. The national target for GPRA measure 2 for FY 2015 is that 85 percent of CAMP participants continue their postsecondary education after completing the first academic year of college. The national targets for subsequent years may be adjusted based on additional baseline data. The panel readers will score related selection criteria on the basis of how well an applicant addresses these GPRA measures. Therefore, applicants will want to consider how to demonstrate a sound capacity to provide reliable data on GPRA measures, including the project's annual performance targets for addressing the GPRA performance measures, as is required by the Office of Management and Budget approved annual performance report that is included in the application package. All grantees will be required to submit, as part of their annual performance report, information with respect to these GPRA performance measures.

5. *Continuation Awards:* In making a continuation award under 34 CFR 75.253, the Secretary considers, among other things: Whether a grantee has made substantial progress in achieving the goals and objectives of the project; whether the grantee has expended funds in a manner that is consistent with its approved application and budget; and, if the Secretary has established performance measurement requirements, the performance targets in the grantee's approved application. In making a continuation grant, the Secretary also considers whether the grantee is operating in compliance with the assurances in its approved

application, including those applicable to Federal civil rights laws that prohibit discrimination in programs or activities receiving Federal financial assistance from the Department (34 CFR 100.4, 104.5, 106.4, 108.8, and 110.23).

VII. Agency Contact

FOR FURTHER INFORMATION CONTACT: Nathan Weiss, U.S. Department of Education, Office of Migrant Education, 400 Maryland Avenue SW., room 3E321, Washington, DC 20202-6135. Telephone Number: (202) 260-7496, or by email: nathan.weiss@ed.gov.

If you use a TDD or a TTY, call the FRS, toll free, at 1-800-877-8339.

VIII. Other Information

Accessible Format: Individuals with disabilities can obtain this document and a copy of the application package in an accessible format (e.g., braille, large print, audiotape, or compact disc) on request to the program contact person listed under **FOR FURTHER INFORMATION CONTACT** in section VII of this notice.

Electronic Access to This Document: The official version of this document is the document published in the **Federal Register**. Free Internet access to the official edition of the **Federal Register** and the Code of Federal Regulations is available via the Federal Digital System at: www.gpo.gov/fdsys. At this site you can view this document, as well as all other documents of this Department published in the **Federal Register**, in text or Adobe Portable Document Format (PDF). To use PDF you must have Adobe Acrobat Reader, which is available free at the site.

You may also access documents of the Department published in the **Federal Register** by using the article search feature at: www.federalregister.gov. Specifically, through the advanced search feature at this site, you can limit your search to documents published by the Department.

Dated: December 18, 2014.

Deborah S. Delisle,

Assistant Secretary for Elementary and Secondary Education.

[FR Doc. 2014-30210 Filed 12-24-14; 8:45 am]

BILLING CODE 4000-01-P

DEPARTMENT OF ENERGY

Plains & Eastern Clean Line Transmission Project Draft Environmental Impact Statement Notice of Availability and Public Hearings; Correction

AGENCY: Office of Electricity Delivery and Energy Reliability, Department of Energy.

ACTION: Correction.

SUMMARY: On December 17, 2014, the U.S. Department of Energy (DOE) published a notice of availability in the **Federal Register** of the *Draft Environmental Impact Statement for the Plains & Eastern Clean Line Transmission Project* (DOE/EIS-0486; Draft EIS). This notice corrects the date of the public comment period.

FOR FURTHER INFORMATION CONTACT: Jane Summerson, Ph.D., DOE NEPA Document Manager on behalf of the Office of Electricity Delivery and Energy Reliability, U.S. Department of Energy, NNSA, PO Box 391 Building 401, Kirtland Air Force Base East, Albuquerque, NM 87185; email at Jane.Summerson01@nnsa.doe.gov; or phone (505) 845-4091.

Correction

In the **Federal Register** dated December 17, 2014 in FR Doc. 2014-29524, please make the following corrections on page 75132:

The end of the first sentence in the **DATES** section, is corrected by removing “which ends on March 17, 2015” and adding “which begins on December 19, 2014, and ends on March 19, 2015” in its place.

Issued in Washington, DC on December 19, 2014.

Patricia A. Hoffman,

Assistant Secretary Office of Electricity Delivery and Energy Reliability.

[FR Doc. 2014-30393 Filed 12-24-14; 8:45 am]

BILLING CODE 6450-01-P

DEPARTMENT OF ENERGY**Federal Energy Regulatory Commission****Combined Notice Of Filings #1**

Take notice that the Commission received the following electric rate filings:

Docket Numbers: ER14-2325-000.
Applicants: Mosaic Fertilizer, LLC.
Description: eTariff filing per 35.19a(b); Mosaic Refund Report to be effective N/A.

Filed Date: 12/19/14.

Accession Number: 20141219-5107.
Comments Due: 5 p.m. ET 1/9/15.

Docket Numbers: ER14-2666-002.
Applicants: Avalon Solar Partners, LLC.

Description: Notice of Non-Material Change in Status of Avalon Solar Partners, LLC.

Filed Date: 12/19/14.

Accession Number: 20141219-5080.
Comments Due: 5 p.m. ET 1/9/15.

Docket Numbers: ER14-2666-002.
Applicants: Avalon Solar Partners, LLC.

Description: Errata [Appendix B] to December 19, 2014 Notice of Non-Material Change in Status of Avalon Solar Partners, LLC.

Filed Date: 12/19/14.

Accession Number: 20141219-5135.
Comments Due: 5 p.m. ET 1/9/15.

Docket Numbers: ER14-2937-000.
Applicants: American Transmission Systems, Incorporated, PJM Interconnection, L.L.C.

Description: eTariff filing per 35.19a(b); ATSI submits Refund Report under Docket No. ER14-2937 to be effective N/A.

Filed Date: 12/18/14.

Accession Number: 20141218-5317.
Comments Due: 5 p.m. ET 1/8/15.

Docket Numbers: ER14-2940-001.
Applicants: PJM Interconnection, L.L.C.

Description: Compliance filing per 35: Compliance Filing per 11/28/2014 Order in Docket No. ER14-2940-000 to be effective 12/1/2014.

Filed Date: 12/19/14.

Accession Number: 20141219-5145.
Comments Due: 5 p.m. ET 1/9/15.

Docket Numbers: ER14-2956-002.
Applicants: Hoopeston Wind, LLC.
Description: Tariff Amendment per 35.17(b); Hoopeston MBRA Amendment to be effective 12/18/2014.

Filed Date: 12/19/14.

Accession Number: 20141219-5001.
Comments Due: 5 p.m. ET 12/29/14.

Docket Numbers: ER15-618-001.
Applicants: PJM Interconnection, L.L.C., Virginia Electric and Power Company.

Description: Tariff Amendment per 35.17(b); Dominion Errata Filing to Resubmit Amended Service Agreement No. 3453 to be effective 12/12/2014.

Filed Date: 12/19/14.

Accession Number: 20141219-5147.
Comments Due: 5 p.m. ET 1/9/15.

Docket Numbers: ER15-660-000.
Applicants: PJM Interconnection, L.L.C.

Description: Tariff Withdrawal per 35.15: Notice of Cancellation of Original Service Agreement No. 3528; Queue No. X3-041 to be effective 12/19/2014.

Filed Date: 12/19/14.

Accession Number: 20141219-5082.
Comments Due: 5 p.m. ET 1/9/15.

Docket Numbers: ER15-661-000.
Applicants: Public Service Company of Oklahoma.

Description: § 205(d) rate filing per 35.13(a)(2)(iii); PSO-OMPA Marlow Delivery Point Agreement to be effective 12/4/2014.

Filed Date: 12/19/14.

Accession Number: 20141219-5093.
Comments Due: 5 p.m. ET 1/9/15.

Docket Numbers: ER15-662-000.
Applicants: PJM Interconnection, L.L.C.

Description: Tariff Withdrawal per 35.15: Notice of Cancellation of Service Agreement No. 3588 to be effective 1/2/2015.

Filed Date: 12/19/14.

Accession Number: 20141219-5096.
Comments Due: 5 p.m. ET 1/9/15.

Docket Numbers: ER15-663-000.
Applicants: AEP Generation Resources Inc.

Description: § 205(d) rate filing per 35.13(a)(2)(iii); Ohio Power Supply Agreement Amd Reflecting State Commission Mandated Updates to be effective 1/1/2015.

Filed Date: 12/19/14.

Accession Number: 20141219-5111.
Comments Due: 5 p.m. ET 1/9/15.

Docket Numbers: ER15-664-000.
Applicants: PacifiCorp.
Description: § 205(d) rate filing per 35.13(a)(2)(iii); Certificate of Concurrence to be effective 1/1/2015.

Filed Date: 12/19/14.

Accession Number: 20141219-5158.
Comments Due: 5 p.m. ET 1/9/15.

Docket Numbers: ER15-665-000.
Applicants: AP Holdings, LLC.
Description: § 205(d) rate filing per 35.13(a)(2)(iii); AP Holdings—Seller Category Filing to be effective 2/17/2015.

Filed Date: 12/19/14.

Accession Number: 20141219-5192.
Comments Due: 5 p.m. ET 1/9/15.

Docket Numbers: ER15-666-000.
Applicants: AP Gas & Electric (PA), LLC.

Description: § 205(d) rate filing per 35.13(a)(2)(iii); AP-PA—Seller Category Filing to be effective 2/17/2015.

Filed Date: 12/19/14.

Accession Number: 20141219-5193.
Comments Due: 5 p.m. ET 1/9/15.

Docket Numbers: ER15-667-000.
Applicants: AP Gas & Electric (MD), LLC.

Description: § 205(d) rate filing per 35.13(a)(2)(iii); AP-MD—Seller Category Filing to be effective 2/17/2015.

Filed Date: 12/19/14.

Accession Number: 20141219-5194.
Comments Due: 5 p.m. ET 1/9/15.

Docket Numbers: ER15-668-000.
Applicants: AP Gas & Electric (NJ), LLC.

Description: § 205(d) rate filing per 35.13(a)(2)(iii); AP-NJ Seller Category Filing to be effective 2/17/2015.

Filed Date: 12/19/14.

Accession Number: 20141219-5195.

of secure test items would significantly impede implementation of the NAEP assessment program if conducted in open session. Such matters are protected by exemption 9(B) of § 552b of Title 5 U.S.C.

Following the Committee meetings, the Board will convene in closed session from 12:45 p.m. to 1:45 p.m. to receive a briefing and discuss the NAEP 2012 grade 8 civics, geography, and U.S. history report cards. This part of the meeting must be conducted in closed session because results of these NAEP assessments have been embargoed and are not ready for public release. Public disclosure of this information would likely have an adverse technical and financial impact on the NAEP program. Discussion of this information would be likely to significantly impede implementation of a proposed agency action if conducted in open session. Such matters are protected by exemption 9(B) of § 552b of Title 5 U.S.C.

On March 6, 2015 from 2:00 p.m. to 3:30 p.m., the Board will meet in open session to receive a briefing and discuss the NAEP Assessment of English Language Learners.

Thereafter, the Board will meet in closed session from 3:45 p.m. to 4:45 p.m. to review and discuss independent government costs estimates for subjects to be assessed under the proposed NAEP Schedule of Assessments. This session will be an in-depth briefing and discussion to examine specific costs for assessing NAEP subjects, including cost projections for moving NAEP to digital-based assessments, which will impact the NAEP schedule from 2016–2024. This part of the meeting must be conducted in closed session because public disclosure of this information would likely have an adverse financial effect on the NAEP program by providing contractors attending the Board meeting an unfair advantage in procurement and contract negotiations for NAEP. Discussion of this information would be likely to significantly impede implementation of a proposed agency action if conducted in open session. Such matters are protected by exemption 9(B) of § 552b of Title 5 U.S.C.

Following this closed session, from 4:45 p.m. to 5:00 p.m., the Board will meet in open session to take action on the NAEP Schedule of Assessments. The March 6, 2015 session will adjourn at 5:00 p.m.

On March 7, 2015, the Nominations Committee will meet in closed session from 7:30 a.m. to 8:15 a.m. to discuss candidates for the eight Board vacancies for terms beginning on October 1, 2015.

The Committee's discussions pertain solely to internal personnel rules and practices of an agency and information of a personal nature where disclosure would constitute an unwarranted invasion of personal privacy. As such, the discussions are protected by exemptions 2 and 6 of § 552b(c) of Title 5 of the United States Code.

On March 7, 2015, the Board will meet in closed session from 8:30 a.m. to 8:50 a.m. to receive a briefing from the Nominations Committee on proposed candidates for Board vacancies for the October 1, 2015 Board term. These discussions pertain solely to internal personnel rules and practices of an agency and information of a personal nature where disclosure would constitute an unwarranted invasion of personal privacy. As such, the discussions are protected by exemptions 2 and 6 of § 552b(c) of Title 5 of the United States Code.

From 8:50 a.m. to 9:00 a.m., the Board will take action on the proposed 2015 slate of finalists for the eight Board positions.

From 9:15 a.m. to 10:30 a.m., the Board will discuss a strategic planning initiative in open session. Following this session, from 10:45 a.m. to 12:00 p.m. the Board will receive reports from the standing committees and the Assessment Literacy Work Group. The Board will take action on committee recommendations to include action on a proposed release plan for the 2014 NAEP Report Cards in civics, geography, and U.S. history.

From 11:45 a.m. to 12:00 p.m., the Board will preview plans for the upcoming May 2015 quarterly Board meeting. The March 7, 2015 meeting is scheduled to adjourn at 12:00 p.m.

Access to Records of the Meeting: Pursuant to FOIA requirements, the public may also inspect the meeting materials at www.nagb.gov on Friday, March 6, 2015 by 9:00 a.m. ET. The official verbatim transcripts of the public meeting sessions will be available for public inspection no later than 30 calendar days following the meeting.

Reasonable Accommodations: The meeting site is accessible to individuals with disabilities. If you will need an auxiliary aid or service to participate in the meeting (e.g., interpreting service, assistive listening device, or materials in an alternate format), notify the contact person listed in this notice at least two weeks before the scheduled meeting date. Although we will attempt to meet a request received after that date, we may not be able to make available the requested auxiliary aid or service

because of insufficient time to arrange it.

Electronic Access to This Document: The official version of this document is the document published in the **Federal Register**. Free Internet access to the official edition of the **Federal Register** and the Code of Federal Regulations is available via the Federal Digital System at: www.gpo.gov/fdsys. At this site you can view this document, as well as all other documents of this Department published in the **Federal Register**, in text or Adobe Portable Document Format (PDF). To use PDF, you must have Adobe Acrobat Reader, which is available free at the site.

You may also access documents of the Department published in the **Federal Register** by using the article search feature at: www.federalregister.gov. Specifically, through the advanced search feature at this site, you can limit your search to documents published by the Department.

Authority: Public Law 107–279, Title III—National Assessment of Educational Progress § 301.

Dated: February 9, 2015.

Munira Mwalimu,

Executive Officer, National Assessment Governing Board (NAGB), U.S. Department of Education.

[FR Doc. 2015–02969 Filed 2–11–15; 8:45 am]

BILLING CODE P

DEPARTMENT OF ENERGY

Extension of Public Comment Period, Draft Environmental Impact Statement for the Plains & Eastern Clean Line Transmission Project

AGENCY: Department of Energy.

ACTION: Extension of public comment period.

SUMMARY: The U.S. Department of Energy (DOE) published a notice of availability and public hearing on December 17, 2014 and a correction on December 29, 2014 that provided for a comment period ending March 19, 2015. DOE is extending the public comment period for the *Draft Environmental Impact Statement for the Plains & Eastern Clean Line Transmission Project* (DOE/EIS–0486) to April 20, 2015.

DATES: DOE extends the public comment period to April 20, 2015. Comments submitted to DOE concerning the Plains & Eastern EIS prior to this announcement do not need to be resubmitted as a result of this extension of the comment period.

ADDRESSES: Written comments on the Draft EIS may be provided on the EIS

Web site at <http://www.plainsand.easterneis.com> (preferred) or addressed to Plains & Eastern EIS, 216 16th Street, Suite 1500, Denver, Colorado 80202; via email to comments@PlainsandEasternEIS.com; or by

facsimile to (303) 295-2818. Please mark envelopes and email subject lines as *Plains & Eastern Draft EIS Comments*.

FOR FURTHER INFORMATION CONTACT: Jane Summerson, Ph.D., DOE NEPA Document Manager on behalf of the Office of Electricity Delivery and Energy Reliability, U.S. Department of Energy, NNSA, PO Box 391 Building 401, Kirtland Air Force Base East, Albuquerque, NM 87185; email at Jane.Summerson01@nnsa.doe.gov; or phone (505) 845-4091.

SUPPLEMENTARY INFORMATION: On December 17, 2014, DOE published a notice of availability and public hearing (79 FR 75132) and on December 29, 2014, DOE published a correction (79 FR 78079) that announced that comments on the Plains & Eastern EIS should be submitted within a 90-day period beginning on December 19, 2014 and ending on March 19, 2015. DOE is extending the time allowed for submittal of comments to April 20, 2015.

Issued in Washington, DC, on February 6, 2015.

Patricia A. Hoffman,

Principal Deputy Assistant Secretary, Office of Electricity Delivery and Energy Reliability.

[FR Doc. 2015-02947 Filed 2-11-15; 8:45 am]

BILLING CODE 6450-01-P

DEPARTMENT OF ENERGY

Office of Energy Efficiency and Renewable Energy

[Case No. RF-042]

Decision and Order Granting a Waiver to GE Appliances From the Department of Energy Residential Refrigerator and Refrigerator-Freezer Test Procedures

AGENCY: Office of Energy Efficiency and Renewable Energy, Department of Energy.

ACTION: Decision and order.

SUMMARY: The U.S. Department of Energy (DOE) gives notice of the decision and order in Case No. RF-042 that grants to GE Appliances (GE) a waiver from the DOE electric refrigerator and refrigerator-freezer test procedures for determining the energy consumption of the specific residential refrigerator-freezer basic models set forth in GE's petition for waiver. Under today's decision and order, GE shall be

required to test and rate these refrigerator-freezer basic models, which use dual compressors, using an alternate test procedure that takes this technology into account when measuring energy consumption.

DATES: This Decision and Order is effective February 12, 2015.

FOR FURTHER INFORMATION CONTACT: Mr. Bryan Berringer, U.S. Department of Energy, Building Technologies Program, Mail Stop EE-5B, Forrestal Building, 1000 Independence Avenue SW., Washington, DC 20585-0121. Telephone: (202) 586-0371. Email: Bryan.Berringer@ee.doe.gov.

Mr. Michael Kido, U.S. Department of Energy, Office of the General Counsel, Mail Stop GC-33, Forrestal Building, 1000 Independence Avenue SW., Washington, DC 20585-0103. Telephone: (202) 586-8145. Email: Michael.Kido@hq.doe.gov.

SUPPLEMENTARY INFORMATION: DOE gives notice of the issuance of its decision and order as set forth below. The decision and order grants GE a waiver from the applicable residential refrigerator and refrigerator-freezer test procedures found in 10 CFR part 430, subpart B, appendix A for certain basic models of refrigerator-freezers with dual compressors, provided that GE tests and rates such products using the alternate test procedure described in this notice. Today's decision prohibits GE from making representations concerning the energy efficiency of these products unless the product has been tested in a manner consistent with the provisions and restrictions in the alternate test procedure set forth in the decision and order below, and the representations fairly disclose the test results.

Distributors, retailers, and private labelers are held to the same standard when making representations regarding the energy efficiency of these products.

Issued in Washington, DC, on February 6, 2015.

Kathleen B. Hogan,

Deputy Assistant Secretary for Energy Efficiency, Energy Efficiency and Renewable Energy.

Decision and Order

In the Matter of: GE Appliances (Case No. RF-042)

I. Background and Authority

Title III, Part B of the Energy Policy and Conservation Act of 1975 (EPCA), Pub. L. 94-163 (42 U.S.C. 6291-6309, as codified) established the Energy Conservation Program for Consumer Products Other Than Automobiles, a program covering most major household appliances, which includes the

residential electric refrigerators and refrigerator-freezers that are the focus of this notice.¹ Part B includes definitions, test procedures, labeling provisions, energy conservation standards, and the authority to require information and reports from manufacturers. Further, Part B authorizes the Secretary of Energy to prescribe test procedures that are reasonably designed to produce results measuring energy efficiency, energy use, or estimated operating costs, and that are not unduly burdensome to conduct. (42 U.S.C. 6293(b)(3)) The test procedure for residential electric refrigerators and refrigerator-freezers is set forth in 10 CFR part 430, subpart B, appendix A.

The regulations set forth in 10 CFR 430.27 contain provisions that enable a person to seek a waiver from the test procedure requirements for covered products. DOE will grant a waiver if it is determined that the basic model for which the petition for waiver was submitted contains one or more design characteristics that prevents testing of the basic model according to the prescribed test procedures, or if the prescribed test procedures may evaluate the basic model in a manner so unrepresentative of its true energy consumption characteristics as to provide materially inaccurate comparative data. 10 CFR 430.27(f)(2). Petitioners must include in their petition any alternate test procedures known to the petitioner to evaluate the basic model in a manner representative of its energy consumption. The Assistant Secretary may grant the waiver subject to conditions, including adherence to alternate test procedures. 10 CFR 430.27(f)(2). Waivers remain in effect pursuant to the provisions of 10 CFR 430.27(l).

DOE also may grant a petitioning manufacturer with an interim waiver from the test procedure requirements when such relief is sought. 10 CFR 430.27(e)(2). Within one year of issuance of an interim waiver, DOE will either: (i) Publish in the **Federal Register** a determination on the petition for waiver; or (ii) publish in the **Federal Register** a new or amended test procedure that addresses the issues presented in the waiver. 10 CFR 430.27(h)(1). When DOE amends the test procedure to address the issues presented in a waiver, the waiver will automatically terminate on the date on which use of that test procedure is required to demonstrate compliance. 10 CFR 430.27(h)(2).

¹ For editorial reasons, upon codification in the U.S. Code, Part B was re-designated Part A.

APPENDIX E

SCOPING SUMMARY REPORT



This page intentionally left blank.

Plains & Eastern Project

Scoping Summary Report

Prepared for the Environmental Impact Statement for the
Plains & Eastern Clean Line Transmission Project

Final

June 2013

Prepared for:



U.S. Department of Energy, 1000 Independence Ave. SW, Washington, DC 20585

Prepared by:



1099 18th St., Suite 580, Denver, CO 80202

Contents

	Page
1. Introduction.....	1
1.1 Project Description.....	1
1.2 Purpose of the Project.....	2
1.3 Purpose of the Scoping Summary Report.....	2
2. Scoping Process	3
2.1 Notice of Scoping Process.....	3
2.1.1 NOI.....	3
2.1.2 Media Announcements.....	3
2.1.3 Direct Mail Postcards.....	3
2.1.4 EIS Website.....	4
2.2 Scoping Meetings.....	4
2.3 Scoping Meeting Materials.....	5
3. Agency and Tribal Consultations.....	5
3.1 Tribal and Agency Letters.....	5
3.1.1 Cooperating Agencies.....	7
3.1.2 Consulting and Commenting Tribes and Agencies.....	7
3.2 Tribe and Agency Meetings.....	8
3.2.1 Tribe and Agency Meeting Materials.....	8
3.2.2 Tribe and Agency Meeting Attendance.....	8
3.3 Section 106 Consultation.....	8
4. Scoping Comments.....	9
4.1 Comment Submittal.....	9
4.2 Summary of Comments.....	9
4.2.1 Purpose and Need.....	10
4.2.2 Alternatives.....	10
4.2.3 Resource Areas.....	15
4.2.4 NEPA Process and Section 1222 of EPAct.....	19
4.2.5 Connected Actions.....	19
4.2.6 Cumulative Impacts.....	19
4.2.7 Mitigation.....	20
4.2.8 Petitions.....	20
5. Project Status/Next Steps.....	20

Tables

Table 2-1:	Plains & Eastern EIS Scoping Meetings	4
Table 3-1:	Agencies Contacted	6
Table 3-2:	Tribes Contacted.....	6
Table 3-3:	Plains & Eastern EIS Cooperating Agencies.....	7
Table 3-4:	Plains & Eastern EIS Agency Scoping Meetings	8
Table 4-1:	Number and Type of Scoping Documents	9
Table 4-2:	Oklahoma Route Segment-Specific Scoping Comments	11
Table 4-3:	Oklahoma/Arkansas Route Segment-Specific Scoping Comments	12
Table 4-4:	Arkansas Route Segment-Specific Scoping Comments	13
Table 4-5:	Tennessee Route Segment-Specific Scoping Comments.....	14

Appendices

Appendix A:	Notice of Intent
Appendix B:	Public Meeting Newspaper Notices
Appendix C:	Postcards and Email Announcements
Appendix D:	Public Scoping Meeting Materials
Appendix E:	Public Scoping Comment Form

List of Acronyms and Abbreviations

AC	Alternating Current
BMP	Best Management Practice
CEQ	Council On Environmental Quality
CFR	Code of Federal Regulations
Clean Line	Plains and Eastern Clean Line LLC
CRP	Conservation Reserve Program
DC	Direct Current
DOE	U.S. Department of Energy
EIS	Environmental Impact Statement
EMF	Electromagnetic Field
EPAct	Energy Policy Act of 2005
GPS	Global Positioning System
HVDC	High Voltage Direct Current
kV	Kilovolt
MW	Megawatt
NEPA	National Environmental Policy Act of 1969
NHPA	National Historic Preservation Act
NOI	Notice of Intent
OG&E	Oklahoma Gas & Electric
RFP	Request for Proposal
ROW	Right-of-Way
SH	State Highway
Southwestern	Southwestern Power Administration
USACE	U.S. Army Corps of Engineers
WRP	Wetland Reserve Program

This page intentionally left blank.

1. Introduction

This report describes the public scoping process for the Environmental Impact Statement (EIS) that the U.S. Department of Energy (DOE) is preparing for the Plains & Eastern Clean Line Transmission Project (DOE/EIS-0486; proposed Project) pursuant to the National Environmental Policy Act (NEPA). According to Council on Environmental Quality (CEQ) regulations, scoping is an open and early process required to determine the scope of issues to be addressed in the EIS and to identify significant issues related to the proposed action (see 40 CFR 1501.7). This report describes the manner in which the DOE notified the public about the scoping process, held scoping meetings, and solicited comments, and includes a summary of scoping comments.

Cooperating agencies for the EIS include the Bureau of Indian Affairs, Natural Resources Conservation Service, U.S. Army Corps of Engineers, U.S. Environmental Protection Agency, U.S. Fish and Wildlife Service, and Tennessee Valley Authority. The role of cooperating agencies is discussed in further detail in Section 3.1.1.

1.1 Project Description

The proposed Project, as described in the Notice of Intent (NOI) and as a basis for scoping comments, would include an overhead \pm 600-kilovolt (kV) high voltage direct current (HVDC) electric transmission system with the capacity to deliver approximately 3,500 megawatts (MW) from the Oklahoma Panhandle region to load-serving entities in the Mid-South and Southeast. The proposed Project would traverse Oklahoma, Arkansas, and Tennessee, a distance of approximately 700 miles. The western portion of the proposed Project would interconnect to the transmission system operated by the Southwest Power Pool in Texas County, Oklahoma. The eastern portion of the proposed Project would interconnect to the transmission system operated by the Tennessee Valley Authority in Shelby County, Tennessee.

A new alternating current (AC)/direct current (DC) converter station would be built at each end of the transmission line. Each converter station would require the use of approximately 30 to 50 acres and would be located on private land. The converter stations are proposed to be located in Texas County, Oklahoma, and either Shelby County or Tipton County, Tennessee. The proposed Project would include, in addition to the HVDC transmission line, four to six AC transmission lines of up to 345kV interconnecting the western converter station with new wind generation facilities that would be located in parts of the Oklahoma Panhandle, southwest Kansas, and Texas Panhandle within approximately 40 miles of the western converter station. Plains and Eastern Clean Line LLC (Clean Line) anticipates that electricity generated by these facilities would constitute the majority of the transmission capacity of the transmission line.

The proposed Project would also include the following major facilities and improvements:

- Right-of-way (ROW) easements for the transmission line with a typical width of approximately 150 to 200 feet for the HVDC line and potentially narrower for the AC transmission lines.
- Tubular or lattice steel structures used to support the transmission lines. For the HVDC line, structures typically would be between 120 and 200 feet tall depending on site-specific conditions. Limited

quantities of taller structures may be required in some locations to address engineering constraints. Structures for the AC transmission lines may be shorter.

- Access roads, including improvements to existing roads, new overland access, and new unpaved temporary roads to access the proposed Project facilities and work areas during the construction and operation phases.
- Ancillary facilities, such as communications facilities for access control and protection.

Clean Line identified the proposed location for the western converter station based on the presence of both an excellent wind resource (as classified by the DOE National Renewable Energy Laboratory) and adequate electrical interconnection facilities, including planned upgrades to existing facilities. Clean Line identified the proposed location for the eastern converter station based on the presence of high-voltage transmission facilities capable of interconnection and delivery of up to 3,500MW of energy to portions of the Mid-South and Southeast.

Details of the proposed Project and the network of potential routes are described in Sections 2.2 and 2.3.¹ Additionally, the EIS website (<http://plainsandeasterneis.com/>), discussed in further detail in Section 2.1.4, includes an interactive map of the network of potential routes that were available for review and comment during the public scoping period.

1.2 Purpose of the Project

DOE's purpose and need for agency action is to implement Section 1222(b) of the Energy Policy Act of 2005 (EPAAct). Section 1222(b) of the EPAAct authorizes the Secretary of Energy, acting through the Southwestern Power Administration (Southwestern), to participate with other entities in designing, developing, constructing, operating, maintaining, or owning new electric power transmission facilities and related facilities located within any state in which Southwestern operates provided the Secretary, in consultation with the Administrator of Southwestern, determines that certain conditions, which are described in Section 1222(b), have been met. Southwestern is one of four Power Marketing Administrations that operates within DOE. Pursuant to EPAAct Section 1222, on June 10, 2010, DOE issued a request for proposals (RFP) for upgrades of existing transmission lines or the construction of new transmission lines within the states where Southwestern operates (75 FR 32940). Clean Line responded to DOE's RFP by proposing the Plains & Eastern Project. Under EPAAct Section 1222, DOE needs to decide that the conditions described in Section 1222(b) have been satisfied and whether and under what conditions to participate in Clean Line's proposed Plains & Eastern Project.

1.3 Purpose of the Scoping Summary Report

The purpose of public scoping is to determine the scope of issues to be addressed in the EIS and to identify significant issues related to the proposed action. These issues include the impacts of and alternatives to the proposed action.

The purpose of the Scoping Summary Report is to describe the scoping process that DOE used to fulfill its obligation to conduct environmental review under NEPA in accordance with federal agency policies and

¹ Clean Line proceeded from a broad study area to the network of potential routes presented during the public scoping period by using an iterative siting process. This process included extensive stakeholder outreach that was not part of the DOE NEPA scoping process.

procedures. This report describes the manner in which DOE notified the public about the scoping process, held scoping meetings, and solicited comments, and includes a summary of scoping comments. DOE is publishing this Scoping Summary Report for the reader's information. The scoping period ended on March 21, 2013. The next public comment opportunity will begin when DOE issues the Draft EIS (see Section 5).

2. Scoping Process

This section describes the public scoping process, the techniques that were used to notify the public about their opportunity to be involved in scoping, and a brief summary of the public scoping meetings. The scoping comment period began on December 21, 2012, and ended on March 21, 2013.

2.1 Notice of Scoping Process

The methods used to announce the scoping period for the EIS are described below.

2.1.1 NOI

The scoping process began with the publication of the NOI in the *Federal Register* on December 21, 2012 (see Appendix A for a copy of the NOI). The NOI announced DOE's intention to prepare an EIS to assess the potential environmental impacts of participating with Clean Line in the proposed Project and advised that a floodplain and wetland assessment will be included in the EIS. The NOI also announced the dates and locations of the public scoping meetings and methods for submitting scoping comments.

2.1.2 Media Announcements

DOE used printed advertisements to publicize the scoping meetings in local and regional newspapers in Oklahoma, Arkansas, and Tennessee. Public service announcements and advertisements were placed with radio stations in Oklahoma in an effort to reach the public in remote, rural areas that may not have been reached by print advertising. Copies of the print advertisements, along with the dates, locations, and media outlets where the advertisements were placed, can be found in Appendix B.

2.1.3 Direct Mail Postcards

Postcards announcing the scoping period and scoping meetings were mailed to landowners within the network of potential routes. The mailing of approximately 28,000 postcards was conducted in stages; the final mailing was sent out two weeks prior to the first scoping meeting.

During the second week of scoping meetings, DOE became aware of an error in collecting information for some of the addresses for some landowners in the Project area. This error resulted in approximately 700 landowners in the Oklahoma counties of Texas, Beaver, Woodward, and Harper either not receiving the initial postcard or receiving it after the meeting had been held in their area. The majority of these landowners were located in Woodward County. To address the error, an additional scoping meeting was held in Woodward, Oklahoma, on March 4, 2013, and a second postcard was sent to nearly 1,600 individuals, including the 700 who were impacted by the problem with the initial mailing, to notify them of this meeting. An email was sent to more than 300 individuals to inform them of the additional scoping meeting. Recipients of the email had made a request to receive Project information using the form on the EIS website.

Copies of the postcards sent to landowners are provided in Appendix C, along with the text of the email notification.

2.1.4 EIS Website

An EIS website was established and launched (<http://plainsandeasterneis.com/>) to coincide with publication of the NOI in the *Federal Register*. The EIS website will be maintained and updated throughout the EIS process. Website content will include information on the NEPA review process, the Draft and Final EIS, and associated resources and issues. The website will provide convenient access to:

- Information about the status of the EIS;
- Project documents, including reports, fact sheets, and the Draft and Final Plains & Eastern EISs;
- Opportunities for stakeholders and other interested parties to add their names and addresses to the EIS mailing list and submit comments electronically during comment periods; and
- Information about upcoming public involvement opportunities such as the dates, times, and locations of public meetings.

2.2 Scoping Meetings

DOE hosted 13 public scoping meetings in January, February, and March 2013, to provide the public with information about the NEPA process and the proposed Project and allow them an opportunity to identify issues and concerns to DOE. The meetings were held as listed in Table 2-1.

Table 2-1:
Plains & Eastern EIS Scoping Meetings

Date	Location	Number of Attendees ¹
Tues., Jan. 22, 2013	Marked Tree, Arkansas	16
Thurs., Jan. 24, 2013	Atoka, Tennessee	42
Mon., Jan. 28, 2013	Guymon, Oklahoma	25
Tues., Jan. 29, 2013	Beaver, Oklahoma	22
Thurs., Jan. 31, 2013	Woodward, Oklahoma	37
Mon., Feb. 4, 2013	Muskogee, Oklahoma	31
Tues., Feb. 5, 2013	Cushing, Oklahoma	39
Thurs., Feb. 7, 2013	Enid, Oklahoma	28
Mon., Feb. 11, 2013	Van Buren, Arkansas	247
Tues., Feb. 12, 2013	Russellville, Arkansas	87
Tues., Feb. 19, 2013	Newport, Arkansas	24
Thurs., Feb. 21, 2013	Searcy, Arkansas	37
Mon., Mar. 4, 2013	Woodward, Oklahoma	57
Total		692

¹ The number of attendees represents the number of people who signed in at the registration table. Actual attendance at each meeting could be slightly higher as registration was not mandatory.

All public scoping meetings were conducted using the same format. Each meeting began with a 90-minute open house period. Posters that presented information about the proposed Project were made available for viewing as described further below. Following the 90-minute open house period, the DOE NEPA Document Manager and/or Deputy NEPA Document Manager made a presentation that provided an overview of NEPA

and the EIS process. An informal question and answer session followed this presentation, during which attendees had the opportunity to ask questions about the scoping process and the proposed Project. Attendees then had the opportunity to further review poster stations and materials, continue discussions with representatives from DOE, DOE's EIS contractor, Clean Line, and Clean Line's environmental support contractor, and provide formal verbal comments to a court reporter before the conclusion of the open house. A court reporter was available for the duration of each meeting to transcribe verbal comments.

2.3 Scoping Meeting Materials

For each scoping meeting, posters that presented information about NEPA and the EIS process, and technical information about the proposed Project transmission line and route networks were arranged in topical stations and staffed by Project team members who were knowledgeable about each topic. These stations were set up around the meeting room and staffed by representatives from DOE, DOE's EIS contractor, Clean Line, and Clean Line's environmental support contractor. The posters also described how to comment during the scoping period, NEPA alternatives, Project participants, purpose and need for agency action, the network of potential routes, typical ROW easements, typical HVDC structures, and wind energy and HVDC.

A Project fact sheet was provided, which included a Project overview, a map of the network of potential routes, and information on how to submit scoping comments. Hard copy scoping comment forms were made available for completion at the scoping meetings or for submittal by mail or email. Large maps (42 inches x 60 inches) of the network of potential routes, showing the 1-mile corridor, were also available for viewing at every meeting. A video animation of a typical transmission line construction process was projected on a continuous loop during the open house period. Electronic versions of the scoping meeting materials were made available on January 18, 2013, and are available on the EIS website. Copies of the printed meeting materials and scoping comment form can be found in Appendix D and Appendix E, respectively.

3. Agency and Tribal Consultations

3.1 Tribal and Agency Letters

DOE contacted Native American tribes and appropriate federal, state, and local agencies before and during the scoping process. On November 6, 2012, DOE sent letters to federal agencies to request their involvement as cooperating agencies for the EIS. The NOI invited federal, state, and tribal governments and local agencies with jurisdiction by law or with special expertise to participate as a cooperating agency as defined by 40 CFR 1501.6. The NOI also stated that such governments and/or agencies may request cooperating agency status. DOE initiated government-to-government consultation with Native American tribes pursuant to Section 106 of the National Historic Preservation Act (NHPA). DOE and Clean Line initiated Section 106 consultation with the Advisory Council on Historic Preservation, State Historic Preservation Officers, and Tribal Historic Preservation Officers. The agencies and tribes that DOE contacted are listed in Tables 3-1 and 3-2, respectively, in alphabetical order.

**Table 3-1:
Agencies Contacted**

Agency	Agency
Advisory Council on Historic Preservation	Oklahoma Secretary of Energy
Arkansas Department of Environmental Quality	Oklahoma Tourism and Recreation Department
Arkansas Farm Service Agency	Oklahoma Turnpike Authority
Arkansas Game and Fish Commission	Oklahoma Water Resources Board
Arkansas Governor Beebe's Chief of Staff	St. Francis Levee District, Arkansas
Arkansas Highway and Transportation Department	Tennessee Department of Environment and Conservation
Arkansas Historic Preservation Program	Tennessee Department of Environment and Conservation, Division of Water Resources
Arkansas Natural Heritage Commission	Tennessee Department of Environment and Conservation, Natural Areas Program
Arkansas Parks and Tourism	Tennessee Department of Environment and Conservation, Natural Heritage Inventory Program
Bureau of Indian Affairs (Cherokee Nation, Eastern Oklahoma Region, Horton Agency, Pawnee Nation, Southern Plains Region)	Tennessee Department of Transportation
Farm Service Agency (Arkansas, Oklahoma, Tennessee)	Tennessee Historical Commission
Federal Highway Administration (Arkansas, Oklahoma, Tennessee)	Tennessee Office of the Governor
Natural Resources Conservation Service (Arkansas, Oklahoma, Tennessee; Eastern Programs Division DC)	Tennessee Valley Authority
Oklahoma Biological Survey	Tennessee Wildlife Resources Agency
Oklahoma Conservation Commission	U.S. Army Corps of Engineers (USACE) (Little Rock, Memphis, and Tulsa Districts; USACE Regulatory Office Oklahoma)
Oklahoma Department of Agriculture, Food, and Forestry	U.S. Coast Guard Tennessee
Oklahoma Department of Environmental Quality	U.S. Department of Agriculture
Oklahoma Department of Transportation (Ada and Oklahoma City, Oklahoma)	U.S. Environmental Protection Agency (Regions 4 and 6)
Oklahoma Department of Wildlife Conservation	U.S. Fish and Wildlife Service (Ecological Services Offices in Arkansas, Oklahoma, Tennessee); Central Arkansas National Wildlife Refuge
Oklahoma Historical Society State Historic Preservation Office	Vance Air Force Base Oklahoma

**Table 3-2:
Tribes Contacted**

Tribe	Tribe
Absentee-Shawnee Tribe of Indians of Oklahoma	Kiowa Indian Tribe of Oklahoma
Alabama Quassarte Tribal Town	Modoc Tribe of Oklahoma
Apache Tribe of Oklahoma	Plains Apache
Arkansas River Bed Authority	Quapaw Tribe of Indians
Caddo Nation of Oklahoma	Sac & Fox Nation, Oklahoma
Cherokee Nation	Santee Sioux Nation, Nebraska
Cherokee Nation (Real Estate Service)	Seneca-Cayuga Tribe of Oklahoma
Choctaw Nation of Oklahoma	Southern Arapahoe & Southern Cheyenne

**Table 3-2:
Tribes Contacted**

Tribe	Tribe
Comanche Nation, Oklahoma	The Muscogee (Creek) Nation—Eastern Oklahoma Region
Delaware Nation, Oklahoma	The Osage Nation
Delaware Tribe of Indians	Thlopthlocco Tribal Town
Eastern Band of Cherokee Indians	Tonkawa Tribe of Indians of Oklahoma
Iowa Tribe of Oklahoma	United Keetoowah Band of Cherokee Indians in Oklahoma
Kaw Nation, Oklahoma	Wichita and Affiliated Tribes, Oklahoma
Kialegee Tribal Town	

3.1.1 Cooperating Agencies

As described above, DOE initiated contact with a number of federal agencies through a letter that was sent on November 6, 2012, as part of the pre-scoping process that preceded the public scoping process. These agencies were invited to participate in the NEPA process as cooperating agencies. The agencies that have accepted that invitation to date are identified in Table 3-3. The role of a cooperating agency includes reviewing the technical approaches for impact analysis, reviewing the preliminary versions of the Draft and Final EIS, representing the interests of the agency, and engaging in activities, such as public hearings, associated with issuance of the Draft EIS.

**Table 3-3:
Plains & Eastern EIS Cooperating Agencies**

Cooperating Agencies
Bureau of Indian Affairs
Natural Resources Conservation Service
U.S. Army Corps of Engineers
U.S. Environmental Protection Agency
U.S. Fish and Wildlife Service
Tennessee Valley Authority

3.1.2 Consulting and Commenting Tribes and Agencies

Agencies that choose not to participate as cooperating agencies in the EIS process for the proposed Project may participate as consulting or commenting agencies.

3.2 Meetings with Tribes and Agencies

Four tribe and agency meetings were held during the public scoping period. The dates and locations for the agency meetings are listed in Table 3-4.

Table 3-4:
Plains & Eastern EIS Agency Scoping Meetings

Date	Location
Thurs., Jan. 24, 2013	Atoka, Tennessee
Tues., Feb. 5, 2013	Cushing, Oklahoma
Tues., Feb. 12, 2013	Russellville, Arkansas
Wed., Feb. 13, 2013	Chattanooga, Tennessee

3.2.1 Tribe and Agency Meeting Materials

The scoping meeting materials described in Section 2.3 were also presented at the tribe and agency meetings. The DOE NEPA Document Manager and/or Deputy Document Manager gave the overview presentation, which was followed by an opportunity for attendees to discuss specific concerns and topics they would like addressed in the Draft EIS.

3.2.2 Tribe and Agency Meeting Attendance

Representatives of the following tribes and agencies attended at least one of the four meetings:

- Pawnee Nation, Division of Natural Resources and Safety
- Bureau of Indian Affairs
- U.S. Department of Agriculture Farm Service Agency, Oklahoma
- U.S. Department of Agriculture Natural Resources Conservation Service
- U.S. Army Corps of Engineers (Little Rock, Memphis, and Tulsa Districts)
- U.S. Fish and Wildlife Service (Tennessee and Arkansas); Oklahoma Ecological Services Field Office
- Tennessee Valley Authority
- Oklahoma Department of Wildlife Conservation
- Oklahoma Department of Transportation
- Oklahoma Tourism and Recreation Department
- Tennessee Department of Environment and Conservation

3.3 Section 106 Consultation

During the scoping period, DOE initiated consultation required under Section 106 of the National Historic Preservation Act and its implementing regulations, 36 CFR Part 800, as amended. DOE sent letters to potentially impacted tribes, Tribal Historic Preservation Officers, and State Historic Preservation Officers requesting input regarding cultural resources or properties near the proposed Project. Tables 3-1 and 3-2 identify the tribes and agencies that were contacted as part of the Section 106 consultation process.

4. Scoping Comments

4.1 Comment Submittal

DOE provided four methods for the public to submit comments during the scoping period. Commenters provided comments via letters, comment forms, email, and oral comments transcribed by a court reporter at public scoping meetings. Project staff made annotations on the large-scale sheet maps of the proposed Project route segments that were available at the public scoping meetings. These notes were not considered scoping comments, but were used as sources of clarification and additional information when the scoping comments were considered. The written notes on the sheet maps were primarily site-specific information or concerns regarding particular preliminary corridors or segments within the network of potential routes. Representatives of DOE, DOE's EIS contractor, Clean Line, and Clean Line's environmental support contractor engaged attendees at the public scoping meetings and encouraged them to submit comments using comment forms or by presenting oral comments to the court reporter. Table 4-1 summarizes the number and type of comments that were considered in this Scoping Summary Report. The report summarizes all comments received during the scoping period, comments submitted electronically through the electronic comment form by March 24, 2013, and comments that were received in the mail by April 3, 2013. As indicated in the NOI, comments submitted or postmarked after the end of the public scoping period on March 21, 2013, are considered to the extent practicable.

Table 4-1:
Number and Type of Scoping Documents

Format	Number of Scoping Documents
Mail	72
Email or Electronic Comment Form	518
Written Comments Submitted at Scoping Meeting	19
Oral Comments at Scoping Meetings	55
Total	664

4.2 Summary of Comments

As described above, DOE received comments by several different methods during the public scoping period. The following preliminary list of impact areas for evaluation in the EIS was identified in the NOI:

- Land Use, Recreation, and Visual Resources
- Water Use and Water Quality
- Surface Water Features including Rivers, Floodplains, and Wetlands
- Fish, Wildlife, and Vegetation, including Critical Habitat
- Socioeconomics
- Environmental Justice
- Historic and Cultural Resources
- Geology, Soil, and Mineral Resources
- Human Health and Electric and Magnetic Fields

- Air Quality and Climate Change
- Construction-Related Impacts, including Road Clearing, Traffic, and Noise
- Accidents, Intentional Destructive Acts, and Hazards, including Air Space Management
- Waste Management

The list was not intended to be all-inclusive or imply any predetermination of impacts. The public was invited to suggest specific issues within these categories, or other categories not included above, for consideration in the EIS.

DOE reviewed each scoping comment document and identified individual comments within each document. DOE categorized each comment by topic and entered the comment in the comment management system database. Individual comments were used to develop the summaries included below.

Comments are summarized in the sections below by category.

4.2.1 Purpose and Need

- The federal government should not be involved in the proposed Project, because the proposed Project would benefit a private corporation.

4.2.2 Alternatives

The following comments are related to potential Project route alternatives.

4.2.2.1 General Comments

- Opposition to the proposed Project being built across areas/states that will receive no benefit from it, specifically Arkansas and Oklahoma; proposed Project should be built in the areas that will receive the electricity needed/produced.
- Update and revise location of gas pipelines and transmission lines, including new Oklahoma Gas & Electric (OG&E) transmission lines.
- Identify locations of oil/gas wells within proximity to route corridors.
- Route along field/property lines and avoid bisecting properties and fields.
- Identify additional/missing homes on maps showing the network of potential routes.
- Identify location of springs-used to water livestock and farms.
- Follow ROWs (highways, interstates, other lines/pipelines/utilities).
- Bury the proposed transmission line.
- Consider other alternatives such as hydroelectric (dam), nuclear, solar, or Atlantic seaboard-based wind farms.
- Avoid populated areas.
- Avoid routes that cross cemeteries.
- Place line on government/public lands.
- Avoid National Audubon Society Important Bird Areas.
- Avoid conservation areas on public and private lands.
- Avoid public lands.

- Commenters requested implementation timeline, Gantt charts detailing resources and critical path, and information about phone lines in Pope County, Arkansas.
- Commenters requested information about cost of project and the cost to federal government.
- Commenters requested information about use of solar panels with HVDC for better efficiency and production of electricity.

4.2.2.2 Route-Specific Scoping Comments

Tables 4-2 through 4-5 provide representative scoping comment summaries related to specific segments of the network of proposed routes, grouped by state. Corresponding sheet map numbers are also provided. If a specific route segment is not listed, scoping comments were not received related to that segment.

Table 4-2:
Oklahoma Route Segment-Specific Scoping Comments

Segment Number	Sheet Map Number	Scoping Comments
B-1	1, 2	<ul style="list-style-type: none"> • Avoid parks or other lands funded with Land and Water Conservation Fund and/or Recreational Trails Program dollars. • Concern that transmission line ROW would convert land to non-recreational use. • Maximize use of State Highway (SH) 412 and Segments B-1, B-5, B-6, and B-8 in routing the proposed Project in order to avoid core lesser prairie-chicken areas.
B-5	2	<ul style="list-style-type: none"> • Maximize use of SH 412 and Segments B-1, B-5, B-6, and B-8 in routing the proposed Project in order to avoid core lesser prairie-chicken areas.
B-6	2, 3	<ul style="list-style-type: none"> • Maximize use of SH 412 and Segments B-1, B-5, B-6, and B-8 in routing the proposed Project in order to avoid core lesser prairie-chicken areas.
B-8	2, 3, 4, 5, 6	<ul style="list-style-type: none"> • Avoid pivot irrigation circles and utilize specific pole placement to avoid impacting operation. • Prefer option north of OG&E line. • Maximize use of Oklahoma State Highway (SH) 412 and Segments B-1, B-5, B-6, and B-8 in routing the proposed Project in order to avoid core lesser prairie-chicken areas.
C-1	6, 7, 8	<ul style="list-style-type: none"> • Concern regarding effects of the Plains and Eastern transmission line plus OG&E Thistle Transmission Line on property.
C-2	8, 9, 11, 12	<ul style="list-style-type: none"> • Sheet 11, Sections 1, 2, 11, 12 T20N, R14W; prolific springs, 15 ponds feed farms North of the area where there are no springs, concern about impacting this water source, also concerned about cultural and wildlife resources around these areas. • Concern about impact to tourism, hunting, wildlife, views.
C-3	8, 9, 10, 12	<ul style="list-style-type: none"> • This segment overlaps with city of Enid water well infrastructure. • Request route go as far north of Glass Mountain State Park as possible. This park is #1 tourist destination in Major County and land is fragile/hard to reclaim. • A route following SH 412 would cross farmland and impact fewer residences, timber, and Cimarron River.
D-2	12, 13, 14	<ul style="list-style-type: none"> • Concern regarding land use impact (cultivation and aerial spraying). • Heavily populated along County Road E590. • Impacts to historical resources (Oklahoma Centennial Farms and Oklahoma Land Runs), geological impacts to buffalo wallows, and impacts to Texas horned lizard habitat. • Significant cottonwood tree (with historical marker) called the Marrying Tree along Highway 81 where Segment D-2 crosses.
E-4	16, 17	<ul style="list-style-type: none"> • Concern regarding large turkey vulture roost and nesting site used by hundreds of birds, located 2.3 miles east of Perkins, Oklahoma, where corridor crosses Cimarron River.
F		<ul style="list-style-type: none"> • Emergency helicopter service located nearby and impact to operations should be avoided.

**Table 4-2:
Oklahoma Route Segment-Specific Scoping Comments**

Segment Number	Sheet Map Number	Scoping Comments
F-1	17, 18	<ul style="list-style-type: none"> • Tank farm areas expanding and may impact corridors.
F-2	17, 18, 19	<ul style="list-style-type: none"> • Concern regarding impacts to areas with high rural population. • Do not like F-2, F-3, and F-5. Indicated F-4 is better but needs to go further south.
F-3	18, 19	<ul style="list-style-type: none"> • Concern regarding impacts to areas with high rural population. • Do not like F-2, F-3, and F-5. Indicated F-4 is better but needs to go further south.
F-4	18, 19, 20	<ul style="list-style-type: none"> • Indicated F-4 is better than other proposed routes in area (F-2, F-3, F-5), but needs to go further south to avoid Bristow and residential areas. • Route line parallel to Bald Hill Rd.
F-5	19, 20	<ul style="list-style-type: none"> • Concern regarding impacts to areas with high rural population. • Do not like F-2, F-3, and F-5. Indicated F-4 is better but needs to go further south.
F-7	20, 21, 22	<ul style="list-style-type: none"> • Concern regarding additional impact to agricultural operations from placing this line adjacent to existing lines on property. • Prefer Segment F-7 because it does not bisect significant grassland habitat in central Oklahoma, which is part of the U.S. Department of Agriculture Grassland Reserve Program.
F-8	20, 21, 22	<ul style="list-style-type: none"> • Large tract of intact native grassland and habitat for prairie birds found on property that participates in the U.S. Department of Agriculture Grassland Reserve Program. • Concerns regarding impact to nesting and brooding practices of indigenous species in this Segment.
G-1	21, 22	<ul style="list-style-type: none"> • Review existing infrastructure locations and ability to route through these locations.

**Table 4-3:
Oklahoma/Arkansas Route Segment-Specific Scoping Comments**

Segment Number	Sheet Map Number	Comments
G-2	22, 23, 24	<ul style="list-style-type: none"> • Identify missing homes on maps, correct transmission line location. • Concerns regarding proximity of proposed route to churches, schools, parks, and other public facilities, and residences in Cedarville, Arkansas. • Avoid bisecting properties due to work with Natural Resources Conservation Service and other agencies. • Avoid this area to eliminate potential threats to Long-nosed Darter and Black-sided Darter.
G-3	22, 23, 24	<ul style="list-style-type: none"> • Concerns regarding impact on Lee Creek Reservoir area, which is city of Fort Smith drinking water supply and hydro electrical generation plant. The reservoir includes a buffer zone around the reservoir as specified in USACE Section 404 permit. • Prefer that G-3 not be used.

**Table 4-4:
Arkansas Route Segment-Specific Scoping Comments**

Segment Number	Sheet Map Number	Comments
G-4	24, 25	<ul style="list-style-type: none"> Concerns regarding quality of life, property values, aesthetics, future sales, and planned expansions of an existing residential subdivision. Opposition to G-4 because of the proximity to an existing residential subdivision. Other routes would be shorter.
G-5	24	<ul style="list-style-type: none"> Concern regarding impact to a comet observatory. Concerns regarding impacts to local residences, farms, and hunting club managed through Arkansas Game and Fish Commission Deer Management Assistance Program. Concern regarding subdivided areas and impact to residences, Mulberry River and Big Piney Creek Wild/Scenic Rivers, Butterfield Trail-Arkansas Heritage Trail, Boston Mountain Scenic Loop on U.S. Highway 71 and Interstate 540, Pig Trail Scenic Byway on SH 23 and Arkansas Scenic 7 Byway. Segment G-5 connecting with G-3 is a more feasible, less expensive route, will impact fewer residences, and will not obstruct views of the Arkansas River Valley and Fort Smith.
G-6	24, 25	<ul style="list-style-type: none"> Scenic byway.
G-7	25	<ul style="list-style-type: none"> Concerns regarding erosion, hay crop.
G-8	25, 26	<ul style="list-style-type: none"> Interstate 40 (exit 35) and Scenic Highway 23 N— avoid planned commercial development.
G-9	25, 26	<ul style="list-style-type: none"> Identify missing pipeline on map.
H-1	26, 27	<ul style="list-style-type: none"> Digitize missing homes on map. Check county road names against what is commonly used (4 digits). Avoid routing where multiple easements exist.
H-2	26, 27	<ul style="list-style-type: none"> Identify missing pipeline on map. Avoid existing subdivision marked on map. Crosses several utility ROWs. Avoid due to Horsehead watershed.
H-5	27	<ul style="list-style-type: none"> Line should share current structures and not create new ROWs. If must cross property along Route 164 and east of intersection of Route 164 and County Road 3751, should be adjacent to Route 164 on northern border of property and not bisect. Future construction of airstrip planned; requests underground option for transmission line.
H-6	27	<ul style="list-style-type: none"> Line should go through Ozark National Forest; consider running line on bench located north of Iron Ore Mountain.
I-1	27, 28	<ul style="list-style-type: none"> Avoid wooded undeveloped lot and tree farm.
I-2	28, 29	<ul style="list-style-type: none"> Easement overload—already have three gas pipelines on property.
I-3	28, 29	<ul style="list-style-type: none"> Many gas wells in area.
I-5	29, 30	<ul style="list-style-type: none"> Avoid center pivot irrigation. Several large land holdings drawn on maps.
J-4	30, 31	<ul style="list-style-type: none"> Do not impact flow of water in Little Creek.
J-5	30, 31	<ul style="list-style-type: none"> Concern regarding impact to timber, many gas wells, large landholdings, Conservation Reserve Program (CRP), and pipelines in the area. J-4 to J-7 route would be shorter.
K-1	31, 32	<ul style="list-style-type: none"> Cultural resource concerns related to CRP and Wetland Reserve Program (WRP).

**Table 4-4:
Arkansas Route Segment-Specific Scoping Comments**

Segment Number	Sheet Map Number	Comments
K-2	31, 32	<ul style="list-style-type: none"> • Incorrect pipeline locations on maps. • Would like to see it turn north when it reaches U.S. Highway 67 and follow the highway along its west side until reaching the junction with SH 14. At this junction turn east and proceed along the north side of Highway 14 until leaving the county. • Another idea is to build the line along the north side of U.S. Highway 64. The line could follow this highway east from Bald Knob until it ends.
K-3	32, 33	<ul style="list-style-type: none"> • CRP and mile-wide pivot irrigation.
L-2	33, 34, 35	<ul style="list-style-type: none"> • Multiple airstrips in area. • Lake Poinsett area—why crossing in this location. • Check for new and no longer used pivots.
L-3	33, 34	<ul style="list-style-type: none"> • Avoid existing aerial application business. • Avoid diagonal field crossings and creating small triangles of land/property. • Use property/field lines for routes.
L-4	33, 34	<ul style="list-style-type: none"> • Avoid existing aerial application business. • Avoid pivot irrigation.
L-5	34, 35	<ul style="list-style-type: none"> • Avoid wetland area (lower route off Highway 214 below Harrisburg) in conservation easement with Arkansas State University and CRP/WRP. • Duck hunting and rest area for waterfowl. • Lake Poinsett area—why crossing in this location. • Check for new and no longer used pivots.
M-1	35, 36	<ul style="list-style-type: none"> • Line should run south of Wilson.
M-2	35, 36	<ul style="list-style-type: none"> • Concern regarding disruption to agricultural lands—pivots and precision leveled lands. • Corridor crosses NRCS WRP area: suggest minor reroute to avoid. This would be the shortest route in the area.

**Table 4-5:
Tennessee Route Segment-Specific Scoping Comments**

Segment Number	Sheet Map Number	Comments
M-3	36	<ul style="list-style-type: none"> • Concern regarding impacts to residential, agricultural lands, cemeteries, Native American burial mounds, and species habitat. • Landowner provided mapped alternatives.
M-4	36, 37	<ul style="list-style-type: none"> • Prefer M-3/M-5 due to concern about impact to property values and potential impact on tax base/emergency services. • Airstrip marked on map in corridor. • Concern regarding residential areas, including Munford, Tennessee. • Existing residential subdivisions located in the area.

Table 4-5:
Tennessee Route Segment-Specific Scoping Comments

Segment Number	Sheet Map Number	Comments
M-5	36, 37	<ul style="list-style-type: none"> • Follow existing route; don't create new route. • Correct road data. • Concern regarding residential areas, including Munford, Tennessee. • Concern regarding impacts to residential, agricultural lands, cemeteries, Native American burial mounds, and species habitat. • Landowner provided mapped alternatives.

4.2.3 Resource Areas

The following comments are related to resource areas that will be addressed in the EIS, organized by topic.

4.2.3.1 Land Use

- Discuss impacts on future oil and gas drilling activities.
- Discuss the restrictions the proposed Project will place on future land use (public and private) and cultivation/development.
- Discuss possibility that proposed Project may impair or delay conservation efforts and agreements, impacts to status of federally designated areas, including blueway (water trail), scenic byway, and wildlife refuge designations.

4.2.3.2 Land Acquisition and Land Rights

- Describe the potential use of eminent domain or other land easements to obtain private property.
- Discuss how ROW access may invite trespassing on private property.
- Describe how construction and maintenance debris will be removed from private property.
- Analyze how the proposed Project may negatively impact the ability for small oil/gas producers to lease property for oil and natural gas exploration and production.
- Discuss whether access to lands would also provide access to mineral rights below the surface for fracking.
- Evaluate utilizing existing levee system, easements, or ROWs.

4.2.3.3 Agriculture

- Analyze effects of proposed Project on agricultural operations, water management systems (e.g., surface water reservoirs, underground pipelines, and tail-water recovery systems), irrigation and/or drainage systems (specifically the use of two center pivot irrigation systems), removal/damage of acreage, seeding, impacts on planting and harvesting, crop production, and aerial applications of fertilizer, insecticide, and herbicide.
- Analyze potential impacts of proposed Project on precision-graded rice and farm fields (Segments, K, L, and M).
- Describe and consider impacts to rice production and indirect impacts on migrating waterfowl that rely on rice producing lands for feeding and winter habitat.
- Analyze how loss of land may reduce area for grazing and hay production.

4.2.3.4 Recreation

- Analyze impacts on recreational uses including fishing, hunting, hiking, camping, canoeing (Lake Poinsett; Poinsett County, Arkansas; Segment K-1 Jackson County, Arkansas).
- Consider impacts on recreational areas, including national and state parks and forests.
- Consider disturbance of recreational activities such as hang-gliding or riding all-terrain vehicles on private lands.
- Avoid crossings of resources that are Scenic Byways, Extraordinary Resource Waters, National Blueways², in areas that may have recreational importance.
- Address use of easement areas for recreational activities such as hiking and camping.

4.2.3.5 Visual and Aesthetic

- Quantify and evaluate the visual impacts of the proposed Project, including on scenic vistas.
- Describe the impacts to property owners' views that may be impacted by the proposed route.
- Avoid crossings/routes in Arkansas in areas that negatively impact scenic sections of Extraordinary Resource Waters; high quality fisheries; Arkansas Water trails; Arkansas Heritage Trails; and National Blueways; and National Scenic Byways.
- Analyze how the visual impacts of the proposed Project may have negative effects on tourism and recreational activities.
- Discuss design aspects of the proposed Project, including tower structures and distance between towers.
- Discuss impacts created by light pollution.

4.2.3.6 Water Resources

- Analyze impacts to water resources including water quality, pollutant sources, load allocations associated with drinking water standards, drinking water sources, wells, springs, wetlands, alluvial aquifers, rivers, streams, creeks, and lakes.
- Discuss impacts to floodplains.
- Discuss impacts to several sensitive, designated, and navigable resources being crossed or in the vicinity of the proposed Project (Segments J, L-4, L-5, and M-5).
- Discuss impacts to aquifers, specifically in Jackson and Poinsett counties where alluvial aquifer begins at 15 feet below the surface.
- Discuss mitigation measures to protect underground water and water wells.

4.2.3.7 Wildlife (including fish and critical habitat)

- Discuss potential for the proposed Project to cause fragmentation of wildlife habitat, including to significant grassland habitat in central Oklahoma.
- Address the impact to threatened and endangered species, and their habitat, found along the proposed routes, including mitigation and plans to avoid sensitive species.
- Analyze impacts of the proposed Project on migratory bird habitat and flyways (including Mississippi Flyway).

² A National Blueway designation includes the entire river from its "headwaters to mouth" as well as the river's watershed.

- Discuss impacts of proposed Project to migrating birds.
- Proposed routes should avoid lands recognized by the National Audubon Society as Important Bird Areas.
- The route that includes Cedarville, Arkansas, will impact the Ozark Mountains habitat currently protected by a partnership with the U.S. Geological Society and the Arkansas Natural Heritage Commission.
- Discuss impacts to old growth forests and the American burying beetle (Segment J).
- Describe potential impacts to the Cache River National Wildlife Refuge.
- Discuss impacts to the lesser prairie-chicken.

4.2.3.8 Vegetation

- Identify and address use of best management practices (BMPs) to minimize disturbance to natural resources, including ground cover, hay production, pecan groves, and sensitive plants along the entire route.
- Address potential impacts that removal of vegetation would have on impaired water bodies, specifically related to filtering of pollutants.
- Describe impacts of proposed Project on significant grassland habitat in central Oklahoma (Segment F-8).
- Discuss how vegetation will be managed along the ROW, specifically the use of chemicals and ability of landowners to manage vegetation as they desire (i.e., without the use of herbicides and defoliant).

4.2.3.9 Socioeconomic Resources

- Evaluate and quantify expected impacts on property and land values along the route.
- Address compensation of land owners along the proposed ROW.
- Describe the economic benefits of the proposed Project to the residents and state of Arkansas.
- Analyze the direct and indirect economic impacts of the proposed route, including to industries such as agriculture, tourism, rice farmers, duck hunting operations (Segments L, L-2, and L-4), and timber farmers.
- Analyze impacts of short and long-term employment associated with the proposed Project.
- Discuss the impacts of the proposed Project on plans for future development and mineral exploration opportunities.
- Discuss how much the proposed Project will cost the state of Tennessee.
- Discuss the impacts of the proposed Project on smaller communities within the Project area that may not be able to absorb the influx of population.

4.2.3.10 Environmental Justice

- Consider environmental justice implications in the use of private land for private gain, specifically percentage of landowners that rely on income from the land that could be devalued by construction of the transmission line.

4.2.3.11 Cultural, Historic, and Archaeological Resources

- Analyze impacts to cultural, historical, and archaeological resources, including Native American relics and artifacts (Segments K and L), burial sites; family cemeteries (Segment C and M-5); historic sites,

including Butterfield Trail Stage Route, the Trail of Tears, and area battlefields, and routes connecting to those sites (Segment G); Sheridan's Roost; Sequoyah Home Museum and other Cherokee heritage sites; and other cultural activities and sites along the proposed route.

- Consider impacts on cultural values of landowners and residents of remote areas, including the impact on future generations who may wish to reside on or farm their families' ancestral properties.
- Analyze impacts to "Centennial" farms and trees in Oklahoma.

4.2.3.12 Geology and Soils (including minerals)

- Analyze impacts of construction equipment and installation of towers and power lines on erosion, scouring, silting, (Segment G).
- Address erosion control activities on the ROW, specifically in hilly areas where removal of trees will cause impacts on Federal Scenic Waterways.
- Analyze impacts of proposed Project to rice production/irrigated agriculture, specifically clay hardpan. Consider that soil structure is crucial to these activities and damage to hardpan will cause loss of topsoil and loss of productivity.
- Consider features such as rough terrain, buffalo wallows, fault lines (Mulberry Fault), and steep-sided hills.

4.2.3.13 Air Quality and Climate Change

- Analyze the impacts on air quality and climate change once the proposed Project is completed. Compare and contrast these impacts with the impacts of various other resources (renewable and non-renewable) that could be used to produce and transmit power.
- Consider impacts on climate change associated with destruction of trees.

4.2.3.14 Traffic and Noise

- Analyze noise emitted by power lines.
- Consider impacts of noise caused by ROW crews, including the possibility for extended work hours.
- Consider impacts of increased traffic from construction and maintenance, including increase in dangerous conditions and damage to roads.
- Address road improvements that will be made before, and after, construction of the proposed Project (Segment H; Woodward, Oklahoma).

4.2.3.15 Human Health and Safety

- Analyze impacts of high-voltage transmission lines on health of humans, especially the young and elderly, as well as livestock. (Segments C, F-8, G-3, K, L, and M-4).
- Discuss health impacts of high-voltage transmission lines on global positioning systems (GPS), pacemakers, farm equipment, defibrillators, neurostimulators, and medical equipment.
- Analyze potential for the proposed Project to cause faulty GPS signals that may cause GPS-guided aircraft and or farm equipment to collide with structures and wires erected.
- Address health impacts of the proposed Project resulting from grass/wild fires, structures or towers that fail, and electrocution due to downed lines.

- Analyze impacts on water quality of a drinking water supply (Segment G-3, under the U.S. Environmental Protection Agency and Arkansas Department of Health's Source Water Protection Program).

4.2.3.16 Accidents, Intentional Destructive Acts, and Hazards (including air space)

- Analyze impacts of aircraft operating in the area of the transmission lines, specifically associated with aerial application of pesticides and fertilizers (Segment L-3, Jackson and Poinsett counties, Arkansas).
- Avoid locating the line in areas near personal airstrips and small airports.
- Consider impacts of tornadoes, fire, earthquake, snow, and ice storms. Discuss the liability and responsibility to maintain the line and ROW in the event of an accident caused by such events.

4.2.3.17 Electric and Magnetic Fields

- Analyze health impacts of high-voltage transmission lines to humans, livestock, and plants.
- Address impacts of electromagnetic fields (EMF) on GPS, cell phones, medical devices, television, and internet.
- Discuss potential for stray voltage and how structures are grounded.

4.2.3.18 Waste Management

No scoping comments were received in this category.

4.2.4 NEPA Process

- The NEPA process should be held in abeyance until there is a full and fair hearing on the merits of Clean Line's application [under Section 1222].
- Individuals received notification of scoping meetings with too short notice or after meetings in their area had been held.
- Requests for extension of scoping period.
- Continue the level of public involvement during public hearings on Draft EIS. Commenter suggested that Clean Line has been very open with level of information and interaction with public.
- Commenters expressed dissatisfaction with lack of communication about the proposed Project and the quality of the maps at the scoping meetings and on the EIS website.
- Address concerns that Northern route (Segment M-4) was announced during scoping period.
- Comments should have been recorded during scoping meetings.

4.2.5 Connected Actions

- Analyze impacts of wind farms that will be constructed in conjunction with the proposed Project.
- Address responsibility for removal of turbines and towers in the event the proposed Project is terminated at some point in the future.

4.2.6 Cumulative Impacts

- Analyze cumulative impacts of wind farms associated with the proposed Project.
- Discuss impacts of potential future projects that may be located near the proposed Project.

- Analyze cumulative impacts on agriculture, wildlife, aesthetic and scenic values, and the economy and the culture of areas that would be impacted by the proposed Project.
- Address cumulative impacts of past, current, or future, local, state, and/or federal projects.
- Address impacts of the construction of Interstate 69 in and around Munford, Tennessee (Segment M-4).

4.2.7 Mitigation

- Consider mitigation needs in areas where wetland mitigation banks do not exist.
- Address use of BMPs for construction to mitigate impacts to wildlife habitat, including sensitive species and species of concern.
- Discuss plans to prevent soil erosion during and after construction, including responsibility for long-term effects of erosion, sediment in streams, and duration of responsibility.

4.2.8 Petitions

A petition was submitted by residents of Cedarville, Arkansas, and Crawford County, Arkansas, who are against the power transmission line coming through the county (Segment G). Four hundred eleven people signed the petition. Specific comments were identified in the petition and were included in the summaries for the following topics discussed above: route-specific alternatives, socioeconomic, agriculture, and cultural, historical, and archaeological resources.

5. Project Status/Next Steps

DOE is considering the comments received during the scoping period in preparing the Draft EIS.

The U.S. Environmental Protection Agency will publish a Notice of Availability of the Draft EIS in the *Federal Register*, which will begin the public comment period. DOE will provide notice that the Draft EIS is available for public review through a Notice of Availability in the *Federal Register*, an announcement on the EIS website, and through other media – including announcing how to comment on the Draft EIS and providing the date, time, and location of public hearings on the Draft EIS. The Draft EIS will be posted on the EIS website and DOE NEPA Website. DOE will provide a minimum of 45 days for public comment on the Draft EIS, during which time DOE will also hold public hearings to receive comments on the Draft EIS. After the close of the public comment period on the Draft EIS, DOE will consider the comments received and prepare a Final EIS. In the Final EIS, DOE will consider and respond to comments it received on the Draft EIS (both written and verbal comments). The availability of the Final EIS will be announced in the *Federal Register* by the U.S. Environmental Protection Agency and the Final EIS will be posted on the EIS Website and the DOE NEPA Website.

Appendix A: Notice of Intent

This page intentionally left blank.

microsclerotia and can be used for aquatic plant control.

Brenda S. Bowen,

Army Federal Register Liaison Officer.

[FR Doc. 2012-30849 Filed 12-20-12; 8:45 am]

BILLING CODE 3720-58-P

DEPARTMENT OF ENERGY

Notice of Intent To Prepare an Environmental Impact Statement for the Plains and Eastern Clean Line Transmission Project and Notice of Potential Floodplain and Wetland Involvement

AGENCY: Department of Energy.

ACTION: Notice of Intent (NOI) To Prepare an Environmental Impact Statement and Notice of Potential Floodplain and Wetland Involvement.

SUMMARY: The U.S. Department of Energy (DOE) intends to prepare an *Environmental Impact Statement for the Plains & Eastern Clean Line Transmission Project* (DOE/EIS-0486; Plains & Eastern EIS or EIS) to assess the potential environmental impacts of participating with Clean Line Energy Partners LLC (Clean Line) in the proposed Plains & Eastern Project (the proposed project). The proposed project would include an overhead ± 600 kilovolt (kV) high voltage direct current (HVDC) electric transmission system and associated facilities with the capacity to deliver approximately 3,500 megawatts (MW) primarily from renewable energy generation facilities in the Oklahoma Panhandle region to load-serving entities in the Mid-South and Southeast via an interconnection with the Tennessee Valley Authority (TVA). The proposed project would traverse Oklahoma, Arkansas, and Tennessee, a distance of approximately 700 miles between interconnection facilities in Texas County, Oklahoma, and Shelby County, Tennessee. The proposed project would require construction of a new alternating current (AC)/direct current (DC) converter station at each end of the transmission line.

Portions of the proposed project may affect floodplains and/or wetlands. This NOI, therefore, also serves as a notice of proposed floodplain or wetland action in accordance with DOE floodplain and wetland environmental review requirements (10 CFR part 1022). The Plains & Eastern EIS will include a floodplain and wetland assessment. DOE plans to coordinate the National Environmental Policy Act (NEPA) review and the Section 106 compliance process under the National Historic

Preservation Act (NHPA). DOE also intends to consult with the U.S. Fish and Wildlife Service (USFWS) and the National Marine Fisheries Service (NMFS), as appropriate, pursuant to Section 7 of the Endangered Species Act.

DATES: DOE invites public comment on the scope of the Plains & Eastern EIS during a 90-day public scoping period beginning with publication of this notice and ending on March 21, 2013. See *Public Participation* in the **SUPPLEMENTARY INFORMATION** section for public scoping meeting dates and locations. DOE will consider all comments received or postmarked by the end of the scoping period and will consider comments received or postmarked after the ending date to the extent practicable.

ADDRESSES: Written comments on the scope of the Plains & Eastern EIS and requests to be added to the EIS distribution list may be submitted by any of the following methods:

- Electronic comments via the project Web site at <http://PlainsandEasternEIS.com>.
- Email to info@PlainsandEasternEIS.com.
- U.S. Mail to Plains & Eastern Clean Line EIS, 1099 18th Street, Suite 580, Denver, CO 80202.

For additions to the distribution list, please specify the format of the Plains & Eastern EIS that you would prefer to receive (printed copy, CD, or DVD) and a preference for either the complete EIS document or “Summary Only.” When completed, the EIS will be available for download at the project Web site (<http://PlainsandEasternEIS.com>) and at the DOE NEPA Web site (<http://energy.gov/nepa>).

FOR FURTHER INFORMATION CONTACT: For information on the Plains & Eastern EIS, contact Jane Summerson, Ph.D., DOE NEPA Document Manager, Office of Energy Efficiency and Renewable Energy, U.S. Department of Energy, 1000 Independence Avenue SW., Washington, DC 20585, or email at Jane.Summerson@ee.doe.gov.

For general information about the DOE NEPA process, contact Carol Borgstrom, Director, Office of NEPA Policy and Compliance (GC-54), U.S. Department of Energy, 1000 Independence Avenue SW., Washington, DC 20585, or phone at (202) 586-4600, voicemail at (800) 472-2756, or email at askNEPA@hq.doe.gov. Additional information regarding DOE’s NEPA activities is available on the DOE NEPA Web site at <http://energy.gov/nepa>.

SUPPLEMENTARY INFORMATION:

1. Background

Section 1222(b) of the Energy Policy Act of 2005 (EPAct) authorizes the Secretary of Energy, acting through and in consultation with the Administrator of the Southwestern Power Administration (Southwestern) to participate with other entities in designing, developing, constructing, operating, maintaining, or owning new electric power transmission facilities and related facilities located within any state in which Southwestern operates, provided the Secretary determines that certain conditions have been met. Southwestern is one of four Power Marketing Administrations that operates within DOE. Southwestern is chartered to market and deliver power in the southwestern United States, including Arkansas and Oklahoma, to rural electric cooperatives and municipal utilities.

On June 10, 2010, DOE issued a Request for Proposals (RFP) for new or upgraded transmission projects pursuant to Section 1222 (75 FR 32940). Clean Line Energy Partners LLC of Houston, Texas, the parent company of Plains and Eastern Clean Line LLC and Plains and Eastern Clean Line Oklahoma LLC (collectively referred to as Clean Line), responded to the RFP on July 6, 2010, providing a description of the proposed project and supporting information. Clean Line’s original proposal included two HVDC lines, each rated at 3,500 MW, together with the capacity to deliver 7,000 MW. Since the original proposal was submitted, Clean Line has modified its Section 1222 proposal to a single HVDC line with the capacity to deliver 3,500 MW. More information on the proposed project, including updates, can be found at <http://PlainsandEasternEIS.com>. DOE has concluded that Clean Line’s proposal complied with and was responsive to the RFP.

Prior to making a determination whether to participate in the proposed project, DOE must fully evaluate the proposed project, in consultation with Southwestern, including reviewing the potential environmental impacts pursuant to NEPA and the requirements of Section 1222(b). DOE is preparing the Plains & Eastern EIS pursuant to NEPA, the Council on Environmental Quality (CEQ) NEPA regulations (40 CFR parts 1500 through 1508), and the DOE NEPA implementing regulations (10 CFR part 1021).

Portions of the proposed project may affect floodplains and/or wetlands. There are floodplains associated with the Cimarron River, North Canadian River, Arkansas River, White River,

Cache River, and Mississippi River, each of which would be crossed by the proposed transmission line, and potentially at other locations along the proposed routes. Similarly, wetlands could be present along the proposed routes, including near tributaries to rivers in the project area. This NOI, therefore, also serves as a notice of proposed floodplain or wetland action in accordance with DOE floodplain and wetland environmental review requirements (10 CFR part 1022). The Plains & Eastern EIS will include a floodplain and wetland assessment. DOE plans to coordinate the NEPA review and the NHPA Section 106 compliance process. DOE also intends to initiate consultation with USFWS and NMFS, as appropriate, pursuant to Section 7 of the Endangered Species Act.

2. Purpose and Need for Agency Action

DOE's purpose and need for agency action is to implement Section 1222(b) of the EPCA. To that end, DOE needs to decide whether and under what conditions to participate in Clean Line's proposed Plains & Eastern Project.

3. Proposed Action and Alternatives

The proposed project would include an overhead ± 600 kV HVDC electric transmission system with the capacity to deliver approximately 3,500 MW from the Oklahoma Panhandle region to load-serving entities in the Mid-South and Southeast. The proposed project would traverse Oklahoma, Arkansas, and Tennessee, a distance of approximately 700 miles. The western portion of the proposed project would interconnect to the transmission system operated by the Southwest Power Pool in Texas County, Oklahoma. The eastern portion of the proposed project would interconnect to the transmission system operated by TVA in Shelby County, Tennessee. TVA would make the necessary upgrades to its transmission system, which could include construction and operation of new transmission lines and substations and upgrades to existing transmission lines and substations.

A new AC/DC converter station would be built at each end of the transmission line. Each converter station would require the use of approximately 30 to 50 acres and would be located on private land. The converter stations are proposed to be located in Texas County, Oklahoma, and either Shelby County or Tipton County, Tennessee. The proposed project would include, in addition to the HVDC transmission line, four to six AC transmission lines of up to 345kV

interconnecting the western converter station with new wind generation facilities that would be located in parts of the Oklahoma panhandle, southwest Kansas, and Texas panhandle within approximately 40 miles of the western converter station. Clean Line anticipates that electricity generated by these facilities would constitute the majority of the transmission capacity of the transmission line.

The proposed project would also include the following major facilities and improvements:

- Right-of-way easements for the transmission lines with a typical width of approximately 150 to 200 feet for the HVDC line and potentially narrower for the AC transmission lines.
- Tubular or lattice steel structures used to support the transmission lines. For the HVDC line, structures typically would be between 120 and 200 feet tall depending on site-specific conditions. Limited quantities of taller structures may be required in some locations to address engineering constraints. Structures for the AC transmission lines may be shorter.
- Access roads, including improvements to existing roads, new overland access, and new unpaved temporary roads to access the proposed project facilities and work areas during the construction and operation phases.
- Ancillary facilities, such as communications facilities for access control and protection.

DOE's proposed action is to participate with Clean Line in the proposed project. In the Plains & Eastern EIS, DOE will analyze the potential environmental impacts of a range of reasonable alternative routes that could comprise the proposed project. DOE will also identify possible mitigation strategies for potential environmental impacts.

Clean Line identified the proposed location for the western converter station based on the presence of both an excellent wind resource (as classified by the DOE National Renewable Energy Laboratory) and adequate electrical interconnection facilities, including planned upgrades to existing facilities. Clean Line identified the proposed location for the eastern converter station based on the presence of high-voltage transmission facilities capable of interconnection and delivery of up to 3,500 MW of energy to portions of the Mid-South and Southeast.

As part of its planning process, Clean Line first identified several corridors within a broad study area. Clean Line evaluated the corridors for engineering and environmental issues and subsequently refined the corridors using

input from federal and state agencies, municipalities, non-governmental organizations, and various stakeholders. Clean Line then identified a study corridor approximately five to eight miles wide and held meetings with community leaders in counties intersected by the study corridor to solicit additional input. Clean Line then held open house meetings in fall 2012 to seek additional public input on potential routes. Using this information, Clean Line identified and submitted to DOE several potential routes.

In Oklahoma, the potential routes proposed by Clean Line begin in the central Oklahoma Panhandle and proceed in an east-southeasterly direction through generally rural areas between Oklahoma City and Tulsa, exiting the state in eastern Oklahoma near Sallisaw. The routes pass through the Central Flyway for migratory birds throughout Oklahoma. The proposed routes intersect the following counties in Oklahoma: Texas; Beaver; Harper; Woodward; Major; Garfield; Kingfisher; Logan; Payne; Lincoln; Creek; Okmulgee; Muskogee; and, Sequoyah. More specifically, from southern Texas County near Guymon, Oklahoma, to Harper County, routes are generally parallel to U.S. Highway 412 in an easterly direction through the Oklahoma Panhandle. They trend southeasterly in Woodward County, crossing the North Canadian River, and north of the city of Woodward and east of Boiling Springs State Park. From Woodward County, routes continue generally east and southeast in Major, Garfield, and Kingfisher counties, crossing the Cimarron River near Fairview and Glass Mountains State Park. In Payne County, routes cross the Cimarron River a second time and run near the Cushing Municipal Airport. The routes then trend in a southeasterly direction south of Cushing. The routes diverge around Bristow and run north of the city of Okmulgee. Routes continue a southeasterly trend in Muskogee County, crossing the Arkansas River at the Webbers Falls Reservoir near Gore. The routes then begin an easterly track, exiting Oklahoma northeast of Sallisaw in eastern Sequoyah County and entering Arkansas in western Crawford County.

In Arkansas, the routes proposed by Clean Line enter western Arkansas north of the city of Van Buren and proceed in an easterly direction through generally rural areas, exiting eastern Arkansas south of the city of Osceola, entering into Tennessee across the Mississippi River. The routes pass through the Mississippi Flyway for migratory birds throughout Arkansas

and Tennessee. The proposed routes intersect the following counties in Arkansas: Crawford; Franklin; Johnson; Pope; Conway; Van Buren; Faulkner; Cleburne; White; Jackson; Poinsett; and, Mississippi. More specifically, from Crawford County to eastern Pope County, the routes are south of the Ozark National Forest and generally follow the Arkansas River valley and Interstate Highway 40. Routes diverge around Alma and Dyer, but pass north of Ozark, Clarksville, and Dover, near the Cherokee Wildlife Management Area. In Conway County north of Morrilton, the routes continue in an easterly direction. The routes continue this easterly track north of Greenbrier, near Damascus and Quitman. North of Searcy, the routes turn northeast generally parallel to State Highway 67 north of Bradford, crossing the White River. The routes continue easterly along divergent paths across the Cache River and south of Marked Tree, cross Interstate Highway 55, to two proposed crossing locations of the Mississippi River. The proposed Mississippi River crossing locations are a north-south oriented crossing east of Wilson, Arkansas, at approximately river mile 768, and an east-west oriented crossing southeast of Joiner, Arkansas, at approximately river mile 762.

In Tennessee, the routes proposed by Clean Line enter western Tennessee from Arkansas at the two potential crossing locations described above and generally proceed in a southeasterly direction along separate paths through generally rural and suburban areas of Tipton County and Shelby County. The routes diverge around the community of Drummonds, with one route near Munford and Atoka and one route near Millington. The routes converge near the proposed interconnection point in Shelby County near Tipton, Tennessee.

DOE will analyze a range of reasonable alternatives. DOE has reviewed Clean Line's process and its proposed routes and determined that they provide a sufficient initial basis for the EIS. In addition, DOE will consider additional reasonable alternatives proposed in scoping comments and may expand or refine the range of alternatives based on those comments. Maps identifying the potential routes currently proposed for analysis are available on the EIS Web site at <http://PlainsandEasternEIS.com>. In addition to the facilities associated with the proposed project, the EIS will also analyze any facility additions and upgrades to third party systems to accommodate the proposed project.

The EIS also will analyze a No Action alternative, under which DOE would

not participate with Clean Line in the proposed project. DOE assumes for analytical purposes that the Plains & Eastern Project would not move forward and none of the potential environmental impacts associated with the proposed project would occur.

4. Preliminary Identification of Environmental Issues

DOE proposes to analyze potential short-term environmental impacts, such as those from construction, and potential long-term environmental impacts of operating and maintaining the transmission line. DOE's guidance for the preparation of an EIS recommends the use of the sliding-scale approach when evaluating environmental impacts. This approach would focus the analysis and discussion of impacts on significant environmental issues in proportion to the significance of the potential impacts. DOE has identified the following preliminary list of impact areas for evaluation in the EIS:

- Land Use, Recreation, and Visual Resources
- Water Use and Water Quality
- Surface Water Features including Rivers, Floodplains, and Wetlands
- Fish, Wildlife, and Vegetation, including Critical Habitat
- Socioeconomics
- Environmental Justice
- Historic and Cultural Resources
- Geology, Soil, and Mineral Resources
- Human Health and Electric and Magnetic Fields
- Air Quality and Climate Change
- Construction-Related Impacts, including Road Clearing, Traffic, and Noise
- Accidents, Intentional Destructive Acts, and Hazards, including Air Space Management
- Waste Management

This list is not intended to be all-inclusive or to imply any predetermination of impacts. DOE invites interested parties to suggest specific issues, including possible mitigation measures, within these general categories, or other categories not included above, to be considered in the EIS.

5. Agency Responsibilities

5.1 Stakeholder Involvement and Cooperating Agencies

DOE will prepare the EIS and will coordinate with appropriate federal, state, and tribal governments; local agencies; and interested members of the public during the preparation of the EIS. DOE will consult with Indian tribes on a government-to-government basis in accordance with Executive Order 13175

and other policies. Tribal concerns, including impacts on Indian trust assets and potential impacts on cultural resources, will be considered. DOE invites federal, state, tribal governments and local agencies with jurisdiction by law or with special expertise to be cooperating agencies on the EIS as defined in 40 CFR 1501.6. Such governments and/or agencies may also make a request to DOE to be a cooperating agency. As of this notice, TVA, and the Tulsa District and the Memphis District of the U.S. Army Corps of Engineers have committed to being cooperating agencies.

5.2 National Historic Preservation Act

Section 106 of the NHPA requires federal agencies to consider the effects of an undertaking on historic properties—historic structures and historic artifacts—before authorizing an undertaking (36 CFR part 800). Federal agencies are encouraged to coordinate compliance with Section 106 of the NHPA with any steps taken to meet the requirements of NEPA (36 CFR 800.8). In the interest of being comprehensive and less duplicative, DOE plans to coordinate the NEPA review and Section 106 compliance process for the preparation of the Plains & Eastern EIS to the greatest extent practicable. Further, DOE plans to invite federal, state, tribal governments, and members of the public to participate in this NEPA process for the purpose of ensuring the standards in 36 CFR 800.8(c)(1) through 800.8(c)(5), "Protection of Historic Properties," are met, including identifying mitigation actions that may be appropriate to address potential adverse effects that may result from implementing the proposed project.

5.3 Endangered Species Act

Section 7 of the Endangered Species Act requires an agency proposing to take an action to inquire of the USFWS and NMFS, as appropriate, whether any threatened or endangered species "may be present" in the area of the proposed action [see 16 U.S.C. 1536(c)(1)]. Accordingly, DOE intends to initiate consultation with these agencies.

6. Public Participation

The purpose of the scoping process is to identify alternatives and potential environmental impacts that DOE should analyze in the EIS. DOE will hold 12 public scoping meetings at the following locations and times in Oklahoma, Arkansas, and Tennessee to provide the public with an opportunity to present comments, ask questions, and discuss the scope of the Plains & Eastern EIS

with DOE and Clean Line representatives.

- January 22, 2013, 5:00–8:00 p.m. at Arkansas State University—Marked Tree Student Center, 33500 Highway 63 E, Marked Tree, AR 72365
- January 24, 2013, 5:00–8:00 p.m. at Gateway Baptist Church Center, 1915 Rosemark Road, Atoka, TN 38004
- January 28, 2013, 5:00–8:00 p.m. at Pickle Creek Center, 822 NE 6th Street, Guymon, OK 73942
- January 29, 2013, 5:00–8:00 p.m. at Beaver County Fairgrounds—Pavilion Building, 1107 Douglas Avenue, Beaver, OK 73932
- January 31, 2013, 5:00–8:00 p.m. at Woodward Convention Center—Meeting Room 1, 3401 Centennial Lane, Woodward, OK 73801
- February 4, 2013, 5:00–8:00 p.m. at Muskogee Civic Center Room D, 425 Boston Street, Muskogee, OK 74401
- February 5, 2013, 5:00–8:00 p.m. at Cushing Youth and Community Center, 700 South Little, Cushing, OK 74023
- February 7, 2013, 5:00–8:00 p.m. at Enid Convention Hall—Grand Ballroom, 301 South Independence, Enid, OK 73701
- February 11, 2013, 5:00–8:00 p.m. at Van Buren Public Library, 1409 Main Street, Van Buren, AR 72956
- February 12, 2013, 5:00–8:00 p.m. at Lake Point Conference Center—Event Center, 61 Lake Point Lane, Russellville, AR 72802
- February 19, 2013, 5:00–8:00 p.m. at Arkansas State University—Newport, Student Community Center—M&P I&I NEDC Room (First room on the left), 7648 Victory Boulevard, Newport, AR 72112
- February 21, 2013, 5:00–8:00 p.m. at Carmichael Community Center Auditorium, 801 S. Elm, Searcy, AR 72143

DOE will also announce the public scoping meetings via local news media, industry newsletters, and posting on the DOE NEPA Web site at <http://energy.gov/nepa/public-comment-opportunities> and on the Plains & Eastern EIS Web site at <http://PlainsandEasternEIS.com> at least 15 days prior to each meeting.

The scoping meetings will start with an informal open house to facilitate dialogue between project officials and the public. DOE will then provide an overview of the proposed project and lead a short, informal question-and-answer period to clarify the information presented and to answer questions about the NEPA process. The public will have an opportunity to view maps and project information and present

comments on the scope of the Plains & Eastern EIS. Representatives from DOE, Clean Line, and involved agencies will be available to answer questions and provide additional information to meeting attendees. A court reporter will be available at each scoping meeting to record oral comments from meeting attendees.

In addition to providing comments at the public scoping meetings, DOE will accept written comments as described in the **ADDRESSES** section. DOE will consider all comments postmarked or received during a 90-day public scoping period beginning with publication of this notice and ending on March 21, 2013. DOE will consider comments postmarked or received after that date to the extent practicable.

DOE expects to publish the draft EIS in the fall of 2013. The U.S. Environmental Protection Agency will publish a Notice of Availability of the draft EIS in the **Federal Register**, which will begin a minimum public comment period of 45 days. DOE will announce how to comment on the draft EIS and will hold public hearings during the public comment period. People who would like to receive a copy of the draft EIS when it is issued should submit a request as provided in the **ADDRESSES** section and specify their format preference.

Issued in Washington, DC, on December 14, 2012.

Patricia Hoffman.

Assistant Secretary for Electricity Delivery and Energy Reliability.

[FR Doc. 2012–30833 Filed 12–20–12; 8:45 am]

BILLING CODE 6450-01-P

DEPARTMENT OF ENERGY

Environmental Management Site-Specific Advisory Board, Portsmouth

AGENCY: Department of Energy (DOE).

ACTION: Notice of open meeting.

SUMMARY: This notice announces a meeting of the Environmental Management Site-Specific Advisory Board (EM SSAB), Portsmouth. The Federal Advisory Committee Act (Pub. L. 92–463, 86 Stat. 770) requires that public notice of this meeting be announced in the **Federal Register**.

DATES: Thursday, January 10, 2013, 6:00 p.m.

ADDRESSES: Ohio State University, Endeavor Center, 1862 Shyville Road, Piketon, Ohio 45661.

FOR FURTHER INFORMATION CONTACT: Greg Simonton, Alternate Deputy Designated Federal Officer, Department of Energy

Portsmouth/Paducah Project Office, Post Office Box 700, Piketon, Ohio 45661, (740) 897–3737, Greg.Simonton@lex.doe.gov.

SUPPLEMENTARY INFORMATION:

Purpose of the Board: The purpose of the Board is to make recommendations to DOE–EM and site management in the areas of environmental restoration, waste management and related activities.

Tentative Agenda

- Call to Order, Introductions, Review of Agenda
- Approval of November Minutes
- Deputy Designated Federal Officer's Comments
- Federal Coordinator's Comments
- Liaisons' Comments
- Presentations
- Administrative Issues
- Subcommittee Updates
- Public Comments
- Final Comments from the Board
- Adjourn

Public Participation: The meeting is open to the public. The EM SSAB, Portsmouth, welcomes the attendance of the public at its advisory committee meetings and will make every effort to accommodate persons with physical disabilities or special needs. If you require special accommodations due to a disability, please contact Greg Simonton at least seven days in advance of the meeting at the phone number listed above. Written statements may be filed with the Board either before or after the meeting. Individuals who wish to make oral statements pertaining to agenda items should contact Greg Simonton at the address or telephone number listed above. Requests must be received five days prior to the meeting and reasonable provision will be made to include the presentation in the agenda. The Deputy Designated Federal Officer is empowered to conduct the meeting in a fashion that will facilitate the orderly conduct of business. Individuals wishing to make public comments will be provided a maximum of five minutes to present their comments.

Minutes: Minutes will be available by writing or calling Greg Simonton at the address and phone number listed above. Minutes will also be available at the following Web site: <http://www.portssab.energy.gov/>.

Issued at Washington, DC, on December 17, 2012.

LaTanya R. Butler,

Deputy Committee Management Officer.

[FR Doc. 2012–30779 Filed 12–20–12; 8:45 am]

BILLING CODE 6450-01-P

Appendix B: Public Meeting Newspaper Notices

This page intentionally left blank.

**Table B-1:
Scoping Notifications Placed with Print Media**

Notification Date	Media Outlet	Media Outlet Location
Tennessee		
Thurs., Jan. 10, 2013	Millington Star	Millington
Thurs., Jan. 17, 2013	Millington Star	Millington
Thurs., Jan. 10, 2013	The Covington Leader	Covington
Thurs., Jan. 17, 2013	The Covington Leader	Covington
Sun., Jan. 13, 2013	Commercial Appeal—Millington/Tipton Appeal	Millington/Tipton County
Sun., Jan. 20, 2013	Commercial Appeal—Millington/Tipton Appeal	Millington/Tipton County
Wed., Jan. 23, 2013	Commercial Appeal—Millington/Tipton Appeal	Millington/Tipton County
Oklahoma		
Mon., Jan. 21, 2013	Guymon Daily Herald	Guymon
Wed., Jan. 23, 2013	Guymon Daily Herald	Guymon
Fri., Jan. 25, 2013	Guymon Daily Herald	Guymon
Wed., Jan. 23, 2013	Hooker Advance*	Guymon
Thurs., Jan. 17, 2013	Beaver Herald Democrat	Beaver
Thurs., Jan. 24, 2013	Beaver Herald Democrat	Beaver
Fri., Jan. 25, 2013	Woodward News	Woodward
Sun., Jan. 27, 2013	Woodward News	Woodward
Tues., Jan. 29, 2013	Mooreland Leader	Mooreland
Sun., Feb. 3, 2013	Muskogee Phoenix	Muskogee
Wed., Jan. 30, 2013	Muskogee Phoenix	Muskogee
Fri., Feb. 1, 2013	Sequoyah County Times	Sallisaw
Sun., Feb. 3, 2013	Okmulgee Daily Times	Okmulgee
Sat., Feb. 2, 2013	Cushing Citizen	Cushing
Wed., Jan. 30, 2013	Cushing Citizen	Cushing
Sun., Feb. 3, 2013	Stillwater News Press	Stillwater
Fri., Feb. 1, 2013	Bristow News & Record System	Bristow
Thurs., Jan. 30, 2013	The Journal (Perkins)	Perkins
Sun., Feb. 3, 2013	Enid News & Eagle	Enid
Tues., Feb. 5, 2013	Enid News & Eagle	Enid
Thurs., Jan. 31, 2013	Fairview Republican	Fairview
Fri., Feb. 1, 2013	Perry Daily Journal	Perry
Mon. Feb. 25, 2013	Guymon Daily Herald	Guymon
Sun., Mar. 3, 2013	Guymon Daily Herald	Guymon
Thurs., Feb. 21, 2013	Beaver Herald Democrat	Beaver
Tues., Feb. 19, 2013	Woodward News	Woodward
Mon., Feb. 25, 2013	Woodward News	Woodward

**Table B-1:
Scoping Notifications Placed with Print Media**

Notification Date	Media Outlet	Media Outlet Location
Sun., Mar. 3, 2013	Woodward News	Woodward
Thurs., Feb. 21, 2013	Mooreland Leader	Mooreland
Thurs., Feb. 28, 2013	Mooreland Leader	Mooreland
Arkansas		
Wed., Jan. 16, 2013	Jonesboro Sun	Jonesboro
Sun., Jan. 20, 2013	Jonesboro Sun	Jonesboro
Thurs., Jan. 10, 2013; Jan. 17, 2013	Harrisburg Modern News	Harrisburg
Thurs., Jan. 10, 2013; Jan. 17, 2013	Trumann Poinsett Co Democrat-Tribune	Trumann/Poinsett County
Wed., Feb. 6, 2013; Sat., Feb. 9, 2013	Van Buren Press Argus-Courier	Van Buren
Wed., Jan. 30, 2013; Feb. 6, 2013	Ozark Spectator	Ozark
Wed., Feb. 6, 2013	Fort Smith Times Record	Fort Smith
Sun., Feb. 10, 2013	Fort Smith Times Record	Fort Smith
Wed., Jan. 30, 2013; Feb. 6, 2013	Greenwood Democrat	Greenwood
Wed., Jan. 30, 2013; Feb. 6, 2013	Morrilton Conway County Headlight	Morrilton
Wed., Feb. 6, 2013	Russellville Courier	Russellville
Sun., Feb. 10, 2013	Russellville Courier	Russellville
Wed., Jan. 30, 2013; Feb. 6, 2013	Clarksville Johnson County Graphic	Clarksville
Thurs., Feb. 7, 2013; Feb. 14, 2013	Newport Independent	Newport
Thurs., Feb. 7, 2013; Feb. 14, 2013	North Central Arkansas Eagle/ Bald Knob Banner	Bald Knob
Wed., Feb. 13, 2013	Searcy Daily Citizen	Searcy
Fri., Feb. 15, 2013	Searcy Daily Citizen	Searcy
Sun., Feb. 17, 2013	Searcy Daily Citizen	Searcy
Thurs., Feb. 7, 2013; Feb. 14, 2013	Beebe News	Beebe

Table B-2:
Scoping Notifications Placed with Radio Stations in Oklahoma

Notification Date	Radio Station	Radio Station Location
Sun., Jan. 27, 2013	KKBS 92.7	Guymon
Mon., Jan. 28, 2013	KKBS 92.7	Guymon
Wed., Jan. 30, 2013	KWOX 101	Woodward
Thurs., Jan. 31, 2013	KWOX 101	Woodward
Sun., Feb. 3, 2013	KTFX	Muskogee
Mon., Feb. 4, 2013	KTFX	Muskogee
Sun., Feb. 3, 2013	KOKL	Okmulgee
Mon. Feb. 4, 2013	KOKL	Okmulgee
Tues., Feb. 5, 2013	KUSH	Cushing
Wed., Feb. 6, 2013	KXLS-FM	Enid
Thurs., Feb. 7, 2013	KXLS-FM	Enid

This page intentionally left blank.

Appendix C: Postcards and Email Announcements

This page intentionally left blank.

JOIN US AT AGENCY MEETINGS FOR THE PLAINS & EASTERN PROJECT

The U.S. Department of Energy will be holding three meetings (locations, dates and times below) for personnel of local, state and federal agencies to provide information on the Plains & Eastern Environmental Impact Statement (EIS) and to seek input on the range of issues to be considered in the EIS.

AGENCY MEETING INFORMATION

Open House: 1:00 p.m. – 4:00 p.m.

Presentation: 2:30 p.m. – 3:30 p.m.

Thursday, January 24, 2013	Tuesday, February 5, 2013	Tuesday, February 12, 2013
Gateway Baptist Church Center 1915 Rosemark Road Atoka, TN 38004	Cushing Youth and Community Center 700 South Little Cushing, OK 74023	Lake Point Conference Center, Event Center 61 Lake Point Lane Russellville, AR 72802

If you need special assistance at an agency meeting, please contact assistance@PlainsandEasternEIS.com. Attempts will be made to accommodate each request.

These meetings for agency personnel are in addition to the public scoping meetings which will be held at various locations across the project area between January 22, 2013 and February 21, 2013. Information on the public scoping meetings, as well as additional information about the project and maps identifying the potential routes proposed for analysis, may be found on the EIS website at: <http://PlainsandEasternEIS.com>

NOTICE OF INTENT

The U.S. Department of Energy intends to prepare an Environmental Impact Statement for the Plains & Eastern Clean Line Transmission Project (DOE/EIS-0486; Plains & Eastern EIS or EIS) to assess the potential environmental impacts of participating with Clean Line Energy Partners LLC in the proposed Plains & Eastern Project. The proposed project would include an overhead \pm 600 kilovolt high voltage direct current electric transmission system and associated facilities with the capacity to deliver approximately 3,500 megawatts primarily from renewable energy generation facilities in the Oklahoma Panhandle region to load-serving entities in the Mid-South and Southeast via an interconnection with the Tennessee Valley Authority. The proposed project would traverse Oklahoma, Arkansas, and Tennessee, a distance of approximately 700 miles between interconnection facilities in Texas County, Oklahoma, and Shelby County, Tennessee. The proposed project would require construction of a new alternating current/direct current converter station at each end of the transmission line.

Comments can be submitted by any of the following methods:

- **Attend a meeting** and provide a written comment
- **Electronic comment form** on the EIS website at: <http://PlainsandEasternEIS.com>
- **Email** to info@PlainsandEasternEIS.com
- **U.S. Mail** to Plains & Eastern EIS, 1099 18th Street, Suite 580, Denver, CO 80202

Comments must be submitted by March 21, 2013.

YOUR INPUT IS NEEDED!

JOIN US AT PUBLIC SCOPING MEETINGS FOR THE PLAINS & EASTERN PROJECT

The U.S. Department of Energy will be holding public scoping meetings to provide information on the Plains & Eastern Environmental Impact Statement (EIS) and seek input on the range of issues to be considered in the EIS (additional information on the other side of this postcard).

SCOPING MEETING INFORMATION

Open House: 5:00 p.m. – 8:00 p.m.

Presentation: 6:30 p.m. – 7:30 p.m.

Week 1: January 22 & 24, 2013

Tuesday, January 22, 2013
Arkansas State University
Marked Tree Student Center
33500 Highway 63 E
Marked Tree, AR 72365

Thursday, January 24, 2013
Gateway Baptist Church Center
1915 Rosemark Road
Atoka, TN 38004

Week 2: January 28, 29, & 31, 2013

Monday, January 28, 2013
Pickle Creek Center
822 NE 6th Street
Guymon, OK 73942

Tuesday, January 29, 2013
Beaver County Fairgrounds
Pavilion Building
1107 Douglas Avenue
Beaver, OK 73932

Thursday, January 31, 2013
Woodward Convention Center
Meeting Room 1
3401 Centennial Lane
Woodward, OK 73801

Week 3: February 4, 5, & 7, 2013

Monday, February 4, 2013
Muskogee Civic Center Room D
425 Boston Street
Muskogee, OK 74401

Tuesday, February 5, 2013
Cushing Youth and Community
Center
700 South Little
Cushing, OK 74023

Thursday, February 7, 2013
Enid Convention Hall
Grand Ballroom
301 South Independence
Enid, OK 73701

Week 4: February 11 & 12, 2013

Monday, February 11, 2013
Van Buren Public Library
1409 Main Street
Van Buren, AR 72956

Tuesday, February 12, 2013
Lake Point Conference Center, Event Center
61 Lake Point Lane
Russellville, AR 72802

Week 5: February 19 & 21, 2013

Tuesday, February 19, 2013
Arkansas State University
Newport Student Community Center
7648 Victory Boulevard
Newport, AR 72112

Thursday, February 21, 2013
Carmichael Community Center Auditorium
801 S. Elm
Searcy, AR 72143

If you need special assistance at a scoping meeting, please contact assistance@PlainsandEasternEIS.com. Attempts will be made to accommodate each request.

Plains & Eastern EIS
1099 18th Street, Suite 580
Denver, CO 80202

NOTICE OF INTENT and SCOPING MEETING ANNOUNCEMENT

The U.S. Department of Energy intends to prepare an Environmental Impact Statement for the Plains & Eastern Clean Line Transmission Project (DOE/EIS-0486; Plains & Eastern EIS or EIS) to assess the potential environmental impacts of participating with Clean Line Energy Partners LLC in the proposed Plains & Eastern Project. The proposed project would include an overhead \pm 600 kilovolt high voltage direct current electric transmission system and associated facilities with the capacity to deliver approximately 3,500 megawatts primarily from renewable energy generation facilities in the Oklahoma Panhandle region to load-serving entities in the Mid-South and Southeast via an interconnection with the Tennessee Valley Authority. The proposed project would traverse Oklahoma, Arkansas, and Tennessee, a distance of approximately 700 miles between interconnection facilities in Texas County, Oklahoma, and Shelby County, Tennessee. The proposed project would require construction of a new alternating current/direct current converter station at each end of the transmission line.

Additional information, including project area maps, may be found on the EIS website at: <http://PlainsandEasternEIS.com>

A series of scoping meetings will be held to provide the public the opportunity to comment on the scope of the planned EIS. The dates and locations for the scoping meetings can be found on the other side of this postcard. Please advise tenants or other parties that would benefit from attending these meetings.

Comments can be submitted by any of the following methods:

- **Attend a meeting** and provide a verbal or written comment
- **Electronic comment form** on the EIS website at: <http://PlainsandEasternEIS.com>
- **Email** to info@PlainsandEasternEIS.com
- **U.S. Mail** to Plains & Eastern EIS, 1099 18th Street, Suite 580, Denver, CO 80202

Comments must be submitted by March 21, 2013.

YOUR INPUT IS NEEDED!

ADDITIONAL SCOPING MEETING SCHEDULED FOR THE PLAINS & EASTERN PROJECT

SCOPING MEETING INFORMATION

Open House: 5:00 p.m. – 8:00 p.m.

Presentation: 6:30 p.m. – 7:30 p.m.

Monday, March 4, 2013

Woodward Convention Center
Exhibit Hall
3401 Centennial Lane
Woodward, Oklahoma 73801

If you need special assistance at the scoping meeting, please contact assistance@PlainsandEasternEIS.com. Attempts will be made to accommodate each request.

The U.S. Department of Energy (DOE) has scheduled an additional scoping meeting in **Woodward, Oklahoma**, on **March 4, 2013**, at the Woodward Convention Center.

The public scoping meeting is being held to provide information on the Plains & Eastern Environmental Impact Statement (EIS) and seek input on the range of issues to be considered in the EIS.

The DOE intends to prepare an EIS for the Plains & Eastern Clean Line Transmission Project (DOE/EIS-0486; Plains & Eastern EIS or EIS) to assess the potential environmental impacts of participating with Clean Line Energy Partners LLC in the proposed Plains & Eastern Project. The proposed project would include an overhead \pm 600 kilovolt high voltage direct current electric transmission system and associated facilities with the capacity to deliver approximately 3,500 megawatts primarily from renewable energy generation facilities in the Oklahoma Panhandle region to load-serving entities in the Mid-South and Southeast via an interconnection with the Tennessee Valley Authority. The proposed project would traverse Oklahoma, Arkansas, and Tennessee, a distance of approximately 700 miles between interconnection facilities in Texas County, Oklahoma, and Shelby County, Tennessee. The proposed project would require construction of a new alternating current/direct current converter station at each end of the transmission line.

Additional information, including project area maps, may be found on the EIS website at: <http://PlainsandEasternEIS.com>

A series of scoping meetings are being held to provide the public the opportunity to comment on the scope of the planned EIS. Please advise tenants or other parties that would benefit from attending these meetings.

Comments can be submitted by any of the following methods:

- **Attend the meeting** and provide a verbal or written comment
- **Electronic comment form** on the EIS website at: <http://PlainsandEasternEIS.com>
- **Email** to info@PlainsandEasternEIS.com
- **U.S. Mail** to Plains & Eastern EIS, 1099 18th Street, Suite 580, Denver, CO 80202

Comments must be submitted by March 21, 2013.

From: Plains & Eastern EIS Website <info=PlainsandEasternEIS.com@mail50.us1.mcsv.net> on behalf of Plains & Eastern EIS Website <info@PlainsandEasternEIS.com>
Sent: Wednesday, February 20, 2013 9:55 AM
To: [REDACTED]
Subject: We Need Your Comments on the Plains & Eastern EIS

[Plains & Eastern EIS](#)

Is this email not displaying correctly?
[View it in your browser.](#)



Plains & Eastern EIS

You are receiving this email because you signed up to receive information and updates about the Plains & Eastern EIS. Thank you for your interest in this project.

We Need Your Comments on the Scope of the EIS

The U.S. Department of Energy (DOE) invites you to [comment](#) on the scope of this EIS during a 90-day public comment period which started on December 21, 2012 and ends on March 21, 2013.

Additional Scoping Meeting Scheduled

The DOE has scheduled an additional public scoping meeting in Woodward, Oklahoma, on Monday, March 4, 2013, from 5 p.m. to 8 p.m. at the Woodward Convention Center. If you are not able to attend the public scoping meetings, you can still provide your [comments](#), [ask questions](#), and [view and download information](#) presented at the public scoping meetings.

Monday, March 4, 2013
Woodward Convention Center
Exhibit Hall
3401 Centennial Lane
Woodward, OK 73801

[Electronic comments](#) can be submitted via our website. Have questions? Email us at info@PlainsandEasternEIS.com

If you need special assistance please contact assistance@PlainsandEasternEIS.com.
Attempts will be made to accommodate each request.

Copyright © 2013 Plains & Eastern EIS
All rights reserved.

Plains & Eastern EIS
1099 18th Street, Suite 580
Denver, CO 80202

[unsubscribe from this list](#) | [update subscription preferences](#)

Sent to [REDACTED] — [why did I get this?](#)
[unsubscribe from this list](#) | [update subscription preferences](#)
Plains & Eastern EIS · 1099 18th Street, Suite 580 · Denver, CO 80202

The MailChimp logo is displayed in a dark grey rounded rectangle. The text "MailChimp" is written in a white, cursive script font.

Appendix D: Public Scoping Meeting Materials

This page intentionally left blank.



A new alternating current (AC)/direct current (DC) converter station would be built at each end of the transmission line. Each converter station would require the use of approximately 30 to 50 acres and would be located on private land. The converter stations are proposed to be located in Texas County, Oklahoma, and either Shelby County or Tipton County, Tennessee. The proposed project would include, in addition to the HVDC transmission line, four to six AC transmission lines of up to 345 kV.

The proposed project would also include the following major facilities and improvements:

- Right-of-way easements for the transmission line, with a typical width of approximately 150 to 200 feet for the HVDC line and potentially narrower for the AC transmission lines.
- Tubular or lattice steel structures used to support the transmission lines. For the HVDC line, structures typically would be between 120 and 200 feet tall depending on site-specific conditions. Limited quantities of taller structures may be required in some locations to address engineering constraints. Structures for the AC transmission lines may be shorter.
- Access roads, including improvements to existing roads, new overland access, and new unpaved temporary roads to access the proposed project facilities and work areas during the construction and operation phases.
- Ancillary facilities, such as communications facilities for access control and protection.

Potential Routes

In **Oklahoma**, the potential routes proposed by Clean Line begin in the central Oklahoma Panhandle and proceed in an east-southeasterly direction through generally rural areas between Oklahoma City and Tulsa, exiting the state in eastern Oklahoma near Sallisaw. In **Arkansas**, the potential routes proposed by Clean Line enter western Arkansas north of the city of Van Buren and proceed in an easterly direction through generally rural areas, exiting eastern Arkansas south of the city of Osceola, entering into Tennessee across the Mississippi River, at two potential crossing locations. In **Tennessee**, the potential routes proposed by Clean Line enter western Tennessee from Arkansas at the two potential Mississippi River crossing locations and generally proceed in a southeasterly direction along separate paths through generally rural and suburban areas of Tipton County and Shelby County. The map on the inside of this fact sheet provides an overview of the potential routes.

HOW TO PROVIDE COMMENTS ON THE EIS

Comments can be submitted by any of the following methods:

- **Attend a meeting** and provide a verbal or written comment
- **Electronic comment form** on the EIS website at: <http://PlainsandEasternEIS.com>
- **Email** to info@PlainsandEasternEIS.com
- **U.S. Mail** to Plains & Eastern EIS, 1099 18th Street, Suite 580, Denver, CO 80202

COMMENTS MUST BE SUBMITTED BY MARCH 21, 2013

January 2013

Plains & Eastern Clean Line Project Environmental Impact Statement

Background

Section 1222(b) of the Energy Policy Act of 2005 (EPA) authorizes the Secretary of Energy, acting through and in consultation with the Administrator of the Southwestern Power Administration (Southwestern) to participate with other entities in designing, developing, constructing, operating, maintaining, or owning new electric power transmission facilities and related facilities located within any state in which Southwestern operates, provided the Secretary determines that certain conditions have been met. Southwestern is one of four Power Marketing Administrations that operates within the Department of Energy (DOE). Southwestern is chartered to market and deliver power in the southwestern United States, including Arkansas and Oklahoma, to rural electric cooperatives and municipal utilities.

On June 10, 2010, DOE issued a Request for Proposals (RFP) for new or upgraded transmission projects pursuant to Section 1222 (75 FR 32940). Clean Line Energy Partners LLC of Houston, Texas, the parent company of Plains and Eastern Clean Line LLC and Plains and Eastern Clean Line Oklahoma LLC (collectively referred to as Clean Line), responded to the RFP, providing a description of the proposed project and supporting information. Clean Line's proposal includes a single high voltage direct current (HVDC) line with the capacity to deliver 3,500 megawatts (MW). DOE has concluded that Clean Line's proposal complied with and was responsive to the RFP.

Prior to making a determination whether to participate in the proposed project, DOE must fully evaluate the proposed project, in consultation with Southwestern, including reviewing the potential environmental impacts pursuant to the National Environmental Policy Act (NEPA) and the requirements of Section 1222(b). DOE is preparing the Plains & Eastern EIS pursuant to NEPA, the Council on Environmental Quality NEPA regulations (40 CFR parts 1500 through 1508), and the DOE NEPA implementing regulations (10 CFR part 1021).

More information on the proposed project, including updates, can be found at <http://PlainsandEasternEIS.com>.

Purpose and Need for Agency Action

DOE's purpose and need for agency action is to implement Section 1222(b) of the EPA Act. To that end, DOE needs to decide whether and under what conditions to participate in Clean Line's proposed Plains & Eastern Project.

In the Plains & Eastern EIS, DOE will analyze the potential environmental impacts of a range of reasonable alternatives that could comprise the proposed project. DOE will also identify possible mitigation strategies for potential environmental impacts.

Project Overview

The proposed project would include an overhead \pm 600 kilovolt (kV) HVDC electric transmission system with the capacity to deliver approximately 3,500 MW from the Oklahoma Panhandle region to load-serving entities in the Mid-South and Southeast. The proposed project would traverse Oklahoma, Arkansas, and Tennessee, a distance of approximately 700 miles. The western portion of the proposed project would interconnect to the transmission system operated by the Southwest Power Pool in Texas County, Oklahoma. The eastern portion of the proposed project would interconnect to the transmission system operated by the Tennessee Valley Authority (TVA) in Shelby County, Tennessee. TVA would make the necessary upgrades to its transmission system, which could include construction and operation of new transmission lines and substations and upgrades to existing transmission lines and substations.

PLAINS & EASTERN CLEAN LINE

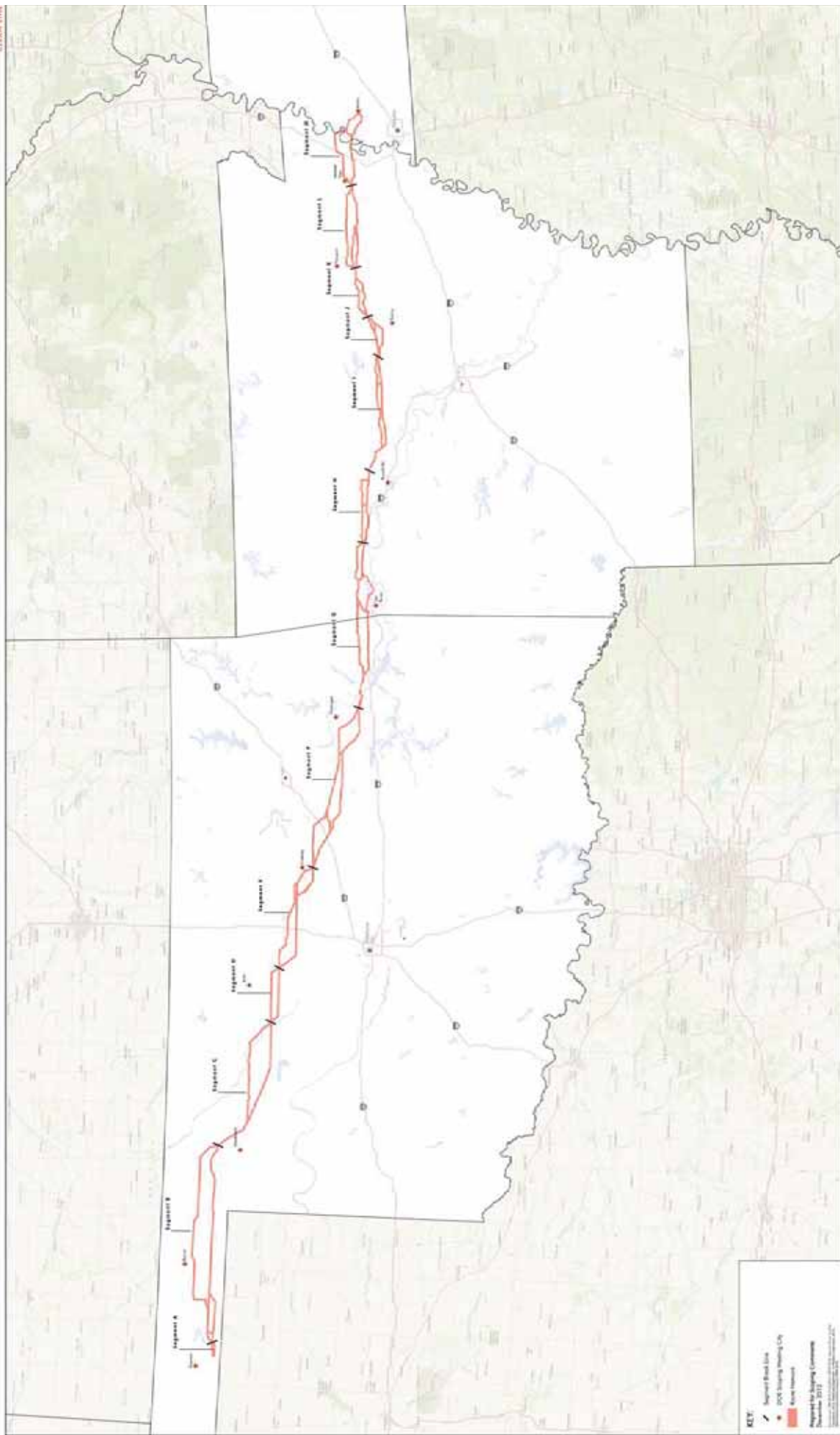

KEY

- Segment Road Line
- APCC Energy Storage City
- State Boundary
- Proposed for Segment 12 Corridor

December 2017



How Does NEPA Work?

Early in its planning process for a proposed action, DOE considers how to comply with the National Environmental Policy Act (NEPA). The appropriate level of review depends on the significance, that is, consideration of the context and intensity of the potential environmental impacts associated with the proposed action. There are three levels of NEPA review:

- **Environmental Impact Statement (EIS)** – For major Federal actions that may significantly affect the quality of the human environment, NEPA requires preparation of an EIS. An EIS is a detailed analysis of the potential environmental impacts of a proposed action and the range of reasonable alternatives. Public participation is an important part of the EIS process.
- **Environmental Assessment (EA)** – When the need for an EIS is unclear, an agency may prepare an EA to determine whether to prepare an EIS or to issue a Finding of No Significant Impact. An EA is a brief analysis. DOE's procedures provide notification and comment opportunities for host states and tribes. DOE also may provide notification and comment opportunities for other interested people. DOE then considers any comments received, makes revisions as appropriate, and issues the EA.
- **Categorical Exclusion** – DOE's NEPA regulations list classes of actions that normally do not require an EIS or an EA because, individually or cumulatively, they do not have the potential for significant environmental impacts. Examples are information gathering activities and property transfers when the use is unchanged.

How Can I Learn More?

We encourage you to learn more about NEPA, the EIS process, and DOE's current NEPA activities by visiting or contacting the following:

- **DOE's NEPA website** at nepa.energy.gov – to learn about upcoming opportunities to participate in DOE's NEPA process, download DOE NEPA documents, and find requirements and guidance that DOE follows for NEPA implementation.
- **DOE's Office of NEPA Policy and Compliance** at askNEPA@hq.doe.gov or at 1-800-472-2756 (toll-free) – to leave a message regarding EIS-specific or general NEPA information.
- **The Council on Environmental Quality's NEPA website** at www.nepa.gov – for government-wide NEPA information.

DOE, NEPA, and You

A Guide to Public Participation

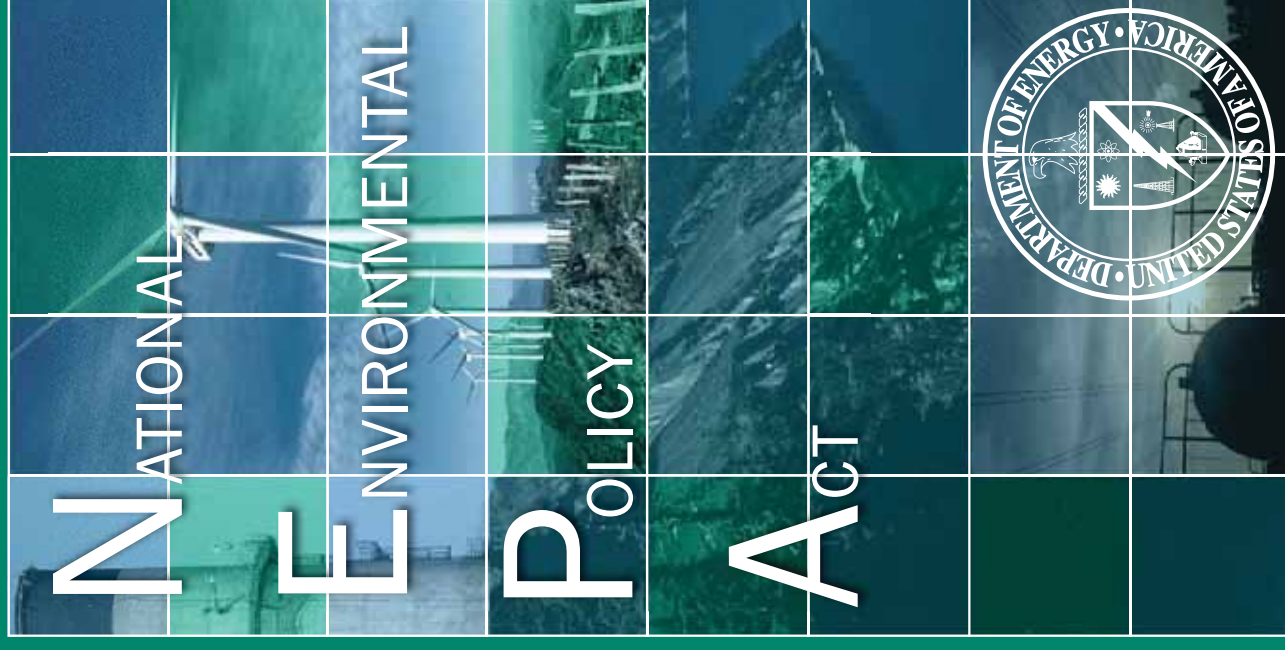

Office of NEPA
Policy and Compliance
2010



Printed on recycled paper

The U.S. Department of Energy (DOE) prepared this brochure to encourage and help you to participate in the National Environmental Policy Act (NEPA) process. All Federal agencies must comply with NEPA, but their procedures vary. This brochure describes DOE's NEPA process, focusing on your role in DOE's preparation of Environmental Impact Statements (EISs).

What is NEPA?

NEPA is a Federal law that serves as the Nation's basic charter for environmental protection. It requires that all Federal agencies consider the potential environmental impacts of their proposed actions. NEPA promotes better agency decisionmaking by ensuring that high quality environmental information is available to agency officials and the public before the agency decides whether and how to undertake a major Federal action. Through the NEPA process, you have an opportunity to learn about DOE's proposed actions and to provide timely information and comments to DOE.

To implement NEPA, all Federal agencies follow procedures issued by the President's Council on Environmental Quality in the Code of Federal Regulations (40 CFR Parts 1500-1508). DOE also follows its own supplementary procedures, found in 10 CFR Part 1021.

How Does DOE Prepare an EIS?

The EIS process consists of several steps, each with opportunities for you to be involved.

- **Notice of Intent.** First, DOE publishes a Notice of Intent to prepare an EIS in the *Federal Register* and makes local announcements. This notice states the need for action and provides preliminary information on the EIS scope, including the alternative actions to

be evaluated, the kinds of potential environmental impacts to be analyzed, and related issues. The Notice of Intent also serves as the beginning of the next step, the "scoping process."

TIP: The Notice of Intent explains how you can participate in the scoping process and provides information about dates and locations of public meetings.

- **Scoping Process.** DOE requests your comments on the scope of the EIS. What alternatives should be evaluated? What potential environmental impacts should be analyzed? DOE's scoping process will last at least 30 days, with at least one public meeting.

TIP: During the scoping process, tell DOE what EIS information you would like to receive (e.g., a summary of the EIS or the full document on CD or on paper, or notification of Web posting).

- **Draft EIS.** DOE considers scoping comments in preparing a Draft EIS. An EIS (Draft or Final) analyzes and compares the potential environmental impacts of the various alternatives, one of which is always a "no action" alternative. The EIS also discusses ways to avoid or reduce adverse impacts. A Draft EIS will identify DOE's preferred alternative(s) if known at the time.

TIP: DOE EIS schedules and related NEPA information are available at nepa.energy.gov. DOE often has EIS-specific websites as well.

- **Public Comment on the Draft EIS.** After DOE issues a Draft EIS, the U.S. Environmental Protection Agency (EPA) publishes a Notice of Availability in the *Federal Register* to begin the public comment period, which will last at least 45 days. DOE also will announce details regarding how you may comment on the Draft EIS, either orally at a public hearing (at least one must be held) or in writing.

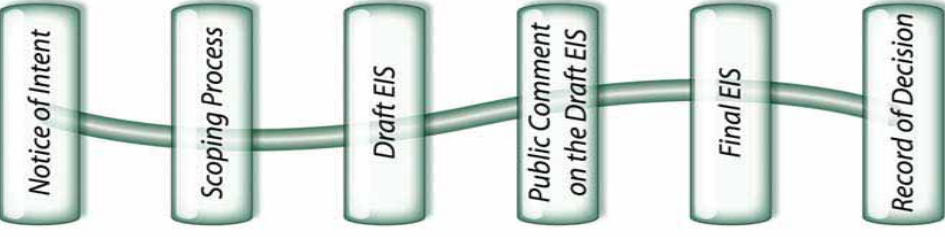

TIP: Check your local paper, the DOE NEPA website (nepa.energy.gov, under "NEPA News" or click on "Public Participation Calendar"), or other DOE notices for information about public hearings and ways to submit comments.

- **Final EIS.** DOE considers all timely public comments on the Draft EIS in preparing the Final EIS, which must respond to such comments. The Final EIS identifies DOE's preferred alternative(s). After DOE issues the Final EIS, EPA publishes a Notice of Availability in the *Federal Register*.

- **Record of Decision.** DOE must wait at least 30 days after the EPA Notice of Availability of the Final EIS before issuing a Record of Decision. A Record of Decision announces and explains DOE's decision and describes any commitments for mitigating potential environmental impacts.

TIP: DOE publishes Records of Decision in the *Federal Register* and makes them available on the DOE NEPA website. You may also ask DOE to send you a copy.

PUBLIC SCOPING MEETING

Welcome to the Public Scoping Meeting!

The purpose of this meeting is to:

- Provide information on the Plains & Eastern Environmental Impact Statement (EIS)
- Seek your input on the range of issues that should be considered in the EIS

Meeting Schedule

- Open House: 5:00 p.m. - 8:00 p.m.
- Presentation: 6:30 p.m. - 7:30 p.m.

You may submit comments on the scope of the Plains & Eastern EIS to a court reporter between 5:00 p.m. and 8:00 p.m.



U.S. DEPARTMENT OF **ENERGY** PLAINS & EASTERN EIS

HOW TO PROVIDE COMMENTS

Please Provide Us With Your Comments

Comments can be submitted using any of the following methods:

- Submit comments on the scope of the Plains & Eastern EIS to the **court reporter** between 5:00 p.m. and 8:00 p.m.
- Place your completed comment form in the **comment box** at this meeting
- **Mail** your comments to:
Plains & Eastern EIS
1099 18th Street, Suite 580
Denver, CO 80202
- **Email** your comments to:
info@plainsandeasterneis.com
- Submit your comments via the Plains & Eastern EIS **website**:
<http://PlainsandEasternEIS.com>

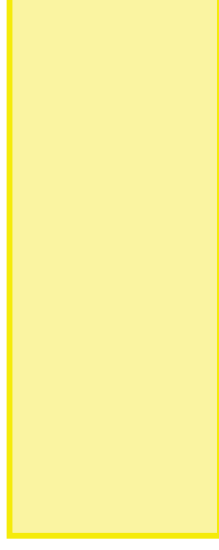

Thank you for your input!



ENERGY PLAINS & EASTERN EIS

NEPA EIS PROCESS

Understanding the NEPA EIS Process

The Department of Energy (DOE) is preparing an Environmental Impact Statement (EIS) under the National Environmental Policy Act (NEPA).

NEPA requires federal agencies to consider and disclose how their actions may impact the environment including natural, cultural, and socioeconomic resources prior to making a decision.

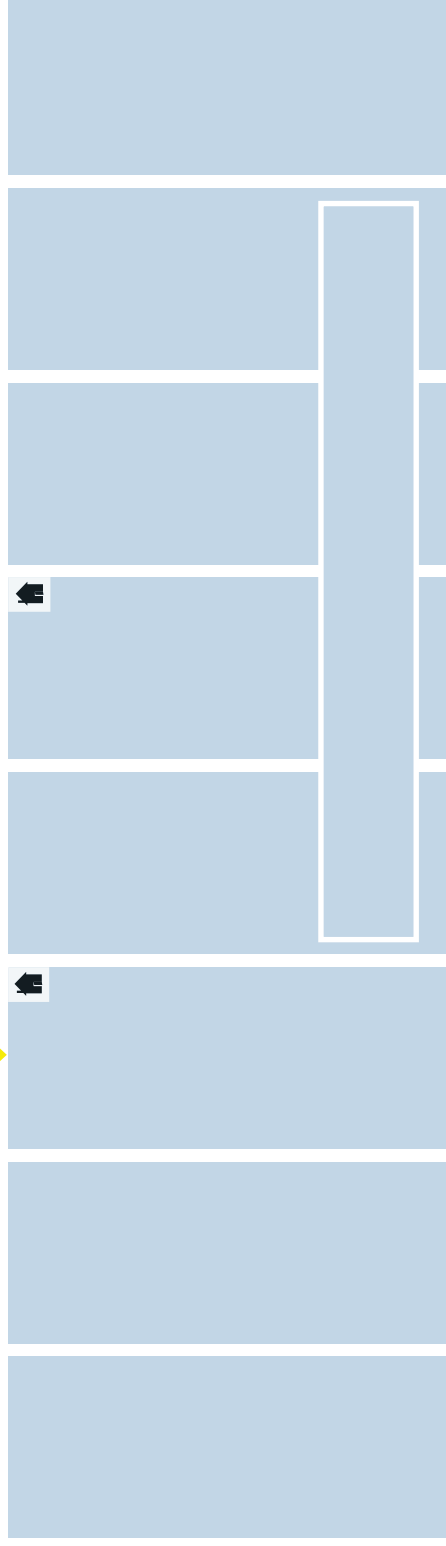
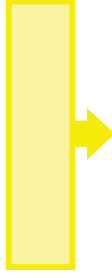

 = Opportunity for Public Involvement



Potential Impacts to be Analyzed in the EIS

DOE proposes to analyze potential short-term and long-term environmental impacts such as those from constructing, operating, and maintaining the transmission line and related facilities for the Plains & Eastern Project.

The following is a preliminary list of resource areas for evaluation in the EIS:

- Land Use, Recreation, and Visual Resources
- Water Use and Water Quality
- Surface Water Features, including Rivers, Floodplains, and Wetlands
- Fish, Wildlife, and Vegetation, including Critical Habitat
- Socioeconomics
- Environmental Justice
- Historic and Cultural Resources
- Geology, Soil, and Mineral Resources
- Human Health and Electric and Magnetic Fields
- Air Quality and Climate Change
- Construction-Related Impacts, including Road Clearing, Traffic and Noise
- Accidents, Intentional Destructive Acts, and Hazards, including Air Space Management
- Waste Management

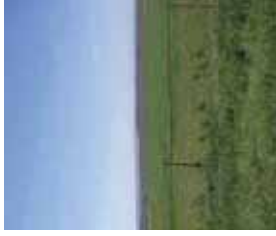

NEPA ALTERNATIVES



Consideration of Reasonable Alternatives Under the National Environmental Policy Act (NEPA)

The Environmental Impact Statement (EIS) will analyze the potential environmental impacts of a range of reasonable alternatives that could comprise the project.

- The U.S. Department of Energy (DOE) has reviewed Clean Line's (the applicant's) siting process and their network of potential routes and determined that they provide a sufficient initial basis for the EIS.
- DOE will consider additional reasonable alternatives proposed in scoping comments and may expand or refine the range of alternatives based on those comments.
- The EIS also will analyze a No Action alternative, under which DOE would not participate with Clean Line in the proposed project. Under the No Action alternative, for analytical purposes, DOE assumes the Plains & Eastern Project would not move forward and none of the environmental impacts associated with the proposed project would occur.



THE PROJECT PARTICIPANTS

 <p>U.S. DEPARTMENT OF ENERGY</p>	 <p>CLEAN LINE ENERGY PARTNERS</p>
<p>On June 10, 2010, the U.S. Department of Energy (DOE) issued a Request for Proposals (RFP) for new or upgraded transmission projects pursuant to Section 1222 of the Energy Policy Act 2005.</p> <p>DOE reviewed the proposal submitted by Clean Line Energy Partners LLC for the Plains & Eastern Clean Line Transmission Project.</p> <p>Before deciding whether to participate in the project, DOE must review the potential environmental impacts in accordance with the National Environmental Policy Act (NEPA), in addition to Section 1222(b), including independent review of information provided by Clean Line.</p>	<p>Proposed the Plains & Eastern Clean Line Transmission Project in response to DOE's RFP.</p>
<p>Provide technical and environmental information regarding the proposed project.</p>	



U.S. DEPARTMENT OF
ENERGY PLAINS & EASTERN EIS

PURPOSE AND NEED AND PROPOSED ACTION

Purpose and Need for Agency Action

The U.S. Department of Energy's (DOE) purpose and need for agency action is to implement Section 1222(b) of the Energy Policy Act of 2005 (EPAAct). To that end, DOE needs to decide whether and under what conditions to participate in Clean Line's proposed Plains & Eastern Project.

Proposed Project to be Analyzed

The proposed project is intended to provide new transmission capacity to meet the actual or projected increase in demand for additional electric transmission capacity. Clean Line is proposing the Plains & Eastern Project, which would include an overhead \pm 600 kilovolt high voltage direct current electric transmission system and associated facilities with the capacity to deliver approximately 3,500 megawatts, primarily from renewable energy generation facilities in the Oklahoma Panhandle region to load-serving entities in the Mid-South and Southeast via an interconnection with the Tennessee Valley Authority.



UNDERSTANDING WIND ENERGY & HVDC

U.S. Wind Resources and Transmission

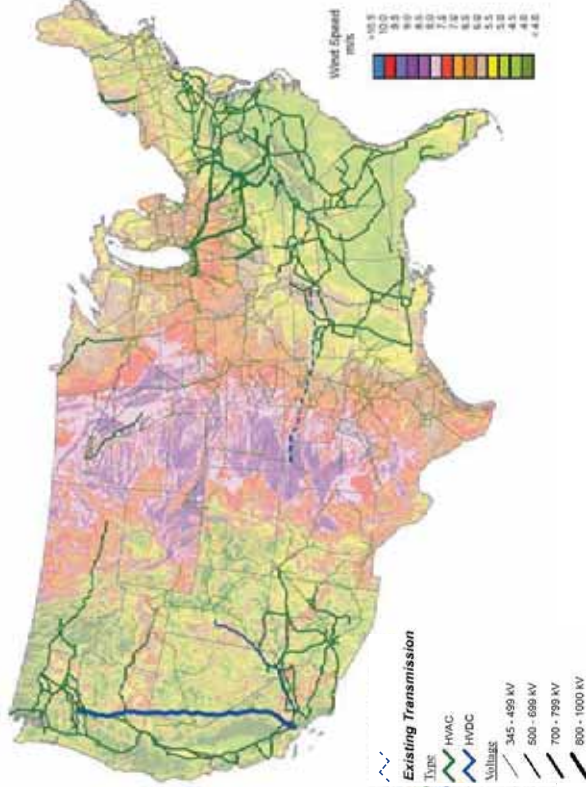

Characteristics of high-voltage direct current (HVDC) Transmission

- Transfers power with lower line losses than alternating current (AC) lines moving a comparable amount of power over long distances
- Provides the operator complete control over power flow, increasing reliability and ability to handle variable generation sources
- Use of HVDC allows narrower right-of-way and less infrastructure than AC lines for the same amount of energy transfer
- Operational and reliability characteristics allow more efficient collection and delivery of wind energy

How does the Plains & Eastern Clean Line HVDC transmission line fit into the grid?

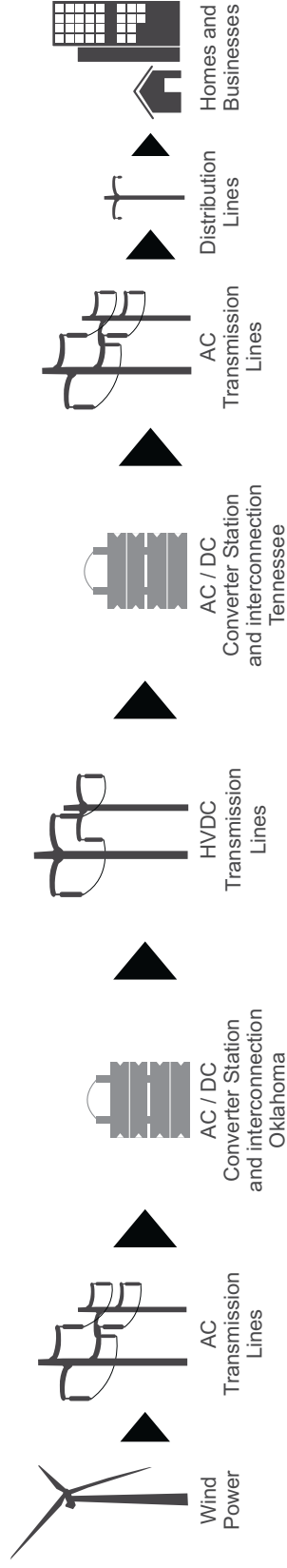

PLAINS & EASTERN EIS

TYPICAL HVDC STRUCTURES

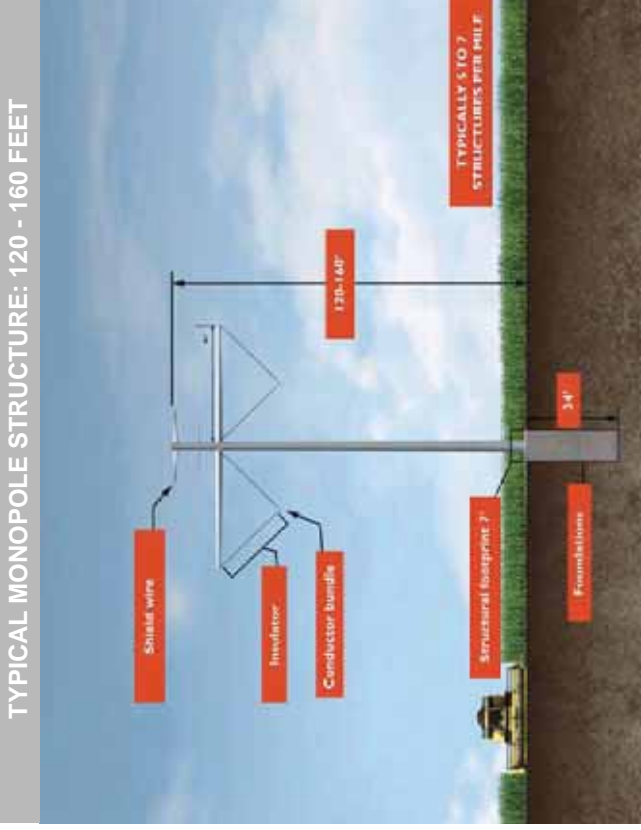
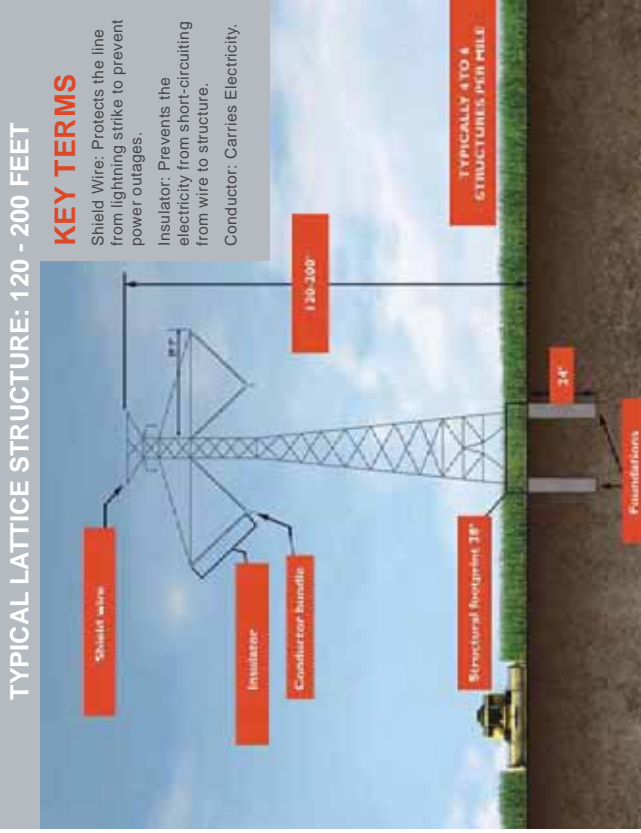

These diagrams depict the typical size, design and appearance of HVDC transmission structures. Variations may be required depending on public and regulatory review. Also, structures of other sizes, design and appearance may be needed due to topography, soil condition, cost consideration, span length and other factors.

This photo depicts a substation and +/- 400 kV DC converter station near Buffalo, MN. This photo is representative only. It is meant to show a site that is roughly comparable to the AC/DC converter stations that will be part of the Project.



TYPICAL RIGHT-OF-WAY EASEMENTS

TYPICAL EASEMENT



WHAT IS AN EASEMENT?

- Where the transmission line right-of-way crosses private property, an easement is required.
- An easement is a legal agreement that grants the owner/operator of the transmission line the right to enter and occupy a specified area of land for constructing, operating and maintaining the transmission line.
- The landowner retains title to the land and may continue to use the easement area in ways that are compatible with the transmission line.

WHAT IS THE EASEMENT ACQUISITION PROCESS?

The acquisition process includes:

- Survey Permission
- Compensation
- Construction
- Operation and Maintenance

THE AMOUNT OFFERED FOR AN EASEMENT IS PRIMARILY BASED ON:

- Value of surface property based on comparable sales or appraisals in local area
- Size of easement area and location of infrastructure
- Impacts during construction
- Conditions specific to the parcel

WHAT USES ARE COMPATIBLE WITH THE TRANSMISSION LINE AND MAY OCCUR IN THE EASEMENT AREA?

Ranching and farming activities, gardening, recreational activities, and other compatible uses may be permitted in the easement area. Transmission lines are designed and constructed to meet or exceed the requirements of the National Electrical Safety Code. These standards provide for the safety and protection of landowners and their property, the public, and maintenance workers. No buildings or structures may be erected in the easement area because they could impede the safe operation of the line or interfere with maintenance access.



U.S. DEPARTMENT OF
ENERGY

PLAINS & EASTERN EIS

NETWORK OF POTENTIAL ROUTES

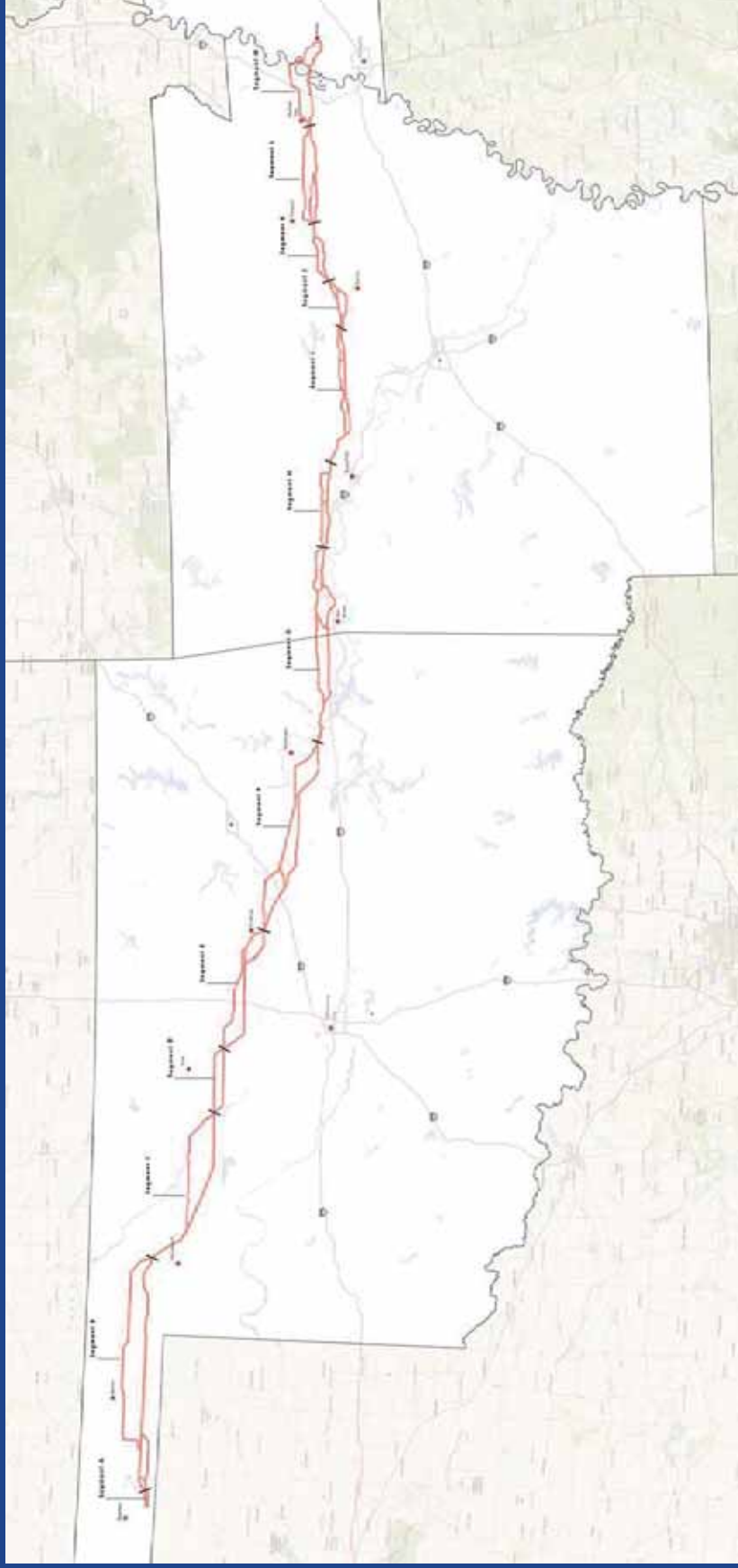

KEY:

- ✓ Segment Break Line
- ★ DOE Scoping Meeting City
- Route Network

Prepared for Scoping Comments
December 2012

Data Source: © 2012 U.S. Department of Energy. All rights reserved.
Government of the United States of America. 2012.
U.S. Department of Energy. 2012.



**Note: The Route Network is the area where the Project transmission line right-of-way could be routed. This area varies in width due to various sensitivities or opportunities, but generally is based on a 1-mile corridor.*

PLAINS & EASTERN
CLEAN LINE



U.S. DEPARTMENT OF ENERGY

PLAINS & EASTERN EIS

Appendix E: Public Scoping Comment Form

This page intentionally left blank.

Plains & Eastern Environmental Impact Statement



Scoping Comment Form

Must be received on or before March 21, 2013

Note: If you have a comment on a specific location or route segment(s), please identify them below. Route segment identifiers (e.g., B-4) can be found on sheet maps at the scoping meeting or on the project website (see address below).

Name: _____

Organization: _____

Address: _____

City: _____ State: _____ ZIP Code: _____

Email Address: _____

Please use the other side if more space is needed.

Comment forms may be **mailed** to:
Plains & Eastern Clean Line EIS
1099 18th Street, Suite 580
Denver, CO 80202

Comments may be **sent by electronic mail** to:
info@PlainsandEasternEIS.com

You may also submit comments through the project website which can be found at:
<http://PlainsandEasternEIS.com>

APPENDIX F

PROJECT DESCRIPTION



This page intentionally left blank.



Draft Project Description

for the

PLAINS & EASTERN
CLEAN LINE

Subject to Revision

Revision 3.1
September 2015

DRAFT



This page intentionally left blank.

Table of Contents

<u>Section</u>	<u>Page</u>
List of Tables	v
List of Figures	vii
Acronyms and Abbreviations	ix
1.0 Project Overview	1
2.0 Project Description	5
2.1 Converter Stations and Other Terminal Facilities.....	5
2.1.1 Elements Common to the Converter Stations.....	5
2.1.2 Oklahoma Converter Station and Other Terminal Facilities	7
2.1.3 Tennessee Converter Station and Other Terminal Facilities	8
2.1.4 Arkansas Converter Station Alternative and Other Terminal Facilities	9
2.2 HVDC Transmission Line.....	13
2.2.1 Right-of-Way.....	15
2.2.2 Structures	15
2.2.3 Conductor	16
2.2.4 Metallic Return.....	16
2.2.5 Optical Ground Wire and Static Wire	16
2.2.6 Communication Facilities.....	17
2.2.7 Fiber Optic Regeneration Sites.....	17
2.3 AC Collection System	18
2.3.1 Right-of-Way.....	20
2.3.2 Structures	20
2.3.3 Conductor	20
2.3.4 Optical Ground Wire and Static Wire	21
2.3.5 Communication Facilities.....	21
2.3.6 Fiber Optic Regeneration Sites.....	21
2.4 Access Roads.....	21
2.4.1 Existing Access Roads.....	22
2.4.2 New Access Roads.....	22
3.0 Typical Construction.....	29
3.1 HVAC/HVDC Converter Station Construction.....	29
3.2 HVDC and AC Transmission Line Construction.....	33
3.2.1 Temporary Construction Areas.....	38
3.2.1.1 Tensioning or Pulling Sites.....	42
3.2.1.2 Multi-use Construction Yards.....	42
3.2.1.3 Fly Yards.....	43
3.2.1.4 Wire Splicing Sites	43
3.2.1.5 Concrete Batch Plants	44

3.2.2	Preparation of the Transmission Line Right-of-Way	44
3.2.3	Clearing and Grading Activities	44
3.2.4	Foundation Excavation and Installation.....	45
3.2.5	Structure Assembly and Erection.....	47
3.2.6	Conductor Stringing.....	47
3.2.7	Grounding.....	48
3.2.8	Cleanup and Restoration	48
3.3	Access Road Construction.....	49
3.3.1	Specialized Road Construction Techniques.....	49
3.4	Construction of AC Interconnections and Related Upgrades.....	52
3.5	Hazardous Materials Handling and Disposal	53
3.6	Gravel Sources.....	53
4.0	Operations and Maintenance	55
4.1	Operational Characteristics.....	55
4.2	Permitted Uses within the Right-of-Way.....	55
4.3	Transmission Line Maintenance Program	56
4.4	Vegetation Management Program.....	58
4.5	Right of Way Management Program.....	60
4.6	Safety and Reliability	60
5.0	Decommissioning	61
6.0	References	62

Appendices

- Appendix A Figures
- Appendix B Environmental Protection Measures
- Appendix C Workforce, Crews, Equipment, and Trips
- Appendix D Drilling Fluids
- Appendix E Water Uses

List of Tables

<u>Table</u>	<u>Page</u>
Table 1-1 Location of Applicant Proposed Route and Project Facilities by State and County.....	3
Table 2-1 Oklahoma Converter Station and Associated Facilities Dimensions and Land Requirements.....	10
Table 2-2 Tennessee Converter Station and Associated Facilities Dimensions and Land Requirements.....	11
Table 2-3 Arkansas Converter Station Alternative and Associated Facilities Dimensions and Land Requirements.....	12
Table 2-4 HVDC Transmission Line Facility Dimensions and Land Requirements.....	13
Table 2-5 AC Collection System Oklahoma Panhandle Region Transmission Lines Facility Dimensions and Land Requirements ¹	18
Table 2-6 Access Roads Facility Dimensions and Land Requirements.....	23
Table 2-7 Estimated Access Road Miles by Road Type and Analysis Region for HVDC Transmission Line	26
Table 2-8 Estimated Access Road Miles by Road Type for AC Interconnection Lines and HVDC Converter Stations	27
Table 2-9 Estimated Access Road Miles by Road Type for AC Collection System	27
Table 3-1 Typical HVDC Converter Station, Estimated Equipment.....	31
Table 3-2 Typical HVDC Segment Construction Equipment	35
Table 3-3 Temporary Construction Areas.....	38

This page intentionally left blank.

List of Figures

Appendix A, “Figures,” contains all of the figures.

Figure

- 1-1 Project Overview
- 2-1 Clean Line Converter Station General Layout
- 2-2a Oklahoma Converter Station Siting Area Property Location
- 2-2b Oklahoma Converter Station Siting Area Property Aerial
- 2-3a Tennessee Converter Station Siting Area Property Location
- 2-3b Tennessee Converter Station Siting Area Property Aerial
- 2-4 Arkansas Converter Station Alternative Siting Area
- 2-5 HVDC Alternatives
- 2-6 AC Alternatives
- 2-7 DC R.O.W. Limits
- 2-8a 600kV Lattice Deadend
- 2-8b 600kV Lattice Running Angle
- 2-8c 600kV Lattice Tangent
- 2-9 600kV DC Lattice Work Area
- 2-10 600kV DC Lattice Foundation and Structure Construction Activities – Plan View
- 2-11a 600kV Monopole Deadend
- 2-11b 600kV Monopole Running Angle
- 2-11c 600kV Monopole Tangent
- 2-12 600kV DC Monopole Work Area
- 2-13 600kV DC Monopole Foundation and Structure Construction Activities – Plan View
- 2-14a 600kV Guyed Mast Tubular Tangent
- 2-14b 600kV Guyed V-Tube Tangent
- 2-14c 600kV Guyed Monopole Tangent
- 2-14d 600kV Guyed Chainette Tangent
- 2-14e 600kV Guyed Mast Lattice Tangent
- 2-14f 600kV Guyed V-Lattice Tangent
- 2-15 600kV Lattice Crossing Structure
- 2-16 Conductor and Ground-Wire Stringing Activities
- 2-17 Regeneration Station Plan
- 2-18 Multi-Use Construction Yard
- 2-19 AC R.O.W. Limits
- 2-20a 345kV Lattice Deadend
- 2-20b 345kV Lattice V-String
- 2-21a 500kV Lattice Deadend
- 2-21b 500kV Lattice V-String
- 2-22 345kV Lattice Work Area
- 2-23 345kV Lattice Foundation and Structure Construction Activities – Plan View
- 2-24a 345kV 3-Pole Guyed Deadend

- 2-24b 345kV 3-Pole Deadend
- 2-24c 345kV 3-Pole Guyed Running Angle
- 2-24d 345kV 3-Pole Running Angle
- 2-24e 345kV Double Circuit Pole Deadend
- 2-24f 345kV Double Circuit Pole V-String
- 2-24g 345kV Single Circuit Guyed Pole DE
- 2-24h 345kV Single Circuit Pole Deadend
- 2-24i 345kV Pole Braced Post
- 2-24j 345kV Single Circuit Pole V-String
- 2-25a 500kV 3-Pole Guyed Deadend
- 2-25b 500kV 3-Pole Deadend
- 2-25c 500kV 3-Pole Guyed Running Angle
- 2-25d 500kV 3-Pole Running Angle
- 2-25e 500kV Double Circuit Pole Deadend
- 2-25f 500kV Double Circuit Pole V-String
- 2-25g 500kV Single Circuit Guyed Pole DE
- 2-25h 500kV Single Circuit Pole Deadend
- 2-25i 500kV Pole Braced Post
- 2-25j 500kV Single Circuit Pole V-String
- 2-26 345kV Monopole Work Area
- 2-27a 345kV Braced H-Frame
- 2-27b 345kV H-Frame Tangent
- 2-27c 345kV H-Frame V-String
- 2-28 Typical Access Roads
- 2-29 HVDC Transmission Line Construction Sequence
- 3-1 Resource Loading per HVDC Converter Station Construction
- 3-2 Peak Local Traffic per HVDC Converter Station Construction
- 3-3 Local vs. Non-Local Labor (HVDC Converter Station)
- 3-4 Equipment Emissions Calculation Data Sheet (HVDC Converter Station)
- 3-5 Resource Loading per 140 mile HVDC Segment
- 3-6 Resource Loading for AC Collection System
- 3-7 Peak Local Traffic per 140 mile HVDC Segment
- 3-8 Local vs. Non-Local Labor (140 mile HVDC Segment)
- 3-9 Resource Loading for Entire Project
- 3-10 Equipment Use by 140 mile HVDC Segment
- 3-11 Equipment Emissions Calculation Data Sheet (140 mile HVDC Segment)

Acronyms and Abbreviations

AC	alternating current
ATV	all-terrain vehicle
Clean Line	Clean Line Energy Partners LLC of Houston, Texas, (parent company of Plains and Eastern Clean Line LLC and Plains and Eastern Clean Line Oklahoma LLC, which two entities are collectively referred to herein as “Clean Line”)
DC	direct current
DOE	United States Department of Energy
EIS	Environmental Impact Statement
HVDC	high-voltage direct current
ISO	Independent System Operator
kV	kilovolt(s)
MISO	Midcontinent Independent System Operator
MW	megawatt(s)
NERC	North American Electric Reliability Corporation
NESC	National Electrical Safety Code
OPGW	optical ground wire
Project, the	Plains & Eastern Clean Line transmission project
ROW	right-of-way
RTO	Regional Transmission Organization
SFHA	Special Flood Hazard Area
SPP	Southwest Power Pool, Inc.
SWPPP	Stormwater Pollution Prevention Plan
TVA	Tennessee Valley Authority

This page intentionally left blank.

Please note: The following project description contains forward-looking statements and anticipated typical designs based on current knowledge. These descriptions are subject to change as further transmission planning, environmental permits, and engineering studies progress.

1.0 Project Overview

Clean Line Energy Partners LLC of Houston, Texas, (parent company of Plains and Eastern Clean Line LLC and Plains and Eastern Clean Line Oklahoma LLC, which are two entities collectively referred to herein as “Clean Line”) prepared this document to describe proposed project facilities and land needs, as well as construction, operation and decommissioning activities for the proposed Plains & Eastern Clean Line transmission project (the Project). The United States Department of Energy (DOE) will use this description to evaluate the potential direct, indirect, and cumulative impacts of the Project.

The proposed Project is an overhead \pm 600 kilovolt (kV) high-voltage direct current (HVDC) electric transmission system and associated facilities with the capacity to deliver approximately 3,500 megawatts (MW) from renewable energy generation facilities in the Oklahoma Panhandle region to load serving entities in the Mid-South and southeastern United States via an interconnection with Tennessee Valley Authority (TVA) in Tennessee and 500 MW to the Midcontinent Independent System Operator (MISO) in Arkansas.

A summary of the Project’s major facilities and improvements follows:

- **Converter Stations:** Two alternating current (AC)/direct current (DC) converter stations, one at each end of the transmission line. Clean Line proposes to locate the converter stations in Texas County, Oklahoma, and Shelby County, Tennessee. Clean Line is studying an intermediate converter station in Pope County, Arkansas.¹ Transmission facilities will be required between each converter station and the point of interconnection to the existing AC grid, as follows:
 - One double circuit 345kV AC transmission line connecting to the future Xcel Energy/Southwestern Public Service Co. Optima² substation in Oklahoma.
 - Two 500kV AC ties connecting to bays within the TVA Shelby substation in Tennessee.
 - One 500kV AC transmission line connecting to a point along an existing 500kV transmission line in Arkansas.
- **HVDC Transmission Facilities:** A \pm 600kV HVDC overhead electric transmission line with the capacity to deliver approximately 3,500MW to the TVA and 500MW to an intermediate substation. Components of the HVDC transmission facilities include:
 - Tubular and lattice steel structures used to support the transmission line.
 - Communications/Control and protection facilities (optical ground wire [OPGW] and fiber optic regeneration sites).
 - Right-of-way (ROW) easements for the transmission line, with a typical width of approximately 150 to 200 feet.

¹ Based on comments received by the DOE during the public scoping period for the Environmental Impact Statement (EIS) held by the DOE, Clean Line is considering an alternative converter station in Arkansas.

² Optima substation was formerly known as “Hitchland #2” during the early planning phases for the Project.

- **AC Transmission Facilities:** To facilitate efficient interconnection of wind generation, four to six AC collection lines of up to 345kV from the Oklahoma converter station to points in the Oklahoma Panhandle region. Components of the AC facilities include:
 - Tubular or lattice steel structures used to support the transmission line;
 - Communications facilities;
 - Control and protection facilities;
 - ROW easements for the transmission line with a typical width of approximately 150 to 200 feet; and
- **Access Roads:** To access the Project facilities and temporary construction areas during the construction and operation phases, Clean Line will use existing public and private roads and construct new roads to certain permanent features.
- **Temporary Construction Areas:** To facilitate project construction, Clean Line will use temporary construction areas such as multi-use construction yards, fly yards, tensioning and pulling sites and wire splicing sites.

Section 2 describes the Project components in detail, Section 3 discusses construction, Section 4 discusses operations and maintenance, and Section 5 describes decommissioning. Table 1-1, “Location of Project Facilities by County,” lists the counties within which the Project facilities could be located. Figure 1-1, “Project Overview” (see Appendix A, “Figures”) provides an overview of the Project components.

Table 1-1 Location of Applicant Proposed Route and Project Facilities by State and County			
	Approximate Length (Miles)	State	County(ies)
CONVERTER STATIONS			
Oklahoma Converter Station	N/A	Oklahoma	Texas
Oklahoma AC Interconnection	3.0	Oklahoma	Texas
Tennessee Converter Station	N/A	Tennessee	Shelby
Tennessee AC Interconnection	0.0	Tennessee	Shelby
Arkansas Converter Station Alternative	N/A	Arkansas	Pope
Arkansas AC Interconnection	5.0	Arkansas	Pope
HVDC ALTERNATIVE ROUTES			
Region 1 (Oklahoma Panhandle)			
Total PR in Region 1	113.6	Oklahoma	Texas, Beaver, Harper, and Woodward
Region 2 (Oklahoma Central Great Plains)			
Total PR in Region 2	106.1	Oklahoma	Woodward, Major, and Garfield
Region 3 (Oklahoma Cross Timbers)			
Total PR in Region 3	162.3	Oklahoma	Garfield, Kingfisher, Logan, Payne, Lincoln, Creek, Okmulgee, and Muskogee
Region 4 (Arkansas River Valley)			
Total PR in Region 4	126.0	Oklahoma and Arkansas	Muskogee and Sequoyah counties, Oklahoma, and Crawford, Franklin, Johnson, and Pope counties, Arkansas
Region 5 (Central Arkansas)			
Total PR in Region 5	113.4	Arkansas	Pope, Conway, Van Buren, Cleburne, White, and Jackson
Region 6 (Cache River, Crowley's Ridge Area, and St. Francis Channel)			
Total PR in Region 6	55.0	Arkansas	Jackson, Cross, and Poinsett
Region 7 (Arkansas Mississippi River Delta and Tennessee)			
Total PR in Region 7	42.7	Arkansas and Tennessee	Poinsett and Mississippi Counties, Arkansas, and Tipton and Shelby Counties, Tennessee
Total Length of the Proposed Route	721.0		

Table 1-1 Location of Applicant Proposed Route and Project Facilities by State and County			
	Approximate Length (Miles)	State	County(ies)
AC COLLECTION SYSTEM			
E1	29.0	Oklahoma	Texas and Beaver
E2	40.0	Oklahoma	Texas and Beaver
E3	40.1	Oklahoma	Texas and Beaver
NE1	30.0	Oklahoma	Texas
NE2	26.2	Oklahoma	Texas
NW1	51.9	Oklahoma	Texas
NW2	56.0	Oklahoma	Texas
SE1	40.2	Oklahoma	Texas
		Texas	Hansford and Ochiltree
SE2	13.3	Oklahoma	Texas
		Texas	Hansford
SE3	49.0	Oklahoma	Texas and Beaver
		Texas	Ochiltree
SW1	13.3	Oklahoma	Texas
		Texas	Hansford
SW2	37.0	Oklahoma	Texas
		Texas	Hansford and Sherman
W1	20.8	Oklahoma	Texas

Key:

PR = Proposed Route

2.0 Project Description

2.1 Converter Stations and Other Terminal Facilities

The Project includes two AC/DC converter stations, one at each end of the transmission line. Clean Line proposes to locate the western converter station in Texas County, Oklahoma and the eastern converter station in Shelby County, Tennessee. The eastern converter station would be capable of delivering up to 3,500MW. At each converter station, AC transmission lines would connect to the existing grid. The following sections provide a description of these facilities.

Based on comments received by the DOE during the public scoping period for the Environmental Impact Statement (EIS) held by the DOE and comments received on the Draft Environmental Impact Statement, Clean Line studied an intermediate converter station to be located in Arkansas. This intermediate converter station will be capable of delivering up to 500MW. AC transmission lines would connect the Arkansas Converter Station to the existing 500kV transmission grid operated by Entergy. Interconnection and engineering studies will determine the design and layout of the Arkansas converter station. Clean Line is considering a siting area in Pope County, Arkansas.

As part of its identification of alternatives for evaluation in the DEIS, DOE has identified an alternative that would provide for the addition of an intermediate converter station in Arkansas that would enable delivery of 500 MW of electricity into the Entergy Arkansas system to serve Arkansans. Since DOE originally identified the Arkansas Converter Station as a DOE alternative, Clean Line has evaluated the feasibility of this alternative. This Project Description supports the selection of the Arkansas Converter Station. Clean Line concluded that not only is this alternative technically feasible and responsive to public comments, but it also provides many socioeconomic and air quality benefits to Arkansans and consumers in the Mid-South.

2.1.1 Elements Common to the Converter Stations

Note: To avoid repetition, this section describes the elements common to the converter stations. Sections 2.1.2, "Oklahoma Converter Station and Other Terminal Facilities," 2.1.3, "Tennessee Converter Station and Other Terminal Facilities," and 2.1.4, "Arkansas Converter Station Alternative and Other Terminal Facilities," discuss differences between converter stations and associated AC interconnections.

Converter stations are similar to a typical AC substation, with additional equipment to convert between AC and DC. Ancillary facilities (e.g., communications equipment and cooling equipment) will be required at each converter station. In addition, AC transmission lines will connect each converter station to the existing grid.

Each converter station will include:

- DC switchyard;
- DC smoothing reactors;
- DC filters;
- Valve hall(s) (which contain the power electronics for converting AC to DC and vice versa);
- Ancillary building(s) (which house, e.g., control and protection equipment, cooling)
- AC switchyard;

- AC filter banks;
- AC circuit breakers and disconnect switches; and
- Transformers.

A typical converter station may require an area encompassing approximately 45 to 60 acres, most of which is occupied by the AC switchyard. The AC switchyard will be the largest portion of the electrical facility within the converter station footprint. There could be up to two buildings (valve halls) to house the power electronic equipment used in AC/DC conversion, each approximately 275 feet long by 80 feet wide. Valve halls protect the converter equipment from ambient conditions and impede the audible noise generated by the thyristors and other equipment. The valve halls could reach heights of 60 to 85 feet. Additionally, smaller building(s) will house the control room, control and protection equipment, auxiliaries, and cooling equipment. Other electrical equipment such as synchronous condensers, static compensators, or static var compensators may be required within the AC portion of the switchyard dependent on system studies. Transformers will be located adjacent to the valve hall(s) and surrounded on two sides with concrete fire walls. In addition to preventing a fire in one transformer from spreading to adjacent ones, the walls will also impede audible noise generated by the transformers. Clean Line will typically utilize 10- to 20-acre lay down areas during construction and post construction as parking and for locating warehousing facilities within the fenced converter station, if needed. Figure 2-1, "Clean Line Converter Station General Layout," shows a typical converter station layout.

Tables 2-1, "Oklahoma Converter Station and Associated Facility Dimensions and Land Requirements," 2-2, "Tennessee Converter Station and Associated Facility Dimensions and Land Requirements," and 2-3, "Arkansas Converter Station and Associated Facility Dimensions and Land Requirements," provide the typical facility dimensions and anticipated land requirements during construction and operation.

Figure 1-1, "Project Overview," depicts potential siting areas under consideration for the Converter Stations and interconnection facilities. Figures 2-2a, "Oklahoma Converter Station Siting Area Property Location," 2-2b, "Oklahoma Converter Station Siting Area Property Aerial," 2-3a, "Tennessee Converter Station Siting Area Property Location," and 2-3b, "Tennessee Converter Station Siting Area Property Aerial," depict converter stations. Figure 2-4, "Arkansas Converter Station Alternative Siting Area," depicts the siting area for the Arkansas converter station alternative.

AC for Interconnection, Oklahoma, Tennessee, and Arkansas

Typical structures include lattice structures and tubular pole structures and the dimensions are summarized in Tables 2-1, "Oklahoma Converter Station and Associated Facility Dimensions and Land Requirements," 2-2, "Tennessee Converter Station and Associated Facility Dimensions and Land Requirements," and 2-3, "Arkansas Converter Station and Associated Facility Dimensions and Land Requirements." They are depicted on Figures 2-21a, "500kV Lattice Deadend," 2-21b, "500kV Lattice String," 2-25a, "500kV 3-Pole Guyed Deadend," 2-25b, "500kV 3-Pole Deadend," 2-25c, "500kV 3-Pole Guyed Running Angle," 2-25d, "500kV 3-Pole Running Angle," 2-25e, "500kV Double Circuit Pole Deadend," 2-25f, "500kV Double Circuit Pole V-String," 2-25g, "500kV Single Circuit Guyed Pole Deadend," 2-25h, "500kV Single Circuit Pole Deadend," 2-25i, "500kV Pole Braced Post," and 2-25j, "500kV Single Circuit Pole V-String."

2.1.2 Oklahoma Converter Station and Other Terminal Facilities

The Oklahoma converter station will be the same as described in Section 2.1.1, “Elements Common to the Converter Stations.”

AC Interconnection Process and Facilities, Oklahoma

The following explains the processes applicable to Clean Line’s requests for interconnections between the Project and the existing electrical grid, including the study and assessment of the upgrades and improvements needed for such interconnections.

Clean Line requested a Point of Interconnection (POI) in Oklahoma at the Hitchland 345 kV substation. This substation is owned by SPS, a subsidiary of Xcel Energy and member of the SPP regional transmission organization. This interconnection is necessary to enable the AC to DC conversion process by HVDC line-commutated converters within the Oklahoma converter station. The interconnection between the proposed Oklahoma converter station and the SPS system would be controlled to a nominal value of zero (0) MW.

For Clean Line to interconnect to the SPS system, a series of studies are performed to review the potential interconnection and identify any upgrades to existing facilities or additions of new facilities to allow a reliable interconnection. SPS has completed a facilities study of the requested interconnection to the SPS 345 kV system. Based on the SPS analysis, a new substation would be necessary to accommodate the interconnection due to space constraints at the existing Hitchland 345 kV substation. To alleviate these space constraints, SPS has proposed a new substation nearby, tentatively named “Optima.” The interconnection of the Oklahoma Converter Station to the new substation would be facilitated by a new, approximately 3 mile long, 345 kV transmission line. Clean Line’s selected HVDC vendor will incorporate the results of the SPS facilities study into its study work on the final converter station design. This final study work, estimated to commence in the middle of 2015, will identify specific technology solutions such as reactive power requirements and filter design that will be included in the final converter station design. Following completion of these studies, Clean Line anticipates that it would enter into an Interconnection Agreement (IA) with SPS and SPP for the Project.

For the purpose of ensuring integration of the Project into the SPP transmission planning process, and to ensure that the interconnection of the Project does not affect the security or reliability of the SPP system, Clean Line contracted Siemens PTI to conduct steady-state and dynamic power system studies to comply with SPP planning requirements under SPP Criteria 3.5. Clean Line and Siemens PTI presented the results of these studies to the SPP Transmission Working Group (TWG) and SPP staff for review. Excel Engineering, an external consultant hired by SPP, reviewed the results and confirmed that Siemens PTI’s studies were complete and correct. In November 2012, the SPP Transmission Working Group endorsed Clean Line’s reliability study as “consistent with SPP planning processes and as having met [the Project’s] coordinated planning requirements under SPP Criteria.” The SPP TWG indicated that Clean Line may need to update the study after selection of a vendor for the Project. These updates would ensure that the final design of the HVDC converter station complies with criteria set forth in the final interconnection agreement.

The 345kV AC interconnection lines between the Oklahoma converter station and the new Optima substation will consist of an arrangement of three electrical phases, each with a two-conductor bundle (i.e., two subconductors) in a vertical configuration of about 18 to 24 inches separation. Each conductor will be an approximately 1- to 1.5-inch diameter aluminum conductor with a steel reinforced core, or a very similar configuration. Clean Line will design minimum conductor height above the terrain, assuming no clearance buffers, per Rule 232D of the NESC, Edition 2012, requiring 25 feet of clearance above general areas and areas with vehicular traffic. The NESC provides for minimum distances between the conductors and the ground, crossing points of other lines, the transmission support structure, and other

conductors on the same structure. The NESC also provides minimum working clearances for personnel during energized operation and maintenance activities (NESC 2012). The exact height of each tower and required vertical clearances is governed by topography and safety requirements.

2.1.3 Tennessee Converter Station and Other Terminal Facilities

The Tennessee converter station will be the same as described in Section 2.1.1, “Elements Common to the Converter Stations.”

AC Interconnection Process and Facilities, Tennessee

Clean Line requested interconnection service in Tennessee at the TVA Shelby 500 kV substation for delivery of up to 3,500 MW of power. Clean Line originally requested interconnection in the fall of 2009, at which time TVA performed feasibility studies on the following three potential options: Shelby 500 kV, a combination of Cordova 500 kV and Weakley 500 kV, and a new substation that would have connected the Shelby – Lagoon Creek and Cordova – Haywood 500 kV transmission lines. Based on studies of these options, Clean Line pursued interconnection at the Shelby substation.

The final Interconnection System Impact Study (ISIS), completed in March 2014, identified direct assignment facilities and network upgrades associated with the Project. Direct assignment facilities included additional bays, breakers, switches, line relays, and interchange meters to install within the Shelby substation before interconnecting the Project. Network upgrade projects are those that TVA identified that would allow injection of up to 3,500 MW to the TVA transmission system. The ISIS identified scenarios that would be resolved by 30 network upgrades, including upratings, reconductoring, and terminal upgrades on 27 existing 161 kV system elements and 3 existing 500 kV system elements. The ISIS also identified certain reliability scenarios that would be resolved by a new Lagoon Creek-Jackson 500 kV transmission line and associated substation upgrades. Direct assignment facilities are required to be constructed and in operation to facilitate the physical interconnection of the Project. Network upgrades, however, relate to the Project’s operational output under various system conditions and may be constructed after initial energization of the interconnection. Following Good Utility Practice, in accordance with a final Interconnection Agreement, and depending on the results of the facilities study, Clean Line may be asked to operate the Project in a way that restricts its full delivery capacity under some limited scenarios until completion of certain network upgrade projects.

As of the date of this publication, TVA is conducting a facilities study to determine costs and projected schedules for the identified direct assignment facilities and network upgrade projects. TVA anticipates the facilities study work will be complete in mid-2016. Following completion of the facilities study, Clean Line would negotiate an IA with TVA for the Project.

In addition, due to the proximity of the Shelby substation to nearby transmission systems operated by other parties, TVA identified the need for two Affected System Impact Studies (ASIS). Memphis Light, Gas and Water (MLGW) completed the first ASIS, which showed the need for two wavetraps (terminal equipment) at an existing 161 kV substation. MISO conducted the second ASIS showing no need for modifications to its system to accommodate the Project’s TVA interconnection.

The 500kV AC ties connecting the Tennessee converter station to the existing Shelby substation will consist of an arrangement of three electrical phases each with a three-conductor bundle (i.e., three subconductors). Final configuration and design of these interconnection facilities is ongoing as part of the TVA facilities study. Due to the location of the Tennessee converter station siting area adjacent to the existing TVA Shelby substation (Figures 2-3a and 2-3b), the 500 kV AC ties are expected to be contained entirely within the converter station footprint and the TVA Shelby substation footprint.

2.1.4 Arkansas Converter Station Alternative and Other Terminal Facilities

The Arkansas Converter Station Alternative would be the same as that described in Section 2.1.1, “Elements Common to the Converter Stations,” except that it would likely require a smaller land area, encompassing approximately 20 to 35 acres, and contain a smaller valve hall approximately 175 feet long by 75 feet wide. The smaller size and reduced equipment needs in comparison to the Oklahoma and Tennessee converter stations are a result of the smaller power capacity and the fact that the Arkansas converter station will connect to only one HVDC pole at any given time. Clean Line would utilize 5 to 10 acre lay down areas during construction and post construction as parking and for locating warehousing facilities, if needed.

AC Interconnection Process and Facilities, Arkansas

An AC interconnection is required to deliver power from the intermediate converter station to the existing transmission system owned by Entergy Arkansas, a subsidiary of Entergy Corp. Entergy Arkansas is part of the MISO system. Clean Line submitted the interconnection request to MISO in November 2013. Under MISO rules, interconnection requests involve three parties: the system operator (MISO), the transmission owner (Entergy Arkansas) and the interconnecting customer (Clean Line).

Clean Line began the interconnection process in Arkansas by requesting interconnection service from Entergy Arkansas for up to 500 MW along the existing Arkansas Nuclear One – Pleasant Hill 500 kV transmission line. Clean Line identified and proposed an AC interconnection consisting of a new 500 kV transmission line connecting the intermediate converter station to a new substation along the Arkansas Nuclear One – Pleasant Hill 500 kV transmission line. Clean Line selected the Arkansas Nuclear One – Pleasant Hill 500 kV POI to avoid the need for additional upgrades to the surrounding transmission system and in order to accommodate a 500 MW injection. MISO performed a feasibility study of the request and delivered results to Clean Line in February 2014. The feasibility study showed that no network upgrades were required to accommodate the interconnection.

In April 2015, MISO began the Definitive Planning Phase (DPP) of the Project’s interconnection study process. The DPP consists of a system impact study (SIS) and a facilities study, which are expected to take six months in total to complete. Following completion of the DPP process, Clean Line would enter into an IA with Entergy Arkansas and MISO.

The AC interconnection for the Arkansas Converter Station Alternative would include a 500 kV AC transmission line of approximately 5 miles (discussed in greater detail in Section 2.3, “AC Transmission Lines”) to an interconnection point along the existing Arkansas Nuclear One-Pleasant Hill 500 kV AC transmission line. An additional 5 acres will be required during construction of the converter station and 500kV AC interconnection for materials staging and equipment storage. The interconnection would also include a new substation at the point where the 500 kV AC interconnection line taps the existing Arkansas Nuclear One-Pleasant Hill 500 kV line. The footprint of this substation is estimated to be between 25 and 35 acres, with an additional 5 acres for temporary materials staging and equipment storage. The design and layout of the interconnection facilities are dependent on the results of ongoing interconnection and engineering studies.

The 500kV AC interconnection line will consist of an arrangement of three electrical phases each with a three-conductor bundle (i.e., three subconductors) in a triangle configuration about 18 to 24 inches on each side. Each conductor will be an approximately 1- to 2-inch diameter aluminum conductor with a steel reinforced core, or a very similar configuration. Clean Line will design minimum conductor height above the terrain, assuming no clearance buffers, per Rule 232D of the NESC, Edition 2012, requiring 29 feet for general areas and vehicular traffic.

Table 2-1 Oklahoma Converter Station and Associated Facilities Dimensions and Land Requirements		
Facility	Construction Dimensions ²	Operation Dimensions
Oklahoma Converter Station		
Oklahoma Converter Station (Figures 2-2a, "Oklahoma Converter Station Siting Area Property Location," and 2-2b, "Oklahoma Converter Station Siting Area Property Aerial")	Forty-five to 60 acres of land will be required for the station, plus an additional 5 to 10 acres for construction.	Forty-five to 60 acres of land will be required for the station; approximately 45 acres will be fenced.
Oklahoma Converter Station Access Road	All weather access roads 20 feet wide by less than 1 mile long will be required. Construction of the access roads may disturb an area up to 35 feet wide.	20 feet wide, paved roadways.
Oklahoma AC Interconnection Facility Dimensions and Land Requirements ¹		
ROW (Figure 2-19, "AC R.O.W. Limits")	One 345kV ROW 150–200 feet wide x 3 miles long	One 345kV ROWs each: 150–200 feet wide x approximately 3 miles long
345kV Lattice Structures (Figures 2-20a, "345kV Lattice Deadend," and 2-20b, "345kV Lattice V-String") (Figures 2-22, "345kV Lattice Work Area," and 2-23, "345kV Lattice Plan View")	Structure assembly area 150 feet wide (ROW width) x 150 feet long (within ROW) 5 to 7 structures per mile	Structural footprint 28 feet x 28 feet (typical for lattice structures) 75 to 180 feet tall 5 to 7 structures per mile
345kV Tubular Pole Structures (Figures 2-24a, "345kV 3-Pole Guyed Deadend," 2-24b, "345kV 3-Pole Deadend," 2-24c, "345kV 3-Pole Guyed Running Angle," 2-24d, "345kV 3-Pole Running Angle," 2-24e, "345kV Double Circuit Pole Deadend," 2-24f, "345kV Double Circuit Pole V-String," 2-24g, "345kV Single Circuit Guyed Pole Deadend," 2-24h, "345kV Single Circuit Pole Deadend," 2-24i, "345kV Pole Braced Post," and 2-24j, "345kV Single Circuit Pole V-String") (Figure 2-26, "345kV Monopole Work Area")	Structure assembly area 150 feet wide (ROW width) x 150 feet long (within ROW) 5 to 7 structures per mile	Structural footprint 7 feet x 7 feet (typical for tubular pole structures) 75 to 180 feet tall 5 to 7 structures per mile
AC Interconnection Point	(Inside the Xcel Energy/Southwestern Public Service Co., substation currently identified as Optima, formerly Hitchland #2)	(Inside the Xcel Energy/Southwestern Public Service Co., substation currently identified as Optima, formerly Hitchland #2)

Table 2-1 Oklahoma Converter Station and Associated Facilities Dimensions and Land Requirements		
Facility	Construction Dimensions ²	Operation Dimensions

- (1) The ultimate design of the interconnections will be dependent on interconnection studies and engineering studies.
- (2) All project analysis areas are described in the technical reports prepared by Clean Line.

Table 2-2 Tennessee Converter Station and Associated Facilities Dimensions and Land Requirements		
Facility	Construction Dimensions ²	Operation Dimensions
Tennessee Converter Station		
Tennessee Converter Station (Figures 2-3a, "Tennessee Converter Station Siting Area Property Location," and 2-3b, "Tennessee Converter Station Siting Area Property Aerial")	Forty-five to 60 acres of land will be required, plus an additional 5 to 10 acres for construction.	Forty-five to 60 acres of land will be required for the station; approximately 45 acres will be fenced.
Tennessee Converter Station Access Road	All weather access roads 20 feet wide by less than 1 mile long will be required. Construction of the access roads may disturb an area up to 35 feet wide.	20 feet wide, paved roadways.
Tennessee AC Interconnection Facility Dimensions and Land Requirements ¹		
ROW	Tennessee AC interconnection ties are expected to be contained entirely within the converter station footprint and the footprint of the existing TVA Shelby substation. No additional ROW is required.	Tennessee AC interconnection ties are expected to be contained within the converter station footprint and the footprint of the existing TVA Shelby substation. No additional ROW is required.
500kV Structures	Tennessee AC interconnection ties are expected to be supported by gantries or other insulated support structures within the converter station footprint and the footprint of the existing Shelby substation.	Tennessee AC interconnection ties are expected to be supported by gantries or other insulated support structures within the converter station footprint and the footprint of the existing Shelby substation.
AC Interconnection Point	(Inside the existing Shelby substation)	(Inside the existing Shelby substation)

- (1) The ultimate design of the interconnections will be dependent on interconnection studies and engineering studies.
- (2) All Project analysis areas, are described in the technical reports prepared by Clean Line.

<p style="text-align: center;">Table 2-3 Arkansas Converter Station Alternative and Associated Facilities Dimensions and Land Requirements</p>		
Facility	Construction Dimensions ¹	Operation Dimensions
Arkansas Converter Station Alternative		
Arkansas Converter Station Alternative- Pope County, Arkansas (Figure 2-4, "Arkansas Converter Station Alternative Siting Area")	20 to 35 acres of land would be required, plus an additional 5 to 10 acres for construction.	20 to 35 acres of land would be required for the station; approximately 35 acres would be fenced.
Arkansas Converter Station Access Road	All weather access roads 20 feet wide by less than 1 mile long will be required. Construction of the access roads may disturb an area up to 35 feet wide.	20 feet wide, paved roadways.
Arkansas AC Interconnection Facility Dimensions and Land Requirements ²		
ROW (Figure 2-19, "AC R.O.W. Limits")	One 500kV ROW 150–200 feet wide x 5 miles long (Assumes 5 mile or less long)	One 500kV ROW 150–200 feet wide x approximately 5 miles long
500kV Lattice Structures (Figures 2-21a, "500kV Lattice Deadend," and 2-21b, "500kV Lattice V-String") (Figures 2-22, "345kV Lattice Work Area," and 2-23, "345kV Lattice Plan View")	Structure assembly area 150 feet wide (ROW width) x 150 feet long (within ROW) 5 to 7 structures per mile	Structural footprint 28 feet x 28 feet (typical for lattice structures) 75 to 180 feet tall 5 to 7 structures per mile
500kV Tubular Pole Structures (Figures 2-25a, "500kV 3-Pole Guyed Deadend," 2-25b, "500kV 3-Pole Deadend," 2-25c, "500kV 3-Pole Guyed Running Angle," 2-25d, "500kV 3-Pole Running Angle," 2-25e, "500kV Double Circuit Pole Deadend," 2-25f, "500kV Double Circuit Pole V-String," 2-25g, "500kV Single Circuit Guyed Pole Deadend," 2-25h, "500kV Single Circuit Pole Deadend," 2-25i, "500kV Pole Braced Post," and 2-25j, "500kV Single Circuit Pole V-String") (Figure 2-26, "345kV Monopole Work Area")	Structure assembly area 150 feet wide (ROW width) x 150 feet long (within ROW) 5 to 7 structures per mile	Structural footprint 7 feet x 7 feet (typical for tubular pole structures) 75 to 180 feet tall 5 to 7 structures per mile

Table 2-3 Arkansas Converter Station Alternative and Associated Facilities Dimensions and Land Requirements		
Facility	Construction Dimensions ¹	Operation Dimensions
AC Interconnection Point	(500kV AC: a 25-35 acre site where the alternative AC transmission line would interconnect with an existing 500kV transmission line. An additional 5 acres would be required during construction)	The 25-35 acre site will be fenced. Permanent access road to the fenced area. Power supply to fenced area.

- (1) All Project analysis areas, are described in the methodologies for the technical reports prepared by Clean Line.
- (2) The ultimate design of the interconnections may change, based interconnection studies and engineering studies.

2.2 HVDC Transmission Line

The Project will transmit energy from the Oklahoma converter station to the Tennessee and Arkansas converter stations via a ± 600kV HVDC transmission line. The Tier IV Siting Narrative provides a description of the alternatives proposed by Clean Line. The final location of the ROW for the HVDC transmission line will be determined following engineering design and ROW acquisition activities. Clean Line considered multiple potential routes through Oklahoma, Arkansas, and Tennessee. DOE will analyze all or some these routes in the EIS. The potential routes cross the counties listed in Table 1-1, “Counties Potentially Affected by the Project,” and depicted on Figure 2-5, “HVDC Route Alternatives.”

Table 2-4, “HVDC Transmission Line Facility Dimensions and Land Requirements,” provides the typical facility dimensions and anticipated typical land requirements during construction and operation of the HVDC transmission line.

Table 2-4 HVDC Transmission Line Facility Dimensions and Land Requirements		
Facility	Construction Dimensions ¹	Operation Dimensions
ROW (Figure 2-7, “DC R.O.W. Limits”)	200 feet wide x approximately 720 miles long	200 feet wide x approximately 720 miles long
Lattice Structures (Figures 2-7, “DC R.O.W. Limits,” 2-8a, “600kV Lattice Deadend,” 2-8b, “600kV Lattice Running Angle,” 2-8c, “600kV Lattice Tangent,” 2-9, “600kV DC Lattice Work Area,” and 2-10, “600kV DC Lattice Foundation and Structure Construction Activities-Plan View”)	Structure assembly area 200 feet wide (ROW width) x 200 feet long (within ROW) 4 to 6 areas per mile (one for each structure)	Structural footprint 28 feet x 28 feet (typical) 120 to 200 feet tall (typical) 4 to 6 structures per mile

Table 2-4 HVDC Transmission Line Facility Dimensions and Land Requirements		
Facility	Construction Dimensions ¹	Operation Dimensions
Monopole Structures (Figures 2-7, "DC R.O.W. Limits," 2-11a, "600kV Monopole Deadend," 2-11b, "600kV Monopole Running Angle," 2-11c, "600kV Monopole Tangent," 2-12, "600kV DC Monopole Work Area," and 2-13 "600kV DC Monopole Foundation and Structure Construction Activities-Plan View")	Structure assembly area 200 feet wide (ROW width) x 200 feet long (within ROW) 5 to 7 areas per mile (one for each structure)	Structural footprint 7 feet x 7 feet (typical) 120 to 160 feet tall (typical) 5 to 7 structures per mile
Guyed Structures (Figures 2-14a, "600kV Guyed Mast Tubular Tangent," 2-14b, "600kV Guyed V-Tube Tangent," 2-14c, "600kV Guyed Monopole Tangent," 2-14d, "600kV Guyed Chainette Tangent," 2-14e, "600kV Guyed Mast Lattice Tangent," and 2-14f, "600kV Guyed V-Lattice Tangent")	Structure assembly area 200 feet wide x 300 feet long	Structural footprint 7 feet x 7 feet typical (does not include guy wire[s]) 120 to 200 feet tall
Lattice Crossing Structures (Figure 2-15, "600kV Lattice Crossing Structure")	Structure assembly area 200 to 550 feet wide x 300 feet long As necessary in limited situations (e.g., Mississippi River and Arkansas River crossings)	Structural footprint 64 feet x 64 feet (for a 350-foot-tall version) 200 to 350 feet tall As necessary in limited situations
Fiber Optic Regeneration Sites (Figure 2-17, "Regeneration Station Plan")	100 feet wide x 100 feet long (outside the ROW) one site each 180 to 200 miles (720 miles/1 site every 180 miles= approximately 4 sites) Typically within, but potentially outside the ROW and near the ROW (within 500 feet) but not necessarily abutting the ROW	100 feet wide x 100 feet wide 75 feet wide x 75-ft-long fenced area Control building 12 x 32 feet and 9 feet tall, within the fenced area. Permanent access road to the fenced area. Power supply to control building. Backup power generator and fuel supply.

(1) All Project analysis areas, including the "1,000-foot-wide Analysis Area", are described in the methodologies for the technical reports prepared by Clean Line.

2.2.1 Right-of-Way

ROW easements for the transmission line, with a typical width of approximately 150 to 200 feet, will be required. Figure 2-7, “DC R.O.W. Limits,” depicts the ROW requirements for the HVDC transmission line. Section 4.2, “Permitted Uses within the Right-of-Way,” provides restrictions on use within the ROW during operation.

2.2.2 Structures

The structures used to support the transmission line will be constructed of either tubular or lattice steel and will typically range in height from 120 to 200 feet. Preliminary engineering indicates that, when using lattice, most structures would be less than 160 feet and when using monopole structures tend to be less than 140 feet. Structure heights, span lengths, and vertical clearance will be determined in accordance with the National Electrical Safety Code (NESC), Clean Line design criteria, terrain and land use, and all applicable standards and laws. Clean Line may use taller structures in circumstances where additional clearances and/or longer spans are required. Typical structures include lattice structures and monopole structures (e.g., tubular steel structures and masts), as summarized in Table 2-4, “HVDC Transmission Line Facility Dimensions and Land Requirements,” and depicted on Figures 2-8a, “600kV Lattice Deadend,” 2-8b, “600kV Lattice Running Angle,” 2-11a, “600kV Monopole Deadend,” 2-11b, “600kV Monopole Running Angle,” and 2-11c, “600kV Monopole Tangent.” In addition to typical structures, there will be limited use of lattice crossing structures (presently planned for the crossing of the Mississippi River and the crossing of the Arkansas River) composed of lattice steel, which could approach 350 feet in height in order to maintain necessary clearance over the navigable channels. There could also be limited use of guyed structures, either tubular or lattice steel.

Clean Line will select structure types at locations along the Project ROW based on, but not limited to, land use, engineering efficiency, ROW restrictions, and existing facilities. Generally, Clean Line expects to use lattice structures for longer spans in open and wooded terrain, and tubular steel structures for spans that are more modest. Clean Line anticipates using guyed structures only in open grass or shrub terrain.

Clean Line will use either galvanized or weathering steel structures. Pier foundations, screw piles, caissons, concrete footings, guying, or other foundations will support the structures based on engineering considerations, cost, and land use. Direct embedment of structures may be possible if loadings and soil conditions at a specific site allow for direct burial. The structural footprint will vary by structure type; Table 2-4, “HVDC Transmission Line Facility Dimensions and Land Requirements,” describes these requirements.

Clean Line will not complete final design for the HVDC transmission line until a final route is chosen and subsequent detailed engineering studies and ROW acquisition activities are complete. Table 2-4, “HVDC Transmission Line Facility Dimensions and Land Requirements,” summarizes typical dimensions for structures. Drawings of the structures are included as Figures 2-8a, “600kV Lattice Deadend,” 2-8b, “600kV Lattice Running Angle,” 2-11a, “600kV Monopole Deadend,” 2-11b, “600kV Monopole Running Angle,” 2-11c, “600kV Monopole Tangent,” 2-14a, “600kV Guyed Mast Tubular Tangent,” 2-14b, “600kV Guyed V-Tube Tangent,” 2-14c, “600kV Guyed Monopole Tangent,” 2-14d, “600kV Guyed Chainette Tangent,” 2-14e, “600kV Guyed Mast Lattice Tangent,” 2-14f, “600kV Guyed V-Lattice Tangent,” and 2-15, “600kV Lattice Crossing Structure.”

2.2.3 Conductor

The $\pm 600\text{kV}$ HVDC line will consist of an arrangement of two electrical poles,³ each with a three-conductor bundle (i.e., three subconductors) arranged in a triangle of 18 to 24 inches on each side. Each subconductor will be an approximately 1- to 2-inch diameter aluminum/steel conductor with a steel reinforced core, or a very similar configuration. The aluminum/steel conductor is composed of three layers of aluminum strands wrapped around a core of steel strands. The aluminum provides the current carrying capacity and the steel provides additional mechanical strength. Alternatively, Clean Line may use a four-conductor bundle per pole (i.e., four subconductors) based on future economic or engineering analysis. In that case, Clean Line will arrange each bundle in a square configuration 18 to 24 inches on each side or similar. Clean Line will design minimum conductor height above the terrain, assuming no clearance buffers, per Rule 232D of the NESC, Edition 2012, which requires a minimum of 31 feet for general areas and areas with vehicular traffic. The NESC provides for minimum distances between the conductors and the ground, crossing points of other lines, the transmission support structure, and other conductors on the same structure. The NESC also provides minimum working clearances for personnel during energized operation and maintenance activities (NESC 2012). Topography and safety requirements govern the exact height of each structure and required vertical clearances. Figure 2-7, "DC R.O.W. Limits," depicts the ROW requirements for the HVDC transmission line and the conductor clearance. The conductor is placed on the transmission structure. The typical structure placement of the conductor in relation to other facilities is depicted on the typical structure drawings (Figures 2-8a, "600kV Lattice Deadend," 2-8b, "600kV Lattice Running Angle," 2-11a, "600kV Monopole Deadend," 2-11b, "600kV Monopole Running Angle," 2-11c, "600kV Monopole Tangent," 2-14a, "600kV Guyed Mast Tubular Tangent," 2-14b, "600kV Guyed V-Tube Tangent," 2-14c, "600kV Guyed Monopole Tangent," 2-14d, "600kV Guyed Chainette Tangent," 2-14e, "600kV Guyed Mast Lattice Tangent," 2-14f, "600kV Guyed V-Lattice Tangent," and 2-15, "600kV Lattice Crossing Structure").

2.2.4 Metallic Return

The Project includes a dedicated metallic conductor return configuration in lieu of a ground electrode or earth return system. An HVDC system requires a complete return path for the current. In bi-pole operation, this is accomplished by the current flowing down one pole and returning via the opposite pole in balanced normal operation. However, when one set of pole conductors are not available due to the electrical failure of that pole or maintenance, the current must have a return path for the line to remain in service. This is accomplished through a smaller set of conductors identified as the dedicated metallic return conductors. These conductors will be of sufficient size to carry full load current during any outage of one set of pole conductors and will also accommodate any imbalance in current during normal operation. Clean Line will place the metallic return on the transmission structure. The typical structure drawings (Figures 2-8a, "600kV Lattice Deadend," 2-8b, "600kV Lattice Running Angle," 2-11a, "600kV Monopole Deadend," 2-11b, "600kV Monopole Running Angle," and 2-11c, "600kV Monopole Tangent") depict the typical structure placement of the metallic return in relation to other facilities.

2.2.5 Optical Ground Wire and Static Wire

The Project includes one OPGW and one static wire to protect the transmission line from direct lightning strikes. Clean line will install these overhead ground wires, approximately 0.75 to 1 inch in diameter, on

³ HVDC schemes, like those Clean Line is proposing, are typically arranged in a bi-pole configuration; meaning there are two electrical poles with one at an electrical potential that is positive with respect to ground potential and one that is negative with respect to ground potential. In the case of HVDC transmission lines, a pole is akin to a phase in AC technology.

the top of the transmission structures. The ground wires and structures will transfer current from lightning strikes through the ground wires and structures into the ground. The typical structure drawings (Figures 2-8a, "600kV Lattice Deadend," 2-8b, "600kV Lattice Running Angle," 2-11a, "600kV Monopole Deadend," 2-11b, "600kV Monopole Running Angle," and 2-11c, "600kV Monopole Tangent") depict the typical structure placement of the OPGW (shield wire/OPGW) and static wire in relation to other facilities.

2.2.6 Communication Facilities

Fiber optic cable is embedded within the OPGW to allow direct communication between converter stations. Fiber optic cables typically have 24 to 48 fibers each. Based on typical practice, Clean Line will use four to six fibers for communications between the converters. The remaining fibers can be utilized as spares or for other communication purposes subject to applicable regulatory requirements.

2.2.7 Fiber Optic Regeneration Sites

As a data signal passes through fiber optic cable, the data signal degrades with distance. This data signal must be regenerated or amplified every 180 to 200 miles at fiber optic regeneration sites. Typical dimensions for fiber optic regeneration sites are summarized in Table 2-4, "HVDC Transmission Line Facility Dimensions and Land Requirements," along with the approximate number of sites required for the HVDC transmission line.

A typical fiber optic regeneration site will be approximately 100 feet by 100 feet, with a fenced area of approximately 75 feet by 75 feet. Regeneration sites are typically adjacent to the ROW. A small control building made of either metal or concrete, approximately 12 feet by 32 feet by 9 feet tall, will enclose the regeneration equipment. An access road and power supply to the site will be required. An existing electric distribution line near the fiber optic regeneration site typically supplies power. If required, the local service provider will extend power lines to serve the regeneration site; these distribution lines will likely be placed on single wood poles, or they may be buried. The voltage of the power supply line is typically 34.5kV or lower. The location and routing of the existing distribution lines to the new sites will be determined during the final design process. Clean Line will install an emergency generator with fuel storage at the site, inside the fenced area. Two cable routes (aerial and/or buried) between the transmission ROW and the equipment shelter will be required.

There are two basic methods of direct burial installation for the cables: trenching and plowing. Trenching involves digging a trench, placing the cable in the trench, and backfilling with native soils. Trenches are often dug with backhoes using narrow buckets (18 inches wide or less) to a depth of approximately 42 inches and are visually inspected for rocks or debris that could potentially damage the cable. In some instances, conduit is laid in the trench and the cable pulled through the conduit. Plowing involves a cable-laying plow designed to simultaneously excavate a ditch and lay the cable. Native soil is used to backfill the ditch.

A permanent access road to each fiber optic regeneration site will be required. Clean Line will also use these access roads for permanent access to the transmission lines and they are included in the access road numbers for HVDC and AC transmission line in Tables 2-7, "Estimated Access Road Miles by Road Type for HVDC Transmission Lines," and 2-8, "Estimated Access Road Miles by Road Type for AC Transmission Lines." Table 2-4, "HVDC Transmission Line Facility Dimensions and Land Requirements," Summarizes typical construction and operation dimensions for fiber optic regeneration sites. Figure 2-17, "Regeneration Station Plan," depicts a typical fiber optic regeneration site.

2.3 AC Collection System

In addition to the HVDC transmission line, the Project will also include AC collection transmission lines to collect energy from generation resources in the Oklahoma Panhandle Region.

The Project will include the construction and operation of an AC collection system on the western end of the Project. The collection system will consist of four to six AC transmission lines up to 345kV from the Oklahoma converter station to points in the Oklahoma Panhandle region to facilitate efficient interconnection of wind energy generation. Clean Line expects that the point of interconnection from generation facilities will be located within approximately 40 miles of the Oklahoma converter station in the Oklahoma Panhandle, and the Texas Panhandle. Wind energy generation facilities (wind farms) would connect to the AC Collection System by way of a number of possible configurations. These configurations could range in size from a direct tap, a bus ring, or even a small substation (up to 2 to 5 acres in size) with transformer and switching equipment. The type and size of these AC connections is unknown at this time; the final design of these facilities is dependent on a number of factors including their location, the number of connections, and the nameplate capacity and voltage of generation facilities.

Figure 1-1, "Project Overview," depicts the siting area for the AC collection system in the Oklahoma Panhandle Region. Table 2-5, "AC Collection System Oklahoma Panhandle Region Transmission Lines Facility Dimensions and Land Requirements," provides the typical facility dimensions and anticipated typical land requirements during construction and operation of the AC collection facilities.

The AC collection system is depicted on Figure 2-6, "AC Alternatives."

Table 2-5 AC Collection System Oklahoma Panhandle Region Transmission Lines Facility Dimensions and Land Requirements ¹		
Facility	Construction Dimensions ²	Operation Dimensions
ROW (Figure 2-19, "AC R.O.W. Limits")	Four to six 345kV ROWs each: 150–200 feet wide x extending up to 40 miles from the converter station (Assumes up to 300 miles of 345kV for the AC Collection System on the western end of the Project) ³	Four to six 345kV ROWs each: 150–200 feet wide x extending up to 40 miles from the converter station
345kV Lattice Structures (Figures 2-20a, "345kV Lattice Deadend," and 2-20b, "345kV Lattice V-String") (Figures 2-22, "345kV Lattice Work Area," and 2-23, "345kV Lattice Plan View")	Structure assembly area 150 feet wide (ROW width) x 150 feet long (within ROW) 5 to 7 structures per mile	Structural footprint 28 feet x 28 feet (typical for lattice structures) 75 to 180 feet tall 5 to 7 structures per mile

Table 2-5 AC Collection System Oklahoma Panhandle Region Transmission Lines Facility Dimensions and Land Requirements ¹		
Facility	Construction Dimensions ²	Operation Dimensions
345kV Tubular Pole Structures (Figures 2-24a, “345kV 3-Pole Guyed Deadend,” 2-24b, “345kV 3-Pole Deadend,” 2-24c, “345kV 3-Pole Guyed Running Angle,” 2-24d, “345kV 3-Pole Running Angle,” 2-24e, “345kV Double Circuit Pole Deadend,” 2-24f, “345kV Double Circuit Pole V-String,” 2-24g, “345kV Single Circuit Guyed Pole Deadend,” 2-24h, “345kV Single Circuit Pole Deadend,” 2-24i, “345kV Pole Braced Post,” and 2-24j, “345kV Single Circuit Pole V-String”) (Figure 2-26, “345kV Monopole Work Area”)	Structure assembly area 150 feet wide (ROW width) x 150 feet long (within ROW) 5 to 7 structures per mile	Structural footprint 7 feet x 7 feet (typical for tubular pole structures) 75 to 180 feet tall 5 to 7 structures per mile
345kV H-Frame Structures (Figures 2-27a, “345kV Braced H-Frame,” 2-27b, “345kV H-Frame Tangent,” and 2-27c, “345kV H-Frame V-String”)	Structure assembly area 150 feet wide (ROW width) x 150 feet long (within ROW) 5 to 7 structures per mile	Structural footprint Two poles spaced 25 feet apart each with a 7 feet x 7 feet footprint (typical for H-frame structures) 75 to 180 feet tall 5 to 7 structures per mile
Fiber Optic Regeneration Site (Figure 2-17, “Regeneration Station Plan”)	100 feet wide x 100 feet long (outside the ROW) (Approximately 6 sites required for the 4 to 6 AC collection system lines) Outside the ROW and near the ROW (within 750 feet) but not necessarily abutting the ROW	100 feet wide x 100 feet wide 75 feet wide x 75-foot-long fenced area Control building 12 x 32 feet and 9 feet tall, within the fenced area. Permanent access road to the fenced area. Power supply to control building. Backup power generator and fuel supply.

- (1) The ultimate design of the interconnections will be dependent on interconnection studies and engineering studies.
- (2) All Project analysis areas are described in the technical reports prepared by Clean Line.
- (3) Clean Line expects that the potential points of interconnection between wind farms and the AC Collection System would be located within approximately 40 miles of the Oklahoma converter station. However, the AC Collection System transmission lines are not expected to take a straight path to the wind farms, and therefore could be longer than 40 miles.

2.3.1 Right-of-Way

Right-of-way easements for the AC collection transmission lines, with a typical width of approximately 150 to 200 feet, will be required. The ROW requirements for the AC collection transmission line are depicted on Figure 2-19, "AC R.O.W. Limits." Restrictions on use within the ROW during operation are provided in Section 4.2, "Permitted Uses within the Right-of-Way."

2.3.2 Structures

The structures used to support the AC collection transmission lines will be constructed of either tubular or lattice steel and will generally range in height from 75 to 180 feet. Clean Line will determine structure heights, span lengths and vertical clearance in accordance with the NESC, Clean Line design criteria, and all applicable standards and laws. Clean Line may use taller structures in circumstances where additional clearances and/or longer spans are required based on engineering review.

Clean Line will construct the structures of either galvanized or weathering steel. Pier foundations, screw piles, caissons, concrete footings, guying, or other appropriate foundations will support the structures. Direct embedment of structures may be possible if loadings and soil conditions at a specific site allow for direct burial. The structural footprint will vary by structure type and these are described in Tables 2-1, "Oklahoma Converter Station and Associated Facility Dimensions and Land Requirements," 2-2, "Tennessee Converter Station and Associated Facility Dimensions and Land Requirements," 2-3, "Arkansas Converter Station and Associated Facility Dimensions and Land Requirements," and 2-5, "AC Collection System Oklahoma Panhandle Region Transmission Lines Facility Dimensions and Land Requirements."

Clean Line will complete final design for the AC collection transmission lines after a final route is chosen and subsequent detailed engineering studies and ROW acquisition activities are complete.

Typical structures include lattice structures and tubular pole structures and the dimensions are summarized in Tables 2-1, "Oklahoma Converter Station and Associated Facility Dimensions and Land Requirements," 2-2, "Tennessee Converter Station and Associated Facility Dimensions and Land Requirements," 2-3, "Arkansas Converter Station and Associated Facility Dimensions and Land Requirements," and 2-5, "AC Collection System Oklahoma Panhandle Region Transmission Lines Facility Dimensions and Land Requirements." They are depicted on Figures 2-20a, "345kV Lattice Deadend," 2-20b, "345kV Lattice V-String," 2-24a, "345kV 3-Pole Guyed Deadend," 2-24b, "345kV 3-Pole Deadend," 2-24c, "345kV 3-Pole Guyed Running Angle," 2-24d, "345kV 3-Pole Running Angle," 2-24e, "345kV Double Circuit Pole Deadend," 2-24f, "345kV Double Circuit Pole V-String," 2-24g, "345kV Single Circuit Guyed Pole Deadend," 2-24h, "345kV Single Circuit Pole Deadend," 2-24i, "345kV Pole Braced Post," and 2-24j, and "345kV Single Circuit Pole V-String," 2-25a.

In addition to typical structures, Clean Line may employ limited use of H-frame structures, typically tubular steel, in locations where structure height is of concern.

2.3.3 Conductor

The ROW requirements for the AC transmission line are depicted on Figure 2-19, "AC R.O.W. Limits," and conductor clearance is illustrated. Typical structure drawings depict the typical placement of the conductor in relation to other facilities on the structure.

2.3.4 Optical Ground Wire and Static Wire

Clean Line will install one OPGW and one static wire to protect the transmission lines from direct lightning strikes. Clean Line will install these overhead ground wires, approximately 0.75 to 1 inch in diameter, on the top of the transmission structures. The ground wires and structures will transfer current from lightning strikes through the ground wires and structures into the ground. The typical structure placement of the OPGW and static wire in relation to other facilities is depicted on the typical structure drawings.

2.3.5 Communication Facilities

Fiber optic cable is embedded within the OPGW to support communications between substations. Fiber optic cables will typically have 24 to 48 fibers each. Based on typical practice, four to six fibers will be used for communications between the converters. The remaining fibers can be utilized as spares or for other communication purposes.

2.3.6 Fiber Optic Regeneration Sites

Clean Line will install and operate fiber optic regeneration sites along the AC transmission lines associated with the AC collection system in the Oklahoma Panhandle Region. As a data signal passes through fiber optic cable, the data signal degrades with distance. This data signal must be regenerated or amplified every 180 to 200 miles. A typical fiber optic regeneration site is described in Section 2.2.7, "Fiber Optic Regeneration Sites." Typical dimensions for fiber optic regeneration sites are summarized in Table 2-5, "AC Collection System Oklahoma Panhandle Region Transmission Lines Facility Dimensions and Land Requirements," along with the approximate number of sites required for the AC collection system.

2.4 Access Roads

Clean Line intends to maximize the use of existing public and private roads to the extent practicable, improve some roads on private land where they are insufficient, and build some new access roads. Clean Line will use access roads during both construction and operation of the project. During construction, new and existing roads are required to access transmission ROWs (for clearing and for moving equipment to structure locations), structure locations, fiber optic regeneration sites and temporary construction areas. During operation of the project, new and existing roads are required to access transmission ROWs (for vegetation management and movement of maintenance equipment) and to access structure locations and fiber optic regeneration sites for maintenance (see Section 4, "Operations and Maintenance"). A new, permanent access road along the entire length of the ROW is not required.

Clean Line will locate access between structures in active agricultural areas along fence lines or field lines where practicable to minimize impacts. Site conditions, engineering design, construction requirements, adopted environmental protection measures and relevant permits will govern the specific locations of proposed new and existing access roads. Clean Line's road construction standards will be in accordance with appropriate jurisdictions' requirements. There are no plans for improvements⁴ to public roads (e.g., highways, state roads, or county roads). Clean Line plans to repair existing private roads before and after

⁴ Improvements are upgrades or expansions to allow passage of equipment or vehicles that would include, for example, alignment modifications or structural replacement (e.g. bridge or culvert). Repairs, as defined in the table, include minor activities such as pothole repair.

construction. Any paving will be limited to approach aprons at intersections with existing paved roads and all-weather access roads to converter stations, unless otherwise required by jurisdictional authorities.

2.4.1 Existing Access Roads

Clean Line will use existing roads for access during construction and operation of the project wherever practicable. Some existing roads may require improvement prior to use. Clean Line divided existing roads into three categories for the purposes of this description, as follows:

- Existing (Public or Private) Roads with No Improvements,
- Existing (Private) Roads that May Need Repairs, and
- Existing (Private) Roads that Need Improvements.

Any improvements to existing roads will be left in place for access during Project operation, where practicable. Table 2-6, "Access Roads Facility Dimensions and Land Requirements" includes more detailed descriptions of each category of existing roads.

2.4.2 New Access Roads

New access for construction equipment will be required where the use of existing roads is not practicable or where existing roads do not provide adequate access. Access types can range from direct overland travel to mat-covered or aggregate temporary roads, and new graded roads that may be shaped with drainage. Clean Line will site new access roads to avoid steep side slopes where practicable. In areas of moderate to steep terrain, Clean Line will site roads to fit the terrain by following the natural contours. In some instances, vertical slopes from 15 percent to 20 percent are acceptable, but roads will not typically exceed straight-line lengths of 1,000 feet in areas with steep terrain. Clean Line will avoid areas with steep terrain and slopes greater than 20 percent to the extent practicable.

Clean Line divided new roads into four categories for the purposes of description as follows:

- New Overland Travel Roads (no improvements needed),
- New Overland Travel Roads with Clearing
- New Bladed Roads, and
- New Temporary Matted or Aggregate Roads

New roads may be temporary (removed after construction) or left in place to provide access during operation and maintenance of the project. Table 2-6, "Access Roads Facility Dimensions and Land Requirements" includes more detailed descriptions of each category of new roads and whether that road will be removed after construction or preserved for access during Project operation.

Typical facility dimensions and anticipated typical land requirements during construction and operation for access roads associated with converter stations are included in Tables 2-1, "Oklahoma Converter Station and Associated Facility Dimensions and Land Requirements," 2-2, "Tennessee Converter Station and Associated Facility Dimensions and Land Requirements," and 2-3, "Arkansas Converter Station and Associated Facility Dimensions and Land Requirements." Table 2-6, "Access Roads Facility Dimensions and Land Requirements," provides the typical facility dimensions and anticipated typical land requirements during construction and operation for access roads associated with HVDC and AC transmission lines. Typical access roads are depicted on Figure 2-28, "Typical Access Roads."

Estimated access road miles for converter stations are included in Tables 2-1, "Oklahoma Converter Station and Associated Facility Dimensions and Land Requirements," 2-2, "Tennessee Converter Station and Associated Facility Dimensions and Land Requirements," 2-3, "Arkansas Converter Station and Associated Facility Dimensions and Land Requirements."

Table 2-6, "Access Roads Facility Dimensions and Land Requirements," includes a description of existing roads with no improvements; however, Clean Line will use existing public roads during construction and operation of the Project to the extent practicable, and has not included estimates for the number of miles of existing roads with no improvements that may be used by the Project in Table 2-7, "Estimated Access Road Miles by Road Type for HVDC Transmission Lines" or Table 2-8, "Estimated Access Road Miles by Road Type for AC Transmission Lines." Table 2-7, "Estimated Road Miles by Road Type for HVDC Transmission Line," and Table 2-8, "Estimated Access Road Miles by Road Type for AC Transmission Lines," contain the estimated access road miles by road type for access roads associated with HVDC and AC transmission lines and fiber optic regeneration sites.

Table 2-6 Access Roads Facility Dimensions and Land Requirements			
Road Type	Definition	Construction Dimensions	Operation Dimensions
Existing Roads			
Existing Roads with No Improvements or Repairs (Public or Private Roads)	Existing roads with no improvements or repairs include public roads maintained by local or state jurisdictions. Private roads that can support construction traffic with no improvements or repairs are also included in this category.	Anticipate existing roads with no improvements or repairs are suitable for construction as is. No construction or ground disturbance expected. Therefore these roads are not included in the access road estimates in Table 2-7, "Estimated Access Road Miles by Road Type for HVDC Transmission Lines," and 2-8, "Estimated Access Road Miles by Road Type for AC Transmission Lines."	Existing roads with no improvements or repairs are suitable for operation as is.
Existing Roads that May Need Repairs (Private Roads)	Existing roads that may need repairs include most dirt and unimproved two-track roads on private land (not publically maintained roads), which are generally in a condition that supports construction traffic with repairs in some spots. No improvements to public roads are planned for construction. Examples of repairs would include grading to remove potholes or surface ruts over short distances. In many cases, grading would include reshaping the surface to promote drainage from the travel surface.	Typically, 14 feet wide travel surface at straight sections and 16 to 20 feet wide at corners. In areas with steep side slopes (greater than 15%), the construction disturbance corridor may be up to 50 feet wide. It is assumed that construction would typically use a total corridor up to 35 feet wide for these roads in limited areas where repairs are needed. However, it is assumed that the new disturbance width would be reduced by the width of the existing road (e.g., 35-foot-wide construction corridor – 16-foot-wide existing road = 19-foot-wide new disturbance).	Repairs to existing roads will be left in place to facilitate access during Project operation.

Table 2-6 Access Roads Facility Dimensions and Land Requirements			
Road Type	Definition	Construction Dimensions	Operation Dimensions
	In some cases, it may be necessary to replenish and re-grade gravel-surfacing material.	Further, for disturbance estimates, it is assumed that repairs will be needed on 10% of the road surface of those roads identified as being in this category. New disturbance footprint is estimated to be $19 \times 5280 \times 0.1 / 43560 = 0.23$ acres/mile.	
Existing Roads that Need Improvements (Private Roads)	Existing roads that need improvements include private roads along which modifications to alignment, structural improvements, or drainage improvements are required before they could be used for construction and/or operation of the Project. These are roads that could not support construction traffic without significant upgrades. Some examples include private roads that traverse numerous drainages, exhibit severe rutting, or have sharp switchbacks. Structural improvements typically involve excavation and replacement of unstable roadbed with structural embankment fill over geotextile and gravel surfacing.	Typically, 14 feet wide travel surface at straight sections and 16 to 20 feet wide at corners. In areas with steep side slopes (greater than 15%), the construction disturbance corridor may be up to 50 feet wide. It is assumed that construction would typically use a total corridor up to 35 feet wide for these roads. However, it is assumed that the new disturbance width would be reduced by the width of the existing road (e.g., 35-foot-wide construction corridor – 16-foot-wide existing road = 19-foot-wide new disturbance). New disturbance footprint for improvements is assumed to be $19 \times 5280 / 43560 = 2.3$ acres/mile	Improvements to existing roads will be left in place to facilitate access during Project operation.
New Roads			
New Overland Travel Roads (no improvements needed) (Private Roads)	Overland travel roads include routes that are created by direct vehicle travel over low-growth vegetation and do not require clearing or grading. Existing low-growth vegetation will be maintained where practicable. These roads require no preparation prior to use by vehicles and equipment.	Typically, 14 feet wide travel surface at straight sections and 16 to 20 feet wide at corners. It is assumed that there will be no clearing or grading for these roads. Construction traffic would occur over an area 14 -20 feet wide. New disturbance footprint is assumed to be $20 \times 5280 / 43560 = 2.4$ acres/mile	Clean Line estimates that 75% of construction roads will be re-used for operation and maintenance access.
New Overland Travel Roads with Clearing (Private Roads)	New overland travel roads with clearing include overland travel routes that require clearing and minor grading using heavy machinery to remove larger vegetation or other	Typically, 14 feet wide travel surface at straight sections and 16 to 20 feet wide at corners. In areas with steep side slopes (greater than 15%), the	Clean Line estimates that 90% of construction roads will be re-used for operation and maintenance access.

Table 2-6 Access Roads Facility Dimensions and Land Requirements			
Road Type	Definition	Construction Dimensions	Operation Dimensions
	obstructions in some locations to ensure safe vehicle operation and access.	<p>construction disturbance corridor may be up to 50 feet wide.</p> <p>It is assumed that construction disturbance would typically include an average corridor up to 35 feet wide for these roads.</p> <p>New disturbance footprint is assumed to be $35' \times 5280 / 43560 = 4.2$ acres/mile.</p>	
New Bladed Roads (Private Roads)	New bladed roads may be constructed to access structure locations or temporary work areas in steep or uneven terrain. Bladed roads are generally used on side slopes greater than 8% and are shaped to provide drainage. New bladed roads are typically un-surfaced unless required by the applicable jurisdiction where soil and moisture conditions contribute to surface erosion or rutting.	<p>It is assumed that construction disturbance for these roads will be 35 feet wide for 90% of the new bladed roads used for the Project.</p> <p>Assumed new disturbance footprint for slopes < 15% is $35' \times 5280 \times 1 / 43560 = 4.2$ acres/mile</p> <p>In areas with steep side slopes (greater than 15%), construction disturbance may be up to 50 feet wide. Such areas are assumed to represent 10% of new bladed roads for the Project.</p> <p>Assumed new disturbance footprint for slopes > 15% is $50' \times 5280 / 43560 = 6.1$ acres/mile.</p>	Clean Line estimates that 90% of construction roads will be re-used for operation and maintenance access.
New Temporary Matted or Aggregate Roads (Private Roads)	New matted or aggregate roads are temporary driving surfaces used to access structures or temporary work areas in soft, wet conditions. These would include a timber or composite temporary mat or aggregate underlain by geotextile fabric.	<p>It is assumed that the temporary construction disturbance for these roads will typically be 35 feet wide.</p> <p>Assumed temporary disturbance footprint is $35' \times 5280 / 43560$</p>	No roads of this type will be retained for operations and maintenance.

Table 2-7 Estimated Access Road Miles by Road Type and Analysis Region for HVDC Transmission Line									
Road Type		1	2	3	4	5	6	7	Total
Existing Roads that May Need Repairs	Miles	80.5	21.5	42.9	58.3	46.3	32.7	19.4	301.7
Existing Roads that Need Improvements	Miles	2.3	4.5	21.9	20.9	23.6	37.6	14.7	125.6
New Overland Travel Roads	Miles	26.4	44.2	49.4	37.7	1.5	0.3	2.3	161.9
New Overland Travel Roads with Clearing	Miles	20.6	24.3	40.2	19.6	27.6	0.5	3.9	136.9
New Bladed Roads	Miles	3.5	14.9	33.9	41.7	58.6	11.9	4.6	169.1
New Temporary Matted or Aggregate Roads	Miles	-	-	-	-	-	21.5	14.1	35.7
Totals	Miles	133.4	109.5	188.4	178.2	157.6	104.6	59.1	930.8
Total Disturbance	Acres	190.7	291.5	500.6	420.6	445.0	240.8	140.6	2229.8
% Road Miles In ROW		1	2	3	4	5	6	7	Total
Existing Roads that May Need Repairs	%	44	70	40	26	25	13	41	35
Existing Roads that Need Improvements	%	92	44	53	31	31	46	30	41
New Overland Travel Roads	%	24	96	84	81	58	100	93	87
New Overland Travel Roads with Clearing	%	84	92	82	80	91	100	79	86
New Bladed Roads	%	89	93	91	87	92	95	84	91
New Temporary Matted or Aggregate Roads	%	-	-	-	-	-	91	88	90
Totals	%	62	87	71	59	63	51	58	83
Disturbance in ROW	Acres	115.6	267.0	407.6	319.5	366.7	176.7	100.0	1753.1
Disturbance Outside ROW	Acres	75.1	24.4	93.0	101.1	78.3	64.2	40.6	476.8

Table 2-8 Estimated Access Road Miles by Road Type for AC Interconnection Lines and HVDC Converter Stations					
Road Type		OK	AR	TN	Totals
Existing Roads that Need Improvements	Miles	0	1	0	1
Existing Roads that May Need Repairs	Miles	2	2	0	4
New Overland Travel Roads	Miles	1	0	0	1
New Overland Travel Roads with Clearing	Miles	1	1	0	2
New Bladed Roads	Miles	1	4	1	6
New Temporary Matted or Aggregate Roads	Miles	0	1	0	1
Totals	Miles	5	9	1	15
Total Disturbance	Acres	11.6	28.9	4.4	44.9
% Road Miles In ROW	%	85	78	85	
% Road Miles Outside ROW	%	15	22	15	
Disturbance in ROW	Acres	9.8	22.6	3.8	36.2
Disturbance Outside ROW	Acres	1.7	6.4	0.7	8.8

Table 2-9 Estimated Access Road Miles by Road Type for AC Collection System		
Road Type		Total
Existing Roads that Need Improvements	Miles	4
Existing Roads that May Need Repairs	Miles	143
New Overland Travel Roads	Miles	47
New Overland Travel Roads with Clearing	Miles	37
New Bladed Roads	Miles	6
New Temporary Matted or Aggregate Roads	Miles	0
Totals	Miles	238
Total Disturbance	Acres	627.7
% Road Miles In ROW	%	85
% Road Miles Outside ROW	%	15
Disturbance in ROW	Acres	533.6
Disturbance Outside ROW	Acres	94.2

Notes:

Access Road Miles

Access Road Miles for the HVDC transmission line (Table 2-7) are based on preliminary engineering and access planning conducted by Clean Line and its consultants in 2014. Preliminary engineering and access planning was conducted using assumed structure parameters from preliminary design, assumed span lengths, assumed conductor parameters from preliminary design, LIDAR data and aerial imagery from the Applicant Proposed Route (APR). Access road miles for the AC interconnection and collection system lines (Table 2-8 and Table 2-9) are not based on preliminary engineering nor access planning, but are

extrapolations based on quantities of line-miles. To determine miles of access roads by type for AC lines, Clean Line used the formula $M=(T*P)/R$ where M is the access road mileage of a given type for an AC line, T is the total line-miles of AC line (interconnection or collection system), P is the miles of HVDC access road of a given type for the corresponding analysis region (from the access planning conducted by Clean Line and its consultants), and R is the total HVDC line-miles in that region. Access road mileage for the HVDC converter stations was assumed to be one mile of New Bladed Road for each station.

Disturbance Footprints

Disturbance footprints for new bladed roads are related to side slope. Using AutoCAD Civil 3D a surface model was used to establish the disturbance footprint impacted by construction of a 14-foot wide bladed road traversing a hillside with variable slopes. Existing ground and proposed finish road surface profiles were created of the roadway alignment. Design parameters were selected for low volume service roads for this analysis and the finish grade profile was established to closely follow the existing ground surface to minimize cuts and fills. A crowned road section with variable daylight treatments was assumed. Sample cross sections were established at major engineering stations along the corridor alignment and the disturbance width between daylight catch points were recorded along with existing side slope at each cross section. Slope and disturbance width data was tabulated for each station, sorted by side slope and average disturbance widths were established for select slope ranges. Disturbance footprints in acres per mile were established for each access road type consistent with construction dimensions described in Table 2-8, “Estimated Access Road Miles by Road Type for AC Transmission Lines,” and supplemented with disturbance for bladed roads described above. The disturbance values were extrapolated across the Project using slope range data summary information.

3.0 Typical Construction

Please note: The following description should be considered a typical representation of the construction sequence and activities for a high voltage transmission line.

This section describes typical construction of the converter stations (Section 3.1), the HVDC and AC transmission lines (Section 3.2), and access roads (Section 3.3). Section 3.4 provides information on construction of the interconnections and related upgrades. Section 3.5 discusses how Clean Line will handle hazardous materials during construction of all Clean Line facilities. Section 3.6 discusses gravel sources. Appendix B, "Environmental Protection Measures," provides measures to avoid and minimize impacts. Appendix C, "Workforce, Crews, Equipment, and Trips," provides estimates of the construction workforce (by crew type and over time), crew types (based on construction activities), crew numbers, construction equipment, estimates of local traffic from construction, and local vs. non-local workers. Clean Line will complete access road layout and geologic/geotechnical investigations during engineering design.

Pre-construction activities for transmission lines and converter station facilities include:

- Land surveys for structure and boundary location staking;
- Access road survey and staking;
- Training; and
- Pre-construction surveys for biological and cultural resources, as required by federal or state permits and/or detailed in Appendix B, "Environmental Protection Measures."

Clean Line will mark and survey the boundaries of all construction workspaces. Clean Line will keep construction sites, material storage yards, and access roads in an orderly condition throughout the construction period. Clean line will train construction personnel on safety and on the protection of sensitive resources, such as biological, cultural, and paleontological issues. Training is discussed in greater detail in Appendix B, "Environmental Protection Measures."

Clean Line will adopt the measures listed in Appendix B, "Environmental Protection Measures", to avoid or minimize potential impacts from Project construction. The description of construction activities provided below will incorporate and be subject to the adopted environmental protection measures as well as measures/requirements imposed as part of federal or state permits and authorizations.

3.1 HVAC/HVDC Converter Station Construction

The construction of a converter station typically includes:

- Land surveying and staking;
- Pre-construction surveys for biological and cultural resources
- Clearing and grubbing, grading, and construction of all-weather access roads;
- Fencing;
- Compaction and foundation installation;
- Installation of underground electrical raceways and grounds;
- Steel-structure erection and area lighting;
- Installation of insulators, bus bar, and high-voltage equipment;
- Installation of Control and protection equipment;

- Placement of final crushed-rock surface; and
- Testing and electrical energization.

Clean Line will begin the construction of a typical converter station with survey work, geotechnical sample drillings, and soil resistivity measurements that Clean Line will use in the final design phases of the station. Once the near-final design of the station has been completed, a civil contractor will mobilize to perform site-development work, including grubbing and reshaping the general grade to form a relatively flat working surface. This effort also will include the construction of all-weather access roads. Clean Line will erect an 8-foot-tall chain-link fence around the perimeter of the station to prevent unauthorized personnel from accessing the construction and staging areas. The perimeter fence will be a permanent safety feature to prevent the public from accessing the station. Clean Line will compact the excavated and fill areas to the required densities to allow structural foundation installations. Following the foundation installation, underground electrical raceways and copper ground-grid installation will take place, followed by steel-structure erection and area lighting. The steel-structure erection will overlap the installation of the insulators and bus bar, as well as the installation of the various high voltage apparatus (typical of an electrical substation). The installation of the high voltage transformers will require special, high-capacity cranes and crews (as recommended by the manufacturer) to be mobilized for the unloading, setting-into-place, and final assembly of the transformers.

While the above-mentioned activities are taking place, Clean Line will construct, equip, and wire the enclosure that contains the control and protection equipment for the station. Clean Line will place a final crushed-rock surfacing on the subgrade to make a stable driving and access platform for the maintenance of the equipment. After Clean Line has installed the equipment, testing of the various systems will take place, followed by electrical energization of the facility. Clean Line will generally time the energization of the facility to take place with the completion of the transmission line work and other required facilities.

Some of the existing AC transmission lines proximate to the existing Shelby substation may be relocated to provide adequate space for safe construction of the Tennessee Converter Station.

Construction of a single converter station is estimated to take 32 months. The construction personnel peak is estimated to be 242 workers, and the average over the construction duration is estimated to be 138 workers. An estimate of HVDC converter station construction workforce over time is included in Appendix C, "Workforce, Crews, Equipment, and Trips." An estimate of peak local traffic for construction of an HVDC converter station is included in Appendix C, "Workforce, Crews, Equipment, and Trips." An estimate of local vs. non-local labor on converter station construction is included in Appendix C, "Workforce, Crews, Equipment, and Trips."

Table 3-1, "Typical HVDC Substation/Converter Station Construction and Equipment," provides the typical types of equipment Clean Line expects to use to construct a converter station. Details on equipment engine ratings, fuel types, operation durations and average engine loads are included in Appendix C, "Workforce, Crews, Equipment, and Trips."

Table 3-1 Typical HVDC Converter Station, Estimated Equipment		
Activity	Quantity of Equipment	Type of Equipment
Site Management	2	Office Trailer
	5	Pick-up Truck
	6	All-Terrain Vehicle (ATV)
	1	Loader Backhoe
	2	Truck (1-ton)
	2	Generator
Surveyors	5	Pick-up Truck
Site Development	1	Office Trailer
	8	Pick-up Truck
	8	Scraper
	1	Bulldozer (D-8 Cat or Equivalent)
	1	Bulldozer (D-4 Cat or Equivalent)
	4	Excavator 300 Series
	2	Excavator 100 Series
	4	Loader Backhoe
	2	Water Truck
	1	Road Sweeper
	4	Vibratory Compactor
	4	Motor Grader
	4	Wheel Loader (5 CY)
	2	Articulated Dump Truck
	10	Dump Truck
	2	Fuel Truck
2	Mechanics' Truck	
14	Plate Compactor	

Table 3-1 Typical HVDC Converter Station, Estimated Equipment		
Activity	Quantity of Equipment	Type of Equipment
	4	Lowboy Truck
Fence Installation	5	Pick-up Truck
	4	Truck (1-ton)
	4	Forklift (Telescopic)
	3	Concrete Truck
	1	Concrete Line Pump
	4	Loader Backhoe
Equipment Footings	1	Office Trailer
	5	Pick-up Truck
	4	Truck (1-ton)
	4	100 Series Excavator
	4	Loader Backhoe
	2	Vibratory Compactor
	2	Wheel Loader (5 CY)
	4	Bobcat\Skid Loader
	2	Forklift (Telescopic)
	5	Dump Truck
	4	Concrete Truck
	2	Concrete Pump Truck
	2	Concrete Line Pump
	2	Air Compressor
	2	Generator
	2	Mechanics' Truck
1	Fuel Truck	
Cable Trench, Conduits, Grounding	5	Pick-up Truck
	4	Truck (1-ton)
	4	Trencher
	8	Excavator Mini
	4	100 Series Excavator
	4	Loader Backhoe
	2	Vibratory Compactor
4	Bobcat\Skid Loader	
Steel Structures, Electrical	1	Office Trailer

Table 3-1 Typical HVDC Converter Station, Estimated Equipment		
Activity	Quantity of Equipment	Type of Equipment
Equipment Installation	5	Pick-up Truck
	6	Truck (2-ton)
	2	Truck (1-ton)
	4	Forklift (Telescopic)
	4	Boom Lift
	2	Crane (15-ton Boom Truck)
	2	Crane (30-ton)
	4	Welder Truck
	2	Generator
Control Building and Wiring Installation	3	Air Compressor
	5	Pick-up Truck
	4	Crane (120- to 300-ton)
	2	Truck (2-ton)
	4	Utility Van
	2	Trencher
Construction Inspection	1	Splicing Truck
Materials Testing/ Inspection	2	Pick-up Truck

3.2 HVDC and AC Transmission Line Construction

Construction activities for the HVDC and AC transmission lines will typically include the following activities:

- Preparation of multi-use construction yards;
- Pre-construction surveys for biological and cultural resources
- Preparation of the ROW;
- Clearing and grading;
- Foundation excavation and installation;
- Structure assembly and erection;
- Conductor stringing;
- Grounding; and
- Cleanup and site restoration;

Figure 2-29, “HVDC Transmission Line Construction Sequence,” illustrates these activities and the typical transmission construction sequence. For a more detailed example of construction activities and durations during and between those activities, as they would occur on one tract of agricultural land, see “Typical Construction Activities and Durations on Single Parcel” in Appendix C, “Workforce, Crews, Equipment, and Trips.”

The duration of construction is expected to be approximately 36 to 42 months for the entire Project, including the time from initiation of clearing and grading through clean up and restoration. Clean Line expects the duration of construction for either a single HVDC segment or the complete AC Collection System to be approximately 24 months from mobilization to restoration. The actual construction duration will be dependent on a number of factors such as weather and availability of labor. Clean Line will divide the Project into several segments with multiple contractors working concurrently on different portions of the route to accomplish this schedule and to maintain effective management of construction operations and allocation of resources. For the purposes of estimating resource needs, Clean Line assumes that the HVDC line will be constructed in five segments of approximately 140 miles in length. Clean Line expects to construct the AC collection lines in four to six segments up to 40 miles in length. For the purposes of estimating resource needs, Clean Line assumes that up to 206 miles of transmission line would be constructed for the AC collection system. Construction of the AC lines requires crew sizes and personnel similar to the HVDC line segments on a per-mile basis. Clean Line will task specific crews to complete each of the individual activities required for construction along each segment in assembly line fashion (see Figure 2-29, “HVDC Transmission Line Construction Sequence,” and Appendix C, “Workforce, Crews, Equipment, and Trips”). Construction would be active on several HVDC segments and/or the AC collection system simultaneously.

Clean Line expects the duration of construction for an individual HVDC segment to be approximately 24 months from mobilization of equipment to site restoration. Disturbance at any one location along a segment would be less, with the length of disturbance affected by the land use, and progress of the individual work crews. The construction personnel peak in any 140-mile segment of the HVDC route would be approximately 290 workers, and the average over the construction duration of one HVDC segment would be 207 workers. An estimate of construction workforce over time for an HVDC segment is included in Appendix C, “Workforce, Crews, Equipment, and Trips.”

Clean Line expects the duration of construction for the entire AC collection system to be approximately 24 months from mobilization of equipment to site restoration. The construction peak for the AC collection system would be approximately 428 workers, and the average over the construction duration of the AC collection system would be approximately 305 workers. An estimate of construction workforce over time for the AC collection system is included in Appendix C, “Workforce, Crews, Equipment, and Trips.”

Clean Line will stage construction on each HVDC segment and on the AC collection system from multi-use construction yards located at regular intervals (approximately every 25 miles) along the route(s). Based on a preliminary desktop review of labor resources, Clean Line anticipates that approximately one-half of the workforce could be recruited from within 200 miles of the Project. Construction access will occur at several locations along the transmission line route, resulting in dispersed construction activity and associated traffic. Appendix C, “Workforce, Crews, Equipment, and Trips,” provides peak local traffic for an HVDC segment. Appendix C, “Workforce, Crews, Equipment, and Trips,” provides an estimate of local vs. non-local labor on an HVDC segment. Local traffic and local vs. non-local labor for construction of the AC collection system is expected to be similar to that of an HVDC segment on a per-mile basis.

Project-wide, the workforce will reach a peak of approximately 2,431 workers. The average workforce across the Project during an assumed 36 month construction duration will be approximately 1,260 people.

Appendix C, “Workforce, Crews, Equipment, and Trips,” provides an estimate of Project-wide workforce over time.

Table 3-2, “Typical HVDC Segment Construction Equipment,” provides the number and type of equipment Clean Line expects to use to construct the HVDC transmission line in a typical 140-mile segment. Appendix C, “Workforce, Crews, Equipment, and Trips,” also provides an estimate of equipment use by segment. Appendix C, “Workforce, Crews, Equipment, and Trips,” provides details on equipment engine ratings, fuel types, operation durations and average engine loads for an HVDC segment.

The equipment types and quantities required is similar for the AC collection system on a per-mile basis.

Table 3-2 Typical HVDC Segment Construction Equipment		
Activity	Quantity of Equipment	Type of Equipment
ROW Clearing	3	Bulldozer (Caterpillar D8 or equivalent)
	2	Chipper
	3	Excavator
	2	Feller buncher
	2	Flail mower or bush hog
	2	Hydra-Ax or mulcher
	3	Loader
	14	Pick-up truck
	2	Skidder
Access Roads & Pads	5	Backhoe
	4	Bobcat
	3	Bulldozer (Caterpillar D8 or equivalent)
	9	Dump truck
	5	Excavator
	3	Loader
	2	Motor grader
	10	Pick-up truck
	2	Roller compactor
	2	Scraper
	2	Water truck
Foundation Construction	5	Bobcat
	3	Bulldozer (Caterpillar D8 or equivalent)
	15	Concrete truck
	7	Crane (20-ton)
	5	Drill rig
	4	Dump truck

Table 3-2 Typical HVDC Segment Construction Equipment		
Activity	Quantity of Equipment	Type of Equipment
	3	Excavator
	5	Generator
	3	Loader
	10	Pick-up truck
	5	Plate compactor
	5	Truck (1-ton)
	5	Wagon drill
Structure assembly crews	4	Air compressor
	20	Crane (rubber-tired)
	5	Generator
	14	Pick-up truck
	15	Truck (2-ton)
Structure Erection	10	Cranes (120- to 300-ton)
	5	Generator
	1	Helicopter (large)
	14	Pick-up truck
	5	Truck (1-ton)
	5	Truck (2-ton)
Wire installation crew (Stringing, Tensioning, & Pulling)	4	3-drum puller (heavy)
	4	3-drum puller (medium)
	4	Bulldozer (Caterpillar D8 or equivalent)
	7	Crane (20-ton)
	4	Crane (30-ton)
	2	Double bull-wheel tensioner (heavy)
	2	Double bull-wheel tensioner (light)
	1	Helicopter (small)
	14	Pick-up truck
	2	Single-drum puller (large)
	4	Splicing truck
	8	Truck (5-ton)
	12	Wire reel trailer
Restoration crew	2	Loader
	2	Motor grader
	7	Pick-up truck

Table 3-2 Typical HVDC Segment Construction Equipment		
Activity	Quantity of Equipment	Type of Equipment
Supervision	2	Office trailer
	4	Pick-up truck
Materials management & delivery, steel hauling	5	Boom truck
	4	Dump truck
	15	Forklift
	7	Pick-up truck
	10	Steel haul truck
Mechanic & Equipment Management	3	Air compressor
	2	Mechanic's truck
Refueling	2	Fuel truck
Watering & Dust Control	2	Water truck
Construction Inspection	4	Pick-up truck
Materials Testing	4	Pick-up truck
Environmental Compliance	4	Pick-up truck
Survey crew	3	All-terrain vehicle (ATV)
	4	Pick-up truck
Clean-up crew (Cleanup/Sanitation)	4	Backhoe
	4	Dump truck
	4	Pick-up truck
	5	Road sweeper

3.2.1 Temporary Construction Areas

Clean Line will use temporary construction areas to support construction. Examples of temporary construction areas include multi-use construction yards, fly yards, tensioning or pulling sites, wire-splicing sites and concrete batch plants.

The approximate number and typical dimensions for temporary construction areas are summarized in Table 3-3, "Temporary Construction Areas."

Table 3-3 Temporary Construction Areas	
Facility	Construction Dimensions
AC Interconnection	
<p>Tensioning or Pulling Sites Inside ROW (Figure 2-16, "Conductor and Ground-Wire Stringing Activities")</p>	<p>150 feet wide (ROW width) x 600 feet long (Typical)</p> <p>No greater than 18,000 linear feet apart. ¹</p> <p>Oklahoma AC Interconnection (345kV AC: 3 miles/1 pulling site and 1 tensioning site for every 2 miles = approximately 4 sites for the 345kV line.)</p> <p>Tennessee AC Interconnection Tensioning and pulling for ties between the Shelby substation and the Tennessee Converter Station (if necessary) will be contained within the footprint of both stations. No temporary construction area will be necessary.</p> <p>Arkansas AC Interconnection (500kV AC: 5 miles/1 pulling site and 1 tensioning site for every 2 miles = approximately 6 sites for the 500kV line.)</p>

Table 3-3 Temporary Construction Areas	
Facility	Construction Dimensions
<p>Tensioning or Pulling Sites Outside ROW (Figure 2-16, “Conductor and Ground-Wire Stringing Activities”)</p>	<p>Tensioning or pulling sites will be located partially outside the ROW at locations where the line turns more than 8 degrees.</p> <p style="text-align: center;">Oklahoma AC Interconnection</p> <p>Of the total footprint of the 4 pulling or tensioning sites, approximately 1 acre will be outside the ROW. The exact area outside of the ROW is dependent on turning angles and subject to more detailed design.</p> <p style="text-align: center;">Tennessee AC Interconnection</p> <p>Tensioning and pulling for ties between the Shelby substation and the Tennessee Converter Station (if necessary) will be contained within the footprint of both stations. No temporary construction area will be necessary.</p> <p style="text-align: center;">Arkansas AC Interconnection</p> <p>Of the total footprint of the 6 pulling or tensioning sites, approximately 1.6 acres will be outside the ROW. The exact area outside of the ROW is dependent on turning angles and subject to more detailed design.</p>
<p>Wire-splicing Site (Figure 2-16, “Conductor and Ground-Wire Stringing Activities”)</p>	<p style="text-align: center;">100 feet x 100 feet (within the ROW)</p> <p style="text-align: center;">Spaced 1 to 3 miles apart.</p> <p style="text-align: center;">Oklahoma AC Interconnection</p> <p>(500kV AC: 3 miles/1 site per 2 miles = approximately 2 sites for the 345kV line)</p> <p style="text-align: center;">Tennessee AC Interconnection</p> <p>Any wire splicing site for the Tennessee AC interconnection will be contained within the footprint of the Tennessee Converter Station and/or the existing Shelby substation.</p> <p style="text-align: center;">Arkansas AC Interconnection</p> <p>(500kV AC: 5 miles/1 site per 2 miles = approximately 3 sites for the 500kV line)</p>
<p>Multi-use Construction Yards (Figure 2-18, “Multi-Use Construction Yard”)</p>	<p style="text-align: center;">25 acres +/-</p> <p style="text-align: center;">Oklahoma AC Interconnection</p> <p>Multi-use construction yard space for the Oklahoma AC interconnection will be shared with that of the HVDC line. No separate MUCY is necessary for the Oklahoma AC interconnection.</p> <p style="text-align: center;">Tennessee AC Interconnection</p> <p>The Tennessee AC interconnection will share construction yard space with the Tennessee Converter Station, and will be contained within the footprint of the converter station.</p> <p style="text-align: center;">Arkansas AC Interconnection</p> <p>Multi-use construction yard space for the Arkansas AC interconnection will be shared with that of the HVDC line. No separate MUCY is necessary for the Oklahoma AC interconnection.</p>

Table 3-3 Temporary Construction Areas	
Facility	Construction Dimensions
Fly Yards (Figure 2-18, "Multi-Use Construction Yard")	No fly yards outside MUCYs will be required for the AC Interconnections
HVDC Transmission Line	
Tensioning or Pulling Sites inside ROW (Figure 2-16, "Conductor and Ground-Wire Stringing Activities")	<p style="text-align: center;">200 feet wide (ROW width) x 650 feet long (Typical)</p> <p style="text-align: center;">No greater than 15,000 linear feet apart.²</p> <p style="text-align: center;">Based on preliminary engineering, 755 pulling or tensioning sites are necessary for the HVDC line.</p>
Tensioning and Pulling Sites Outside ROW (Figure 2-16, "Conductor and Ground-Wire Stringing Activities")	Based on preliminary engineering and access planning, approximately 230 acres of pulling or tensioning sites across the HVDC route will be outside of the ROW.
Wire-splicing Site (Figure 2-16, "Conductor and Ground-Wire Stringing Activities")	<p style="text-align: center;">100 feet x 100 feet (within the ROW) Spaced 1 to 3 miles apart (720 miles/average of 1 site every 2 miles = 360 sites)</p>
Multi-use Construction Yards (Figure 2-18, "Multi-Use Construction Yard")	<p style="text-align: center;">25 acres +/-</p> <p style="text-align: center;">Located at regular intervals of approximately 25 miles apart and typically within 10 miles of the ROW.</p> <p style="text-align: center;">(720 miles/25 per mile = approximately 29 yards)</p>
Fly Yards (Figure 2-18, "Multi-Use Construction Yard")	<p style="text-align: center;">10 to 15 acres</p> <p style="text-align: center;">Located at approximately 5-mile intervals along the ROW and typically within 10 miles of the ROW.</p> <p style="text-align: center;">(720 miles/1 yard per 5 miles = 144 yards – 29 yards within multi-use construction yards = 115 fly yards)</p>

Table 3-3 Temporary Construction Areas	
Facility	Construction Dimensions
Concrete Batch Plants	<p>Access to concrete is required at approximately 60-mile intervals along the ROW. Clean Line will use local concrete plants where practicable.</p> <p>Based on preliminary review of commercial ready-mix plants in proximity to the Project, up to four temporary batch plants may be required where the haul time for a commercial ready-mix concrete producer exceeds 45 minutes (where the haul distance may exceed 25 to 30 miles).</p> <p>Temporary portable concrete batch plants will require approximately 1 to 2 acres within multi-use construction yards.</p>
AC Collection System	
Tensioning and Pulling Sites Inside ROW (Figure 2-16, "Conductor and Ground-Wire Stringing Activities")	<p style="text-align: center;">150 feet wide (ROW width) x 600 feet long</p> <p style="text-align: center;">No greater than 18,000 linear feet apart.¹</p> <p>(Total 345kV AC: 206.4 miles/1 pulling site and 1 tensioning site for every 2 miles = approximately 200 sites for 345kV. It is assumed that about 25% [50] will be entirely inside the ROW)</p>
Tensioning and Pulling Sites Outside ROW (Figure 2-16, "Conductor and Ground-Wire Stringing Activities")	<p style="text-align: center;">150 feet wide (ROW width) x 600 feet long</p> <p>Tensioning or pulling sites will be located partially outside the ROW at locations where the line turns more than 8 degrees. Of the total footprint of the approximately 200 pulling or tensioning sites, approximately 64 acres will be outside the ROW. The exact area outside of the ROW is dependent on turning angles and subject to more detailed design.</p>
Wire-splicing Site (Figure 2-16, "Conductor and Ground-Wire Stringing Activities")	<p style="text-align: center;">100 feet x 100 feet (within the ROW)</p> <p style="text-align: center;">Spaced 1 to 3 miles apart</p> <p>(345kV AC: 300 miles/1 site per 2 miles = 150 sites for 345kV)</p>

**Table 3-3
Temporary Construction Areas**

Facility	Construction Dimensions
Multi-use Construction Yards (Figure 2-18, "Multi-Use Construction Yard")	25 acres +/- Located at regular intervals approximately 25 miles apart. (345kV AC: 300 miles/1 per 25 miles = approximately 15 yards for 345kV AC)
Fly Yards (Figure 2-18, "Multi-Use Construction Yard")	10 to 15 acres Located at approximately 5-mile intervals along the ROW (345kV AC 300 miles/1 yard per 5 miles = 60 yards – 15 yards within multi-use construction yards = 45 fly yards)
Concrete Batch Plants	Access to concrete is required at approximately 60-mile intervals along the ROW. Clean Line will use local concrete plants where practicable. Based on preliminary review of commercial ready-mix plants in proximity to the Project, two temporary batch plants may be required where the haul time for a commercial ready-mix concrete producer exceeds 45 minutes (where the haul distance may exceed 25 to 30 miles). Temporary portable concrete batch plants will require approximately 1 to 2 acres within multi-use construction yards.

- (1) Assumes AC reel lengths are 9,000 feet on 96-inch reels. Two reels per setup limits the separation between T&P to about 18,000 feet maximum. Clean Line will also utilize shorter distances.
- (2) HVDC Reel lengths are 7,500 feet on 96-inch reels. Two reels per setup limits the separation between tensioning and pulling to about 15,000 feet maximum. Clean Line will also utilize shorter distances.

3.2.1.1 Tensioning or Pulling Sites

Tensioning or pulling sites will typically be 2 to 3 miles apart. Land requirements for typical tensioning or pulling sites are listed in Table 2-3, "HVDC Transmission Line Facility Dimensions and Land Requirements," 2-4, "AC Collection System Oklahoma Panhandle Region Transmission Lines Facility Dimensions and Land Requirements," 2-5, "AC Interconnection in Oklahoma AC Transmission Lines Facility Dimensions and Land Requirements," 2-6, "AC Interconnection in Tennessee AC Transmission Lines Facility Dimensions and Land Requirements," and 2-7, "Alternative AC Interconnection Arkansas AC Transmission Lines Facility Dimensions and Land Requirements," and would be either entirely within the ROW or partially outside the ROW, depending on the structure's turning angle and type. Where the transmission line turns, the tensioning or pulling site may extend outside of the ROW to maintain a straight line with the ground wire and conductor being pulled (see Figure 2-16, "Conductor and Ground-Wire Stringing Activities").

3.2.1.2 Multi-use Construction Yards

Multi-use construction yards are one type of temporary construction area that Clean Line will use. Multi-use construction yards are primarily for staging of construction personnel and equipment, and for material storage to support construction activities (Figure 2-18, "Multi-use Construction Yard"). Clean Line will locate temporary concrete batch plants (discussed in Section 3.2.1.5, "Concrete Batch Plants") within a multi-use construction yard where needed. Clean Line will locate multi-use construction yards outside

the ROW and typically at intervals of approximately 25 miles. Additionally, they will be located within approximately 10 miles of the ROW or Project facility. Typical multi-use construction yards will be approximately 25 acres in size, fenced and access-controlled.

Flat ground is preferred for multi-use construction yards, although moderate slopes (maximum slope 6 percent) are acceptable for some activities. Approximately 20 percent of each multi-use construction yard (approximately 5 acres each) must be reasonably flat (maximum 4 percent slope) and will be surfaced with a 6-inch gravel base.

To the extent practicable, Clean Line will employ site-selection criteria to determine preferred locations, with exceptions noted below. The site-selection criteria for both temporary multi-use construction yards and fly yards are as follows:

- Preferred sites will be on previously disturbed, privately owned parcels (e.g., vacant industrial yards, commercial lots) or on other such suitable parcels.
- Sites will be located in a manner to minimize conflict with nearby and adjacent land uses.
- Sites will have good access to public roads.
- Sites will be relatively flat.
- Sites will be selected for their relative ease of restoration; preferred sites are those that can be restored more easily to their original condition.

Clean Line may arrange individual multi-use construction yards differently, but typical sites will include areas designated for a field office, crew parking, sanitation, waste management, fueling, equipment wash, material storage, and equipment storage. Clean Line will base fuel trucks, maintenance trucks and construction crews in multi-use construction yards. Clean Line will store any fuel, lubricants, antifreeze, detergents, paints, solvents, and/or other chemicals used during construction at the multi-use construction yards consistent with standard practices and relevant permits.

3.2.1.3 Fly Yards

Clean Line will use helicopters for conductor stringing operations and/or for transport and erection of structure sections during construction. Clean Line will locate landing areas for the helicopters (fly yards) at regular intervals of approximately 5 miles along the ROW. About 20 percent of fly yards will be collocated within multi-use construction yards. All other fly yards would be located near the ROW. Typical fly yards will be approximately 5 acres or less in size.

Clean Line may arrange individual fly yards differently, but typical sites will include areas designated for helicopter landing, crew parking, sanitation, waste management, refueling, and temporary material staging. Fly yards would be operated and maintained consistent with standard practices and relevant permits.

To the extent practicable, Clean Line will employ site-selection criteria for fly yards similar to those used for multi-use construction yards.

3.2.1.4 Wire Splicing Sites

Typically, wire-splicing sites are within the ROW. Conductors and shield wires (wires) are strung into their supporting structures over a length of two reels. The wire from the two reels is mechanically joined at the wire ends with a temporary steel wire-gripping sleeve (stringing sock) which passes through the stringing blocks. After the wire is strung and secured, the stringing sock is replaced with a compression splice connector. The location of the splice connector installation is the wire splicing site. Typical wire splicing sites include a wire splicing truck and a line truck to facilitate installation.

3.2.1.5 Concrete Batch Plants

Portable concrete batch plants will be located within multi-use construction yards.

Concrete will be required for construction of foundations for transmission structures, foundations for transformers and electrical equipment at converter stations, and foundations at fiber optic regeneration sites. Concrete will be delivered to structure sites and ancillary facilities in concrete trucks with a capacity of up to 10 cubic yards. Clean Line will obtain concrete from commercial ready-mix concrete producers, to the extent practicable. In locations where haul times exceed 45 minutes (approximately 25 to 30 miles haul distance), concrete will be dispensed from portable concrete batch plants located within a multi-use construction yard. Based on preliminary review of commercial ready-mix plants in proximity to the Project, Clean Line may require up to four temporary batch plants for the HVDC transmission line and two for the AC collection system (where the haul distance may exceed 25 to 30 miles).

Temporary concrete batch plant facilities typically consist of silos containing fly ash or blast furnace slag and cement; sand and gravel material storage bins; mixing equipment; aboveground storage tanks containing concrete additives and water; designated areas for sand and gravel truck unloading, concrete truck loading, and concrete truck washout. The batching unit, aggregate conveying unit, water supplying and additive agent supplying system, scaling system, mixing system, electrical control system, and pneumatic system are centralized on one or two trailer chassis.

3.2.2 Preparation of the Transmission Line Right-of-Way

Prior to the start of construction, Clean Line will prepare the ROW for construction by delineating all approved access, work, and environmentally sensitive areas (e.g., wetlands, streams, etc.) and conducting any required surveys or inspections of such areas. Clean Line will develop specific flagging, staking, and signage procedures for the Project to identify these areas. Some limited vegetation trimming may be required for land surveying activities. The ROW will be 150 to 200 feet in width.

3.2.3 Clearing and Grading Activities

Clean Line will begin construction of the transmission lines with clearing and grading of access roads to allow entry to individual structure locations. After the access roads are cleared and/or graded, individual structure sites, wire splicing sites, and tensioning and pulling sites will be cleared and/or graded, as necessary, to install the transmission line support structures and facilitate access for future transmission line and structure maintenance and grading.

Clearing of natural vegetation and grading will be required for safe construction purposes and for long-term electrical safety clearances, maintenance, and reliability of the transmission line. Hand and/or mechanized clearing methods may be used. Clearing of tensioning and pulling sites will be limited to removal of larger woody vegetation or dense brush that might otherwise interfere with tensioning equipment or damage conductors. Similarly, ground disturbance activities will be limited to minor grading to provide temporary access for tensioning equipment.

Within or adjacent to the ROW, Clean Line may selectively remove vegetation for access during construction and to provide adequate electrical safety clearance. Present vegetation reliability rules issued by North American Electric Reliability Corporation (NERC) require the removal of all tall-growing species that could grow into the conductors (wire zone) and adjacent tall-growing species that could fall into the conductors (Figures 2-7, "DC R.O.W. Limits" and 2-19 "AC R.O.W. Limits"). Clean Line will also remove vegetation outside the wire zone, including beyond the limits of the ROW, which could fall into the conductors, as described in the Transmission Vegetation Management Plan that will be developed and filed

with NERC for the Project. Section 4 “Operations and Maintenance,” describes the Transmission Vegetation Management Plan for maintenance.

Clean Line may selectively apply herbicides during clearing and grading for construction to minimize regrowth of certain trees and woody species. Only persons who are certified and licensed to apply herbicides perform this work. During clearing and grading for construction, Clean Line may remove dead, dying, diseased, or unstable trees or branches outside of the easement, which are encroaching on the ROW and will later threaten the safe and reliable operation of the transmission system.

Clean Line will clear individual structure sites to provide a safe working space for placing equipment, vehicles, and materials for tower assembly and erection. Equipment used in clearing could range from a brush hog flail-type mower to a bulldozer to blade the area required. The grade of the temporary disturbance area should be no greater than 8 percent. If grading structure sites will require a bulldozer or other earth moving equipment, the minimum amount of grading will occur to provide a safe working space for placing equipment, vehicles, and materials for tower assembly and erection.

Additional equipment or construction practices may be required if solid rock is encountered at a structure location and cannot be removed with conventional excavation equipment. Hydraulic rock hammers or blasting may be required to remove the rock. Excess rock that is too large in size or volume to be spread at the site or rock that the landowner requests not be spread at the site will be hauled away and disposed of at approved landfills.

In addition, Clean Line will develop a Stormwater Pollution Prevention Plan (SWPPP) during preliminary and final engineering and will implement the SWPPP during construction.

3.2.4 Foundation Excavation and Installation

Excavations for foundations will typically be made with power equipment (Table 3-2, “Typical HVDC Transmission Line Construction, Estimated Personnel, and Equipment,” provides a list of equipment used for foundation construction). The excavation and installation of a foundation will require access to the site by a power auger or drill rig, a crane, material trucks, and concrete trucks using designated access roads. In areas where disturbance is limited (i.e., by permit conditions or adopted environmental protection measures) or areas of steep terrain, excavation and installation of the foundation may require a power auger or drill brought in by all-terrain vehicle (ATV), track unit, or similar device.

Within the Mississippi floodplain, the foundation depths required for lattice structures could range from 17 feet to 158 feet depending on structure height, soil quality, and structure type (tangent, angle or deadend). For tangent, basic suspension structures, which are estimated to make up 60% of all structures within the Mississippi floodplain, foundation depths would not exceed 40 feet for lattice structures of typical height, even in very poor soils. Within the Mississippi floodplain, the foundation depths required for pole structures could range from 26 feet to 115 feet depending on structure height, soil quality and structure type (tangent or angle – pole structure deadends would require much deeper and wider foundations, but are not expected to be used in this area) For tangent, basic suspension structures, foundation depths would not exceed 56 feet for pole structures of typical height, even in very poor soils. Outside of the Mississippi floodplain, the foundation depths required for lattice structures average 15 feet, and the foundation depths required for pole structures average 30 feet.

Within the work areas, the disturbance associated with the tower footings (structure footprint) will depend on the type of structure and foundation. Tables 2-3, “HVDC Transmission Line Facility Dimensions and Land Requirements,” 2-4, “AC Collection System Oklahoma Panhandle Region Transmission Lines Facility Dimensions and Land Requirements,” 2-5, “AC Interconnection in Oklahoma AC Transmission Lines Facility Dimensions and Land Requirements,” 2-6, “AC Interconnection in Tennessee AC Transmission Lines Facility Dimensions and Land Requirements,” and 2-7, “Alternative AC

Interconnection Arkansas AC Transmission Lines Facility Dimensions and Land Requirements” provide information on approximate structure footprints. Clean Line will clear the work area of vegetation to the extent necessary for installation of foundations and erection of transmission structures and for safe operation of the transmission facilities. After transmission line construction, all work areas outside of structure footprint and not otherwise occupied by permanent access roads or ancillary facilities needed for operations and maintenance of the transmission facilities, will be restored (see Section 3.2.8, “Cleanup and Restoration”).

Clean Line will excavate the foundation holes by drilling, blasting, or installing special rock anchors. Blasting may be used in isolated locations where required to break up rock. When blasting techniques are used, all safeguards associated with using explosives (e.g., blasting mats) will be implemented. Environmental protection measures associated with blasting are described in Appendix B, “Environmental Protection Measures.”

In sandy soils and areas with a high water table, Clean Line may use approved synthetic drilling fluids to suspend drill cuttings and stabilize excavations for drilled shaft foundations. Information regarding potential drilling fluids is included in Appendix D, “Drilling Fluids.”

Clean Line will procure the required water to prepare drilling fluids from municipal sources and/or from landowners. While Clean Line currently anticipates obtaining water from municipal sources, if other sources are used written landowner approval and any applicable state or local authorizations will be obtained prior to extracting water from any non- municipal source and the approval will include a description of the location of the water source and the volume approved for use. Water uses, volume estimates, and anticipated sources are provided in Appendix E, “Water Uses.”

Where suitable, Clean Line may use excavated clean spoil materials for fill and/or spread at approved locations, for example upland locations near a structure site or along access roads. Where Clean Line spreads spoil materials at the site, the materials would be covered with topsoil to promote re-growth of vegetation. Disposition of excavated materials would be governed by easement agreements or as otherwise approved by landowners and according to relevant local, state, or federal waste disposal requirements. Clean Line will remove soil from foundation holes and stockpile it on the work area as described below:

1. The first 6 inches of topsoil will be removed from the structure base area (not just the structure foundation holes), placed in a designated segregated pile within the structure work area, and clearly labeled. The structure foundations will be excavated and the spoils will be stockpiled in a designated location within the structure work area until the foundations are complete. Once the foundations are complete, the spoils will be spread over the structure base area and will be graded to blend with surrounding terrain to promote water drainage away from the structure foundations. The segregated topsoil will be replaced over the top of the graded spoils.
2. An approximately 50-foot by 100-foot area adjacent to the structure base area will have the first 6 inches of topsoil removed, placed in a designated segregated pile within the structure work area, and clearly labeled. The structure foundations will be excavated and the spoils will be placed evenly over the 50-foot by 100-foot area. Once the structure foundation excavations and tower erection are complete, the topsoil will be replaced over the top of the spoils.
3. Excess soils that are unsuitable for incorporation into the work area will be transported off site and disposed at an approved commercial landfill.

Clean Line will temporarily fence, when practicable, or cover foundation holes temporarily left open or unguarded to protect the public and wildlife.,

After excavations are complete, Clean Line will typically install foundations through:

- Installation of a rebar cage in the excavation, backfill of the excavation with concrete, and installation of an anchoring assembly while the concrete is still wet; or
- Installation of the structure within the excavation, and backfill with engineered fill (compacted gravel, controlled density fill, or concrete); or
- Installation of a steel grill pad connected with the reinforced steel legs of the structure, which is in turn connected to a driven steel shaft or concrete pile.

Clean Line will contain unused concrete and liquids generated when cleaning concrete placement equipment and dispose of them in accordance with federal, state and local permit requirements. Clean Line will transport excess concrete off site for disposal or return it to the ready-mix plant to be recycled. Dried concrete may be broken up and blended with native spoils for use as clean fill or as a substitute for conventional aggregate on the Project.

Stockpiled soils will be used to backfill the foundation holes. During backfilling, soil will be replaced subsoil first and topsoil at the surface, thereby salvaging the highest concentration of organic matter, nutrients, and residual seed bank. Clean Line will spread remaining topsoil on the access road. This will ensure that Clean Line does not cover the best topsoil for reseeding with subsoil during the restoration of the site. Clean Line may leave some large rocks onsite, if appropriate, to help blend the area in with the surrounding landscape.

3.2.5 Structure Assembly and Erection

For lattice structures, Clean Line will transport bundles of steel and associated hardware (e.g., insulators, hardware, and stringing sheaves) to each structure site by truck for on-site assembly. Clean Line will haul wood blocking to each location and lay it out to support bundled materials aboveground. Then, Clean Line will open and lay out the steel-structure bundles for assembly by sections and assembly into subsections. Typically, the leg extensions for the structures are assembled and erected by separate crews with smaller cranes, to make ready for the setting of the main structure assembly. In other cases, one crew may assemble the entire structure. The assembled subsections will then be hoisted into place by means of a large crane and fastened together to form a complete structure. A follow-up crew will then tighten all the bolts in the required joints. Where lattice structures are used, four to six structures will be required per mile.

For tubular monopole structures, sections will be delivered near each structure site. Each section or the entire structure will be hoisted into place by a crane onto the foundation. Where monopole structures are used, five to seven structures will be required per mile.

3.2.6 Conductor Stringing

Clean Line will deliver insulators, hardware, and stringing sheaves to each structure site. The structures will be rigged with insulator strings and stringing sheaves at each ground-wire and conductor position.

For protection of the public during wire installation, Clean Line will erect guard structures over highways, railroads, power lines, foreign structures, and other barriers. Guard structures will consist of either an H-frame wood pole structure placed on each side of the barriers or a guard cross-beam raised by boom trucks. These structures will prevent ground wires, conductors, or equipment from falling across obstacles. Equipment for erecting guard structures includes augers, backhoes, line trucks, boom trucks, pole trailers, and cranes. Guard structures may not be required for small roads. In such cases, Clean Line will use other safety measures such as barriers, flaggers, or other traffic control. Following stringing and

tensioning of all conductors, Clean Line will remove the guard structures and restore the area (see Section 3.2.8, “Cleanup and Restoration”).

Clean Line will pull (string) pilot lines from structure to structure by either a helicopter or land-operated equipment and thread them through the stringing sheaves at each structure. Following pilot lines, Clean Line will attach a stronger, larger diameter line to conductors, which will then be used to pull the conductors through the sheaves onto structures. Clean Line will repeat this process, using pulling equipment at one end and braking or tensioning equipment at the other end, until the ground wire or conductor is pulled through all the sheaves.

Clean Line will string ground wires, fiber optic cable, and conductors using powered pulling equipment at one end and powered braking or tensioning equipment at the other end of a conductor segment.

Tensioners, pullers, line trucks, wire trailers, dozers, pick-ups, and tractors needed for stringing and anchoring the ground wire or conductor will be located at these sites. The tensioner, in concert with the puller, will maintain tension on the ground wire or conductor while they are fastened to the structures. In areas with soft unstable soils, Clean Line may use matting or rock to support tensioning equipment. Clean Line will reclaim gravel used for temporary access for use elsewhere on the Project and restore surface contours as described in the Restoration Plan.

3.2.7 Grounding

Grounding will be required for each structure. The need for counterpoise,⁵ a trenched-in ground wire and rod, will depend on local soil resistance characteristics. Part of standard construction practices prior to conductor installation involves measuring the resistance of the ground to electrical current near the structures. If the measurements indicate high resistance, counterpoise will be installed, which will consist of trenching in-ground wire to a depth of 12 inches in non-cultivated land and 18 to 30 inches in cultivated land, with a ground rod driven at the end. Clean Line will contain the counterpoise within the limits of the ROW and may alter it or double it back and forth to meet the requirements of the Project. Clean Line will install the ground rod at the time of structure installation. Typical equipment used for installing ground rods includes line trucks, backhoes, and trenchers.

3.2.8 Cleanup and Restoration

Clean Line will keep construction sites, material storage yards, and access roads in an orderly condition throughout the construction period. Clean Line will remove refuse and trash from the sites and dispose of it in a timely and approved manner (e.g., in an approved landfill). In remote areas, trash and refuse could be removed to a construction staging area and contained temporarily until it could be hauled to an approved site. Clean Line will not burn construction trash. Clean Line will restore the ROW and work areas when construction is complete according to the Restoration Plan (to be developed).

The Restoration Plan will identify and describe restoration actions for construction- and operation-related disturbance. Restoration actions will be specific to the setting and vegetation communities affected during construction and operation activities, disturbance type, and duration. In particular, additional information is required to develop appropriate seed mixes that will incorporate the dominant plant species of the existing vegetation communities, where applicable.

⁵ **Counterpoise** is a type of electrical ground that enhances electrical connection to the Earth. It is used when a normal earth ground is compromised because of high soil resistance. It consists of a network of wires buried in the native soil to develop a low resistance connection to earth ground.

3.3 Access Road Construction

Clean Line will use existing highways, local public roads, and existing local private roads to the extent practicable. Clean Line will also repair or improve certain private roads to improve access for heavy equipment. Where existing roads do not provide sufficient or safe access and as local conditions allow, Clean Line will use a range of access road options, such as overland travel or building new roads. For more detail regarding the number and types of access roads anticipated for the Project, please see Section 2.4, "Access Roads," and Tables 2-6, "Access Roads Facility Dimensions and Land Requirements," 2-7, "Estimated Access Road Miles by Road Type for HVDC Transmission Lines," and 2-8, "Estimated Access Road Miles by Road Type for AC Transmission Lines."

During construction, the size and weight of the heavy equipment typically dictates the minimum road dimensions. For example, heavy equipment during construction will typically include a lowboy equipment hauling truck, flatbed steel hauling truck, or truck-mounted aerial lift crane. Commercial concrete mixing trucks will typically generate the heaviest axle loads and often dictate certain structural requirements. Partial concrete loads may reduce weight where weight restrictions exist. To accommodate this construction equipment, project specifications for roads require a 14-foot-wide travel surface on straight sections and 16- to 20-foot-wide travel surface for horizontal curves.

Existing farm roads and unimproved two-track roads often suffice for both construction and operational access needs without significant upgrades, provided there is adequate horizontal clearance, level terrain, and firm native soil to support overland travel. Some grading may be required to ensure safe vehicle passage or during restoration.

Different types of construction activities are required with different terrain. In areas of gentle terrain, and where soil conditions permit, direct vehicle travel over low growth vegetation is generally preferred. In this case, Clean Line will retain existing low-growth vegetation to the extent practicable and will only remove any larger woody vegetation to allow safe vehicle passage. In areas of moderate to steep terrain, new roads will follow the natural contours of the terrain to avoid cuts on steep side slopes. In areas of rolling to hilly terrain, a wider disturbance area will be required to account for cuts and fills and surface drainage. In steep or mountainous terrain, the disturbance width may exceed 50 feet depending on soil conditions.

Access road construction will be consistent with Appendix B, "Environmental Protection Measures," relevant jurisdictional standards and landowner agreements.

3.3.1 Specialized Road Construction Techniques

In limited circumstances (e.g., flood hazard areas, waterbodies, steep slopes, shallow bedrock), special road construction techniques may be required.

Special construction techniques addressed below include:

- Temporary Crossings,
- Road construction within special flood hazard areas;
- Road construction at waterbody crossings;
- Broad Based Dips;
- Construction on steep slopes; and
- Blasting.

Temporary Crossings

Clean Line may use temporary matting or temporary channel spanning structures during construction where soil conditions will not support heavy construction vehicles or where gravel or fill is prohibited or would otherwise interfere with the current land use. Bottom land soils and wetlands typically have engineering properties that make them poorly suited for roads. Where fill in floodplains is prohibited or where gravel surfacing would interfere with agricultural land uses, temporary matting or other similar solutions may be necessary. The size and placement of temporary matting or temporary channel spanning structures will be location specific.

Road Construction within Special Flood Hazard Areas

Conventional roadway construction within Special Flood Hazard Areas (SFHAs) will typically involve excavation of native soils, placement of separation geotextile fabric, and replacement of native soils with coarse rock sub-base topped with smaller crushed gravel base. Permanent roads are compacted and shaped to promote drainage and will be designed with roadside drainage ditches to convey stormwater. In many cases, cuts and fills will need to balance in order to satisfy floodplain development criteria and obtain a no-rise certification, if applicable. The SFHA is that portion of the floodplain subject to inundation by the base flood (1 percent annual chance or 100-year floodplain) SFHAs are shown on FEMA Digital Flood Insurance Rate Maps as A Zones.

Road Construction at Waterbody Crossings

In some instances, avoiding construction of access roads across waterbodies will not be practicable. Clean Line has identified four typical stream crossing methods, based on stream characteristics and permitting requirements. All Project-related activities in waterbodies will be conducted in compliance with applicable federal and state permit requirements.

- *Type 1 – Drive-Through with Minimal Grading and/or Fill.* Type 1 crossings may be used for crossings of seasonally dry, non-fish-bearing drainages (ephemeral and intermittent streams) requiring minimal grading and/or fill to repair surface ruts or re-contour minor surface erosion. Where required, stabilization to support vehicular travel will generally involve minor grading and, in some cases, placement of geotextile fabric and surface application of commercially available aggregate base material on approaches and the drainage bottom below the ordinary high water mark. Clean Line will limit the use of fill material to the amount needed for safe vehicular travel. A Type 1 drive-through crossing results in an average disturbance profile of approximately 25 feet wide (along the waterbody).
- *Type 2 – Drive-Through/Ford.* Type 2 crossings may be used for defined stream channel (ephemeral, intermittent, or perennial) that require grading and stabilization. Use of ford crossings on perennial streams would largely be limited to shallow water streams. Clean Line would typically grade stream banks and approaches to allow vehicle passage. In some cases, the channel bed may require stabilization. Ford crossings will have equal slope to the natural channel. Clean Line will armor approaches with surface application of commercially available aggregate base rock extending at least 75 feet on each side of the stream channel. Rock armoring will be placed so as not to impede natural water flow. If necessary to ensure flow, Clean Line will typically excavate the streambed and replace native materials with large angular rock (pit run) over geotextile fabric, while maintaining the dimensions of the natural streambed. Armoring of the approaches will provide a suitable running surface, protect the stream banks and floodplain, keep soil from sticking to tracks or tires, and prevent soil from washing off in streams. If the soil type for the approaches is fine-grained, Clean Line may use a woven geotextile fabric between the

subgrade and the gravel surfacing to add strength and separation. A Type 2 drive-through crossing results in an average disturbance profile of approximately 25 feet wide (along the waterbody).

- *Type 3 – Culvert:* Type 3 crossings may be used for more incised stream channels and channels with more consistent flow regimes sufficient to maintain native fishery populations. Clean Line will design and install culverts under the guidance of a qualified engineer who, in consultation with a hydrologist and aquatic biologist, will recommend culvert locations, specifications, and construction techniques, including culvert gradient, height, and sizing. Culvert design will consider drainage basin characteristics, hydrology, bed load, and debris. Culvert slope will not exceed stream gradient. Typically, Clean Line will partially bury culverts in the streambed to maintain streambed material in the culvert. Clean Line will place sandbags or other non-erosive material around the culverts to prevent scour or water flow around the culvert. A stable travel surface will be installed across the culverts by backfilling with clean gravel or rock. Adjacent sediment control structures such as silt fences, check dams, rock armoring, or riprap may be necessary to prevent erosion or sedimentation. Clean Line may stabilize stream banks and approaches with rock or other erosion control devices. The disturbance footprint for culvert installation is estimated to be 30 feet to 60 feet wide (along the waterbody) depending on the channel profile.
- *Type 4 – Channel-Spanning Structures:* Type 4 crossings may be used for higher quality defined perennial stream channels that do not exceed 30 feet in width. Clean Line will use channel-spanning structures to span the channel from bank to bank. The type of structure used will be largely determined by the width of the active channel and will potentially include a submerged arch culvert, low-profile multi-plate arch, or short-span bridge structure. Clean Line will design and install channel-spanning structures under the guidance of a qualified engineer who, in consultation with a hydrologist and aquatic biologist, will recommend structure locations, specifications, and construction techniques, including structure gradient, height, and sizing. Clean Line estimates that the disturbance footprint for channel-spanning structure installation is 30 feet to 60 feet wide.

Broad-Based Dips

Sometimes referred to as water bars, a broad-based dip is a gradual depression in the roadway that is hardened to allow water to cross over the roadway in a controlled manner so that it drains into stable, vegetated areas at the side of the road. Dips are preferred to culverts for cross-drainage of seeps where no defined channels are present. Broad-based dips can serve two functions: 1) to divert surface flow off a traffic surface, and 2) to permit water to drain across a traffic surface. They are best suited for grades of less than 10 percent.

The dip would be approximately 20 feet long. The bottom of the dip would be aligned at a slight angle across the road and out-sloped where the terrain permits to ensure drainage. The bottom of the dip is typically armored with 3-inch diameter (or larger) crushed aggregate applied to a depth of 10 inches over a geotextile separation fabric and topped with crushed gravel.

A broad-based dip results in an average disturbance profile of 25 feet wide. Clean Line would conduct minor excavation to remove material from the dip and replace with geotextile fabric and rock.

Construction on Steep Slopes

Clean Line will site new access roads and transmission structures to avoid steep side slopes, to the extent practicable. Where access to structures along steep slopes is required, special construction techniques are required to ensure the structure foundation and access roads are stable and persist for future access

if needed. If required for access to individual transmission structures, roads will generally be located to traverse ridgelines to avoid extensive cuts, which would otherwise be required for bladed roads traversing steep side slopes. Clean Line will construct transmission structures and new roads on steep side slopes, if required, on an excavated bench rather than on compacted embankment fills. Where Clean Line encounters hard rock, blasting may be required to enable excavation of the bench. Access roads on steep side slopes will be insloped (shed to the inside) and Clean Line will construct them with frequent cross-drainage structures to convey water across the road. Clean Line will typically surface access roads on steep side slopes with crushed rock to minimize erosion. Specialized techniques may be required to stabilize cut slopes, promote vegetative cover, and minimize rill erosion. Embankment fills on side slopes over 25 percent may require benched cut and fill slopes depending on soil characteristics and site-specific geologic conditions. Clean Line will avoid sidecasting of excavated spoils onto slopes greater than 30 percent.

Blasting

Blasting may be used in isolated locations, where required, to break up rock, enabling excavation using traditional techniques. This technique is used most frequently in steep mountainous terrain where roads or structure benches must be excavated in hard rock. Rock is not a homogeneous material; Clean Line must consider fracture planes, seams, and overburden issues. There are four main categories of commercial high explosives: dynamite; slurries; ammonia nitrate and fuel oil; and two-component explosives. Ammonia nitrate and fuel oil is the most common general purpose explosive in use today. Every blast must be designed to meet existing conditions of the rock formation and overburden and to produce the desired result. A trial blast is typically performed in the field to validate theoretical blast designs or to provide additional information for final blast designs. There are federal and state regulations concerning the transportation and handling of explosives. All safeguards associated with using explosives (e.g., blasting mats) would be implemented. Alternatively, Clean Line may install special rock anchors.

3.4 Construction of AC Interconnections and Related Upgrades

The AC interconnections and related upgrades would involve construction of transmission lines and upgrades to existing equipment to facilitate injection of additional power transmitted by the Project.

Section 2.1, “Converter Stations and Other Terminal Facilities,” describes the transmission lines between each converter station and their respective interconnection point. Section 3.2, “HVDC and AC Transmission Line Construction,” describes construction of AC transmission lines; all construction methods described for AC transmission lines are the same as those expected for AC interconnection lines.

Construction of upgrades are anticipated as follows:

- Based on the analysis completed to date, Clean Line expects that a new substation would be necessary to accommodate the interconnection due to space constraints at the existing Hitchland 345 kV substation. To alleviate these space constraints, SPS has proposed a new substation nearby, tentatively named “Optima.” This new substation would be located within a few miles of the Oklahoma Converter Station in Texas County, OK.
- Based on TVA’s final Interconnection System Impact Study (ISIS), TVA would need to make substation or transmission upgrades to accommodate interconnection of the proposed Project to the transmission system in Tennessee. The final ISIS, completed in March 2014, identified direct assignment facilities and network upgrades required for the Project. Direct assignment facilities included additional bays, breakers, switches, line relays, and interchange meters to install within the Shelby substation to facilitate the physical interconnection of the Project. Network upgrades include upratings,

reconductoring, and terminal upgrades on 27 existing 161 kV system elements and 3 existing 500 kV system elements, which are necessary to operate the project at its full output under various system conditions (line faults, generator trips, etc.).

The ISIS also identified certain reliability scenarios that would be resolved by a new Lagoon Creek-Jackson 500 kV transmission line and associated substation upgrades. Following Good Utility Practice, in accordance with a final Interconnection Agreement, and depending on the results of the Facilities Study, Clean Line may be asked to operate the Project in a way that restricts its full delivery capacity under some limited scenarios until completion of network upgrade projects.

- Clean Line selected the Arkansas Nuclear One –Pleasant Hill 500 kV POI because it can accommodate a 500 MW injection without additional upgrades to the surrounding transmission system. MISO performed a feasibility study of the request and concluded in February 2014 that no network upgrades were required to accommodate the interconnection. In Arkansas, the construction of the interconnection point along the existing Arkansas Nuclear One-Pleasant Hill 500kV AC transmission line would require a new substation. The interconnection facilities will be located within this substation of up to 25 to 35 acres in size based on an air-insulated facility; this area will be fenced and retained during operation of the Project.

3.5 Hazardous Materials Handling and Disposal

Construction will involve the transport of limited quantities of hazardous materials to the Project site and will pose minor hazards associated with their use. Small oil spills may occur during onsite refueling of equipment. If a fuel spill occurs on soil, Clean Line will place the contaminated soil into barrels or trucks for offsite disposal as a hazardous waste. In addition, Clean Line will perform equipment refueling away from water bodies to prevent contamination of water in the event of a fuel spill. The worst-case scenario for a chemical release from fueling operations would be an accident involving a service or refueling truck.

The quantities of hazardous materials that Clean Line will handle during construction are relatively small and Clean Line will implement applicable construction practices.

The health and safety program will comply with all federal, state, and local health standards that pertain to worker health and safety. Clean Line will handle and dispose of all hazardous materials according to applicable regulations. Clean Line will develop pollution prevention control measures during preliminary and final engineering design. Clean Line will remediate accidental leakage of fuel or lubricants from construction, operation, and maintenance equipment in accordance with applicable regulatory standards. Environmental protection measures associated with hazardous materials and spills are discussed in Appendix B, "Environmental Protection Measures."

3.6 Gravel Sources

Crushed stone and gravel resources used for concrete and road construction are widely distributed across the Project area and Clean Line will obtain these resources from commercial suppliers. Crushed stone and gravel resources include limestone, dolomite, granite, and rhyolite and extensive sand and gravel deposits along existing and historic river courses. Due to the high cost of transportation, mineral aggregate (e.g., sand, rock and gravel) would typically be procured from local producers. These producers may distribute bulk aggregate or construction contractors may elect to utilize their own trucking resources. Contractors may solicit bids from local and/or regional producers to support the project and would consider availability, quality, cost, and distribution capabilities in their selection. Clean Line identified 135

commercial sand and gravel producers in Oklahoma, 51 in Arkansas, and at least 150 in Tennessee (USGS 2014).

4.0 Operations and Maintenance

This section describes the activities performed to operate and maintain the Project. The maintenance activities will consist of a Transmission Line Maintenance Program, a Vegetation Management Plan, and a ROW Management Program.

4.1 Operational Characteristics

The nominal voltage of the DC line will be ± 600 kV DC. There may be minor variations of the nominal level depending on load flow. The nominal voltage of the AC facilities will be 345 kV or 500 kV as described previously. There may be minor variations of the nominal level depending on load flow and operating conditions. The typical ROW for both AC and DC lines will be 150 to 200 feet in width. The final ROW width will be determined during engineering design.

4.2 Permitted Uses within the Right-of-Way

Land uses compatible with reliability and safety requirements for HVDC and AC facilities will be permitted in and adjacent to the ROW. Existing land uses such as agriculture and grazing, vehicle and pedestrian access, recreational use, and pre-existing compatible uses are generally permitted. Incompatible land uses within the ROW include construction and maintenance of inhabited dwellings, and any use requiring changes in surface elevation that affect electrical clearances of existing or planned facilities.

Good Utility Practice, NERC rules, and the planned design, maintenance, and operation of the line govern height restrictions of activities within the right-of-way in order to maintain minimum clearance requirements as determined from the NESC. Once a route is established, Clean Line will review the route for non-standard activities that may require adjustments to minimum clearances.

After the transmission line has been energized, agricultural and non-agricultural land uses that are compatible with reliability and safety requirements will be permitted in the ROW, subject to limitations. Limitations on land uses will be described in the easement agreements; these limitations may be modified based on site-specific conditions and coordination with landowners. For example, limitations on uses within the ROW could include the following:

- A prohibition on placing a building or structure within the ROW.
- Restrictions on timber or the height of orchard trees within the ROW.
- Restrictions on grading and land re-contouring within the ROW that would change the ground surface elevation within the ROW such that required electrical clearances are no longer maintained.
- Restrictions and/or required coordination for the construction of future facilities such as fences and/or irrigation lines within the ROW.
- Restricted access for safety considerations where maintenance activities are being performed.

Clean Line anticipates that any restrictions on land use within the ROW would be determined based on site-specific conditions and/or in coordination with landowners. These are not blanket limitations or restrictions that would apply to every parcel associated with the Project. For example, Clean Line recognizes that agricultural areas are graded, contoured, and ditched as part of routine agricultural practices. These types of routine practices are compatible with the reliability of the HVDC and AC facilities and would not be restricted. Similarly, Clean Line has no intent to displace or prohibit livestock grazing in

pastures overlapped by the ROW during construction, operation or maintenance, unless otherwise desired by the landowner. Clean Line anticipates that livestock would continue grazing during construction, operation, and maintenance.

To illustrate the typical activities, restrictions, and temporal nature of construction, Clean Line has developed the *Example of Typical Construction Activities on Agricultural Property* (Appendix C), which describes a typical construction sequence that could occur on a single parcel.

Clean Line anticipates that construction EPMs would be implemented and carried forward into operations and maintenance phases. For example, Clean Line will work with landowners to develop compensation for lost crop value caused by operations and maintenance activities (AG-6). To avoid the potential of operations and maintenance activities resulting in loss of or injuries to livestock, Clean Line will continue to coordinate with landowners regarding access controls (e.g., cattle guards, fences, gates) (GE-8).

4.3 Transmission Line Maintenance Program

Clean Line will establish a Transmission Line Maintenance (TLM) program to maintain physical facilities. Through this program, Clean Line will identify, prioritize, and schedule maintenance activities for resolution depending on their potential severity. This section describes the categories and types of maintenance activities, potential staffing, and general safety practices. Maintenance activities can be classified into preventative and corrective activities. Preventative activities are more regular and scheduled in nature. Corrective activities are those that are discovered following an inspection or caused by a discrete event.

The TLM Program would include Program Level Guidelines (PLGs) to address the goals, activities, frequency and duration, and required resources for all maintenance activities. For example, Clean Line PLGs would include, but may not be limited to, the following:

- All transmission structures will be inspected from the ground every 24 months.
- All transmission lattice structures will be climbed and inspected every 10 years (climbing inspection).
- All transmission structures and spans will be patrolled by helicopter every 6 months (aerial inspection).

Corrective Activities

Depending on the severity of the issue, corrective activities would be either immediate or scheduled. Activities considered immediate are those that require a response in the case of an event, or imminent threat of an event, that could result in a sustained outage. Immediate corrective maintenance activities tend to be intermittent and random in nature. Scheduled corrective activities can be delayed, reprioritized and scheduled without risking damage or outages. Scheduled corrective activities tend to be planned and scheduled and/or performed after the event is found.

To minimize the frequency and duration of corrective activities, Clean Line has designed robust structures that incorporate the appropriate National Electric Safety Code requirements. The Project's design criteria contemplate a loading scenario, on a structure without wires, of wind speeds equivalent to an F-2/EF3 tornado. While these loading scenarios don't eliminate the potential for damage to the line, they do decrease the likelihood of structure damage or a major outage. Current engineering plans call for stop-structures every 5-10 miles to prevent cascading events.

Clean Line plans to utilize weather monitoring systems currently in place in the project area to track tornadic activity, and to communicate elevated risk levels to interconnecting utilities in order to ensure operational readiness.

A spare parts inventory would be put in place along the route to address both high and low probability weather events. Standby contracts for labor and emergency equipment would provide for quick responses to any outages.

Preventative Activities

Typical preventative maintenance activities anticipated would include various levels of physical inspections of the facility within specific periods. For example, the type of inspections for the HVDC transmission line would likely include:

- Aerial inspection of the line as specified in the PLG's typically on a 6 month rolling schedule. The aerial inspections would typically require a helicopter with a pilot and an observer to perform and record the aerial inspection. This activity might be pursued on a six month PLG and could involve the use of cameras, both visual and thermo vision, to detect hot spots. This activity could increase noise but has essentially no impact on agricultural activities.
- Ground based working patrols with each structure visited and visually inspected including the span ahead and back of each structure typically every 24 months. The ground based working patrols would require a line truck with typically two line hands to perform the inspection at each structure once a year. This activity would have low impact for land issues. In agricultural lands the inspections could be either staged to not conflict with crops during the off season or alternately performed from a modest distance to avoid driving on cultivated land. The activity is essentially limited to driving or walking to the site and performing a visual inspection.
- Climbing inspections of perhaps 10% of the lattice structures to identify loose or bent members, missing bolts, etc. annually. This specific PLG would have all the lattice structures with a climbing inspection performed on a ten year rolling schedule. The climbing inspections would typically require two line trucks or a larger line truck that carries four passengers. The actual climbing inspection would involve either one or two climbers and ground support for each climber requiring about four line hands. This activity would also have low impact for land issues. In agricultural lands, or in other areas of sensitive habitats or land uses, the inspection could be staged during times when there would be minimal impact. Tubular steel structures would likely be excluded from climbing inspections.

Staffing

Clean Line's TLM resources would likely consist of one of the following personnel mixes:

- Entirely maintained in-house as utility employees;
- Base TLM crews augmented with contract support line-hands; or,
- Entirely contracted to qualified providers.

Standards and Work Practices (SWPs)

The TLM Program may include the supported and expected TLM Standards and Work Practices (SWPs) for safely and efficiently accomplishing the PLGs. Essentially the PLGs specify what shall be done, how often it shall be done, and resources to accomplish the goals of the TLM Program. The SWP specifies the standards by which the work shall be accomplished and accepted work practices to safely perform the work. Examples of SWP specifics might include, but may not be limited to the following:

- TLM maintenance practices will support the use of helicopter platforms for maintenance activities.
- Minimum approach distances are specified in the TLM standards and shall be honored at all times when working in the vicinity of conductors or shield wires regardless of whether energized or de-energized.

- All de-energized maintenance work shall commence only after a clearance hold from Operations is secured by the Foreman I and all grounds have been installed and inspected and declared safe before work may commence.

4.4 Vegetation Management Program

Pursuant to the NERC Reliability Standard FAC-003-2, Clean Line is required to create and implement a documented vegetation management strategy for the Project's permanent ROW to prevent vegetation-caused outages on the transmission system. Clean Line will develop a Vegetation Management Program (Vegetation Program) that will provide the framework for implementing treatments prescribed by the Project's Transmission Vegetation Management Plan (TVMP). The Vegetation Program will recommend broad vegetation management objectives and identify appropriate vegetation management actions for implementing the TVMP. The TVMP will define site-specific standards, measurable metrics and management objectives; and prescribe controls or treatment options to achieve defined objectives and support the Vegetation Program's goals.

The Vegetation Program and TVMP will comply with federal, state, and local regulations and standards for reliability and ROW vegetation clearing and maintenance, including NERC Reliability Standard FAC-003-2. The Vegetation Program and TVMP will also comply with relevant regulations applicable to all lands, including but not limited to the Clean Water Act (CWA) Sections 303(d) and 404 and the Endangered Species Act (ESA) of 1973, as amended in Section 7(a)(2). Vegetation management treatment types, methods, and activities will be developed in accord with applicable stipulations and protection measures identified in other Project Plans and decision documents, including but not limited to the following documents:

- Right-of-Way Easement agreements
- Applicant-proposed Environmental Protection Measures
- Agency-proposed Best Management Practices
- Clean Line's Avian Program and related Avian Protection Plan
- Biological Opinion
- Restoration Plan
- Storm Water Pollution Prevention Plan
- Agriculture Impact Mitigation Policy

Clean Line will develop a Vegetation Program and TVMP using principles of Integrated Vegetation Management (IVM) following the guidelines presented in the American National Standards for Tree Care Operations - *Tree, Shrub, and Other Woody Plant Management - Standard Practices* (Integrated Vegetation Management a. Utility Rights-of-Way) (ANSI A300, Part 7) and *Best Management Practices* (Second Edition; 2014) and subsequent versions or similar future guidance documents, as appropriate. Integrated Vegetation Management is an established system for promoting and managing sustainable plant communities within transmission line ROWs that are compatible with safe, reliable operations and maintenance of the Project. The TVMP will adopt key IVM principles in order to encourage desirable vegetative communities that reduce the risk that incompatible vegetation poses for utility service reliability, accessibility of the ROW and facilities, and other security or safety risks.

As defined in *ANSI A300 Part 7*, key steps of IVM include:

- Gaining a science-based understanding of incompatible vegetation and ecosystem dynamics within and near the ROW;

- Setting specific, measurable management objectives and tolerance thresholds based on site-specific conditions, regulatory requirements, landowner's or tenant's input, and other factors;
- Selecting treatments from a variety of options and applying them responsibly to promote sustainable, desirable plant communities; and
- Monitoring treatments to determine their efficacy in creating desired plant communities and achieving management objectives over time.

An important benefit of creating a Vegetation Program and TVMP based on IVM principles is the opportunity for continuous improvement. Routine monitoring and adaptive management are fundamental to IVM and require diligent monitoring of treatments and inherently dynamic ecological conditions. Over time, this information is used to inform and refine future vegetation management decisions that are, in turn, monitored for efficacy and efficiency. This system of feedback encourages selection of the most effective treatment types that balance socioeconomic and environmental considerations. Integrated Vegetation Management allows for an array of different treatment options to achieve desired management objectives and, while emphasizing biological controls, also encourages other treatment types, such as manual, mechanical, cultural, and chemical.

While IVM is an established management method, it "is not a set of rigid prescriptions based upon set time periods, repeated unselective mowing, or broadcast [herbicide] spraying across entire rights-of-way widths without the objective of establishing diverse, compatible plant communities" (ANSI A300 part 7: IVM BMPs; Second Edition, 2014). Herbicide application is a valuable tool in IVM that, when implemented properly and in a targeted manner, reduces the need for future intervention, minimizes soil disturbance, and can selectively and efficiently target undesirable plant species and encourage growth of desirable vegetative communities. Selective herbicide use, for example, can be applied manually to prevent the stumps of undesirable woody species from re-sprouting and growing in high densities that become increasingly more hazardous to the transmission system, often provide poor habitat value, and are more difficult to manage over time. As with all potential control options consistent with IVM, Clean Line will evaluate herbicidal treatment options in consideration of site-specific ecological conditions, surrounding and underlying land uses, and any environmental sensitivities before selecting and applying a control.

The TVMP will apply to the ROW, temporary work areas, access roads, and other facilities associated with the Project during pre-construction clearing activities, construction, site restoration, and Operations and Maintenance. Any project-related ground disturbing activities outside these areas require prior approval by the appropriate landowners and/or agencies. Clean Line will develop the Vegetation Program based on the preferred alternative identified in the Final Environmental Impact Statement and Clean Line's preliminary design and engineering.

Clean Line retains the primary responsibility of directing and monitoring vegetation management activities for the Project. Clean Line and/or its construction contractor may choose to utilize a contractor that specializes in vegetation management to implement the protocols identified in the TVMP or Vegetation Program during and following construction, including site restoration. During Operations and Maintenance, Clean Line Operations and Maintenance staff will work with a professional consulting forester to set management objectives, evaluate the ROW and Project areas to assess field conditions, define action thresholds, and evaluate and select control methods or treatment options. Clean Line will then work with a certified professional arborist to implement the treatment options or control methods to achieve the established management objectives. Typically, the resources required to accomplish the specifics of the Vegetation Program are based on the TVMP and tend to be a mix of in-house resources and contract resources.

Vegetation Specialists typically rely on helicopter inspection reports, TLM working patrol reports, and contract field inspectors to identify vegetation which requires removal or trimming based on the standards

and metrics of the TVMP. These identified vegetation issues are aggregated into contract or statement of work (SOW) instruments to provide specifics to a vegetation management contract crew qualified to work in the vicinity of OH electrical facilities. The vegetation management contractor accomplishes the vegetation removal or trimming to the satisfaction of the Vegetation Specialist based on the SOW.

The Vegetation Management Program also carries PLGs and SWPs for danger tree (vegetation) identification, marking, and removal which is contained within the TVMP.

4.5 Right of Way Management Program

The Right of Way Management Program will manage the ROW to identify any encroachments on the ROW which either threaten the safe and reliable operation of the HVDC and AC transmission lines or are not compliant with any ROW easement limitations. When encroachments are identified, Clean Line will resolve them with the landowner or tenant to bring the ROW back into a state where land use activities are compatible with the overhead transmission lines.

Clean Line ROW Specialists would review helicopter inspection reports, TLM working patrol reports, and contract field inspectors as appropriate to identify activities encroaching on the ROW. Once identified, the ROW Specialist would inform and work with the landowner or tenant to resolve the encroachment issues. Examples of encroachments that occur after the transmission line is in place might include, for example:

- Non-permitted communication or electrical facilities in the ROW.
- Non-permitted pipelines crossing the ROW.
- Structures such as buildings, swimming pools, or grain elevators, that are not compliant with the ROW easement.
- Earth grading that significantly altered the ground elevation for agricultural or road construction activities such that required electrical clearances are no longer maintained.

4.6 Safety and Reliability

Clean Line's primary concern is the safe and reliable operation of the transmission facilities. The Project will be designed to meet or exceed applicable criteria and requirements outlined by organizations such as the Federal Energy Regulatory Commission, the North American Electric Reliability Corporation, NESC, SPP, TVA, the American Society of Civil Engineers, and other applicable federal, state, or local requirements. Safety measures will meet or exceed applicable occupational safety and health standards. The transmission line will be protected with circuit interruption equipment (circuit breakers, disconnects, etc.). If conductor failure occurs, the line will be automatically de-energized. Lightning protection will be provided by overhead ground wires. Electrical equipment and fencing at the converter stations and substations will be grounded. Vegetation management will occur to minimize potential hazards; trees will be trimmed or removed to prevent accidental grounding contact.

Clean Line will turn over functional control of the Project to a Regional Transmission Organization (RTO)/Independent System Operator (ISO) or an RTO-like entity. For the Project, this could include SPP, TVA, or a third party. Functional control of a facility means that the RTO ensures compliance with reliability standards for issues such as maintenance outages and the like. Coordination agreements – also known as “seams agreements” – will be negotiated and executed with all interconnection parties. Balancing area functions will be performed by Clean Line or a third party acting as the Transmission Operator on behalf of Clean Line. Clean Line will be subject to all national (NERC) and regional (SPP, MISO, and TVA) reliability standards and compliance.

5.0 Decommissioning

Decommissioning could occur at the end of the useful life and if the facility were no longer required. However, a transmission system lifetime can exceed 80 years with proper maintenance. If, at the end of the service life of the Project, and assuming that the facilities are not upgraded or otherwise kept in service, conductors, insulators, and structures could be dismantled and removed. The converter stations and regeneration stations, if not needed for other existing transmission line projects, could also be dismantled and removed. The station structures would be disassembled and either used at another station or sold for scrap. Access roads that have a sole purpose of providing maintenance crews access to the transmission lines could be decommissioned following removal of the structures and lines, or could be decommissioned with the lines in service if determined to no longer be necessary. Clean Line will consult with landowners to assess whether access roads may be serving a larger purpose for landowners, at which point in time, Clean Line may elect to leave the access roads in place. A Decommissioning Plan would be developed prior to decommissioning, but due to the uncertainty of future technology and unknown future environmental requirements, any document would follow appropriate governing requirements at that time.

6.0 References

American National Standards for Tree Care Operations (ANSI) *Tree, Shrub, and Other Woody Plant Management - Standard Practices (Integrated Vegetation Management a. Utility Rights-of-Way) (ANSI A300, Part 7) and Best Management Practices (Second Edition; 2014)*

National Electrical Safety Code (NESC). 2012. Rule 232D; Edition 2012.

U.S. Geological Survey (USGS). 2014. Directory of State Listings of Crushed Stone and Sand and Gravel Producers. http://minerals.usgs.gov/minerals/pubs/commodity/stone_crushed/statedir03.pdf . Accessed April 2014.

Appendix A

Figures

This page intentionally left blank.

List of Figures

Figure

- 1-1 Project Overview
 - 2-1 Clean Line Converter Station General Layout
 - 2-2a Oklahoma Converter Station Siting Area Property Location
 - 2-2b Oklahoma Converter Station Siting Area Property Aerial
 - 2-3a Tennessee Converter Station Siting Area Property Location
 - 2-3b Tennessee Converter Station Siting Area Property Aerial
 - 2-4 Arkansas Converter Station Alternative Siting Area
 - 2-5 HVDC Alternatives
 - 2-6 AC Alternatives
 - 2-7 DC R.O.W. Limits
 - 2-8a 600kV Lattice Deadend
 - 2-8b 600kV Lattice Running Angle
 - 2-8c 600kV Lattice Tangent
 - 2-9 600kV DC Lattice Work Area
 - 2-10 600kV DC Lattice Foundation and Structure Construction Activities – Plan View
 - 2-11a 600kV Monopole Deadend
 - 2-11b 600kV Monopole Running Angle
 - 2-11c 600kV Monopole Tangent
 - 2-12 600kV DC Monopole Work Area
 - 2-13 600kV DC Monopole Foundation and Structure Construction Activities – Plan View
 - 2-14a 600kV Guyed Mast Tubular Tangent
 - 2-14b 600kV Guyed V-Tube Tangent
 - 2-14c 600kV Guyed Monopole Tangent
 - 2-14d 600kV Guyed Chainette Tangent
 - 2-14e 600kV Guyed Mast Lattice Tangent
 - 2-14f 600kV Guyed V-Lattice Tangent
 - 2-15 600kV Lattice Crossing Structure
 - 2-16 Conductor and Ground-Wire Stringing Activities
 - 2-17 Regeneration Station Plan
 - 2-18 Multi-Use Construction Yard
 - 2-19 AC R.O.W. Limits
 - 2-20a 345kV Lattice Deadend
 - 2-20b 345kV Lattice V-String
 - 2-21a 500kV Lattice Deadend
 - 2-21b 500kV Lattice V-String
 - 2-22 345kV Lattice Work Area
 - 2-23 345kV Lattice Foundation and Structure Construction Activities – Plan View
 - 2-24a 345kV 3-Pole Guyed Deadend
-

- 2-24b 345kV 3-Pole Deadend
 - 2-24c 345kV 3-Pole Guyed Running Angle
 - 2-24d 345kV 3-Pole Running Angle
 - 2-24e 345kV Double Circuit Pole Deadend
 - 2-24f 345kV Double Circuit Pole V-String
 - 2-24g 345kV Single Circuit Guyed Pole DE
 - 2-24h 345kV Single Circuit Pole Deadend
 - 2-24i 345kV Pole Braced Post
 - 2-24j 345kV Single Circuit Pole V-String
 - 2-25a 500kV 3-Pole Guyed Deadend
 - 2-25b 500kV 3-Pole Deadend
 - 2-25c 500kV 3-Pole Guyed Running Angle
 - 2-25d 500kV 3-Pole Running Angle
 - 2-25e 500kV Double Circuit Pole Deadend
 - 2-25f 500kV Double Circuit Pole V-String
 - 2-25g 500kV Single Circuit Guyed Pole DE
 - 2-25h 500kV Single Circuit Pole Deadend
 - 2-25i 500kV Pole Braced Post
 - 2-25j 500kV Single Circuit Pole V-String
 - 2-26 345kV Monopole Work Area
 - 2-27a 345kV Braced H-Frame
 - 2-27b 345kV H-Frame Tangent
 - 2-27c 345kV H-Frame V-String
 - 2-28 Typical Access Roads
 - 2-29 HVDC Transmission Line Construction Sequence
-

PLAINS & EASTERN CLEAN LINE

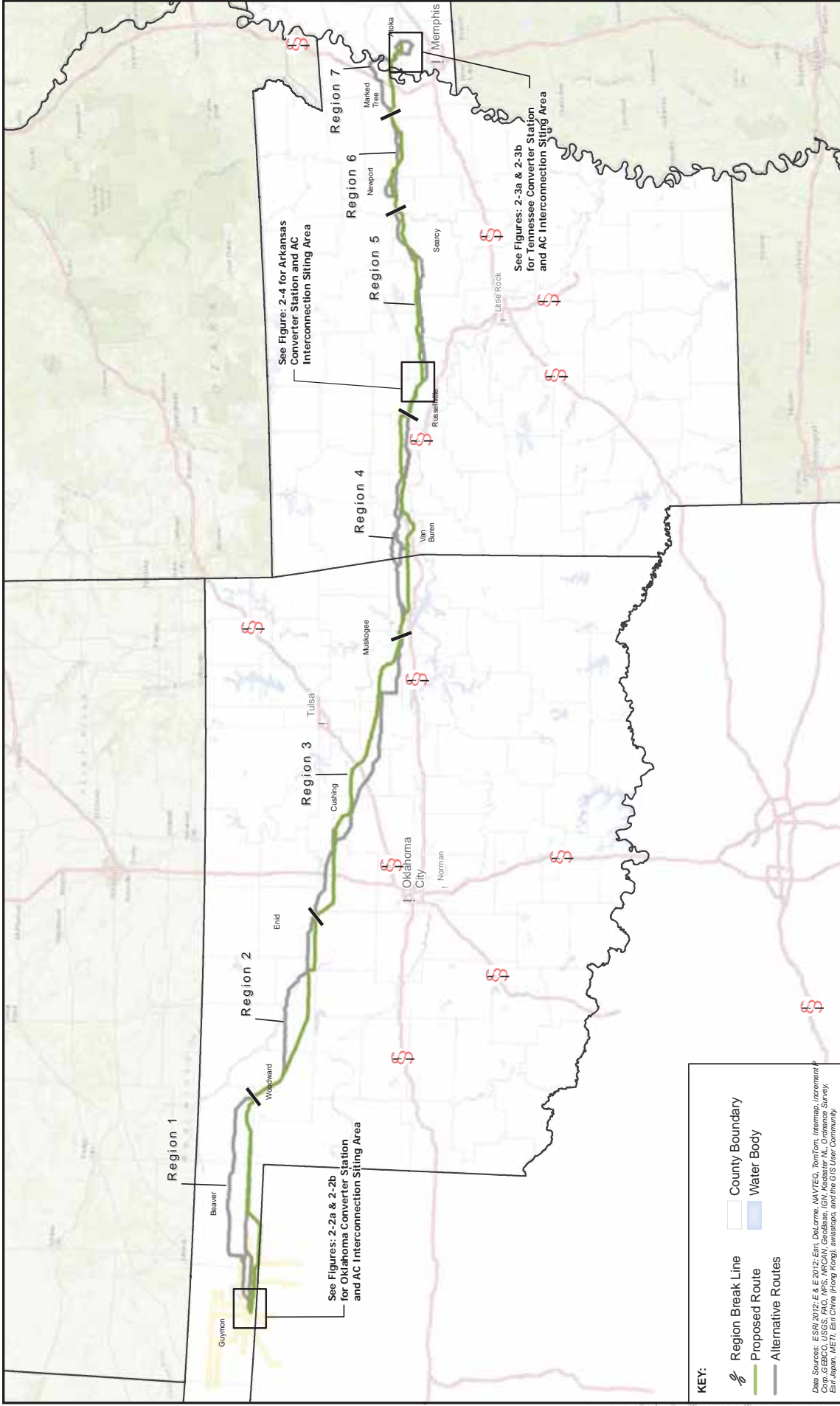

Figure 1-1
Project Overview
 Plains & Eastern Clean Line
 Texas, Oklahoma, Arkansas and Tennessee



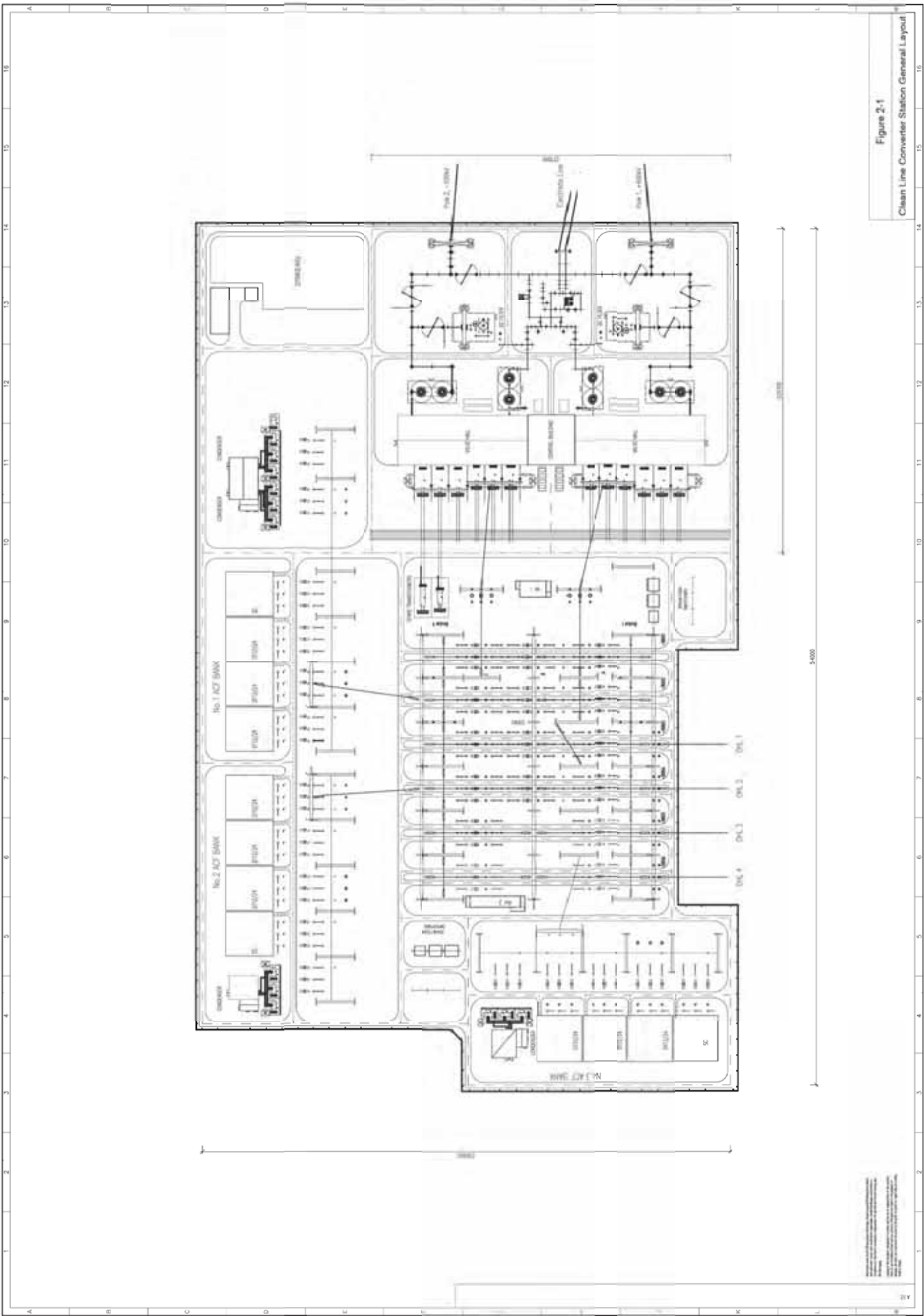
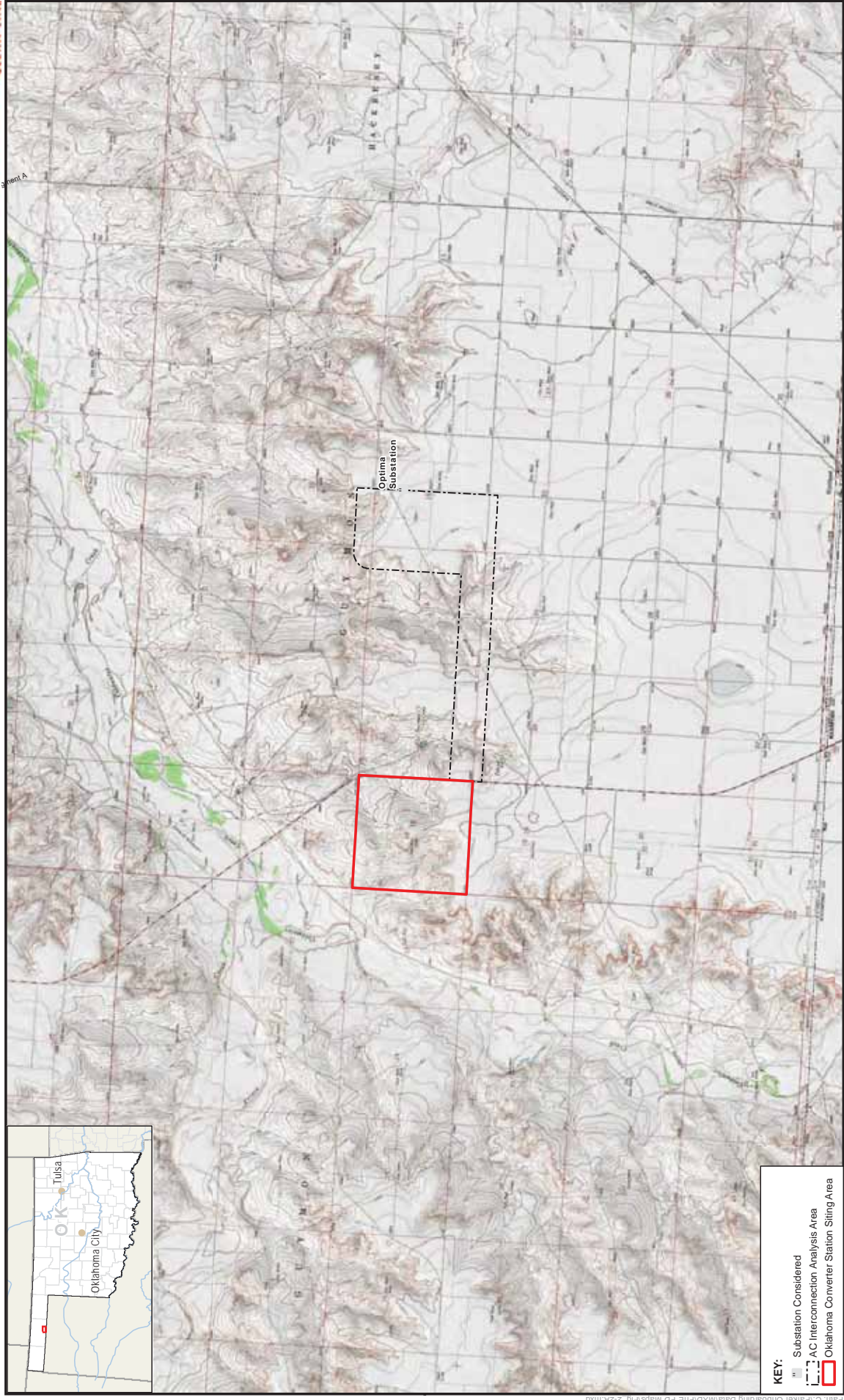
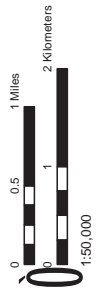

Figure 2-1
Clean Line Converter Station General Layout

PLAINS & EASTERN CLEAN LINE



KEY:
Substation Considered
AC Interconnection Analysis Area
Oklahoma Converter Station Siting Area



Service Layer Credits Copyright © 2013 National Geographic Society

Figure 2-2a
Oklahoma Converter Station Siting Area
Plains & Eastern Clean Line
Texas County, Oklahoma



Data Sources: ESRI 2012; E & E 2012; NAD 2013.

0 0.5 1 Miles
0 0.5 1 Kilometers
1:24,000

Figure 2-2b
Oklahoma Converter Station Siting Area Aerial
Plains & Eastern Clean Line
Texas County, Oklahoma

**PLAINS & EASTERN
CLEAN LINE**

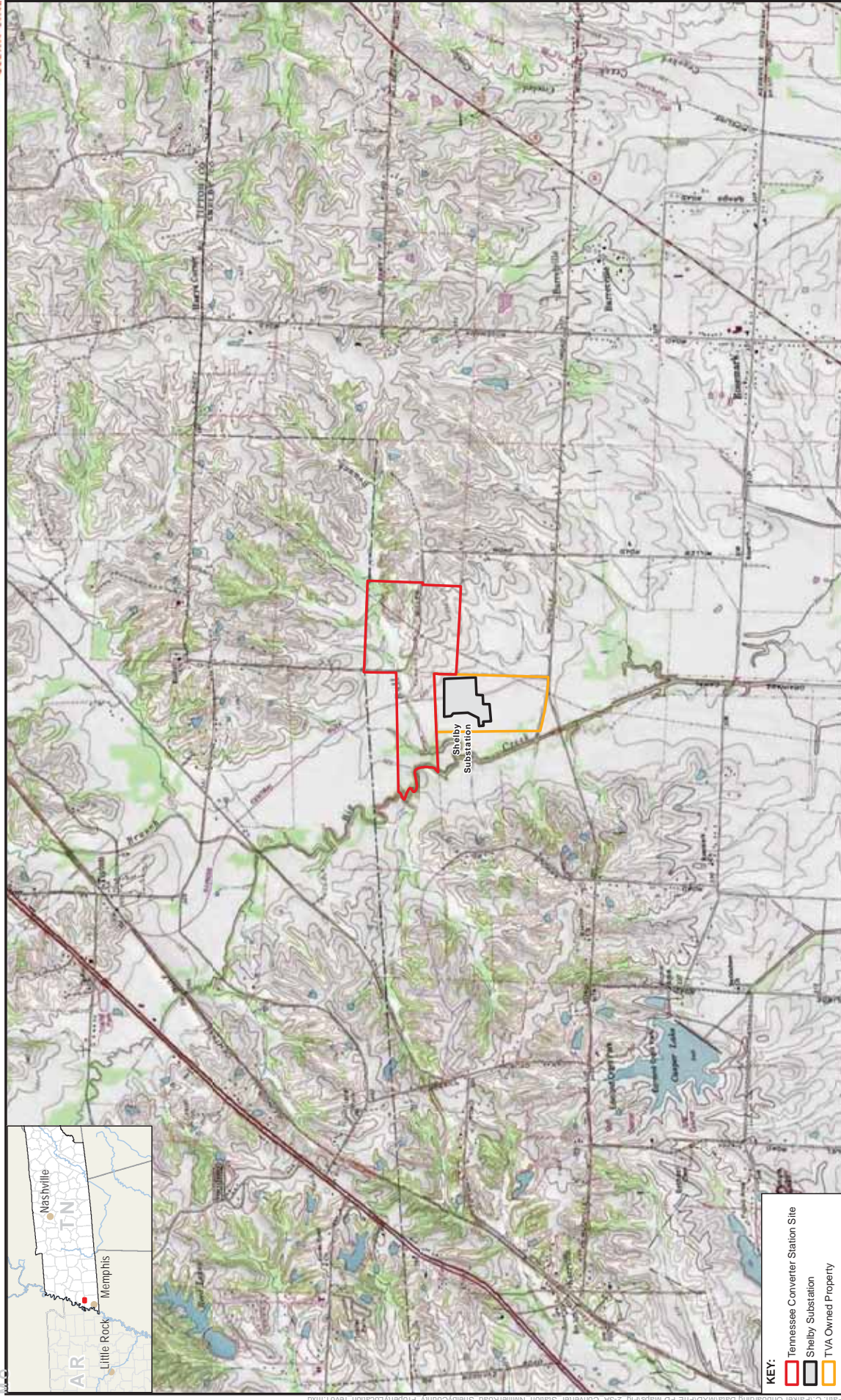

KEY:
 Tennessee Converter Station Site
 Shelby Substation
 TVA Owned Property



Service Layer Credits: Copyright © 2013 National Geographic Society

Figure 2-3a
Tennessee Converter Station Site
Plains & Eastern Clean Line
 Shelby and Tipton County, Tennessee

PLAINS & EASTERN
CLEAN LINE



Date Sources: Clean Line Energy 2015; NMAP 2014.

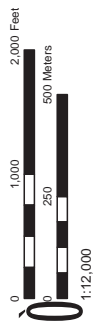

- KEY:**
- Tennessee Converter Station Site
 - Shelby Substation
 - TVA Owned Property

0 1,000 2,000 Feet

0 250 500 Meters

1:12,000

Figure 2-3b
Tennessee Converter Station Site Aerial
Plains & Eastern Clean Line
Shelby and Tipton County, Tennessee

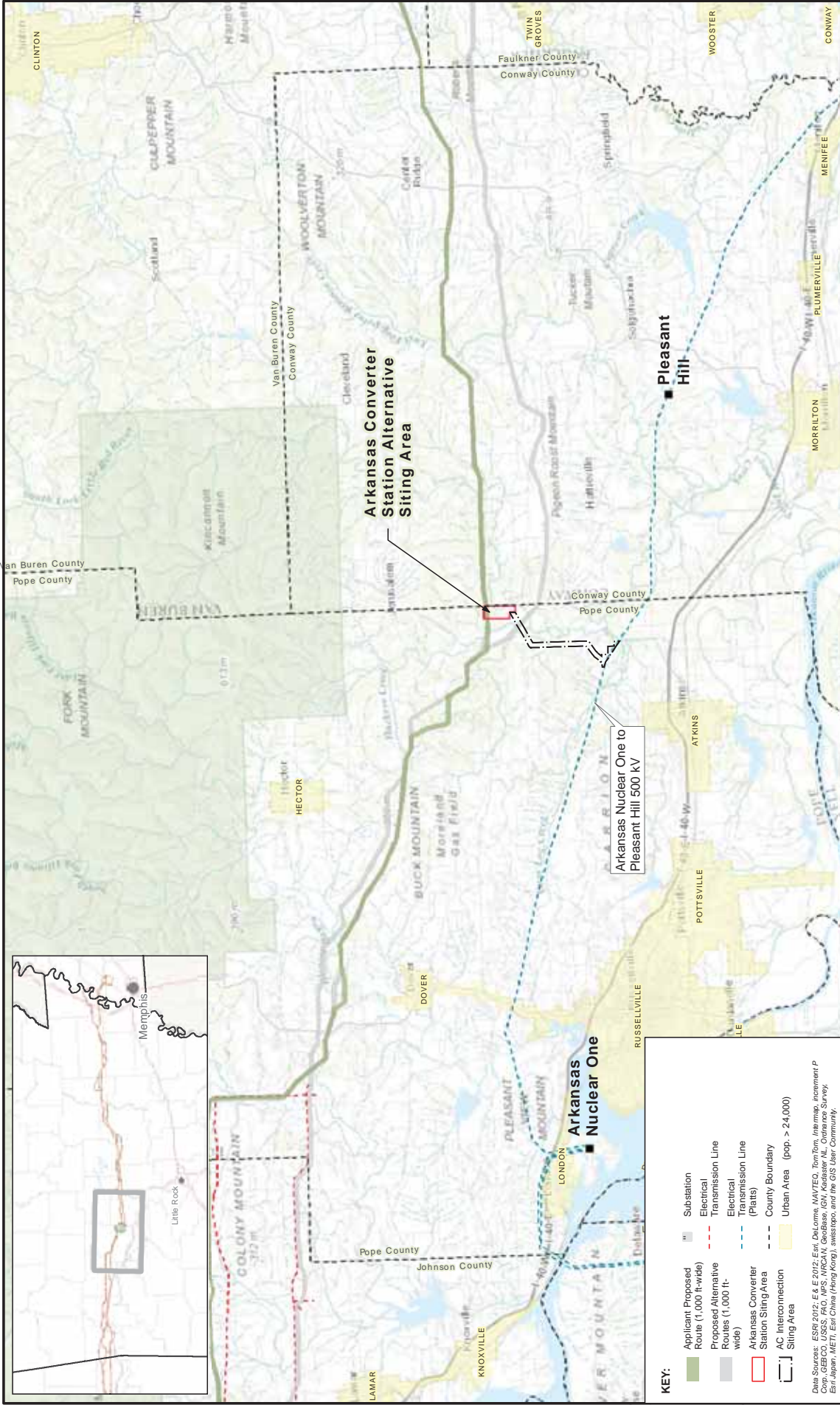
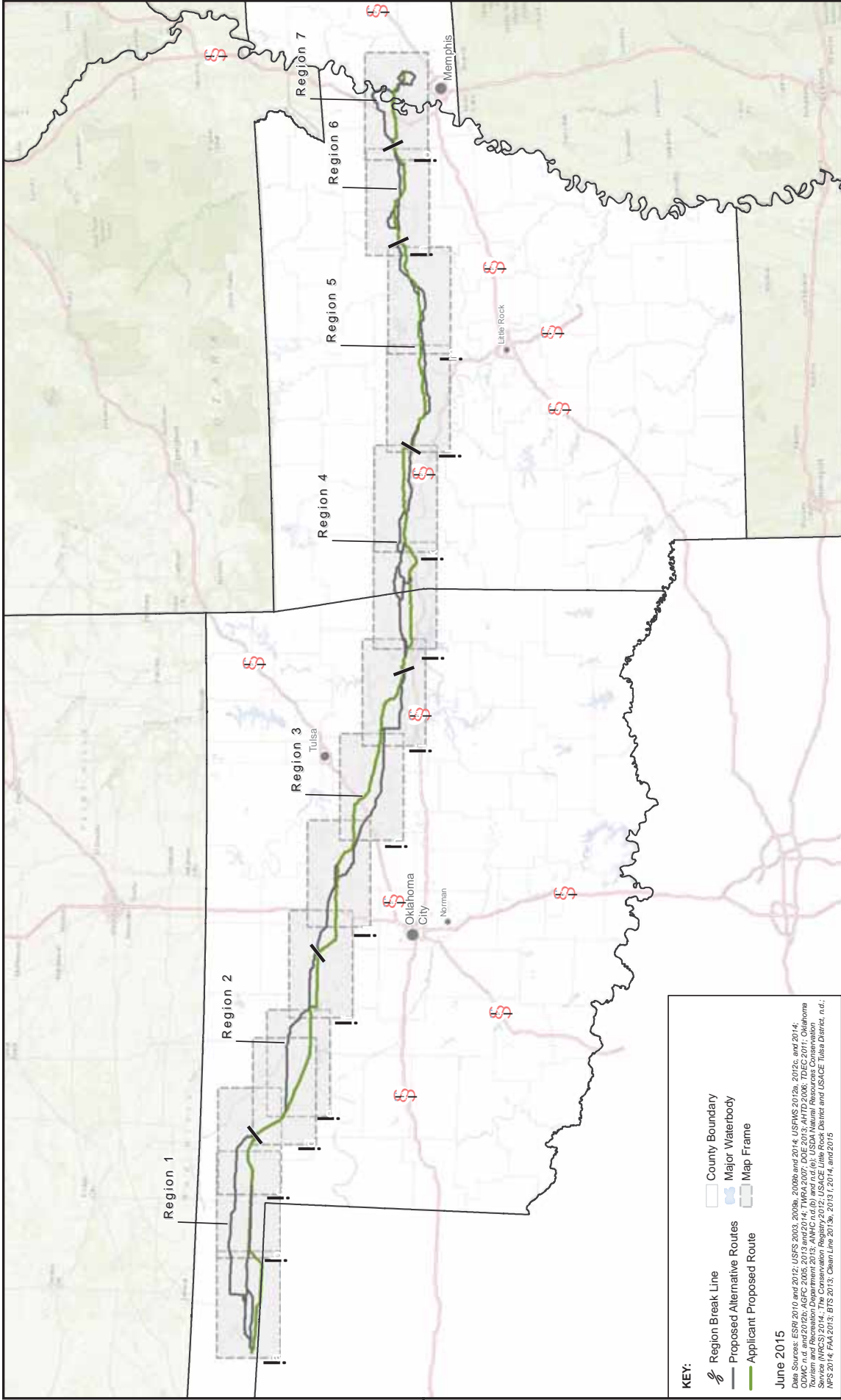

Figure 2-4
Arkansas Converter Station Alternative Siting Area
Plains & Eastern Clean Line
Pope County, Arkansas



PLAINS & EASTERN CLEAN LINE



These Maps and Figures were prepared for the Department of Energy pursuant to 10 CFR 102.215(b)(2) to assist in the Applicant's Proposed Route and Alternatives Routes under the Project. The routes and information included in these Maps and Figures are preliminary and may be subject to revision based on new and/or additional information and input from DOE and/or others. No confidential data is depicted.

Figure 2-5
**HVDC Alternatives: Map Index
 Plains & Eastern Clean Line**
 Oklahoma, Arkansas and Tennessee

PLAINS & EASTERN CLEAN LINE

Map 1 of 15

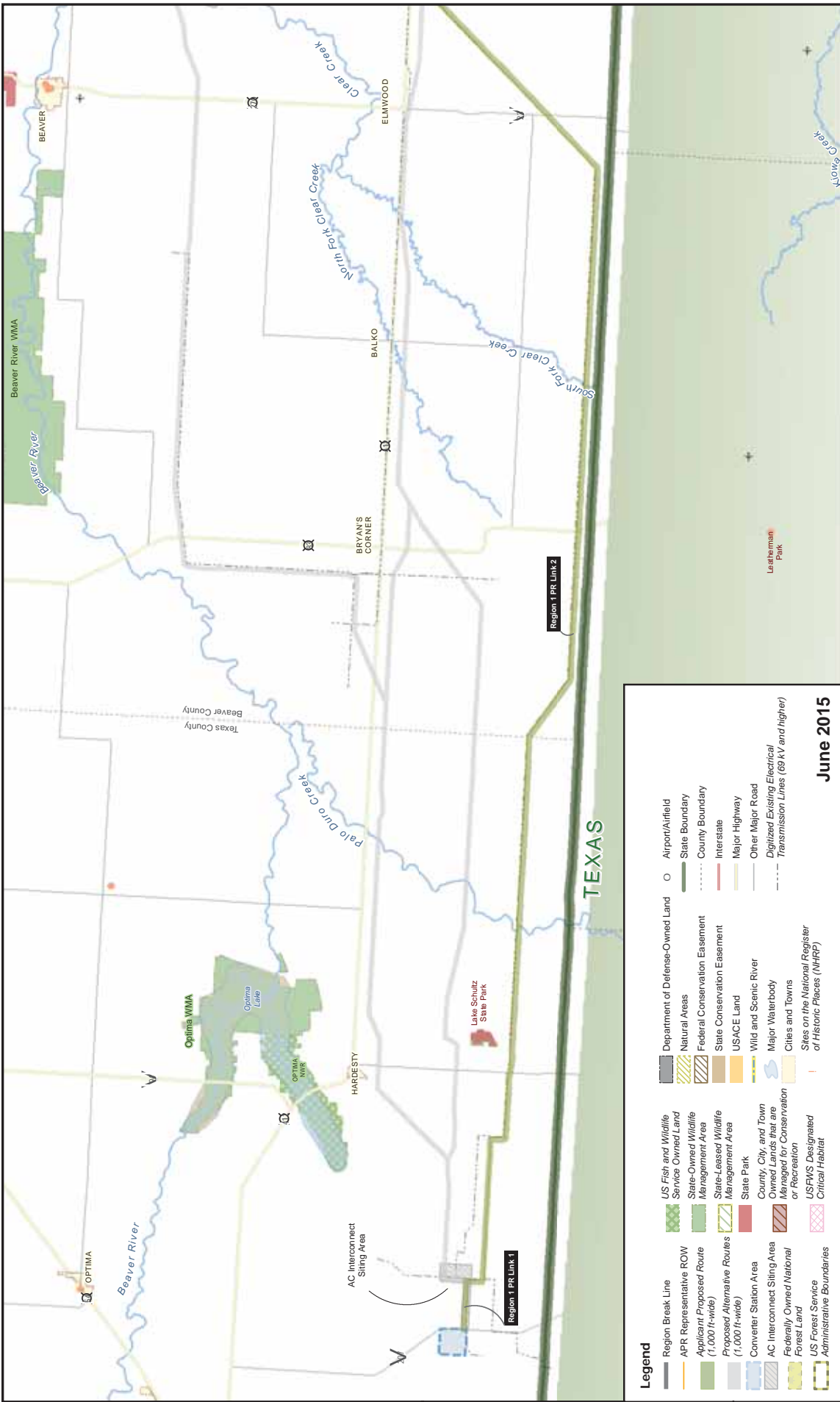

Figure 2-5a
HVDC Alternatives
Plains & Eastern Clean Line
Oklahoma, Arkansas and Tennessee

These Maps and Figures were prepared for the Department of Energy pursuant to 10 CFR 900.611-900.612. The maps and figures are for informational purposes only and are not intended to be used for any other purpose. The Department of Energy reserves the right to update the maps and figures at any time without notice. The maps and figures are preliminary and may be subject to revision based on new and/or additional information and input from DOE and/or others. No confidential data is depicted.

Map 1 of 15

June 2015

Scale: 1:222,730
Date: 6/24/2015

0 5 10 Miles
0 5 10 Kilometers

PLAINS & EASTERN CLEAN LINE

Map 2 of 15

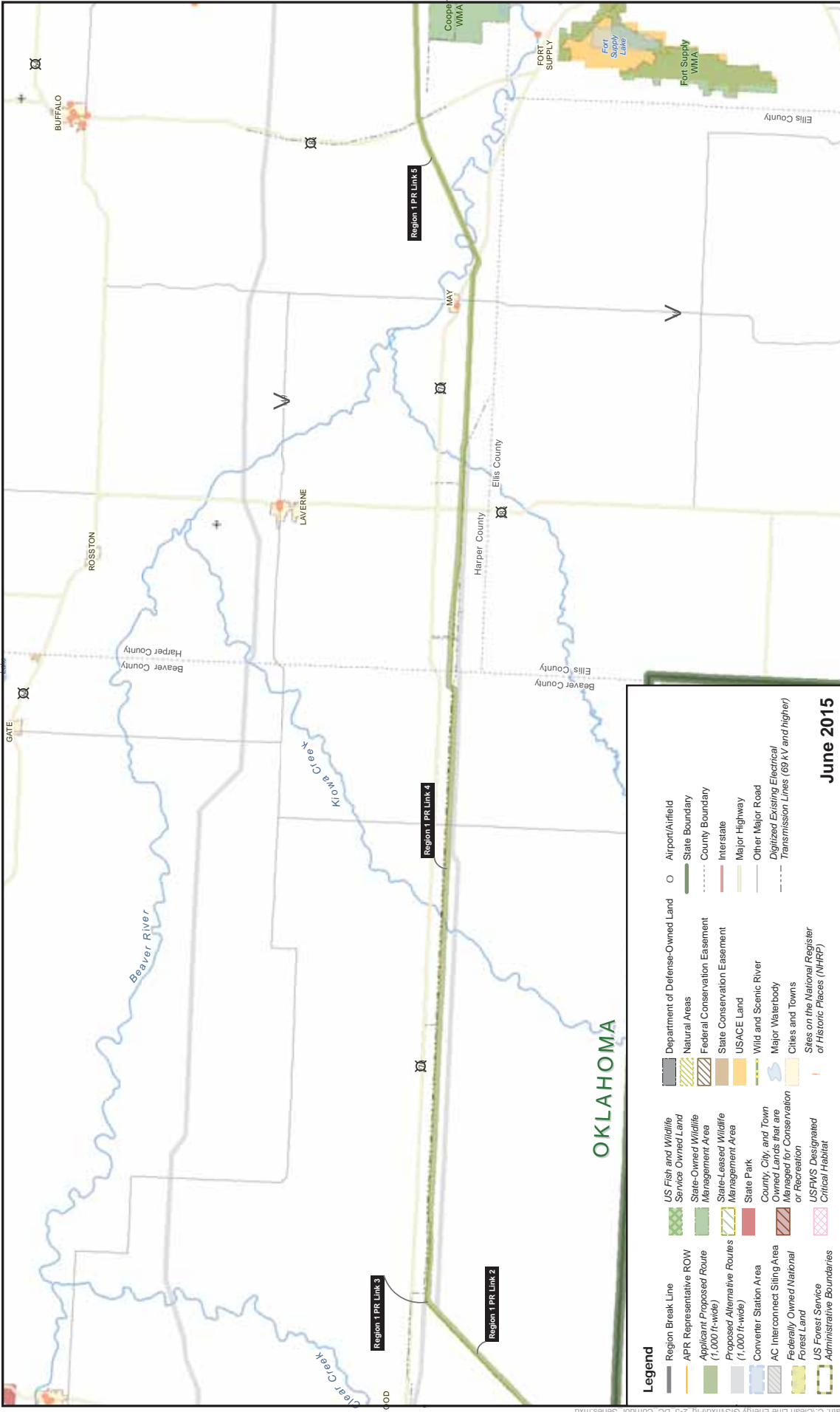
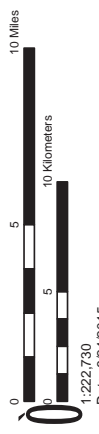

**Figure 2-5b
HVDC Alternatives
Plains & Eastern Clean Line**
Oklahoma, Arkansas and Tennessee

These Maps and Figures were prepared for the Department of Energy pursuant to 10 CFR 101.11, and are subject to the National Environmental Policy Act of 1969 (NEPA) and the requirements of the National Environmental Policy Act of 1969 (NEPA) under consideration in the Environmental Impact Statement for the Plains & Eastern Clean Line Project. The routes and information included in these Maps and Figures are preliminary and may be subject to revision based on new and/or additional information and input from DOE and/or others. No confidential data is depicted.

Data Sources: ESRI 2010 and 2012; USFS 2000, 2009a, 2009b, and 2014; USFWS 2012a, 2012b, 2013, and 2014; USACE 2011; Oklahoma Tourism and Recreation Department 2013; ANHC n.d.(b) and n.d.(c); USDA Natural Resources Conservation Service (NRCS) 2014; The Conservation Registry 2012; USACE Little Rock District and USACE Tulsa District, n.d.; NPS 2014; FAA 2013; BPS 2013; Clean Line 2013a, 2013 b, 2014, and 2015

June 2015



PLAINS & EASTERN CLEAN LINE

Map 3 of 15

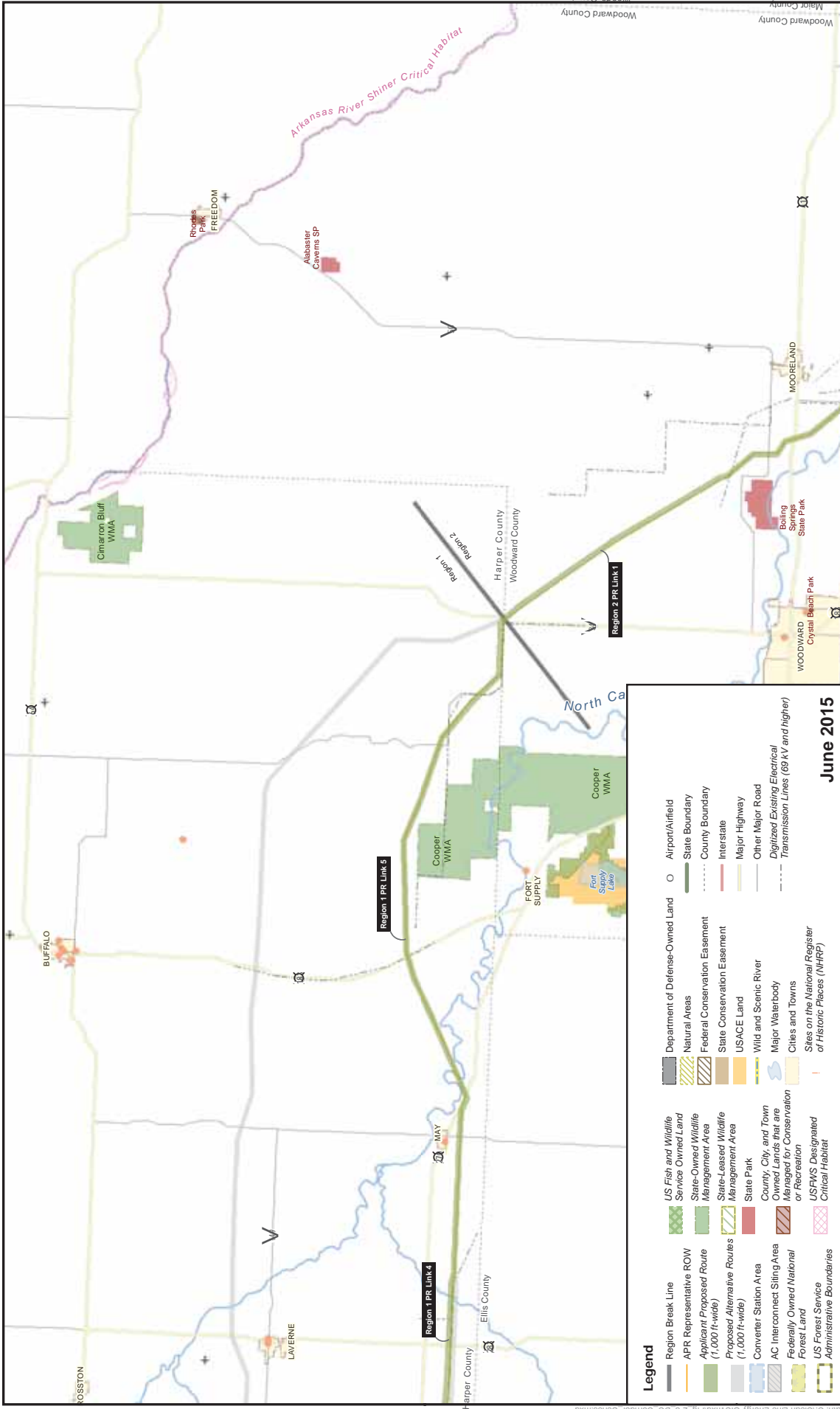

Legend

	Region Break Line		US Fish and Wildlife Service Owned Land		Airport/Airfield
	APR Representative ROW		State-Owned Wildlife Management Area		State Boundary
	Applicant Proposed Route (1,000 ft-wide)		State-Leased Wildlife Management Area		County Boundary
	Proposed Alternative Routes (1,000 ft-wide)		State Park		Interstate
	Converter Station Area		Wild and Scenic River		Major Highway
	AC Interconnect Siting Area		Major Waterbody		Other Major Road
	Federally Owned National Forest Land		Cities and Towns		Digitized Existing Electrical Transmission Lines (69 kV and higher)
	US Forest Service		Sites on the National Register of Historic Places (NHRP)		
	Administrative Boundaries				

June 2015

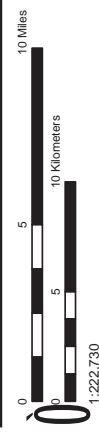

Data Sources: ESRI 2010 and 2012; USFS 2000, 2009a, 2009b, and 2014; USFWS 2012a, 2012b, 2013, and 2014; USACE 2012; USACE Tulsa District and USACE Tulsa District, n.d.; NPS 2014; PA 2013; GIS 2013; Clean Line 2013; 2014, and 2015

These Maps and Figures were prepared for the Department of Energy pursuant to 10 CFR 201.10(b) and 201.10(d) under consideration in the Environmental Impact Statement for the Plains & Eastern Clean Line Project. The routes and information included in these Maps and Figures are preliminary and may be subject to revision based on new and/or additional information and input from DOE and/or others. No confidential data is depicted.

Figure 2-5C
HVDC Alternatives
Plains & Eastern Clean Line
Oklahoma, Arkansas and Tennessee

PLAINS & EASTERN CLEAN LINE

Map 15 of 15

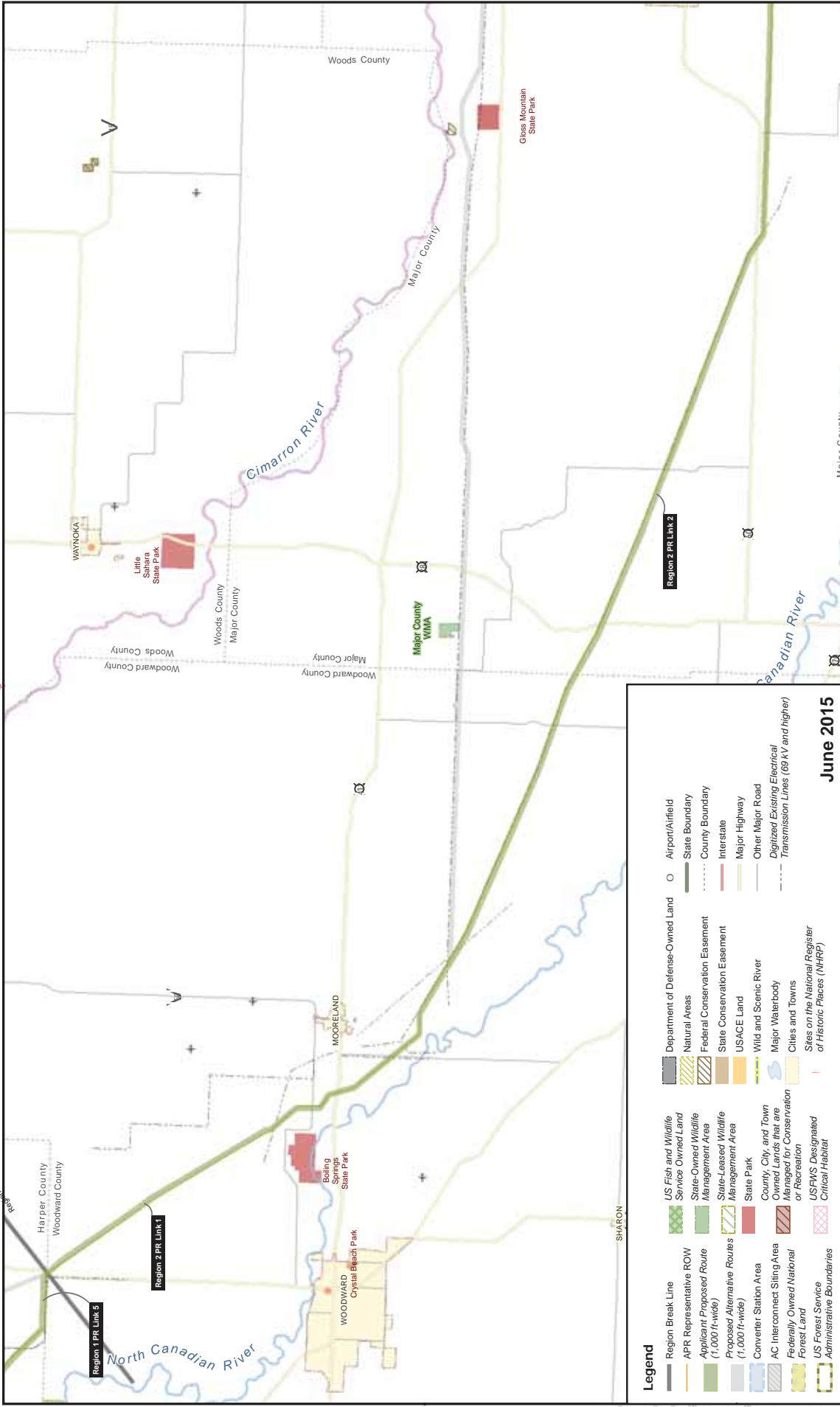

Figure 2-5d
HVDC Alternatives
Plains & Eastern Clean Line
 Oklahoma, Arkansas and Tennessee

These Maps and Figures were prepared for the Department of Energy pursuant to 10 CFR 101.11, which requires the Department of Energy to prepare and submit to the public under consideration in the Environmental Impact Statement for the Plains & Eastern Clean Line Project. The routes and information included in these Maps and Figures are preliminary and may be subject to revision based on new and/or additional information and input from DOE and/or others. No confidential data is depicted.

June 2015

Data Sources: ESRI 2010 and 2012; USFS 2000, 2009a, 2009b, and 2014; USFWS 2012a, 2013, and 2014; USDA 2006; TREC 2011; Oklahoma Tourism and Recreation Department 2013; ANHC n.d.(b) and n.d.(c); USDA Natural Resources Conservation Service (NRCS) 2014; The Conservation Registry 2012; USACE Little Rock District and USACE Tulsa District, n.d.; NPS 2014; PA 2013; BPS 2013; Clean Line 2013a, 2013 b, 2014, and 2015

0 5 10 Miles
 0 5 10 Kilometers

1,222,730
 Date: 6/24/2015

PLAINS & EASTERN CLEAN LINE

Map 4 of 15

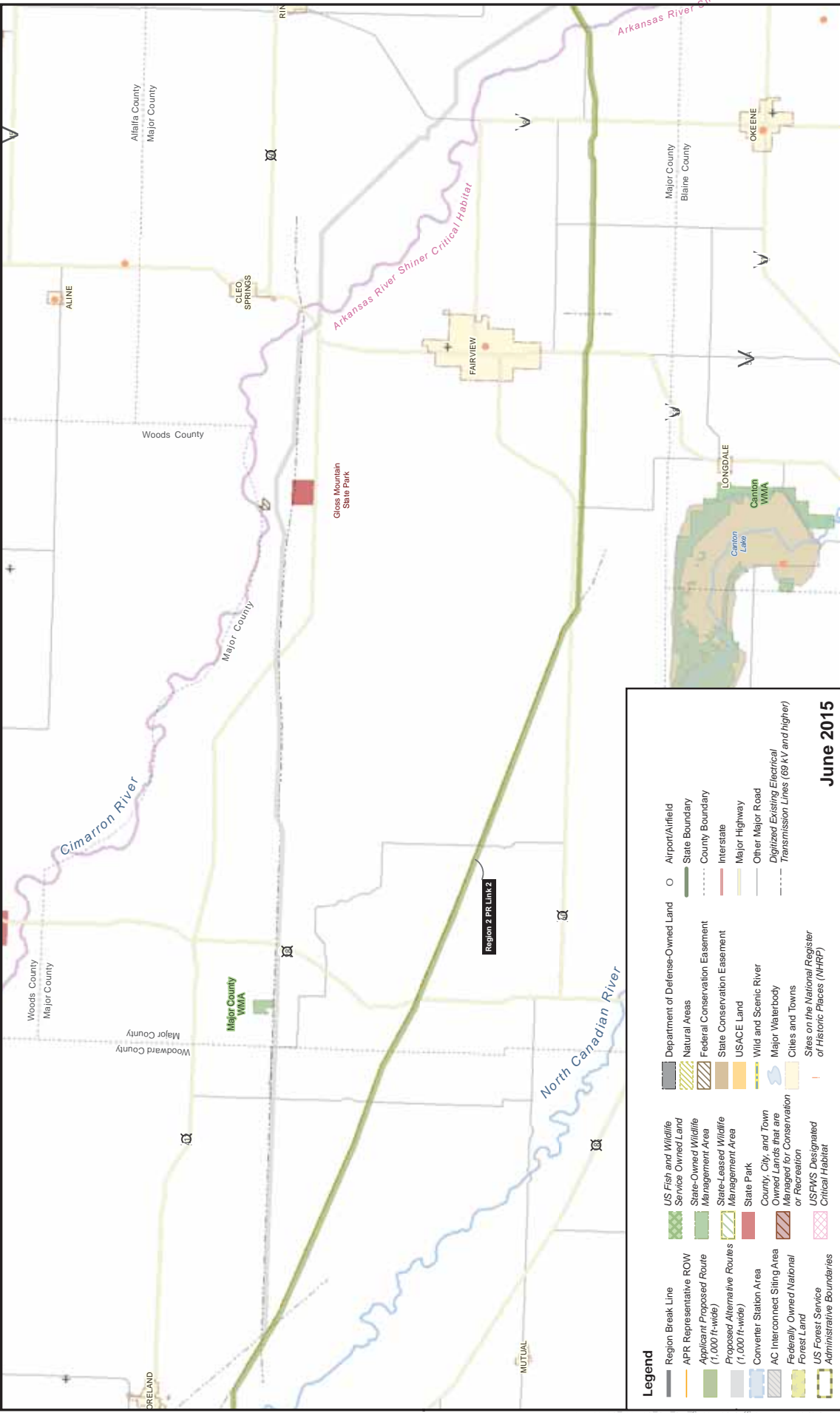

**Figure 2-5e
HVDC Alternatives
Plains & Eastern Clean Line**
Oklahoma, Arkansas and Tennessee

These Maps and Figures were prepared for the Department of Energy pursuant to 10 CFR 201.6(b) and (c) for the HVDC Alternatives Study for the Plains & Eastern Clean Line Project. The routes and information included in these Maps and Figures are preliminary and may be subject to revision based on new and/or additional information and input from DOE and/or others. No confidential data is depicted.

Data Sources: ESRI 2010 and 2012; USFS 2000, 2009a, 2009b, and 2014; USFWS 2012a, 2012b, 2013, and 2014; USACE 2010, 2011, 2012, 2013, and 2014; USACE Tulsa District, n.d.; USACE Little Rock District and USACE Tulsa District, n.d.; NPS 2014; PA 2013; GIS 2013; Clean Line 2013a, 2013b, 2013c, 2014, and 2015.

1:222,730
Date: 6/24/2015

PLAINS & EASTERN CLEAN LINE

Map 5 of 15

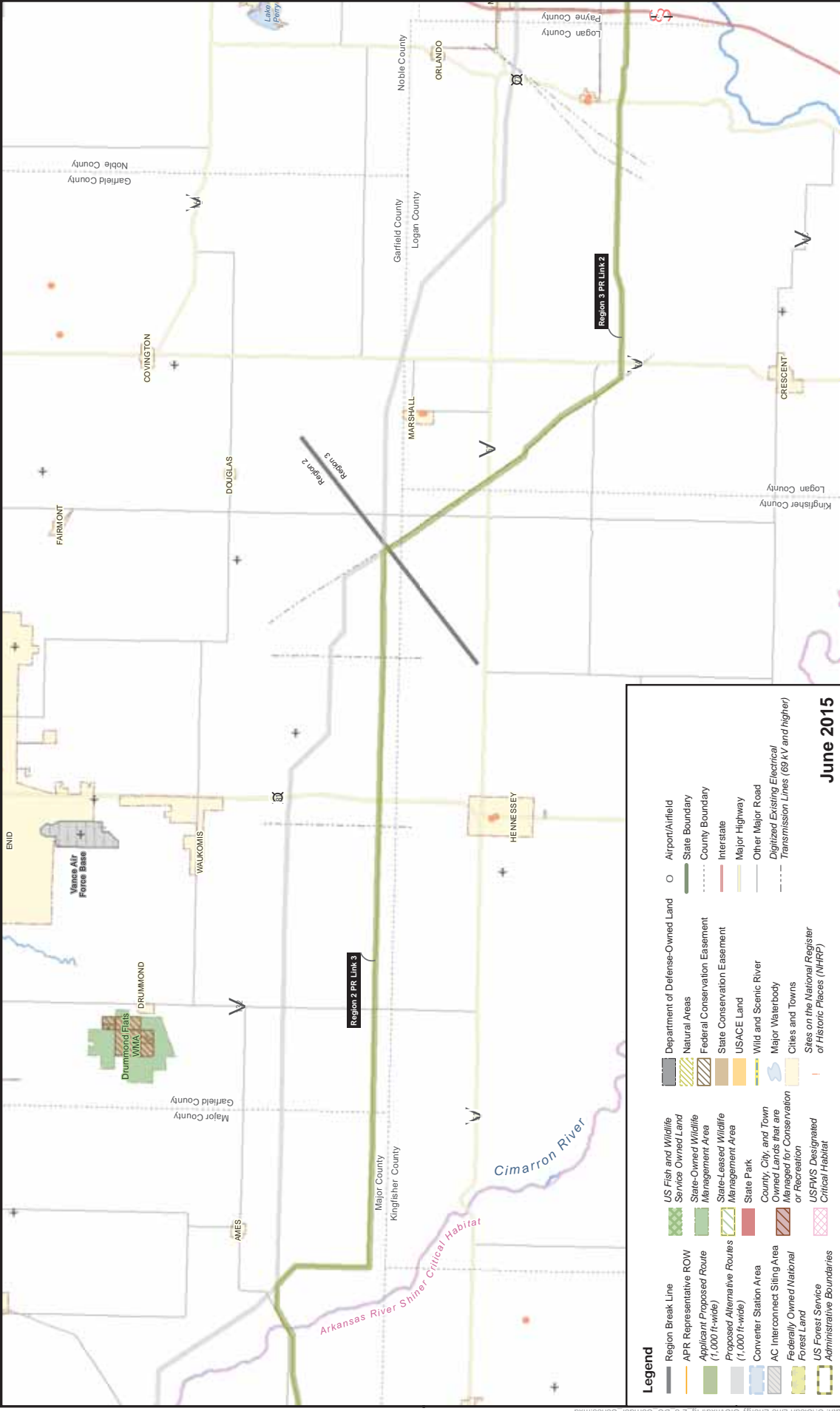

Legend

Region Break Line	US Fish and Wildlife Service Owned Land	Airport/Airfield
APR Representative ROW	State-Owned Wildlife Management Area	State Boundary
Applicant Proposed Route (1,000 ft-wide)	State-Leased Wildlife Management Area	County Boundary
Proposed Alternative Routes (1,000 ft-wide)	State Park	Interstate
Converter Station Area	County, City, and Town Owned Lands that are Managed for Conservation or Recreation	Major Highway
AC Interconnect Staging Area	Federally Owned National Forest Land	Other Major Road
US Forest Service	US Forest Service Designated Critical Habitat	Digitized Existing Electrical Transmission Lines (69 kV and higher)
Administrative Boundaries	Sites on the National Register of Historic Places (NHRP)	

June 2015

Data Sources: ESRI 2010 and 2012; USFS 2000, 2009a, 2009b, and 2014; USFWS 2012a, 2012b, 2013, and 2014; USACE Little Rock District and USACE Tulsa District, n.d.; NPS n.d.(b) and n.d.(c); USDA Natural Resources Conservation Service (NRCS) 2014; The Conservation Registry 2012; USACE Little Rock District and USACE Tulsa District, n.d.; NPS 2014; PA 2013; GIS 2013; Clean Line 2013a, 2013 b, 2014, and 2015

1:222,730
Date: 6/24/2015

**Figure 2-5f
HVDC Alternatives
Plains & Eastern Clean Line**
Oklahoma, Arkansas and Tennessee

These Maps and Figures were prepared for the Department of Energy pursuant to 10 CFR 101.11, and are not intended to be used for any other purpose. The maps and figures were prepared under consideration in the Environmental Impact Statement for the Plains & Eastern Clean Line Project. The routes and information included in these Maps and Figures are preliminary and may be subject to revision based on new and/or additional information and input from DOE and/or others. No confidential data is depicted.

PLAINS & EASTERN CLEAN LINE

Map 6 of 15

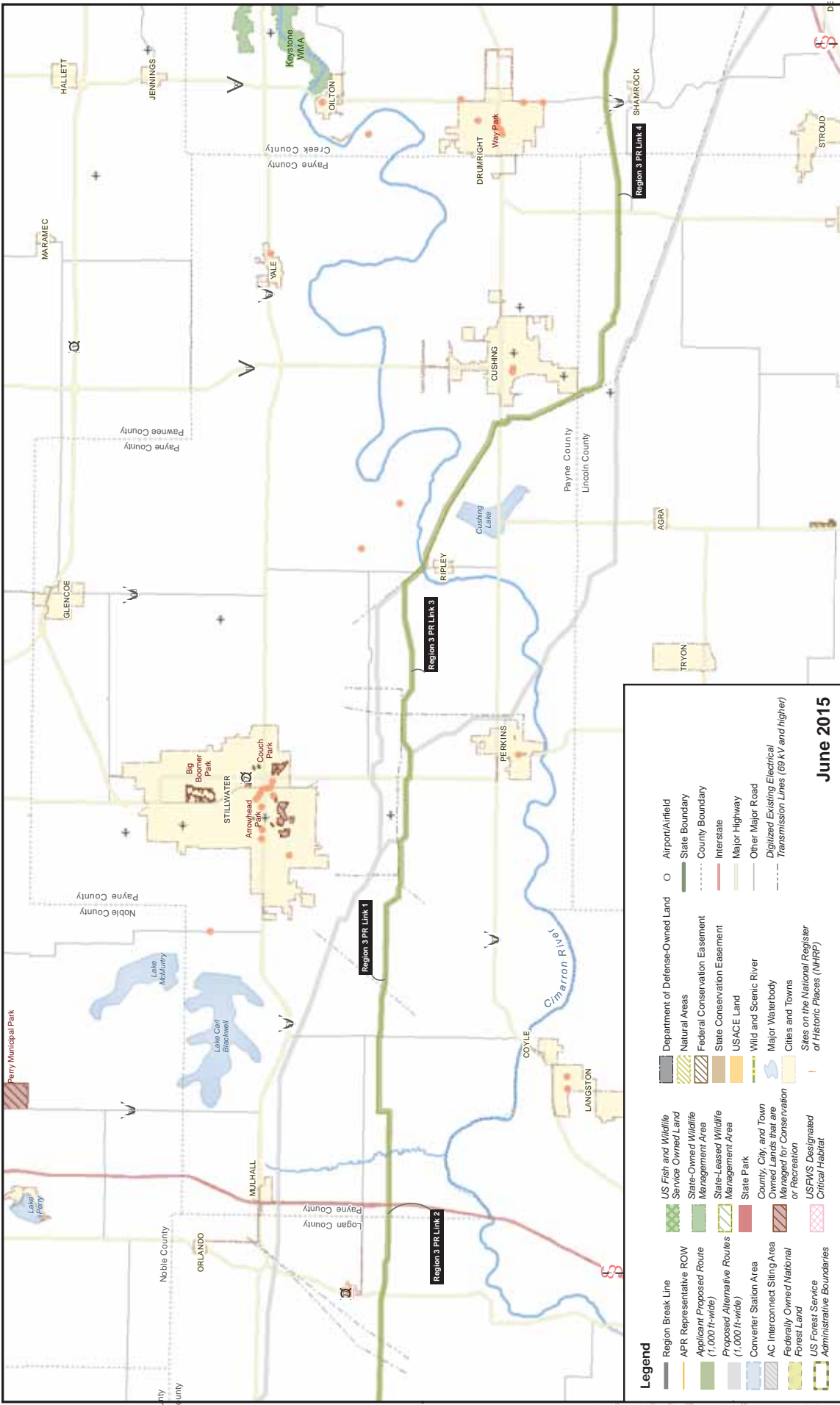

Legend

Region Break Line	US Fish and Wildlife Service Owned Land	Department of Defense-Owned Land	Airport/Airfield
APR Representative ROW	State-Owned Wildlife Management Area	Natural Areas	State Boundary
Applicant Proposed Route (1,000 ft-wide)	State-Leased Wildlife Management Area	Federal Conservation Easement	County Boundary
Proposed Alternative Routes (1,000 ft-wide)	State Park	State Conservation Easement	Interstate
Converter Station Area	County, City, and Town Owned Lands that are Managed for Conservation or Recreation	USACE Land	Major Highway
AC Interconnect Staging Area	Federally Owned National Forest Land	Wild and Scenic River	Other Major Road
US Forest Service	US Forest Service	Major Waterbody	Digitized Existing Electrical Transmission Lines (69 kV and higher)
Administrative Boundaries	Critical Habitat	Sites on the National Register of Historic Places (NHRP)	

June 2015

Data Sources: ESRI 2010 and 2012; USFS 2000, 2009a, 2009b, and 2014; USFWS 2012a, 2012b, 2013, and 2014; USACE 2010, 2011, 2012, 2013, and 2014; USACE Tulsa District, n.d.; USACE Little Rock District and USACE Tulsa District, n.d.; NPS 2014; PA 2013; GIS 2013; Clean Line 2013; 2014, and 2015.

1:222,730
Date: 6/24/2015

0 5 10 Miles
0 5 10 Kilometers

Figure 2-5g
HVDC Alternatives
Plains & Eastern Clean Line
Oklahoma, Arkansas and Tennessee

These Maps and Figures were prepared for the Department of Energy pursuant to 10 CFR 201.6(b) and 201.6(c) under the authority of the Department of Energy under consideration in the Environmental Impact Statement for the Plains & Eastern Clean Line Project. The routes and information included in these Maps and Figures are preliminary and may be subject to revision based on new and/or additional information and input from DOE and/or others. No confidential data is depicted.

PLAINS & EASTERN CLEAN LINE

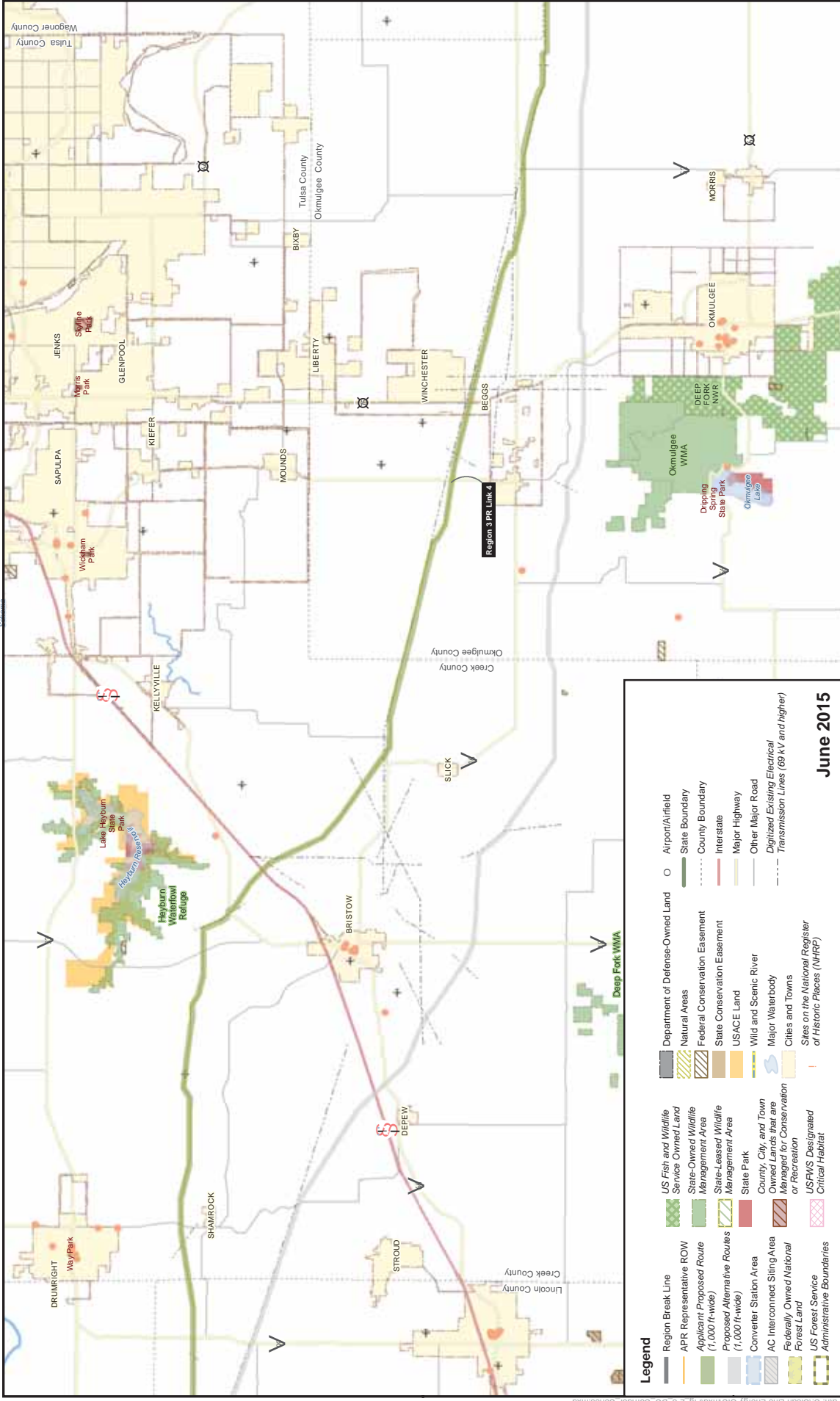

**Figure 2-5h
HVDC Alternatives
Plains & Eastern Clean Line**
Oklahoma, Arkansas and Tennessee

These Maps and Figures were prepared for the Department of Energy, pursuant to 10 CFR 2.206, under the authority of the Department of Energy under consideration in the Environmental Impact Statement for the Plains & Eastern Clean Line Project. The routes and information included in these Maps and Figures are preliminary and may be subject to revision based on new and/or additional information and input from DOE and/or others. No confidential data is depicted.

June 2015

Data Sources: ESRI 2010 and 2012; USFS 2000, 2009a, 2009b, and 2014; USFWS 2012a, 2012b, 2013, and 2014; USACE 2010, 2011, 2012, and 2013; ARCS 2013; ANHC n.d.(b) and n.d.(c); USDA Natural Resources Conservation Service (NRCS) 2014; The Conservation Registry 2012; USACE Little Rock District and USACE Tulsa District, n.d.; NPS 2014; PA 2013; GIS 2013; Clean Line 2013a, 2013 b, 2014, and 2015

1:222,730
Date: 6/24/2015

PLAINS & EASTERN CLEAN LINE

Map 8 of 15

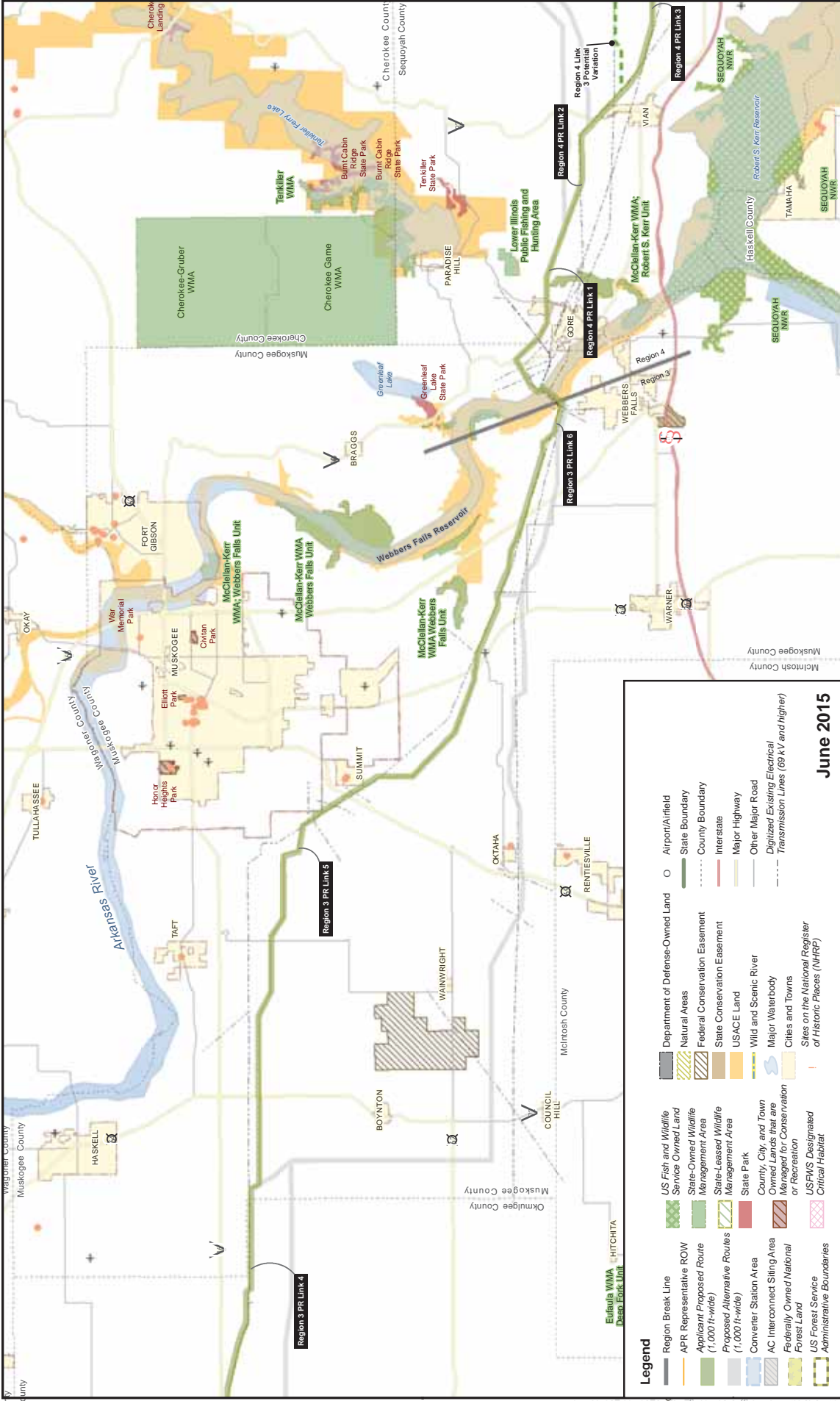

Legend

- Region Break Line
- APR Representative ROW
- Applicant Proposed Route (1,000 ft-wide)
- Proposed Alternative Routes (1,000 ft-wide)
- Converter Station Area
- AC Interconnect Siting Area
- Federally Owned National Forest Land
- US Forest Service Administrative Boundaries
- US Fish and Wildlife Service Owned Land
- State-Owned Wildlife Management Area
- State-Leased Wildlife Management Area
- State Park
- County, City, and Town Owned Lands that are Managed for Conservation or Recreation
- USFWS Designated Critical Habitat
- Department of Defense-Owned Land
- Natural Areas
- Federal Conservation Easement
- State Conservation Easement
- USACE Land
- Wild and Scenic River
- Major Waterbody
- Cities and Towns
- Sites on the National Register of Historic Places (NHRP)
- Airport/Airfield
- State Boundary
- County Boundary
- Interstate
- Major Highway
- Other Major Road
- Digitized Existing Electrical Transmission Lines (69 kV and higher)

June 2015

0 5 10 Miles
0 5 10 Kilometers

1:222,730

Date: 6/24/2015

Data Sources: ESRI 2010 and 2012; USFS 2000, 2009a, 2009b, and 2014; USFWS 2012a, 2012b, 2013, and 2014; USACE 2011; Oklahoma Department of Transportation 2013; ANHC n.d.(b) and n.d.(c); USDA Natural Resources Conservation Service (NRCS) 2014; The Conservation Registry 2012; USACE Little Rock District and USACE Tulsa District, n.d.; NPS 2014; PA 2013; GIS 2015; Clean Line 2015a, 2013, 2014, and 2015

These Maps and Figures were prepared for the Department of Energy pursuant to 10 CFR 20.101(b) and 20.101(c) for the proposed Plains & Eastern Clean Line project. The maps and figures are preliminary and subject to change without notice. The maps and figures are prepared under consideration in the Environmental Impact Statement for the Plains & Eastern Clean Line Project. The routes and information included in these Maps and Figures are preliminary and may be subject to revision based on new and/or additional information and input from DOE and/or others. No confidential data is depicted.

**Figure 2-51
HVDC Alternatives
Plains & Eastern Clean Line**
Oklahoma, Arkansas and Tennessee

PLAINS & EASTERN CLEAN LINE

Map 9 of 15

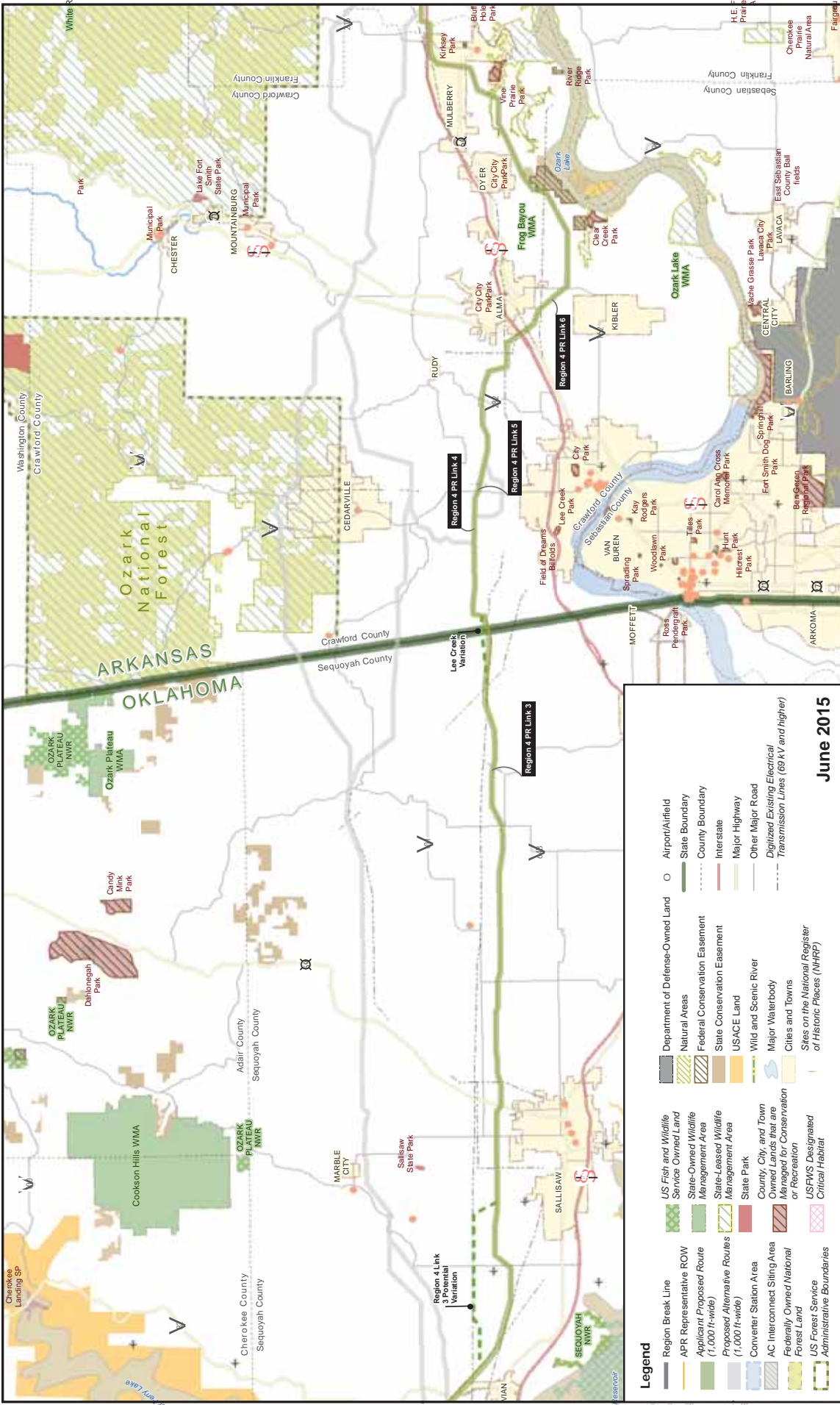

Figure 2-5] HVDC Alternatives Plains & Eastern Clean Line

These Maps and Figures were prepared for the Department of Energy pursuant to 10 CFR 20.101-20.102 and 20.103-20.104. The maps and figures are preliminary and subject to revision based on new and/or additional information and input from DOE and/or others. No confidential data is depicted.

Data Sources: ESRI 2010 and 2012; USFS 2000, 2009a, 2009b, and 2014; USFWS 2012a, 2012b, 2013, and 2014; USACE 2011; Oklahoma Department of Transportation 2013; ANRC n.d.(b) and n.d.(c); USDA Natural Resources Conservation Service (NRCS) 2014; The Conservation Registry 2012; USACE Little Rock District and USACE Tulsa District, n.d.; NPS 2014; PA 2013; GIS 2013; Clean Line 2013a, 2013b, 2013c, 2014, and 2015

June 2015

0 5 10 Miles
0 5 10 Kilometers

1:222,730

Date: 6/24/2015

PLAINS & EASTERN CLEAN LINE

Map 10 of 15

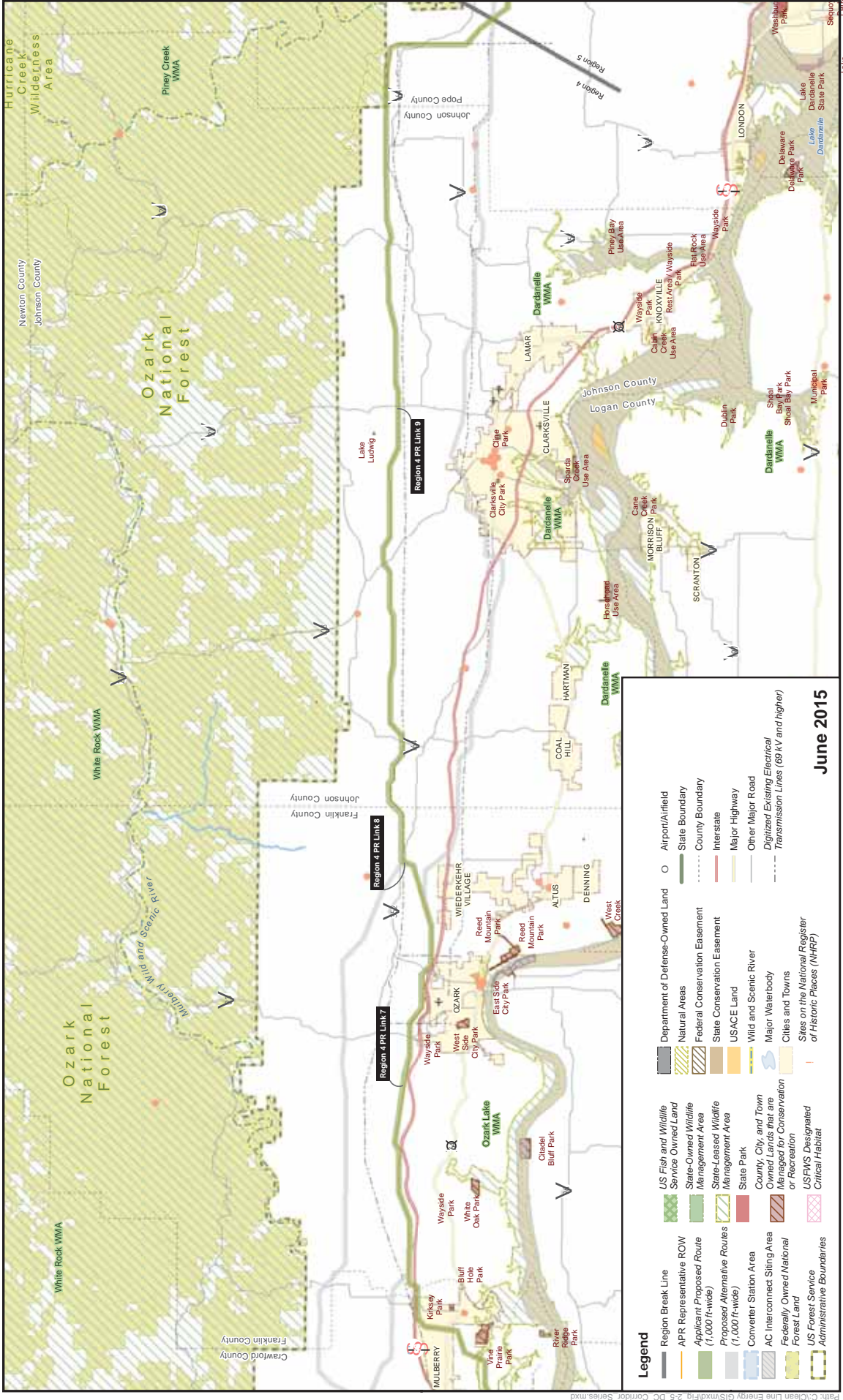

Legend

Region Break Line	US Fish and Wildlife Service Owned Land	Department of Defense-Owned Land	Airport/Airfield
APR Representative ROW	State-Owned Land	Natural Areas	State Boundary
Applicant Proposed Route (1,000 ft-wide)	State-Owned Wildlife Management Area	Federal Conservation Easement	County Boundary
Proposed Alternative Routes (1,000 ft-wide)	State-Leased Wildlife Management Area	State Conservation Easement	Interstate
Converter Station Area	State Park	USACE Land	Major Highway
AC Interconnect Staging Area	County, City, and Town Owned Lands that are Managed for Conservation or Recreation	Wild and Scenic River	Other Major Road
Federally Owned National Forest Land	USFWS Designated Critical Habitat	Major Waterbody	Digitized Existing Electrical Transmission Lines (69 kV and higher)
US Forest Service		States on the National Register of Historic Places (NHRP)	
Administrative Boundaries			

June 2015

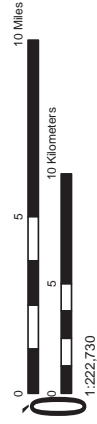

Data Sources: ESRI 2010 and 2012; USFS 2000, 2009a, 2009b, and 2014; USFWS 2012a, 2012b, 2013, 2014; USACE 2005, 2006, 2007, 2008, 2009, 2010, 2011, 2012, 2013, 2014; USACE 2013; ARD 2006; TREC 2011; Oklahoma, Tourism and Recreation Department 2013; ANHC n.d.(b) and n.d.(c); USDA Natural Resources Conservation Service (NRCS) 2014; The Conservation Registry 2012; USACE Little Rock District and USACE Tulsa District, n.d.; NPS 2014; PA 2013; GIS 2013; Clean Line 2010a, 2010b, 2011, 2012, 2013, 2014, and 2015

These Maps and Figures were prepared for the Department of Energy pursuant to 10 CFR 201.10(a) and 201.10(b) for the proposed HVDC Alternatives for the Plains & Eastern Clean Line under consideration in the Environmental Impact Statement for the Plains & Eastern Clean Line Project. The routes and information included in these Maps and Figures are preliminary and may be subject to revision based on new and/or additional information and input from DOE and/or others. No confidential data is depicted.

Figure 2-5k
HVDC Alternatives
Plains & Eastern Clean Line
Oklahoma, Arkansas and Tennessee

PLAINS & EASTERN CLEAN LINE

Map 11 of 15

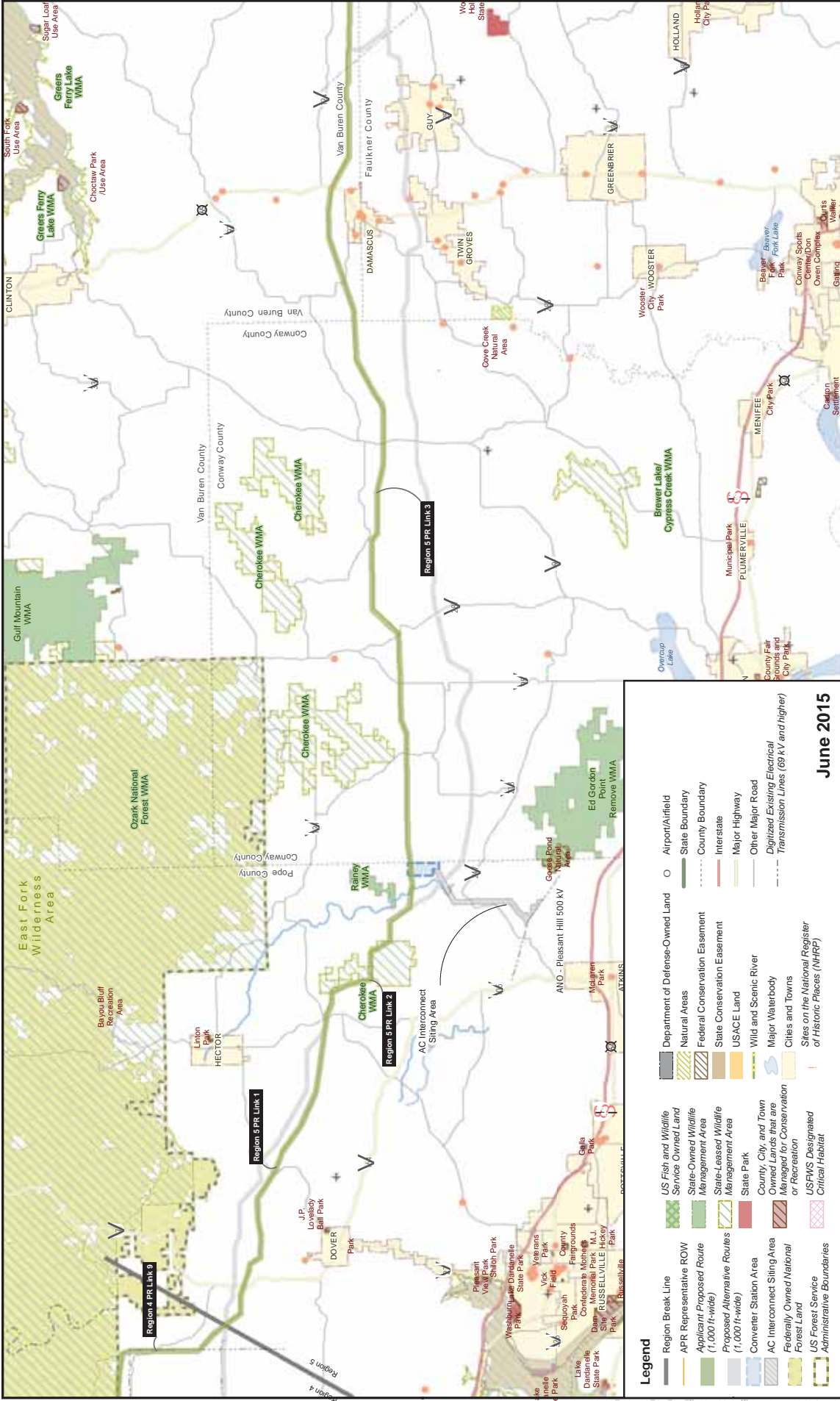

Figure 2-51 HVDC Alternatives Plains & Eastern Clean Line

These Maps and Figures were prepared for the Department of Energy pursuant to 10 CFR 101.11, 101.12, 101.13, and 101.14, under the authority of the Department of Energy under consideration in the Environmental Impact Statement for the Plains & Eastern Clean Line Project. The routes and information included in these Maps and Figures are preliminary and may be subject to revision based on new and/or additional information and input from DOE and/or others. No confidential data is depicted.

Data Sources: ESRI 2010 and 2012; USFS 2000, 2009a, and 2014; USFWS 2012a, 2012b, 2013, and 2014; USACE 2013; ARD 2006; TREC 2011; Oklahoma Tourism and Recreation Department 2013; ANRC n.d.(b) and n.d.(c); USDA Natural Resources Conservation Service (NRCS) 2014; The Conservation Registry 2012; USACE Little Rock District and USACE Tulsa District, n.d.; NPS 2014; PA 2013; GIS 2013; Clean Line 2013a, 2013b, 2014, and 2015

PLAINS & EASTERN CLEAN LINE

Map 12 of 15

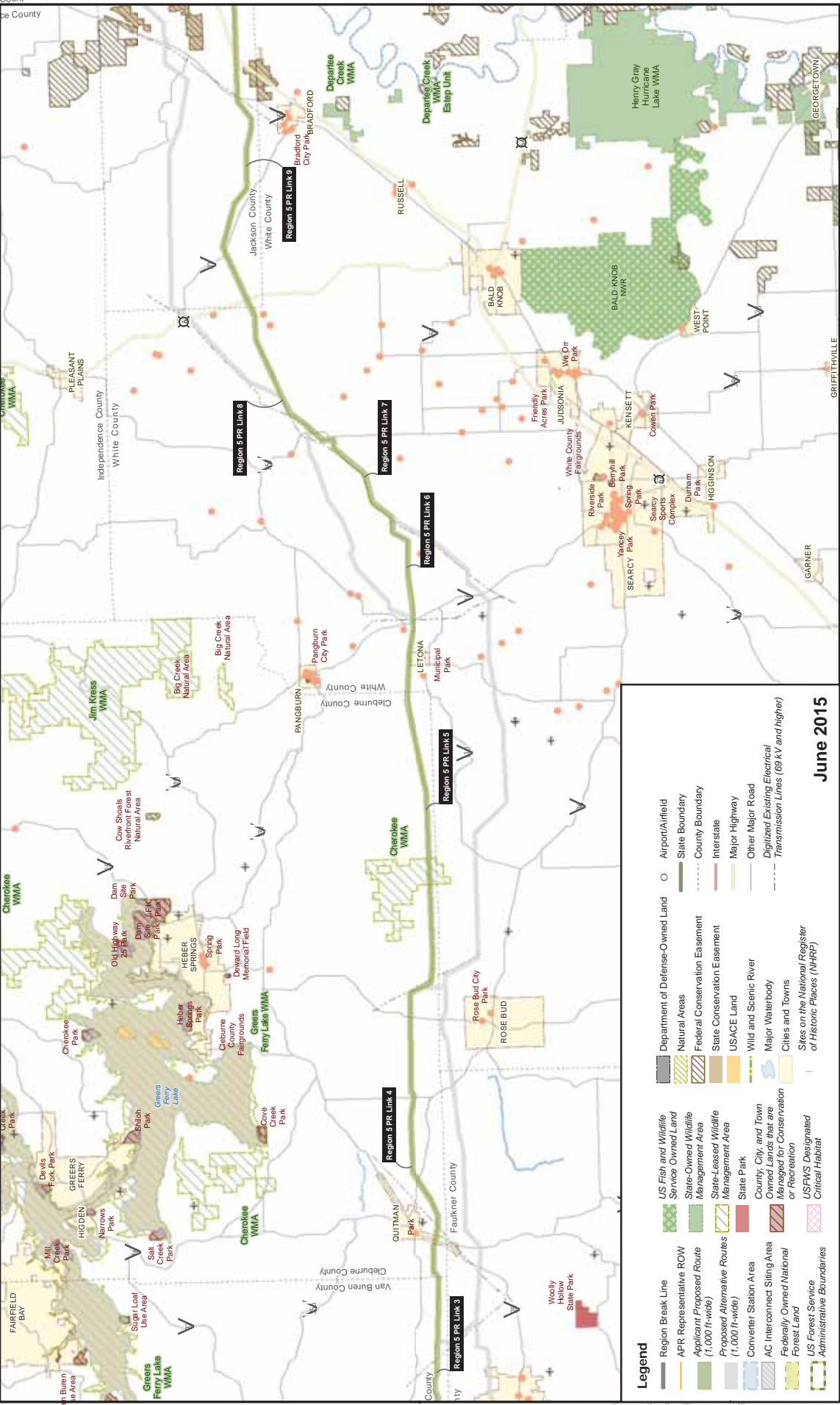

Figure 2-5m HVDC Alternatives Plains & Eastern Clean Line
 Oklahoma, Arkansas and Tennessee

These Maps and Figures were prepared for the Department of Energy pursuant to 10 CFR 201.10(b) and 201.10(d) under consideration in the Environmental Impact Statement for the Plains & Eastern Clean Line Project. The routes and information included in these Maps and Figures are preliminary and may be subject to revision based on new and/or additional information and input from DOE and/or others. No confidential data is depicted.

Data Sources: ESRI 2010 and 2012; USFS 2000, 2009a, 2009b, and 2014; USFWS 2012a, 2012b, 2013, and 2014; USACE 2010, 2011, 2012, 2013, and 2014; USACE Tulsa District, n.d.; USACE n.d.(b) and n.d.(c); USDA Natural Resources Conservation Service (NRCS) 2014; The Conservation Registry 2012; USACE Little Rock District and USACE Tulsa District, n.d.; NPS 2014; PA 2013; GIS 2013; Clean Line 2013a, 2013b, 2013c, 2014, and 2015

June 2015

1:222,730
 Date: 6/24/2015

PLAINS & EASTERN CLEAN LINE

Map 13 of 15

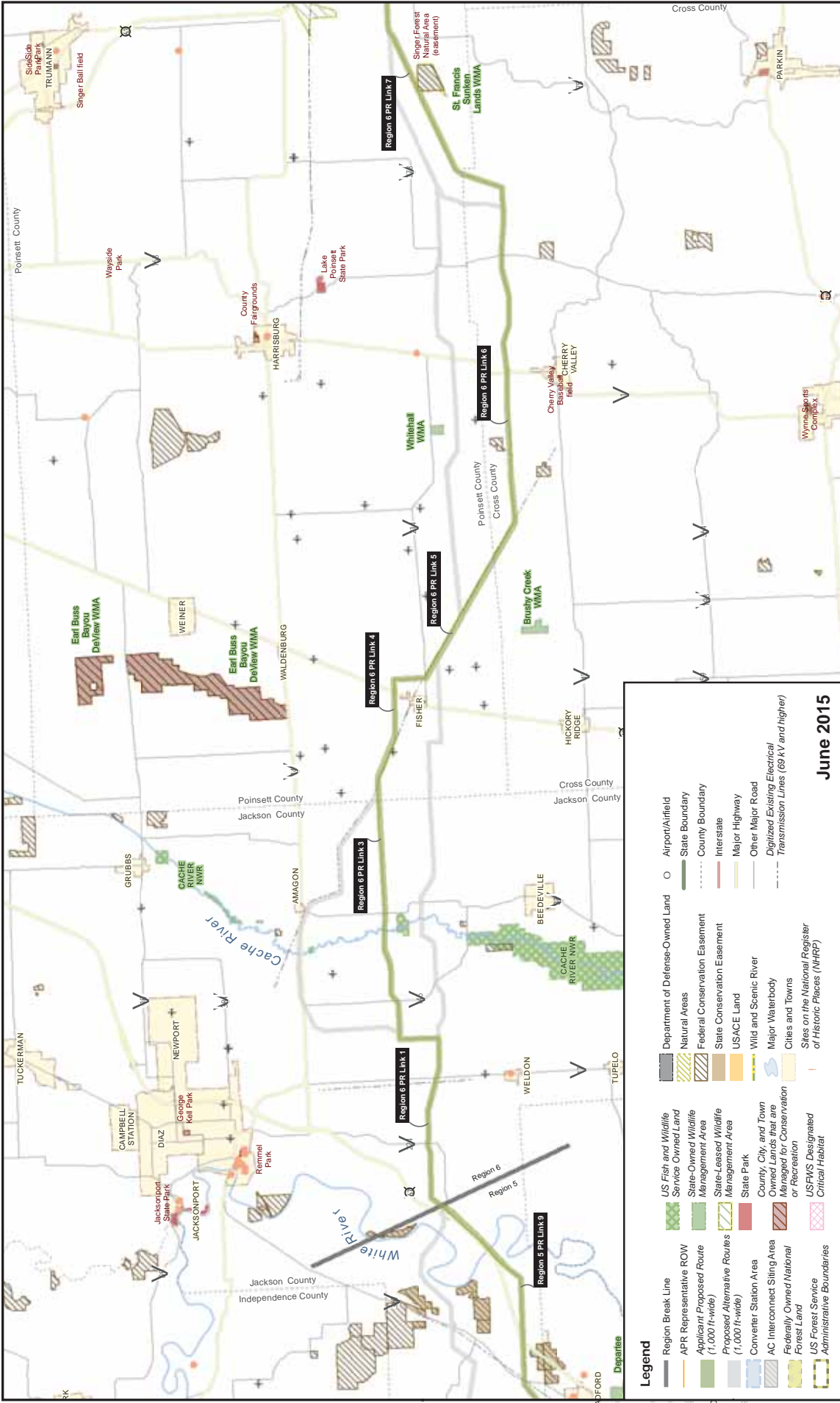
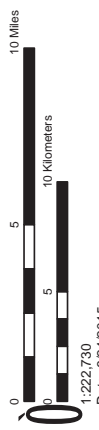

**Figure 2-5n
HVDC Alternatives
Plains & Eastern Clean Line**
Oklahoma, Arkansas and Tennessee

These Maps and Figures were prepared for the Department of Energy pursuant to 10 CFR 20.101(b) and 20.101(c) under consideration in the Environmental Impact Statement for the Plains & Eastern Clean Line Project. The routes and information included in these Maps and Figures are preliminary and may be subject to revision based on new and/or additional information and input from DOE and/or others. No confidential data is depicted.

June 2015

Data Sources: ESRI 2010 and 2012; USFS 2000, 2009a, 2009b, and 2014; USFWS 2012a, 2012b, 2013, and 2014; ARD 2006; TREC 2011; Oklahoma, Tourism and Recreation Department 2013; ANHC n.d.(b) and n.d.(c); USDA Natural Resources Conservation Service (NRCS) 2014; The Conservation Registry 2012; USACE Little Rock District and USACE Tulsa District, n.d.; NPS 2014; PA 2013; GIS 2013; Clean Line 2010a, 2013, 2014, and 2015



Legend

	Region Break Line		Department of Defense-Owned Land
	APR Representative ROW		Natural Areas
	Applicant Proposed Route (1,000 ft-wide)		Federal Conservation Easement
	Proposed Alternative Routes (1,000 ft-wide)		State Conservation Easement
	Converter Station Area		USACE Land
	AC Interconnect Siting Area		Wild and Scenic River
	Federally Owned National Forest Land		Major Waterbody
	US Forest Service		Cities and Towns
	Administrative Boundaries		Sites on the National Register of Historic Places (NHRP)
	US Fish and Wildlife Service Owned Land		Airport/Airfield
	State-Owned Wildlife Management Area		State Boundary
	State-Leased Wildlife Management Area		County Boundary
	State Park		Interstate
	County, City, and Town Owned Lands that are Managed for Conservation or Recreation		Major Highway
	USFWS Designated Critical Habitat		Other Major Road
			Digitized Existing Electrical Transmission Lines (69 kV and higher)

PLAINS & EASTERN

CLEAN LINE

Map 14 of 15

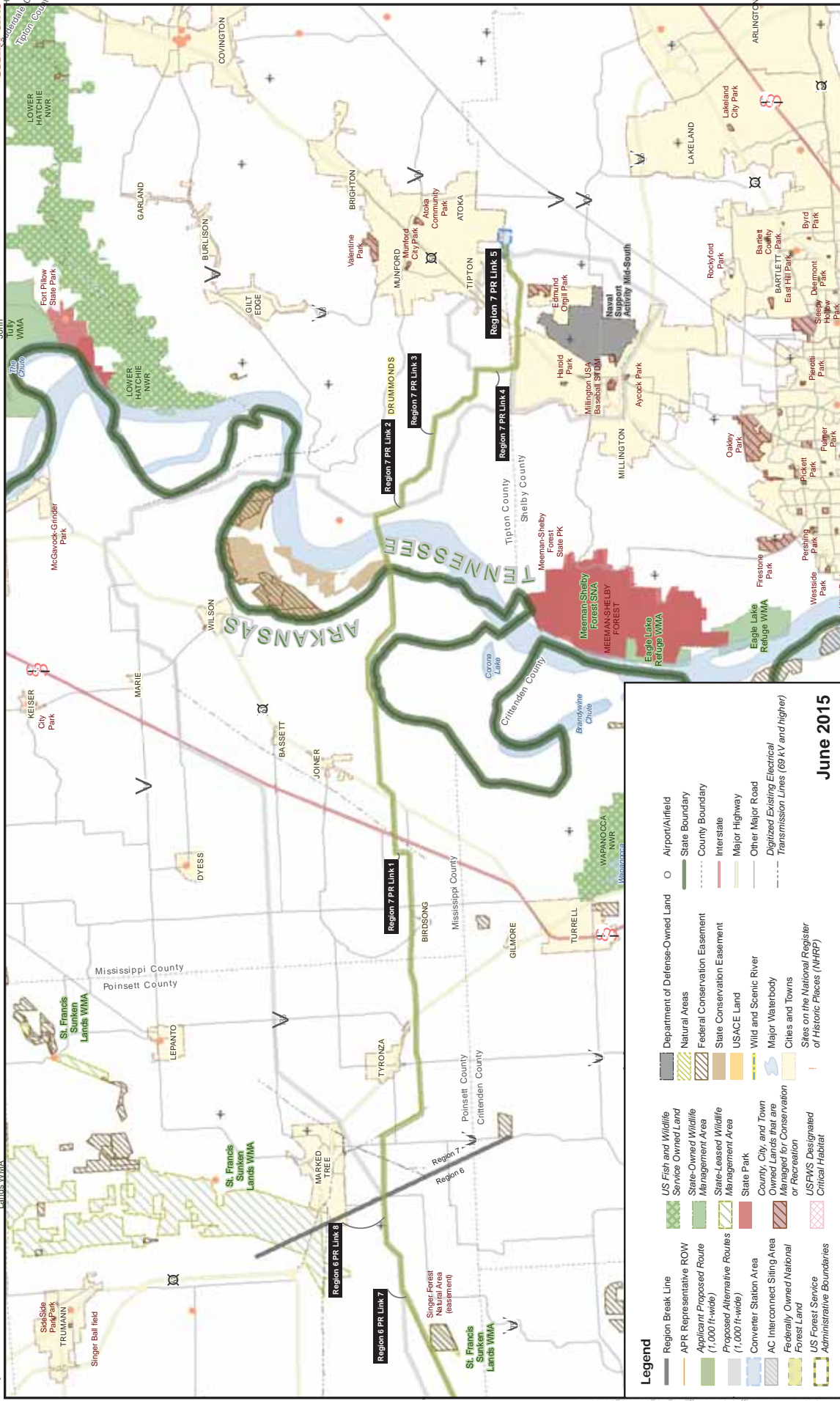

Legend

	Region Break Line		US Fish and Wildlife Service Owned Land		Department of Defense-Owned Land
	APR Representative ROW		State-Owned Land		Natural Areas
	Applicant Proposed Route (1,000 ft-wide)		Federal Conservation Easement		State Conservation Easement
	Proposed Alternative Routes (1,000 ft-wide)		USACE Land		Interstate
	Converter Station Area		Wild and Scenic River		Major Highway
	AC Interconnect Siting Area		Major Waterbody		Digitized Existing Electrical Transmission Lines (69 kV and higher)
	Federally Owned National Forest Land		Cities and Towns		Sites on the National Register of Historic Places (NHRP)
	US Forest Service Administrative Boundaries		State Boundary		
			County Boundary		
			Airport/Airfield		

June 2015

Data Sources: ESRI 2010 and 2012; USFS 2000, 2009a, 2009b, and 2014; USFWS 2012a, 2012b, 2013, and 2014; USACE 2012; USACE Tulsa District and USACE Tulsa District, n.d.; NPS 2014; PA 2013; BLS 2013; Clean Line 2013; 2014, and 2015

Scale: 0 to 10 Miles / 0 to 10 Kilometers

1:222,730

Date: 6/24/2015

Figure 2-50
HVDC Alternatives
Plains & Eastern Clean Line
 Oklahoma, Arkansas and Tennessee

These Maps and Figures were prepared for the Department of Energy pursuant to 10 CFR 2.106. The maps and figures are preliminary and are not intended to be used for any other purpose. The maps and figures are prepared under consideration in the Environmental Impact Statement for the Plains & Eastern Clean Line Project. The routes and information included in these Maps and Figures are preliminary and may be subject to revision based on new and/or additional information and input from DOE and/or others. No confidential data is depicted.

PLAINS & EASTERN CLEAN LINE

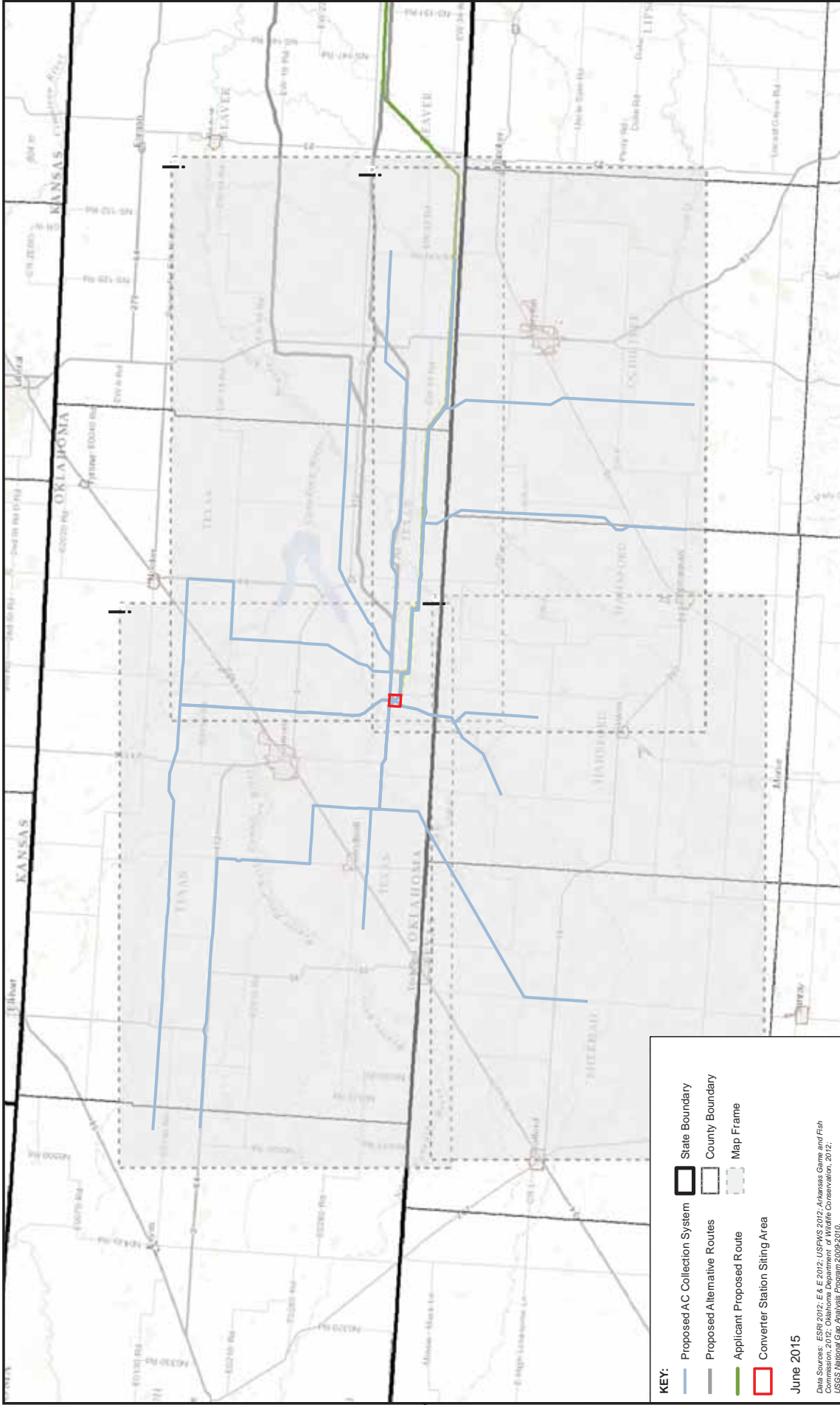

The Proposed Routes and Alternative Routes are preliminary and based upon desktop review. The Proposed Route and Alternative Routes will be revisited after field and engineering review.

Figure 2-6
AC Collection System: Map Index
Plains & Eastern Clean Line
Oklahoma and Texas

PLAINS & EASTERN CLEAN LINE

Map 1 of 4

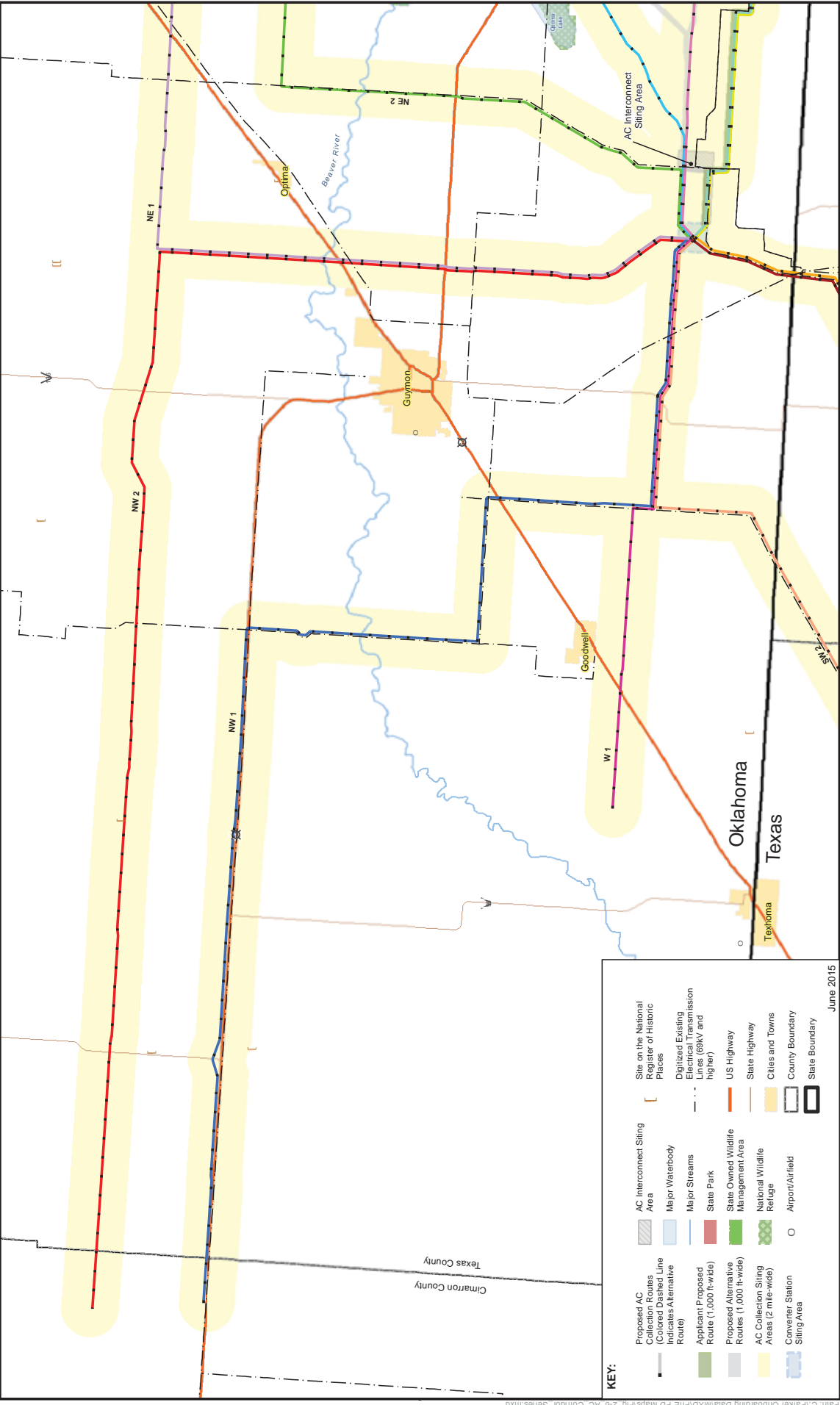

KEY:

Proposed AC Routes (Colored Dashed Line Indicates Alternative Route)	AC Interconnect Sling Area	Site on the National Register of Historic Places
Applicant Proposed Route (1,000 ft-wide)	Major Waterbody	Digitized Existing Electrical Transmission Lines (69kV and higher)
Proposed Alternative Routes (1,000 ft-wide)	Major Streams	US Highway
AC Collection Sling Areas (2-mile-wide)	State Park	State Highway
Converter Station Sling Area	State Owned Wildlife Management Area	Cities and Towns
	National Wildlife Refuge	County Boundary
	Airport/Airfield	State Boundary

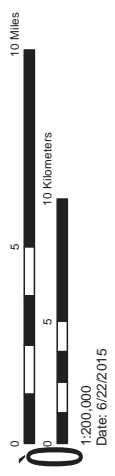

Data Sources: ESRI 2010 and 2012; USFS 2003, 2009a, 2009b, and 2010; USFWS 2012a and 2012b; USGS 2010; USGS 2011; Oklahoma Tourism and Recreation Department 2013; ANRC n.d.(b) and n.d.(c); USDA Natural Resources Conservation Service (NRCS) n.d.; The Conservation Registry 2012; USACE Little Rock District and USACE Tulsa District, n.d.; NPS 2010; FAA 2010; BTS 2008; Clean Line 2013a and 2013f.

These Maps and Figures were prepared to assist in determining the route alternatives to be used for the AC Collection System for the Plains & Eastern Clean Line Project. The routes and information included in these Maps and Figures are preliminary and may be subject to revision based on new and/or additional information and input from DOE and/or others. No confidential data is depicted.

Figure 2-6a
AC Collection System
Plains & Eastern Clean Line
Oklahoma and Texas

1:200,000
Date: 6/22/2015

PLAINS & EASTERN CLEAN LINE

Map 2 of 4

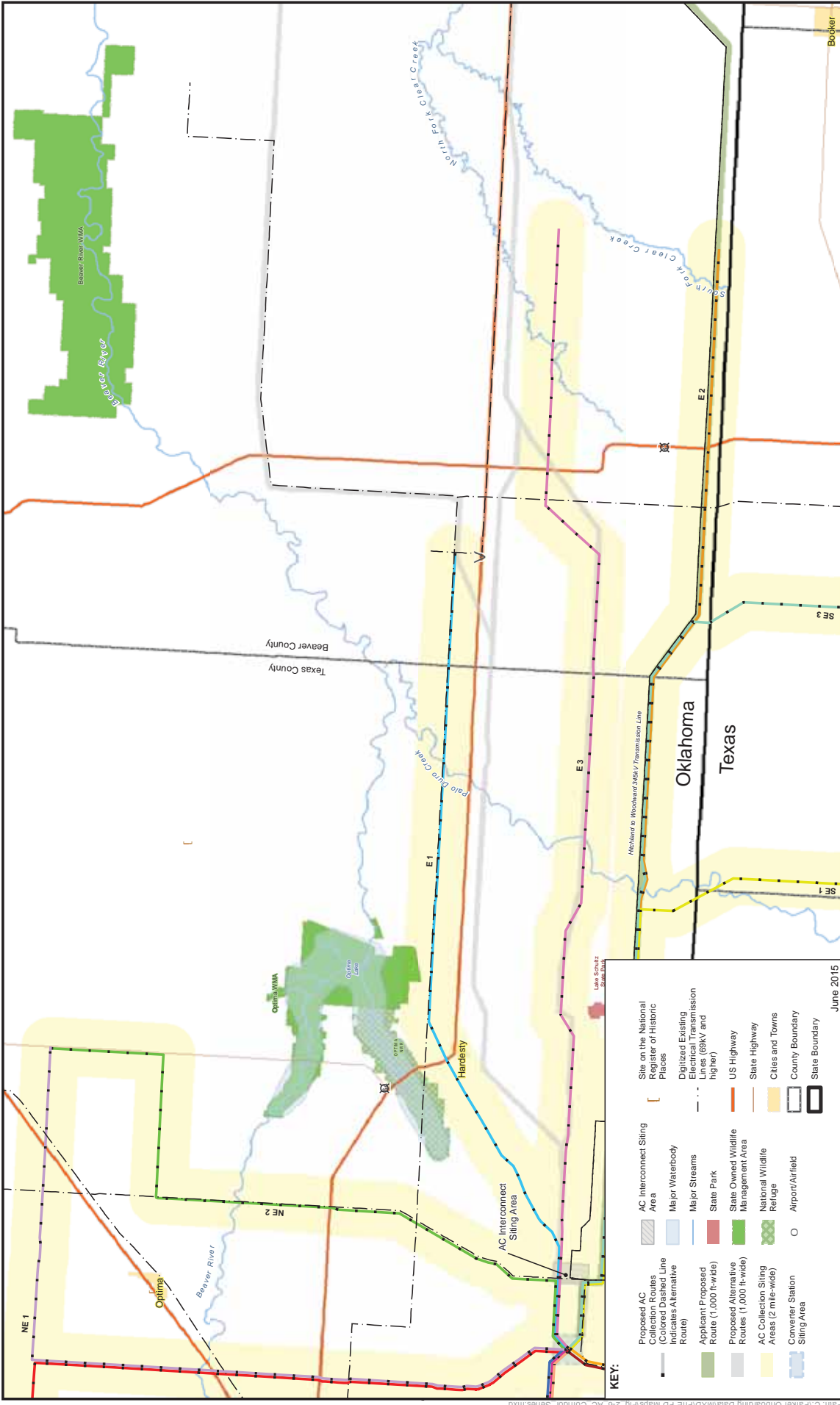

Figure 2-6b

AC Collection System Plains & Eastern Clean Line

Oklahoma and Texas

These Maps and Figures were prepared to assist in determining the route alternatives to be used for the AC Collection System Project. The routes and information included in these Maps and Figures are preliminary and may be subject to revision based on new and/or additional information and input from DOE and/or others. No confidential data is depicted.

Data Sources: ESRI 2010 and 2012; USFS 2003, 2009a, 2009b and 2010; USFWS 2012a and 2012b; USFWS 2012c; USFWS 2012d; USFWS 2012e; USFWS 2012f; USFWS 2012g; USFWS 2012h; USFWS 2012i; USFWS 2012j; USFWS 2012k; USFWS 2012l; USFWS 2012m; USFWS 2012n; USFWS 2012o; USFWS 2012p; USFWS 2012q; USFWS 2012r; USFWS 2012s; USFWS 2012t; USFWS 2012u; USFWS 2012v; USFWS 2012w; USFWS 2012x; USFWS 2012y; USFWS 2012z; USFWS 2013; ANRC n.d.(b) and n.d.(c); USDA Natural Resources Conservation Service (NRCS) n.d.; The Conservation Registry 2012; USACE Little Rock District and USACE Tulsa District, n.d.; NPS 2010; FAA 2010; BFS 2008; Clean Line 2013e and 2013f.

June 2015

0 5 10 Miles
0 5 10 Kilometers

1:200,000
Date: 6/22/2015

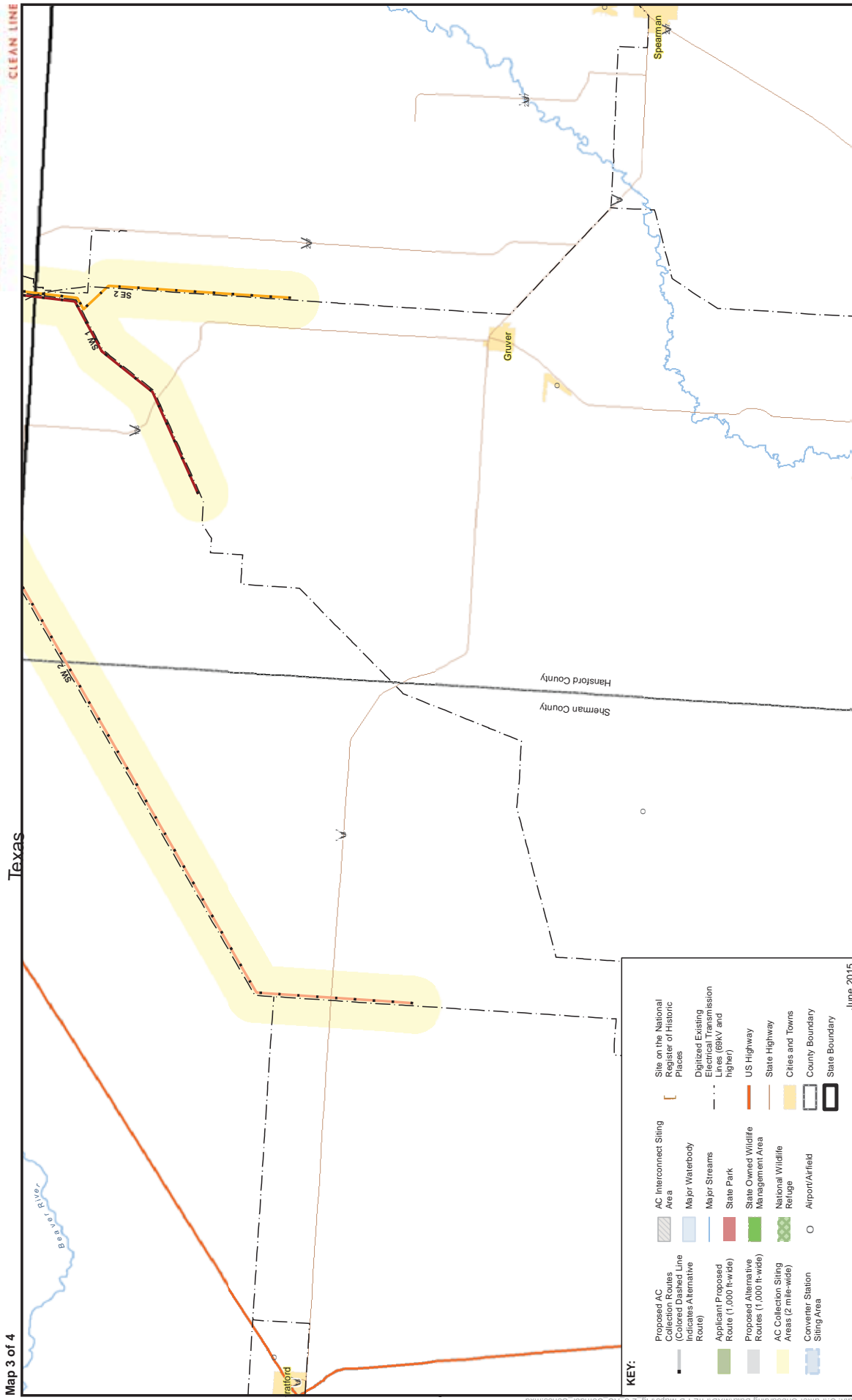

Map 3 of 4

Figure 2-6c
AC Collection System
Plains & Eastern Clean Line
Oklahoma and Texas

These Maps and Figures were prepared to assist in determining the route alternatives to be used for the Plains & Eastern Clean Line Project. The routes and information included in these Maps and Figures are preliminary and may be subject to revision based on new and/or additional information and input from DOE and/or others. No confidential data is depicted.

Data Sources: ESRI 2010 and 2012; USFS 2003, 2009a, 2009b, and 2010; USFWS 2012a and 2012b; USFWS 2012c; USFWS 2012d; USFWS 2012e; USFWS 2012f; USFWS 2012g; USFWS 2012h; USFWS 2012i; USFWS 2012j; USFWS 2012k; USFWS 2012l; USFWS 2012m; USFWS 2012n; USFWS 2012o; USFWS 2012p; USFWS 2012q; USFWS 2012r; USFWS 2012s; USFWS 2012t; USFWS 2012u; USFWS 2012v; USFWS 2012w; USFWS 2012x; USFWS 2012y; USFWS 2012z; USFWS 2013; ANRC n.d.(a) and n.d.(b); TDEC 2011; Oklahoma Tourism and Recreation Department 2013; ANRC n.d.(c) and n.d.(d); USDA Natural Resources Conservation Service (NRCS) n.d.; The Conservation Registry 2012; USACE Little Rock District and USACE Tulsa District, n.d.; NPS 2010; FAA 2010; BTS 2008; Clean Line 2013a and 2013b, 1

KEY:

- Proposed AC Routes (Colored Dashed Line)
- Indicates Alternative Route
- Applicant Proposed Route (1,000 ft-wide)
- Proposed Alternative Routes (1,000 ft-wide)
- AC Collection Siting Areas (2-mile-wide)
- AC Interconnect Siting Area
- Major Waterbody
- Major Streams
- State Park
- State Owned Wildlife Management Area
- National Wildlife Refuge
- Airport/Airfield
- Siting Area
- Site on the National Register of Historic Places
- Digitized Existing Electrical Transmission Lines (69kV and Higher)
- US Highway
- State Highway
- Cities and Towns
- County Boundary
- State Boundary

June 2015

0 5 10 Miles
0 5 10 Kilometers

1:200,000
Date: 6/22/2015

PLAINS & EASTERN CLEAN LINE

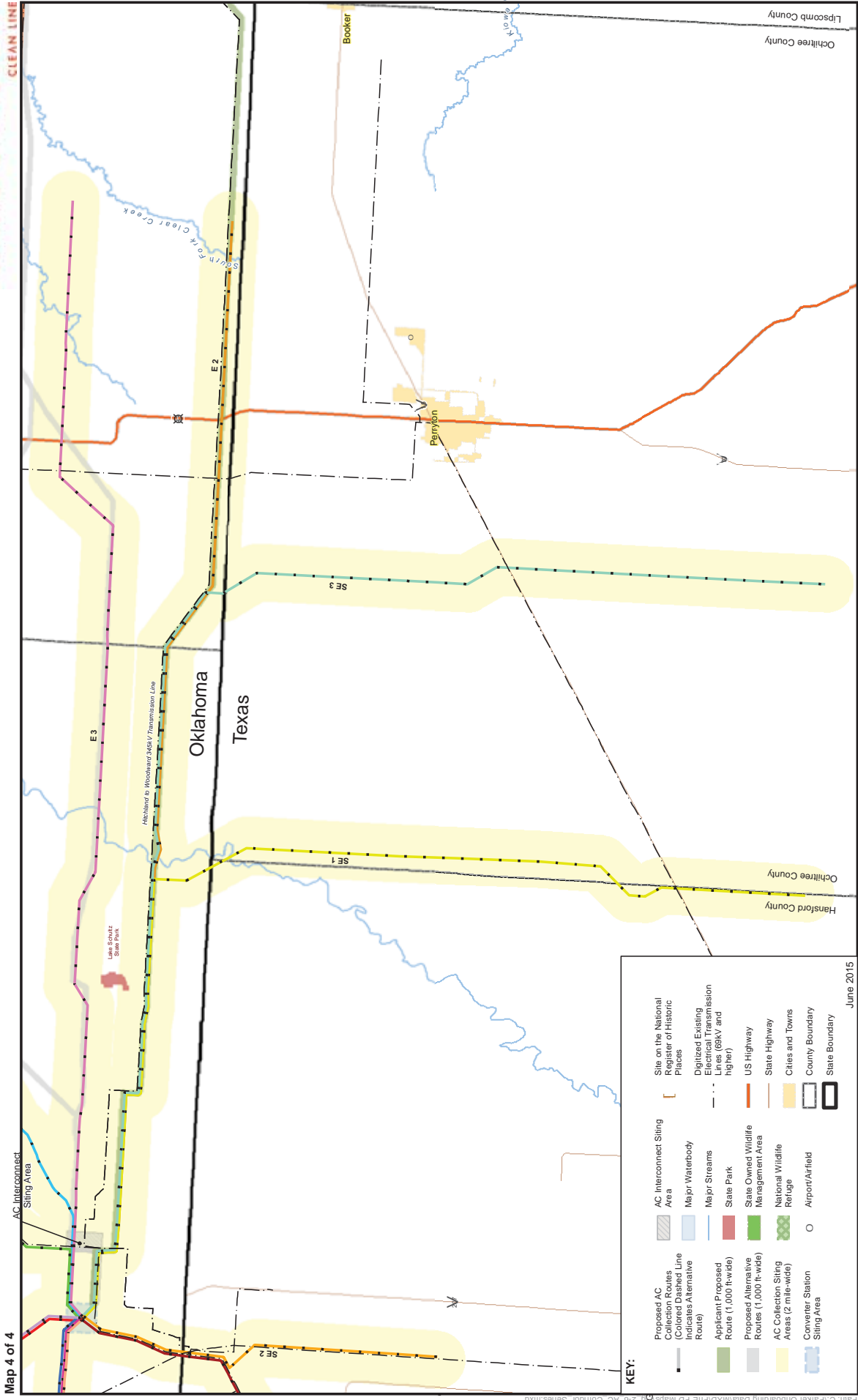

Map 4 of 4

KEY:

- Proposed AC Routes (Colored Dashed Line)
- Indicates Alternative Route
- Aplicant Proposed Route (1,000 ft-wide)
- Proposed Alternative Routes (1,000 ft-wide)
- AC Collection Siting Areas (2 mile-wide)
- Converter Station Siting Area
- AC Interconnect Siting Area
- Major Waterbody
- Major Streams
- State Park
- State Owned Wildlife Management Area
- National Wildlife Refuge
- Site on the National Register of Historic Places
- Digitized Existing Electrical Transmission Lines (69kV and higher)
- US Highway
- State Highway
- Cities and Towns
- County Boundary
- State Boundary

Scale: 0 to 10 Miles / 0 to 10 Kilometers

Date: June 2015

Figure 2-6d
AC Collection System
Plains & Eastern Clean Line
 Oklahoma and Texas

These Maps and Figures were prepared to assist in determining the route alternatives to be used for the AC Collection System for the Plains and Eastern Clean Line Project. The routes and information included in these Maps and Figures are preliminary and may be subject to revision based on new and/or additional information and input from DOE and/or others. No confidential data is depicted.

Data Sources: ESRI 2010 and 2012; USFS 2003, 2009a, 2009b and 2010; USFWS 2012a and 2012b; USFWS 2012c; USFWS 2012d; USFWS 2012e; USFWS 2012f; USFWS 2012g; USFWS 2012h; USFWS 2012i; USFWS 2012j; USFWS 2012k; USFWS 2012l; USFWS 2012m; USFWS 2012n; USFWS 2012o; USFWS 2012p; USFWS 2012q; USFWS 2012r; USFWS 2012s; USFWS 2012t; USFWS 2012u; USFWS 2012v; USFWS 2012w; USFWS 2012x; USFWS 2012y; USFWS 2012z; USFWS 2013; ANRC n.d.(b) and n.d.(c); TDEC 2011; Oklahoma Tourism and Recreation Department 2013; ANRC n.d.(b) and n.d.(c); USACE Little Rock District and USACE Tulsa District, n.d.; The Conservation Registry 2012; USACE Little Rock District and USACE Tulsa District, n.d.; NPS 2010; FAA 2010; BFS 2008; Clean Line 2013a and 2013b, 1

1:200,000
 Date: 6/22/2015

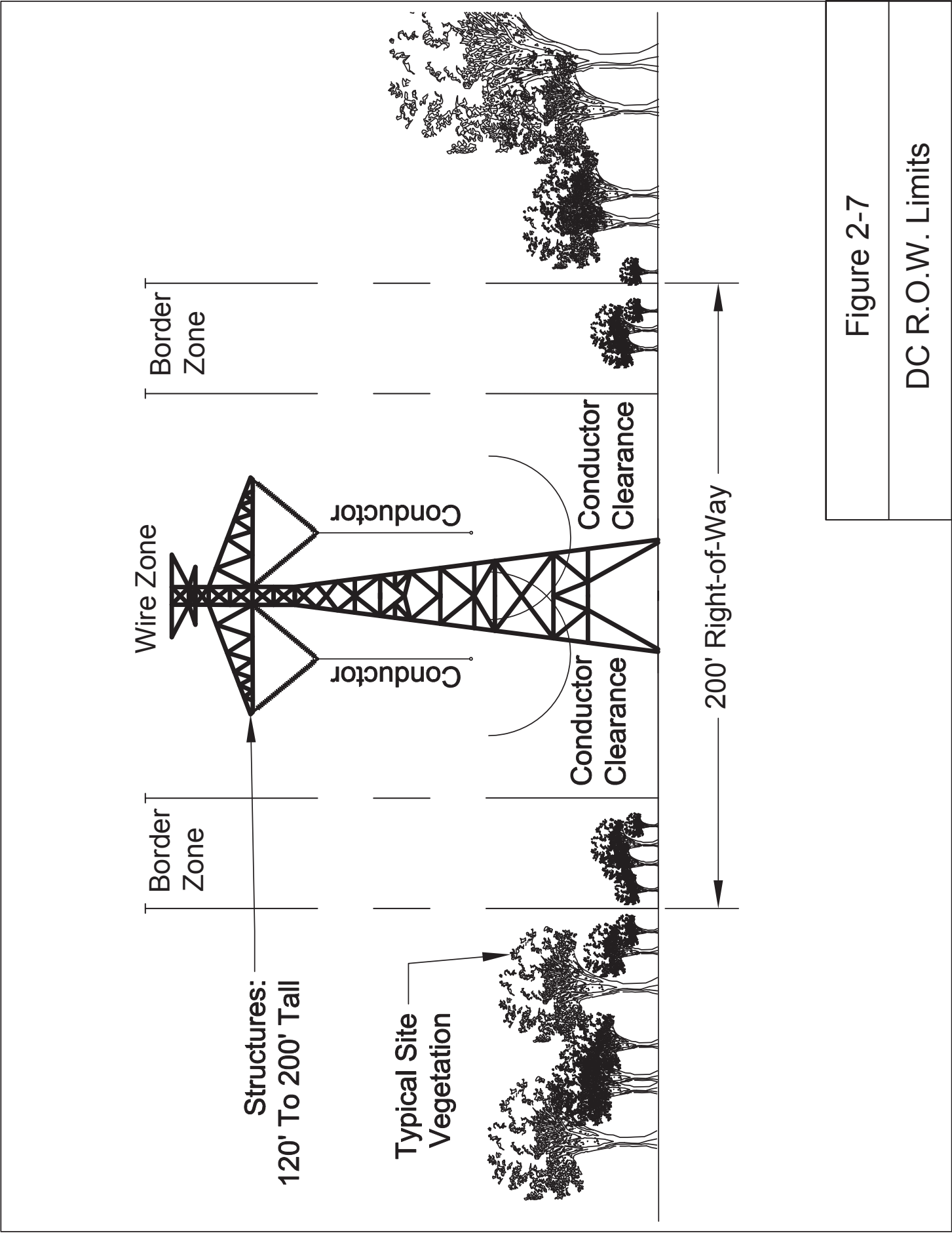

Figure 2-7

DC R.O.W. Limits

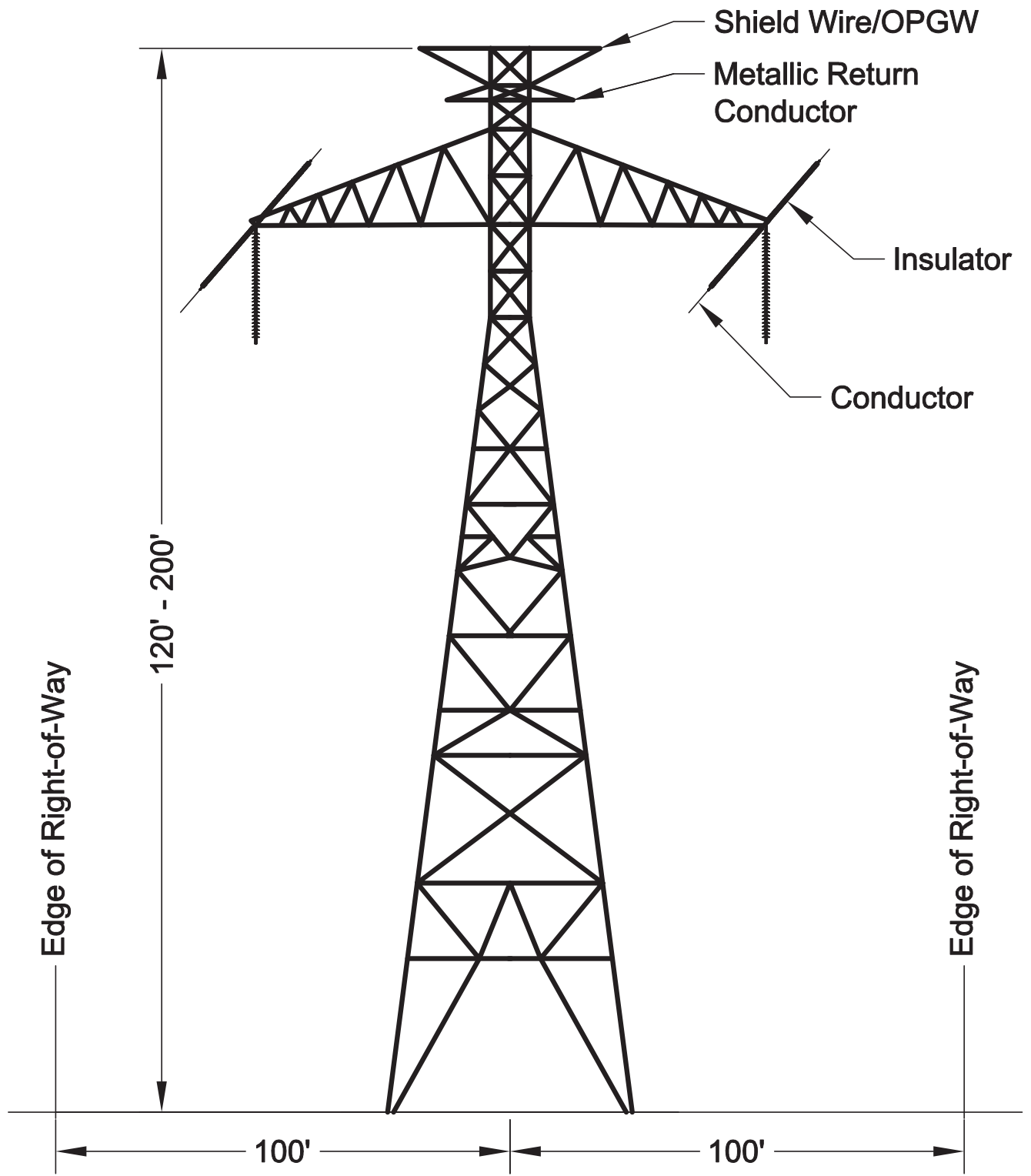

Figure 2-8a

600kV Lattice Deadend

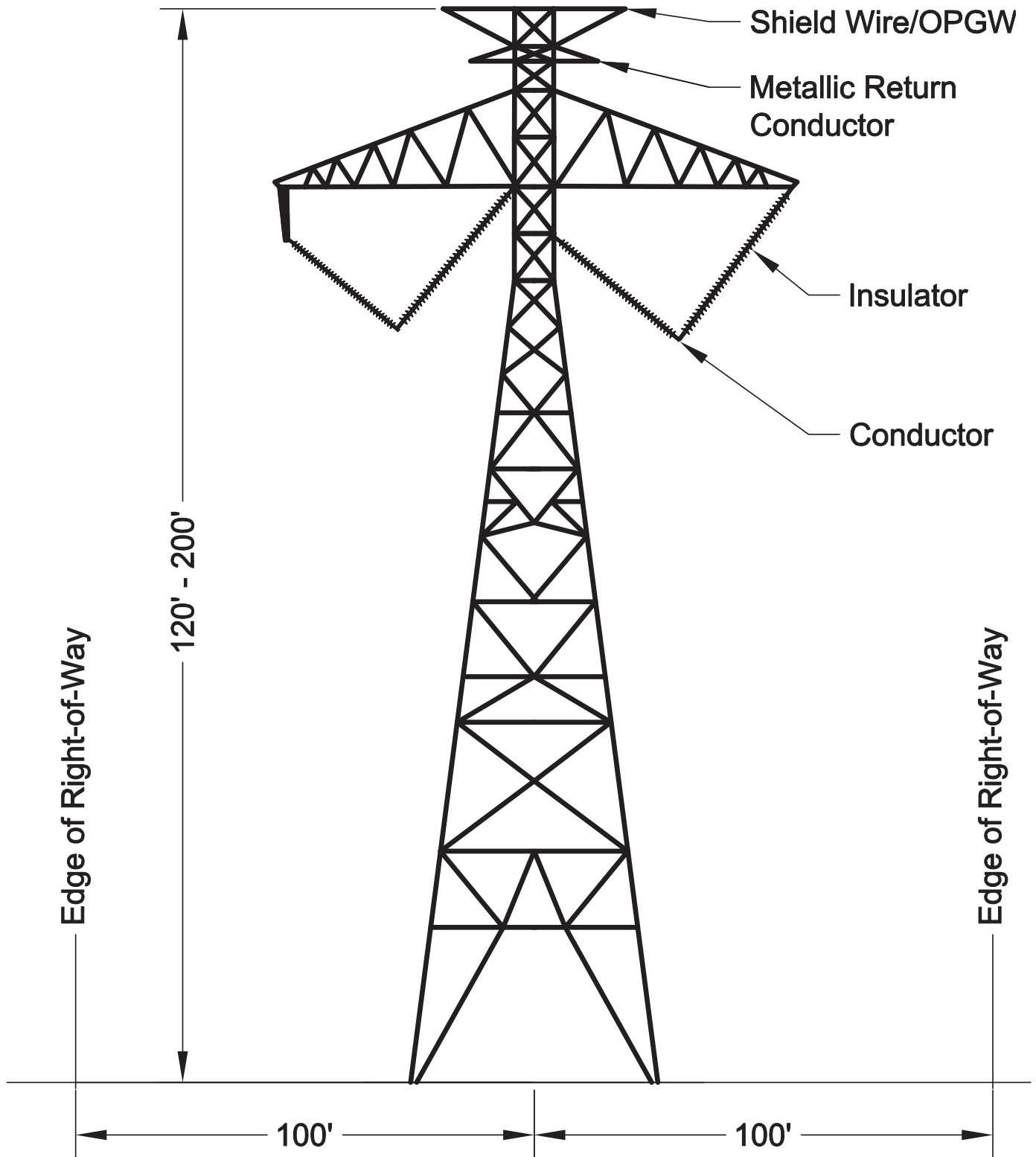

Figure 2-8b

600kV Lattice Running Angle

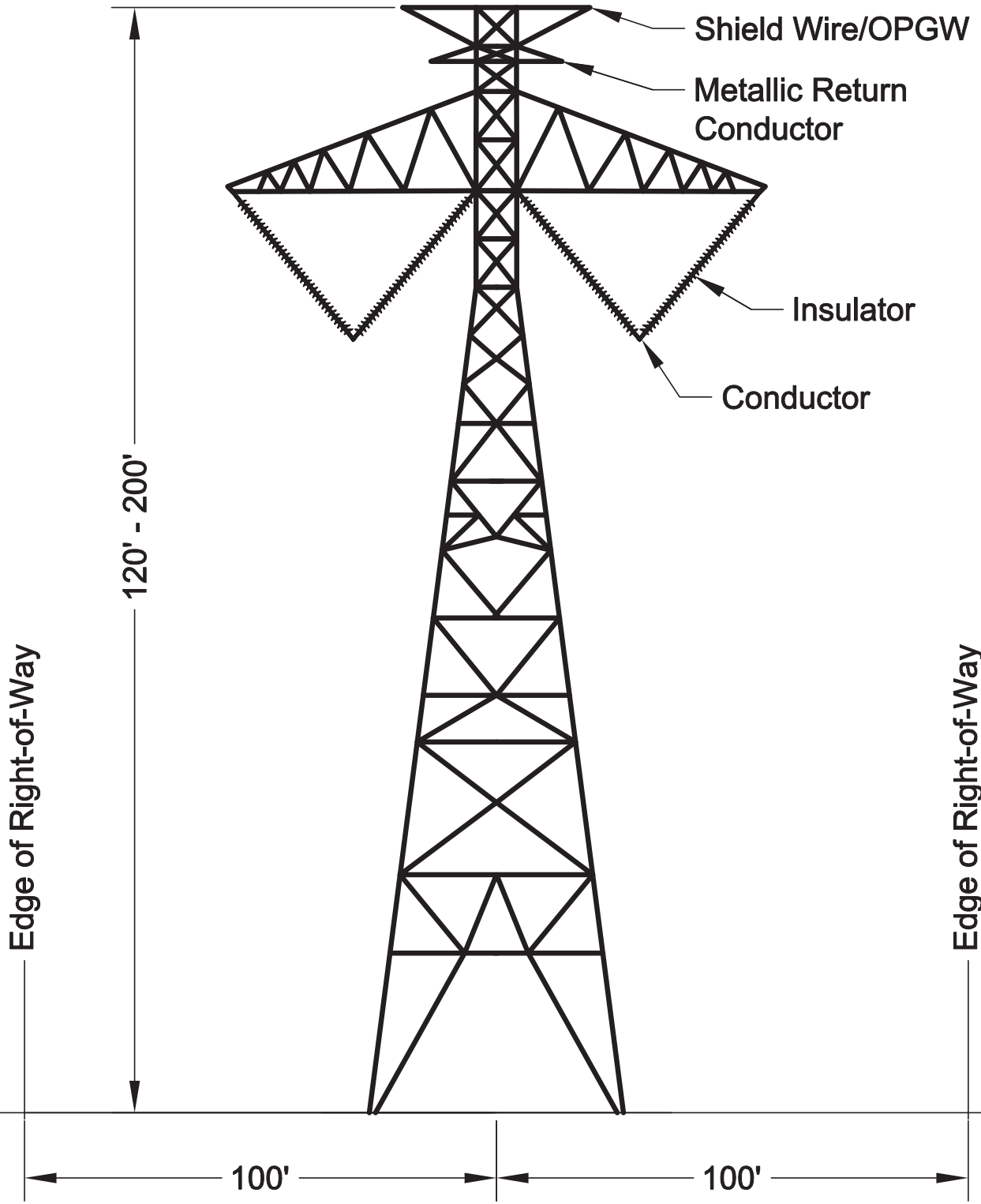
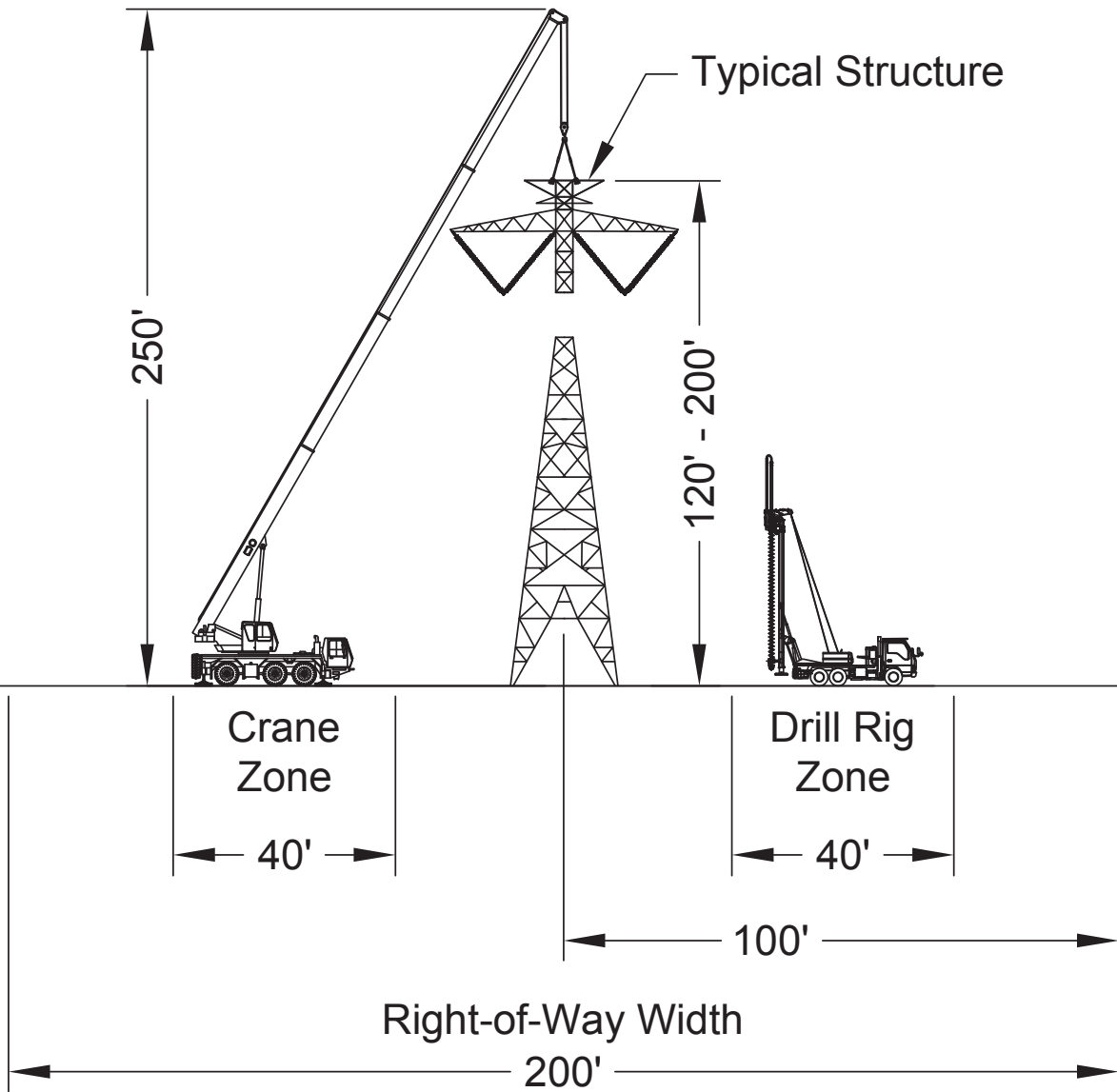

Figure 2-8c

600kV Lattice Tangent



Note: All Dimension Are Typical

Figure 2-9

600kV DC Lattice Work Area

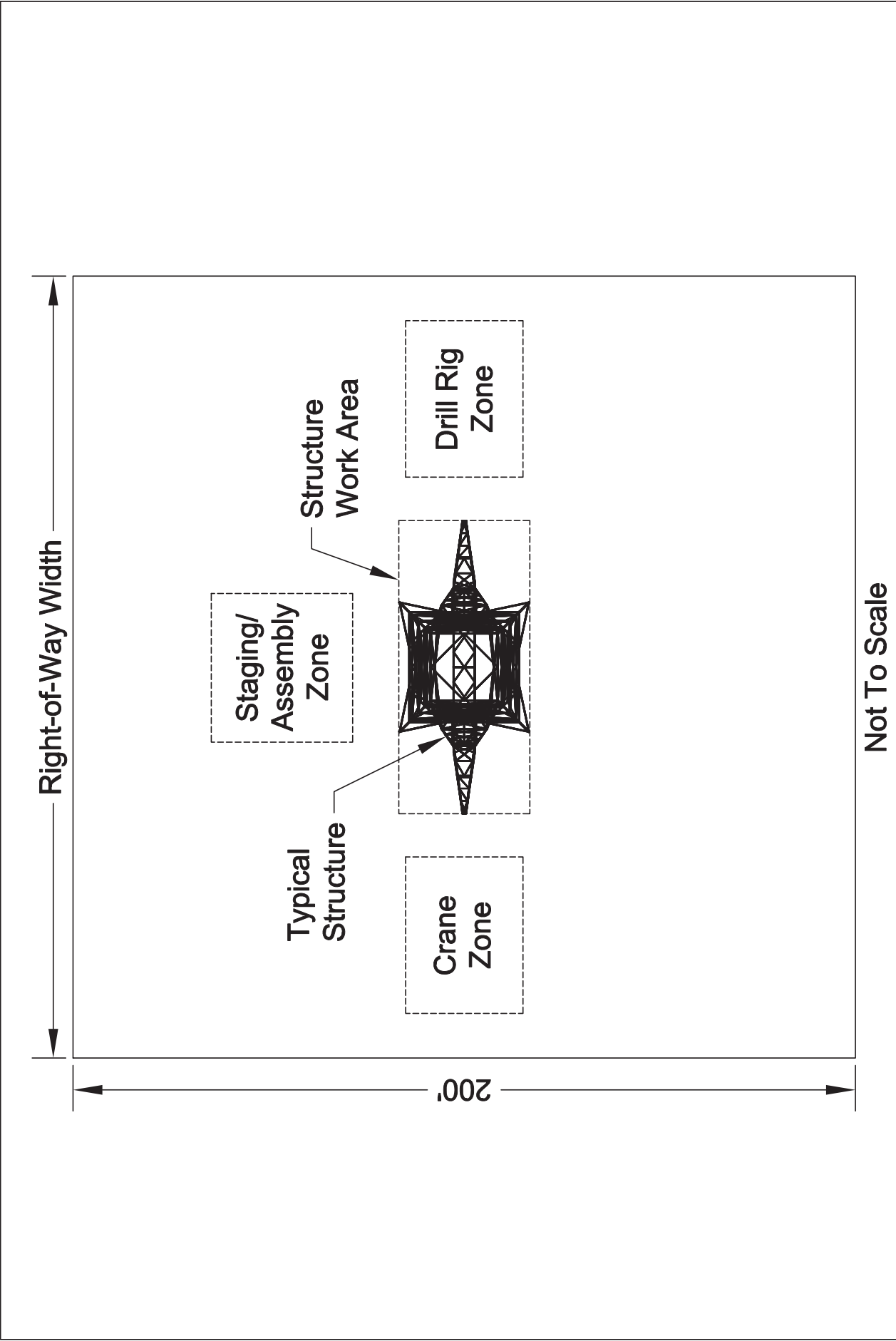

Not To Scale

Figure 2-10
 600kV DC Lattice Foundation and Structure
 Construction Activities - Plan View

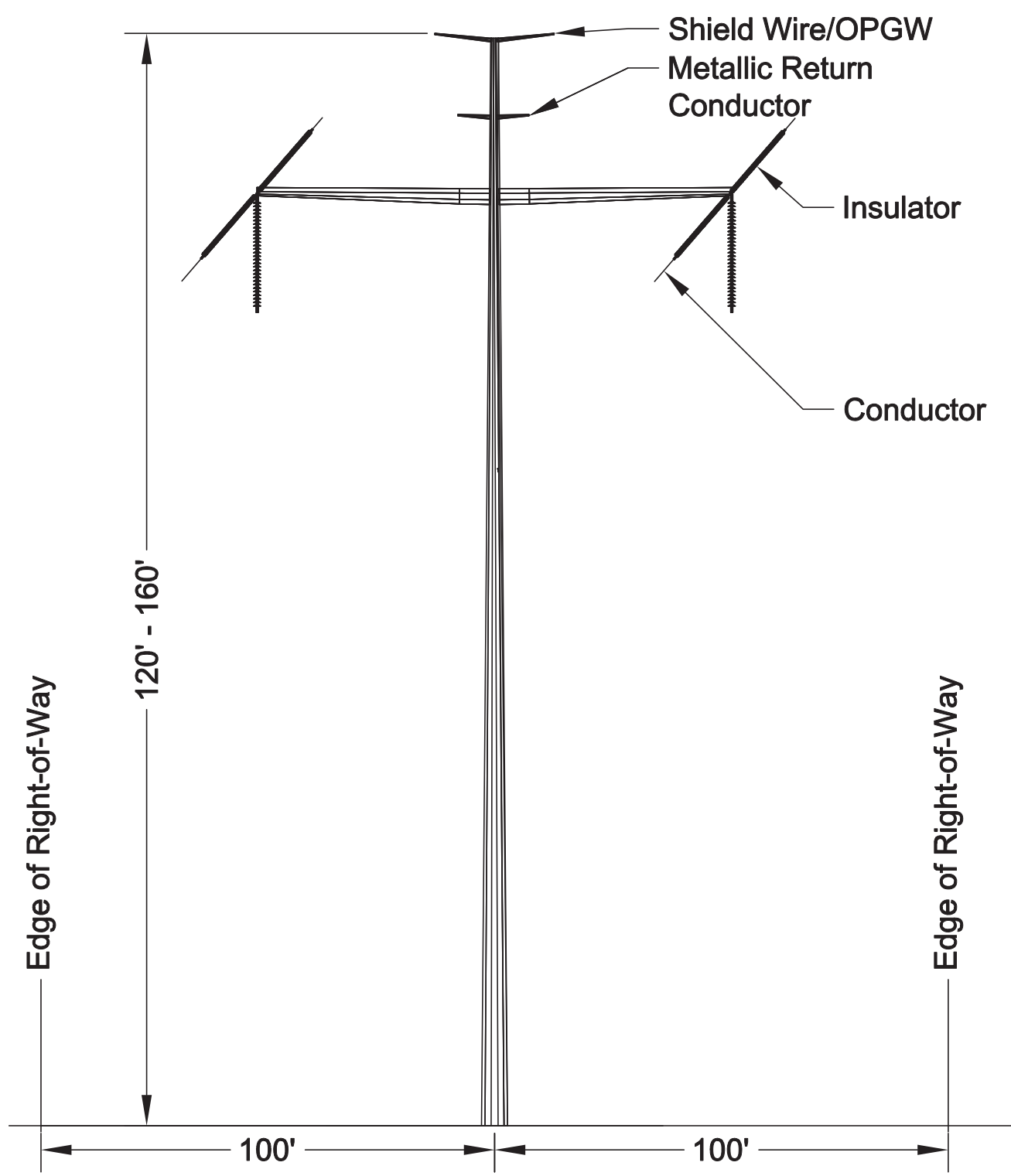

Figure 2-11a
600kV Monopole Deadend

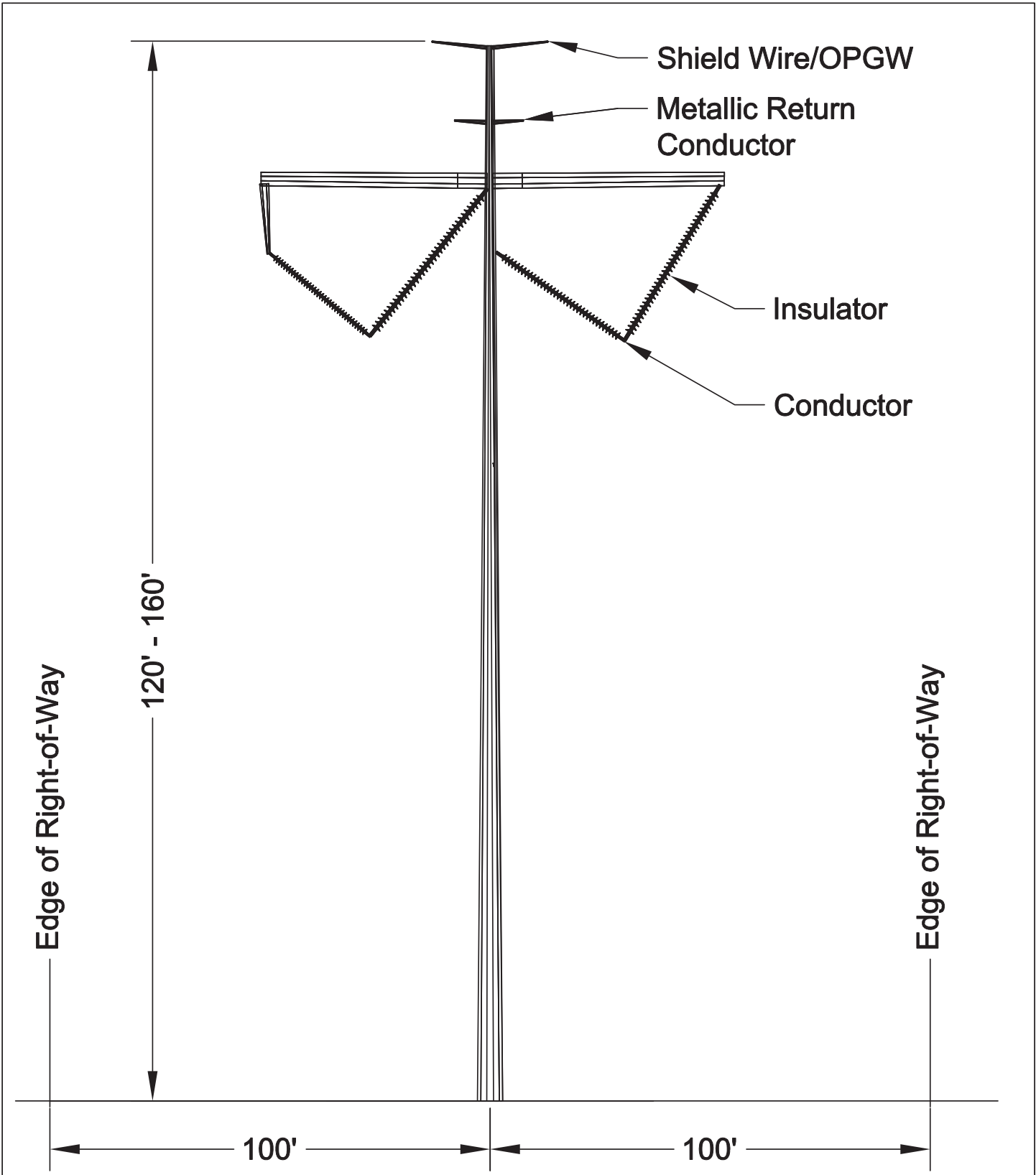

Figure 2-11b
600kV Monopole Running Angle

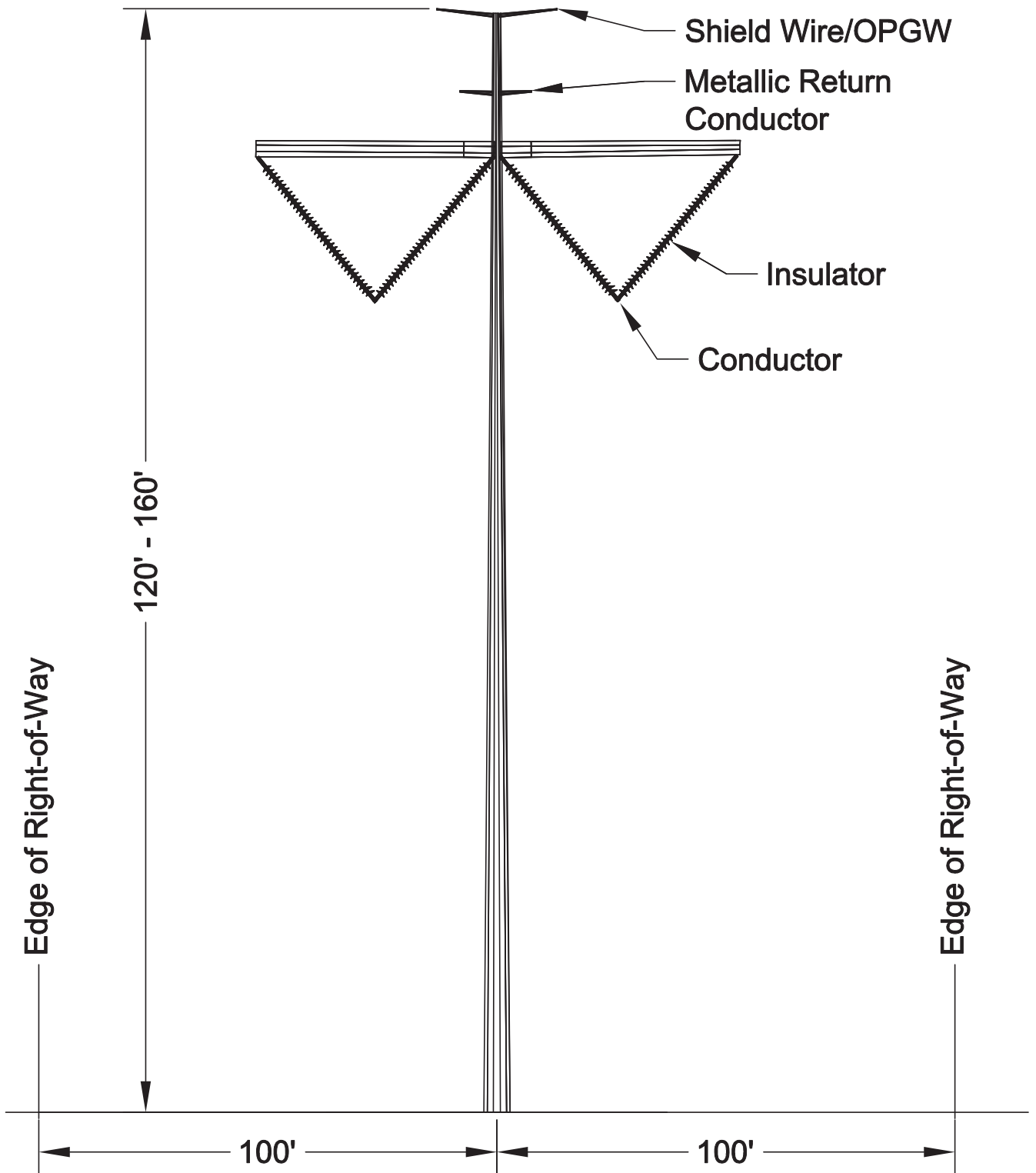

Figure 2-11c

600kV Monopole Tangent

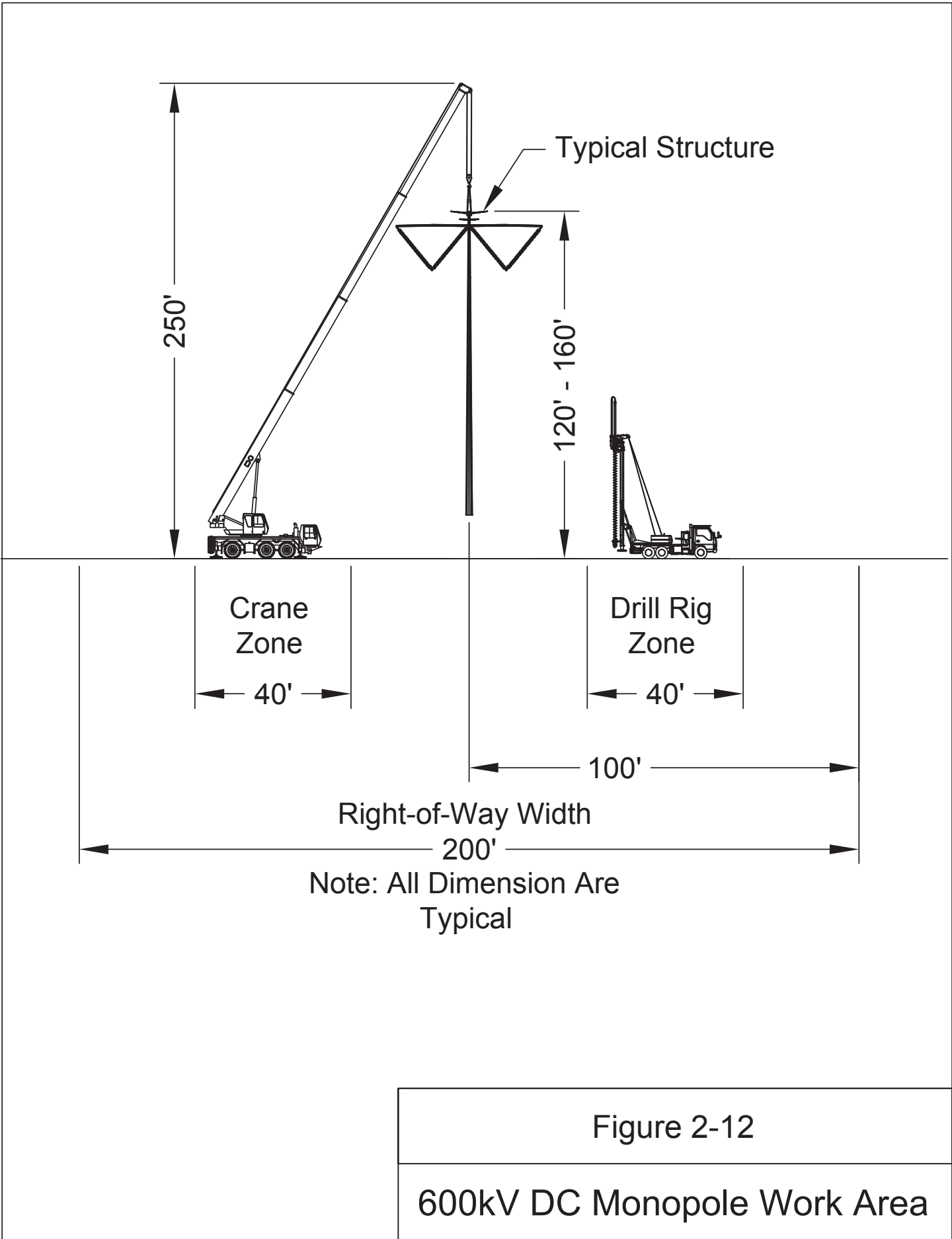
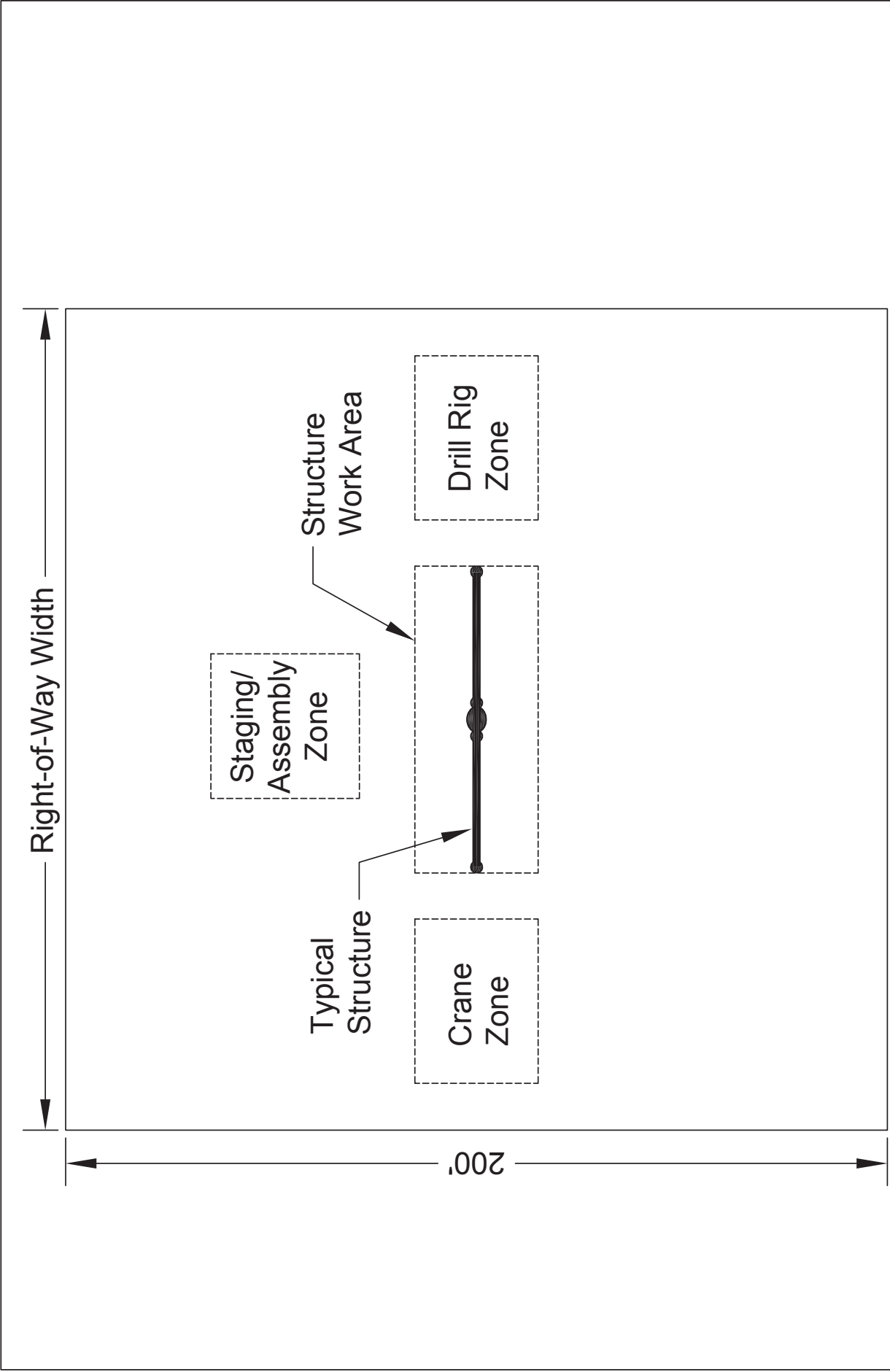

Figure 2-12

600kV DC Monopole Work Area



Not To Scale

Figure 2-13

600kV DC Monopole Foundation and Structure
Construction Activities - Plan View

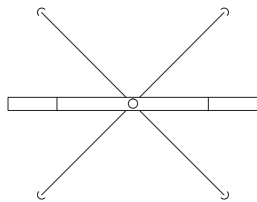

PLAN VIEW

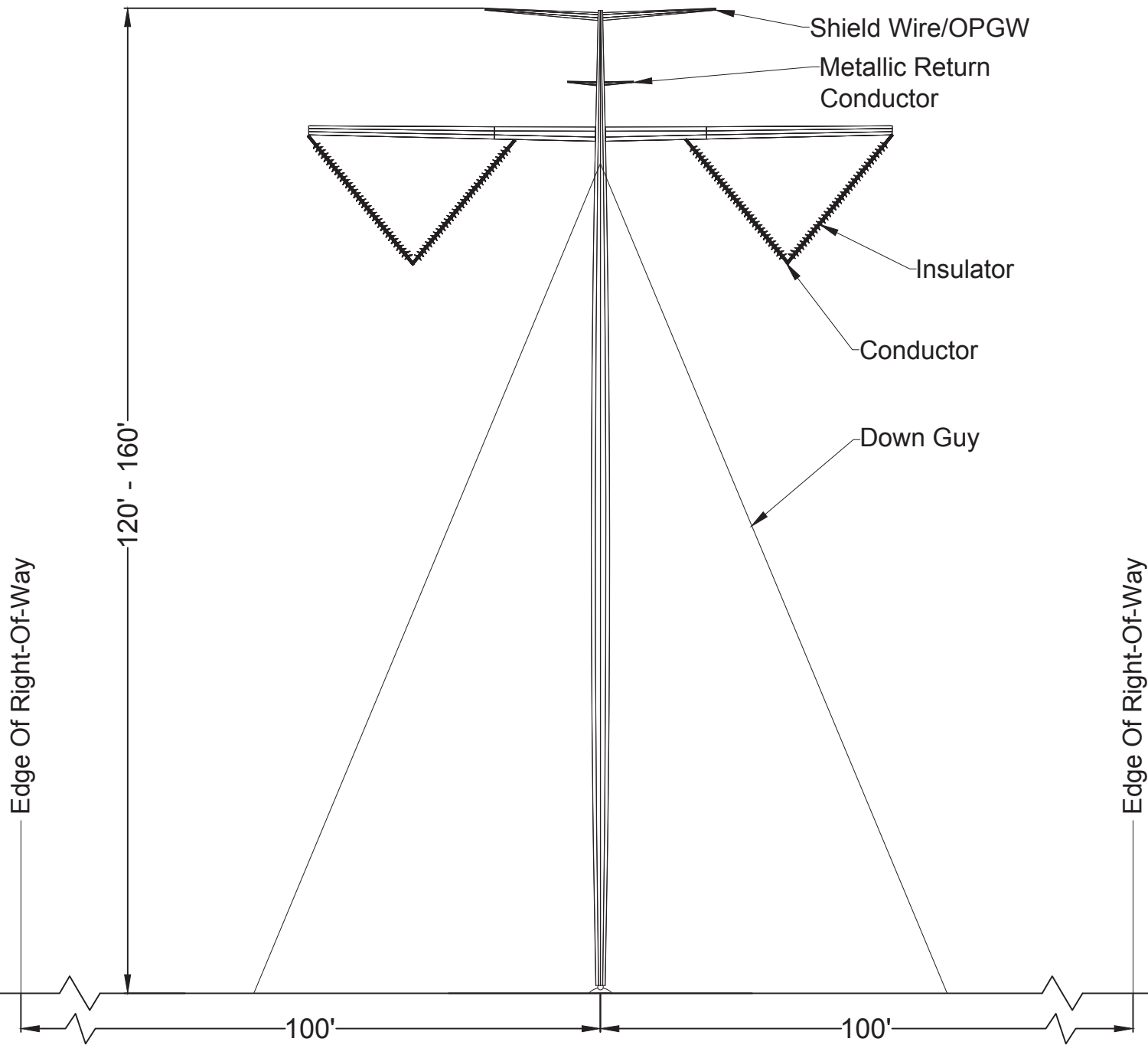

ELEVATION VIEW

NOT TO SCALE

NOTE:
 DEPENDING ON STRUCTURE HEIGHT AND LINE ANGLE, GUY
 EASEMENTS MAY BE REQUIRED BEYOND THE PROJECT 200
 FOOT RIGHT-OF-WAY.

Figure 2-14a

600kV Guyed Mast Tubular Tangent

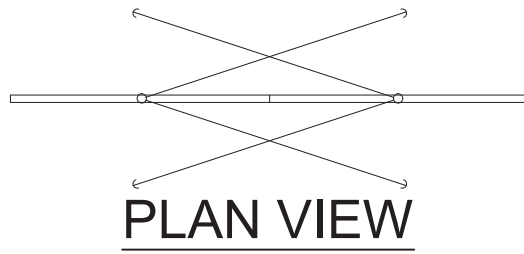

PLAN VIEW

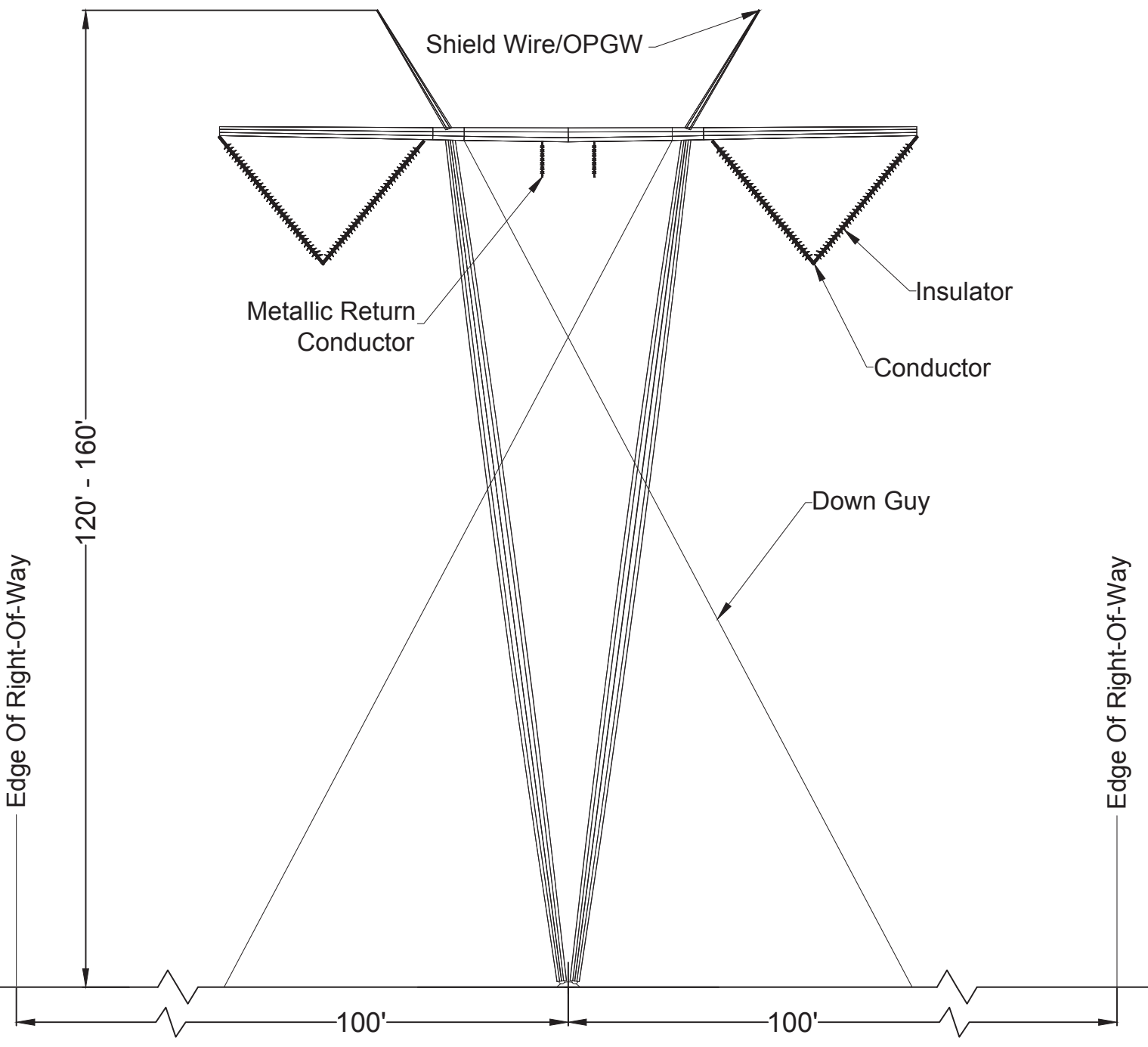

ELEVATION VIEW

NOT TO SCALE

NOTE:
 DEPENDING ON STRUCTURE HEIGHT AND LINE ANGLE, GUY
 EASEMENTS MAY BE REQUIRED BEYOND THE PROJECT 200
 FOOT RIGHT-OF-WAY.

Figure 2-14b

600kV Gayed V-Tube Tangent

PLAN VIEW

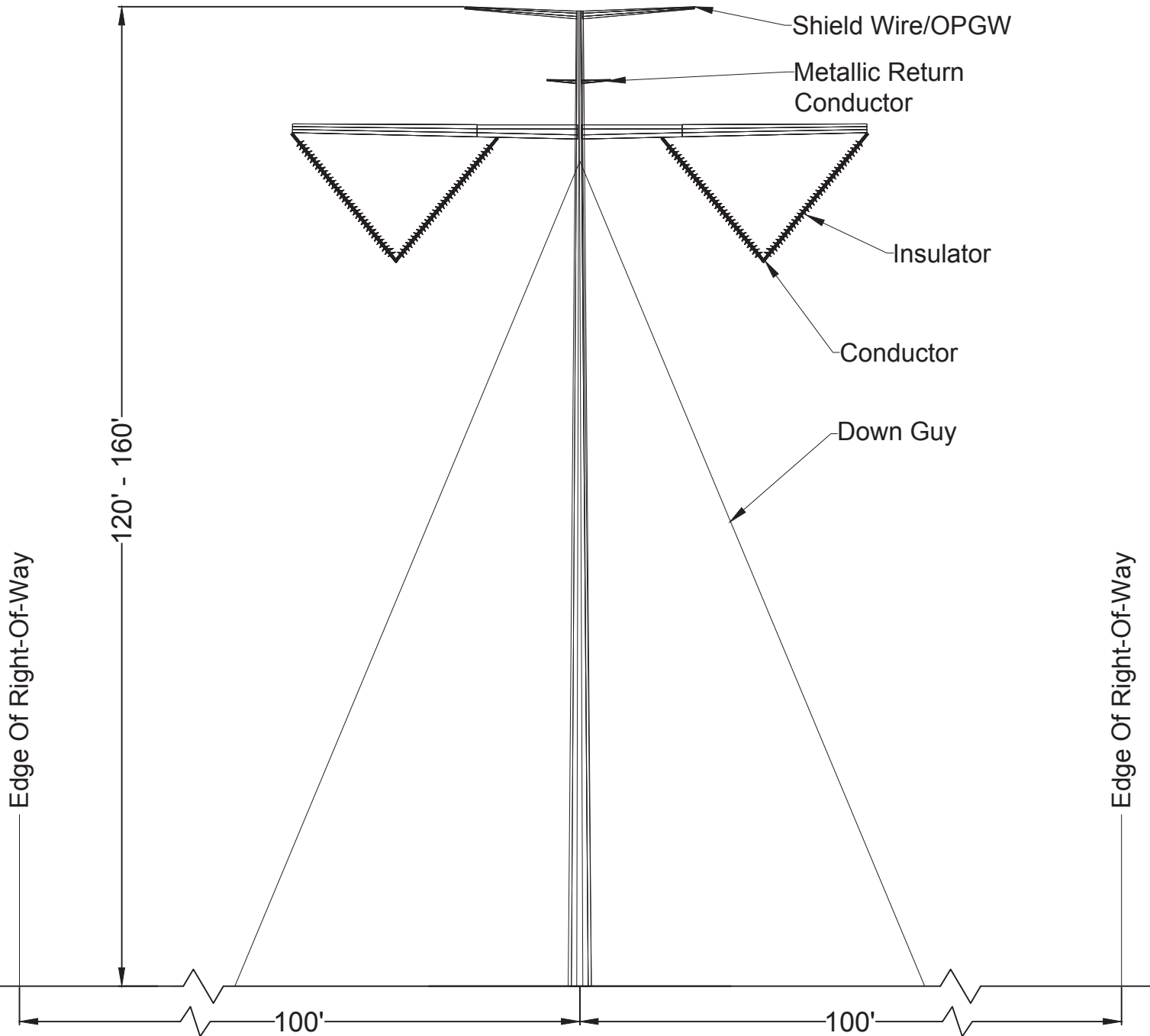

ELEVATION VIEW

NOT TO SCALE

NOTE:
DEPENDING ON STRUCTURE HEIGHT AND LINE ANGLE, GUY
EASEMENTS MAY BE REQUIRED BEYOND THE PROJECT 200
FOOT RIGHT-OF-WAY.

Figure 2-14c

600kV Guyed Monopole Tangent

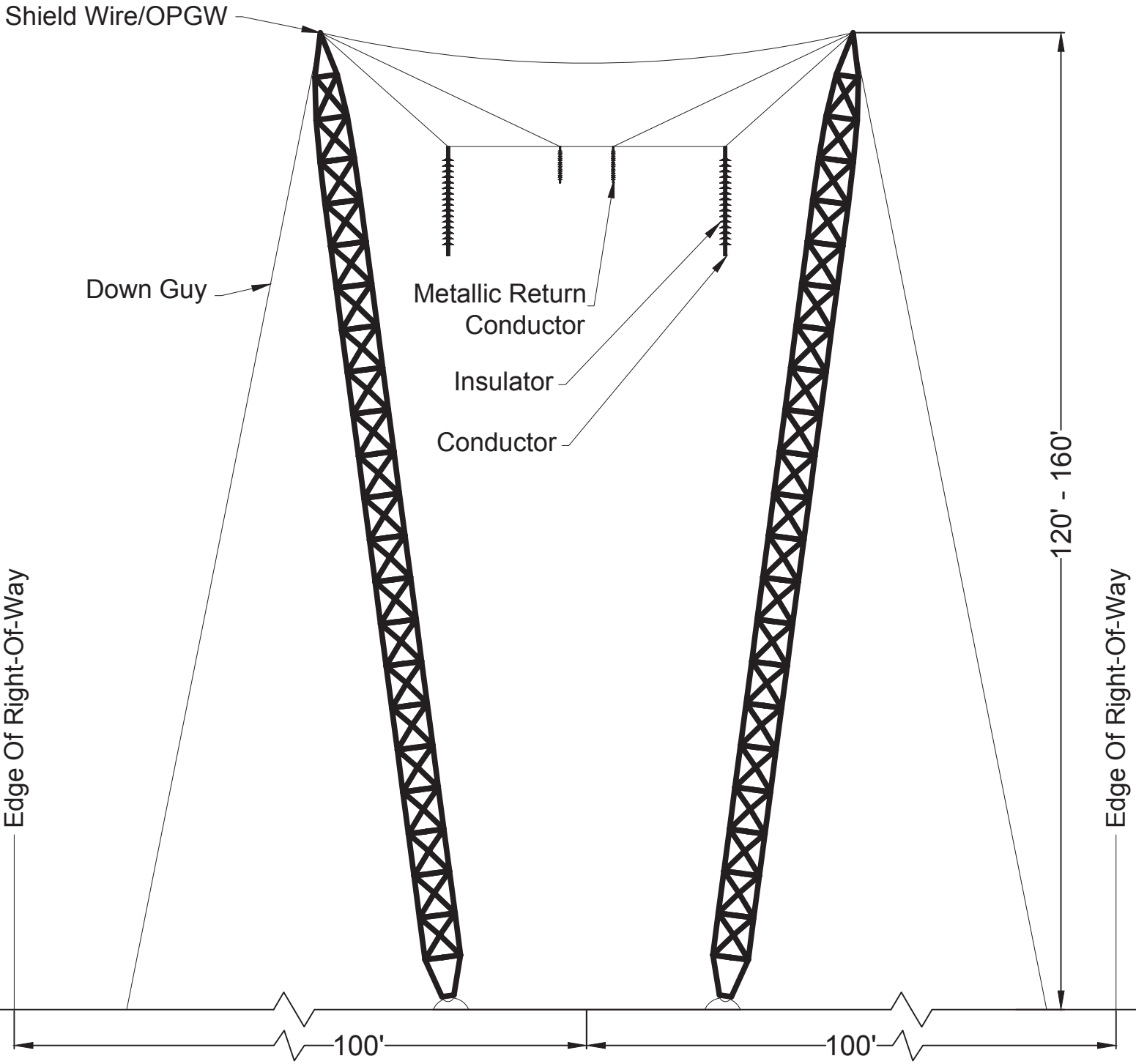
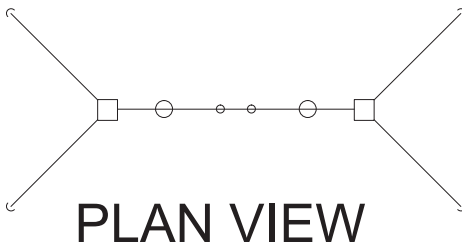

ELEVATION VIEW

NOT TO SCALE

NOTE:
 DEPENDING ON STRUCTURE HEIGHT AND LINE ANGLE, GUY
 EASEMENTS MAY BE REQUIRED BEYOND THE PROJECT 200
 FOOT RIGHT-OF-WAY.

Figure 2-14d

600kV Guyed Chainette Tangent

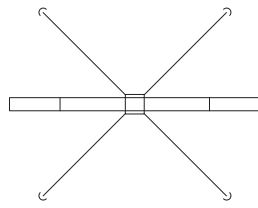

PLAN VIEW

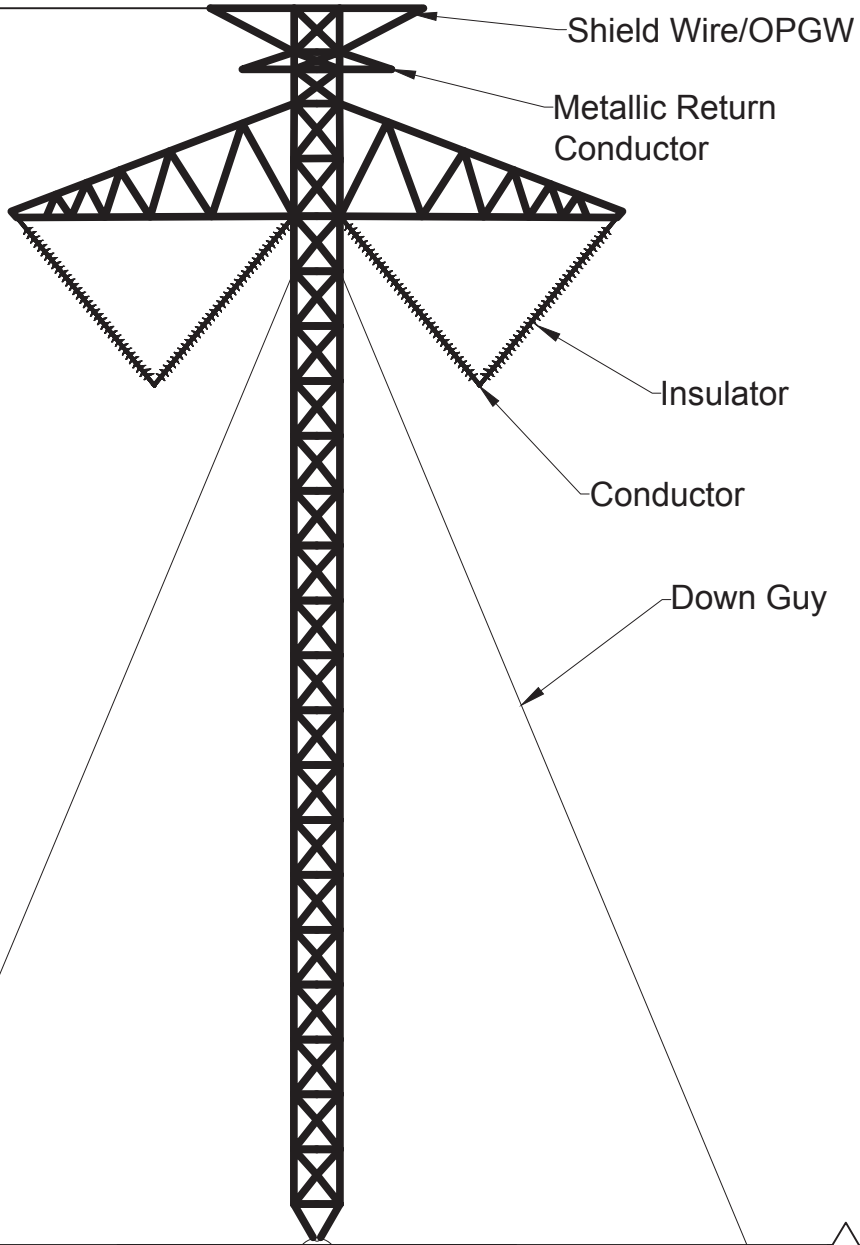

120' - 200'

Edge Of Right-Of-Way

Edge Of Right-Of-Way

100'

100'

ELEVATION VIEW

NOT TO SCALE

NOTE:
 DEPENDING ON STRUCTURE HEIGHT AND LINE ANGLE, GUY
 EASEMENTS MAY BE REQUIRED BEYOND THE PROJECT 200
 FOOT RIGHT-OF-WAY.

Figure 2-14e

600kV Guyed Mast Lattice Tangent

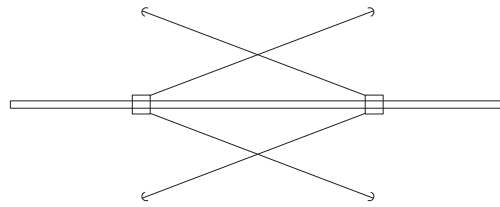

PLAN VIEW

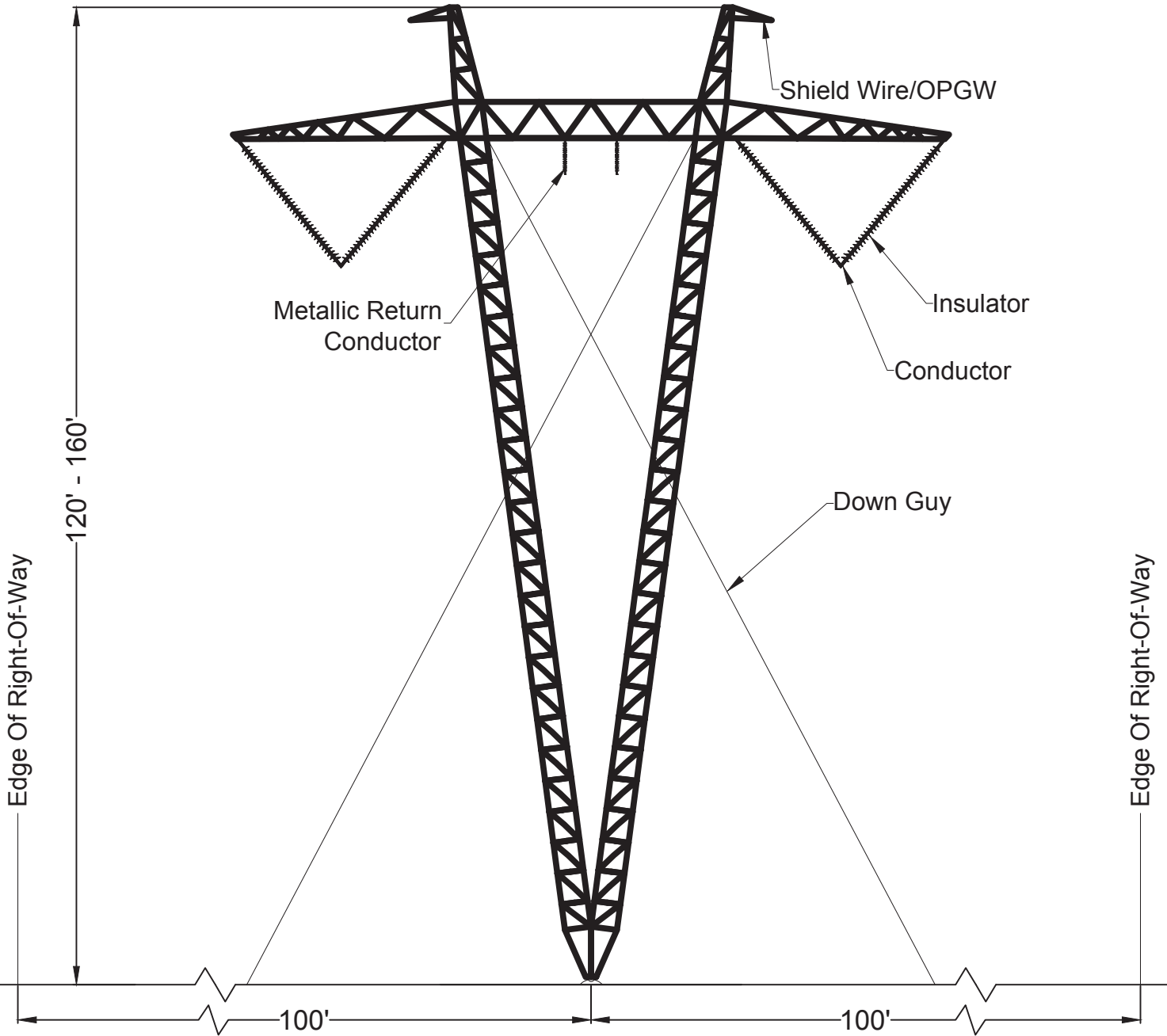

ELEVATION VIEW

NOT TO SCALE

NOTE:
 DEPENDING ON STRUCTURE HEIGHT AND LINE ANGLE, GUY
 EASEMENTS MAY BE REQUIRED BEYOND THE PROJECT 200
 FOOT RIGHT-OF-WAY.

Figure 2-14f

600kV Guyed V-Lattice Tangent

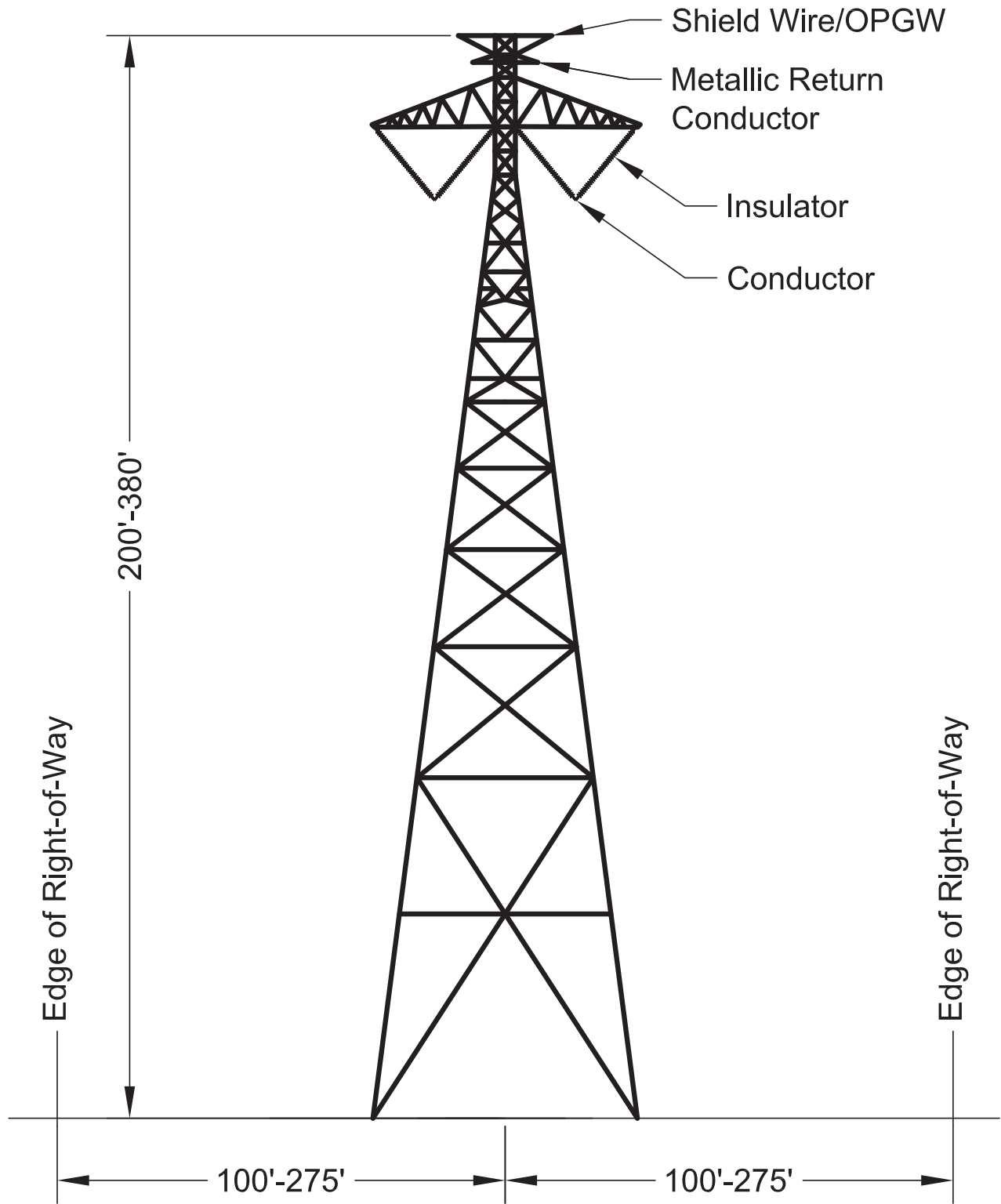
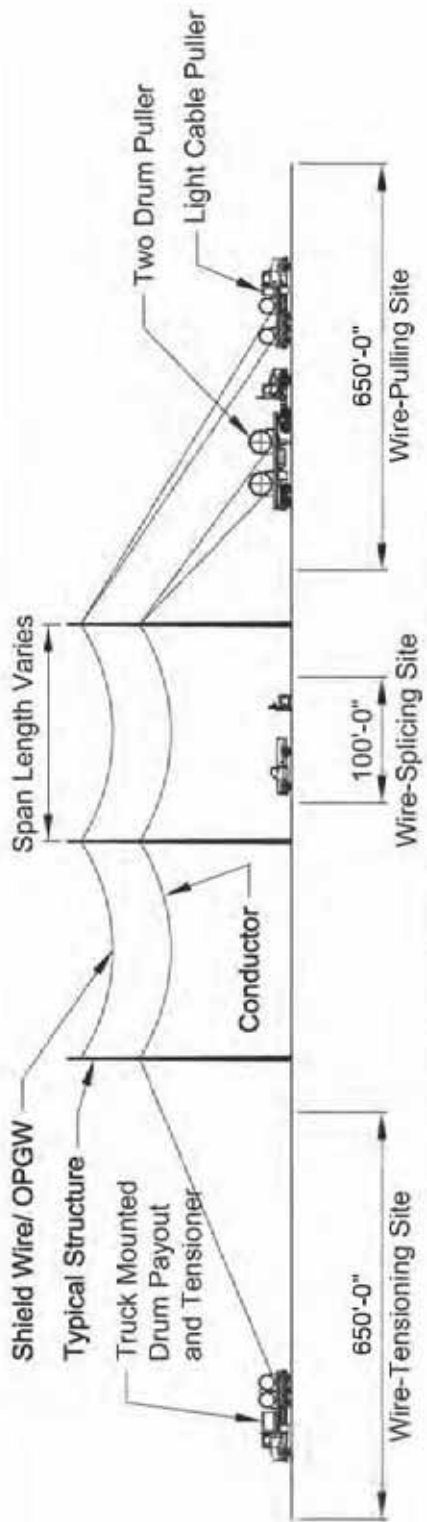
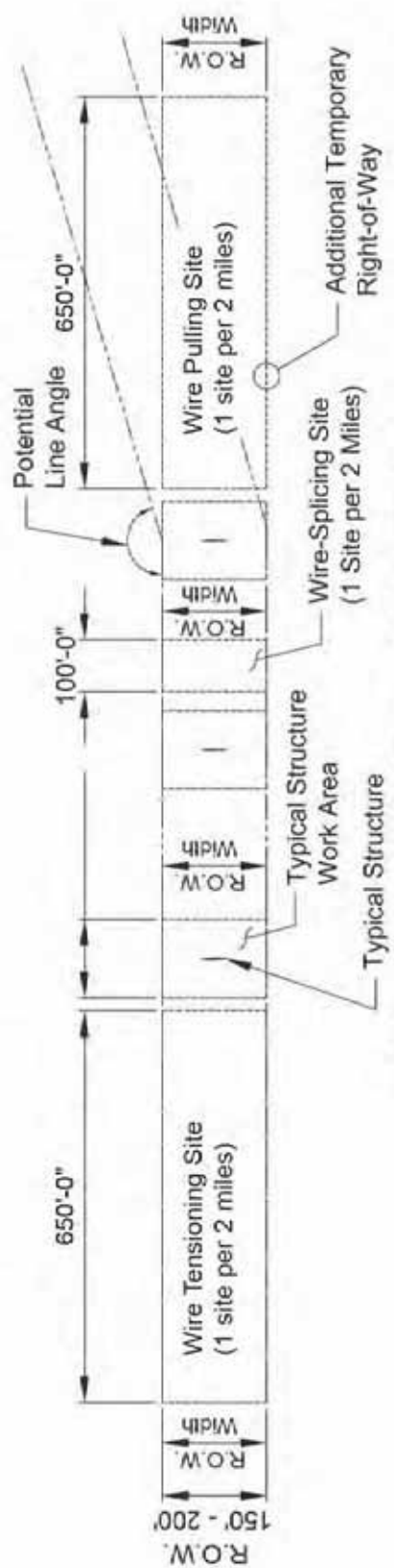

Figure 2-15

600kV Lattice Crossing Structure



Conductor and Ground-Wire Stringing Activities - Profile View
Not To Scale



Conductor and Ground-Wire Stringing Activities - Plan View
Note To Scale

Figure 2-16

Conductor and Ground-Wire Stringing Activities

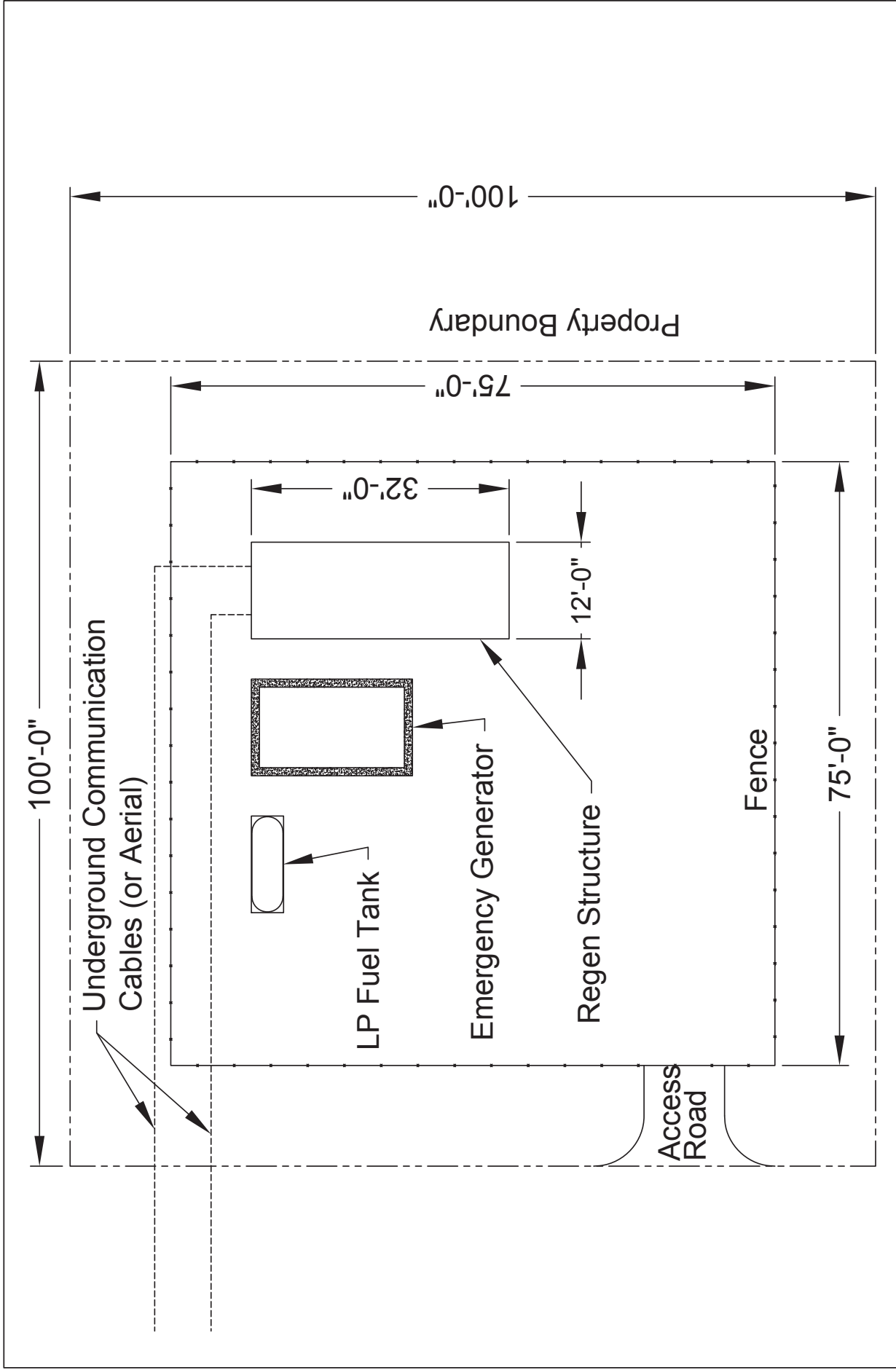
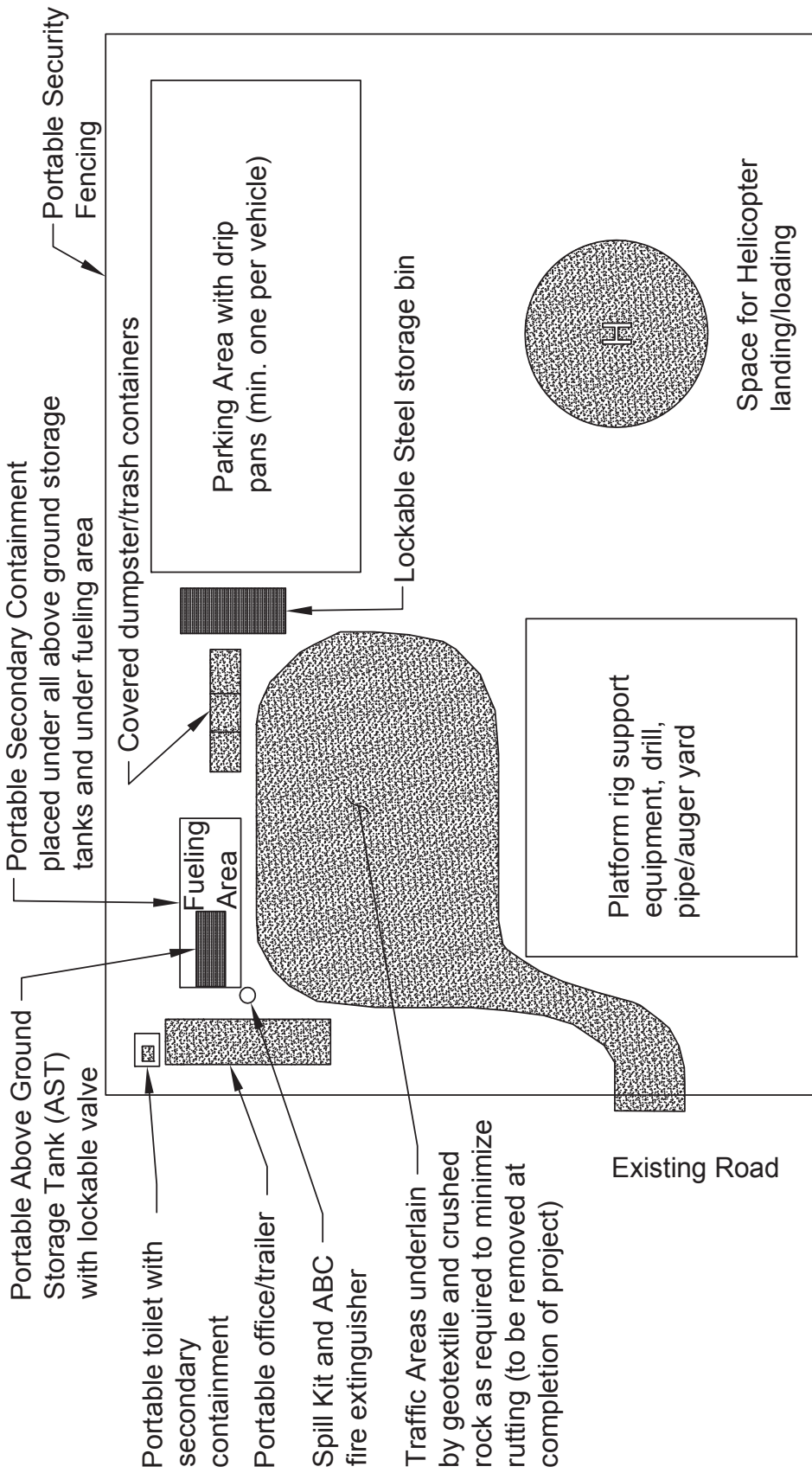

Figure 2-17
Regeneration Station Plan

Typical Multi-Use Construction Yard Schematic Plan (Not To Scale)



Notes:

- Individual, Multi-Use Areas may be arranged differently but all sites will typically include areas designated for field office, crew parking and sanitation, waste management, fueling area, material storage, and equipment storage.
- Fuel trucks, maintenance trucks and construction crews will be based in Multi-Use Areas.
- Vehicle wash stations may be located at multi use yards.
- Multi-Use Areas can also be used as fly yards (landing areas for helicopters) when needed for assembly and erection of tower sections prior to transport to final structure location.
- Staging areas will be reclaimed unless otherwise directed by landowner by removing all element from the site, raking, repairing ruts and seeding disturbed areas.

Figure 2-18

Multi-Use Construction Yard

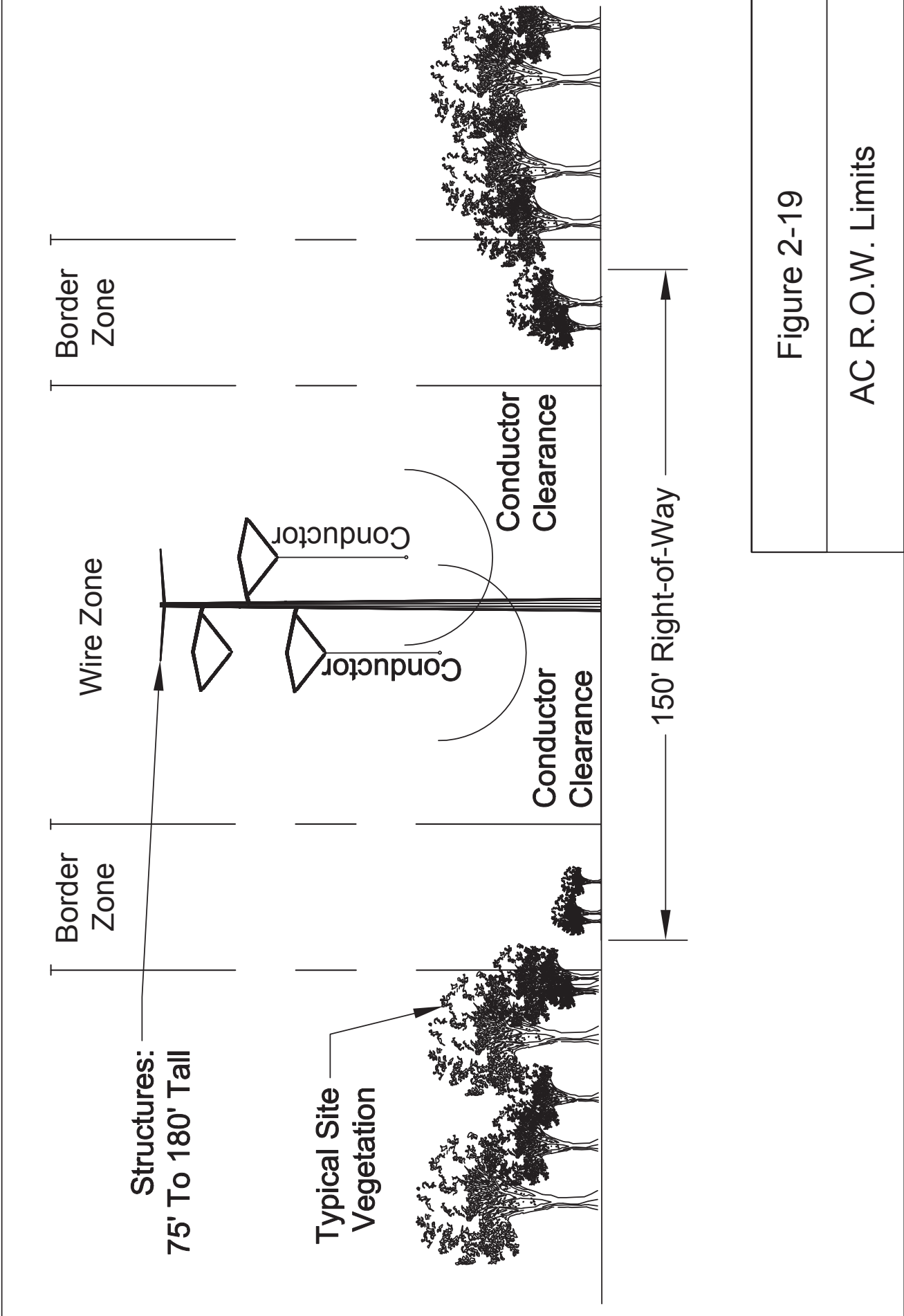

Figure 2-19
AC R.O.W. Limits

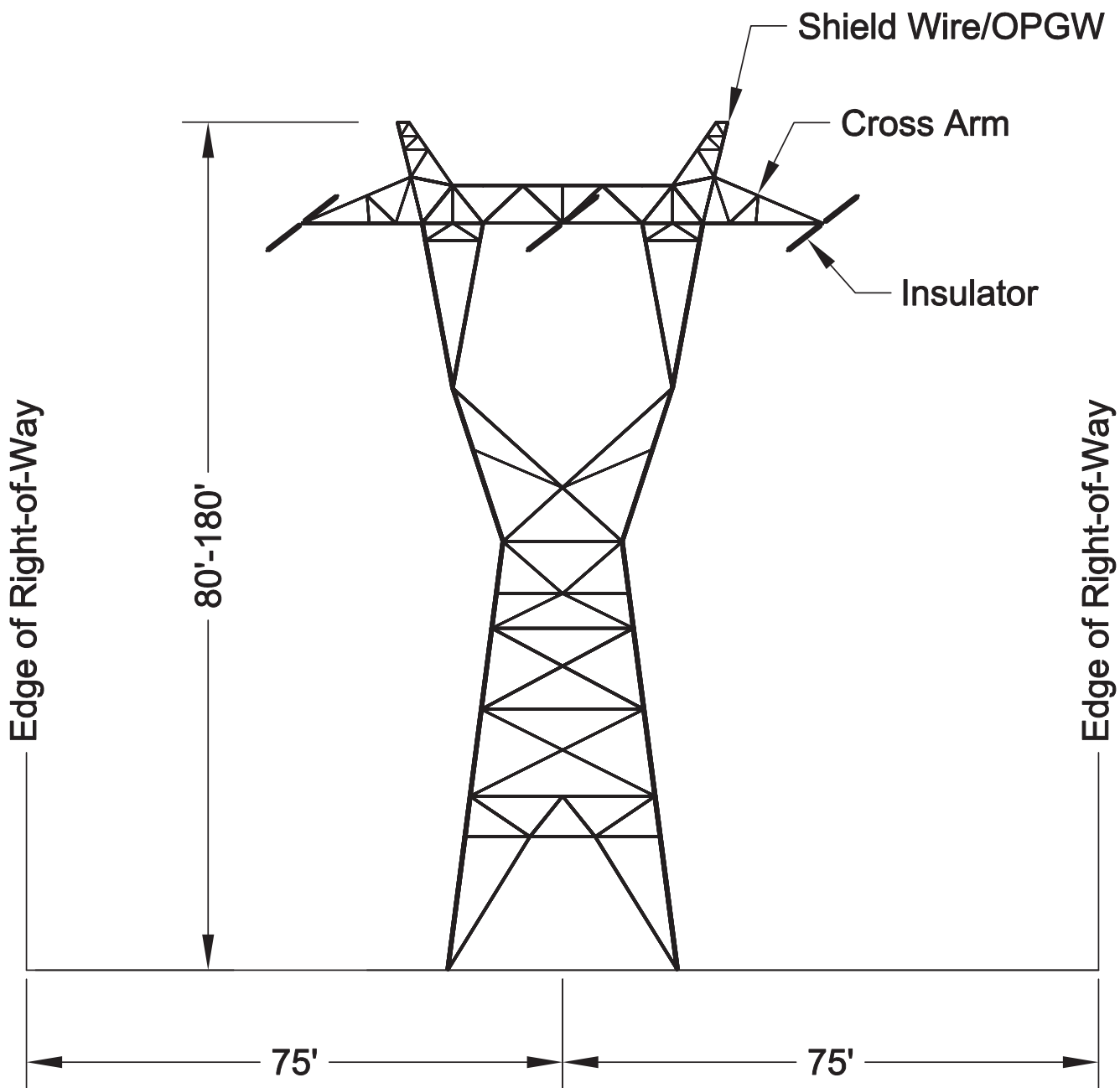

Figure 2-20a

345kV Lattice Deadend

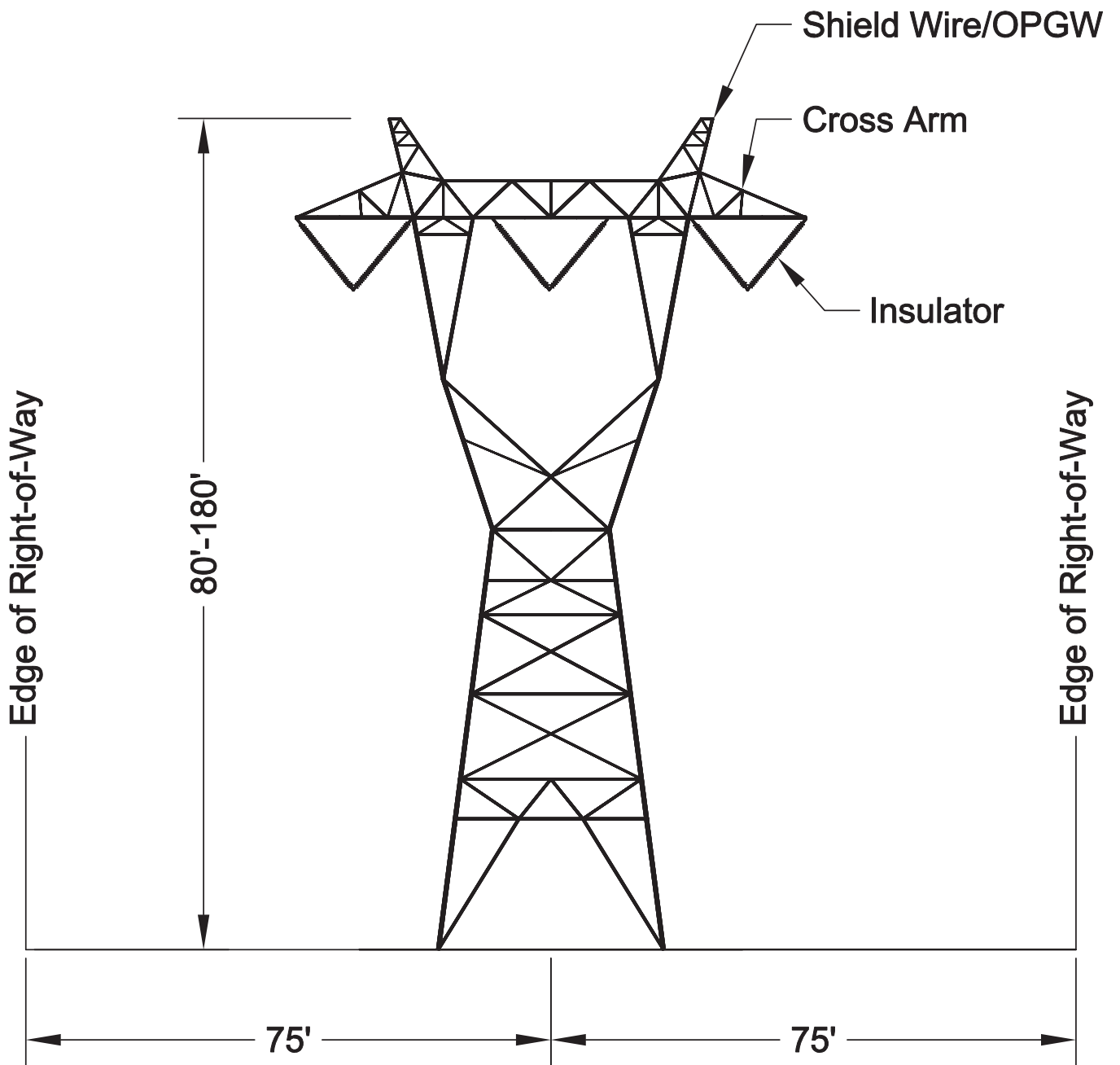

Figure 2-20b

345kV Lattice V-String

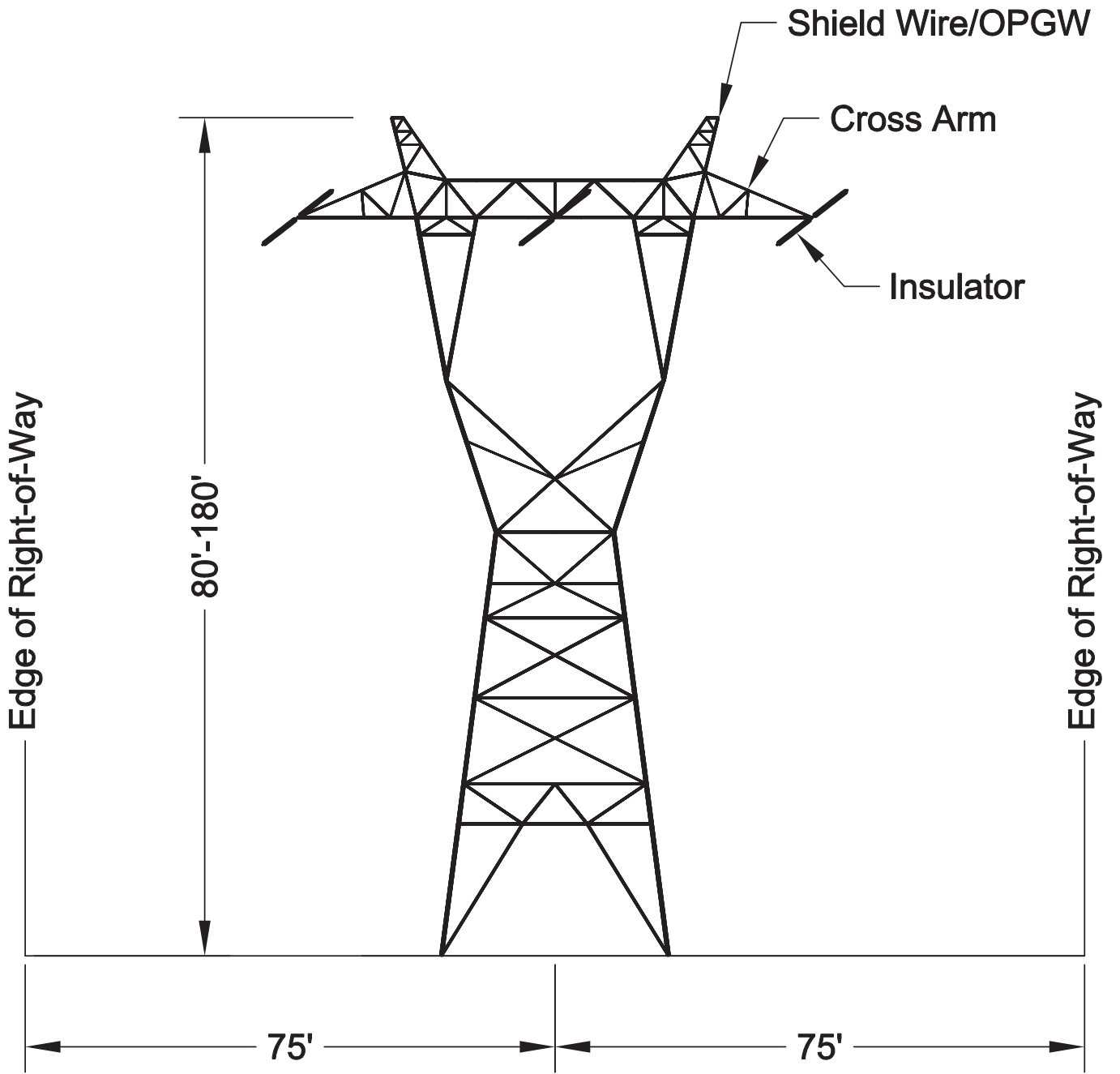

Figure 2-21a

500kV Lattice Deadend

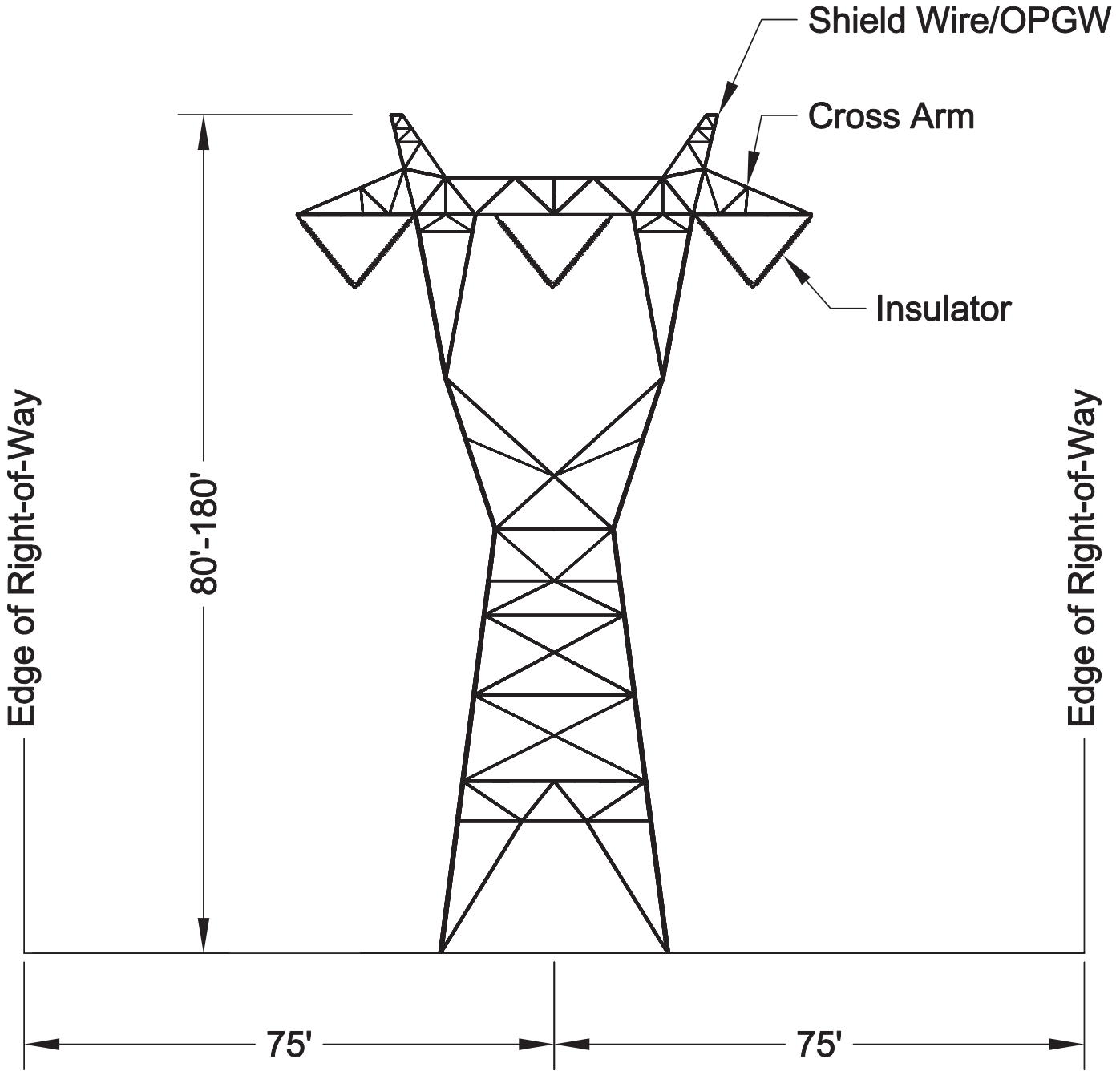
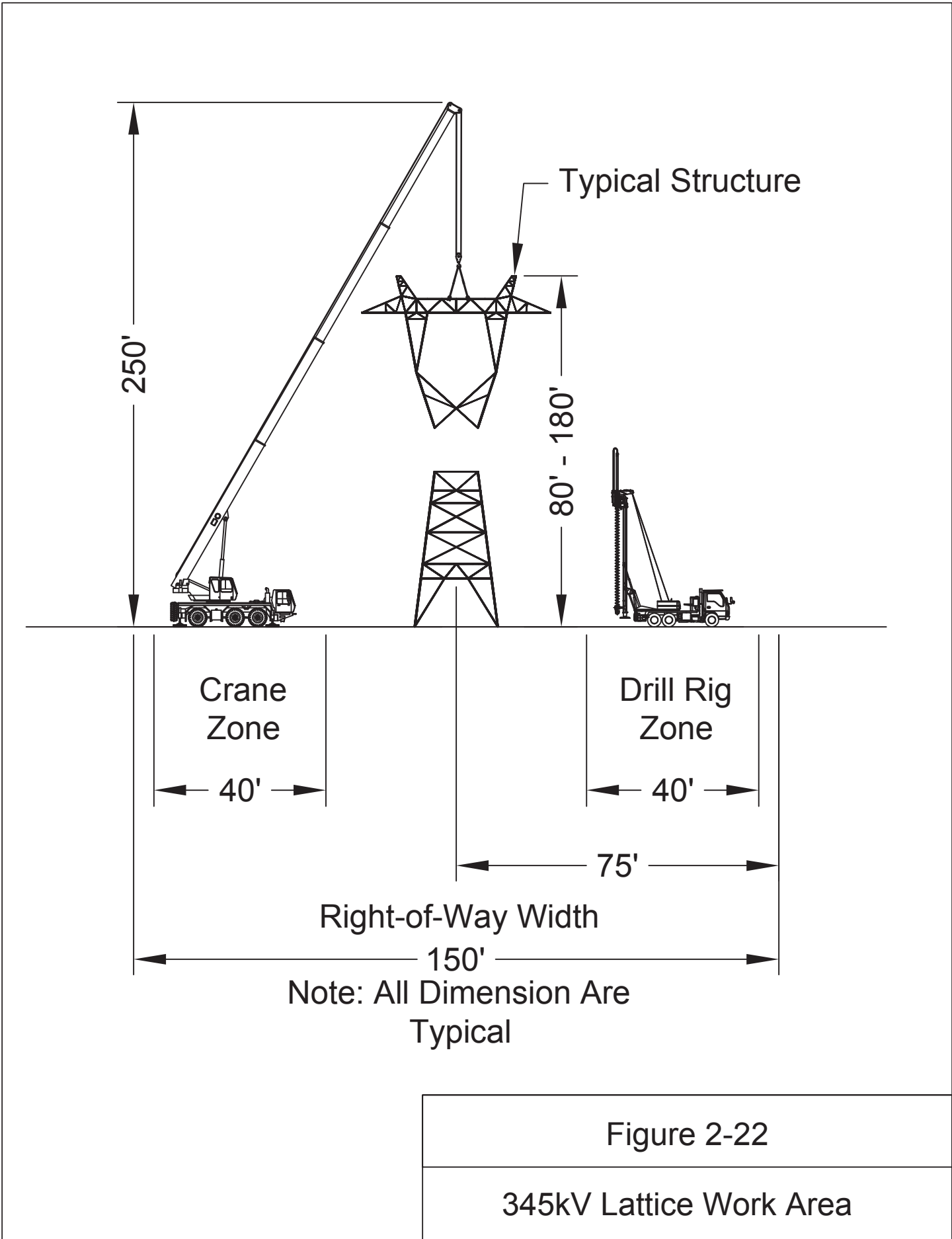
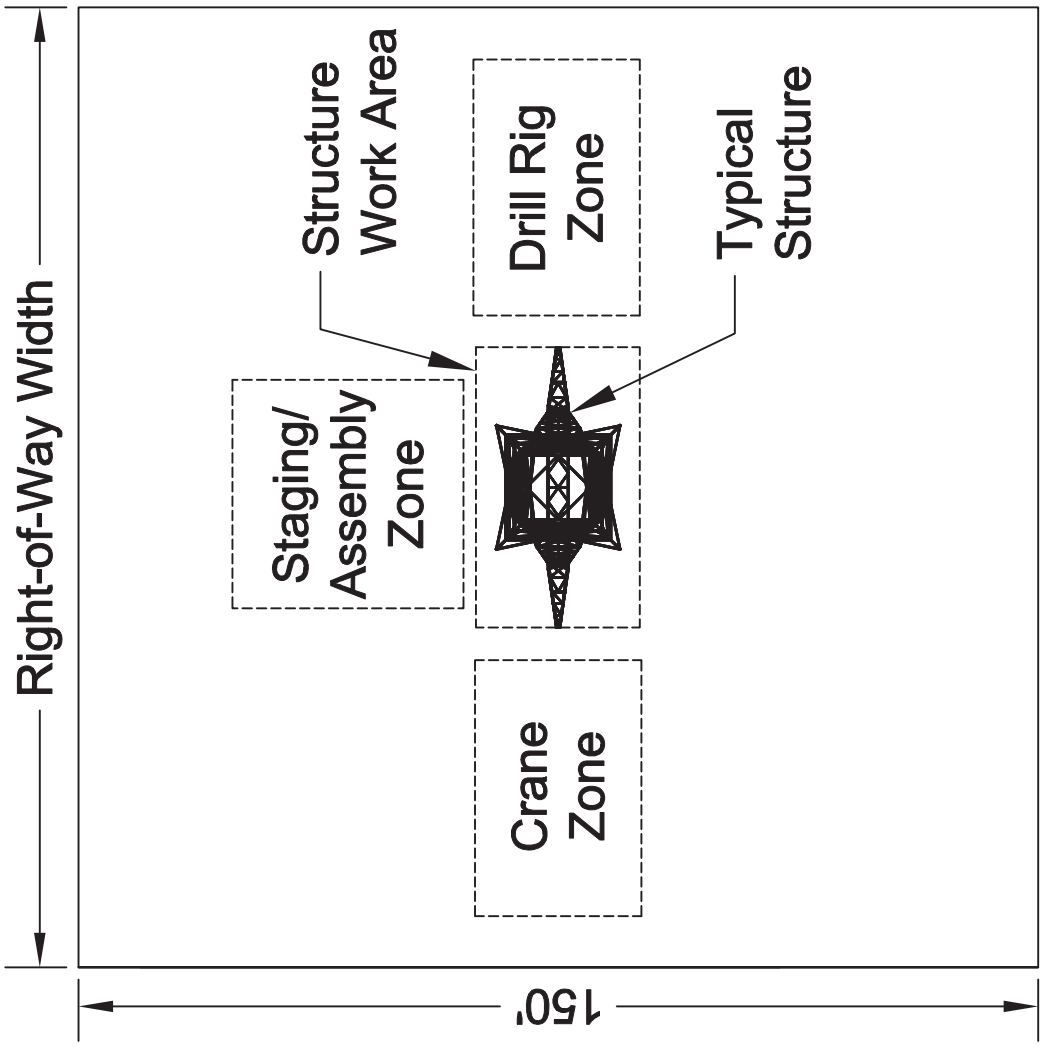

Figure 2-21b

500kV Lattice V-String





Not To Scale

Figure 2-23

345kV Lattice Foundation and Structure
Construction Activities - Plan View

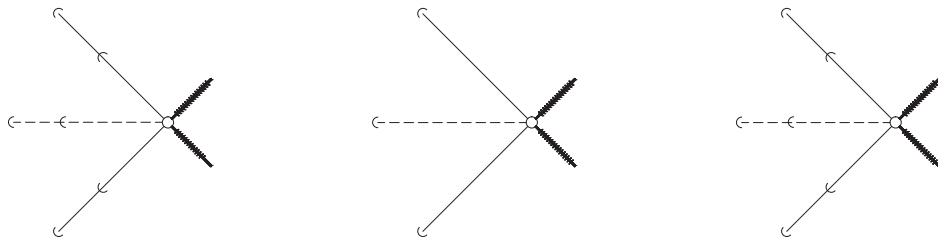

PLAN VIEW

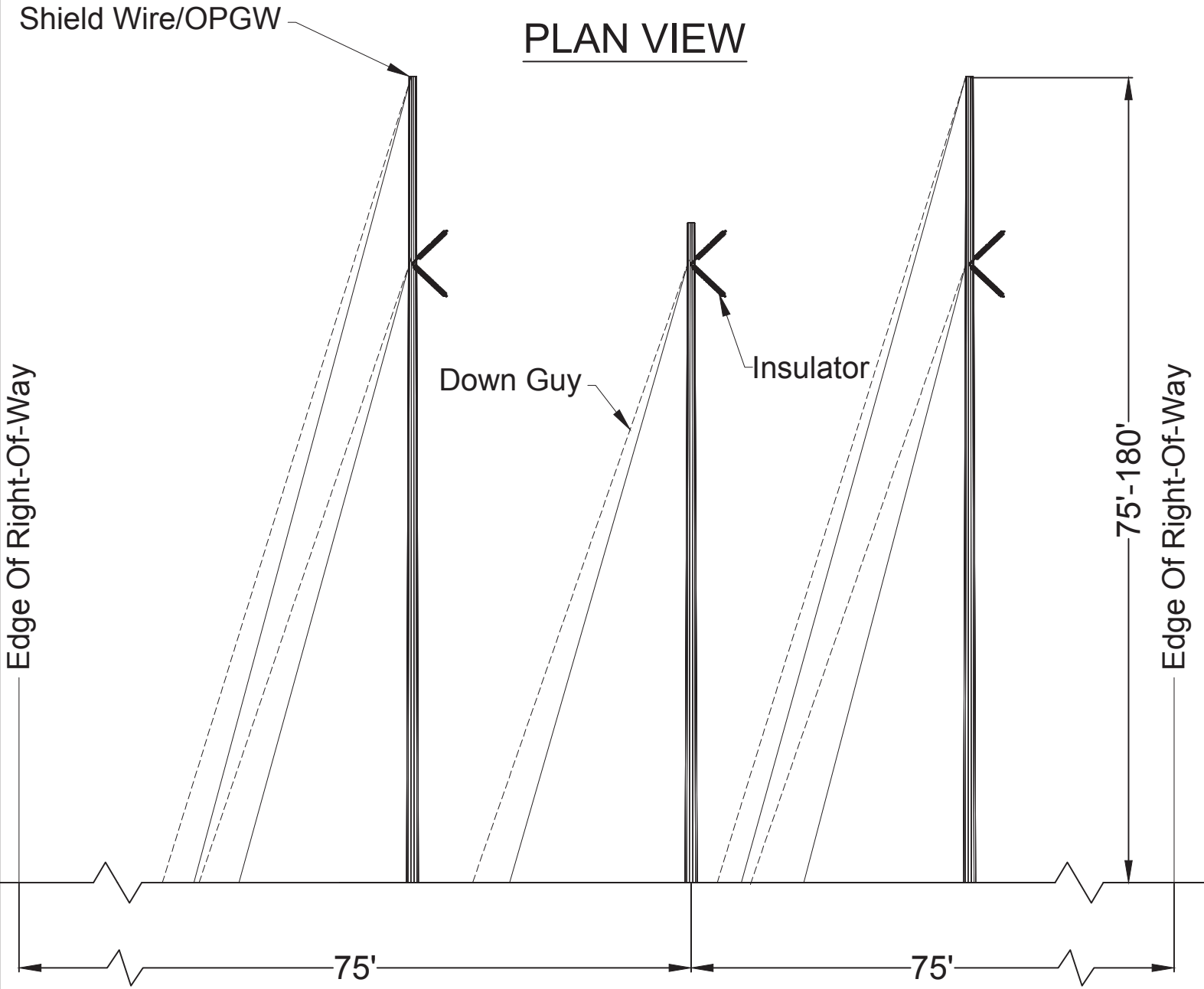

ELEVATION VIEW

NOT TO SCALE

NOTE:
 DEPENDING ON STRUCTURE
 HEIGHT AND LINE ANGLE, GUY EASEMENTS MAY BE
 REQUIRED BEYOND THE PROJECT 150 FOOT RIGHT-OF-WAY.

Figure 2-24a

345kV 3-Pole Guyed Deadend

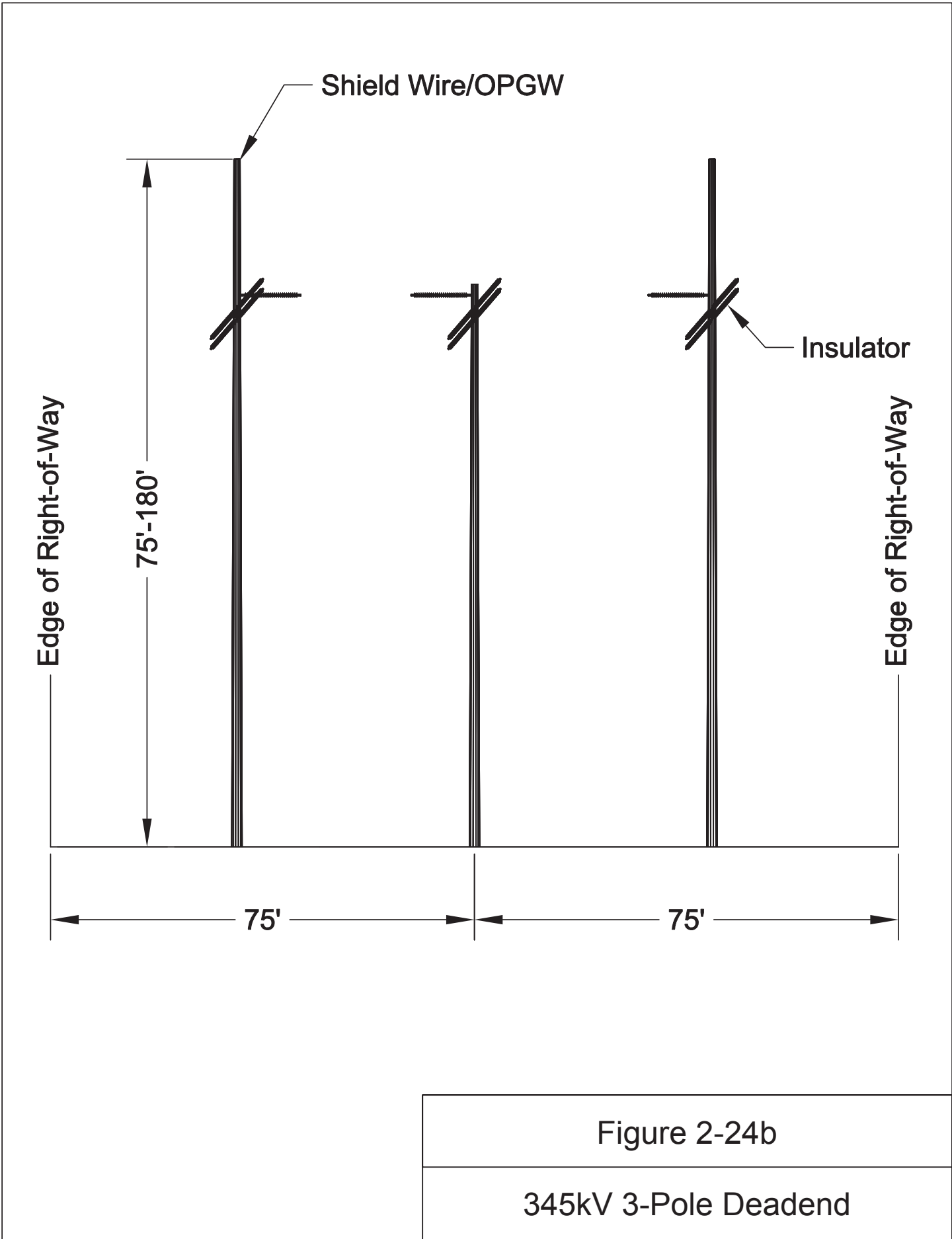



PLAN VIEW

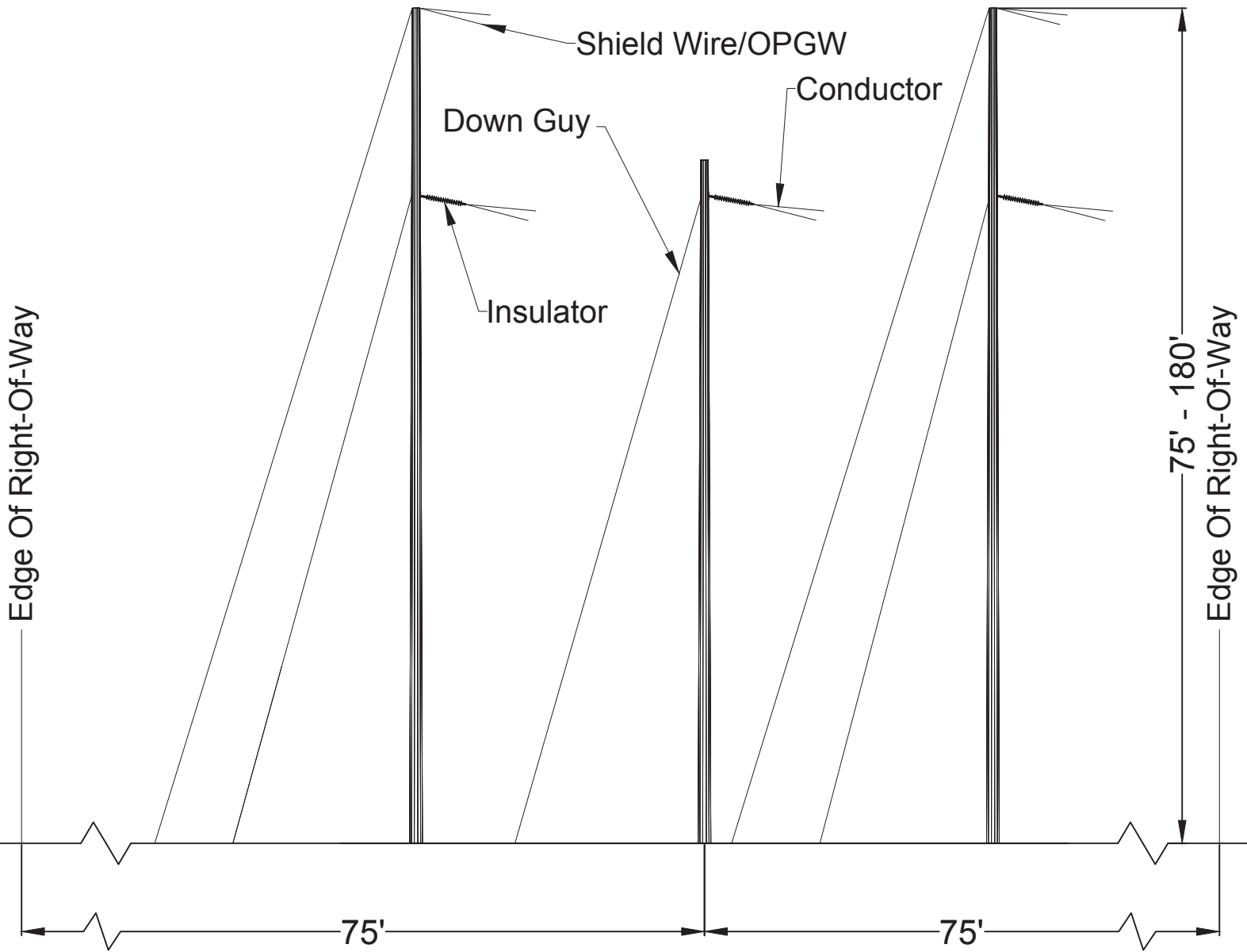

ELEVATION VIEW

NOT TO SCALE

NOTE:
DEPENDENT ON STRUCTURE
HEIGHT AND LINE ANGLE, GUY EASEMENTS MAY BE
REQUIRED BEYOND THE PROJECT 150 FOOT RIGHT-OF-WAY.

Figure 2-24c

345kV 3-Pole Guyed Running Angle

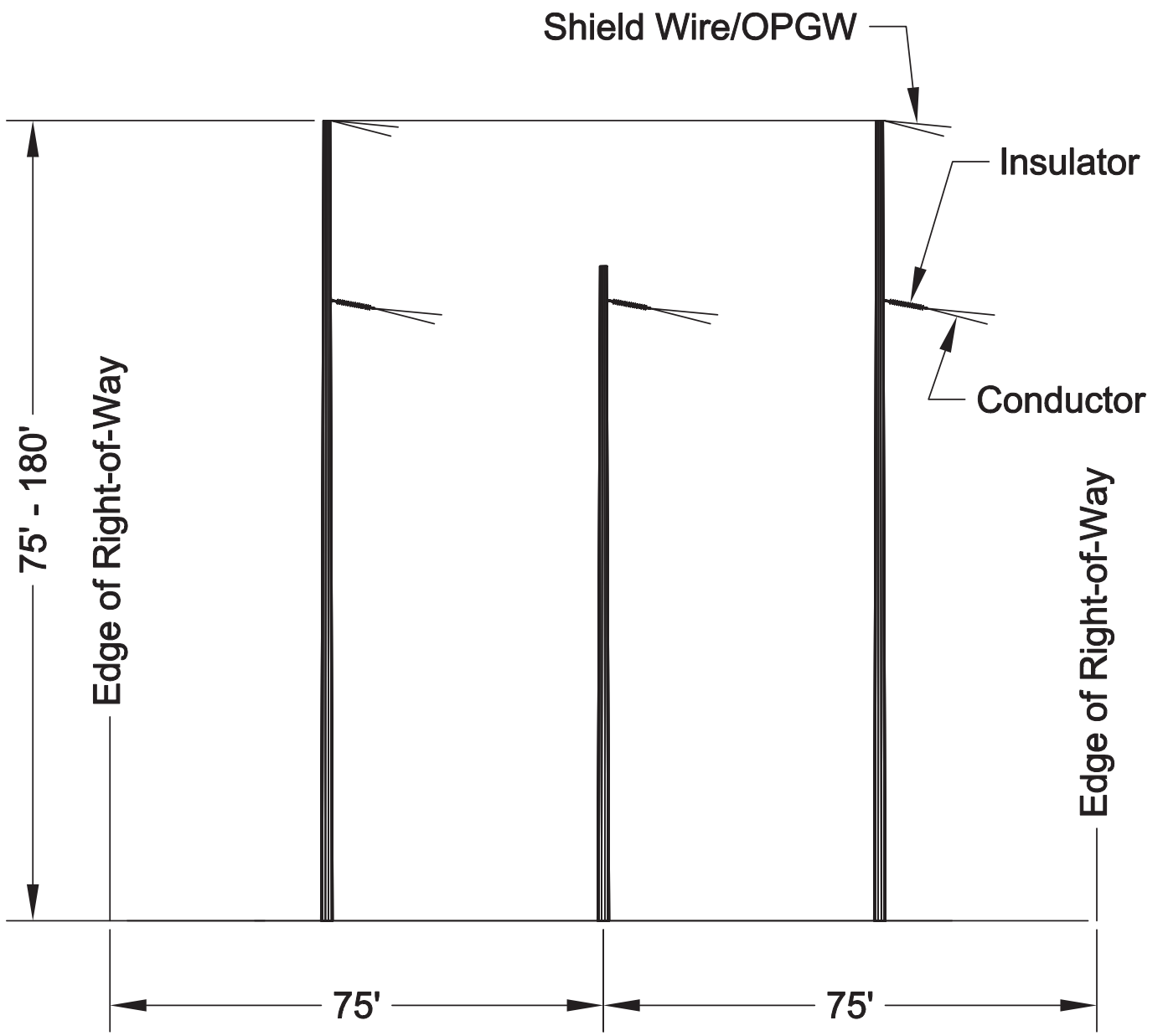

Figure 2-24d

345kV 3-Pole Running Angle

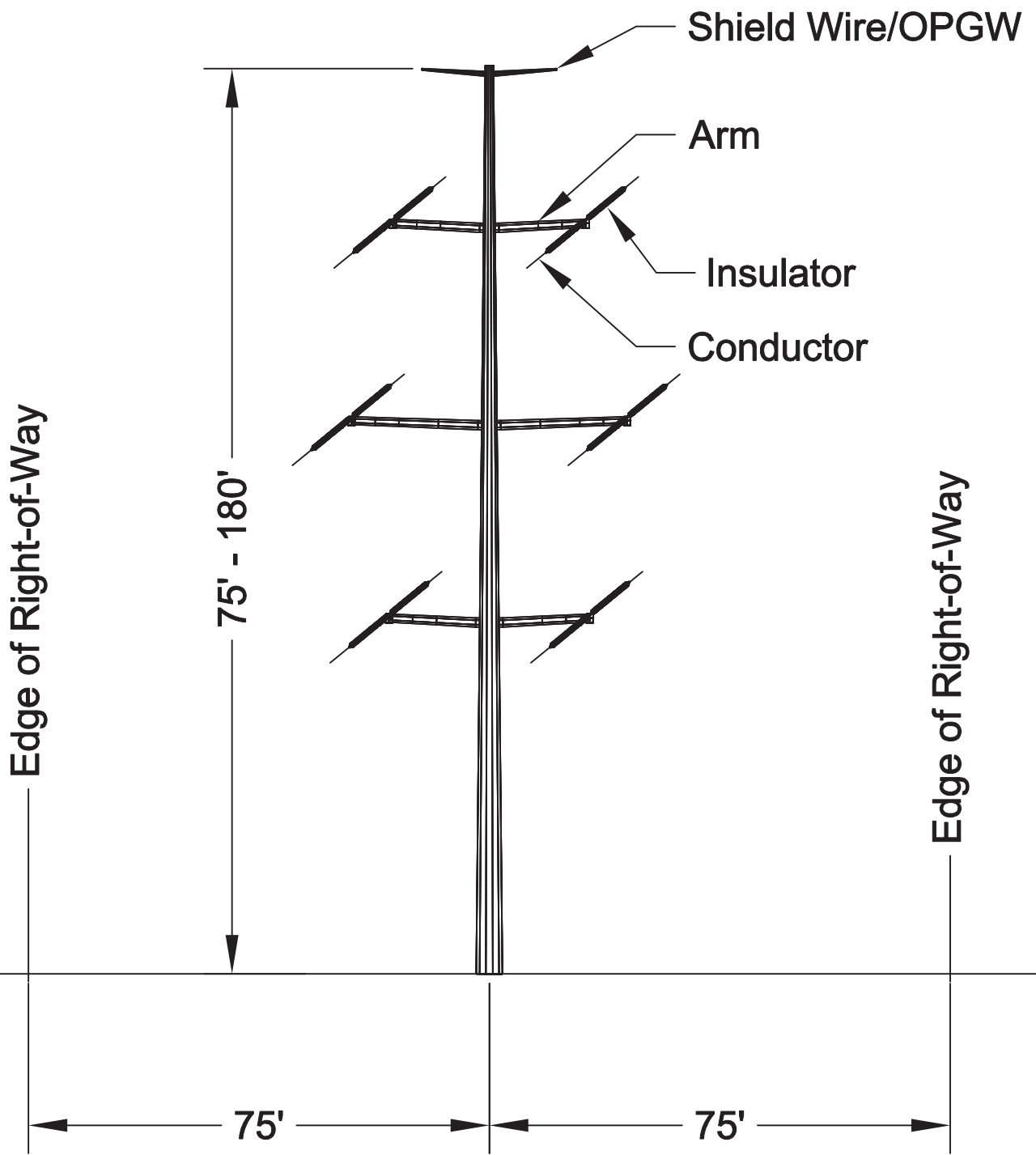
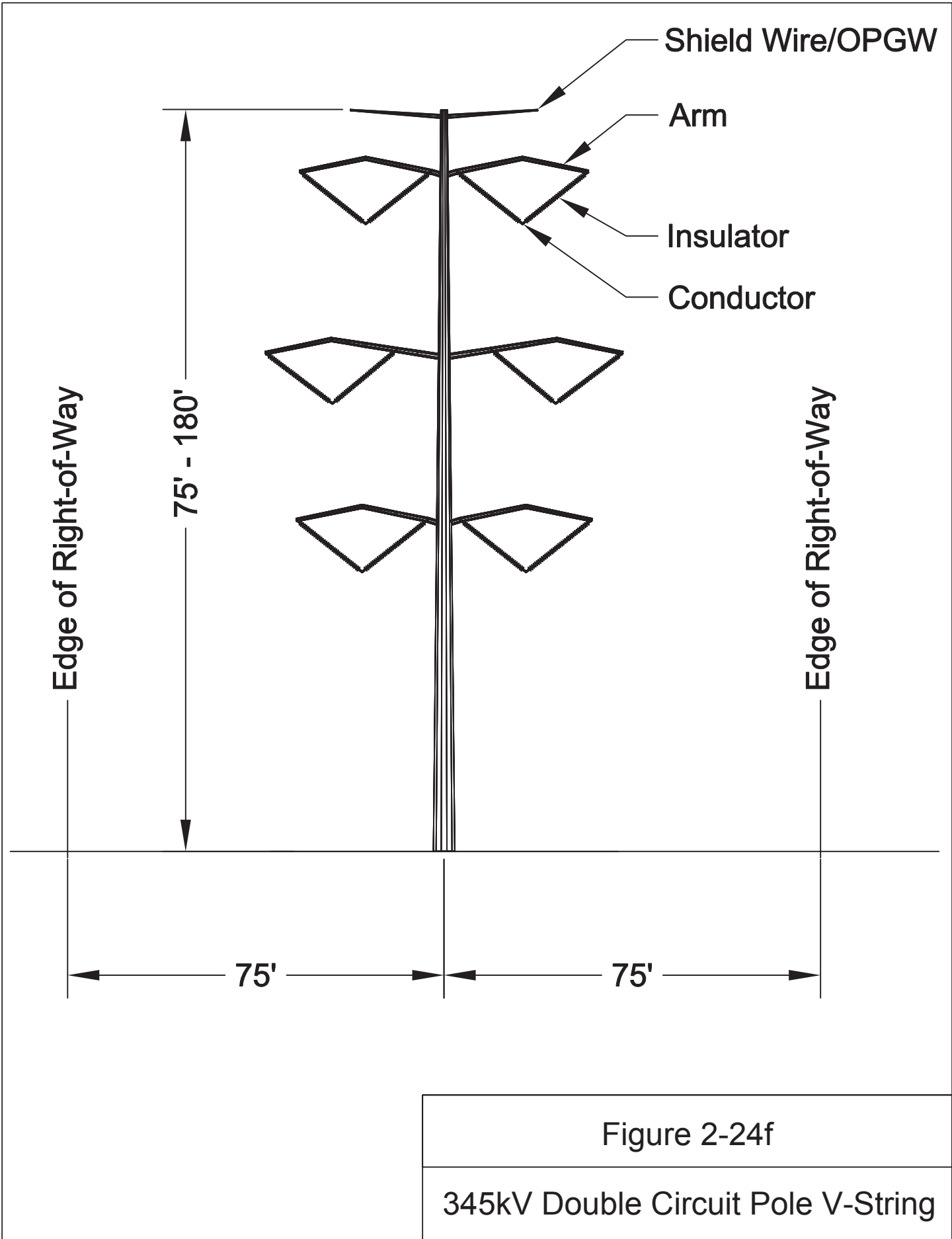
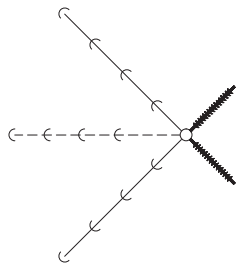

Figure 2-24e

345kV Double Circuit Pole Deadend





PLAN VIEW

Shield Wire/OPGW

Down Guy

Insulator

Conductor

Edge Of Right-Of-Way

75' - 180'

Edge Of Right-Of-Way

75'

75'

ELEVATION VIEW

NOT TO SCALE

NOTE:
 DEPENDING ON STRUCTURE
 HEIGHT AND LINE ANGLE, GUY EASEMENTS MAY BE
 REQUIRED BEYOND THE PROJECT 150 FOOT RIGHT-OF-WAY.

Figure 2-24g

345kV Single Circuit Guyed Pole DE

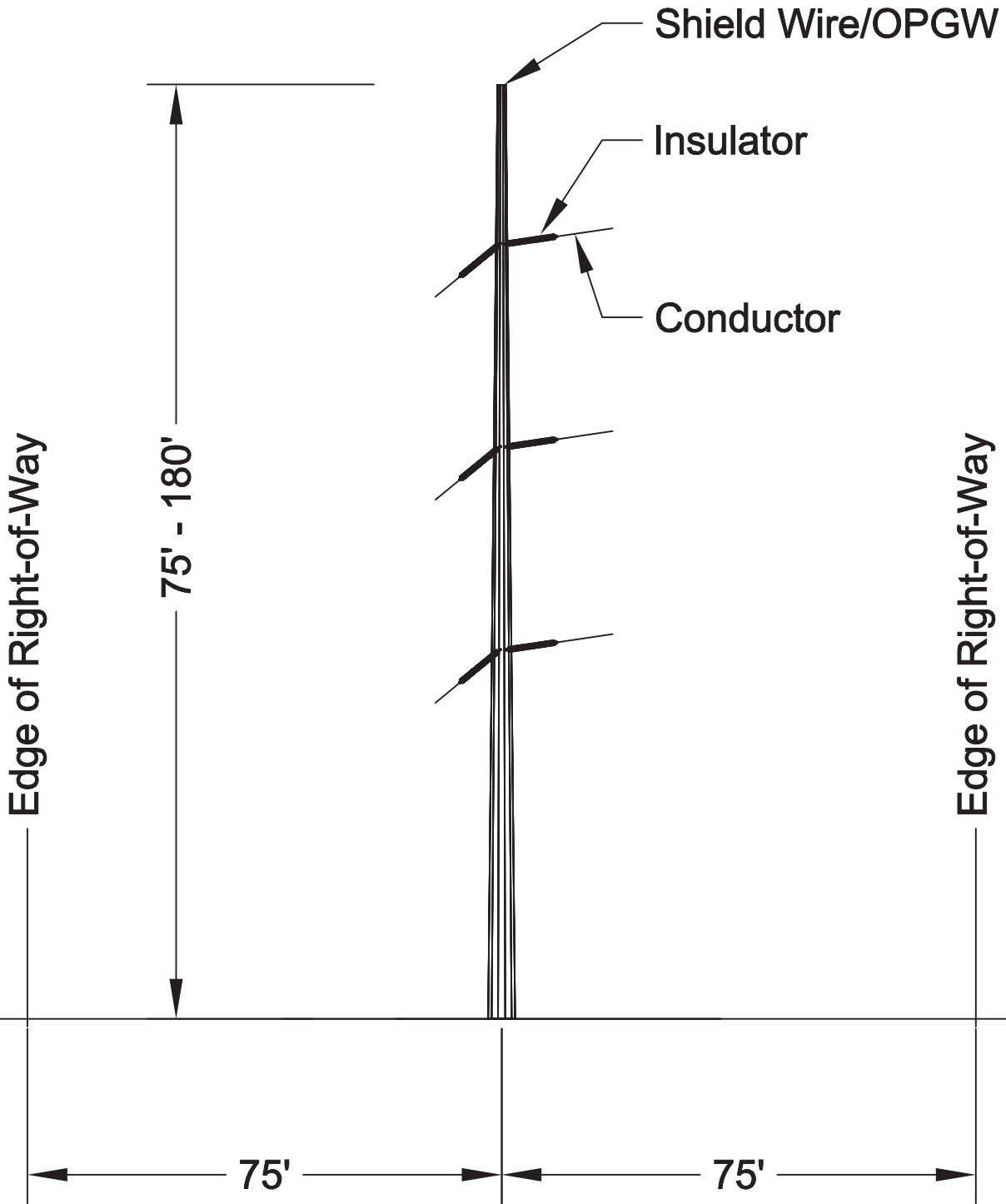

Figure 2-24h
345kV Single Circuit Pole Deadend

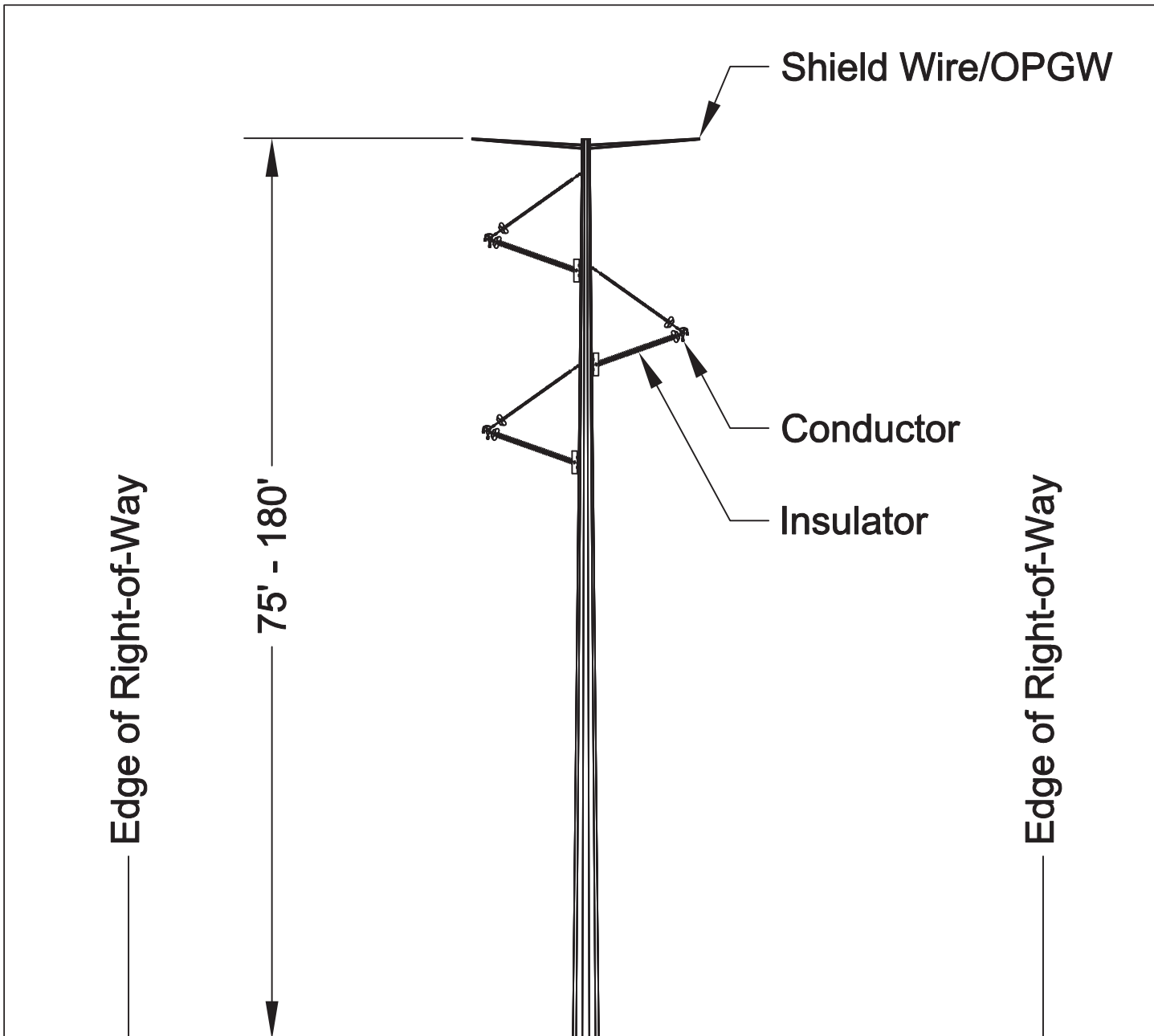

Figure 2-24i

345kV Pole Braced Post

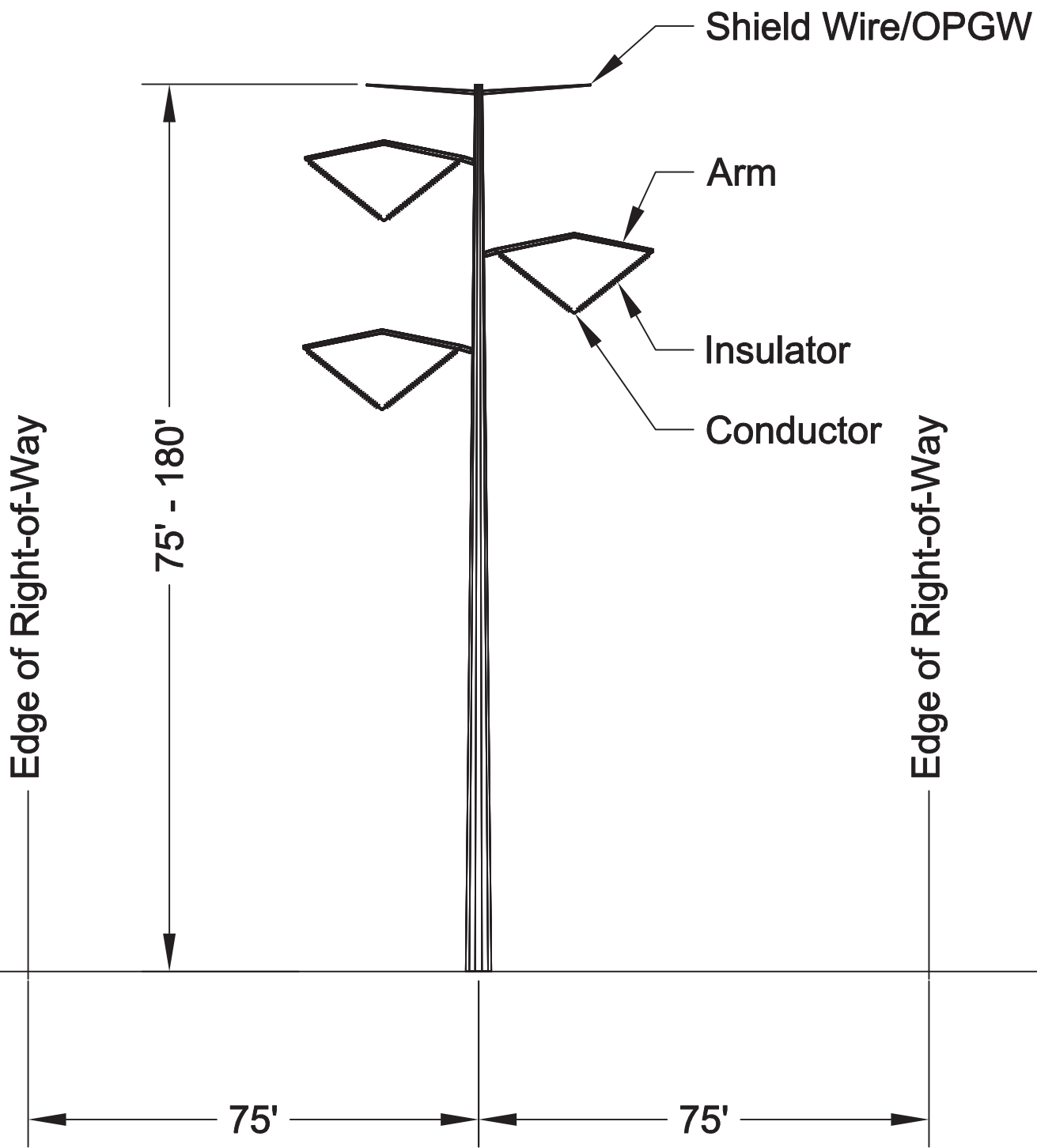
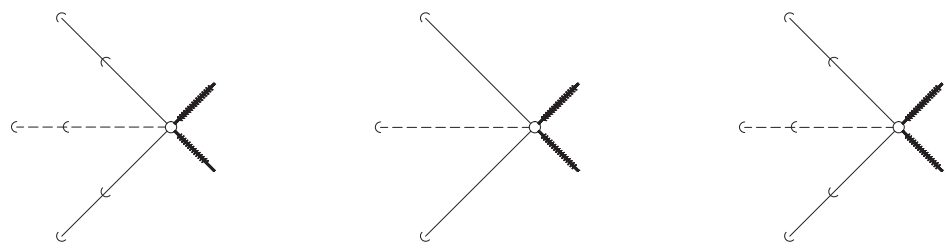
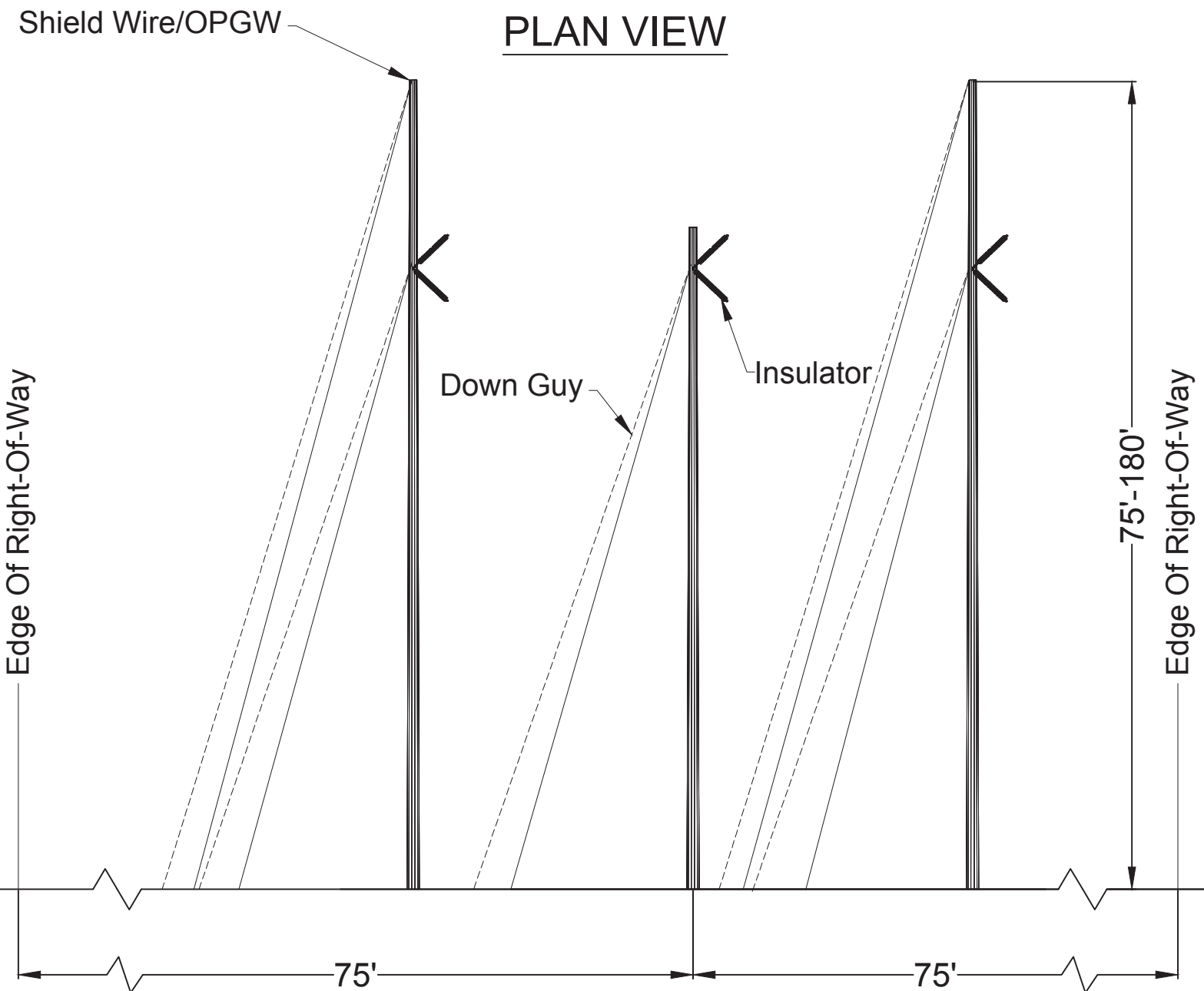

Figure 2-24j

345kV Single Circuit Pole V-String



PLAN VIEW



ELEVATION VIEW

NOT TO SCALE

NOTE:
 DEPENDING ON STRUCTURE
 HEIGHT AND LINE ANGLE, GUY EASEMENTS MAY BE
 REQUIRED BEYOND THE PROJECT 150 FOOT RIGHT-OF-WAY.

Figure 2-25a
 500kV 3-Pole Guyed Deadend

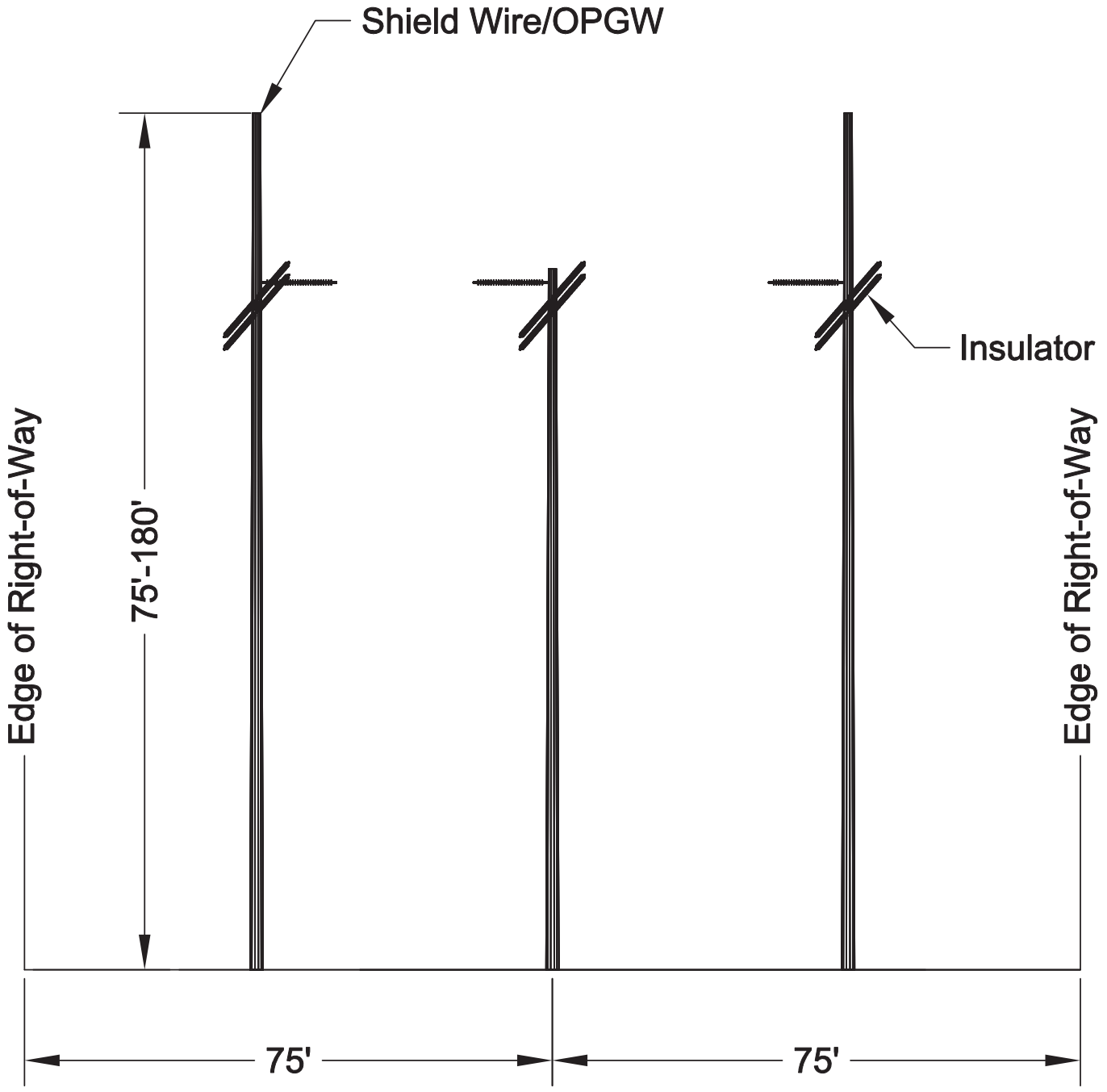
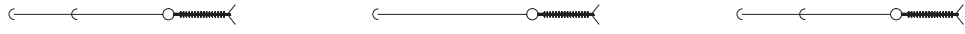
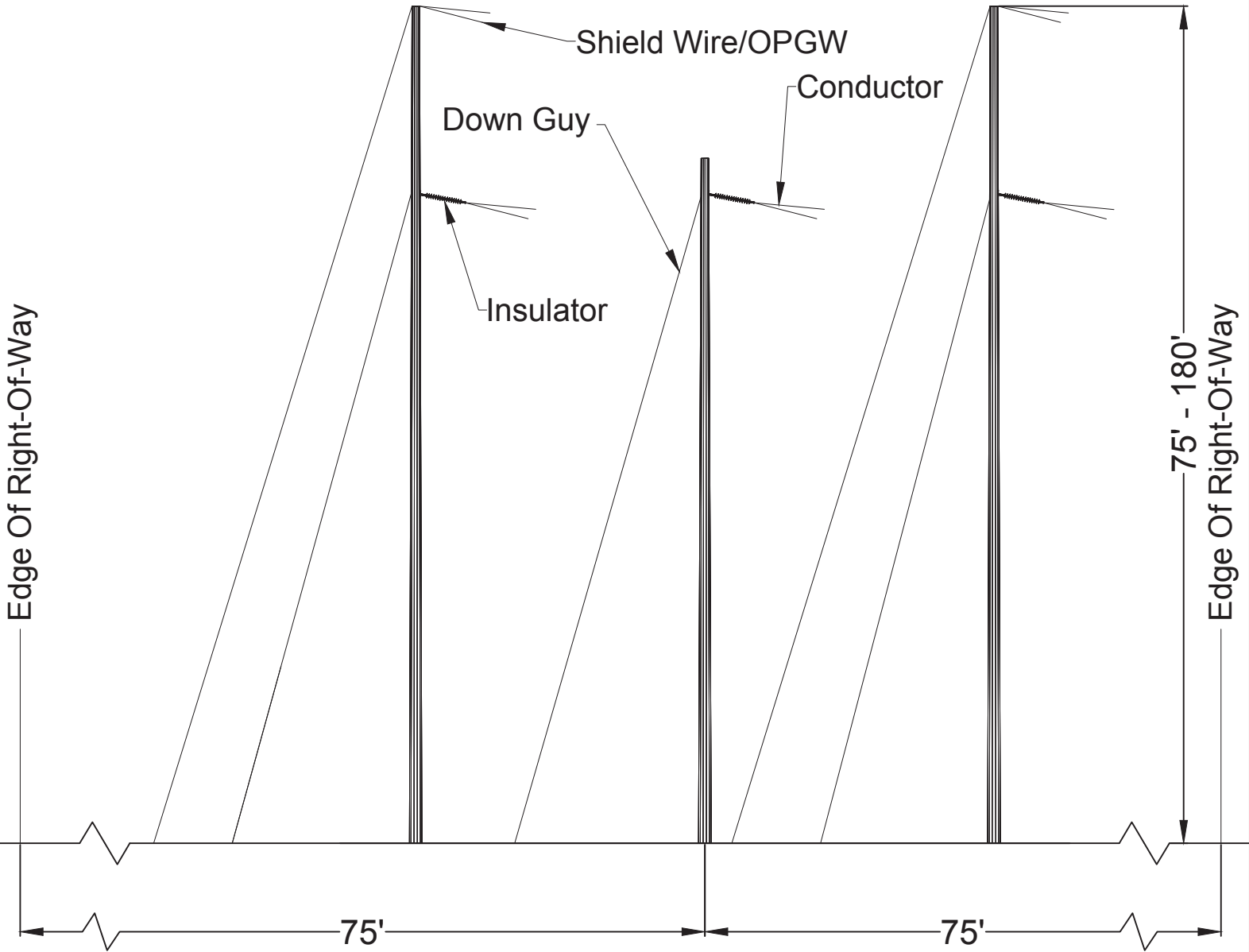

Figure 2-25b
500kV 3-Pole Deadend



PLAN VIEW



ELEVATION VIEW

NOT TO SCALE

NOTE:
DEPENDENT ON STRUCTURE
HEIGHT AND LINE ANGLE, GUY EASEMENTS MAY BE
REQUIRED BEYOND THE PROJECT 150 FOOT RIGHT-OF-WAY.

Figure 2-25c

500kV 3-Pole Guyed Running Angle

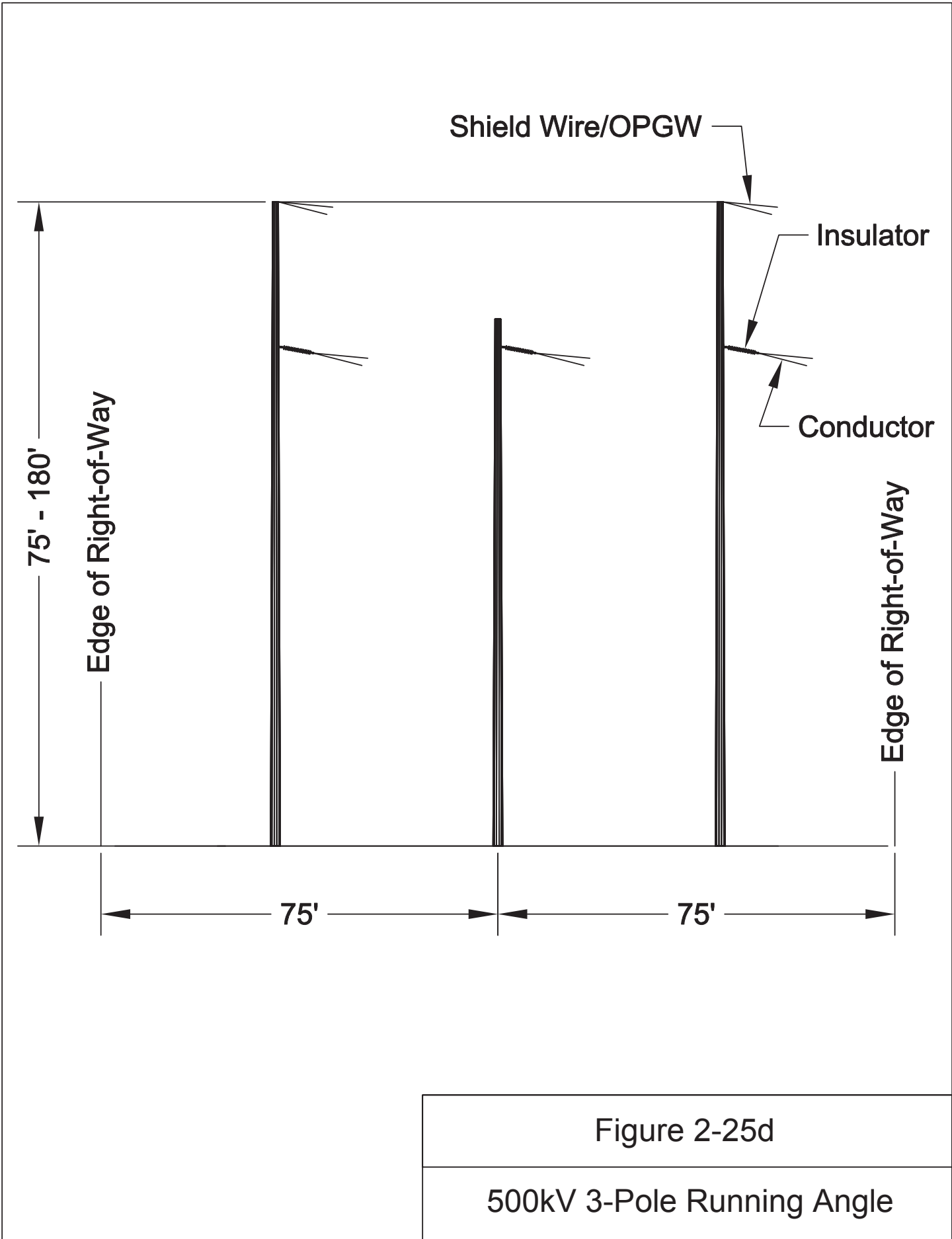

Figure 2-25d

500kV 3-Pole Running Angle

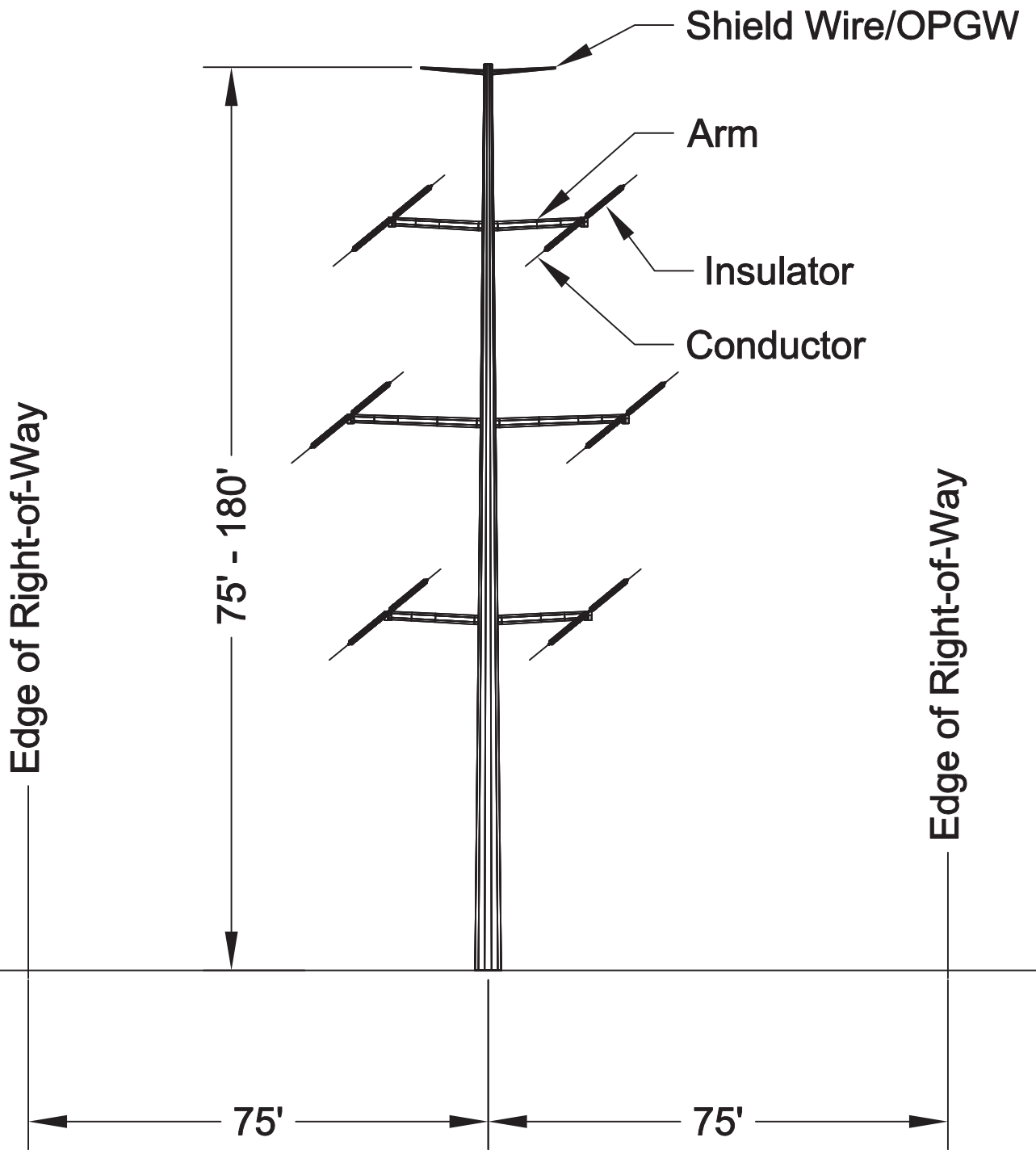

Figure 2-25e

500kV Double Circuit Pole Deadend

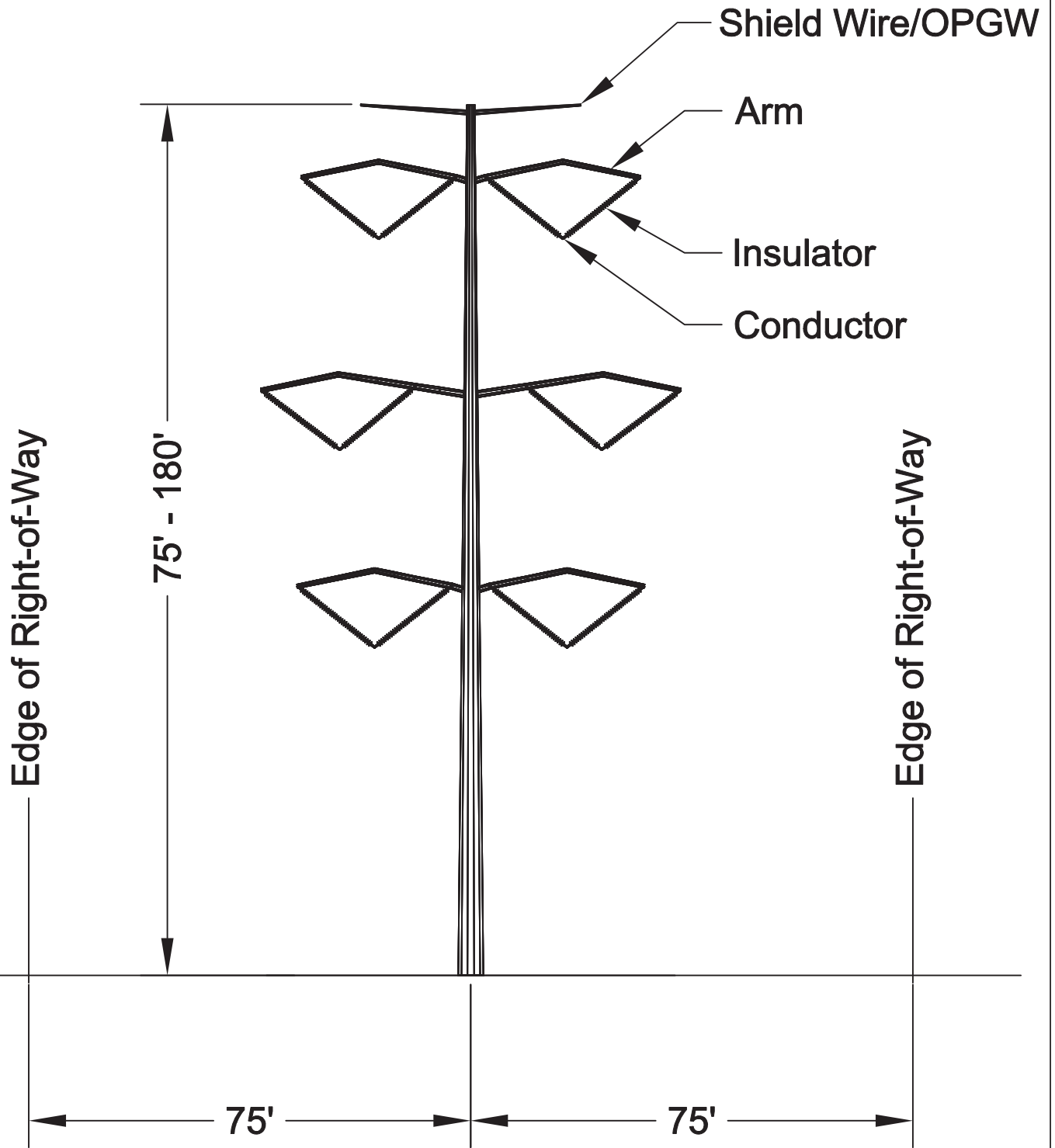
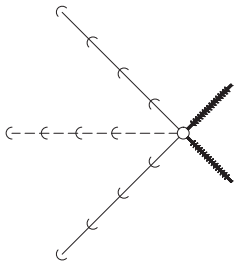

Figure 2-25f

500kV Double Circuit Pole V-String



PLAN VIEW

Shield Wire/OPGW

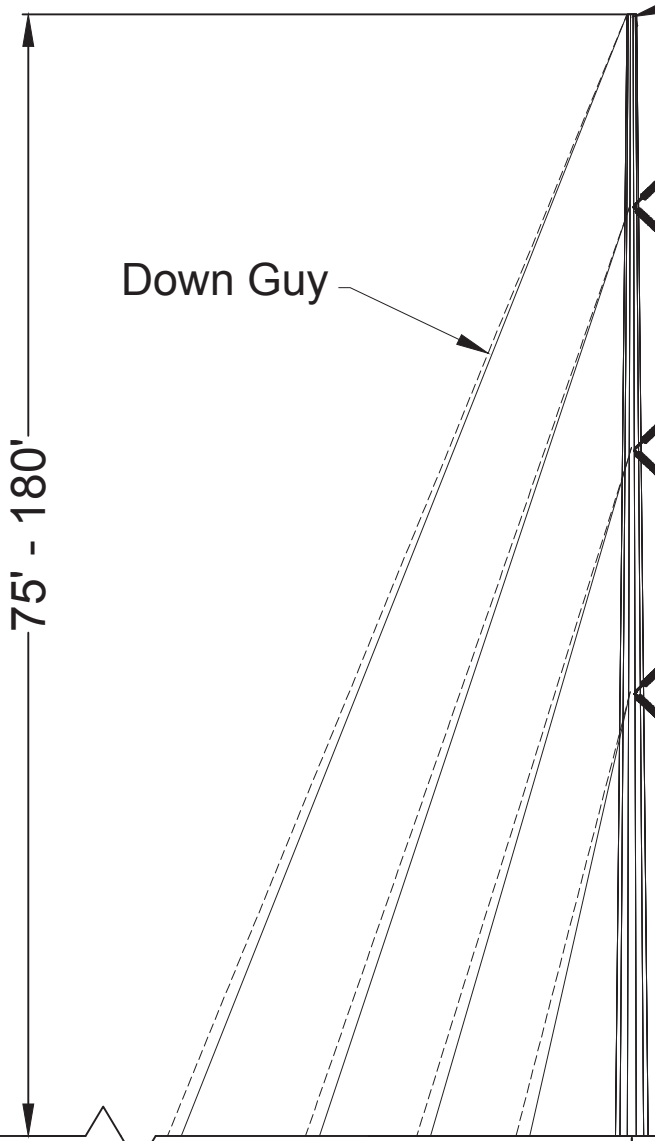

Insulator

Conductor

Down Guy

Edge Of Right-Of-Way

Edge Of Right-Of-Way

75' - 180'

75'

75'

ELEVATION VIEW

NOT TO SCALE

NOTE:
 DEPENDING ON STRUCTURE
 HEIGHT AND LINE ANGLE, GUY EASEMENTS MAY BE
 REQUIRED BEYOND THE PROJECT 150 FOOT RIGHT-OF-WAY.

Figure 2-25g

500kV Single Circuit Guyed Pole DE

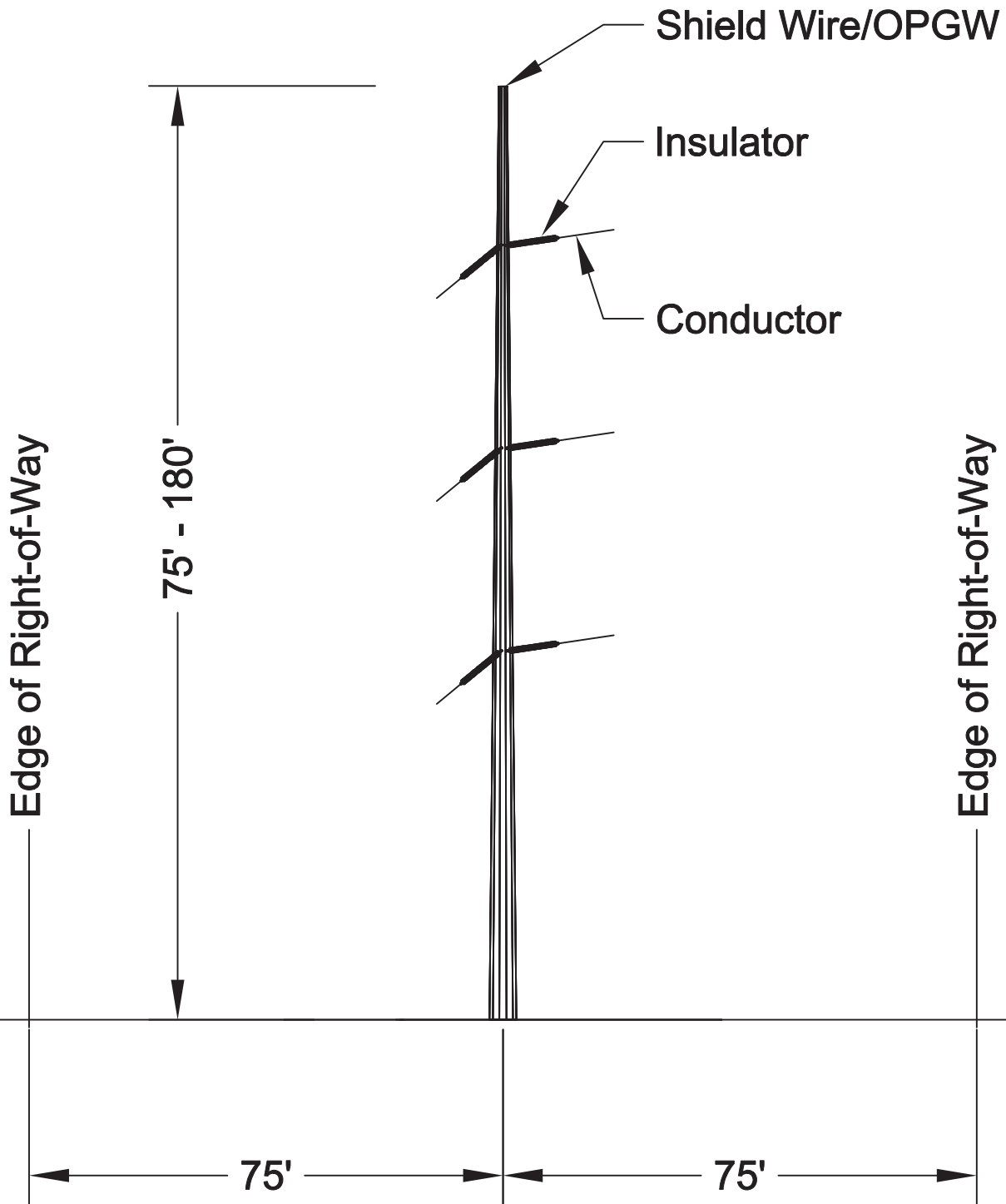

Figure 2-25h

500kV Single Circuit Pole Deadend

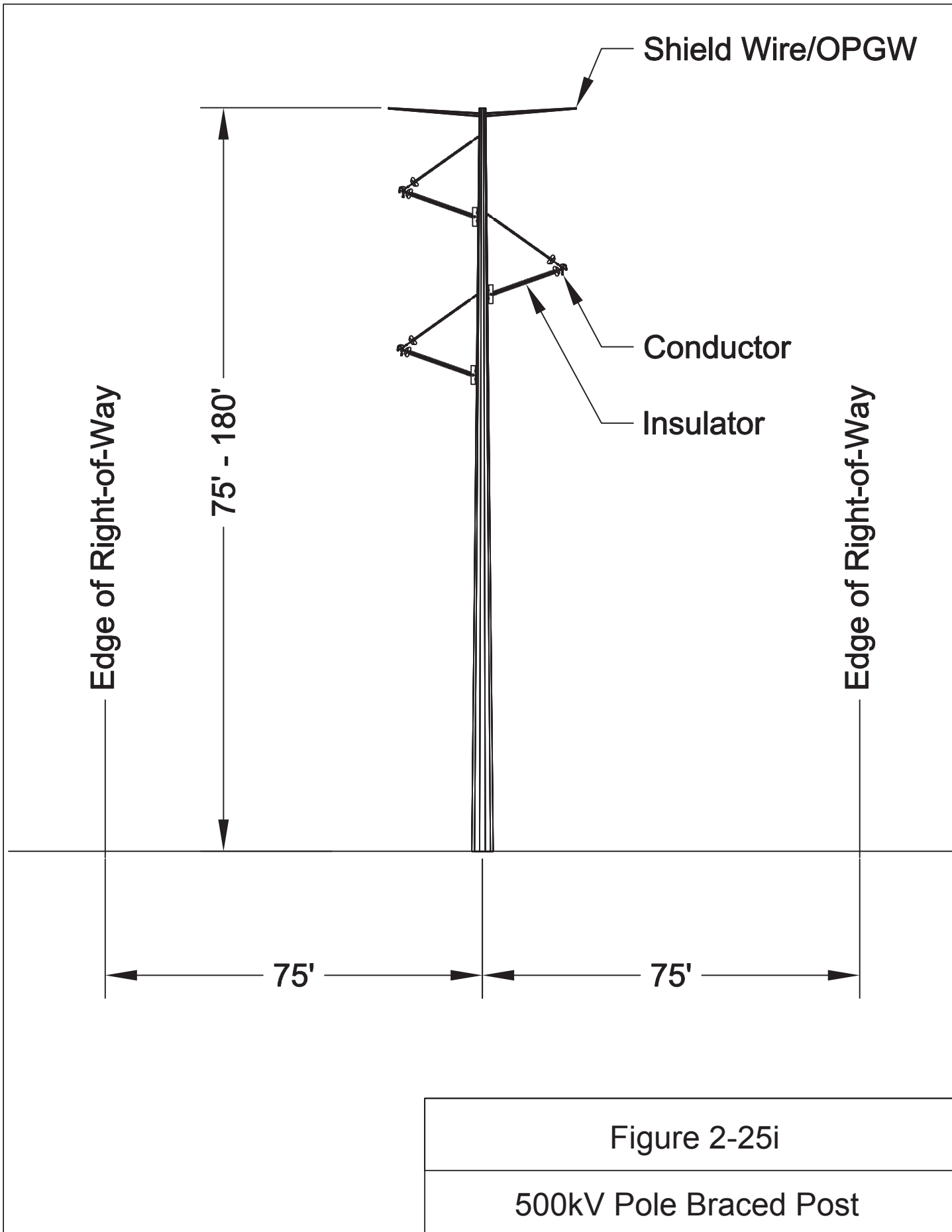

Figure 2-25i

500kV Pole Braced Post

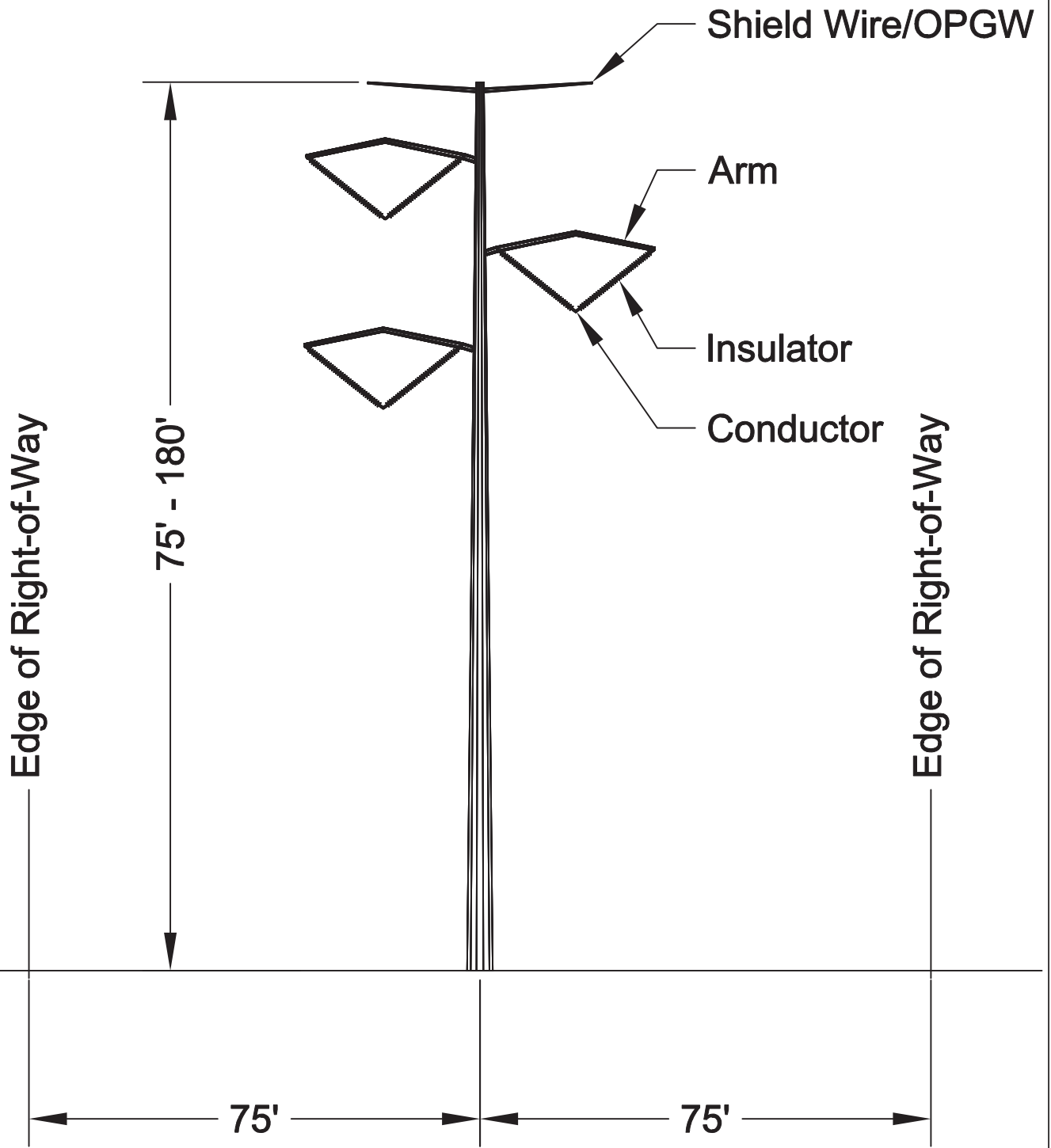
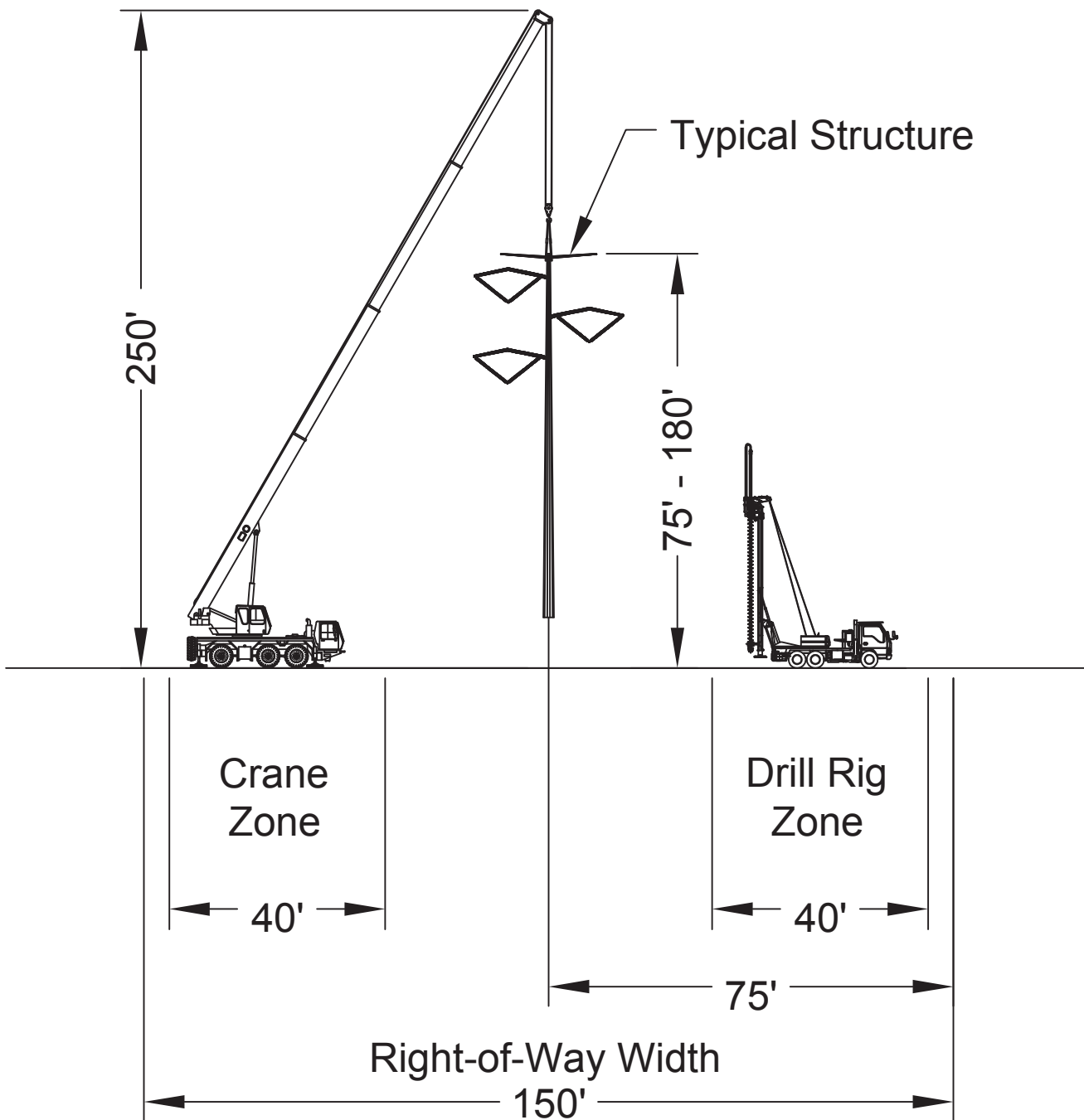

Figure 2-25j

500kV Single Circuit Pole V-String



Note: All Dimension Are Typical

Figure 2-26

345kV Monopole Work Area

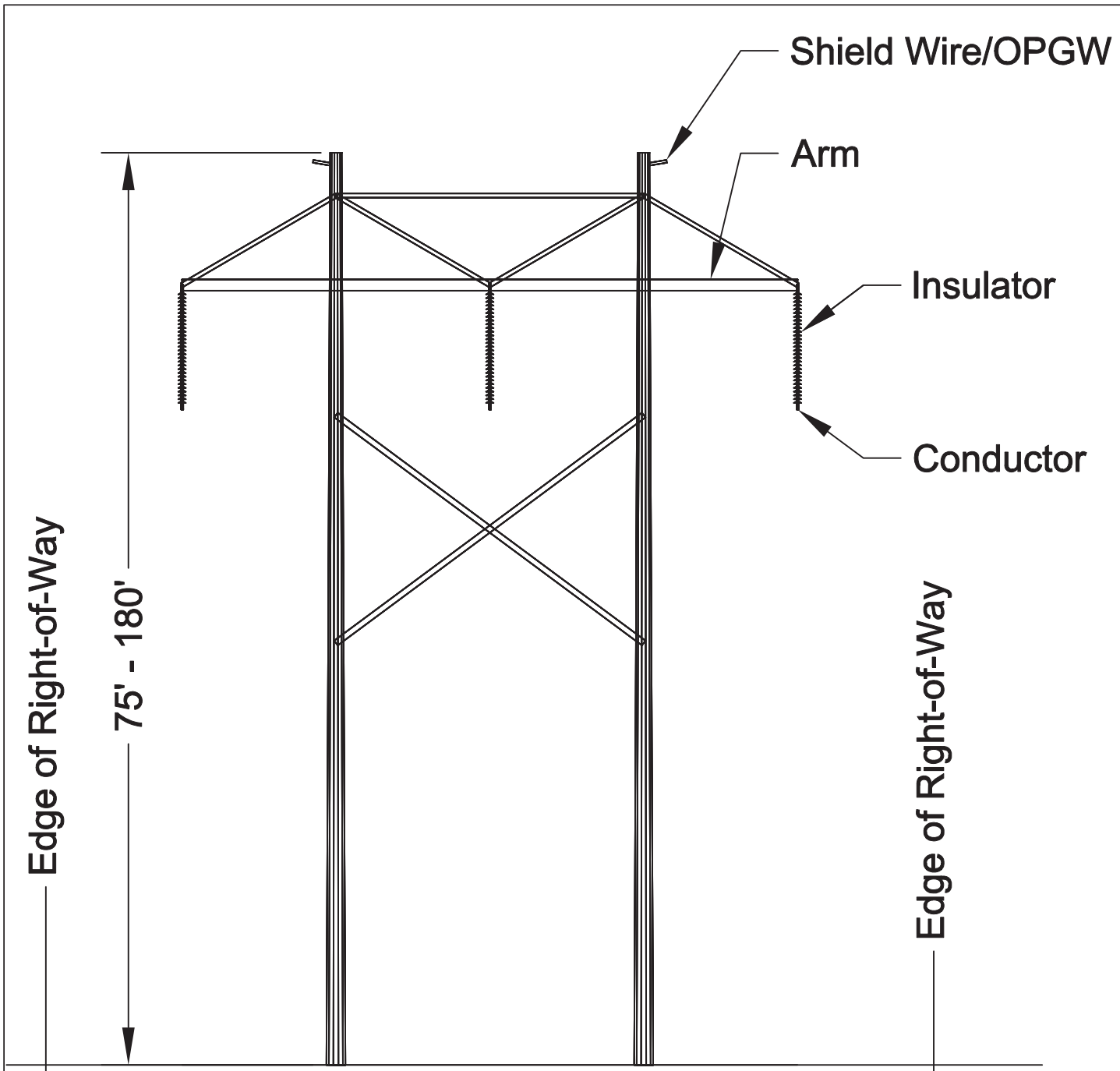

Shield Wire/OPGW

Arm

Insulator

Conductor

Edge of Right-of-Way

Edge of Right-of-Way

75' - 180'

75'

75'

Figure 2-27a

345kV Braced H-Frame

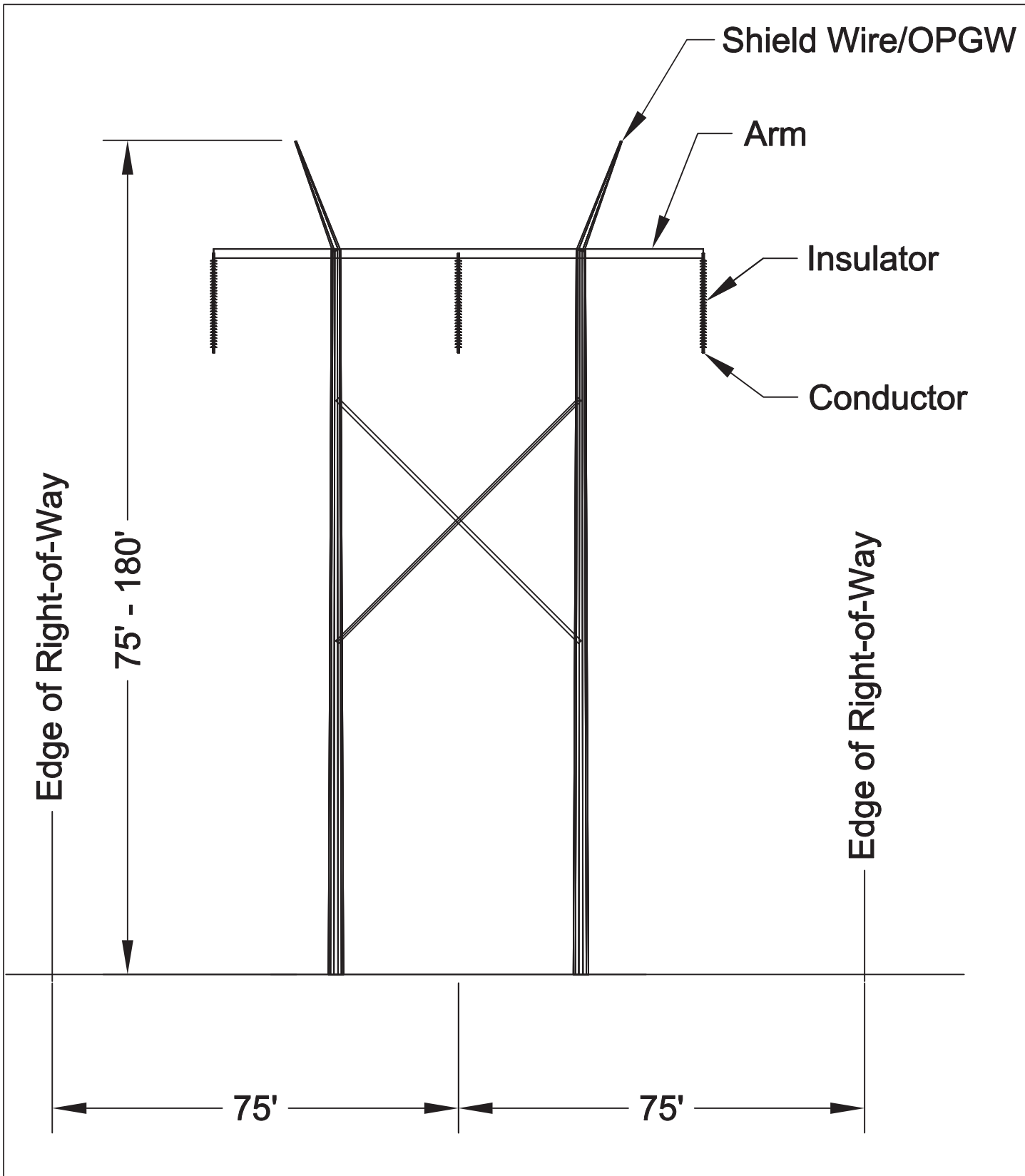

Figure 2-27b
 345kV H-Frame Tangent

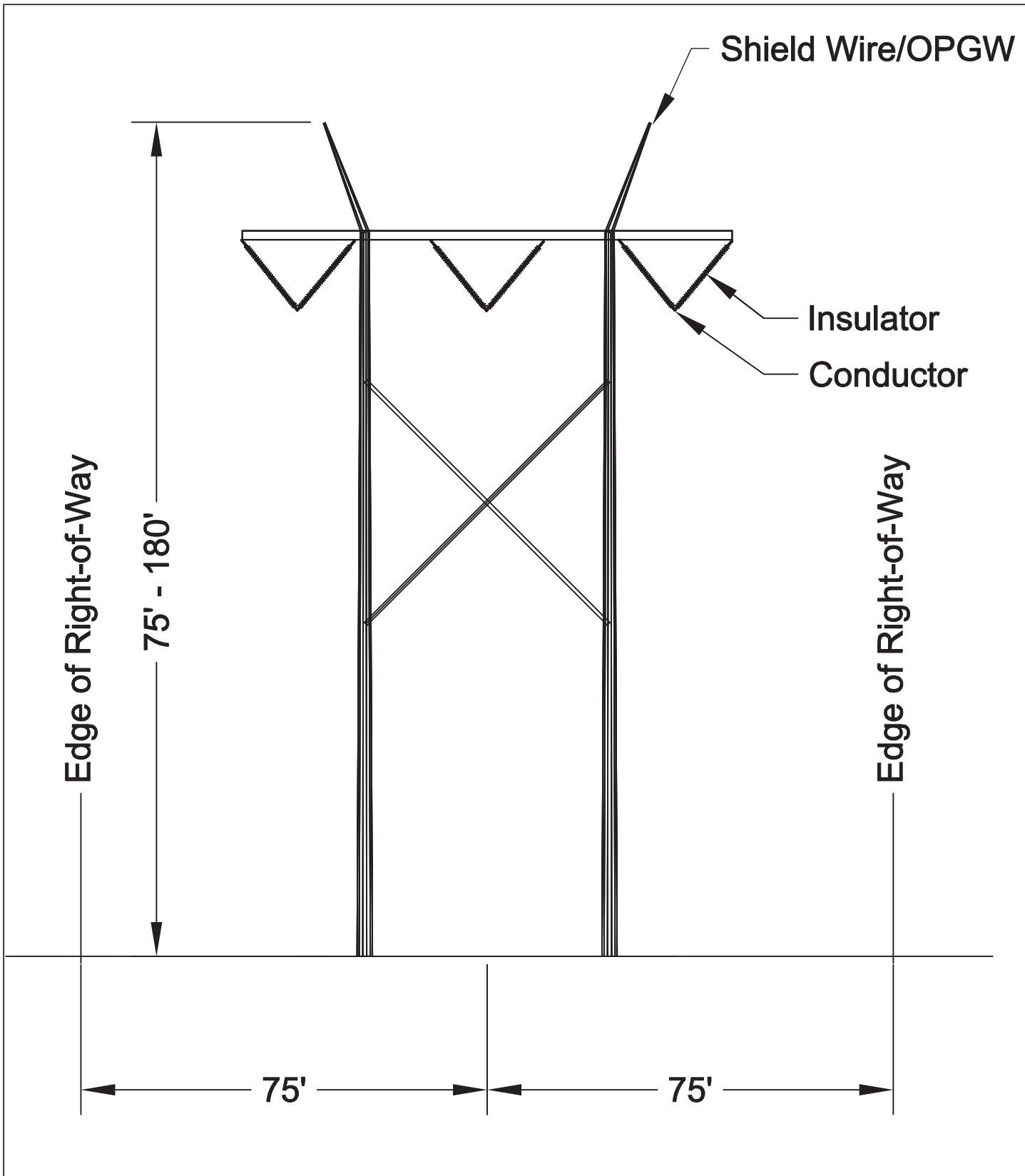
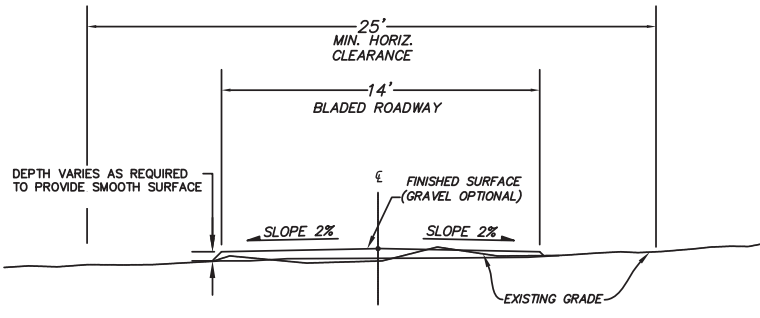
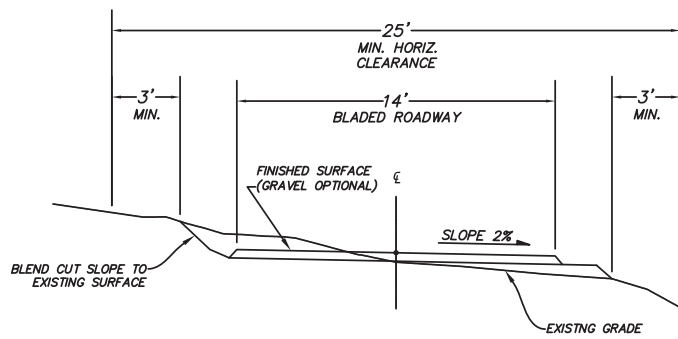

Figure 2-27c
345kV H-Frame V-String



TYPICAL SECTION ON FLAT GROUND



TYPICAL 'OUTSLOPE' SECTION

NOTE:
 PROVIDE OUTSLOPE ON ROADS WITH GRADES AS STEEP AS 20% IN THE SAME DIRECTION AS THE SURROUNDING TOPOGRAPHY SO THAT THE UPHILL EDGE OF THE ROAD IS HIGHER THAN THE DOWNHILL EDGE.

AVOID OUTSLOPED ROADS WHERE THEY WOULD DIRECT RUNOFF ONTO ERODIBLE FILL, EMBANKMENTS, OR WHERE THEY COULD CAUSE OFF-CAMBER CURVES.

PROVIDE "INSLOPED" ROAD SECTION WITH ROADSIDE DITCH ON GRADES STEEPER THAN 20%.

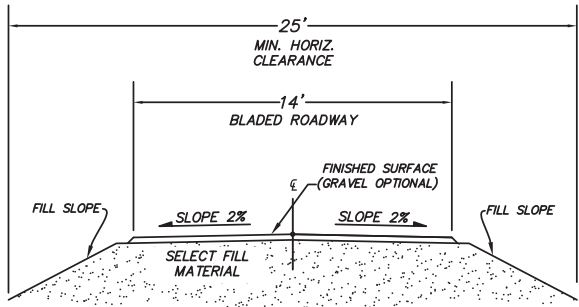

TYPICAL FILL SECTION

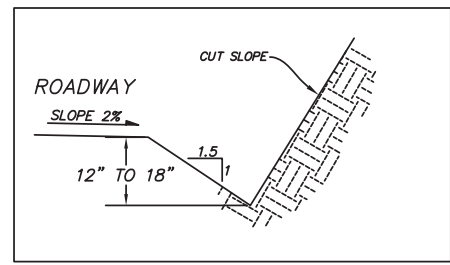

TYPICAL DITCH SECTION

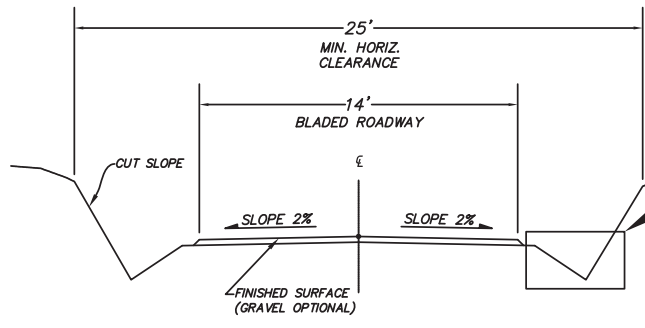

TYPICAL THROUGH-CUT SECTION

Figure 2-28
 TYPICAL ACCESS ROADS

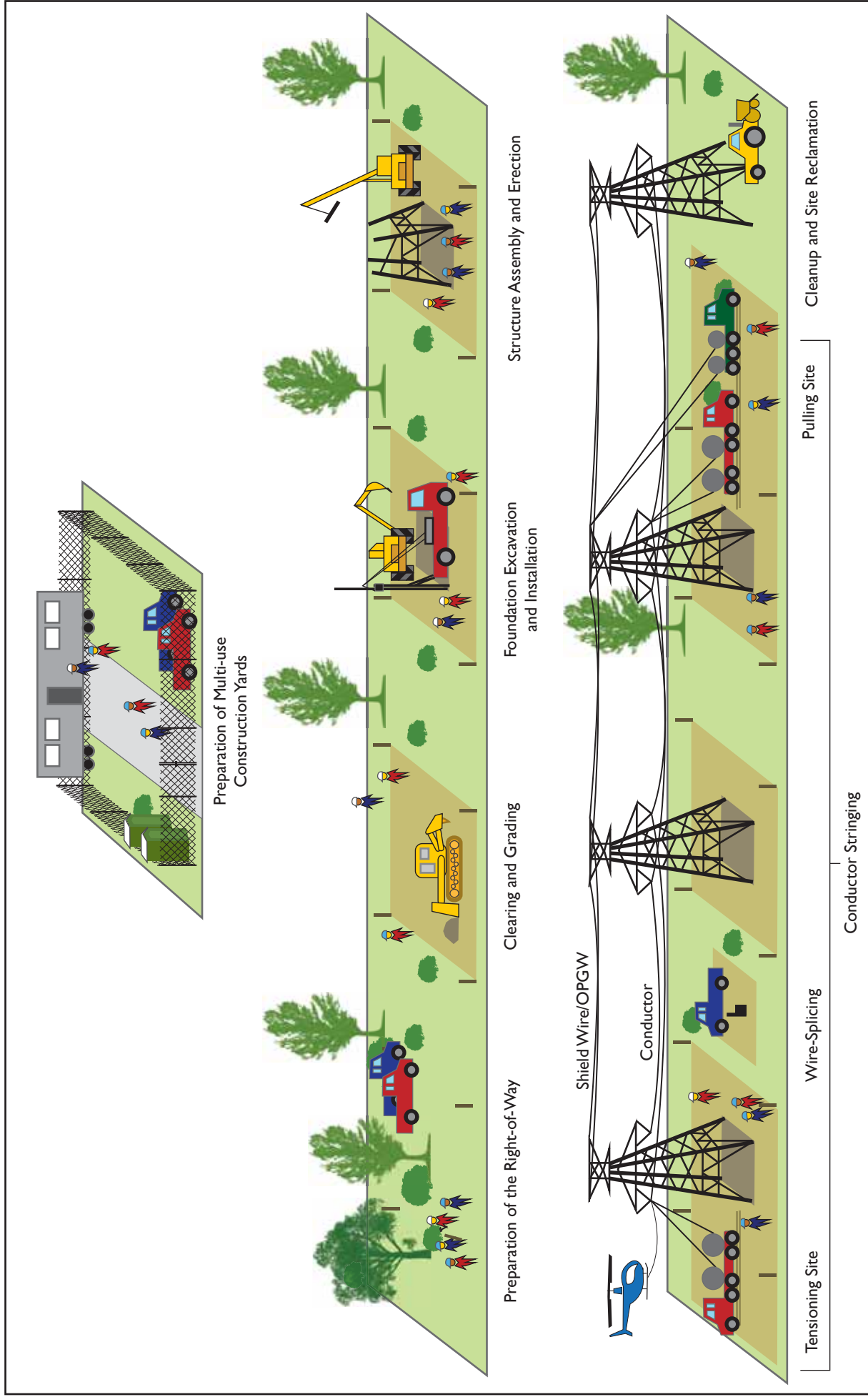

Figure 2-29
HVDC Transmission Line Construction Sequence
Plains & Eastern Clean Line
Oklahoma, Arkansas, and Tennessee

Appendix B

Environmental Protection Measures

This page intentionally left blank.

Environmental Protection Measures

for the

PLAINS & EASTERN
CLEAN LINE

June 2015
Revision 3

Subject to Revision

Prepared by:

CLEAN LINE
ENERGY PARTNERS

Prepared for the Department of Energy
pursuant to 10 CFR 1021.215(b)(2)

This page intentionally left blank.

Acronyms and Abbreviations

AG	Agriculture Environmental Protection Measure
APLIC	Avian Power Line Interaction Committee
APP	Avian Protection Plan
Clean Line	Clean Line Energy Partners LLC of Houston, Texas, parent company of Plains and Eastern Clean Line LLC and Plains and Eastern Clean Line Oklahoma LLC
DOE	United States Department of Energy
FVW	Fish, Vegetation, and Wildlife Environmental Protection Measure
GE	General Environmental Protection Measure
GEO	Soils (geology) Environmental Protection Measure
LU	Land Use Environmental Protection Measure
NERC	North American Electric Reliability Corporation
Project, the	Plains & Eastern Clean Line transmission project
SPCC	Spill Prevention, Control, and Countermeasures
SWPPP	Storm Water Pollution Prevention Plan
TVMP	Transmission Vegetation Management Plan
W	Waters, Wetlands, and Floodplains Environmental Protection Measure

1.0 Introduction

Clean Line Energy Partners LLC of Houston, Texas, (parent company of Plains and Eastern Clean Line LLC and Plains and Eastern Clean Line Oklahoma LLC, which are two entities collectively referred to herein as Clean Line) is proposing to construct, own, and operate the Plains and Eastern Clean Line transmission project (the Project). Clean Line is providing this information to assist the United States Department of Energy (DOE) in preparing the Draft Environmental Impact Statement for the Project.

Clean Line will plan, coordinate, and conduct each of the Project phases in a manner that protects the quality of the environment. Clean Line will comply with applicable federal, state, and local laws, regulations, permits, and ordinances related to environmental protection. Clean Line will take corrective action as appropriate if a violation occurs.

2.0 Project Plans

Clean Line will develop and implement the following environmental-related plans to avoid or minimize effects to environmental resources from construction, operations and maintenance, and/or decommissioning as appropriate:

- Transportation and Traffic Management Plan. This plan will describe measures designed to avoid and/or minimize adverse effects associated with the existing transportation system.
- Blasting Plan. This plan will describe measures designed to minimize adverse effects due to blasting.
- Restoration Plan. This plan will describe post-construction activities to reclaim disturbed areas.
- Spill Prevention, Control and Countermeasures (SPCC) Plan. This plan will describe the measures designed to prevent, control, and clean up spills of hazardous materials.
- Storm Water Pollution Prevention Plan (SWPPP). This plan, consistent with federal and state regulations, will describe the practices, measures, and monitoring programs to control sedimentation, erosion, and runoff from disturbed areas.
- Transmission Vegetation Management Plan (TVMP). This plan, to be filed with the North American Electric Reliability Corporation (NERC), will describe how Clean Line will conduct work on its right-of-way to prevent outages due to vegetation.
- Avian Protection Plan (APP). This plan, consistent with Avian Power Line Interaction Committee (APLIC) guidelines, will describe a program of specific and comprehensive actions that, when implemented, reduce risk of avian mortality.
- Various cultural resources management planning documents, including historic properties identification plans, historic properties treatment plans and unanticipated discovery plans. These plans will set forth the process that Clean Line will use to identify, evaluate, and treat historic properties and cultural resources encountered during Project construction, operations and maintenance. Clean Line anticipates that these plans would be incorporated in a future Programmatic Agreement.

- Construction Security Plan. This plan will describe measures designed to avoid and/or minimize adverse effects associated with breaches in Project security during construction including terrorism, sabotage, vandalism, and theft. The plan will include provisions describing how the Project construction team will coordinate with state and local law enforcement agencies during construction to improve Project security and facilitate security incident response, if required.

3.0 Measures

Clean Line will develop and implement the following Environmental Protection Measures to avoid or minimize effects to environmental resources from construction, operations and maintenance, and/or decommissioning as appropriate. Clean Line will designate certain areas as “environmentally sensitive,” and take actions to avoid and/or minimize effects on these areas. Environmentally sensitive areas may include, for example, wetlands, certain water bodies, cultural resources, or wildlife habitat.

Categories of Environmental Protection Measures follow:

- General (GE) Measures;
- Land Use (LU) Measures;
- Soils (GEO) and Agriculture (AG) Measures;
- Fish, Vegetation and Wildlife (FVW) Measures; and
- Waters, Wetlands, and Floodplains (W).

3.1 General (GE) Measures

General (GE) Environmental Protection Measures				
Reference Number	Measure	Applicable Phase ¹		
		D/E	C	O&M
GE-1	Clean Line will train personnel on health, safety, and environmental matters. Training will include practices, techniques, and protocols required by federal and state regulations and applicable permits.	•	•	•
GE-2	Clean Line will design, construct, maintain, and operate the Project following current Avian and Power Line Interaction Committee guidelines to minimize risk of avian mortality.	•	•	•
GE-3	Clean Line will minimize clearing vegetation within the ROW, consistent with a Transmission Vegetation Management Plan filed with NERC, and applicable federal, state, and local regulations.	•	•	•
GE-4	Vegetation removed during clearing will be disposed of according to federal, state, and local regulations.		•	•
GE-5	Any herbicides used during construction and operations and maintenance will be applied according to label instructions and any federal, state, and local regulations.		•	•
GE-6	Clean Line will restrict vehicular travel to the ROW and other established areas within the construction, access, or maintenance easement(s).		•	•

General (GE) Environmental Protection Measures				
Reference Number	Measure	Applicable Phase ¹		
		D/E	C	O&M
GE-7	Roads not otherwise needed for maintenance and operations will be restored to preconstruction conditions. Restoration practices may include decompacting, recontouring, and re-seeding. Roads needed for maintenance and operations will be retained.		•	•
GE-8	Access controls (e.g., cattle guards, fences, gates) will be installed, maintained, repaired, replaced, or restored as required by regulation, road authority, or as agreed to by landowner.	•	•	•
GE-9	Clean Line will avoid and/or minimize damage to drainage features and other improvements such as ditches, culverts, levees, tiles, and terraces; however, if these features or improvements are inadvertently damaged, they will be repaired and or restored.	•	•	•
GE-10	Clean Line will work with landowners to repair damage caused by construction, operation, or maintenance activities of the Project. Repairs will take place in a timely manner, weather and landowner permitting.		•	•
GE-11	Clean Line will conduct construction, operation, and maintenance activities to minimize the creation of dust. This may include measures such as limitations on equipment, speed, and/or travel routes utilized. Water, dust palliative, gravel, combinations of these, or similar control measures may be used. Clean Line will implement measures to minimize the transfer of mud onto public roads.		•	•
GE-12	Clean Line will avoid remedial structures (e.g., capped areas, monitoring equipment, or treatment wells) on contaminated sites, Superfund sites, CERCLA remediation areas, and other similar areas. Workers will use appropriate protective equipment and appropriate safe working techniques when working at or near contaminated sites.		•	•
GE-13	Emergency and spill response equipment will be kept on hand during construction.		•	•
GE-14	Clean Line will restrict the refueling and maintenance of vehicles and the storage of fuels and hazardous chemicals within at least 100 feet from wetlands, surface waterbodies, and groundwater wells, or as otherwise required by federal, state, or local regulations.	•	•	•
GE-15	Waste generated during construction or maintenance, including solid waste, petroleum waste, and any potentially hazardous materials will be removed and taken to an authorized disposal facility.		•	•
GE-16	Where required by FAA, or in certain areas to protect aviator safety, Clean Line will mark structures and/or conductors and/or shield wires with high-visibility markers (i.e., marker balls or other FAA-approved devices).		•	•
GE-17	Clean Line will consider noise and radio/television interference in the design of bundle configurations and conductors. To minimize noise and radio/television interference, Clean Line will maintain tension on insulator assemblies and protect the conductor surface from damage during construction.	•	•	
GE-18	Clean Line will inspect the line from the ground and/or aircraft routinely. Damaged insulators or other equipment causing noise or radio/television interference will be identified and repaired or replaced.			•
GE-19	Clean Line will properly ground permanent structures (e.g., fences, gates) to reduce the potential for induced voltage and currents onto conductive objects in the ROW.	•	•	•

General (GE) Environmental Protection Measures				
Reference Number	Measure	Applicable Phase ¹		
		D/E	C	O&M
GE-20	Clean Line will conduct construction and scheduled maintenance activities on the facilities during daylight hours, except in rare circumstances that may include, for example, to address emergency or unsafe situations, to avoid adverse environmental effects, to minimize traffic disruptions, or to comply with regulatory or permit requirements.		•	•
GE-21	Clean Line will maintain construction equipment in good working order. Equipment and vehicles that show excessive emissions of exhaust gasses and particulates due to poor engine adjustments or other inefficient operating conditions will be repaired or adjusted.		•	•
GE-22	Clean Line will impose speed limits during construction for access roads (e.g., to reduce dust emissions, for safety reasons, and for protection of wildlife).		•	
GE-23	Clean Line will maximize the distance between stationary equipment and sensitive noise receptors consistent with engineering design criteria.		•	
GE-24	Clean Line will minimize the number and distance of travel routes for construction equipment near sensitive noise receptors.		•	
GE-25	Clean Line will turn off idling equipment when not in use.		•	•
GE-26	When needed, Clean Line will use guard structures, barriers, flaggers, and other traffic controls to minimize traffic delays and road closures.		•	
GE-27	Clean Line will minimize compaction of soils and rutting through appropriate use of construction equipment (e.g., low ground pressure equipment and temporary equipment mats).		•	•
GE-28	Hazardous materials and chemicals will be transported, stored, and disposed of according to federal, state, or local regulations or permit requirements.		•	•
GE-29	Clean Line will work with landowners and operators of active oil and gas wells, utilities, and other infrastructure to identify and verify the location of facilities and to minimize adverse impacts. Identification may include use of the One Call system and surveying of existing facilities.	•	•	•
GE-30	Clean Line will minimize the amount of time that any excavations remain open.		•	•
GE-31	Clean Line will provide sanitary toilets convenient to construction; these will be located greater than 100 feet from any stream or tributary or to any wetland. These facilities will be regularly serviced and maintained; waste disposal will be properly manifested. Employees will be notified of sanitation regulations and will be required to use sanitary facilities.		•	

Key:

C = Construction

CERCLA = Comprehensive Environmental Response, Compensation, and Liability Act

D/E = Design / Engineering

FAA = Federal Aviation Administration

NERC = North American Electric Reliability Corporation

O&M = Operations and Maintenance

ROW = right-of-way

3.2 Land Use (LU) Measures

Land Use (LU) Environmental Protection Measures				
Reference Number	Measure	Applicable Phase ¹		
		D/E	C	O&M
LU-1	Clean Line will work with landowners and operators to ensure that access is maintained as needed to existing operations (e.g., to oil/gas wells, private lands, agricultural areas, pastures, hunting leases).	•	•	•
LU-2	Clean Line will minimize the frequency and duration of road closures.		•	•
LU-3	Clean Line will work with landowners to avoid and minimize impacts to residential landscaping.	•	•	•
LU-4	Clean Line will coordinate with landowners to site access roads and temporary work areas to avoid and/or minimize impacts to existing operations and structures.	•	•	•
LU-5	Clean Line will make reasonable efforts, consistent with design criteria, to accommodate requests from individual landowners to adjust the siting of the ROW on their properties. These adjustments may include consideration of routes along or parallel to existing divisions of land (e.g., agricultural fields and parcel boundaries) and existing compatible linear infrastructure (e.g., roads, transmission lines, and pipelines), with the intent of reducing the impact of the ROW on private properties.	•		

Key:

C = Construction

D/E = Design / Engineering

O&M = Operations and Maintenance

ROW = right-of-way

3.3 Soils (GEO) and Agriculture (AG) Measures

Soils (GEO) and Agriculture (AG) Environmental Protection Measures				
Reference Number	Measure	Applicable Phase ¹		
		D/E	C	O&M
AG-1	Clean Line will avoid or minimize adverse effects to surface and subsurface irrigation and drainage systems (e.g., tiles). Clean Line will work with landowners to minimize the placement of structures in locations that would interfere with the operation of irrigation systems.	•	•	•
AG-2	Agricultural soils temporarily impacted by construction, operation, or maintenance activities will be restored to pre-activity conditions. For example, soil remediation efforts may include decompaction, recontouring, liming, tillage, fertilization, or use of other soil amendments.		•	•
AG-3	Clean Line will consult with landowners and/or tenants to identify the location and boundaries of agriculture or conservation reserve lands and to understand the criteria for maintaining the integrity of these committed lands.	•	•	•
AG-4	Clean Line will work with landowners and/or tenants to identify specialty agricultural crops or lands (e.g., certified organic crops or products that require special practices, techniques, or standards) that may require protection during construction, operation, or maintenance. Clean Line will avoid and/or minimize impacts that could jeopardize standards or certifications that support specialty croplands or farms.	•	•	•
AG-5	Clean Line will work with landowners and/or tenants to consider potential impacts to current aerial spraying or application (i.e., crop dusting) of herbicides, fungicides, pesticides, and fertilizers within or near the transmission ROW. Clean Line will avoid or minimize impacts to aerial spraying practices when routing and siting the transmission line and related infrastructure.	•	•	
AG-6	Clean Line will work with landowners to develop compensation for lost crop value caused by construction and/or maintenance.	•	•	•
AG-7	Clean Line will work with landowners and/or their representatives in the development of a site plan for each cropland farm on which construction or maintenance is to be performed.	•	•	•
GEO-1	Clean Line will stabilize slopes exposed by its activities to minimize erosion.		•	•

Key:

C = Construction

D/E = Design / Engineering

O&M = Operations and Maintenance

ROW = right-of-way

3.4 Fish, Vegetation, and Wildlife (FVW) Measures

Fish, Vegetation, and Wildlife (FVW) Environmental Protection Measures				
Reference Number	Measure	Applicable Phase ¹		
		D/E	C	O&M
FVW-1	Clean Line will identify environmentally sensitive vegetation (e.g., wetlands, protected plant species, riparian areas, large contiguous tracts of native prairie) and avoid and/or minimize impacts to these areas.	•	•	•
FVW-2	Clean Line will identify and implement measures to control and minimize the spread of non-native invasive species and noxious weeds.		•	•
FVW-3	Clean Line will clearly demarcate boundaries of environmentally sensitive areas during construction to increase visibility to construction crews.		•	
FVW-4	If construction- and/or decommissioning-related activities occur during the migratory bird breeding season, Clean Line will work with USFWS to identify migratory species of concern and conduct pre-construction surveys for active nests for such species. Clean Line will consult with USFWS and/or other resource agencies for guidance on seasonal and/or spatial restrictions designed to avoid and/or minimize adverse effects.		•	•
FVW-5	If construction occurs during important time periods (e.g., breeding, migration, etc.) or at close distances to environmentally sensitive areas with vegetation, wildlife, or aquatic resources, Clean Line will consult with USFWS and/or other resource agencies for guidance on seasonal and/or spatial restrictions designed to avoid and/or minimize adverse effects.		•	•
FVW-6	Clean Line will avoid and/or minimize construction within 300 feet of caves known to be occupied by threatened or endangered species.		•	

Key:

C = Construction

D/E = Design / Engineering

O&M = Operations and Maintenance

USFWS = United States Fish and Wildlife Service

3.5 Waters, Wetlands, and Floodplains (W) Measures

Waters, Wetlands, and Floodplains (W) Environmental Protection Measures				
Reference Number	Measure	Applicable Phase ¹		
		D/E	C	O&M
W-1	Clean Line will avoid and/or minimize construction of access roads in special interest waters.	•	•	•
W-2	Clean Line will identify, avoid, and/or minimize adverse effects to wetlands and waterbodies. Clean Line will not place structure foundations within the Ordinary High Water Mark of Waters of the United States.		•	
W-3	Clean Line will establish streamside management zones within 50 feet of both sides of intermittent and perennial streams and along margins of bodies of open water where removal of low-lying vegetation is minimized.	•	•	•
W-4	If used, Clean Line will selectively apply herbicides within streamside management zones.		•	•
W-5	Clean Line will construct access roads to minimize disruption of natural drainage patterns including perennial, intermittent, and ephemeral streams.		•	
W-6	Clean Line will not construct counterpoise or fiber optic cable trenches across waterbodies.	•	•	
W-7	Clean Line will locate spoil piles from foundation excavations and fiber optic cable trenches outside of streamside management zones.		•	
W-8	Dewatering will be conducted in a manner designed to prevent soil erosion (e.g., through discharge of water to vegetated areas and/or the use of flow control devices).		•	•
W-9	Clean Line will design converter station sites to avoid adverse changes to the base flood elevation within the 100-year floodplain.	•		
W-10	Clean Line will minimize fill for access roads and structure foundations within 100-year floodplains to avoid adverse changes to the base flood elevation.	•	•	•
W-11	Clean Line will locate and minimize impacts to groundwater wells and springs within the construction ROW.	•	•	•
W-12	If blasting is required within 150 feet of a spring or groundwater well, Clean Line will conduct preconstruction monitoring of yield and water quality in cooperation with the landowner. In the event of damage, Clean Line will arrange for a temporary water supply through a local supplier until a permanent solution is identified.		•	
W-13	If any groundwater wells are needed to support operational facilities, withdrawal volumes will be limited so as not to adversely affect supplies for other uses.		•	•
W-14	Clean Line will ensure that there is no off-site discharge of wastewater from temporary batch plant sites.		•	
W-15	Clean Line will seek to procure water from municipal water systems where such water supplies are within a reasonable haul distance; any other water required will be obtained through permitted sources or through supply agreements with landowners.		•	

Waters, Wetlands, and Floodplains (W) Environmental Protection Measures					
Reference		Applicable Phase ¹			
Number	Measure	D/E	C	O&M	

Key:

C = Construction

D/E = Design / Engineering

O&M = Operations and Maintenance

ROW = right-of-way

Appendix C

Workforce, Crews, Equipment, and Trips

This page intentionally left blank.

Figure 3-1

Resource loading per HVDC Converter Station Construction

Task	Crew Size	Crew Use In Month #																																							
		1	2	3	4	5	6	7	8	9	10	11	12	13	14	15	16	17	18	19	20	21	22	23	24	25	26	27	28	29	30	31	32								
Site Management	20	0.1	0.25	0.25	0.5	1	1	1	1	1	1	1	1	1	1	1	1	1	1	1	1	1	1	1	1	1	1	1	1	1	1	1	1	1	1	1	1	1	1		
Surveyors	5	0.25	0.5	1	1	1	1	1	1	1	1	1	1	1	1	1	1	1	1	1	1	1	1	1	1	1	1	1	1	1	1	1	1	1	1	1	1	1	1		
Site Development	61	0.2	0.25	0.25	0.5	0.75	1	1	1	1	1	1	1	1	1	1	1	1	1	1	1	1	1	1	1	1	1	1	1	1	1	1	1	1	1	1	1	1	1	1	
Fence Installation	22			0.25	0.25	0.75	1	1	1	0.5	0.25																														
Equipment Footings	65					0.25	0.25	0.5	0.5	0.5	0.75	1	1	1	1	1	1	1	1	1	1	1	1	1	1	1	1	1	1	1	1	1	1	1	1	1	1	1	1	1	
Cable Trench, Conduits, Grounding	30					0.25	0.5	0.75	0.75	1	1	1	1	1	1	1	1	1	1	1	1	1	1	1	1	1	1	1	1	1	1	1	1	1	1	1	1	1	1	1	1
Steel Structures, Electrical Equipment	42					0.25	0.25	0.25	0.5	0.75	0.75	1	1	1	1	1	1	1	1	1	1	1	1	1	1	1	1	1	1	1	1	1	1	1	1	1	1	1	1	1	1
Control Building and Wiring	36																																								
Traffic Control	5		0.5	0.5	0.5	0.75	1	1	1	1	1	1	1	1	1	1	1	1	1	1	1	1	1	1	1	1	1	1	1	1	1	1	1	1	1	1	1	1	1	1	
Construction Inspection	5	0.25	0.25	0.25	0.5	1	1	1	1	1	1	1	1	1	1	1	1	1	1	1	1	1	1	1	1	1	1	1	1	1	1	1	1	1	1	1	1	1	1	1	
Materials Testing	5	0.25	0.25	0.5	0.5	0.5	1	1	1	1	1	1	1	1	1	1	1	1	1	1	1	1	1	1	1	1	1	1	1	1	1	1	1	1	1	1	1	1	1	1	
Total Workers	18	28	37	66	133	165	189	199	206	217	228	238	238	238	232	241	242	240	216	207	180	140	133	94	92	92	83	64	54	54	37	27	27	22							

Total Duration (in weeks): 128
 Total Number of Work Days: 640
 Weekly Work Schedule (day/wk): 5
 Avg. Number of Workers: 139
 Daily Work Schedule (hr/day): 8
 Max. Number of Workers: 242

Figure 3-2

Peak Local Traffic Per HVDC Converter Station Construction

Estimated Peak Daily Trips (Local Roads)	# People / Crew	# crews @ peak month	Personal Vehicles						Construction Vehicles										Trip Length Unpaved Rds (miles)	Trip Length Paved Rds (miles)	
			ppl/veh	Number veh	Trips / veh	Total Trips/Day	Trip Length Unpaved Rds (miles)	Trip Length Paved Rds (miles)	Light Const. Vehicles per crew	Trips per crew	Total Trips/Day (light)	Trip Length Unpaved Rds (miles)	Trip Length Paved Rds (miles)	Heavy Const. Vehicles	Trips	Total Trips/Day (heavy)	Trip Length Unpaved Rds (miles)	Trip Length Paved Rds (miles)			Total Construct ion Trips
Crow	20	1	1.5	9	2	18	32	599	5	6	30	23	428	0	0	0	0	0	30	23	428
Site Management	5	1	0	0	0	0	0	0	3	4	12	21	399	0	0	0	0	0	12	21	399
Surveyors	61	0.5	2	6	2	12	21	399	10	4	20	15	285	17	10	85	64	1211	105	79	1496
Site Development	22	0	2	0	2	0	0	0	6	36	0	0	0	3	4	12	9	171	12	9	171
Fence Installation	65	1	2	23	2	46	81	1530	10	4	40	30	570	12	8	96	72	1368	136	102	1938
Equipment Footings	30	1	2	7	2	14	25	466	8	4	32	24	456	2	0	0	0	0	32	24	456
Cable Trench, Conduits, Grounding	42	1	2	11	2	22	39	732	10	4	40	30	570	11	1	11	8	157	51	38	727
Steel Structures, Electrical Equipment	36	1	2	9	2	18	32	599	9	4	36	27	513	4	2	8	6	114	44	33	627
Control Building and Wiring	5	1	2	1	2	2	4	67	3	4	12	9	171	0	0	0	0	0	12	9	171
Traffic Control	5	1	0	0	0	0	0	0	4	4	16	12	228	0	0	0	0	0	16	12	228
Construction Inspection	5	0.75	0	0	0	0	0	0	4	4	12	9	171	0	0	0	0	0	12	9	171
Materials Testing																					
Totals per converter station						132					250								462		
Total per multi-use area						26					50								92		
Total personal veh trips /day / work site											132										
Total light construction veh trips /day /work site											250										
Total heavy construction veh trips /day /work site											462										
Total veh trips /day /work site											844										

Assumes Month 16 is peak month

Figure 3-3

Local vs Non-Local Labor (HVDC Converter Station)

Task	Crew Size	% Local	% Non Local	Average Crews over 32 months
Site Management	20	50	50	0.53
Surveyors	5	100	0	0.66
Site Development	61	100	0	0.50
Fence Installation	22	100	0	0.16
Equipment Footings	65	25	75	0.45
Cable Trench, Conduits, Grounding	30	25	75	0.54
Steel Structures, Electrical Equipment	42	25	75	0.55
Control Building and Wiring	36	50	50	0.35
Traffic Control	5	100	0	0.60
Construction Inspection	5	0	100	0.59
Materials Testing	5	100	0	0.57
Total				
% Local				52%
% Non-Local				48%

Local = Within 200 Miles of Project Limits

Figure 3-4

Equipment Emissions Calculation Data Sheet (HVDC Converter Station)

Project Description:		HVDC Converter Station - Typical	
Construction Phase:			
Phase Start Date:			
Phase End Date:			
Total Duration (in weeks):	5	Weekly Work Schedule (day/week):	5
Total Number of Work Days:	640	Daily Work Schedule (Friday):	8
Avg. Number of Workers:	139	Max. Number of Workers:	242
Total Disturbed Area (acres):	70	Avg. Disturbed Area per Day (acres):	30
Max. Disturbed Area per Day (acres):	70		

NON-ROAD EQUIPMENT

Equipment Description ¹	No. of Units	Engine Rating per Unit (hp)	Fuel Type	Daily Operation per Unit ² (hrs/day)	Average Engine Load ³ (%)	Total Work Days per Unit
Air Compressor	5	197	D	6	59	322
All Terrain Vehicle (ATV)	6	22	D	5	21	376
Bobcat/Skid Loader	8	49	D	6	59	347
Boom Lift	4	110	D	6	43	391
Bulldozer (D-8 Cat or Equivalent)	1	305	D	8	59	350
Bulldozer (D-4 Cat or Equivalent)	1	85	D	8	59	350
Concrete Line Pump	3	40	D	6	59	246
Excavator Mini	8	20	D	8	59	347
Excavator 100 Series	10	81	D	8	59	347
Excavator 300 Series	4	115	D	8	59	350
Flat mower or Bush hog	0	50	D	0	21	0
Fork Lift	0	300	D	6	59	0
Forklift (Telescopic)	10	100	D	8	59	283
Generator	6	43	D	6	59	360
Wheel Loader (6 CV)	6	300	D	8	21	338
Loader Backhoe	17	80	D	8	21	369
Motor Grader	4	297	D	6	59	350
Office Trailer	5	43	D	10	21	367
Plate Compactor	14	8	G	6	43	334
Road Sweeper	1	50	D	4	43	350
Scraper	8	407	D	8	59	350
Single-Drum Pulver (Large)	0	210	D	6	21	0
Trencher	6	80	D	8	21	336
Articulated Dump Truck	2	1300	D	8	43	350
Vibratory Compactor	8	133	D	8	43	348
Wagon Drill	0	N/A	N/A	6	N/A	0
Wire Reel Trailer	0	N/A	N/A	8	N/A	0

- Notes:
- As applicable, list the same equipment of different sizes, fuel types, daily operation, load, or total days on separate lines.
 - Daily operation refers to the amount of time equipment is operating each day, not the amount of time on-site.
 - If engine load data is not available, load will be estimated based on published nonroad equipment inventories.

ON-ROAD EQUIPMENT

Vehicle Description	No. of Units	Travel on Unpaved Roads per Roundtrip ¹ (miles)	Paved Roads per Roundtrip ¹ (miles)	Roundtrips per Day per Unit	Total Work Days per Unit	Vehicle Class ²
Concrete Truck	7	1.5	28.5	5	226	8
Concrete Pump Truck	2	1.5	28.5	1	314	8
Crane (15-ton Boom Truck)	2	1.5	28.5	0.5	391	7
Crane (80-ton)	2	1.5	28.5	0.5	391	7
Crane (120- to 300-ton)	4	1.5	28.5	1	320	8
Dump Truck	15	1.5	28.5	6	343	7
Fuel Truck	3	1.5	28.5	2	351	7
Welder Truck	4	1.5	28.5	2	391	4
Lowboy Truck	4	1.5	28.5	6	332	4
Mechanics' Truck	4	1.5	28.5	2	332	4
Pickup Truck	45	1.5	28.5	2	353	2
Splicing Truck	1	1.5	28.5	1	250	3
Truck (1-ton)	16	1.5	28.5	4	6	3
Truck (2-ton)	8	1.5	28.5	2	353	2
Utility Van	4	1.5	28.5	2	250	3
Water Truck	2	1.5	28.5	5	350	7

- Notes:
- Estimate of the average travel distance during a single work day.
 - See types of Vehicle Class in attached Table 1

WORKER COMMUTING

Number of Daily Workshifts:	1
Duration of Workshifts (hrs):	8
Average One-Way Worker Commute Distance (miles):	30
Percentage of Travel on Unpaved Roads (%):	5
Percentage of Workers Carpooling (%):	10
Percentage of Workers With Transportation Provided, e.g., buses (%):	5

COMMENTS

Estimate of crew size and equipment based on guidance from TGS

Figure 3-5

Resource loading per 140 mile HVDC segment

Task	Crew Size	Crew Use In Month #																												
		1	2	3	4	5	6	7	8	9	10	11	12	13	14	15	16	17	18	19	20	21	22	23	24					
ROW Clearing	8	2	2	2	2	2	2																							
Access Roads & Pads	8	2	2	2	2	2	2																							
Foundation Construction	5	2	2	5	5	5	5	5	5	5	5	5																		
Tower Lacing (assembly)	16		3	8	8	8	8	8	8	8	8	8																		
Tower Setting (erection)	8		3	5	5	5	5	5	5	8	8	8																		
Wire Stringing	26												2	2	2	2	2	2	2	2	2	2	2	2	1					
Restoration	4				1	1	1	1	1	1	1	2	1	1	1	1	1	1	1	1	1	1	1	1	1					
Supervision	2	2	2	2	2	2	2	2	2	2	2	2	2	2	2	2	2	2	2	2	2	2	2	2	1					
Materials Management	4	2	3	5	5	5	5	5	5	5	5	5	5	5	5	5	5	5	5	5	5	5	5	5	1					
Mechanic & Equipment Mgmt.	1	2	2	2	2	2	2	2	2	2	2	2	2	2	2	2	2	2	2	2	2	2	2	2	1					
Refueling	1	2	2	2	2	2	2	2	2	2	2	2	2	2	2	2	2	2	2	2	2	2	2	2	2					
Watering & Dust Control	2	2	2	2	2	2	2	2	2	2	2	2	2	2	2	2	2	2	2	2	2	2	2	2	2					
Blasting	0																													
Construction Inspection	1	3	4	5	5	5	5	5	5	5	5	5	5	5	5	5	5	5	5	5	5	5	5	5	5					
Materials Testing	1	3	4	5	5	5	5	5	5	5	5	5	2	1																
ENV Compliance	1	3	3	3	3	3	3	3	3	3	3	3	3	3	3	3	3	3	3	3	3	3	3	3	1					
Surveyors	2	3	3	3	3	3	3	3	3	3	3	3	2	2	2	2	2	2	2	2	2	2	2	2						
Sanitation/ Cleanup	2	3	5	5	5	5	5	5	5	5	5	5	5	5	5	5	5	5	5	5	5	5	5	5	5					
Total Crews		31	42	56	57	57	57	57	57	53	53	53	53	53	53	52	53	46	41	40	40	40	38	34	29	29	29	28	28	19
Total Workers		83	165	286	290	290	290	258	258	234	234	232	236	256	230	229	229	224	174	144	144	144	144	144	144	144	140	140	55	

Figure 3-6

Resource Loading for AC Collection System

Task	Crew Size	Crew Use in Month #																							
		1	2	3	4	5	6	7	8	9	10	11	12	13	14	15	16	17	18	19	20	21	22	23	24
ROW Clearing	8	2,949	2,949	2,949	2,949	2,949	2,949																		
Access Roads & Pads	8	2,949	2,949	2,949	2,949	2,949	2,949																		
Foundation Construction	5	2,949	2,949	7,371	7,371	7,371	7,371	7,371	7,371	7,371	7,371	7,371													
Tower Lacing (assembly)	16		4,423	11,79	11,79	11,79	11,79	11,79	11,79	7,371	7,371	7,371	7,371	7,371	7,371	7,371	7,371	7,371	7,371	7,371	7,371	7,371	7,371	7,371	
Tower Setting (erection)	8		4,423	7,371	7,371	7,371	7,371	7,371	7,371	7,371	7,371	7,371	7,371	7,371	7,371	7,371	7,371	7,371	7,371	7,371	7,371	7,371	7,371	7,371	
Wire Stringing	26																								
Restoration	4				1,474	1,474	1,474	1,474	1,474	1,474	1,474	1,474	1,474	1,474	1,474	1,474	1,474	1,474	1,474	1,474	1,474	1,474	1,474	1,474	
Supervision	2	2,949	2,949	2,949	2,949	2,949	2,949	2,949	2,949	2,949	2,949	2,949	2,949	2,949	2,949	2,949	2,949	2,949	2,949	2,949	2,949	2,949	2,949	2,949	
Materials Management	4	2,949	4,423	7,371	7,371	7,371	7,371	7,371	7,371	7,371	7,371	7,371	7,371	7,371	7,371	7,371	7,371	7,371	7,371	7,371	7,371	7,371	7,371	7,371	
Mechanic & Equipment Mgmt.	1	2,949	2,949	2,949	2,949	2,949	2,949	2,949	2,949	2,949	2,949	2,949	2,949	2,949	2,949	2,949	2,949	2,949	2,949	2,949	2,949	2,949	2,949	2,949	
Refueling	1	2,949	2,949	2,949	2,949	2,949	2,949	2,949	2,949	2,949	2,949	2,949	2,949	2,949	2,949	2,949	2,949	2,949	2,949	2,949	2,949	2,949	2,949	2,949	
Watering & Dust Control	2	2,949	2,949	2,949	2,949	2,949	2,949	2,949	2,949	2,949	2,949	2,949	2,949	2,949	2,949	2,949	2,949	2,949	2,949	2,949	2,949	2,949	2,949	2,949	
Blasting	0																								
Construction Inspection	1	4,423	5,897	7,371	7,371	7,371	7,371	7,371	7,371	7,371	7,371	7,371	7,371	7,371	7,371	7,371	7,371	7,371	7,371	7,371	7,371	7,371	7,371	7,371	
Materials Testing	1	4,423	5,897	7,371	7,371	7,371	7,371	7,371	7,371	7,371	7,371	7,371	7,371	7,371	7,371	7,371	7,371	7,371	7,371	7,371	7,371	7,371	7,371	7,371	
ENV Compliance	1	4,423	4,423	4,423	4,423	4,423	4,423	4,423	4,423	4,423	4,423	4,423	4,423	4,423	4,423	4,423	4,423	4,423	4,423	4,423	4,423	4,423	4,423	4,423	
Surveyors	2	4,423	4,423	4,423	4,423	4,423	4,423	4,423	4,423	4,423	4,423	4,423	4,423	4,423	4,423	4,423	4,423	4,423	4,423	4,423	4,423	4,423	4,423	4,423	
Sanitation/ Cleanup	2	4,423	7,371	7,371	7,371	7,371	7,371	7,371	7,371	7,371	7,371	7,371	7,371	7,371	7,371	7,371	7,371	7,371	7,371	7,371	7,371	7,371	7,371	7,371	
Total Crews		45.7	61.92	82.56	84.03	84.03	84.03	84.03	84.03	84.03	84.03	84.03	84.03	84.03	84.03	84.03	84.03	84.03	84.03	84.03	84.03	84.03	84.03	84.03	
Total Workers		122	243	422	428	428	428	428	428	428	428	428	428	428	428	428	428	428	428	428	428	428	428	428	

AC collection system mileage assumed to be 206.4 miles

Crew totals are from resource loading for 140 mile HVDC segment, scaled to AC collection system mileage

Figure 3-7

Peak Local Traffic Per 140 Mile HVDC Segment																					
Estimated Peak Daily Trips (Local Roads)																					
Crew	# People / Crew	# crews @ peak month	pph/veh	Personal Vehicles					Construction Vehicles												
				Number Veh	Trips / Veh	Total Trips/Day	Trip Length Unpaved Rds (miles)	Trip Length Paved Rds (miles)	Light Const. Vehicles per crew	Trips per crew	Total Trips/Day (light)	Trip Length Unpaved Rds (miles)	Trip Length Paved Rds (miles)	Heavy Const. Vehicles	Total Trips/Day (heavy)	Trip Length Unpaved Rds (miles)	Trip Length Paved Rds (miles)	Total Construct Ion Trips	Trip Length Unpaved Rds (miles)	Trip Length Paved Rds (miles)	
ROW Clearing	8	2	2	8	2	16	140	420	4	6	48	185	540	2	4	16	70	180	64	255	720
Access Roads & Pads	8	2	2	8	2	16	140	420	4	4	32	135	360	4	2	16	75	180	48	210	540
Foundation Construction	5	5	2	13	2	26	228	683	2	3	30	113	338	5	2	50	385	1125	80	498	1463
Tower Lacing (assembly)	16	8	2	64	2	128	1120	3360	4	2	64	240	720	0	0	0	0	0	64	240	720
Tower Setting (erection)	8	5	2	20	2	40	350	1050	4	2	40	150	450	1	2	10	38	113	50	188	563
Wire Stringing	26	0	2	0	2	0	0	0	4	4	0	0	0	4	4	0	0	0	0	0	0
Restoration	4	1	2	2	2	4	35	105	2	3	12	50	135	2	4	8	35	90	20	85	225
Supervision	2	2	0	0	0	0	0	0	2	6	24	105	270	0	0	0	0	0	24	105	270
Materials Management	4	5	2	10	2	20	175	525	4	4	80	315	900	6	2	60	225	675	140	540	1575
Mechanic & Equipment Mgmt.	1	2	1	2	2	4	35	105	1	3	6	23	68	1	3	6	23	68	12	45	135
Refueling	1	2	1	2	2	4	35	105	0	0	0	0	0	2	8	16	75	180	16	75	180
Watering & Dust Control	1	2	1	2	2	4	35	105	0	0	0	0	0	2	8	32	135	360	32	135	360
Blasting	0	0	0	0	0	0	0	0	0	0	0	0	0	0	0	0	0	0	0	0	0
Construction Inspection	1	5	0	0	0	0	0	0	1	6	30	148	383	0	0	0	0	0	30	148	383
Materials Testing	1	5	0	0	0	0	0	0	1	4	20	110	270	0	0	0	0	0	20	110	270
ENV Compliance	1	3	0	0	0	0	0	0	1	5	15	91	214	0	0	0	0	0	15	91	214
Surveyors	2	3	0	0	0	0	0	0	1	5	15	91	214	0	0	0	0	0	15	91	214
Sanitation/Cleanup	2	5	2	5	2	10	88	263	1	3	15	76	169	1	4	20	90	225	35	166	394
Totals per 140 mi segment (work site)						272					431								665		
Totals Per multi-use area						54					86								133		
Total Personal veh trips /day / work site						272					431								665		
Total light construction veh trips /day /work site											431								133		
Total heavy construction veh trips /day /work site											665								133		
Total veh trips /day /work site											1368								1368		

Peak months are 4-6

Figure 3-8

Local vs Non-Local Labor (140 mile HVDC segment)

Task	Crew Size	% Local	% Non Local	Average Crews over 24 months
ROW Clearing	8	100	0	0.50
Access Roads & Pads	8	100	0	0.50
Foundation Construction	5	100	0	2.25
Tower Lacing (assembly)	16	25	75	4.50
Tower Setting (erection)	8	25	75	4.50
Wire Stringing	26	25	75	0.96
Restoration	4	100	0	0.92
Supervision	2	0	100	1.96
Materials Management	4	67	33	4.00
Mechanic & Equipment Mgmt.	1	100	0	1.96
Refueling	1	100	0	2.00
Watering & Dust Control	2	100	0	2.00
Blasting	0	0	100	0.00
Construction Inspection	1	0	100	4.88
Materials Testing	1	100	0	2.50
ENV Compliance	1	100	0	2.21
Surveyors	2	100	0	1.96
Sanitation/ Cleanup	2	100	0	4.83
Total				
% Local				45%
% Non-Local				55%

Local = Within 200 Miles of Project Limits

Example of Typical Construction Activities and Durations on Agricultural Property

The following example timeline describes a typical construction sequence that could occur on a single parcel currently in agricultural use (with row crop or hay / grass pasture). This hypothetical situation assumes the following: 0.5 miles of HVDC right-of-way (ROW) on the parcel; two tangent lattice structures are planned within the parcel; no grading is needed; and access is obtained by driving only within the ROW from adjoining parcels through existing gates. The following timeline also assumes that the ROW has been surveyed and the clearing boundaries have been staked. The timeline describes the major planned activities associated with construction. During the construction period, other activities, usually smaller in scale (such as inspections or monitoring) may require intermittent access to and presence in the ROW between the activities listed below. Note that there will be breaks in the construction process. The duration of these breaks may vary from the periods identified below.

Typical Construction Activities on Agricultural Property			
Activity	Access typically restricted?	Day	Description
ROW mowing and/or clearing	Yes	1 to 2	Mowing equipment enters from adjoining parcel and mows portions of the ROW. The area mowed would include an access path down the ROW (approximately 16 to 35 feet wide) and two areas (each 100 x 100 ft) for future structure construction pads. Access to the construction area is restricted during mowing operations for safety.
None	No	3 to 14	There is a period of inactivity between mowing and/or clearing (above) and the beginning of surveying and staking (below). This period may be shorter or longer depending on construction schedule.
Survey and staking	No	15	A survey crew stakes each structure location with wooden lath.
Install storm water protection measures	No	16	According to state requirements, any storm water protection measures (e.g., silt fences) are installed. Silt fences would be discontinuous, and would not limit livestock movement. This typically requires one or two pickup trucks with trailers, possibly a small excavator, and a small crew of workers.
Drill and pour foundations	Partially	17 to 19	Auger equipment drills holes for footings, rebar cages are set, concrete trucks delivery concrete to the pad, stub angles are set, and concrete is poured into holes and mold surrounding stub angles. Access is prohibited in a small area within a protective fence around foundation sites, and periodically restricted around the construction area for safety due to the movement of trucks and other equipment.
None (Concrete curing)	Partially	20 to 22	Access to ROW is not restricted, except for a small area within a protective fence around foundation sites.

Typical Construction Activities on Agricultural Property			
Activity	Access typically restricted?	Day	Description
Remove concrete forms	Partially	23	Access to ROW is not restricted, except for a small area within a protective fence around foundation sites.
None (Concrete curing)	Partially	24 to 33	Access to ROW is not restricted, except for a small area within a protective fence around foundation sites.
Equipment set up, assembly, and structure erection	Partially	34 to 41	Structure material delivered to each structure site with a heavy truck, structure sections are assembled, and sections are lifted by crane and set into place. Access to ROW may be periodically restricted around the construction area for safety due to the movement of trucks, cranes, and other equipment.
Insulator assemblies fixed to structure	Partially	42	Insulators and associated hardware are pre-assembled into strings, strings are then lifted by crane or lift truck and fixed to tower arms. Access to ROW is periodically restricted around the construction area for safety due to the movement of trucks, cranes, and other equipment.
None	Partially	42 to 86	There is a period of inactivity between the end of insulator installation (above) and the beginning of wire stringing (below). This period may be shorter or longer depending on location and site conditions. During this period, access to the ROW outside of the structure pads is unrestricted.
Sock and Pilot line threading	Yes	87	A helicopter lifts a light weight sock/pilot line, which is threaded through rollers attached to the insulators. During stringing operations, access to the ROW is restricted for safety.
Conductor pulling and tensioning	Yes	88 to 92	Conductor is attached to the end of the sock/pilot and pulled through. Pulling and tensioning equipment (located on other parcels in this example) ensure that the proper clearance and sag is achieved for each span of the conductor. During stringing operations, access to the ROW is restricted for safety.
Clipping in	Yes	93	Conductor is permanently attached ("clipped in") to hardware connection at the end of insulator strings using one to three bucket trucks. Access to ROW is periodically restricted around the construction area for safety due to the movement of trucks and other equipment.
None	No	94 to 122	There is a period of inactivity between the end of clipping in and the start of final restoration activities. This lag could be considerably shorter, depending on season and site conditions.

Typical Construction Activities on Agricultural Property			
Activity	Access typically restricted?	Day	Description
ROW restoration	Partially	123 to 130	Repair of construction damage occurs, which may include re-seeding, recontouring, and restoration of drainage patterns. In row crop areas, this may also include decompaction, ripping, and/or tilling to restore ROW. Access to ROW is periodically restricted around the construction area due to the movement of trucks and other equipment for safety.
Vegetation Re-establishment	No	131 –	Depending on site conditions, vegetation will be allowed to become reestablished. Depending on the season, for row crops areas, crops or cover crops could be planted or re-established following restoration. Any storm water protection measures are removed after the site meets or exceeds state reclamation thresholds.

Appendix D

Drilling Fluids

This page intentionally left blank.



MATERIAL SAFETY DATA SHEET
OSHA Hazard Communication Standard
29 CFR 1910.12000

U. S. Department of Labor
Occupational Safety and Health Adm.
OMB 1218-0072

Identity (used on label): High Yield Bentonite Gel

SECTION I

Manufacturer :	PDSCo P.O. BOX 507, 105 West Sharp Street El Dorado, AR 71730	Emergency Phone :	(800) 243-7455
		Information Phone :	(870) 863-5707

SECTION II HAZARDOUS INGREDIENTS

Hazardous Components	OSHA PEL	TLV	Other Limits	%
Crystalline Quartz CAS# 14808-60-7 (naturally occurring contaminant)	-	-	*	2-6%
Respirable Crystalline Quartz			NIOSH	
present (TWA)	0.1 mg/m ³	0.1 mg/m ³	50ug/m ³	<2%
proposed (TWA)	-	50ug/m ³	-	-
Nuisance Dust				
Respirable	5 mg/ m ³	5 mg/ m ³	-	-
Total Dust	15 mg/ m ³	10 mg/ m ³	-	-

* **Warning:** This product contains a small amount of crystalline silica which may cause delayed respiratory disease if inhaled over a prolonged period of time. Avoid breathing dust. Use NOISH/MSHA approved respirator when TLV for crystalline silica may be exceeded. IARC Monographs on the evaluation of the Carcinogenic Risk of Chemicals to Humans (volume 42, 1987) concludes that there is "limit evidence" of the carcinogenicity of crystalline silica to humans. IARC classification 2A.

SECTION III PHYSICAL CHEMICAL CHARACTERISTICS

Boiling Point	:	N/A
Vapor Pressure (mm Hg at 20°C)	:	N/A
Vapor Density (Air = 1)	:	N/A
Solubility in Water	:	Negligible
Appearance & Odor	:	Pale grey to buff powder or granules, odorless.
Specific Gravity	:	2.5
Melting Point	:	N/A
Evaporation Rate	:	N/A

SECTION IV FIRE AND EXPLOSION HAZARD DATA

Flash Point	:	N/A
Flammable Limit	:	N/A
LEL	:	N/A
UEL	:	N/A
Extinguishing Media	:	Not Applicable
Special Fire Fighting Procedure	:	Inorganic mineral/non-flammable.
Unusual Fire and Explosion Hazards	:	N/A

SECTION V REACTIVITY DATA

Stability	:	Unstable				Stable		X	
Conditions to Avoid	:	None Known							
Materials to Avoid	:	None Known							
Hazardous Decomposition	:	None Known							
Hazardous Polymerization	:	May Occur				Will Not Occur		X	

SECTION VI HEALTH HAZARD DATA

Routes of Entry	:	Inhalation: Yes	Skin: No	Ingestion: No	
Health Hazards (Acute-Chronic)	:	May cause delayed respiratory disease if dust inhaled over a prolonged period of time.			
Carcinogenicity	:	N/A	NTP: No	IARC: Yes	OSHA Req: No
		IARC Monographs on the evaluation of the Carcinogenic Risk of Chemicals to Humans (volume 42, 1987) concludes that there is "limited evidence" of the carcinogenicity of crystalline silica to humans. IARC classification 2A.			
Sighs and Symptoms of Exposure	:	Excessive inhalation of dust may result in shortness of breath and reduced pulmonary function.			
Conditions Aggravated by Exposure	:	Individuals with pulmonary and/or respiratory disease including but not limited to asthma and bronchitis be precluded from exposure to dust.			
Emergency First Aid	:	Eyes: Flush with water. Gross inhalation of dust: Remove to fresh air. Give oxygen or artificial respiration if necessary. Get medical attention immediately.			

SECTION VII PRECAUTIONS FOR SALE HANDLING AND USE

In Case Released or Spilled	:	Vacuum if possible to avoid generating airborne dust. Avoid breathing duct. Wear an approved respirator. Avoid adding water, the product will become slippery when wet.
Waste Disposal	:	Consult appropriate Federal, State, and Local regulatory agencies to ascertain proper disposal procedures.
Caution In Handling and Storing	:	Avoid breathing dust, use NOISH/MSHA approved respirator when TLV limits for Crystalline Silica may be exceeded.
Other Precautions	:	Slippery when wet.

SECTION VIII CONTROL MEASURES

Respiratory Protection	:	OSHA standard 1910.134 or ANSI Z88.2-1980 specification.
Ventilation	:	Local and mechanical exhaust as appropriate.
Protective Gloves	:	Not Required.
Eye Protection	:	Recommended.
Other Protection Equipment	:	Not required for normal use.
Work/Hygienic Practices	:	Normal personal hygiene required.



MATERIAL SAFETY DATA

1. CHEMICAL PRODUCT AND COMPANY IDENTIFICATION

PRODUCT NAME : **Super Mud**
SYNONYMS : Anionic polyacrylamide in water-in-oil emulsion
CHEMICAL FAMILY : Anionic polyacrylamide copolymer
MOLECULAR FORMULA : Mixture
MOLECULAR WEIGHT : Mixture

PDSCo, P.O. BOX 507, WEST SHARP STREET, EL DORADO, AR 71730 USA
EMERGENCY PHONE: For emergency call PDSCo: 1 (800) 243-7455

2. COMPOSITION/INFORMATION ON INGREDIENTS

OSHA REGULATED COMPONENTS				
COMPONENT	CAS. NO.	%	TWA/CEILING	REFERENCE
Petroleum distillate	064742-47-8	24	400 ppm	OSHA
Hydrotreated light				

3. HAZARDS IDENTIFICATION

EMERGENCY OVERVIEW

APPEARANCE AND ODOR : White, viscous, opaque liquid; slight hydrocarbon odor
STATEMENTS OF HAZARD : WARNING! MAY CAUSE SKIN IRRITATION
IMPORTANT! SPILLS OF THIS PRODUCT ARE VERY SLIPPERY WHEN WET

POTENTIAL HEALTH EFFECTS

EFFECTS OF OVEREXPOSURE:

Acute oral (rat) LD50 and acute dermal (rabbit) LD50 of > 10 ml/kg. Direct contact with this material may cause minimal eye and moderate skin irritation.

Refer to Section 11 for toxicology information on the OSHA regulated components of this product.

4. FIRST AID MEASURES

In case of skin contact, wash affected areas of skin with soap and water. Do not reuse clothing without laundering.

In case of eye contact, immediately irrigate with plenty of water for 15 minutes.

5. FIRE FIGHTING MEASURES

FLAMMABLE PROPERTIES

FLASH POINT : >200⁰F (>93.3⁰C) METHOD : Pensky-Martens Closed Cup
FLAMMABLE LIMITS
(% BY VOL) : Not applicable
AUTOIGNITION TEMP : Not available
DECOMPOSITION TEMP : Not available

EXTINGUISHING MEDIA AND FIRE FIGHTING INSTRUCTIONS

Use water spray, carbon dioxide or dry chemical to extinguish fires. Use water to keep containers cool. Wear self-contained, positive pressure breathing apparatus and full fire-fighting protective clothing. See Section 8 (Exposure Controls/Personal Protection) for special protective clothing.

6. ACCIDENTAL RELEASE MEASURES

STEPS TO BE TAKEN IN CASE MATERIAL IS RELEASED OR SPILLED

Cover spill with some inert absorbent material; sweep up and place in waste disposal container. Flush area thoroughly with water. Residual may be very slippery. If slipperiness remains, apply more dry-sweeping compound.

7. HANDLING AND STORAGE

Avoid contact with skin. Wash thoroughly after handling. To avoid product degradation and equipment corrosion, do not use iron, copper, or aluminum container or equipment. OSHA regulations (29 CFR 106.a.14), require that the flashpoint of materials of this type be determined by the Pensky-Martens Closed Tester method. The test for this product indicated it has flash point at >200°F (93.3°C); therefore, caution should be exercised in storage and handling.

8. EXPOSURE CONTROLS/PERSONAL PROTECTION

ENGINEERING CONTROLS AND PERSONAL PROTECTIVE EQUIPMENT (PPE)

Engineering controls are not usually necessary if good hygiene practices are followed. Before eating, drinking, or smoking, wash face and hands thoroughly with soap and water. Avoid unnecessary skin contact. Impervious gloves are recommended to prevent prolonged skin contact. For operations where eye or face contact can occur, eye protection is recommended.

9. PHYSICAL AND CHEMICAL PROPERTIES

APPEARANCE AND ODOR	:	White, viscous, opaque liquid; slight hydrocarbon odor.
BOILING POINT	:	~ 347°F; ~ 175°C (value for oil phase)
MELTING POINT	:	0°F; -18°C
VAPOR PRESSURE	:	Not available
SPECIFIC GRAVITY	:	1.0
VAPOR DENSITY	:	Not available
% VOLATILE (BY WT)	:	~ 70
pH	:	Not available
SATURATED IN AIR (BY VOL)	:	Not available
EVAPORATION RATE	:	<1 (Butyl Acetate = 1)
SOLUBILITY IN WATER	:	Appreciable

10. STABILITY AND REACTIVITY

STABILITY	:	Stable
CONDITIONS TO AVOID	:	None known
POLYMERIZATION	:	Will not occur
CONDITIONS TO AVOID	:	None known
INCOMPATIBLE MATERIALS	:	Strong oxidizing agents
HAZARDOUS DECOMPOSITION PRODUCTS	:	Thermal decomposition or combustion may produce carbon monoxide, carbon dioxide, ammonia, and/or oxides or nitrogen.

11. TOXICOLOGICAL INFORMATION

Toxicological information on the OSHA regulated components of this product is as follows:

Acute overexposure to petroleum distillate vapors may cause eye and throat irritation. On direct skin contact, petroleum distillate may produce a severe skin irritation.

12. ECOLOGICAL INFORMATION

No aquatic LC50, BOD, or COD data available.
 OCTANOL/H₂O PARTITION COEF: Not available

13. DISPOSAL CONSIDERATIONS

Disposal must be made in accordance with applicable governmental regulations.

14. TRANSPORT INFORMATION

	D.O.T SHIPPING INFORMATION	IMO SHIPPING INFORMATION
SHIPPING NAME :	Not applicable/Not Regulated	Not applicable/Not Regulated
HAZARD CLASS/ PACKING GROUP :	Not applicable	Not applicable
UN NUMBER :	Not applicable	Not applicable
IMDG PAGE :	Not applicable	Not applicable
D.O.T HAZARDOUS SUBSTANCES :	(Product Reportable Quantity) Not applicable	Not applicable
TRANSPORT LABEL REQUIRED :	None required	None required
	ICAO/IATA	TRANSPORT CANADA
SHIPPING NAME :	Not applicable	Not applicable
HAZARD CLASS :	Not applicable	Not applicable
SUBSIDIARY CLASS :	Not applicable	Not applicable
UN / ID NUMBER :	Not applicable	Not applicable
PACKING GROUP :	Not applicable	Not applicable
TRANSPORT LABEL REQUIRED :	None required	None required
PACKING INSTRUCTIONS :	Passenger Not applicable Cargo Not applicable	Not applicable
MAX NET QTY :	Passenger Not applicable Cargo Not applicable	Not applicable
	ADDITIONAL TRASPOT INFORMATION	
TECHNICAL NAME (N.O.S.) :	Not applicable	

15. REGULATORY INFORMATION

INVENTORY INFORMATION

- US TSCA : This product is manufactured in compliance with all provisions of the Toxic Substances control Act, 15 U.S.C.
- CANASA DSL : Components of this product have been reported to Environment Canada in accordance with subsection 25 of the Canadian Environmental Protection Act and are included on the Domestic Substances List.
- EEC EINECS : All components of this product are included on the European Inventory of Existing Chemical Substances [EINECS] in compliance with Council Directive 67/548/EEC, Amended 79/831/EEC.

OTHER ENVIRONMENTAL INFORMATION

The following components are defined as toxic chemicals subject to reporting requirements of Section 313 of Title III and of 40 CFR 372 or subject to other EPA regulations.

COMPONENT	CAS. NO.	%	TPQ(lbs)	RQ (lbs)	S313	RCRA	TSCA 12B
This product does not contain any components regulated under these sections of the EPA							

PRODUCT CLASSIFICATION UNDER SECTION 311 OF SARA
Not applicable under SARA TITLE III

16. OTHER INFORMATION

NFPA HAZARD RATING (National Fire Protection Association)

- Fire : FIRE : Materials that must be preheated before ignition can occur.
- 1 : HEALTH : Materials which on exposure under fire conditions would offer
- Health 0 0 Reactivity no hazard beyond that of ordinary combustible material.
- : REACTIVITY : Materials which in themselves are normally stable, even under
- Special fire exposure conditions, and which are not reactive with water.

This information is given without any warranty or representation. We do not assume any legal responsibility for same, nor do we give permission, inducement, or recommendation to practice any patented invention without a license. It is offered solely for your consideration, investigation, and verification. Before using any product, read its label.

SUPER MUD

• for Deep Foundation Construction •

Polymer Slurry & Additives
Slurry Testing Equipment
Technical Services



www.pdscoinc.com





POLYMER DRILLING SYSTEMS (PDS)

PDS produces a comprehensive line of high performance drilling fluids, specialized slurry additives and testing equipment for a variety of drilling, construction and excavation operations and has been the pioneer in developing and innovating polymer slurry technology for the deep foundations industry for over 20 years.

SYNTHETIC POLYMERS



SUPER MUD™ Liquid Polymer



SUPER MUD DRY™ Dry Granular Polymer

Super Mud and **Super Mud Dry** are highly concentrated synthetic polymers that are primarily used to create high viscosity slurries which stabilize excavations, maintain hole cleanliness and promote stronger load capacities. **Super Mud** slurries also simplify the process of slurry mixing, excavating, concrete placement and disposal. These slurries are environmentally friendly and recyclable.

ADVANTAGES

- Easy to mix and requires little or no mixing equipment
- Mixes in either fresh or saltwater
- Increases speed of production
- Reduces wear on tools and equipment
- Controls fluid loss
- Recyclable and reusable
- Lowers disposal costs
- Environmentally friendly



PERFORMANCE CHARACTERISTICS

Sand & Gravel – The polymer molecules form a matrix, binding these granular soil particles together.

Clay – Super Mud encapsulates clay preventing water from hydrating the clay plates and inhibits swelling.

Shale – Super Mud slurries are designed to prevent slaking in shales.



Unlike mineral slurries that leave seams of wall cake between concrete and soil, **Super Mud** slurries are instantly degraded upon contact with concrete creating a direct bond between existing soil and concrete providing greater friction bearing capacity.



Super Mud binds the soil together making excavating easy.

TECHNICAL SERVICES

- On-Site Technical Assistance
- Free Slurry Cost Estimation
- Slurry Training Seminars
- Free Site Specific Slurry System Programs



Slurry technicians are available for on-site technical support and training.

WATER TREATMENT

Most slurries are sensitive to various water characteristics that should be treated prior to initial mixing and controlled during excavating for best slurry performance. Water conditions such as water hardness, acidity, and alkalinity occur in city water, ground water, or can be caused by contamination from soil or cement.

The remedy is **Water Treat™**, a pH conditioner from PDSCo. See page 10 of this brochure for additional information regarding the usage of **Water Treat**. **Water Treat** or soda ash is recommended for pH buffering and softening of makeup water and preventing contamination from calcium and magnesium ions.

A good estimate for correction of **Super Mud** slurry is 1lb **Water Treat** to 200 gallons freshwater (1 kg : 1.6 m³) or 1lb **Water Treat** to 100 gallons (1 kg : 0.8 m³) of salt or brackish water. In cases of extreme acidic soil conditions, the use of sodium or potassium hydroxide as a water conditioner may be necessary. However, extra precautions should be taken if these materials are used.

MIXING



Mixing in Surface Tanks

Simply pour **Super Mud** through a venturi type mixer or pour slowly directly into a rapid, turbulent moving stream of water filling the tank.

For mixing **Super Mud Dry**, slowly sift the granular directly into a stream of running water.

Surface tank mixing is recommended, especially on large scale projects, because properties of the slurry are more easily controlled.

Avoid the use of shear mixers or centrifugal pumps if at all possible as over shearing will reduce viscosity.



Mixing Directly into the Excavation

Pour **Super Mud** slowly and directly into the stream of water allowing the stream of **Super Mud** to enter the water at the most turbulent point.

If **Super Mud Dry** is used, add slowly to avoid lumping and wastage.

The drilling tool should then be slowly raised and lowered into the slurry column to distribute and homogenize the slurry with slow rotation.

USAGE TABLES

Super Mud™					
Formation Type	Super Mud Dosage or Concentration				Marsh Funnel Viscosity
	vol/vol ratio	lbs/cu yd	gal/1000 gal or liter/m ³	kg/m ³	
Clay & Shale	1/800	2.19	1.25	1.30	35-45
Silt & Fine to Medium Sand	1/600	3.3	1.87	1.87	45-60
Coarse Sand to Pea Gravel	1/400	4.4	2.5	2.6	60+

Super Mud Dry™				
Formation Type	Super Mud Dosage or Concentration			Marsh Funnel Viscosity sec/quart
	lbs/cu yd	lbs/1000 gal	kg/m ³	
Clay & Shale	0.3 – 0.8	1.5 - 4.2	0.2 – 0.5	40 -50
Silt & Fine to Medium Sand	0.8 – 1.7	4.2 – 8.3	0.5 – 1.0	50 – 60
Coarse Sand to Pea Gravel	1.7 - 2.5	8.3 – 12.5	1.0 – 1.5	60 -80
Gravel to Cobbles	2.5 – 3.4	12.5 -16.7	1.5 - 2.0	80+

These values are not specifications. They should be used as guidelines in matching slurry to soil. In applications where brackish, salt, or seawater contaminates slurry or is used in slurry makeup, dosage should be near top of given ranges, and developed viscosities may be lower. Treatment of makeup water and /or slurry with pH conditioners such as **Water Treat** or soda ash may be required.

Volume of Water in Drilled Shaft/ Bored Pile		
Diameter Feet	Diameter Inches	Gallons per Foot of Depth
	3	0.37
	6	1.50
	9	3.37
1	0	5.91
	3	9.35
	6	13.24
	9	18.18
2	0	23.49
	3	29.99
	6	36.73
	9	44.73
3	0	52.88
	3	62.38
	6	71.96
	9	83.03
4	0	93.95
	3	106.59
	6	118.93
	9	133.07
5	0	146.83
	3	162.47
	6	177.65
	9	194.78
6	0	211.38
	3	230.08
	6	248.11
	9	268.31
7	0	287.76
	3	309.52
	6	330.32
	9	353.58
8	0	375.80
	3	400.63
	6	424.27
	9	450.60
9	0	475.65
	3	503.48
	6	529.96
	9	559.35
10	0	587.18
	3	618.15
	6	647.39
	9	679.86

The volume can be calculated with a simple formula:

$$\text{Radius}^2 \times \text{Depth} \times \pi$$

$$\text{Radius} = \frac{1}{2} \text{Diameter}$$

$$\pi = 3.14$$

MAINTENANCE

FLUID LOSS – High rates of fluid loss can be detrimental to the excavation stability because migration of fluid through the side walls of the excavation can reduce cohesion of the surrounding soil, equalize pressure between the hole and the soil, increase potential for hydration of swellable clays and shales, and cause sloughing or collapse of the hole.

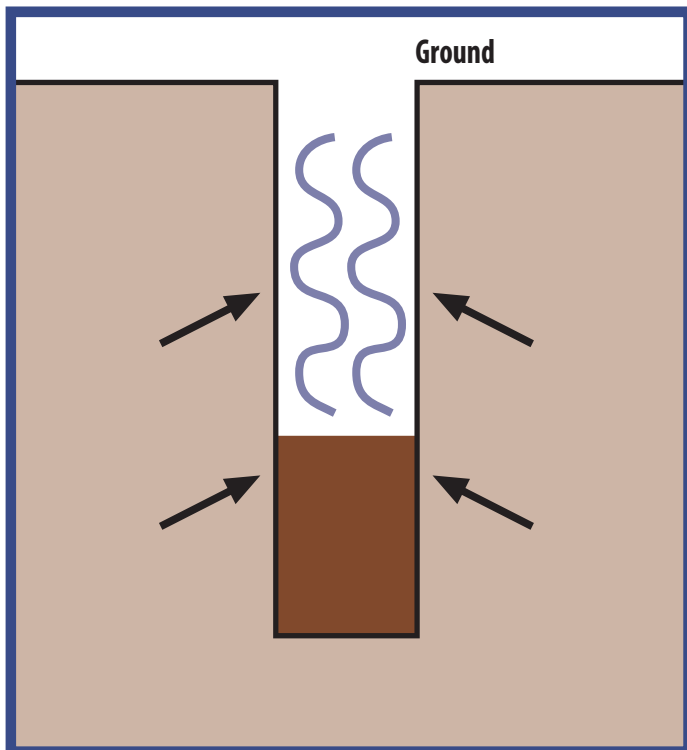

OPTIONS

- Increase the polymer dosage and viscosity of the slurry by adding **Super Mud** or **Super Mud Dry** directly into the hole with water.
- Transfer premixed high viscosity polymer slurry to the hole from storage tank.
- Fluid loss control agents such as **Aquasorb** or **Granular Bentonite** may be added to the existing slurry. (Use only additives developed for compatibility with the fluid in use). See page 9 for additional information on fluid loss control additives.
- Natural silts that have already been removed from the excavation can be added directly into the top of the excavation or can be applied directly to the fluid loss zone by placing the natural silt on the auger. The auger should be rotated so as to spin the material off against the sidewalls of the excavation just above the loss zone.

WATER TABLE – The slurry level should be maintained at least 6 feet (2 m) above the water table to balance hydrostatic pressure and to prevent collapse of unstable formations. If the slurry drops below this level, the operation should be paused and the proper slurry level reestablished by adding fresh water and polymer directly to the hole or by transferring premixed slurry from a holding tank to the hole. Surface casing use is always recommended.

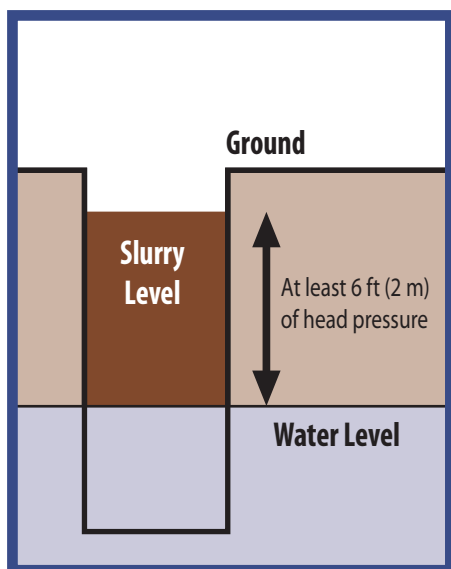

A head pressure must be maintained at a level of 6 feet (2 m) above the static water level at all times.

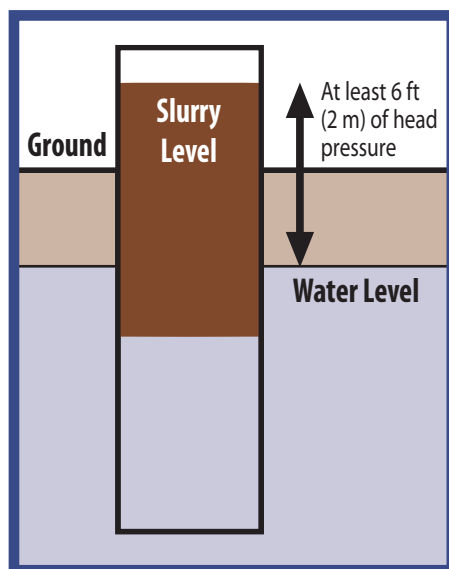

If water table is at grade, extend surface casing above grade to allow sufficient head pressure.

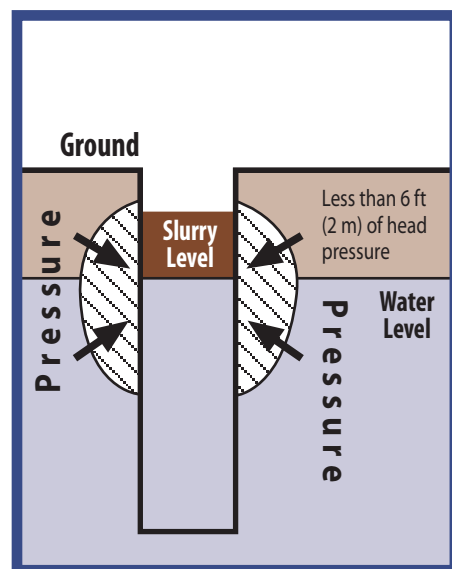

Failing to do so will result in the collapse of the wall from near the water level.

PREPARING FOR CONCRETE PLACEMENT

TYPICAL CLEANUP – When design depth is reached, the hole bottom should be cleaned with a cleanout bucket, submersible pump or an airlift system.

If required, slurry samples should subsequently be taken from within 2 feet or ½ meter from the bottom of the hole to determine viscosity, sand content, pH and density. After the bottom of the hole is cleaned, placement of the rebar and concrete may proceed.



RECYCLING

Care should be taken not to pump any slurry back to the holding tanks that have become contaminated from contact with the concrete. Contamination can be very visible as it looks very much like clabbered milk or oatmeal.

The last 3 feet (1 m) of slurry above the concrete interface shall be diverted to a waste tank or pit.

The slurry collected in a holding tank should be tested for pH and viscosity, and adjusted by the addition of **Water Treat** or **Super Mud** for reuse in the next excavation.

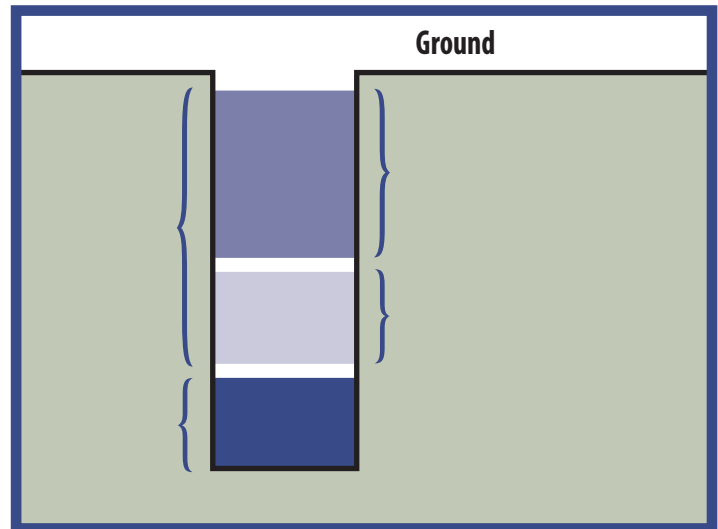

BREAKDOWN OF SUPER MUD SLURRY FOR DISPOSAL

Upon completion of a job, any remaining **Super Mud** slurries can be broken down with a chemical oxidizer. The most common oxidizer for this purpose is 5% Sodium Hypochlorite solution (household bleach); 3% Hydrogen Peroxide (household use concentration) can also be used.

The Hypochlorite solution should be added to the **Super Mud** slurry at a rate of 1 gallon to 800 gallons of slurry to be treated. After the breaker is added, the entire system should be circulated to insure complete oxidation of all polymer molecules.

When breakdown is complete, all that remains is acrylate molecules and water. This is often safely discharged into sewer systems, percolated into the ground, or simply left to evaporate. Always check local regulations before disposal.

SLURRY ADDITIVES



QUIK FLOC™ (Flocculent/Settling Agent) – A selective mud flocculent in liquid form that aids in the settlement of solids. **Quik Flocc** reduces the time required for settlement by rapidly agglomerating silt and other micron size particles that are suspended within the slurry and settles them to the bottom of the excavation allowing for easy removal by cleanout bucket or airlift system. Flocculation time will vary depending upon concentration of suspended fines.

- Can be premixed with **Super Mud** slurries or can be mixed directly in the excavation prior to cleanout.
- **Quik Flocc** is salt tolerant and meets the same rigorous environmental standards as **Super Mud**.
- 1 to 2 quarts **Quik Flocc** : 4000 gallons of slurry to be cleaned (1 to 2 liters : 15 m³).
- **Quik Flocc** can also be used in flocculating water, without the presence of polymer or bentonite slurry.



WATER TREAT™ (pH Conditioner) – A pH conditioning and water-hardness reducing additive that is designed to enhance the performance of the slurry. **Water Treat** is especially useful and necessary when acidic water is used, acidic soil or groundwater is encountered, or when brackish or saltwater conditions exist.

For use with **Super Mud** and **Super Mud Dry**, we recommend maintaining the pH level between 8 and 10 in fresh water and a pH of at least 10 in saltwater. **Water Treat** should be added to the makeup water prior to mixing of the other slurry materials.

To mix, slowly sift into the

makeup water or slurry. pH of the slurry should be monitored through-

out the drilling operation and **Water Treat** should be added as necessary to maintain proper pH level and buffer against contaminants. **Water Treat** can be added directly to the hole, in the slurry tank, or mud pit.

Recommended Usage		
Fresh Water	1 lb : 200 gallons of water	1 kg : 1.6 m ³
Brackish/Saltwater	1 lb : 100 gallons of water	1 kg : 0.8 m ³

AQUASORB™ (Fluid Loss Control Additive) – A water absorbent polymer, is a crosslinked, modified polyacrylamide which absorbs many hundreds of times its own weight in water and swells to form a durable crystalline gel. These gel particles do not dissolve, but continue to swell with time, making a seal in the pore spaces of the formation; thus, eliminating fluid loss.

For maximum results, every pound (0.45 kg) of **Aquasorb** should be prehydrated with three gallons (11.36 liters) of water for about 10-15 minutes before introducing to the excavation. Upon hydration, pour into the excavation allowing hydrated polymer to migrate into the loss zone. Repeat as necessary. Generally, one pound (0.45 kg) of **Aquasorb** per foot (0.30 meter) of diameter of hole will control moderate losses. For severe losses, this amount will require doubling to achieve complete seal.

GRANULAR SEAL™ (Mineral Fluid Loss Control Additive) – A dry, granular fluid loss control additive for use with **Super Mud** polymer slurries. **Granular Seal** helps to control fluid loss in porous soil conditions.

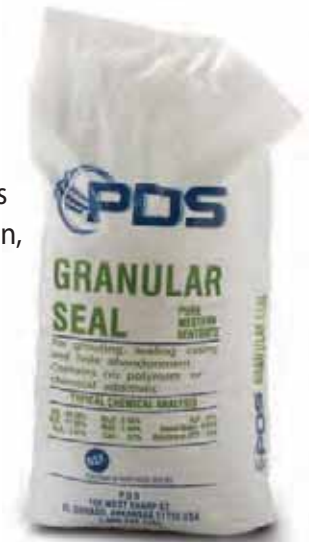

SLURRY TESTING EQUIPMENT

TESTING SLURRY PROPERTIES – There are four main properties that require testing during use:

pH – This test is performed by dipping a piece of litmus paper (pH paper) into the slurry and comparing the color change to a chart. The result is reported in a number from 1 to 14, 1 to 6 acidic, 7 is neutral, and 8 to 14 is alkaline; 1 is the most acidic, 14 the most alkaline.

Optimum Zone (pH 8 – 10) / Problematic Acidic Conditions (pH below 7)

At this level, polymer molecules can fully hydrate and extend, creating more viscosity. The carbonate ion present in alkaline solutions also buffers the slurry against calcium and magnesium contamination. Acidic soil and groundwater can be extremely detrimental to a slurry and should be corrected by additions of a safe pH conditioner such as **Water Treat** or soda ash (Na_2CO_3). In extreme cases potassium or sodium hydroxide may be used, however extreme caution should be taken; for further details contact PDS.

pH Scale							Optimum Zone						
1	2	3	4	5	6	7	8	9	10	11	12	13	14
Acidic							Neutral		Alkaline				

MARSH FUNNEL VISCOSITY – Viscosity is the measure of slurry thickness, polymer concentration and the slurry’s ability to stabilize surrounding soils. This test should be performed both initially and at frequent intervals during use of the slurry. The time in seconds for one quart of slurry to pass through the funnel is reported as viscosity in seconds per



volume. At standard mixing rates, **Super Mud** slurries will yield a viscosity of 40+ seconds per quart (0.95 liter).

Procedure – The test requires a Marsh Funnel and Viscosity Cup.

While holding a finger over the tip of the Marsh Funnel, fill the funnel by pouring the slurry sample through the screen located in the top of the funnel. The screen will filter out any particles that may clog the tip of the funnel. The funnel should be filled to the bottom of the screen.

Place the Viscosity Cup on a level surface and while holding the funnel over the cup, remove your finger allowing the fluid to flow into the cup. Using a stop watch or wrist watch, time the number of seconds it takes to fill the cup to the top line marked 32 oz. (1 quart). MFV is reported in seconds per quart.

DENSITY TEST – This test determines the weight of the slurry and is performed with a standard mud balance, also known as a mud scale or density scale. **Super Mud** slurries, regardless of viscosity, have the same density as water, specific gravity of one (8.3 lbs/gal).



Procedure – Fill the reservoir of the mud balance with the slurry sample and replace the lid. Wipe off any excess mud from the reservoir and place the balance on the fulcrum or knife edge. Slide the weight along the balance arm while using the level located on the arm just behind the reservoir to determine when the balance is level. Once the balance is leveled, the result can be read and reported in specific gravity, pounds per gallon, pounds per cubic foot, or pounds per square inch.

SLURRY TESTING EQUIPMENT

SAND CONTENT – This test measures the amount of sand suspended within the slurry and is performed with a standard sand content kit. The results are reported as percent sand. Testing is normally performed at the completion of excavation and just prior to placing concrete. When using **Super Mud** slurries, the sand content will rarely test over 1.0% sand. Due to **Super Mud's** flocculation ability, it drops sand very quickly; therefore, the slurry remains nearly sand free.



Procedure – This test requires the glass and content tube, the 200 mesh sieve with funnel, and the wash bottle. Due to the binding effect the polymer has on the mesh sieve, the wash bottle should be filled with water containing 10% regular household bleach.

Fill the glass and content tube with the slurry sample to the point marked MUD TO HERE. Then fill tube with clean water to the point marked WATER TO HERE. While holding your finger over the tip of the tube, shake the tube for several seconds, mixing the water and slurry sample.

Pour the diluted slurry sample on top of the sieve, invert the sieve and with the wash bottle (containing clean water) wash the sand particles that were trapped in the screen back into the glass sand content tube. When all the sand particles have dropped to the bottom of the tube, the result can be read and reported in percent sand.

FLUID SAMPLER – The Fluid Sampler permits its user to sample at any depth of the excavation for accurate analysis.



The Fluid Sampler is 3.5 inches in diameter and it is constructed of schedule 40 PVC. It is equipped with a double ball check valve allowing for fluid extraction from desired depths and also features a threaded midsection for easy cleaning and storage.

PDS TESTING EQUIPMENT KIT

- Marsh Funnel & Viscosity Cup
- Mud Balance
- pH Test Paper
- Sand Content Kit
- Fluid Sampler
- Stop Watch
- Durable Carrying Case





870-863-5707

800-243-7455

Fax 870-863-0603

sales@pdscoinc.com

www.pdscoinc.com

The information contained herein is believed to be accurate and reliable. PDS Co, Inc. makes no warranty of any kind and accepts no responsibility for the results obtained through application of this information.

© 2010 PDS Co, Inc.

SUPER MUD

POLYMER SLURRY

DESCRIPTION

Super Mud is a liquid polymer slurry which is primarily used as a viscosifying agent and as a soil stabilizer to prevent sloughing and/or collapse of a borehole. **Super Mud** is far easier to use than any bentonite.

5 Gallons of Super Mud is Equivalent to 1 Ton of Conventional Bentonite

ADVANTAGES

1. Mixes easily in both fresh and saltwater.
2. Allows for faster drilling.
3. Non-fermenting and nontoxic.
4. Reduces wear on pump and bits; unlike bentonite, **Super Mud** slurry will always weigh approximately the same as water, therefore, requiring lower pump rate.
5. Eliminating swelling in most clays and shales.
6. Rapidly settles cuttings in bottom of pit.
7. Reduces fluid loss.
8. Can be readily broken down for easy disposal.

MIXING PROCEDURE

1. Pretreat makeup water with *Water Treat*, a pH conditioner, to pH of 8-10. Normally, 1 lb to 200 gallons of makeup water is sufficient for freshwater. For brackish makeup water, the ratio is 1 lb to 100 gallons.
2. Mixing Ratio **800 (Fresh water) : 1 (Super Mud)** These ratios yields Marsh Funnel Viscosity of 40 plus.
600 (Brackish water) : 1 (Super Mud)
This mixing ratio is sufficient for most drilling situations. Clay or rock formations require a lower mixing ratio.
3. Monitor the pH of the slurry, as it will change with the chemical structure of the formation. Add a cup or two of *Water Treat* into the flowing ditch to revitalize the slurry when pH drops or if salt or brackish water is encountered.
4. **Super Mud** slurry can be pumped into a storage tank for reuse or for breaking down with household bleach (5% Sodium Hypochlorite solution) or 3% Hydrogen Peroxide. The breaker should be added to the **Super Mud** slurry at a rate of 1 part to 800 parts of slurry. After the breaker is added, the entire system should be circulated to insure complete oxidation of all polymer molecules.

PACKAGING

Available in 5 gallon (19 liter) pails and ½ gallon (2 liter) jugs of six to a case.



HIGH YIELD

BENTONITE GEL

DESCRIPTION

High Yield is a Polymer Extended Sodium Bentonite that yields a minimum 200 barrel of API fluid per ton of material. It mixes rapidly for quick hydration and carries cuttings in mud with lower soil content. **High Yield** diminishes fluid loss conditions, reduces seeping into permeable formations, and helps eliminate loss circulations.

APPLICATION

High Yield is ideal for use in water well, monitoring well, mineral exploration, seismic operations, and directional drilling applications.

RECOMMENDED USAGE

Pre-treat makeup water with *Water Treat*, a pH conditioner, to pH of 8-10.

Normal Formation : Mix 15-20 lbs (6.8-9.1 kg) of **High Yield** per 100 gallons (379 liters) of makeup water.
 Unstable Formation : Increase to 25-40 lbs (11.3-18.1 kg) per 100 gallons (379 liters) of makeup water.

PACKAGING

Packaged in 50 lb (22.7 kg) multi-walled paper bags.

SPECIFICATIONS

Fann @ 600 RPM : 30.0
 Filtrate : 16.20 ml
 Moisture : 10.0 Maximum
 Dry Sieve Analysis : 75.80% (200 mesh)
 Wet Sieve Analysis : 2.3%-3.5% (200 mesh)
 pH : 7.9

TYPICAL CHEMICAL ANALYSIS

SiO ₂	61.3 %
Al ₂ O ₃	19.8 %
Fe ₂ O ₃	3.9 %
CaO	0.6 %
MgO	1.3 %
Na ₂ O	2.2 %
K ₂ O	0.4 %
Trace Elements	3.2 %
H ₂ O (crystal)	7.2 %

X-RAY ANALYSIS

85 %	Montmorillonite
5%	Quartz
5%	Feldspars
2%	Cristobalite
2%	Illite
1%	Calcite and Gypsum

Yield : >220bbl/ton



Appendix E

Water Uses

This page intentionally left blank.

Water Uses

Construction of the Project transmission lines, access roads, converter station and supporting facilities will require water. Major water uses are for transmission line structure and converter station and fiber optic regeneration station foundations, access road construction, dust control during right-of-way (ROW) and converter station grading and site work, and re-seeding restoration work upon project completion. A minor amount of water will be used to establish converter station landscaping where required during construction. Drilling and fire prevention also may require minor amounts of water. Each converter station would include drinking water and sewer/septic service to support less than 15 permanent full-time employees. In addition, each converter station would include a fire suppression system. Water requirements for these activities would be relatively low. Clean Line would not drill wells and would, instead, obtain water from municipal water agencies. Although these agencies may or may not withdraw from the local groundwater aquifers, it is assumed that they would already hold any necessary permits or registrations for water withdrawal.

In the construction of foundations, water is used to mix wet concrete produced in commercial ready-mix batch plants, the wet concrete (ready-mix) is transported to the structure sites in concrete trucks for use in foundation installations.

Other water uses during foundation construction include water to prepare drilling slurry required to maintain excavations for drilled shaft foundation construction, if required due to soil conditions, and water used by concrete trucks to wash chutes and drums after delivering concrete.

Water usage for access road construction is primarily for moisture conditioning of new bladed roads necessary to achieve adequate compaction to support heavy equipment travel.

Construction of the transmission lines and related facilities will generate a temporary increase in fugitive dust. Water will be applied to disturbed areas and unpaved roadways using water trucks as needed to minimize dust.

Water usage for restoration will include the water needed to prepare and apply hydra-mulch to help stabilize disturbed slopes and reseeded of disturbed work areas after construction activities are complete.

Water usage for converter station construction is primarily for dust control and moisture conditioning to aid soil compaction during site preparation work. During this period, construction equipment will be cutting, moving, and compacting soil to prepare the subgrade surface. As a result, water trucks will make as many as one pass per hour over pad sites. Once site preparation work is complete, concrete for the placement of foundations becomes the largest user of water, and dust control becomes minimal.

If converter station landscaping is required as part of Project permitting, drought-tolerant plant materials will be used to minimize watering requirements after plant establishment.

Normal operations and maintenance of the transmission line and converter station will not require any water use.

Water Sources and Estimated Amounts

The Project will contract with municipal water providers along the transmission-line route to obtain water for the project construction.

Letters will be sent to each water provider requesting documentation that they are willing and able to provide water, and confirming that doing so would not adversely impact their ability to provide water for other uses or restrict future growth.

During construction, water obtained from contracted sources will be pumped into tanker trucks at locations indicated by municipal providers and transported to Project staging areas.

Approximately 110 million gallons will be needed during the approximately 36-month construction period.

The amount of water required for the Project is equivalent to approximately 339 acre-feet, or the amount of water that 252 typical families use over the same time period (based on the Environmental Protection Agency [2011] estimate of 400 gallons per day per family, applied over the 3-year construction schedule).

The amount of water required for dust control will depend on precipitation, temperature, soil conditions, and frequency of use. Dust control water application may also include eco-safe, biodegradable, liquid copolymers to stabilize unpaved road surfaces and manage fugitive dust where extended use is anticipated. Average water use for dust control along the transmission line and related facilities was estimated assuming that two 3,000-gallon water truck will operate in each segment, emptying its tank up to four times per day. However, we anticipate the use of water will be more heavily concentrated over the earlier portions of the schedule during access roadway and foundation construction.

Pad preparation activities are included in water use estimates for the converter stations proposed at the terminus of the 600 kV HVDC transmission line. Water used for construction of the Texas County, OK Converter Station pad was estimated based on the preliminary grading plan assuming 2% moisture conditioning of structural fills. It is anticipated the preparation of the Tennessee converter station pad will involve only minimal grading and will therefore require less than 500,000 gallons.

As the Project will contract with municipal water providers along the transmission-line route to obtain water for the project construction, impacts to above-ground (surface water) or below-ground (groundwater) water supplies are not anticipated as a result of Project construction or operation.

Water Losses and Disposal of Liquids

Water used for moisture conditioning and dust control (approximately 17 million gallons annual average, 25.4 million gallons annual average under worst-case conditions assuming a 50 percent increase in water use for all Project dust control throughout construction) will infiltrate into the ground or evaporate into the atmosphere. Similarly water used for hydra-mulch will infiltrate into the ground, evaporate into the atmosphere or be absorbed by new ground cover. The amount of water used for dust control will be sufficiently small that runoff will not occur. Water used for foundations (approximately 7.4 million gallons) will remain in the concrete mix.

Concrete washout water produced during construction of tower and converter station foundations will also be required. Designated aboveground washouts will be used to contain residual concrete, concrete associated liquids, and the wash water from cleaning trucks, hoppers, and chutes. Washout containment best management practices (BMPs) will be earthen

berm or straw bale enclosures lined with plastic, a storage tank, or other structure approved by the engineer or inspector. These washouts will be located within each structure work area at least 50 feet away from storm drains, ditches, streams, or other water bodies in accordance with the Erosion and Sediment Control Plan (ESCP). Washouts will be monitored like other BMPs to ensure there are no leaks and that they are operating effectively. They will be cleaned out when they reach 75 percent of their design capacity. Care will be taken to ensure these structures do not overflow during storm events. The locations of concrete washouts will be provided in the ESCP as a part of the 1200-C stormwater permit.

After a concrete washout is no longer needed, the contractor will ensure proper disposal of washout materials. Washout liquids are generally allowed to evaporate. Washout liquids will not be discharged into storm drains, ditches, streams or other water bodies. Dried concrete will be broken up and used as clean fill on the Project, recycled, or properly disposed of by other means. Hardened concrete that is not recycled may be buried in embankments on-site in accordance with applicable permit requirements.

Some foundations may require slurry to stabilize foundation shafts during drilling. Slurry fluids will be recycled to the extent practicable. Excess and degraded slurry fluids will be disposed of at off-site location(s). Cement may be added to residual slurry to convert it to a solid concrete material for disposal at public landfills. The disposal will be in strict accordance with local, state, and federal environmental, and pollution laws and ordinances.

Washing of large construction equipment to prevent the spread of weeds will also generate a minimal amount of wastewater. Construction contractor vehicles will be cleaned using high-pressure equipment (compressed air or water) when moving from weed-contaminated areas to other areas along the Project. The cleaning activities will focus on tracks, feet, or tires, and vehicle undercarriages including axles, frame, motor mounts, running boards, and front bumper/brush guards. All washing of vehicles will be performed in designated, approved wash stations. The washing of the construction vehicles will generate a minimal amount of wastewater. Wash station locations will be monitored to ensure that weedy vegetation does not germinate at the wash stations.

This page intentionally left blank

APPENDIX G

DRAFT EIS ROUTE DEVELOPMENT PROCESS



This page intentionally left blank.

Route Development Process

The complete Alternatives Development Report, which was completed by the U.S. Department of Energy (DOE) in 2013, is provided in full on the Reference CD accompanying the Draft Plains & Eastern Environmental Impact Statement (EIS).

Clean Line employed a multi-stage approach to develop guidelines and criteria to identify corridors and refine them. At each stage, Clean Line incorporated public stakeholder input on the development of criteria and the identification of corridors and routes. The Clean Line Routing Team considered and utilized guidelines and criteria consistent with transmission line siting principles used by federal entities such as the Rural Utilities Service, Western, and Bonneville Power Administration.

Appendices to the Alternatives Development Report, which are included in their entirety in the complete version of the report on the Reference CD, include the following:

- A. Preliminary Draft Project Description (July 2013)¹
- B. Project Siting Narrative (May 2013)
- C. DOE Comments and Clean Line Responses on Project Siting Narrative (May 2013)
- D. Notice of Intent
- E. Display Board and One Map Showing the Network of Potential Routes
- F. Comments and Responses on DOE EIS Scoping Comments Pertaining to Routing
- G. Draft Tier IV Criteria with Responses to the DOE Team Comments
- H. Tier IV Routing Study (November 2013)

Two excerpts from the DOE Alternatives Development Report and Clean Line's Tier IV Routing Study (also completed in 2013) are provided herein to provide the reader a more detailed explanation of the route development process. Exhibit 1 is the main body of the Alternatives Development Report. This 20-page document addresses the process undertaken for development of the alternatives, including converter station siting and transmission line route alternatives. Exhibit 2 is the main body and Appendix A of the Tier IV Routing Study. This excerpt includes a description of the process used to develop the Applicant Proposed Route and DOE HVDC alternative routes for the Project. It includes specific information related to each region and the criteria used to develop and distinguish between route alternatives. The complete Tier IV Routing Study, provided in entirety on the Reference CD, includes the following appendices:

- A. Tier IV Siting Criteria
- B. Example Paired-Node Analysis
- C. Aerial Reconnaissance Summary Report
- D. Figures

It should be noted that some inconsistencies in language and nomenclature between these excerpts and the Plains & Eastern EIS may have occurred during the development of the Draft EIS. Additionally, several route variations to the Applicant Proposed Route in Regions 2–7 were developed in response to public comments on the Draft EIS and are described in Appendix M of the EIS. This appendix includes details about the route variations that have been adopted

¹ It should be noted that Appendix F of the Plains & Eastern EIS presents an updated (July 2015) Project Description.

for consideration in the Final EIS. Table M.2-1 provides a list of the route variations analyzed in the Final EIS (and any required route adjustments), the affected counties where those route variations are located, and whether the route variation replaces the corresponding segment of the Applicant Proposed Route or if the variation is carried forward in the Final EIS analysis in addition to the Applicant Proposed Route.

Exhibit 1: DOE Alternatives Development Report

1. Purpose of the DOE Alternatives Development Report

The purpose of this report is to describe the process used by the U.S. Department of Energy (DOE), Southwestern Power Administration (Southwestern), and the third party contractor (Tetra Tech) (collectively the “DOE Team”) to develop the alternatives (including converter station locations and the HVDC transmission line routes) to be analyzed in the EIS. Based on this process, the DOE Team reached the recommendations set forth in this Report.

2. Background

Section 1222(b) of the Energy Policy Act of 2005 (EPAct) authorizes the Secretary of Energy, acting through and in consultation with the Administrator of the Southwestern (provided the Secretary determines that certain conditions have been met), to participate with other entities in designing, developing, constructing, operating, maintaining, or owning new electric power transmission facilities and related facilities located within any state in which Southwestern operates. Southwestern is one of four Power Marketing Administrations that operates within the U.S. Department of Energy. Southwestern is chartered to market and deliver power in the southwestern United States, including Arkansas and Oklahoma, to rural electric cooperatives and municipal utilities.

On June 10, 2010, the DOE issued a Request for Proposals (RFP) for new or upgraded transmission projects pursuant to Section 1222(b) (75 FR 32940). Clean Line Energy Partners LLC of Houston, Texas, the parent company of Plains and Eastern Clean Line LLC and Plains and Eastern Clean Line Oklahoma LLC (collectively referred to as Clean Line), responded to the RFP on July 6, 2010, providing a description of the proposed Project and supporting information. Clean Line’s original proposal included two high voltage direct current (HVDC) lines, each rated at 3,500 megawatts (MW), together with the capacity to deliver 7,000MW. Subsequently, Clean Line modified its Section 1222(b) proposal to a single HVDC line with the capacity to deliver 3,500MW.¹ DOE concluded that Clean Line’s modified proposal (Proposed Project) complied with and was responsive to the RFP.²

Prior to making a determination whether to participate in the proposed Project, DOE had to fully evaluate the proposed Project, in consultation with Southwestern, including reviewing the potential environmental impacts and the requirements of Section 1222(b), and must consider the criteria listed in the RFP. DOE is preparing the Plains & Eastern Environmental Impact Statement (EIS) pursuant to NEPA, the Council on Environmental Quality NEPA regulations (40 CFR Parts 1500 through 1508), and the DOE NEPA implementing regulations (10 CFR Part 1021).

¹ <http://energy.gov/oe/downloads/plains-eastern-clean-line-project-proposal-new-or-upgraded-transmission-line-projects>

² <http://energy.gov/oe/downloads/letter-deputy-secretary-poneman-clean-line-energy-regarding-plains-eastern-clean-line>

2.1 Clean Line Proposed Project Description

The proposed Project would include an overhead \pm 600 kilovolt (kV) HVDC electric transmission system and associated facilities with the capacity to deliver approximately 3,500MW primarily from renewable energy generation facilities from the Oklahoma Panhandle region to load-serving entities in the Mid-South and Southeast. The proposed Project would traverse Oklahoma, Arkansas, and Tennessee, a distance of approximately 700 miles between interconnection facilities in Texas County, Oklahoma, and Shelby County or Tipton County, Tennessee. The western portion of the proposed Project would interconnect to the transmission system operated by the Southwest Power Pool in Texas County, Oklahoma. The eastern portion of the proposed Project would interconnect to the transmission system operated by Tennessee Valley Authority (TVA) in Shelby County, Tennessee. TVA would make the necessary upgrades to its transmission system, which could include construction and operation of new transmission lines and substations and upgrades to existing transmission lines and substations.

As proposed, the Project would include the following major facilities and improvements:

- Converter Stations. A new alternating current (AC)/direct current (DC) converter station would be built at each end of the transmission line. Each converter station would require the use of approximately 30 to 50 acres and would be located on private land. The converter stations are proposed to be located in Texas County, Oklahoma, and either Shelby County or Tipton County, Tennessee.
- HVDC Transmission Facilities. A \pm 600kV HVDC overhead electric transmission line with the capacity to deliver approximately 3,500MW. Components of the HVDC transmission facilities include:
 - Tubular and lattice steel structures used to support the transmission line.
 - Communications/control and protection facilities (optical ground wire [OPGW] and fiber optic regeneration sites).
 - Right-of-way (ROW) easements for the transmission line, with a typical width of approximately 150 to 200 feet.
 - Temporary construction areas such as multi-use construction yards, fly yards, tensioning and pulling sites, and wire-splicing sites.
- High voltage alternating current (AC) Transmission Facilities. High voltage alternating current facilities would be required at the western and eastern termini of the HVDC transmission line. To facilitate efficient interconnection of wind generation, four to six high voltage alternating current transmission lines of up to 345kV from the Texas County converter station to undetermined points in the Oklahoma Panhandle region would be required. In addition, AC transmission lines would be required to connect each converter station to the existing grid. One double circuit 345kV AC transmission line would be required to connect the proposed Texas County converter station to the future Xcel Energy/Southwestern Public Service Company Hitchland #2 substation. Two 500kV high voltage alternating current transmission lines would be required to connect the Shelby County or Tipton County converter station to the Shelby Substation. Components of these facilities include:
 - Tubular or lattice steel structures used to support the transmission line.
 - Communications facilities.
 - ROW easements for the transmission line, with a typical width of approximately 150 to 200 feet or less.

- Temporary construction areas such as multi-use construction yards, fly yards, tensioning and pulling sites, and wire-splicing sites.
- Access roads. Access roads to the proposed Project facilities and work areas during the construction and operation phases would consist of:
 - Existing roads with no improvements;
 - Existing roads that may need repairs;
 - Existing roads that need improvements;
 - New overland travel roads (no improvements needed);
 - New overland travel roads with clearing; and
 - New bladed roads.

Clean Line developed a Preliminary Draft Project Description in July 2013 (Appendix A). The DOE Team sent comments on the Preliminary Draft Project Description to Clean Line in August 2013. Clean Line is currently revising and updating this project description to respond to comments.

3. Summary of Proponent Routing/Siting Approach

Clean Line developed the proposed locations for the converter stations and HVDC transmission line for the Project using an iterative process. They began with a broad study area, which was evaluated with progressively more detailed and restrictive siting criteria, resulting in identification of proposed converter station siting areas and a proposed Network of Potential Routes for the HVDC transmission line. Clean Line considered and utilized guidelines and criteria consistent with transmission line siting principles used by federal entities such as the Rural Utilities Service, Western Area Power Administration, and Bonneville Power Administration. These principles include identifying opportunity areas (e.g., paralleling existing infrastructure) and sensitive resources that limit or conflict with transmission line development (e.g., U.S. Fish and Wildlife Service designated critical habitat). This section describes Clean Line's preliminary steps of the transmission line routing process and converter station siting.

Clean Line employed a multi-disciplinary team of professionals, (Clean Line Routing Team), to undertake the route identification process. The Clean Line Routing Team included Clean Line employees and representatives from Clean Line's technical team, including members from Ecology and Environment, Inc. (general Environmental Consultant), SWCA Environmental Consultants (cultural and historical resources consultant), and Pike Energy Solutions (engineering construction consultant).

The Clean Line Routing Team applied General and Technical guidelines intended to avoid conflicts with existing resources, developed areas, and existing incompatible infrastructure; to maximize opportunities for paralleling existing compatible infrastructure; and to take into consideration land use and other factors. The technical guidelines included considerations related to design and engineering of the transmission line. A glossary of siting and routing terms is included in section 9.0 of this report.

3.1 Converter Station Siting

The proposed Project includes converter stations at each end point of the HVDC transmission line, one in Texas County, Oklahoma, and one in Shelby or Tipton County, Tennessee. The process that Clean Line used to select the converter station siting areas is discussed below. Detailed information about the converter station siting is included in the Project Siting Narrative, included as Appendix B.

3.1.1 Oklahoma Converter Station

Clean Line began the site selection process for the western converter station by studying a broad region of northwestern Oklahoma. Clean Line narrowed the Study Area by considering criteria such as wind resources, AC transmission interconnection, regional land use compatibility, and environmental sensitivities. Clean Line selected the proposed western converter station siting area based on three primary factors: (1) proximity to a large area of concentrated high capacity factor wind resources; (2) proximity to a point on the existing or planned AC transmission system that would support the interconnection; and (3) proximity to large areas of land uses compatible with wind farm development and which are known to be relatively low in environmental sensitivities.

3.1.2 Tennessee Converter Station

Clean Line began the site selection process for the eastern converter station by studying a broad geographic region from central Arkansas to western Tennessee. Clean Line selected the eastern converter station siting area based on four primary factors: (1) proximity to existing transmission facilities capable of reliable interconnection and delivery of up to 3,500MW of energy to points further in the Southeast and Mid-South; (2) the level of potential upgrades required to accommodate the Project; (3) historical congestion and market access; and (4) land use and environmental siting consideration.

3.2 Clean Line Routing Process—Tier I to Tier III

The Clean Line Routing Team used a three-tiered process to identify a Study Area and 5-mile-wide Candidate Corridors, refine the Candidate Corridors into a Study Corridor, and narrow and refine the identified Study Corridor to the Network of Potential Routes. The Study Area is shown on Figure 4-2 of Appendix B. General Corridor Pathways are shown on Figure 4-4 of Appendix B. Candidate Corridors are shown on Figure 4-5 of Appendix B. The Network of Potential Routes is included as Figure 4-13 in Appendix B.

At the end of the Tier III process, the Clean Line Routing Team recommended to DOE the Network of Potential Routes for use in the scoping process. Additional detail on the three-tiered process can be reviewed in the Project Siting Narrative developed by the Clean Line Routing Team included as Appendix B.

3.3 DOE Team Review of Routing Process—Tier I to Tier III

The DOE Team reviewed Clean Line's process and its Network of Potential Routes and determined they provided a sufficient initial basis for the EIS. The maps of the Network of Potential Routes were posted to the EIS website concurrent with publication of the NOI on December 21, 2012, and used for the DOE EIS scoping process.

In addition, the DOE Team reviewed the complete draft Project Siting Narrative and provided comments to Clean Line. Global comments consisted of clarifying routing terminology, identifying more specific criteria used for each Tier (Tier I–Tier III), and providing more extensive descriptions for areas with only one link. Specific comments and questions were also provided for sections of the report and associated maps and figures (Appendix C). Clean Line revised the draft Project Siting Narrative and provided a response to the DOE Team comments in a table format (Appendix C). Upon review the DOE Team was satisfied that the Project Siting Narrative adequately described the routing process (Tier I to Tier III) that lead to the Network of Potential Routes presented to and reviewed by the public and agencies during EIS scoping.

4. DOE EIS Scoping

The EIS scoping comment process began with the DOE publication of the Notice of Intent (NOI) (Appendix D) on December 21, 2012, and ended on March 21, 2013. Thirteen scoping meetings were held in January, February, and March 2013. The goal of scoping was for the DOE Team to request and receive comments on the scope of the EIS and alternatives from the public, agencies, tribes, and other interested parties. At the public and agency scoping meetings, the DOE Team presented large-scale maps (42 inches by 60 inches) to gather input on the Network of Potential Routes in addition to traditional comment forms. The display board and one map showing the Network of Potential Routes presented at the EIS scoping meetings are shown in Appendix E.

A summary of scoping comments can be viewed in the Scoping Summary Report published on the EIS website in June 2013, www.plainsandeasternEIS.com. The DOE Team reviewed all scoping comments and compiled and categorized the comments pertaining to transmission line routing or converter station siting by link number in a spreadsheet (Appendix F). These comments were provided to Clean Line for use in the development of draft Tier IV Siting Criteria. These comments were also used by the DOE Team as a basis for their review and approval of the Tier IV Siting Criteria and the application of the criteria in the routing process.

5. DOE Response to Scoping Comments

5.1 Tier IV Process

After the EIS scoping process was complete the DOE Team met with Clean Line in April 2013 to discuss the approach for the development of the next set of criteria (Tier IV) that would be used to refine the routes. In advance, and during this meeting, the DOE Team reviewed all EIS scoping comments and specifically those that were compiled in the spreadsheet pertaining to transmission line routing or converter station siting (Appendix F).

For the development of the draft Tier IV criteria, the Clean Line Routing Team reviewed the comments received during the EIS scoping process and verified location and subject-specific information from the

comments to the extent practicable. Review and verification methods included cross-referencing with applicable third-party data to confirm the physical location of features; validating other information provided (e.g., locations of newly built electric transmission lines or gas pipelines); and/or obtaining additional information pertaining to a specific comment. Using this input, the Clean Line Routing Team built on Tiers I–III criteria to develop Draft Tier IV Criteria.

The Draft Tier IV criteria were submitted to the DOE Team for review in May 2013. The DOE Team reviewed the draft criteria and provided comments. Comments included questions on specific data sources, recommendations for other data sources, recommendations for units of measurement, the classification of public lands, etc. Clean Line subsequently revised the Tier IV criteria and submitted the revised Draft Tier IV criteria along with responses to the DOE Team comments (Appendix G).

The DOE Team met with Clean Line in July 2013 to conduct a final review of the Tier IV criteria and discuss the next steps in the routing process. Following that meeting, the DOE Team indicated their concurrence with the Tier IV criteria and the Clean Line Routing Team began applying the Tier IV criteria, along with Geographic Information System Analysis (GIS) analysis and additional field reconnaissance (by aerial and ground surveys), to develop 1,000-foot wide Applicant Proposed Routes and Proposed Alternative Routes as well as 2,000-foot wide Applicant Preliminary Proposed Routes and Proposed Alternative Routes to be provided to Cooperating Agencies to solicit input. As part of the process of identifying and evaluating potential Alternative Routes, the Clean Line Routing Team compared pairs of links or series of links within a relatively small geographic area between two common endpoints (called the paired-node analysis) to determine the routes that contained the best application and balance of the Tier IV criteria. The Clean Line Routing Team then conducted field reconnaissance by aerial and ground surveys to confirm the presence or absence of opportunities and sensitivities.

In September 2013, the DOE Team reviewed the Applicant Preliminary Proposed Route and Proposed Alternative Routes compared to the Network of Potential Routes used during the EIS scoping process and provided comments and questions to the Clean Line Routing Team. This review included evaluating the placement of the Applicant Preliminary Proposed Route and Proposed Alternative Routes in relation to the Network of Potential Routes presented at EIS scoping, determining if scoping comments pertaining to routing had been addressed, and reviewing why some of the routes were outside the Network of Potential Routes used during the EIS scoping process. Comments from the DOE Team were submitted to Clean Line.

A Draft Tier IV Routing Study was submitted to DOE on October 4, 2013. This routing study discussed the development of the Tier IV criteria and included the measurement of each of the criterion for each link within a defined geographic area. The Applicant Proposed Route and Proposed Alternative Routes were comprised of a 1,000-foot corridor and a 200-foot right-of-way and representative route centerlines. The DOE Team reviewed the study and submitted comments to Clean Line. Comments included checking measurements for each of the Tier IV criterion (e.g., checking distances that a route parallels existing infrastructure or checking the number of structures within a certain distance of a route) and if EIS scoping comments pertaining to land uses, such as airports and irrigation systems, had been taken into account. Other comments submitted to the Clean Line Routing Team included questions about routes following existing linear corridors and connecting segments at nodes.

In addition, Tier IV process results were independently verified between October and November 2013 by the DOE Team using the Project GIS database information to ensure the correct information had been captured and used for the identification of the Applicant Proposed Route and Proposed Alternative Routes. The process consisted of several step-wise data checks and iterative reviews during which various members of the DOE Team and the Clean Line Routing Team participated in phone calls and webinars to discuss specific criteria, data sets, and GIS operations related to individual criteria to clarify any differences in results. The DOE Team offered suggestions for revisions to the GIS models used to calculate the Tier IV results and, in some cases, identified calculation errors in the models or in the data being used in the models. The process concluded when the DOE Team was able to agree to and reproduce the Tier IV criteria results produced by the Clean Line Routing Team.

At the end of the Tier IV process, the Clean Line Routing Team submitted a Final Tier IV Routing Study to DOE with 1,000-foot corridor and with a proposed 200-foot right-of-way and route centerlines. Additional detail on the Tier IV process can be reviewed in the Tier IV Routing Study developed by the Clean Line Routing Team and included as Appendix H. Clean Line also provided a response to the DOE Team comments on the Draft Tier IV Routing Study (Appendix I).

5.2 Converter Station Alternative

Based on comments received during the scoping period, DOE requested that Clean Line evaluate the feasibility of an alternative that would add a converter station in Arkansas. The Arkansas converter station would be an intermediate converter station; it would not replace the Texas County converter station or the Shelby or Tipton County converter station. Based on the feasibility evaluation, an Arkansas converter station could be sited in Pope County, Arkansas. This alternative converter station would be similar to the Texas County and Shelby converter stations. One 500kV AC transmission line would be required to connect the Arkansas converter station alternative to an interconnection point along an existing 500kV transmission line in Arkansas.

6. Tribal and Agency Review

DOE contacted Native American tribes and federal, state, and local agencies during the DOE EIS scoping process and solicited route-specific feedback to aid in the routing process. DOE sent maps showing the Network of Potential Routes to each entity and requested feedback. The agencies and tribes that DOE contacted during DOE EIS scoping are listed in Tables 6-1 and 6-2, respectively, in alphabetical order.

Table 6-1:
Agencies Contacted during Scoping

Agency	Agency
Advisory Council on Historic Preservation	Oklahoma Secretary of Energy
Arkansas Department of Environmental Quality	Oklahoma Tourism and Recreation Department
Arkansas Farm Service Agency	Oklahoma Turnpike Authority
Arkansas Game and Fish Commission	Oklahoma Water Resources Board
Arkansas Governor Beebe's Chief of Staff	St. Francis Levee District, Arkansas
Arkansas Highway and Transportation Department	Tennessee Department of Environment and Conservation
Arkansas Historic Preservation Program	Tennessee Department of Environment and Conservation, Division of Water Resources

Table 6-1:
Agencies Contacted during Scoping

Agency	Agency
Arkansas Natural Heritage Commission	Tennessee Department of Environment and Conservation, Natural Areas Program
Arkansas Parks and Tourism	Tennessee Department of Environment and Conservation, Natural Heritage Inventory Program
Bureau of Indian Affairs (Cherokee Nation, Eastern Oklahoma Region, Horton Agency, Pawnee Nation, Southern Plains Region)	Tennessee Department of Transportation
Farm Service Agency (Arkansas, Oklahoma, Tennessee)	Tennessee Historical Commission
Federal Highway Administration (Arkansas, Oklahoma, Tennessee)	Tennessee Office of the Governor
Natural Resources Conservation Service (Arkansas, Oklahoma, Tennessee; Eastern Programs Division DC)	Tennessee Valley Authority
Oklahoma Biological Survey	Tennessee Wildlife Resources Agency
Oklahoma Conservation Commission	U.S. Army Corps of Engineers (USACE) (Little Rock, Memphis, and Tulsa Districts; USACE Regulatory Office Oklahoma)
Oklahoma Department of Agriculture, Food, and Forestry	U.S. Coast Guard Tennessee
Oklahoma Department of Environmental Quality	U.S. Department of Agriculture
Oklahoma Department of Transportation (Ada and Oklahoma City, Oklahoma)	U.S. Environmental Protection Agency (Regions 4 and 6)
Oklahoma Department of Wildlife Conservation	U.S. Fish and Wildlife Service (Ecological Services Offices in Arkansas, Oklahoma, Tennessee); Central Arkansas National Wildlife Refuge
Oklahoma Historical Society State Historic Preservation Office	Vance Air Force Base Oklahoma

Table 6-2:
Tribes Contacted during Scoping

Tribe	Tribe
Absentee-Shawnee Tribe of Indians of Oklahoma	Kiowa Indian Tribe of Oklahoma
Alabama Quassarte Tribal Town	Modoc Tribe of Oklahoma
Apache Tribe of Oklahoma	Plains Apache
Arkansas River Bed Authority	Quapaw Tribe of Indians
Caddo Nation of Oklahoma	Sac & Fox Nation, Oklahoma
Cherokee Nation	Santee Sioux Nation, Nebraska
Cherokee Nation (Real Estate Service)	Seneca-Cayuga Tribe of Oklahoma
Choctaw Nation of Oklahoma	Southern Arapahoe & Southern Cheyenne
Comanche Nation, Oklahoma	The Muscogee (Creek) Nation—Eastern Oklahoma Region
Delaware Nation, Oklahoma	The Osage Nation
Delaware Tribe of Indians	Thlopthlocco Tribal Town
Eastern Band of Cherokee Indians	Tonkawa Tribe of Indians of Oklahoma
Iowa Nation, Oklahoma	United Keetoowah Band of Cherokee Indians in Oklahoma
Kaw Nation, Oklahoma	Wichita and Affiliated Tribes, Oklahoma
Kialegee Tribal Town	

During the DOE EIS scoping process, DOE invited federal agencies with jurisdiction by law and/or with special expertise applicable to the EIS to be cooperating agencies as defined in 40 CFR 1501.6. The cooperating agencies that have accepted DOE's invitation to date are identified in Table 6-3.

Table 6-3:
Plains & Eastern EIS Cooperating Agencies

Cooperating Agency
U.S. Department of the Interior, Bureau of Indian Affairs (BIA)
U.S. Department of Agriculture, Natural Resources Conservation Service (NRCS)
U.S. Fish and Wildlife Service (USFWS)
U.S. Environmental Protection Agency (EPA)
Tennessee Valley Authority (TVA)
U.S. Army Corps of Engineers (USACE)

As part of the Tier IV process, DOE invited the federal and state agencies and interested tribes to participate in the routing and siting process related to their authority or expertise. DOE sent agencies and tribes the Network of Potential Routes for review and input during DOE EIS Scoping and the Applicant Preliminary Proposed Route and Alternative Proposed Routes for review and input in August 2013. Because some comments from the EIS scoping process suggested that an alternative route be analyzed north of the city of Cedarville, Arkansas, in the Ozark National Forest as part of the Tier IV process, DOE requested that Clean Line apply the Tier IV siting criteria and evaluate a route in this area. Clean Line has identified a Proposed Alternative Route in this area in the Final Tier IV Routing Study.

The U.S. Department of Interior-National Park Service, National Trails Intermountain Region, submitted comments to DOE during EIS scoping regarding the Trail of Tears (National Historic Trail). As a result, the U.S. Department of Interior-National Park Service, National Trails Intermountain Region, and the U.S. Department of Agriculture-Forest Service, Ozark National Forest, were sent the Applicant Preliminary Proposed Route and Alternative Proposed Routes for review and input.

DOE received feedback from the following agencies and tribes regarding the Network of Potential Routes (sent during DOE EIS Scoping) and the Applicant Preliminary Proposed Routes and Alternative Proposed Routes (sent in August 2013). The agencies and tribes' responses are included in Table 6-4.

Table 6-4:
Agencies' and Tribes' Responses to DOE Request for Feedback

Agency or Tribe	Response
USACE Tulsa District	USACE sent a map showing the Webber Falls Lock and Dam Project in Muskogee, Oklahoma which may overlap the Project.
USACE Memphis District	USACE provided comments on the White River crossing stating that the Alternate Proposed Route may cross fewer wetlands than the proposed, and suggesting that the Mississippi River crossing be relocated to the north.

Table 6-4:
Agencies' and Tribes' Responses to DOE Request for Feedback

Agency or Tribe	Response
USACE Little Rock District	USACE provided comments on the Applicant Preliminary Proposed Route describing the permitting requirements and designations for the following water body crossings; Lee Creek, Vine Prairie Creek, Little Red River, Mulberry River, Big Piney Creek, Illinois Bayou, and Cadron Creek. Comments were also provided on the Proposed Alternative Routes describing permitting requirements and designations for the following water body crossings; Lee Creek, TJ House Reservoir, Mulberry River, Big Piney Creek, Illinois Bayou, Cadron Creek, Little Red River, and Departee Creek. The USACE also provided comments about oil and gas pipeline and well pad locations in relation to the Applicant Preliminary Proposed and Alternative Proposed Routes.
Tennessee Valley Authority	TVA provided data showing the locations of Element Occurrence Records of state and federally listed species and Natural Areas locations in relation to the Applicant Preliminary Proposed and Alternative Proposed Routes.
Tennessee Wildlife Resources Agency	The Tennessee Wildlife Resources Agency commented on the Network of Potential Routes and identified one route that would cross a stream mitigation site that is protected by a conservation easement and that requires that vegetation be allowed to grow with no maintenance. The agency sent a map showing the location of the stream mitigation project in relation to the route.
Choctaw Nation of Oklahoma	Choctaw Nation requested additional maps. As of the date this report no comments have been received.
Iowa Nation	The Iowa Nation reviewed the Network of Potential Routes and provided information on Iowa Nation trust and fee lands and a burial ground/cemetery in relation to the routes.
City of Enid, Oklahoma	Representatives from the City of Enid Oklahoma reviewed the Network of Potential Routes and provided water well and water collection system information in relation to the routes.
U.S. Forest Service (USFS)-Ozark-St. Francis National Forests	USFS provided ownership data to be corrected on Project maps showing the Piney Creek WMA, and concern with Proposed Alternative Route crossings in the Ozark-St. Francis National Forests due to forest clearing and rough terrain, concern about illegal off-highway vehicle use in transmission line ROW, and concern about visual impacts and listed species.
U.S. Department of Interior-National Park Service (NPS), National Trails Intermountain Region	NPS reviewed the Network of Potential Routes and provided information and maps of the Trail of Tears (National Historic Trail) in relation to the routes.
Tennessee State Historic Preservation Office, Tennessee Historical Commission	The Tennessee State Historic Preservation Office, Tennessee Historical Commission commented on the Applicant Preliminary Proposed and Alternative Proposed Routes. Their "architectural site files indicate numerous surveyed properties located within your proposed ROW on the Munford, Millington, and Brunswick quads. These resources must be re-charted, that is, current conditions photographs and NR eligibility determinations made." As for archaeological resources, they would want to wait for a formal Section 106 review request from the agency before being more specific. .

Table 6-4:
Agencies' and Tribes' Responses to DOE Request for Feedback

Agency or Tribe	Response
Oklahoma Historical Society State Historic Preservation Office	The Oklahoma Historical Society, State Historic Preservation Office requested additional maps to perform their review. As of the date this report no comments have been received.
Oklahoma Department of Wildlife Conservation	The Oklahoma Department of Wildlife Conservation reviewed the Network of Potential Routes and provided lesser prairie chicken core area maps in relation to the routes.
Arkansas State Historic Preservation Office	The Arkansas State Historic Preservation Office reviewed the 7.5 minute topographic maps depicting the Applicant Preliminary Proposed and Alternative Proposed Routes for the proposed Plains & Eastern Clean Line transmission line. The Arkansas State Historic Preservation Office stated that there were likely numerous archaeological and architectural properties located along all the routes and that cultural resource surveys will be required prior to construction. They recommended the Applicant Proposed Route be selected.
NRCS	NRCS reviewed the Network of Potential Routes and provided Farmland Conversion Impact Ratings, NRCS easements, and flood control dam information.
USFWS	USFWS commented on the Applicant Preliminary Proposed and Alternative Proposed Routes and provided information on threatened and endangered species habitats within the Project area related to specific route segments. USFWS also suggested specific changes to segments to avoid sensitive land uses and threatened and endangered species habitats.

As a result of the input received from the Ozark National Forest from its review of the Applicant Preliminary Proposed Route and Alternative Proposed Routes, DOE sent an invitation to the U.S. Department of Agriculture-Forest Service, Ozark National Forest, to participate to as a cooperating agency in the Plains & Eastern EIS on October 31, 2013.

DOE and Clean Line have reviewed the information provided by agencies and tribes in the routing process, considered requests, and incorporated data to the extent practicable.

7. DOE Alternatives for EIS: Routes and Converter Stations

Based on its independent evaluation, the DOE Team has decided to analyze the following route alternatives in the EIS.

7.1 Region 1 (Oklahoma Panhandle)

Region 1 begins at the converter station site in Texas County, Oklahoma, and continues east through Texas, Beaver, Harper, and Woodward counties approximately 116 miles to the area north of Woodward,

Oklahoma. Region 1 is located in agricultural land. The Clean Line Routing Team identified an Applicant Proposed Route and four Proposed Alternative Routes.

- The Applicant Proposed Route is located parallel to the existing Xcel/Oklahoma Gas & Electric (OG&E) Woodward-to-Hitchland 345kV transmission line for the majority of the length.
- Proposed Alternative Route 1-A parallels county roads and section lines for the majority of its length and parallels existing transmission lines for some short distances.
- Proposed Alternative Route 1-B parallels section lines for the majority of its distance.
- Proposed Alternative Route 1-C would combine with parts of Proposed Alternative Routes 1-A and 1-B.
- Proposed Alternative Route 1-D follows sections lines for the majority of its distance.

Region 1 Applicant Proposed Route and Proposed Alternative Routes are included in Figures 3-1 and 3-2 in Appendix H.

7.2 Region 2 (Oklahoma Central Great Plains)

Region 2 begins north of Woodward, Oklahoma, and continues southeast through Woodward, Major, and Garfield counties, Oklahoma, for approximately 106 miles to end approximately 16 miles southeast of Enid, Oklahoma. Region 2 is located in forested, agricultural, and rural residential developed areas. The Clean Line Routing Team identified an Applicant Proposed Route and two Proposed Alternative Routes.

- The Applicant Proposed Route parallels Western Farmers Electric Cooperative's existing 115kV transmission line, U.S. Route 60, section lines and parcel boundaries, and county roads to the extent practicable.
- Proposed Alternative Route 2-A parallels OG&E's Woodward-to-Cleo's Corner 155kV electrical transmission line and the Cimarron River floodplain for the majority of its length.
- Proposed Alternative Route 2-B parallels section lines and parcel boundaries and OG&E's Cottonwood Creek-to-Enid 138kV transmission line for the majority of its length.

A portion of the Applicant Proposed Route is outside the 1-mile-wide area of Link D-2 of the Network of Potential Routes presented at scoping. The Clean Line Routing Team sited the Applicant Proposed Route outside of the Network of Potential Routes in this area to avoid several center-pivot irrigation systems that were identified during scoping.

A portion of Proposed Alternative Route 2-B is outside of the 1-mile-wide area of Link D-1 of the Network of Potential Routes presented at scoping. The Clean Line Routing Team sited the Proposed Alternative Route 2-B outside of the Network of Potential Routes in this area to avoid a private airstrip identified through review of Federal Aviation Administration (FAA) data and aerial imagery.

Additionally, there is only one route option in the western portion of Region 2 because the city of Woodward, the city of Moreland, Boiling Springs State Park, potentially high value lesser prairie-chicken habitat and rough terrain limited the potential opportunities for routes.

Region 2 Applicant Proposed Route and Proposed Alternative Routes are included in Figures 3-1 and 3-2 in Appendix H.

7.3 Region 3 (Oklahoma Cross Timbers)

Region 3 begins southeast of Enid, Oklahoma and continues southeast through Garfield, Kingfisher, Logan, Payne, Lincoln, Creek, Okmulgee, and Muskogee counties for approximately 162 miles and ends north of Webbers Falls, Oklahoma, at the Arkansas River. Region 3 is located in forested areas, agricultural lands, and residential and commercial developed areas. The eastern portion of Region 3 from Stillwater to the region's terminal point on the eastern end has more residential development than the other portions of Region 3. The Clean Line Routing Team identified an Applicant Proposed Route and five Proposed Alternative Routes.

- The Applicant Proposed Route parallels OG&E's Cottonwood Creek-to-Enid 138kV transmission line, section lines, county roads, parcel boundaries, gas pipeline, the KAMO Electric Cooperative, Inc. Stillwater-to-Ramsey 115kV transmission line, KAMO Electric Cooperative, Inc. Stillwater-to-Cushing 69kV transmission line, and the OG&E's Beggs-to-Pecan Creek 138kV transmission line for the majority of its length.
- Proposed Alternative Route 3-A parallels county roads and parcel boundaries to the extent practicable before joining Applicant Proposed Route near Stillwater.
- Proposed Alternative Route 3-B begins where Proposed Alternative Route 3-A joins the Applicant Proposed Route and parallels parcel boundaries, section lines, and the KAMO Electric Cooperative, Inc. Stillwater-to-Cushing 69kV transmission line to the extent practicable until it rejoins the Applicant Proposed Route north of Ripley.
- Proposed Alternative Route 3-C parallels OG&E's Cushing-to-Bristow 138kV transmission line, roads, section lines and property boundaries to the extent practicable and rejoins the Applicant Proposed Route west of the Arkansas River.
- Proposed Alternative Route 3-D begins northwest of Boynton and joins Alternative Route 3-C approximately 1 mile to the southeast.
- Proposed Alternative Route 3-E begins north of Warner, Oklahoma, and rejoins the Applicant Proposed Route just west of the Arkansas River crossing.

Portions of the Applicant Proposed Route are outside the 1-mile-wide area of Link F-7 of the Network of Potential Routes presented at scoping. The Clean Line Routing Team sited the Applicant Proposed Route outside the Network of Potential Routes in response to scoping comments that identified additional residential areas and residences.

Portions of Proposed Alternative Route 3-C are outside the 1-mile-wide area of Link F-8 of the Network of Potential Routes presented at scoping. The Clean Line Routing Team sited Proposed Alternative Route 3-C outside the Network of Potential Routes in response to comments by the Oklahoma Department of Wildlife Conservation (ODWC) regarding the presence of federal grassland conservation easements and potential high value greater prairie-chicken habitat.

Portions of Proposed Alternative Route 3-D are outside the 1-mile-wide area of Link F-8 of the Network of Potential Routes presented at scoping. The Clean Line Routing Team sited Proposed Alternative Route 3-D outside - the Network of Potential Routes in response to comments received by the ODWC regarding the

presence of federal grassland conservation easements and potential high value greater prairie-chicken habitat

Region 3 Applicant Proposed Route and Proposed Alternative Routes are included in Figures 3-1 and 3-2 in Appendix H.

7.4 Region 4 (Arkansas River Valley)

Region 4 begins north of Webbers Falls in Muskogee County, Oklahoma, and continues east through Muskogee and Sequoyah counties, Oklahoma, and Crawford, Franklin, Johnson, and Pope counties, Arkansas, for approximately 127 miles, and ends north of Russellville, Arkansas. Region 4 is located in open lands, pasture, and mixed pine/hardwood forest. The Clean Line Routing Team identified an Applicant Proposed Route and five Proposed Alternative Routes.

- The Applicant Proposed Route parallels several existing transmission lines across the Arkansas River and continues into Arkansas and parallels OG&E's Muskogee-to-Fort Smith 345kV transmission, Gore-to-Alma 138kV transmission line, Interstate-40, Alma-to-Dardanelle 138kV transmission line, and county roads and parcel lines to the extent practicable.
- Proposed Alternative 4-A parallels parcel boundaries and the Nicut-to-Brushy Switching Station 69kV transmission line in Crawford County, Arkansas, to the extent practicable.
- Proposed Alternative 4-B is located within the Ozark National Forest in Crawford County, Arkansas.
- Proposed Alternative 4-C is a short route that parallels parcel lines to the extent practicable in the Van Buren, Arkansas area.
- Proposed Alternative 4-D is an alternative in the areas of Cedarville, Van Buren, and Mulberry, Arkansas.
- Proposed Alternative 4-E parallels parcel boundaries and the Dardanelle-to-Ozark 161kV transmission line to the extent practicable.

Portions of the Applicant Proposed Route are outside the 1-mile-wide area of Links H-1 and H-5 of the Network of Potential Routes presented at scoping. The Applicant Proposed Route was sited outside the Network of Potential Routes in this area to avoid residences and agricultural structures identified in comments submitted to the DOE during scoping.

Portions of Proposed Alternative Route 4-A are outside the 1-mile-wide area of Links G-2 and G-5 of the Network of Potential Routes presented at scoping to avoid residences and a municipality (Cedarville, Arkansas). These resources were identified in comments submitted to the DOE during EIS scoping and through comments received during Clean Line stakeholder meetings.

Portions of Proposed Alternative Route 4-B are outside the 1-mile-wide area of Links G-2 and G-6 of the Network of Potential Routes presented at scoping. Proposed Alternative Route 4-B was sited outside the Network of Potential Routes in this area to avoid residences and a municipality (Cedarville, Arkansas) and to respond to a scoping comment that requested an alternative route through the Ozark National Forest. These resources were identified in comments submitted to the DOE during EIS scoping and through comments received during stakeholder meetings.

Portions of Proposed Alternative Route 4-C are outside of the 1-mile-wide area of Link G-4 of the Network of Potential Routes presented at scoping. Proposed Alternative Route 4-C was sited outside the Network of Potential Routes in response to comments received by the DOE during the EIS scoping period regarding the residential area north of Van Buren.

Portions of Proposed Alternative Route 4-D are outside the 1-mile-wide area of Link G-5 of the Network of Potential Routes presented at scoping to avoid residences. These residences were identified in comments submitted to the DOE during scoping and through comments received during stakeholder meetings.

Region 4 Applicant Proposed Route and Proposed Alternative Routes are included in Figures 3-1 and 3-2 in Appendix H.

7.5 Region 5 (Central Arkansas)

Region 5 begins north of Russellville, in Pope County, Arkansas, and continues east through Pope, Conway, Van Buren, Faulkner, Cleburne, White, and Jackson counties, Arkansas, and ends southwest of Newport, in Jackson County, Arkansas, for 113 miles. Region 5 is located in forested areas, open lands for pasture or cultivated crops, and rural residential development. The Clean Line Routing Team identified an Applicant Proposed Route and six Proposed Alternative Routes.

- The Applicant Proposed Route parallels parcel boundaries and section lines, Entergy Arkansas Inc.'s Independence-to-Genpower Keo 500kV transmission line, and transmission pipeline to the extent practicable.
- Proposed Alternative Route 5-A is a short alternative that provides a route north of Dover, Arkansas, before it rejoins the Applicant Proposed Route.
- Proposed Alternative Route 5-B parallels existing transmission pipeline, electrical transmission lines, parcel boundaries, and the Entergy Arkansas, Inc.'s Independence-to-Genpower Keo 500kV transmission line to the extent practicable.
- Proposed Alternative Route 5-C is a short alternative that provides a route northeast of Letona, Arkansas before rejoining the Applicant Proposed Route.
- Proposed Alternative Route 5-D parallels the Entergy Arkansas, Inc.'s Independence-to-Genpower Keo 500kV transmission line, parcel boundaries, and transmission pipelines to the extent practicable.
- Proposed Alternative Route 5-E parallels existing transmission lines to the extent practicable through Faulkner County, Arkansas.
- Proposed Alternative Route 5-F provides an alternative to the south of Letona, Arkansas.

Region 5 Applicant Proposed Route and Proposed Alternative Routes are included in Appendix G.

7.6 Region 6 (Cache River, Crowley's Ridge Area, and St. Francis Channel)

Region 6 begins southwest of Newport in Jackson County, Arkansas, and continues northeast through Jackson, Cross, and Poinsett counties, Arkansas, for approximately 55 miles and ends south of Marked Tree Arkansas. With the exception of the Crowley's Ridge area, Region 6 is located in cultivated crops such

as rice, corn, and soybeans. Crowley's Ridge consists mostly of hardwood forest. The Clean Line Routing Team identified an Applicant Proposed Route and four Proposed Alternative Routes.

- The Applicant Proposed Route parallels the Entergy Arkansas Inc.'s Fisher-to-Cherry Valley 161kV transmission line, the St. Francis Levee, parcel boundaries, and county road to the extent practicable.
- Proposed Alternative Route 6-A parallels parcel boundaries and roads to the extent practicable to provide a southern alternative river crossing location for the Cache River.
- Proposed Alternative Route 6-B parallels parcel boundaries, State Route 14, and existing transmission lines to provide a northern alternative river crossing location for the Cache River.
- Proposed Alternative Route 6-C parallels parcel boundaries and local roads to the extent practicable to provide alternative crossing of Crowley's Ridge and the St. Francis Levee District ditches.
- Proposed Alternative Route 6-D is a short alternative that parallels a ditch to the extent practicable to provide an alternative crossing location for the St. Francis Levee District ditches.

Portions of the Applicant Proposed Route in Region 6 are outside the 1-mile-wide area of Links L-3, L-4, and L-5 of the Network of Potential Routes presented at scoping. These deviations outside the Network of Potential Routes resulted from aligning the Applicant Proposed Route to follow an existing electrical transmission line into Cross County, Arkansas, to follow the St. Francis Levee (Ditch No. 60), and to avoid private airfields and aerial applicator operations in Poinsett County, Arkansas.

Portions of Proposed Alternative Route 6-A are outside of the 1-mile-wide area of Link L-4 of the Network of Potential Routes presented at scoping. Proposed Alternative Route 6-A was sited outside the Network of Potential Routes in this area to follow parcel lines and traverse less forested wetlands.

Portions of Proposed Alternative Route 6-B are outside the 1-mile-wide area of Links L-2 and L-3 of the Network of Potential Routes presented at scoping. Proposed Alternative Route 6-B was sited outside the Network of Potential Routes in this area to follow an existing electrical transmission line south of Amagon and to avoid private airfields, aerial spraying, and agricultural operations in Poinsett County.

Region 6 Applicant Proposed Route and Proposed Alternative Routes are included in Figures 3-1 and 3-2 in Appendix H.

7.7 Region 7 (Arkansas Mississippi River Delta and Tennessee)

Region 7 begins south of Marked Tree, in Poinsett County, Arkansas, and continues east and southeast through Poinsett and Mississippi counties, Arkansas, across the Mississippi River and into Tipton and Shelby counties, Tennessee, for approximately 43 miles, ending near the Tipton/Shelby County line south of Tipton, Tennessee. Region 7 west of the Mississippi River is located in cultivated, agricultural crops; east of the Mississippi River it is located in a mix of hardwood forests, residential and commercial development, and open land areas. The Clean Line Routing Team identified an Applicant Proposed Route and four Proposed Alternative Routes.

- The Applicant Proposed Route parallels Entergy Arkansas Inc.'s Marked Tree to Marion 161kV electrical transmission line, county roads, section lines, and parcel boundaries to the extent practicable.

- Proposed Alternative Route 7-A parallels existing canals, county roads, section lines, parcel boundaries, and field lines to the extent practicable to provide an alternative river crossing location to the north for the Mississippi River.
- Proposed Alternative Route 7-B parallels property lines and local roads to provide an alternative in Tipton County, Tennessee.
- Proposed Alternative Route 7-C parallels local roads and TVA's Covington-to-Northeast Gate 161kV transmission line and provides a southern route into the converter station.
- Proposed Alternative Route 7-D parallels TVA's Shelby-to-Sans Souci 500kV electrical transmission line and provides a northern route into the converter station.

Portions of the Applicant Proposed Route are outside of the 1-mile-wide area of Links M-2 and M-5 of the Network of Potential Routes presented at scoping. In Link M-2, the Clean Line Routing Team identified a route that more closely follows Entergy Arkansas Inc.'s Marked Tree-to-Marion 161kV electric transmission line. In Link M-5, the Clean Line Routing Team identified a route that more closely followed field lines and parcel boundaries and that avoided residential areas identified during aerial reconnaissance.

Portions of Proposed Alternative Route 7-A are outside of the 1-mile-wide area of Link M-1 of the Network of Potential Routes presented at scoping. Proposed Alternative Route 7-A was sited outside the Network of Potential Routes in this area to avoid a center pivot irrigation system and a perpendicular crossing of an airfield observed during aerial reconnaissance. Although the GIS data sources used to identify airfields show a private airfield east of Marie, the Clean Line Routing Team was not able to visually confirm the existence of any private airfields within 0.5 mile of the route during the aerial reconnaissance.

Portions of Proposed Alternative Route 7-B are outside the 1-mile-wide area of Link M-5 of the Network of Potential Routes presented at scoping. The Clean Line Routing Team proposed this alternative in response to scoping comments received by the DOE; these comments requested the analysis and identification of routes that were south of Millington, Tennessee.

Portions of Proposed Alternative Route 7-C are outside the 1-mile-wide area of Link M-5 of the Network of Potential Routes presented at scoping. The Clean Line Routing Team proposed this alternative in response to scoping comments received by the DOE; these comments requested the analysis and identification of routes south of the Millington Regional Airport that also would avoid Munford, Tipton, and Atoka.

Proposed Alternative Route 7-D is outside of the Network of Potential Routes presented at scoping. The Clean Line Routing Team developed Proposed Alternative Route 7-D in response to scoping comments received by the DOE expressing concerns about the existing and planned airspace north of the Millington Regional Airport; this alternative is a greater distance from the airport than the Applicant Proposed Route and follows the TVA Shelby-to-Sans Souci 500kV existing transmission line for portions of its length.

Region 7 Applicant Proposed Route and Proposed Alternative Routes are included in Figures 3-1 and 3-2 in Appendix H.

7.8 Converter Stations

DOE will analyze three converter station alternatives. The applicant proposed western converter station would be located in Texas County, Oklahoma. The applicant proposed eastern converter station would be located in Shelby or Tipton County, Tennessee. The alternative converter station would be located in Pope County, Arkansas. Each converter station would require the use of approximately 30 to 50 acres of land.

8. Next Steps

The DOE Team will begin analysis of the Applicant Proposed Routes and Proposed Alternative Routes and converter stations described above in the EIS. The affected environment section of the EIS will be developed based on the 1,000 foot wide corridor identified during the Tier IV process for the Applicant Proposed Routes and Proposed Alternative Routes. Potential impacts will be identified based on a 200 foot right-of-way surrounding the representative route centerlines.

9. Glossary

Applicant Proposed Route. The HVDC route that is Clean Line's proposed route for the Project. This route is generally 1,000 feet wide.

Applicant Preliminary Proposed Route. The HVDC route that is Clean Line's preliminary proposed route for the Project. This route is in a 2,000-foot corridor and a description of it was sent to agencies and tribes in August 2013 for feedback.

Candidate Corridor. A corridor within the Study Area approximately 5 miles wide.

Clean Line Routing Team. Clean Line employed a multi-disciplinary team of professionals, referred to hereinafter as the "Clean Line Routing Team," to undertake this route selection process. The Clean Line Routing Team included Clean Line employees and representatives from Clean Line's technical team, including members from Ecology and Environment (general NEPA/EIS consultant), SWCA Environmental Consultants (cultural and historical resources), and Pike Energy Solutions (engineering and construction).

Converter Station. Project end-point and potentially mid-point substation. Each station would require the use of approximately 30 to 50 acres and would be located on private land.

Corridor Network. Several intersecting Candidate Corridors.

DOE Team. The U.S. Department of Energy, Southwestern Power Administration, and the third party contractor (Tetra Tech).

General and Technical Guidelines. The General Guidelines are intended to avoid conflicts with existing resources, developed areas, and existing incompatible infrastructure; to maximize opportunities for paralleling existing compatible infrastructure; and to take into consideration land use and other factors

affecting route selection. The Technical Guidelines are specific to the Project. These are based on technical limitations related to the design, right-of-way requirements, or reliability concerns.

Link. A portion of a route between nodes within a network.

Network of Potential Routes. A refined version of the Route Network that was presented to the DOE for analysis in the NEPA scoping process.

Proposed Alternative Routes. Several Alternative Routes proposed by Clean Line to DOE for analysis as the HVDC transmission line route alternatives in the Environmental Impact Statement. Each Proposed Alternative Route is approximately 1,000 feet wide.

Node. A point of intersection of potential routes within a network.

Opportunities. Encompass pre-existing linear infrastructure features along which transmission line development is considered generally compatible. Examples include existing federal, state, and county roads; existing electric transmission lines; railroads; and existing transmission pipelines.

Segments. Geographic divisions of a network, generally where several links overlap at a common node.

Sensitivities. Encompass various resources that potentially limit or conflict with transmission line development. Examples include areas restricted by regulations or covenants/easements limiting transmission line development, pre-existing incompatible land uses, or other locations containing natural or man-made resources that are subject to protection and/or that are difficult to mitigate (e.g., threatened and endangered species habitat, residential and commercial development, cultural and historic resources, etc.).

Exhibit 2: Tier IV Routing Study

Tier IV Routing Study

for the

PLAINS & EASTERN

CLEAN LINE

November 8, 2013

Prepared for:



Prepared by:



This page intentionally left blank.

Acronyms and Abbreviations

AC	alternating current
APR	Applicant Proposed Route
AR	Alternative Route
BPA	Bonneville Power Administration
Clean Line	Plains and Eastern Clean Line LLC and Plains and Eastern Clean Line Oklahoma LLC
CR	County Road
DOD	(United States) Department of Defense
DOE	(United States) Department of Energy
EIS	Environmental Impact Statement
ESRI	Environmental Systems Resource Institute
FAA	Federal Aviation Administration
ft	feet
GIS	geographic information system
GLO	General Land Office
GRPC	greater prairie-chicken
HV	high-voltage
HVDC	high-voltage direct current
I	Interstate
kV	kilovolt(s)
LEPC	lesser prairie-chicken
MW	megawatt(s)
NEPA	National Environmental Policy Act
NLCD	National Land Cover Dataset
NOI	Notice of Intent
NRHP	National Register of Historic Places
NWI	National Wetlands Inventory
ODWC	Oklahoma Department of Wildlife Conservation
OG&E	Oklahoma Gas & Electric
OGRPCSPT	Oklahoma Greater Prairie-Chicken Spatial Planning Tool
OLEPCSPT	Oklahoma Lesser Prairie-Chicken Spatial Planning Tool

November 2013

Project	Plains & Eastern Clean Line transmission project
RFP	Request for Proposals
ROW	right-of-way
SGP CHAT	Southern Great Plains Crucial Habitat Assessment Tool
SWPA	Southwestern Power Administration
TNC	The Nature Conservancy
TVA	Tennessee Valley Authority
U.S.C.	United States Code
USACE	United States Army Corps of Engineers
USDA	United States Department of Agriculture
USFWS	United States Fish and Wildlife Service
WAPA	Western Area Power Administration
WGA	Western Governors Association
WMA	Wildlife Management Area

1.0 Introduction

1.1 Purpose of this Report

The goal of this Tier IV Routing Study is to present the process Clean Line used to identify the potential routes for the high-voltage direct current (HVDC) transmission line for the Plains & Eastern Clean Line transmission project (the Project), including both the “Applicant Proposed Route” and “Proposed Alternative Routes.”

This Tier IV Routing Study is organized as follows:

- Section 1 describes the purpose of this report, Project background, and the approach to the route identification process;
- Section 2 provides a general description of the Project;
- Section 3 describes the iterative Tier IV process used to identify the Applicant Proposed Route and Proposed Alternative Routes for the HVDC Transmission Line portion of the Project;
- Section 4 discusses the geographic information system (GIS) data sources used during the Tier IV process; and
- Section 5 provides the references used during the Tier IV process.

Clean Line is providing the United States Department of Energy (DOE) with the results of this Tier IV process, including the Applicant Proposed Route and the Proposed Alternative Routes for the HVDC transmission line. DOE intends to independently review the Applicant Proposed Route and Proposed Alternative Routes. Based on the outcome of that independent review, the DOE will select the Alternative Routes to be analyzed, including the Applicant Proposed Route, in the Environmental Impact Statement (EIS) for the Project.

1.2 Project Background

On June 10, 2010, the DOE issued a Request for Proposals (RFP) for new or upgraded transmission projects pursuant to Section 1222(b) of the Energy Policy Act of 2005 (codified at 42 United States Code [U.S.C.] §16421). Clean Line Energy Partners LLC of Houston, Texas, parent company of Plains and Eastern Clean Line LLC and Plains and Eastern Clean Line Oklahoma LLC, (collectively referred to herein as “Clean Line”) responded to the RFP on July 6, 2010. The DOE published its Notice of Intent (NOI) to prepare an EIS for the Project under the National Environmental Policy Act (NEPA) on December 21, 2012.

The goal of the Project is to develop new transmission capacity to meet the actual or projected increase in demand for additional electric transmission capacity to deliver renewable energy generated in the Oklahoma Panhandle region to load-serving entities in the Mid-South and southeastern United States. The Project will improve public access to renewable energy at a competitive cost; assist in satisfying the growing customer demand for renewable energy; provide safe, efficient, and reliable infrastructure; and reduce the variability of renewable energy by connecting geographically diverse resources with high-voltage (HV) transmission.

1.3 Approach to Route Identification Process

As part of its planning process prior to and since submitting its Section 1222 application to the DOE and the Southwestern Power Administration (SWPA), Clean Line evaluated siting for the converter stations and the HVDC transmission line portion of the Project using an iterative process. Clean Line began with a broad Study Area, to which it applied progressively more detailed and restrictive siting criteria, resulting in identification of the proposed converter station siting areas and the Network of Potential Routes published in the NOI. Clean Line considered and utilized guidelines and criteria consistent with transmission line siting principles used by federal entities.¹ This process was described in the **Project Siting Narrative** (Clean Line 2013k).

Following the close of the NEPA scoping period, Clean Line considered the scoping comments received by the DOE during the EIS scoping period and the stakeholder comments received by Clean Line (see Section 3.3.2) and continued the iterative route identification process. Between April and June 2013, Clean Line consulted with the DOE on the Tier IV criteria. The DOE approved the criteria. Thereafter, Clean Line began the route identification process that is described in this Tier IV Routing Study (Section 3.0).

¹For example, the Rural Utility Service (Basin Electric 2012), Western Area Power Administration (WAPA 2010) and Bonneville Power Administration (BPA 2010) use similar route development processes, siting criteria, and alternatives analysis.

2.0 Project Description

The proposed Project is an overhead ± 600 kilovolt (kV) HVDC electric transmission system and associated facilities with the capacity to deliver approximately 3,500 megawatts (MW) from renewable energy generation facilities in the Oklahoma Panhandle region to load-serving entities in the Mid-South and southeastern United States via an interconnection with Tennessee Valley Authority (TVA). The proposed Project would include the following major facilities:

- Converter stations;
- HVDC transmission facilities;
- Alternating current (AC) transmission facilities;
- Access roads; and
- Interconnections to existing transmission systems.

This report pertains to the routing of the HVDC transmission facilities right-of way (ROW). For a more detailed Project Description see the **Project Siting Narrative** (Clean Line 2013k).

This page intentionally left blank.

3.0 Development Process for the HVDC Transmission Line Routes

Clean Line identified the Network of Potential Routes, each approximately 1-mile wide, published in the NOI (Clean Line 2013k). After the completion of the DOE's NEPA public scoping process, Clean Line began Tier IV of the HVDC transmission line route identification process.

The Routing Team (defined in Section 3.1 below) met with the DOE and Tetra Tech staff in April 2013 to discuss the scoping comments and the Tier IV process and review siting criteria. This process and siting criteria were documented in the June 2013 Tier IV Siting Criteria (Appendix A). The Routing Team then began the Tier IV Siting process and in July 2013 the Routing Team met with the DOE, the SWPA, and Tetra Tech to discuss its preliminary findings of the siting efforts. The Routing Team then refined its conclusions based on feedback from the DOE, the SWPA, and Tetra Tech. The findings are provided in this Tier IV Routing Study.

3.1 Routing Team

Clean Line continued to employ a multi-disciplinary team of professionals, referred to hereinafter as the "Routing Team," to undertake this Tier IV of the route identification process. The Routing Team included Clean Line employees and representatives from Clean Line's technical team, including members from Ecology and Environment, Inc. (general Environmental Consultant), SWCA Environmental Consultants (cultural and historical resources consultant), and Pike Energy Solutions (engineering and construction consultant).

3.2 Transmission Line Routing Terminology

During previous phases of the route identification process (see **Project Siting Narrative** [Clean Line 2013k]), the Routing Team developed terms to describe the components of the network. The following terms continued to be used during Tier IV:

- *Segments* – Geographic divisions of a network, generally where several Links overlap at a common Node.
- *Node* – A point of intersection of potential routes within a network.
- *Link* – A portion of a route between Nodes within a network.

The following terms correspond to degrees of refinement of the network through the route identification process. The list starts with terms used to describe the Network of Potential Routes published in the NOI, and narrows to the Tier IV Route Network, and subsequently to the Applicant Proposed Route and Proposed Alternative Routes:

- *Network of Potential Routes* – The series of intersecting routes that was presented to the DOE for review in the NEPA scoping process.
- *Tier IV Route Network* – The range of alternatives derived from the Network of Potential Routes from which the Routing Team identified the Applicant Proposed Route and the Proposed Alternative Routes.
- *Applicant Proposed Route* – The HVDC route that is Clean Line's proposed route for the Project. This route is generally 1,000 feet wide.

November 2013

- *Proposed Alternative Routes* –Other HVDC routes, in addition to the Applicant Proposed Route, proposed by Clean Line to the DOE for review in the EIS for the Project. Each Proposed Alternative Route is approximately 1,000 feet wide.

In addition, throughout the Tier IV process, the Routing Team continued to use the terms “opportunities” and “sensitivities.” As explained in the **Project Siting Narrative** (Clean Line 2013k), opportunities encompass pre-existing linear infrastructure features along which transmission line development is considered generally compatible. Examples include existing federal, state, and county roads; existing electric transmission lines; railroads; and existing transmission pipelines. Sensitivities encompass various resources that may potentially limit or conflict with transmission line development. Examples include areas restricted by regulations or covenants/easements limiting transmission line development, pre-existing incompatible land uses, or other locations containing natural or manmade resources that are subject to protection and/or that are difficult to mitigate (e.g., threatened and endangered species habitat, residential and commercial development, cultural and historic resources).

3.3 Development Process for the Proposed Alternative Routes

This section explains the process the Routing Team used to develop the Applicant Proposed Route and Proposed Alternative Routes. Section 3.3.1 identifies the General and Technical Guidelines developed by the Routing Team to guide the Tier IV route identification process. Section 3.3.2 describes the process and criteria used by the Routing Team to identify the Applicant Proposed Route and Proposed Alternative Routes. The Tier IV analysis integrated information from, and built upon, the information gained in the prior Tiers, as described in the **Project Siting Narrative** (Clean Line 2013k).

3.3.1 Development of General and Technical Guidelines

The Routing Team, in consultation with the DOE, developed General and Technical Guidelines for use throughout the Tier IV route identification process. The General Guidelines are intended to minimize conflicts with existing resources, developed areas, and existing incompatible infrastructure; to maximize opportunities for paralleling existing compatible infrastructure; and to take into consideration land use and other factors affecting route identification. The General Guidelines included the following:

- Utilize existing linear corridors to the extent practicable;
- Utilize areas with land uses/land cover that are consistent or compatible with linear utility uses, such as existing utility corridors and open lands, to the extent practicable;
- Avoid existing residences;
- Avoid nonresidential structures, including barns, garages, and commercial buildings;
- Minimize interference with the use and operation of existing schools, known places of worship, and existing facilities used for cultural, historical, and recreational purposes;
- Avoid cemeteries or known burial places;
- Minimize adverse effects to economic activities (e.g., impacts to existing residences, businesses and developed areas);
- Minimize crossing of designated public resource lands, including, but not limited to, national and state forests and parks, large camps and other recreation lands, designated battlefields or other designated historic resources and sites, and state-owned wildlife management areas;
- Minimize crossings of tribal trust lands and allotments;

November 2013

- Minimize the number and length of crossings of large lakes, major rivers, large wetland complexes, or other sensitive water resources;
- Minimize adverse effects on protected species habitat and on other identified sensitive natural resources (e.g., forested areas, native prairies, and other areas as identified by Natural Heritage Commissions);
- Minimize visibility of transmission lines from residential areas and visually sensitive public locations (e.g., public parks, scenic routes or trails, and designated Wild and Scenic Rivers);
- Avoid areas of past environmental contamination to the extent practicable; and
- Minimize route length, circuitry, special design requirements, and impractical construction requirements.

The Technical Guidelines are specific to the Project. They are based on technical limitations related to the design, ROW requirements, or reliability concerns. The Technical Guidelines are informed by: (1) technical expertise of industry professionals (e.g., civil, structural, and electrical engineers; transmission planners; and other Project Managers) responsible for the reliable and economical construction, operation, and maintenance of the Project and other electric system facilities to which the Project interconnects; (2) North American Electric Reliability Corporation reliability standards; and (3) industry best practices. The Technical Guidelines included the following:

- Minimize the crossing of transmission lines of 345kV or above;
- Minimize paralleling corridors with more than one existing circuit of 345kV or above;
- Maintain 200 feet of centerline-to-centerline separation when paralleling existing transmission lines of 345 kV or above;
- Maintain 150 feet of centerline-to-centerline separation when paralleling 138kV or lower voltage transmission lines;
- Minimize turning angles in the transmission line greater than 65 degrees²;
- Minimize the length of the transmission line located on soils sloped more than 20 percent; and
- Minimize underbuild³ or double circuit arrangements with existing alternating current (AC) infrastructure.

3.3.2 Tier IV – Development of Proposed Alternative Routes

The steps in the Tier IV process are described below:

- Review and consideration of stakeholder and scoping comments;
- Development of Tier IV criteria;
- Consultation with and concurrence by the DOE on the Tier IV criteria;
- Identification of Tier IV Route Network;
- Identification of Preliminary Applicant Proposed Route and Proposed Alternative Routes;

² The degrees expressed here represent the angle of a turn measured from a straight line. For example, a straight line is 0 degrees and a light angle would be 3 to 4 degrees.

³ "Underbuild" refers to conductors from other circuits that are placed on the same structure, but below HVDC conductors.

November 2013

- Aerial reconnaissance; and
- Development of the Applicant Proposed Route and Proposed Alternative Routes, each approximately 1,000 feet wide.

Review and Consideration of Stakeholder and Scoping Comments

Clean Line reviewed and considered stakeholder comments obtained by Clean Line and scoping comments received by the DOE during the EIS scoping period (DOE 2013). The Routing Team integrated the stakeholder and scoping comments into the Tier IV criteria (Appendix A, Table 1). Thereafter, the Routing Team reviewed and verified locational and/or subject-specific information (e.g., residence locations, airstrips/aviation bases, pivot irrigation, planned subdivisions, planned commercial development, known plant and wildlife habitat, refined infrastructure information, commercial recreation areas, and/or cultural resources) contained in those stakeholder and scoping comments to the extent practicable. Review and verification methods included review and/or cross-reference with applicable third-party data to confirm the physical location of features, validate other information provided, and/or obtain additional information pertaining to a specific comment. For example, the Routing Team utilized best available aerial imagery (USGS 2010) to visually confirm the physical location of airstrips and center pivot agricultural fields.

Development of Tier IV Criteria

To identify, refine, and analyze the Tier IV Route Network, the Routing Team used the Tier IV siting criteria provided in Appendix A. Building on the siting criteria used during Tiers 1 through III of the route development process (Clean Line 2013k), the Routing Team developed the Tier IV criteria in consultation with DOE and DOE's NEPA consultant, Tetra Tech. The Tier IV criteria focus on localized opportunities and sensitivities, and information gathered by Clean Line during stakeholder outreach and by the DOE during the EIS scoping period. The DOE reviewed and approved the Tier IV criteria for use in the route identification process in June 2013.

Identification of the Tier IV Route Network

Using the Tier IV criteria, and considering the stakeholder and scoping comments received, the Routing Team conducted an iterative route identification process to identify the Tier IV Route Network. The Tier IV route identification process included the identification and analysis of over 990 Links totaling over 2,720 miles. To identify the Tier IV Route Network, the Routing Team engaged in the following route identification process:

- Starting with the Network of Potential Routes, identification of representative centerlines for the Tier IV Route Network based on opportunities and sensitivities and scoping and stakeholder comments;
- Adjustment of representative centerlines in relation to the Tier IV criteria;
- Completion of GIS analysis of each Link for quantifiable criteria;
- Comparison of Links using Paired-Node Analysis (see below); and
- Elimination of Links according to the results of the Paired-Node Analysis.

A key tool used by the Routing Team to identify and evaluate the Tier IV Route Network was "Paired-Node Analysis." In this process, the Routing Team compared pairs of Links or series of Links within a relatively small geographic area between two common endpoints using the Tier IV siting criteria (see

November 2013

Appendix A). In Paired-Node Analysis, a computer program presents all Tier IV criteria data associated with the selected pairs or series of links from the project's Geographic Information System database. The program then displays the sum of all Tier IV criteria along a series of links to facilitate comparison.

Based on the results of these comparisons, the Routing Team eliminated from further consideration Links with relatively fewer opportunities and/or greater sensitivities when compared to other Links within the Tier IV Route Network. Appendix B provides an example of a Paired-Node Analysis conducted by the Routing Team.

The Routing Team conducted the Paired-Node Analysis in association with the identification of the Tier IV Route Network during several routing meetings. At the completion of the routing meetings, the Routing Team had identified the Tier IV Route Network.

Identification of Preliminary Applicant Proposed Route and Proposed Alternative Routes

From the Tier IV Route Network, the Routing Team used the Paired-Node Analysis to identify the Preliminary Applicant Proposed Route and Proposed Alternative Routes. The Preliminary Applicant Proposed Route and Proposed Alternative Routes were then further evaluated during the aerial reconnaissance (see below and see Appendix C).

Aerial Reconnaissance

The Routing Team completed an aerial reconnaissance to verify field conditions and determine the need for adjustments to the Preliminary Applicant Proposed Route and Proposed Alternative Routes. The aerial reconnaissance was conducted from August 13 to 18, 2013. The observations made during the aerial reconnaissance were used to refine the Preliminary Applicant Proposed Route and Proposed Alternative Routes and identify the Applicant Proposed Route and Proposed Alternative Routes (see Section 3.3.3). A summary of the findings of the aerial reconnaissance are provided in Appendix C.

3.3.3 Applicant Proposed Route and Proposed Alternative Route Descriptions

Clean Line provided the Applicant Proposed Route and the Proposed Alternative Routes to the DOE. Following receipt, the DOE independently reviewed the Applicant Proposed Routes and Proposed Alternative Routes and provided comments to Clean Line.

Table 3-1 provides a cross-reference between the Proposed Alternative Routes and the corresponding Links of the Applicant Proposed Route. Table 3-1 also provides a cross reference between the Applicant Proposed Route, the Proposed Alternative Routes, and the Links from the Network of Potential Routes that were shown during the DOE scoping period. Figures 3-1 and 3-2 (see Appendix D, "Figures") illustrate the location of the Applicant Proposed Route and Proposed Alternative Route corridors and centerlines, respectively.

Table 3 1

Region 1 (Oklahoma Panhandle)			
Applicant Proposed Route ³	n/a	A-2, B-8	Texas, Beaver, Harper, Woodward
1-A ³	PR Link 2, PR Link 3, PR Link 4, PR Link 5	A-1, B-1, B-5, B-7	Texas, Beaver, Harper, Woodward
1-B ³	PR Link 2, PR Link 3	A-1, B-2, B-4, B-8	Texas, Beaver
1-C ³	PR Link 2, PR Link 3	A-1, B-1, B-5, B-6, B-8	Texas, Beaver
1-D ³	PR Link 3, PR Link 4	B-8	Beaver, Harper
Region 2 (Oklahoma Central Great Plains)			
Applicant Proposed Route ³	n/a	C-1, C-2, D-2	Woodward, Major, Garfield
2-A ³	PR Link 2	C-3	Woodward, Major
2-B ³	PR Link 3	D-1	Major, Garfield
Region 3 (Oklahoma Cross Timbers)			
Applicant Proposed Route ³	n/a	E-1, E-6, E-7, F-2, F-5, F-7, G-1	Garfield, Kingfisher, Logan, Payne, Lincoln, Creek, Okmulgee, Muskogee
3-A ³	PR Link 1	E-2	Garfield, Logan, Payne
3-B ³	PR Link 1, PR Link 2, PR Link 3	E-2, E-5	Garfield, Logan, Payne
3-C ³	PR Link 3, PR Link 4, PR Link 5, PR Link 6	E-4, F-1, F-4, F-8, G-1	Payne, Lincoln, Creek, Okmulgee, Muskogee
3-D ³	PR Link 5, PR Link 6	F-6, F-8, G-1	Muskogee
3-E ³	PR Link 6	G-1	Muskogee
Region 4 (Arkansas River Valley)			
Applicant Proposed Route ³	n/a	G-1, G-3, G-4, G-5, G-8, H-1	Oklahoma – Muskogee, Sequoyah Arkansas – Crawford, Franklin, Johnson, Pope
4-A ³	PR Link 3, PR Link 4, PR Link 5, PR Link 6	G-2, G-5, G-6, G-7, G-8	Oklahoma – Sequoyah Arkansas – Crawford, Franklin
4B ³	PR Link 2, PR Link 3, PR Link 4, PR Link 5, PR Link 6, PR Link 7, PR Link 8	G-1, G-2, G-6, G-9, H-1	Oklahoma – Sequoyah Arkansas – Crawford, Franklin
4-C ³	PR Link 5	G-4	Arkansas - Crawford
4-D ³	PR Link 4, PR Link 5, PR Link 6	G-5, G-2, G-6, G-7	Arkansas – Crawford, Franklin
4-E ³	PR Link 8, PR Link 9	G-8, H-2, H-4, H-6	Arkansas – Franklin, Johnson, Pope
Region 5 (Central Arkansas)			
Applicant Proposed Route ³	n/a	H-6, I-1, I-3, I-5, J-1, J-4, J-6, J-8, K-1	Pope, Conway, Van Buren, Cleburne, White, Jackson

Table 3 1 Locations of Proposed Alternative Routes			
Alternative Routes	Corresponding Links of the Applicant Proposed Route ¹	Network of Potential Route Links ²	County(ies)
5-A ³	PR Link 1	H-6, I-1	Pope
5-B ³	PR Link 3, PR Link 4, PR Link 5, PR Link 6	I-2, I-6, J-2, J-5, J-8	Pope, Conway, Faulkner, White
5-C ³	PR Link 6, PR Link 7	J-6, J-7, K-1	White
5-D ³	PR Link 9	K-2	White, Jackson
5-E ³	PR Link 4, PR Link 5, PR Link 6	I-4, I-6, J-2, J-5, J-8	Van Buren, Faulkner, White
5-F ³	PR Link 5, PR Link 6	I-5, I-6, J-2, J-5, J-8	Cleburne, White
Region 6 (Cache River, Crowley's Ridge Area, and St. Francis Channel)			
Applicant Proposed Route ³	n/a	K-3, L-1, L-3, L-4, L-5	Jackson, Poinsett, Cross
6-A ³	PR Link 2, PR Link 3, PR Link 4	L-4	Jackson, Poinsett
6-B ³	PR Link 3	L-2, L-3	Jackson, Poinsett
6-C ³	PR Link 6, PR Link 7	L-4, L-5	Poinsett
6-D ³	PR Link 7	L-5	Cross, Poinsett
Region 7 (Arkansas Mississippi River Delta and Tennessee)			
Applicant Proposed Route ³	n/a	M-2, M-5	Arkansas – Poinsett, Mississippi Tennessee – Tipton, Shelby
7-A ³	PR Link 1	M-1, M-3	Arkansas – Poinsett, Mississippi Tennessee – Tipton
7-B ³	PR Link 3, PR Link 4	M-5	Tennessee – Tipton, Shelby
7-C ³	PR Link 3, PR Link 4, PR Link 5	M-5	Tennessee – Tipton, Shelby
7-D ³	PR Link 4, PR Link 5	M-5	Tennessee – Tipton, Shelby

Notes:

- 1 = This column cross-references the links of the Applicant Proposed Route that were used for the quantitative comparison to a particular Proposed Alternative Route presented in Tables 3-2 through 3-8. The Applicant Proposed Route Links are shown in Figure 3-2.
- 2 = This column cross-references the Links from the Network of Potential Route Links (i.e., these links were shown on the maps used during the DOE scoping period) within which the Applicant Proposed Route and each Proposed Alternative Route are located. The Links from the Network of Potential Route Links are shown in Figures 3-1 and 3-2.
- 3 = The identified Alternative Route has a portion of the corridor located outside of the NOI Scoping Corridor (i.e., Network of Potential Route Links) identified during the DOE scoping period.

For purposes of this Tier IV Routing Study, Clean Line divided the Project into seven regions based on geographic similarities and common nodes in the routes. The general location and land cover of each Region is presented in Sections 3.3.3.1 through 3.3.3.7. Each section also describes the locations of the Applicant Proposed Route and Proposed Alternative Routes within the Region, identifies the reason for any routes being located outside of the Network of Potential Routes presented during scoping, provides a table summarizing Tier IV criteria for the Applicant Proposed Route and Proposed Alternative Routes, explains the key Tier IV criteria used by the Routing Team to identify the Applicant Proposed Route and Proposed Alternative Routes, and explains the Routing Team's reasons for identifying the Applicant Proposed Route rather than the Proposed Alternative Routes. Table 3-1 identifies the Alternative

November 2013

Routes in which portions of the corridor are located outside of the Network of Potential Route Links identified during the DOE scoping period. Many of these deviations were *de minimis*. Other deviations from the Network of Potential Routes are called out and explained in the discussion of each Region.

3.3.3.1 Region 1 (Oklahoma Panhandle)

Region 1 begins at the proposed converter station site located in Texas County, Oklahoma, continues east through Texas, Beaver, Harper, and Woodward Counties, Oklahoma, for a distance of approximately 116 miles, and terminates near the intersection of the Harper/Woodward County line and State Route (S.R.) 34, north of Woodward, in Harper County, Oklahoma.

Land cover in Region 3 consists generally of agricultural lands such as pasture and cultivated crops. Towns near the routes in the Region include Hardesty, Laverne, and May, Oklahoma.

Clean Line identified the Applicant Proposed Route and four Proposed Alternative Routes in Region 1. The locations of these routes are summarized below and illustrated on Figures 3-2a through 3-2c.

- **The Applicant Proposed Route** begins at the proposed converter station in Texas County and traverses east to parallel Southwestern Public Service Company's Finney-to-Hitchland 345kV electrical transmission line for approximately 2 miles. This route then turns south and then east for approximately 5 miles, following section lines, until it intersects the Xcel/Oklahoma Gas & Electric (OG&E) Woodward-to-Hitchland 345kV electrical transmission line, which it parallels for approximately 87 miles through Texas, Beaver, and Harper Counties, Oklahoma. Where the OG&E transmission line turns south in Harper County, the Applicant Proposed Route continues east, following section lines 0.5 mile south of U.S. Route 412. Southeast of May, Oklahoma, the Applicant Proposed Route proceeds northeast and across U.S. Route 412, then continues east and then southeast through an 11-mile area dominated by wind energy farms north of the Cooper Wildlife Management Area (WMA). East of the Cooper WMA, the Applicant Proposed Route continues east along the Harper/Woodward County line to the eastern boundary of Region 1.

As shown on Figures 3-2a and 3-2b, portions of the Applicant Proposed Route are outside of the 1-mile-wide area of Links A-2, B-2, B-4, and B-8 of the Network of Potential Routes presented at scoping. The Routing Team sited the Applicant Proposed Route outside of the Network of Potential Routes to follow the newly constructed OG&E Hitchland-to-Woodward 345kV electrical transmission line. This transmission line had been proposed, but not constructed, at the time Clean Line developed the Network of Potential Routes.

- **Proposed Alternative Route 1-A** begins approximately 1 mile east of the proposed converter station siting area in Texas County at an intersection with the Applicant Proposed Route, and turns north for approximately 2 miles to parallel Southwestern Public Service Company's Finney-to-Hitchland 345kV electrical transmission line. It then turns east to follow section lines for approximately 5 miles before turning northeast along an abandoned railroad. Proposed Alternative Route 1-A turns east for approximately 16 miles to follow section lines 0.5 to 1 mile south of U.S. Route 412. The route then turns northeast for approximately 3 miles to parallel Southwestern Public Service Company's Guymon-to-Beaver 115kV electrical transmission line east, north, and then east for approximately 20 miles. At this point, the 115kV electrical transmission line turns north and Proposed Alternative Route 1-A continues east for approximately 63 miles through Beaver and Harper Counties, Oklahoma, paralleling county roads and section lines to the extent practicable. Proposed Alternative 1-A then turns southeast and intersects with the Applicant Proposed Route at the eastern boundary of Region 1, approximately 13 miles north of Woodward, near the intersection of the Harper/Woodward County line and S.R. 34. This Proposed Alternative Route provides a northern alternative through the Panhandle region in Texas, Beaver, and Harper Counties.

- **Proposed Alternative Route 1-B** begins approximately 1 mile east of the Texas County converter station site and follows the same alignment as Proposed Alternative Route 1-A (for approximately 5 miles) to where Proposed Alternative Route 1-A turns northeast along the abandoned railroad. At this point, Alternative Route 1-B continues east, following section lines for approximately 22 miles before turning northeast to parallel a pipeline ROW for approximately 6 miles. Proposed Alternative Route 1-B then turns east and follows section lines generally 0.5 mile south of U.S. Route 412 for 19 miles. Alternative Route 1-B intersects the Applicant Proposed Route where it turns east, south of U.S. Route 412 in Beaver County, Oklahoma.
- **Proposed Alternative Route 1-C** begins approximately 1 mile east of the Texas County converter station site and follows Proposed Alternative Route 1-A to where it turns northeast to cross U.S. Route 412. At this location, Proposed Alternative Route 1-C continues east and southeast for approximately 5 miles to follow section lines 0.5 mile south of U.S. Route 412 until it meets Proposed Alternative 1-B, which it follows to its termination at the Applicant Proposed Route.
- **Proposed Alternative Route 1-D** begins in Beaver County, Oklahoma, 0.5 mile south of where the Applicant Proposed Route turns east to follow U.S. Route 412. At this location, Proposed Alternative Route 1-D continues east for approximately 25 miles, following section lines generally 1.0 mile south of U.S. Route 412. The route then turns northeast and east to intersect the Applicant Proposed Route just east of the Beaver/Harper County lines in Harper County, Oklahoma.

The key Tier IV criteria for each route are presented below. Table 3-2 compares the Tier IV criteria of each Proposed Alternative Route to the corresponding portion of the Applicant Proposed Route and summarizes the Tier IV criteria for the Applicant Proposed Route in Region 1. Figures 3-2 through 3-7 identify the Tier IV criteria in Region 1.

3.3.3.1.1 Applicant Proposed Route

The Applicant Proposed Route is 115.89 miles in length, with 86.20 miles (74.4%) of the Applicant Proposed Route paralleling existing linear infrastructure. Land cover is dominated by agricultural and open lands (108.60 miles [93.7%]), with urban lands (6.51 miles [5.6%]) making up most of the remaining land cover.

The Applicant Proposed Route is within 1,000 feet of 16 residences, within 250 feet of two residences, and within 100 feet of one residence. No schools, churches, or hospitals are within 1,000 feet of the route.

The route traverses 57.64 miles (49.7%) of prime farmland soils.

In Region 1, the Applicant Proposed Route traverses the potential range of the lesser prairie-chicken. The Tier IV criteria assessed potential sensitivities using both the Oklahoma Department of Wildlife Conservation (ODWC) Oklahoma Lesser Prairie-Chicken Spatial Planning Tool (OLEPCSPT) (for Rankings 4-8) and the Western Governors Association (WGA) Southern Great Plains (SGP) Crucial Habitat Assessment Tool (CHAT) (for Rankings 1-3) data sets. Using the ODWC OLEPCSPT, this route traverses 75.73 miles (65.3%) of lands ranked 4 through 8, with 52.00 miles (44.9%) of this length being within existing impacted areas. Using the WGA SGP CHAT, 24.24 miles (20.9%) of the route traverse Rank 1, and 44.55 miles (38.4%) of the route traverse ranks 2 and 3. Of these WGA SGP CHAT totals, 21.75 mile (18.8%) of Rank 1 and 37.29 miles (32.2%) of Ranks 2 and 3 overlap with existing impacted areas. The route traverses 12.63 miles (10.9%) of lands with the potential to contain native prairie.

November 2013

The Applicant Proposed Route traverses three major waterbodies (Palo Duro Creek, Kiowa Creek, and Beaver River) and 10 other waterbodies in Region 1. The Applicant Proposed Route traverses 0.27 mile of National Wetlands Inventory (NWI)-identified forested wetlands and an additional 0.14 mile of NWI-identified non-forested wetlands. None of these crossings of NWI-identified wetlands are more than 1,000 feet in length. Additionally, 2.20 miles (1.9%) of the route traverse 100-year floodplain, with three crossings being more than 1,000 feet in length.

No National Register of Historic Places (NRHP) sites and two recorded cultural sites are within 0.25 mile of the Applicant Proposed Route.

3.3.3.1.2 Proposed Alternative Route 1-A

Proposed Alternative Route 1-A is 123.29 miles in length, with 32.36 miles (26.2%) paralleling existing linear infrastructure. Land cover is dominated by agricultural and open lands (114.40 miles [92.8%]), with urban lands (8.09 miles [6.6%]) making up most of the remaining land cover.

Proposed Alternative Route 1-A is within 1,000 feet of 22 residences and within 250 feet of one residence; no residences are within 100 feet of the route. No schools, churches, or hospitals are within 1,000 feet of the route.

The route traverses 33.07 miles (26.8%) of prime farmland soils.

Proposed Alternative Route 1-A traverses the potential range of the lesser prairie-chicken. The Tier IV criteria assessed potential sensitivities using both the ODWC OLEPCSPT (for Rankings 4-8) and the WGA SGP CHAT (for Rankings 1-3) data sets. Using the ODWC OLEPCSPT, this route traverses 95.79 miles (77.7%) of lands that are ranked 4 through 8, with 45.44 miles (36.9%) of this length being within existing impacted areas. Using the WGA SGP CHAT, 46.74 miles (37.9%) of the route traverse Rank 1 and 59.80 miles (48.5%) of the route traverse Ranks 2 and 3. Of these Ranks 1 through 3 totals, 28.84 mile (23.4%) of Rank 1 and 27.06 miles (21.9%) of Ranks 2 and 3 overlap with existing impacted areas. The route traverses 41.69 miles (33.8%) of lands with the potential to be native prairie.

Proposed Alternative Route 1-A traverses three major waterbodies (Palo Duro Creek, Kiowa Creek, and Beaver River) and six other waterbodies. The route also traverses 0.14 mile of NWI-identified forested wetlands and an additional 0.35 mile of NWI-identified non-forested wetlands. None of these crossings of NWI-identified wetlands are more than 1,000 feet in length. Additionally, 0.21 mile of the route traverses 100-year floodplain, with no crossing being more than 1,000 feet in length.

No NRHP sites and 35 recorded cultural sites are within 0.25 mile of Proposed Alternative Route 1-A.

Table 3-2 compares the Tier IV criteria of each Proposed Alternative Route to the corresponding portions of the Applicant Proposed Route and summarizes the Tier IV criteria for the Applicant Proposed Route in Region 1. In summary, Clean Line chose the Applicant Proposed Route rather than Proposed Alternative Route 1-A because the Applicant Proposed Route:

- Parallels more linear infrastructure;
- Has six fewer residences within 1,000 feet;
- Traverses less OLEPCSPT and CHAT potential lesser prairie-chicken habitat; and
- Is approximately 10 miles shorter in length.

3.3.3.1.3 Proposed Alternative Route 1-B

Proposed Alternative Route 1-B is 52.11 miles in length, with 8.14 miles (15.2%) paralleling existing linear infrastructure. Land cover is dominated by agricultural and open lands (48.02 miles [92.2%]), with urban lands (4.06 miles [7.8%]) making up most of the remaining land cover.

November 2013

Proposed Alternative Route 1-B is within 1,000 feet of nine residences and within 250 feet of one residence; no residences are within 100 feet of the route. No schools, churches, or hospitals within 1,000 feet of the route.

The route traverses 23.08 miles (44.3%) of prime farmland soils.

Proposed Alternative Route 1-B is within the potential range of the lesser prairie-chicken. The Tier IV criteria assessed potential sensitivities using both the ODWC OLEPCSPT (for Rankings 4-8) and the WGA SGP CHAT (for Rankings 1-3) data sets. Using the ODWC OLEPCSPT, this route traverses 27.60 miles (53.0%) of lands that are ranked 4 through 8, with 16.48 miles (31.6%) of this length being within existing impacted areas. Using the WGA SGP CHAT, 4.72 miles (9.1%) of the route traverse Rank 1 and 22.64 miles (43.4%) of the route traverse Ranks 2 and 3. Of these Ranks 1 through 3 totals, 1.72 miles (3.3%) of Rank 1 and 10.23 miles (19.8%) of Ranks 2 and 3 overlap with existing impacted areas. The route traverses 1.52 miles (2.9%) of lands with the potential to be native prairie.

Proposed Alternative Route 1-B traverses one major waterbody (Palo Duro Creek) and three other waterbodies. The route also traverses 0.05 mile of NWI-identified forested wetlands and an additional 0.02 mile of NWI-identified non-forested wetlands. None of these crossings of NWI-identified wetlands are more than 1,000 feet in length. Additionally, 0.22 mile of the route traverses 100-year floodplain, with no crossing being more than 1,000 feet in length.

No NRHP sites and six recorded cultural sites are within 0.25 mile of Proposed Alternative Route 1-B.

Table 3-2 compares the Tier IV criteria of each Proposed Alternative Route to the corresponding portions of the Applicant Proposed Route and summarizes the Tier IV criteria for the Applicant Proposed Route in Region 1. In summary, Clean Line chose the Applicant Proposed Route rather than Proposed Alternative Route 1-B because the Applicant Proposed Route:

- Parallels more linear infrastructure; and
- Traverses less OLEPCSPT and CHAT potential lesser prairie-chicken habitat.

3.3.3.1.4 Proposed Alternative Route 1-C

Proposed Alternative Route 1-C is 52.23 miles in length, with 7.42 miles (14.2%) paralleling existing linear infrastructure. Land cover is dominated by agricultural and open lands (48.52 miles [93.0%]), with urban lands (3.63 miles [7.0%]) making up most of the remaining land cover.

Proposed Alternative Route 1-C is within 1,000 feet of 18 residences and within 250 feet of one residence; no residences are within 100 feet of the route. No schools, churches, or hospitals are within 1,000 feet of the route.

The route traverses 27.95 miles (53.5%) of prime farmland soils.

Proposed Alternative Route 1-C is within the potential range of the lesser prairie-chicken. The Tier IV criteria assessed potential sensitivities using both the ODWC OLEPCSPT (for Rankings 4-8) and the WGA SGP CHAT (for Rankings 1-3) data sets. Using the ODWC OLEPCSPT, this route traverses 23.88 miles (45.7%) of lands that are ranked 4 through 8, with 9.67 miles (18.5%) of this length being within existing impacted areas. Using the WGA SGP CHAT, 4.72 miles (9.0%) of the route traverse Rank 1 and 27.24 miles (52.2%) of the route traverse Ranks 2 and 3. Of these Ranks 1 through 3 totals, 1.72 mile (3.3%) of Rank 1 and 10.74 miles (20.6%) of Ranks 2 and 3 overlap with existing impacted areas. The route traverses 5.18 miles (9.9%) of lands with the potential to be native prairie.

Proposed Alternative Route 1-C traverses one major waterbody (Palo Duro Creek) and two other waterbodies. The route traverses 0.13 mile of NWI-identified forested wetlands and an additional 0.07 mile of NWI-identified non-forested wetlands. None of these crossings of NWI-identified wetlands are

November 2013

more than 1,000 feet in length. Additionally, 0.21 mile of the route traverses 100-year floodplain, and one crossing is more than 1,000 feet in length.

No NRHP sites and two recorded cultural sites are within 0.25 mile of Proposed Alternative Route 1-C.

Table 3-2 compares the Tier IV criteria of each Proposed Alternative Route to the corresponding portions of the Applicant Proposed Route and summarizes the Tier IV criteria for the Applicant Proposed Route in Region 1. In summary, Clean Line chose the Applicant Proposed Route rather than Proposed Alternative Route 1-C because the Applicant Proposed Route:

- Parallels more linear infrastructure;
- Has 13 fewer residences within 1,000 feet; and
- Traverses less CHAT potential lesser prairie-chicken habitat.

3.3.3.1.5 Proposed Alternative Route 1-D

Proposed Alternative Route 1-D is 33.61 miles in length, with 12.56 miles (37.4%) paralleling existing linear infrastructure. Land cover is dominated by agricultural and open lands (29.88 miles [88.9%]) with urban lands (3.51 miles [10.4%]) making up most of the remaining land cover.

Proposed Alternative Route 1-D is within 1,000 feet of 12 residences and within 250 feet of six residences; no residences are within 100 feet of the route. No schools, churches, or hospitals are within 1,000 feet of the route.

The route traverses 13.49 miles (40.1%) of prime farmland soils.

Proposed Alternative Route 1-D is within the potential range of the lesser prairie-chicken. The Tier IV criteria assessed potential sensitivities using both the ODWC OLEPCSPT (for Rankings 4-8) and the WGA SGP CHAT (for Rankings 1-3) data sets. Using the ODWC OLEPCSPT, this route traverses 29.37 miles (87.4%) of lands that are ranked 4 through 8, with 20.63 miles (61.4%) of this length being within existing impacted areas. Using the WGA SGP CHAT, 13.34 miles (39.7%) of the route traverses Rank 1 and 20.27 miles (60.3%) of the route traverses Ranks 2 and 3. Of these Ranks 1 through 3 totals, 8.12 mile (24.2%) of Rank 1 and 13.97 miles (41.6%) of Ranks 2 and 3 overlap with existing impacted areas.

Proposed Alternative Route 1-D traverses one major waterbody (Kiowa Creek) and no other waterbodies. The route traverses 0.06 mile of NWI-identified forested wetlands. None of these crossings of NWI-identified wetlands are more than 1,000 feet in length.

No NRHP sites and two recorded cultural sites are within 0.25 mile of Proposed Alternative Route 1-D. Additionally, one cemetery is located within 500 feet of the route.

Table 3-2 compares the Tier IV criteria of each Proposed Alternative Route to the corresponding portions of the Applicant Proposed Route and summarizes the Tier IV criteria for the Applicant Proposed Route in Region 1. In summary, Clean Line chose the Applicant Proposed Route rather than Proposed Alternative Route 1-D because the Applicant Proposed Route:

- Parallels more linear infrastructure;
- Has nine fewer residences within 1,000 feet; and
- Traverses less OLEPCSPT and CHAT potential lesser prairie-chicken habitat.

Table 3 2
Region 1 Tier IV Criteria Comparison

Criterion	Unit	AR 1 A (123.29 miles)	Corresponding Links of APR (113.96 miles)	AR 1 B (52.11 miles)	Corresponding Links of APR (54.00 miles)	AR 1 C (52.23 miles)	Corresponding Links of APR (54.00 miles)	AR 1 D (33.61 miles)	Corresponding Links of APR (33.73 miles)	APR Total in Region 1 (115.89 miles)
Existing Infrastructure¹										
Electrical Transmission Lines (69 kilovolt [kV] and higher)	Miles	21.30	83.03	5.50	48.70	5.42	48.70	8.80	31.47	84.96
Transmission Pipelines	Miles	9.86	11.39	2.24	3.68	1.63	3.68	3.91	7.51	11.95
Railroads	Miles	0.00	0.00	0.00	0.00	0.00	0.00	0.00	0.00	0.00
Publically Maintained Federal, State, and County Roads	Miles	2.71	5.09	4.48	0.66	4.44	0.66	0.38	0.38	5.17
Total Paralleling Existing Linear Infrastructure	Miles	32.36	84.28	8.14	48.70	7.42	48.70	12.56	31.47	86.20
Land Cover										
Parcels and Parcel Boundaries	Number	268	159	139	16	140	16	58	82	163
Agriculture and Open Lands										
NLCD Pasture / Hay	Miles	0.00	0.00	0.00	0.00	0.00	0.00	0.00	0.00	0.00
NLCD Barren Land	Miles	0.05	0.00	0.00	0.00	0.00	0.00	0.00	0.00	0.00
NLCD Grassland / Herbaceous	Miles	97.60	70.95	39.20	25.09	38.65	25.09	23.68	27.18	72.67
NLCD Shrub / Scrub	Miles	5.26	5.24	3.72	3.68	3.47	3.68	1.55	1.33	5.39
NLCD Cultivated Crops	Miles	11.49	30.54	5.11	21.87	6.40	21.87	4.65	4.12	30.54
Total Agriculture and Open Lands	Miles	114.40	106.73	48.02	50.64	48.52	50.64	29.88	32.63	108.60
Forested Areas	Miles	0.20	0.00	0.00	0.00	0.00	0.00	0.00	0.00	0.00
Urban/Developed Areas	Miles	8.09	6.46	4.06	3.35	3.63	3.35	3.51	0.88	6.51
Structures										
K-12 Schools, Colleges and Universities										
0 - 100 ft	Number	0	0	0	0	0	0	0	0	0
100 - 250 ft	Number	0	0	0	0	0	0	0	0	0
250 - 500 ft	Number	0	0	0	0	0	0	0	0	0

Table 3 2
Region 1 Tier IV Criteria Comparison

Criterion	Unit	AR 1 A (123.29 miles)	Correspon ding Links of APR (113.96 miles)	AR 1 B (52.11 miles)	Correspon ding Links of APR (54.00 miles)	AR 1 C (52.23 miles)	Correspon ding Links of APR (54.00 miles)	AR 1 D (33.61 miles)	Correspon ding Links of APR (33.73 miles)	APR Total in Region 1 (115.89 miles)
500 - 1,000 ft	Number	0	0	0	0	0	0	0	0	0
Churches										
0 - 100 ft	Number	0	0	0	0	0	0	0	0	0
100 - 250 ft	Number	1	0	0	0	0	0	0	0	0
250 - 500 ft	Number	0	0	0	0	0	0	0	0	0
500 - 1,000 ft	Number	0	0	0	0	0	0	0	0	0
Hospitals										
0 - 100 ft	Number	0	0	0	0	0	0	0	0	0
100 - 250 ft	Number	0	0	0	0	0	0	0	0	0
250 - 500 ft	Number	0	0	0	0	0	0	0	0	0
500 - 1,000 ft	Number	0	0	0	0	0	0	0	0	0
Residences										
0 - 100 ft	Number	0	1	0	0	0	0	0	0	1
100 - 250 ft	Number	1	2	1	0	1	0	6	0	2
250 - 500 ft	Number	6	6	1	1	3	1	3	2	6
500 - 1,000 ft	Number	15	7	7	4	14	4	3	1	7
Agricultural, Commercial, and Industrial Structures										
0 - 100 ft	Number	17	1	1	0	9	0	3	1	1
100 - 250 ft	Number	10	8	4	1	5	1	3	4	8
250 - 500 ft	Number	36	23	21	7	14	7	6	9	23
500 - 1,000 ft	Number	120	39	46	7	50	7	23	17	41
Government Jurisdictions										
Cities and Towns	Miles	0.00	0.00	0.00	0.00	0.00	0.00	0.00	0.00	0.00

Table 3 2
Region 1 Tier IV Criteria Comparison

Criterion	Unit	AR 1 A (123.29 miles)	Correspon ding Links of APR (113.96 miles)	AR 1 B (52.11 miles)	Correspon ding Links of APR (54.00 miles)	AR 1 C (52.23 miles)	Correspon ding Links of APR (54.00 miles)	AR 1 D (33.61 miles)	Correspon ding Links of APR (33.73 miles)	APR Total in Region 1 (115.89 miles)
National Forests (U.S. Forest Service) - Administrative Boundary	Miles	0.00	0.00	0.00	0.00	0.00	0.00	0.00	0.00	0.00
National Forests (U.S. Forest Service) - Owned	Miles	0.00	0.00	0.00	0.00	0.00	0.00	0.00	0.00	0.00
National Wildlife Refuges (U.S. Fish and Wildlife Service)	Miles	0.00	0.00	0.00	0.00	0.00	0.00	0.00	0.00	0.00
National Parks (National Park Service)	Miles	0.00	0.00	0.00	0.00	0.00	0.00	0.00	0.00	0.00
U.S. Army Corps of Engineers (USACE) Lands	Miles	0.00	0.00	0.00	0.00	0.00	0.00	0.00	0.00	0.00
Defense (DOD) Lands	Miles	0.00	0.00	0.00	0.00	0.00	0.00	0.00	0.00	0.00
State Parks										
Oklahoma State Parks (Oklahoma Department of Tourism and Recreation Department)	Miles	0.00	0.00	0.00	0.00	0.00	0.00	0.00	0.00	0.00
Arkansas State Parks (Arkansas Department of Parks and Tourism)	Miles	0.00	0.00	0.00	0.00	0.00	0.00	0.00	0.00	0.00
Tennessee State Parks (Tennessee Department of Environment and Conservation, Division of Parks and Conservation, State Parks)	Miles	0.00	0.00	0.00	0.00	0.00	0.00	0.00	0.00	0.00
State Owned WMAs										
Oklahoma WMAs (Oklahoma Department of Wildlife Conservation)	Miles	0.00	0.00	0.00	0.00	0.00	0.00	0.00	0.00	0.00
Arkansas WMAs (Arkansas Game and Fish Commission)	Miles	0.00	0.00	0.00	0.00	0.00	0.00	0.00	0.00	0.00
Tennessee WMAs (Tennessee Wildlife Resources Agency)	Miles	0.00	0.00	0.00	0.00	0.00	0.00	0.00	0.00	0.00

Table 3 2
Region 1 Tier IV Criteria Comparison

Criterion	Unit	AR 1 A	Correspon	AR 1 B	Correspon	AR 1 C	Correspon	AR 1 D	Correspon	APR Total
		(123.29 miles)	ding Links of APR (113.96 miles)	(52.11 miles)	ding Links of APR (54.00 miles)	(52.23 miles)	ding Links of APR (54.00 miles)	(33.61 miles)	ding Links of APR (33.73 miles)	in Region 1 (115.89 miles)
Arkansas Leased WMAs (Arkansas Game and Fish Commission)	Miles	0.00	0.00	0.00	0.00	0.00	0.00	0.00	0.00	0.00
Oklahoma School Lands (The Commissioners of the Land Office)	Miles	0.00	0.00	0.00	0.00	0.00	0.00	0.00	0.00	0.00
Arkansas Natural Areas (Arkansas Natural Heritage Commission)	Miles	0.00	0.00	0.00	0.00	0.00	0.00	0.00	0.00	0.00
Tennessee Natural Areas (Tennessee Department of Environment and Conservation, Division of Natural Areas, Natural Areas Program)	Miles	0.00	0.00	0.00	0.00	0.00	0.00	0.00	0.00	0.00
County, City, and Town owned Lands that are managed for conservation or recreation	Miles	0.00	0.00	0.00	0.00	0.00	0.00	0.00	0.00	0.00
Tribal Trust Lands and Allotments	Miles	0.00	0.00	0.00	0.00	0.00	0.00	0.00	0.00	0.00
Conservation Easements or Areas										
Federal Conservation Easements	Miles	0.00	0.00	0.00	0.00	0.00	0.00	0.00	0.00	0.00
State Conservation Easements	Miles	0.00	0.00	0.00	0.00	0.00	0.00	0.00	0.00	0.00
The Nature Conservancy (TNC) Conservation Easements	Miles	0.00	0.00	0.00	0.00	0.00	0.00	0.00	0.00	0.00
Soil, Geologic, or Topographic Resources										
Prime Farmland	Miles	33.07	57.64	23.08	36.41	27.95	36.41	13.49	13.03	57.64
Farmlands of Statewide Importance	Miles	0.00	0.00	0.00	0.00	0.00	0.00	0.00	0.00	0.00
Slopes Greater than 20%	Miles	1.15	0.35	0.07	0.00	0.05	0.00	0.00	0.00	0.37
Karst Areas	Miles	10.02	26.41	17.96	26.41	9.92	26.41	0.00	0.00	0.00
Airport / Airfields										
Military Airports	Miles	0.00	0.00	0.00	0.00	0.00	0.00	0.00	0.00	0.00

Table 3 2
Region 1 Tier IV Criteria Comparison

Criterion	Unit	AR 1 A	Correspon	AR 1 B	Correspon	AR 1 C	Correspon	AR 1 D	Correspon	APR Total
		(123.29 miles)	ding Links of APR (113.96 miles)	(52.11 miles)	ding Links of APR (54.00 miles)	(52.23 miles)	ding Links of APR (54.00 miles)	(33.61 miles)	ding Links of APR (33.73 miles)	in Region 1 (115.89 miles)
FAA-Registered Public Airports	Number	0	0	0	0	0	0	0	0	0
FAA-Registered Private Airports	Number	0	0	0	0	0	0	0	0	0
Other Private Airstrips and Helipads	Number	0	0	0	0	0	0	0	0	0
Biological Resources										
USFWS-Designated Critical Habitat	Miles	0.00	0.00	0.00	0.00	0.00	0.00	0.00	0.00	0.00
Native Prairies	Miles	41.69	12.63	1.52	0.00	5.18	0.00	0.00	0.00	12.63
State Natural Heritage Program Species Location Data – Occurrence Records	Number	4	3,221	4	4	9	4	3,261	3,170	3,221
Arkansas Natural Heritage Program Species Location Data – Focal Areas	Miles	0.00	0.00	0.00	0.00	0.00	0.00	0.00	0.00	0.00
Arkansas Natural Heritage Program Species Location Data – Sensitive Streams	Number	0	0	0	0	0	0	0	0	0
Arkansas Natural Heritage Program Species Location Data – Designated Streams	Number	0	0	0	0	0	0	0	0	0
Lesser Prairie Chicken (LEPC) Potential Habitat: ODWC OLEPCSPT	Miles	95.79	74.12	27.60	23.32	23.88	23.32	29.37	29.36	75.73
LEPC Potential Habitat – WGA SGP CHAT - Rank 1	Miles	46.74	24.24	4.72	0.00	4.72	0.00	13.34	11.85	24.24
LEPC Potential Habitat – WGA SGP CHAT - Rank 2 and 3	Miles	59.80	44.55	22.64	8.82	27.24	8.82	20.27	21.88	44.55
Existing Impacted Areas within LEPC Habitat - CHAT Rank 1	Miles	28.84	21.75	1.72	0.00	1.72	0.00	8.12	11.85	21.75
Existing Impacted Areas within LEPC Habitat - CHAT Rank 2 – 3	Miles	27.06	37.29	10.23	7.74	10.74	7.74	13.97	21.88	37.29
Existing Impacted Areas within LEPC Habitat - OLEPCSPT Ranks 4 – 8	Miles	45.44	50.38	16.48	7.22	9.67	7.22	20.63	29.36	52.00

Table 3 2
Region 1 Tier IV Criteria Comparison

Criterion	Unit	AR 1 A (123.29 miles)		AR 1 B (52.11 miles)		AR 1 C (52.23 miles)		AR 1 D (33.61 miles)		APR Total in Region 1 (115.89 miles)	
		Corresponding Links of APR (113.96 miles)	Corresponding Links of APR (54.00 miles)	Corresponding Links of APR (54.00 miles)	Corresponding Links of APR (54.00 miles)	Corresponding Links of APR (54.00 miles)	Corresponding Links of APR (33.73 miles)	Corresponding Links of APR (33.73 miles)	Corresponding Links of APR (33.73 miles)	Corresponding Links of APR (33.73 miles)	
Greater Prairie Chicken (GRPC) Potential Habitat: ODWC Oklahoma Greater Prairie Chicken Spatial Planning Tool (OGRPCSTP)	Miles	0.00	0.00	0.00	0.00	0.00	0.00	0.00	0.00	0.00	0.00
Whooping Crane Migratory Stopover Locations	Miles	0.00	0.00	0.00	0.00	0.00	0.00	0.00	0.00	0.00	0.00
Ozark Big-Eared Bat Potential Occurrence Areas	Miles	0.00	0.00	0.00	0.00	0.00	0.00	0.00	0.00	0.00	0.00
Indiana Bat Potential Occurrence Areas	Miles	0.00	0.00	0.00	0.00	0.00	0.00	0.00	0.00	0.00	0.00
Gray Bat Potential Occurrence Areas	Miles	0.00	0.00	0.00	0.00	0.00	0.00	0.00	0.00	0.00	0.00
Known Bat Caves	Number	0	0	0	0	0	0	0	0	0	0
American Burying Beetle Potential Occurrence Areas	Miles	0.00	0.00	0.00	0.00	0.00	0.00	0.00	0.00	0.00	0.00
Water Resources											
NWI Forested Wetlands	Miles	0.14	0.27	0.05	0.06	0.13	0.06	0.06	0.06	0.02	0.27
NWI Nonforested Wetlands	Miles	0.35	0.14	0.02	0.12	0.07	0.12	0.12	0.00	0.01	0.14
NWI Forested Wetland Crossings >1,000 ft	Number	0	0	0	0	0	0	0	0	0	0
NWI Nonforested Wetland Crossings >1,000 ft	Number	0	0	0	0	0	0	0	0	0	0
NLCD Forested Wetlands	Miles	0.36	0.23	0.00	0.00	0.08	0.00	0.00	0.22	0.18	0.23
NLCD Nonforested Wetlands	Miles	0.00	0.00	0.00	0.00	0.00	0.00	0.00	0.00	0.00	0.00
NLCD Forested Wetland Crossings >1,000 ft	Number	0	0	0	0	0	0	0	0	0	0
NLCD Nonforested Wetland Crossings >1,000 ft	Number	0	0	0	0	0	0	0	0	0	0
Floodplains - Length Crossed	Miles	0.21	2.20	0.22	2.20	0.21	2.20	2.20	0.00	0.00	2.20

Table 3 2
Region 1 Tier IV Criteria Comparison

Criterion	Unit	AR 1 A (123.29 miles)	Correspon ding Links of APR (113.96 miles)	AR 1 B (52.11 miles)	Correspon ding Links of APR (54.00 miles)	AR 1 C (52.23 miles)	Correspon ding Links of APR (54.00 miles)	AR 1 D (33.61 miles)	Correspon ding Links of APR (33.73 miles)	APR Total in Region 1 (115.89 miles)
Floodplains - Crossings Greater than 1,000 ft	Number	0	3	0	3	1	3	0	0	3
Major Waterbodies and Reservoirs - Number Intersected	Number	1	3	1	1	1	1	1	1	3
Major Waterbodies and Reservoirs - Distance Crossed	Miles	0.03	0.06	0.01	0.01	0.01	0.01	0.01	0.01	0.06
State-Designated Waterbodies with Special Significance	Number	0	0	0	0	0	0	0	0	0
Other Waterbodies	Number	6	10	3	6	2	6	0	2	10
Springs 0 - 250 ft	Number	0	0	0	0	0	0	0	0	0
Springs 250 - 500 ft	Number	0	0	0	0	0	0	0	0	0
Wild and Scenic Rivers	Number	0	0	0	0	0	0	0	0	0
Visual / Cultural Resources										
Federally and State-Designated Scenic Routes, Trails, and Byways	Number	0	0	0	0	0	0	0	0	0
Sites on the National Register of Historic Places (NRHP)	Number	0	0	0	0	0	0	0	0	0
Recorded Cultural or Historical Sites										
Archeological Sites	Number	20	2	4	0	2	0	2	2	2
GLO Sites	Number	15	0	2	0	0	0	0	0	0
Historical Sites	Number	0	0	0	0	0	0	0	0	0
Total Recorded Cultural or Historical Sites	Number	35	2	6	0	2	0	2	2	2
Cemeteries	Number	0	0	0	0	0	0	1	0	0
Environmentally Regulated Sites										
Known Contaminated Sites	Number	0	0	0	0	0	0	0	0	0

Table 3 2
Region 1 Tier IV Criteria Comparison

Criterion	Unit	AR 1 A (123.29 miles)	Correspon ding Links of APR (113.96 miles)	AR 1 B (52.11 miles)	Correspon ding Links of APR (54.00 miles)	AR 1 C (52.23 miles)	Correspon ding Links of APR (54.00 miles)	AR 1 D (33.61 miles)	Correspon ding Links of APR (33.73 miles)	APR Total in Region 1 (115.89 miles)
Engineering Considerations										
Total Length of the Transmission Line	Miles	123.29	113.96	52.11	54.00	52.23	54.00	33.61	33.73	115.89
Electrical Transmission Line Crossings										
69kV - 345kV intersected by the representative centerline	Number	4	6	1	0	1	0	2	4	6
Greater than 345kV intersected by the representative centerline	Number	1	3	2	2	2	2	1	1	3
Transmission Pipeline Crossings	Number	22	16	8	7	8	7	8	8	18
Major Road Crossings	Number	5	4	1	1	1	1	1	1	4
Railroad ROW Crossings	Number	0	0	0	0	0	0	0	0	0

Notes:

¹ Miles of existing infrastructure are determined by measuring the length of the representative centerline intersection with a 500-foot buffer to each side of existing infrastructure. Crossings of existing infrastructure are included in this total and can add approximately 1,000 to 1,500 feet of length per crossing, depending on the angle of intersection. The Engineering Considerations section presents the number of crossings for each type of existing infrastructure. The Routing Team considered this additional length during the route identification process and Paired-Node Analyses.

Key:

- APR = Applicant Proposed Route.
- AR = Alternative Route.
- DOD = (United States) Department of Defense.
- FAA = Federal Aviation Administration.
- ft = feet.
- GLO = General Land Office.
- GRPC = greater prairie-chicken.
- kV = kilovolt(s).
- LEPC = lesser prairie-chicken.
- NLCD = National Land Cover Dataset.
- NRHP = National Register of Historic Places.

- NWI = National Wetlands Inventory.
- ODWC = Oklahoma Department of Wildlife Conservation.
- OGRPCST = Oklahoma Greater Prairie-Chicken Spatial Planning Tool.
- OLEPCST = Oklahoma Lesser Prairie-Chicken Spatial Planning Tool.
- ROW = right-of-way.
- SGP CHAT = Southern Great Plains Crucial Habitat Assessment Tool.
- TNC = The Nature Conservancy.
- USACE = United States Army Corps of Engineers.
- USFWS = United States Fish and Wildlife Service.
- WGA = Western Governors Association.
- WMA = Wildlife Management Area.

3.3.3.2 Region 2 (Oklahoma Central Great Plains)

Region 2 begins approximately 11 miles north of Woodward, Oklahoma, at the intersection of the Harper/Woodward County line and S.R. 34, continues southeastward through Woodward, Major, and Garfield Counties, Oklahoma, for a distance of approximately 106 miles, and terminates approximately 16 miles southeast of Enid, Oklahoma, near the Garfield/Kingfisher County line. Land cover in Region 2 generally includes forested areas dominated by cedar; agricultural lands consisting of pasture and cultivated crops; and rural residential developed areas. Towns near the routes in this Region include Moreland, Fairview, Cleo Springs, Isabella, Ames, and Bison, Oklahoma.

Clean Line identified the Applicant Proposed Route and two Proposed Alternative Routes in Region 2. The locations of these routes are summarized below and illustrated on Figures 3-2c through 3-2f.

- **The Applicant Proposed Route** begins at the western boundary of Region 2 and extends southeast through Woodward County for approximately 20 miles, traversing between Mooreland, Oklahoma, and Boiling Springs State Park. From there, the Applicant Proposed Route parallels Western Farmers Electric Cooperative's existing 115kV electrical transmission line for approximately 33 miles in Woodward and Major Counties, Oklahoma. The route then diverges from this transmission line and turns east to parallel U.S. Route 60 for approximately 4 miles. The Applicant Proposed Route continues east along section lines and parcel boundaries, to the extent practicable, for approximately 20 miles. Southeast of Fairview, Oklahoma, the route crosses the Cimarron River, at the County Road E0550 crossing of the Cimarron River. After the Cimarron River crossing, the Applicant Proposed Route turns southeast and then south, following parcel boundaries for approximately 4 miles before turning east to parallel county roads, section lines, and parcel boundaries, to the extent practicable, for approximately 28 miles before terminating northwest of the Kingfisher-Logan County line in Garfield County, Oklahoma.

As shown on Figure 3-2f, a portion of the Applicant Proposed Route is outside the 1-mile-wide area of Link D-2 of the Network of Potential Routes presented at scoping. The Routing Team sited the Applicant Proposed Route outside of the Network of Potential Routes in this area to avoid several center-pivot irrigation systems that were identified during scoping. The Routing Team subsequently confirmed the presence and location of these structures during the aerial reconnaissance.

- **Proposed Alternative Route 2-A** begins at the intersection of the Western Farmers Electric Cooperative 115kV electrical transmission line (which the Applicant Proposed Route parallels) and OG&E's Woodward-to-Cleo's Corner 155kV electrical transmission line. The route generally parallels the OG&E's Woodward-to-Cleo's Corner 155kV electrical transmission line east for approximately 42 miles. At Gloss Mountain State Park, this alternative route diverges north, away from the transmission line to go around the state park. East of Gloss Mountain State Park, Proposed Alternative Route 2-A continues east and crosses the Cimarron River south of U.S. Highway 412. Proposed Alternative Route 2-A then turns south and southeast, running next to the Cimarron River floodplain for approximately 15 miles before terminating at an intersection with the Applicant Proposed Route. Proposed Alternative Route 2-A provides a northern alternative through Major County, Oklahoma, as well as an alternative crossing of the Cimarron River.
- **Proposed Alternative Route 2-B** begins at the eastern end of Proposed Alternative Route 2-A and traverses east along section lines and parcel boundaries for approximately 20 miles in Major and Garfield Counties, Oklahoma. The route then turns southeast for 2 miles, east for 3 miles (along parcel and section lines), southeast for less than 1 mile, east for 2 miles (along parcel and half-section lines), and then parallels OG&E's Cottonwood Creek-to-Enid 138kV

electrical transmission line southeast for approximately 2 miles. The route then terminates at its intersection with the Applicant Proposed Route at the eastern boundary of Region 2. Proposed Alternative Route 2-B provides a northern alternative through Garfield County, Oklahoma.

As shown on Figure 3-2f, a portion of Proposed Alternative Route 2-B is outside of the 1-mile-wide area of Link D-1 of the Network of Potential Routes presented at scoping. The Routing Team sited the Proposed Alternative Route 2-B outside of the Network of Potential Routes in this area to avoid a private airstrip identified through review of aerial imagery and the aerial reconnaissance.

There is a single route alternative in the western portion of Region 2 because of the city of Woodward, the city of Moreland, potentially high value lesser prairie-chicken habitat, and rough terrain limit potential opportunities for transmission line siting.

The key Tier IV criteria for each route are presented below. Table 3-3 compares the Tier IV criteria for each Proposed Alternative Route with the corresponding portion of the Applicant Proposed Route and summarizes the Tier IV criteria for the Applicant Proposed Route in Region 2. Figures 3-2 through 3-7 identify the Tier IV criteria in Region 2.

3.3.3.2.1 Applicant Proposed Route

The Applicant Proposed Route is 106.22 miles in length, with 49.11 miles (46.2%) of the Applicant Proposed Route paralleling existing linear infrastructure. Land cover is dominated by agricultural and open lands (88.68 miles [83.5%]), with forested lands (11.75 miles [11.1%]) and urban lands (5.57 miles [5.2%]) making up most of the remaining land cover.

The Applicant Proposed Route is within 1,000 feet of 60 residences; with three residences within 250 feet. No schools, churches, or hospitals are within 1,000 feet of the route. Additionally, the route traverses 0.49 mile (0.4%) of Oklahoma School Lands.

The Applicant Proposed Route traverses 24.33 miles (22.9%) of lands with prime farmland soils.

The Applicant Proposed Route intersects United States Fish and Wildlife Service (USFWS)-designated critical habitat for the Arkansas River shiner at the Cimarron River. The Applicant Proposed Route in Region 2 is within the potential range of the lesser prairie-chicken. The Tier IV criteria assessed potential sensitivities using both the ODWC OLEPCSPT (for Rankings 4-8) and WGA SGP CHAT (for Rankings 1-3) data sets. Using the ODWC OLEPCSPT, this route traverses 21.57 miles (20.3%) of lands that are ranked 4 through 8; 8.47 miles (8.0%) of this length is in existing impacted areas. Using the WGA SGP CHAT, 2.23 miles (2.1%) of the route traverse Rank 1 land and 14.58 miles (13.7%) traverse Ranks 2 and 3 lands; 0.54 mile (0.5%) in Rank 1 and 3.78 miles (3.6%) in Ranks 2 and 3 overlap existing impacted areas. The route also traverses 14.17 miles (13.3%) of lands with the potential to be native prairie.

The Applicant Proposed Route crosses two major waterbodies (Cimarron River and Turkey Creek) and three other waterbodies in Region 2. The Applicant Proposed Route traverses 0.13 mile of NWI-identified forested wetlands and 0.15 mile of NWI-identified non-forested wetlands. None of these NWI-identified wetland crossings are more than 1,000 feet in length. Additionally, 6.40 miles of the route traverse a 100-year floodplain, with eight crossings more than 1,000 feet in width.

No NRHP sites and two recorded cultural sites are within 0.25 mile of the Applicant Proposed Route.

3.3.3.2.2 Proposed Alternative Route 2-A

Proposed Alternative Route 2-A is 57.33 miles in length with 35.79 miles (62.4%) paralleling existing linear infrastructure. Land cover is dominated by agricultural and open lands (47.73 miles [83.3%]), with

forested lands (6.31 miles [11.0%]) and urban lands (3.05 miles [5.3%]) making up most of the remaining land cover.

Proposed Alternative Route 2-A is within 1,000 feet of 12 residences; no residences are within 250 feet. No schools, churches, or hospitals are within 1,000 feet of the route.

Proposed Alternative Route 2-A traverses 13.82 miles (24.1%) of lands with prime farmland soils.

Proposed Alternative Route 2-A intersects USFWS-designated critical habitat for the Arkansas River shiner at the Cimarron River. Proposed Alternative Route 2-A is within the potential range of the lesser prairie-chicken. The Tier IV criteria assessed potential sensitivities using both the ODWC OLEPCSPT (for Rankings 4-8) and the WGA SGP CHAT (for Rankings 1-3) data sets. Using the ODWC OLEPCSPT, this route traverses 8.08 miles (14.1%) of lands ranked 4 through 8 and that 5.82 miles (10.2%) of the 8.08 miles are in existing impacted areas. Using the WGA SGP CHAT, no Rank 1 lands are traversed by this route, but 3.96 miles (6.9%) of the route traverse Ranks 2 and 3; the entirety of these 3.96 miles in Ranks 2 and 3 lands are in existing impacted areas. Proposed Alternative Route 2-A traverses 23.86 miles (41.6%) of lands with the potential to be native prairie.

Proposed Route 2-A crosses one major waterbody (Cimarron River) and seven other waterbodies. NWI-identified forested wetlands are traversed by 0.12 mile of Proposed Alternative Route 2-A, with an additional 0.01 mile being NWI-identified non-forested wetlands. None of these NWI-identified wetland crossings are more than 1,000 feet in length. Additionally, the route traverses 0.19 mile of 100-year floodplain with none of the crossings being more than 1,000 feet in width.

No NRHP sites and six recorded cultural sites are within 0.25 mile of Proposed Alternative Route 2-A.

Table 3-3 compares the Tier IV criteria of each Proposed Alternative Route with the corresponding portions of the Applicant Proposed Route and summarizes the Tier IV criteria for the Applicant Proposed Route in Region 2. In summary, Clean Line chose the Applicant Proposed Route rather than Proposed Alternative Route 2-A because the Applicant Proposed Route:

- Avoids the proximity of Gloss Mountain State Park;
- Traverses less ODWC OLEPCSPT Ranks 4 through 8 lands; and
- Traverses fewer NWI-identified forested wetlands and waterbodies.

3.3.3.2.3 Proposed Alternative Route 2-B

Proposed Alternative Route 2-B is 29.86 miles in length with 9.52 miles (31.9%) paralleling existing linear infrastructure. Land cover is dominated by agricultural and open lands (27.90 miles or 93.4%) with forested lands (0.80 miles [2.7%]) and urban lands (0.88 miles [2.7%]) making up most of the remaining land cover.

Proposed Alternative Route 2-B is within 1,000 feet of five residences; no residences are within 250 feet. No schools, churches, or hospitals are within 1,000 feet of the route.

Proposed Alternative Route 2-B traverses 15.14 miles (50.7%) of lands with prime farmland soils.

Proposed Alternative Route 2-B traverses 4.60 miles (15.4%) of lands with the potential to be native prairie. Proposed Alternative Route 2-B crosses one major waterbody, Turkey Creek, and three other waterbodies. NWI-identified forested wetlands are traversed by 0.02 mile of Proposed Alternative Route 2-B, with an additional 0.28 mile being NW- identified non-forested wetlands. None of these NWI-identified wetland crossings are more than 1,000 feet in length. The route also traverses 3.42 miles of 100-year floodplains, but five crossings more than 1,000 feet in width.

No NRHP sites or recorded cultural sites are within 0.25 mile of Proposed Alternative Route 2-B.

November 2013

Table 3-3 compares the Tier IV criteria of each Proposed Alternative Route with the corresponding portions of the Applicant Proposed Route and summarizes the Tier IV criteria for the Applicant Proposed Route in Region 2. In summary, Clean Line chose the Applicant Proposed Route rather than Proposed Alternative Route 2-B, because the Applicant Proposed Route:

- Traverses fewer NWI-identified non-forested wetlands; and
- Traverses fewer floodplains.

In addition, review of aerial imagery, parcel maps, and aerial reconnaissance showed that the Applicant Proposed Route follows more section lines, field lines, and mapped parcel lines than Proposed Alternative Route 2-B.

Table 3.3
Region 2 Tier IV Criteria Comparison

Criterion	Unit	AR 2 A (57.33 miles)	Corresponding Links of APR (54.63 miles)	AR 2 B (29.86 miles)	Corresponding Links of APR (31.34 miles)	APR Total in Region 2 (106.22 miles)
Existing Infrastructure¹						
Electrical Transmission Lines (69 kV and higher)	Miles	35.15	30.79	2.24	0.45	34.17
Transmission Pipelines	Miles	1.04	1.17	6.64	1.11	13.43
Railroads	Miles	0.00	0.00	0.42	0.39	0.59
Publically Maintained Federal, State, and County Roads	Miles	3.25	3.05	0.39	0.39	4.31
Total Paralleling Existing Linear Infrastructure	Miles	35.79	33.10	9.52	2.04	49.11
Land Cover						
Parcels and Parcel Boundaries	Number	141	150	87	72	281
Agriculture and Open Lands						
NLCD Pasture / Hay	Miles	0.11	0.00	0.00	0.00	0.00
NLCD Barren Land	Miles	0.04	0.00	0.00	0.00	0.00
NLCD Grassland / Herbaceous	Miles	34.28	24.02	9.66	12.37	53.63
NLCD Shrub / Scrub	Miles	0.55	0.38	0.00	0.00	0.43
NLCD Cultivated Crops	Miles	12.74	17.15	18.23	15.54	34.63
Total Agriculture and Open Lands	Miles	47.73	41.55	27.90	27.91	88.68
Forested Areas	Miles	6.31	10.86	0.80	0.67	11.75
Urban/Developed Areas	Miles	3.05	2.00	0.88	2.77	5.57
Structures						
K-12 Schools, Colleges and Universities						
0-100 ft	Number	0	0	0	0	0
100-250 ft	Number	0	0	0	0	0
250-500 ft	Number	0	0	0	0	0
500-1,000 ft	Number	0	0	0	0	0
Churches						
0-100 ft	Number	0	0	0	0	0
100-250 ft	Number	0	0	0	0	0
250-500 ft	Number	0	0	0	0	0
500-1,000 ft	Number	0	0	0	0	0

Table 3.3
Region 2 Tier IV Criteria Comparison

Criterion	Unit	AR 2 A (57.33 miles)	Corresponding Links of APR (54.63 miles)	AR 2 B (29.86 miles)	Corresponding Links of APR (31.34 miles)	APR Total in Region 2 (106.22 miles)
Hospitals						
0-100 ft	Number	0	0	0	0	0
100-250 ft	Number	0	0	0	0	0
250-500 ft	Number	0	0	0	0	0
500-1,000 ft	Number	0	0	0	0	0
Residences						
0-100 ft	Number	0	0	0	0	0
100-250 ft	Number	0	2	0	1	3
250-500 ft	Number	3	8	3	9	17
500-1,000 ft	Number	9	33	2	0	40
Agricultural, Commercial, and Industrial Structures						
0-100 ft	Number	5	2	2	2	4
100-250 ft	Number	10	4	6	6	10
250-500 ft	Number	16	19	16	19	41
500-1,000 ft	Number	61	44	24	24	77
Government Jurisdictions						
Cities and Towns	Miles	0.00	0.00	0.00	0.00	0.00
National Forests (U.S. Forest Service) - Administrative Boundary	Miles	0.00	0.00	0.00	0.00	0.00
National Forests (U.S. Forest Service) - Owned	Miles	0.00	0.00	0.00	0.00	0.00
National Wildlife Refuges (USFWS)	Miles	0.00	0.00	0.00	0.00	0.00
National Parks (National Park Service)	Miles	0.00	0.00	0.00	0.00	0.00
USACE Lands	Miles	0.00	0.00	0.00	0.00	0.00
DOD Lands	Miles	0.00	0.00	0.00	0.00	0.00

Table 3 3
Region 2 Tier IV Criteria Comparison

Criterion	Unit	AR 2 A (57.33 miles)	Corresponding Links of APR (54.63 miles)	AR 2 B (29.86 miles)	Corresponding Links of APR (31.34 miles)	APR Total in Region 2 (106.22 miles)
State Parks						
Oklahoma State Parks (Oklahoma Tourism and Recreation Department)	Miles	0.00	0.00	0.00	0.00	0.00
Arkansas State Parks (Arkansas Department of Parks and Tourism)	Miles	0.00	0.00	0.00	0.00	0.00
Tennessee State Parks (Tennessee Department of Environment and Conservation, Division of Parks and Conservation, State Parks)	Miles	0.00	0.00	0.00	0.00	0.00
State-Owned WMAs						
Oklahoma WMAs (Oklahoma Department of Wildlife Conservation)	Miles	0.00	0.00	0.00	0.00	0.00
Arkansas WMAs (Arkansas Game and Fish Commission)	Miles	0.00	0.00	0.00	0.00	0.00
Tennessee WMAs (Tennessee Wildlife Resources Agency)	Miles	0.00	0.00	0.00	0.00	0.00
Arkansas Leased WMAs (Arkansas Game and Fish Commission)	Miles	0.00	0.00	0.00	0.00	0.00
Oklahoma School Lands (The Commissioners of the Land Office)	Miles	0.00	0.00	0.00	0.49	0.49
Arkansas Natural Areas (Arkansas Natural Heritage Commission)	Miles	0.00	0.00	0.00	0.00	0.00
Tennessee Natural Areas (Tennessee Department of Environment and Conservation, Division of Natural Areas, Natural Areas Program)	Miles	0.00	0.00	0.00	0.00	0.00
County-, City-, and Town-owned Lands that are managed for conservation or recreation	Miles	0.00	0.00	0.00	0.00	0.00
Tribal Trust Lands and Allotments	Miles	0.00	0.00	0.00	0.00	0.00
Conservation Easements or Areas						
Federal Conservation Easements	Miles	0.00	0.00	0.00	0.00	0.00
State Conservation Easements	Miles	0.00	0.00	0.00	0.00	0.00
TNC Conservation Easements	Miles	0.00	0.00	0.00	0.00	0.00

Table 3 3
Region 2 Tier IV Criteria Comparison

Criterion	Unit	AR 2 A (57.33 miles)	Corresponding Links of APR (54.63 miles)	AR 2 B (29.86 miles)	Corresponding Links of APR (31.34 miles)	APR Total in Region 2 (106.22 miles)
Soil, Geologic, or Topographic Resources						
Prime Farmland	Miles	13.82	10.75	15.14	12.33	24.33
Farmlands of Statewide Importance	Miles	0.00	0.00	0.00	0.00	0.00
Slopes Greater than 20%	Miles	1.10	1.39	0.00	0.00	1.39
Karst Areas	Miles	12.75	7.77	0.00	0.00	0.00
Airport / Airfields						
Military Airports	Miles	0.00	0.00	0.00	0.00	0.00
FAA-Registered Public Airports	Number	0	0	0	0	0
FAA-Registered Private Airports	Number	0	0	1	0	0
Other Private Airstrips and Helipads	Number	0	0	0	0	0
Biological Resources						
USFWS-Designated Critical Habitat	Miles	0.04	0.05	0.00	0.00	0.05
Native Prairies	Miles	23.86	3.67	4.60	10.50	14.17
State Natural Heritage Program Species Location Data – Occurrence Records	Number	8	3	0	1	47
Arkansas Natural Heritage Program Species Location Data – Focal Areas	Miles	0.00	0.00	0.00	0.00	0.00
Arkansas Natural Heritage Program Species Location Data – Sensitive Streams	Number	0	0	0	0	0
Arkansas Natural Heritage Program Species Location Data – Designated Streams	Number	0	0	0	0	0
LEPC Potential Habitat: ODWC OLEPCSPT	Miles	8.08	7.42	0.00	1.84	21.57
LEPC Potential Habitat –WGA SGP CHAT - Rank 1	Miles	0.00	0.00	0.00	0.00	2.23
LEPC Potential Habitat –WGA SGP CHAT - Rank 2 and 3	Miles	3.96	0.76	0.00	0.00	14.58
Existing Impacted Areas within LEPC Habitat - CHAT Rank 1	Miles	0.00	0.00	0.00	0.00	0.54
Existing Impacted Areas within LEPC Habitat - CHAT Rank 2 and 3	Miles	3.96	0.76	0.00	0.00	3.78
Existing Impacted Areas within LEPC Habitat - OLEPCSPT Ranks 4–8	Miles	5.82	5.59	0.00	0.84	8.47

Table 3 3
Region 2 Tier IV Criteria Comparison

Criterion	Unit	AR 2 A (57.33 miles)	Corresponding Links of APR (54.63 miles)	AR 2 B (29.86 miles)	Corresponding Links of APR (31.34 miles)	APR Total in Region 2 (106.22 miles)
GRPC Potential Habitat: ODWC OGRPCSPT	Miles	0.00	0.00	0.00	0.00	0.00
Whooping Crane Migratory Stopover Locations	Miles	0.00	0.00	0.00	0.00	0.00
Ozark Big-Eared Bat Potential Occurrence Areas	Miles	0.00	0.00	0.00	0.00	0.00
Indiana Bat Potential Occurrence Areas	Miles	0.00	0.00	0.00	0.00	0.00
Gray Bat Potential Occurrence Areas	Miles	0.00	0.00	0.00	0.00	0.00
Known Bat Caves	Number	0	0	0	0	0
American Burying Beetle Potential Occurrence Areas	Miles	0.00	0.00	0.00	0.00	0.00
Water Resources						
NWI Forested Wetlands	Miles	0.12	0.07	0.02	0.07	0.13
NWI Non-forested Wetlands	Miles	0.01	0.07	0.28	0.07	0.15
NWI Forested Wetland Crossings > 1,000 ft	Number	0	0	0	0	0
NWI Non-forested Wetland Crossings > 1,000 ft	Number	0	0	0	0	0
NLCD Forested Wetlands	Miles	0.00	0.00	0.00	0.00	0.00
NLCD Non-forested Wetlands	Miles	0.00	0.00	0.00	0.00	0.00
NLCD Forested Wetland Crossings > 1,000 ft	Number	0	0	0	0	0
NLCD Non-forested Wetland Crossings > 1,000 ft	Number	0	0	0	0	0
Floodplains - Length Crossed	Miles	0.19	0.00	3.42	2.63	6.40
Floodplains - Crossings Greater than 1,000 ft	Number	0	0	5	5	8
Major Waterbodies and Reservoirs - Number Intersected	Number	1	1	1	1	2
Major Waterbodies and Reservoirs - Distance Crossed	Miles	0.09	0.13	0.01	0.01	0.14
State-Designated Waterbodies with Special Significance	Number	0	0	0	0	0
Other Waterbodies	Number	7	1	3	2	3
Springs 0-250 ft	Number	0	0	0	0	0
Springs 250-500 ft	Number	0	0	0	0	0
Wild and Scenic Rivers	Number	0	0	0	0	0

Table 3.3
Region 2 Tier IV Criteria Comparison

Criterion	Unit	AR 2 A (57.33 miles)	Corresponding Links of APR (54.63 miles)	AR 2 B (29.86 miles)	Corresponding Links of APR (31.34 miles)	APR Total in Region 2 (106.22 miles)
Visual / Cultural Resources						
Federally and State-Designated Scenic Routes, Trails, and Byways	Number	0	0	0	0	0
Sites on the NRHP	Number	0	0	0	0	0
Recorded Cultural or Historical Sites						
Archaeological Sites	Number	5	2	0	0	2
GLO Sites	Number	0	0	0	0	0
Historical Sites	Number	1	0	0	0	0
Total Recorded Cultural or Historical Sites	Number	6	2	0	0	2
Cemeteries	Number	0	0	0	1	1
Environmentally Regulated Sites						
Known Contaminated Sites	Number	0	0	0	0	0
Engineering Considerations						
Total Length of the Transmission Line	Miles	57.33	54.63	29.86	31.34	106.22
Electrical Transmission Line Crossings						
69kV-345kV intersected by the representative centerline	Number	3	2	1	1	7
Greater than 345kV intersected by the representative centerline	Number	0	0	1	1	1
Transmission Pipeline Crossings	Number	4	6	9	5	15
Major Road Crossings	Number	3	2	2	2	6
Railroad ROW Crossings	Number	0	0	1	1	2
Notes:						
<p>1 Miles of existing infrastructure are determined by measuring the length of the representative centerline intersection with a 500-foot buffer to each side of existing infrastructure. Crossings of existing infrastructure are included in this total and can add approximately 1,000 to 1,500 feet of length per crossing, depending on the angle of intersection. The Engineering Considerations section presents the number of crossings for each type of existing infrastructure. The Routing Team considered this additional length during the route identification process and Paired-Node Analyses.</p>						

Table 3 3
Region 2 Tier IV Criteria Comparison

Criterion	Unit	AR 2 A (57.33 miles)	Corresponding Links of APR (54.63 miles)	AR 2 B (29.86 miles)	Corresponding Links of APR (31.34 miles)	APR Total in Region 2 (106.22 miles)
-----------	------	-------------------------	--	-------------------------	--	--

Key:

- APR = Applicant Proposed Route.
- AR = Alternative Route.
- DOD = (United States) Department of Defense.
- FAA = Federal Aviation Administration.
- ft = feet.
- GLO = General Land Office.
- GRPC = greater prairie-chicken.
- kV = kilovolt(s).
- LEPC = lesser prairie-chicken.
- NLCD = National Land Cover Dataset.
- NRHP = National Register of Historic Places.

- NWI = National Wetlands Inventory.
- ODWC = Oklahoma Department of Wildlife Conservation.
- OGRPCSPT = Oklahoma Greater Prairie-Chicken Spatial Planning Tool.
- OLEPCSPT = Oklahoma Lesser Prairie-Chicken Spatial Planning Tool.
- ROW = right-of-way.
- SGP CHAT = Southern Great Plains Crucial Habitat Assessment Tool.
- TNC = The Nature Conservancy.
- USACE = United States Army Corps of Engineers.
- USFWS = United States Fish and Wildlife Service.
- WGA = Western Governors Association.
- WMA = Wildlife Management Area.

3.3.3.3 Region 3 (Oklahoma Cross Timbers)

Region 3 begins approximately 21 miles southeast of Enid, Oklahoma, near the intersection of the Kingfisher/Logan/Garfield County lines, continues southeastward through Garfield, Kingfisher, Logan, Payne, Lincoln, Creek, Okmulgee, and Muskogee Counties for a distance of approximately 162 miles, and terminates north of Webbers Falls, Oklahoma, at the Arkansas River. Land cover in Region 3 generally includes forested areas consisting of both cedar and mixed hardwoods; agricultural lands consisting of pasture and cultivated crops; and residential and commercial developed areas. From Stillwater to the eastern boundary of Region 3, residential development increases (as compared with the western third of this region), particularly near Stillwater, Cushing, Drumright, Depew, Bristow, Winchester, Beggs, Muskogee, and Webbers Falls, Oklahoma. Towns near the routes in this Region include Marshall, Orlando, Mulhall, Perkins, Ripley, Cushing, Shamrock, Winchester, Beggs, Summit, Oktaha, and Webbers Falls, Oklahoma.

Clean Line identified the Applicant Proposed Route and five Proposed Alternative Routes in Region 3. The locations of these routes are summarized below and illustrated on Figures 3-2f through 3-2i.

- **The Applicant Proposed Route** begins at the OG&E's Cottonwood Creek-to-Enid 138kV electrical transmission line, which it parallels to the southeast for approximately 11 miles before turning east. The route then runs for approximately 39 miles through Logan and Payne Counties, following various features such as section lines, County Road (CR) 67, and the KAMO Electric Cooperative, Inc. Stillwater-to-Ramsey 115kV electrical transmission line. The route then turns southeast to parallel the KAMO Electric Cooperative, Inc. Stillwater-to-Cushing 69kV electrical transmission line for approximately 12 miles in Payne and Lincoln Counties to Cushing, Oklahoma. South of Cushing, the Applicant Proposed Route diverges from the 69kV electrical transmission line and turns east for approximately 23 miles into Creek County, following sections lines, parcel boundaries, county roads, and pipelines. North of Bristow, the Applicant Proposed Route turns southeast for approximately 10 miles before turning east to parallel OG&E's Beggs-to-Pecan Creek 138kV electrical transmission line. The Applicant Proposed Route generally follows this electrical transmission line southeast, east, and southeast for 66 miles to the west side of the Arkansas River, approximately 0.6 mile north of Webbers Falls in Muskogee County, which is also the eastern boundary of Region 3.

As shown on Figure 3-2i, portions of the Applicant Proposed Route are outside the 1-mile-wide area of Link F-7 of the Network of Potential Routes presented at scoping. The Routing Team sited the Applicant Proposed Route outside of the Network of Potential Routes in response to scoping comments that identified additional residential areas and residences in Link F-7 that Clean Line subsequently located via additional desktop evaluation and the aerial reconnaissance.

- **Proposed Alternative Route 3-A** begins at an intersection with the Applicant Proposed Route at the western boundary of Region 3 west of Marshall in Garfield County, Oklahoma. Proposed Alternative Route 3-A then continues in an east and southeast direction, following county roads and parcel boundaries to the extent practicable through Garfield, Logan, and Payne Counties for approximately 37 miles before intersecting with the Applicant Proposed Route south of Stillwater (at a location where the Applicant Proposed Route begins to parallel the KAMO Electric Cooperative, Inc. Stillwater-to-Ramsey 115kV electrical transmission line). Proposed Alternative Route 3-A provides an alternative route in an area of residential development south of Stillwater, Oklahoma.
- **Proposed Alternative Route 3-B** begins at the same location as Proposed Alternative Route 3-A and follows the same path until a point approximately 1 mile northwest of where Proposed Alternative Route 3-A terminates at the Applicant Proposed Route. At this point, Proposed Alternative Route 3-B generally traverses east, following section lines and parcel boundaries to

the extent practicable, through Payne County for approximately 10 miles. At this point, the route intersects the KAMO Electric Cooperative, Inc. Stillwater-to-Cushing 69kV electrical transmission line, which the route then parallels for approximately 2 miles. This alternative terminates at the Applicant Proposed Route approximately 1 mile northwest of Ripley. Similar to Proposed Alternative 3-A, Proposed Alternative Route 3-B provides an alternative route in an area of residential development south of Stillwater, Oklahoma.

- **Proposed Alternative Route 3-C** begins at an intersection with the Applicant Proposed Route south of Stillwater and traverses southeast through Payne and Lincoln Counties, Oklahoma, for approximately 12 miles before turning east to parallel property lines and section lines for approximately 7 miles. South of Cushing, the route turns southeast for approximately 12 miles to parallel OG&E's Cushing-to-Bristow 138kV electrical transmission line. The route diverges from the transmission line south of Shamrock and continues in a southeast and east direction for approximately 53 miles following roads, section lines, and property boundaries, to the extent practicable. Northwest of Boynton, the route turns due south for approximately 8 miles then due east for approximately 8 miles along section lines. The route then continues southeast and east for approximately 23 miles, following section lines and parcel boundaries to the extent practicable, before terminating at the Applicant Proposed Route west of the Arkansas River. This Proposed Alternative Route includes an alternative crossing of the Cimarron River and a southern alternative to the Applicant Proposed Route through Region 3 east of the Cimarron River. This route also provides an alternative crossing approach for the Arkansas River.

As shown on Figure 3-2i, portions of Proposed Alternative Route 3-C are outside the 1-mile-wide area of Link F-8 of the Network of Potential Routes presented at scoping. The Routing Team sited Proposed Alternative Route 3-C outside of the Network of Potential Routes in response to comments by the ODWC regarding the presence of federal grassland conservation easements and potential high value greater prairie-chicken habitat along Link F-8.

- **Proposed Alternative Route 3-D** begins at an intersection with the Applicant Proposed Route northwest of Boynton and traverses southeast for approximately 1 mile before joining Proposed Alternative Route 3-C, which it follows to its terminus. This route provides for the potential use of the eastern half of Proposed Alternative Route 3-C.

As shown on Figure 3-2i, portions of Proposed Alternative Route 3-D are outside the 1-mile-wide area of Link F-8 of the Network of Potential Routes presented at scoping. The Routing Team sited Proposed Alternative Route 3-D outside of the Network of Potential Routes in response to comments received by the ODWC regarding the presence of federal grassland conservation easements and potential high value greater prairie-chicken habitat along Link F-8.

- **Proposed Alternative Route 3-E** begins at an intersection with the Applicant Proposed Route approximately 4 miles north of Warner, Oklahoma, and then turns south away from the Applicant Proposed Route for approximately 1 mile between Martin and McLain in Muskogee County, Oklahoma. At this point, the route turns east for approximately 8 miles before terminating at the Applicant Proposed Route west of the Arkansas River. This route provides an alternative crossing approach to the Arkansas River crossing. This alternative Arkansas River crossing approach is also shared by Proposed Alternative Routes 3-C and 3-D.

The key Tier IV criteria for each route are presented below. Table 3-4 compares the Tier IV criteria of each Proposed Alternative Route with the corresponding portion of the Applicant Proposed Route and summarizes the Tier IV criteria for the Applicant Proposed Route in Region 3. Figures 3-2 through 3-7 identify the Tier IV criteria in Region 3.

3.3.3.3.1 Applicant Proposed Route

The Applicant Proposed Route is 162.11 miles in length with 77.54 miles (47.8%) paralleling existing linear infrastructure. Land cover is predominantly agricultural and open lands (107.66 miles [66.4%]) with forested lands (46.75 miles [28.8%]) and urban lands (7.33 miles [4.5%]) making up most of the remaining land cover.

The Applicant Proposed Route is within 1,000 feet of 390 residences, within 250 feet of five residences, and within 100 feet of two residences. No schools, churches, or hospitals are within 1,000 feet of the route. The Applicant Proposed Route traverses 0.05 mile of the municipal boundaries of Beggs, Oklahoma, and 4.28 miles (2.6%) of Oklahoma School Lands.

The route traverses 80.43 miles (49.6%) of lands with prime farmland soils. One mile of the route is within the restricted air space for Vance Air Force Base, and the Applicant Proposed Route is within 1 mile of the Cushing Regional Airport.

The route traverses 42.85 miles (26.4%) of lands with the potential to be native prairie. Additionally, the Applicant Proposed Route traverses 36.00 miles (22.2%) of lands the USFWS has documented as having a potential for occurrence of the gray bat; and 86.28 miles (53.2%) of lands the USFWS has documented as having a potential for occurrence of the American burying beetle.

The Applicant Proposed Route crosses one major waterbody (Cimarron River) and 64 other waterbodies in Region 3. The Applicant Proposed Route traverses 1.04 miles (0.6%) of NWI-identified forested wetlands and 0.01 miles of NWI-identified non-forested wetlands. None of these NWI-identified wetland crossings are more than 1,000 feet in length. Additionally, the route traverses 11.97 miles (7.4%) of 100-year floodplain, with 16 crossings more than 1,000 feet in width.

No NRHP sites are within 0.25 mile of the Applicant Proposed Route; 17 recorded cultural sites are within 0.25 mile of the Applicant Proposed Route.

3.3.3.3.2 Proposed Alternative Route 3-A

Proposed Alternative Route 3-A is 37.74 miles in length with 3.23 miles (8.5%) paralleling existing linear infrastructure. Land cover is dominated by agricultural and open lands (27.78 miles [73.6%]), with forested lands (8.11 miles [21.5%]) and urban lands (1.51 miles [4.0%]) making up most of the remaining land cover.

Proposed Alternative Route 3-A is within 1,000 feet of 44 residences and within 250 feet of one residence; no residences are within 100 feet of the route. No schools, churches, or hospitals are within 1,000 feet of the route. Additionally, the route traverses 0.03 mile of the municipal boundaries of Mulhall, Oklahoma and 1.12 miles (3.0%) of Oklahoma School Lands.

The route traverses 13.87 miles (36.6%) of lands with prime farmland soils and 16.41 miles (43.5%) of lands with the potential to be native prairie.

Proposed Alternative Route 3-A crosses no major waterbodies but does cross 17 other waterbodies. Proposed Alternative Route 3-A traverses 0.08 mile (0.2%) of NWI-identified forested wetlands and an additional 0.03 mile (0.08%) of NWI-identified non-forested wetlands. None of these NWI-identified wetland crossings are more than 1,000 feet in length. Additionally, 1.75 miles (4.6%) of the route traverse 100-year floodplain, with one crossing being more than 1,000 feet in width.

No NRHP sites or recorded cultural sites are within 0.25 mile of Proposed Alternative Route 3-A.

Table 3-4 compares the Tier IV criteria of each Proposed Alternative Route with the corresponding portions of the Applicant Proposed Route and summarizes the Tier IV criteria for the Applicant Proposed Route in Region 3. In summary, Clean Line chose the Applicant Proposed Route rather than Proposed Alternative Route 3-A because the Applicant Proposed Route is:

- Parallel to more linear infrastructure; and
- Has lower residential density. While initial desktop evaluations showed fewer residential structures within 250 feet and 500 feet of the Proposed Alternative Route 3-A, direct observations during aerial reconnaissance (see Section 3.3.2 and Appendix C) led the Routing Team to conclude that the Applicant Proposed Route would pose fewer potential effects to existing residential areas.

3.3.3.3.3 Proposed Alternative Route 3-B

Proposed Alternative Route 3-B is 47.90 miles in length with 5.31 miles (11.1%) paralleling existing linear infrastructure. Land cover is predominantly agricultural and open lands (35.99 miles [75.1%]) with forested lands (9.61 miles [20.0%]) and urban lands (1.92 miles [4.0%]) making up most of the remaining land cover.

Proposed Alternative Route 3-B is within 1,000 feet of 127 residences and within 250 feet of three residences; no residences are within 100 feet of the route. No schools, churches, or hospitals are within 1,000 feet of the route, however, the route traverses 0.03 mile of the municipal boundaries of Mulhall, Oklahoma and 1.12 miles (2.3%) of Oklahoma School Lands.

The route traverses 18.88 miles (39.2%) of lands with prime farmland soils, and 17.67 miles (36.9%) of lands with the potential to be native prairie.

Proposed Alternative Route 3-B crosses no major waterbodies, but does cross 22 other waterbodies. Proposed Alternative Route 3-B traverses 0.16 mile (0.3%) of NWI-identified forested wetlands and an additional 0.03 mile (0.06%) of NWI-identified non-forested wetlands. None of these NWI-identified wetland crossings are more than 1,000 feet in length. Additionally, 2.45 miles (5.1%) of the route traverse a 100-year floodplain, with two crossings more than 1,000 feet in width.

No NRHP sites are within 0.25 mile of Proposed Alternative Route 3-B; one recorded cultural site is within 0.25 mile of Proposed Alternative Route 3-B.

Table 3-4 compares the Tier IV criteria of each Proposed Alternative Route with the corresponding portions of the Applicant Proposed Route and summarizes the Tier IV criteria for the Applicant Proposed Route in Region 3. In summary, Clean Line chose the Applicant Proposed Route rather than Proposed Alternative Route 3-B because the Applicant Proposed Route:

- Parallels more linear infrastructure;
- Has 43 fewer residences within 1,000 feet; and
- Crosses fewer waterbodies.

3.3.3.3.4 Proposed Alternative Route 3-C

Proposed Alternative Route 3-C is 121.93 miles in length with 40.41 miles (33.1%) paralleling existing linear infrastructure. Land cover is predominantly agricultural and open lands (80.82 miles [66.3%]), with forested lands (36.99 miles [30.3%]) and urban lands (3.76 miles [3.1%]) making up most of the remaining land cover.

Proposed Alternative Route 3-C is within 1,000 feet of 391 residences, within 250 feet of 11 residences, and within 100 feet of two residences. No schools, churches, or hospitals are within 1,000 feet of the route.

The route traverses 64.85 miles (53.2%) of lands with prime farmland soils, and 10.87 miles (8.9%) of lands with the potential to be native prairie. Additionally, The Applicant Proposed Route traverses 39.35

miles (32.3%) of lands the USFWS has documented as having a potential for occurrence of the gray bat and 87.89 miles (72.1%) of lands the USFWS has documented as having a potential for occurrence of the American burying beetle.

Proposed Alternative Route 3-C crosses one major waterbody (Cimarron River) and 39 other waterbodies in Region 3. Proposed Alternative Route 3-C traverses 2.45 miles (2.0%) of NWI-identified forested wetlands and an additional 0.25 mile (0.2%) of NWI-identified non-forested wetlands. Three of these NWI-identified wetland crossings are more than 1,000 feet in length. Additionally, 12.62 miles (10.4%) of the route traverse 100-year floodplain with 21 crossings more than 1,000 feet in width.

No NRHP sites are within 0.25 mile of Proposed Alternative Route 3-C; 24 recorded cultural sites are within 0.25 mile of Proposed Alternative Route 3-C.

Table 3-4 compares the Tier IV criteria of each Proposed Alternative Route with the corresponding portions of the Applicant Proposed Route and summarizes the Tier IV criteria for the Applicant Proposed Route in Region 3. In summary, Clean Line chose the Applicant Proposed Route rather than Proposed Alternative Route 3-C because the Applicant Proposed Route:

- Parallels more linear infrastructure,
- Has 65 fewer residences within 1,000 feet;
- Crosses fewer 100-year floodplains; and
- Crosses fewer NWI-identified wetlands.

3.3.3.3.5 Proposed Alternative Route 3-D

Proposed Alternative Route 3-D is 39.39 miles in length with 12.48 miles (31.7%) paralleling existing linear infrastructure. Land cover is predominantly agricultural and open lands (30.31 miles [76.9%]) with forested lands (7.55 miles [19.2%]) and urban lands (1.40 miles [3.6%]) making up most of the remaining land cover.

Proposed Alternative Route 3-D is within 1,000 feet of 163 residences, within 250 feet of three residences, and within 100 feet of two residences. No schools, churches, or hospitals are within 1,000 feet of the route.

The route traverses 27.81 miles (70.6%) of lands with prime farmland soils, and 0.46 miles (1.2%) of lands with the potential to be native prairie. The route also traverses 39.39 miles (100.0%) of lands the USFWS has documented as having a potential for occurrence of the gray bat and 35.56 miles (90.3%) of lands the USFWS has documented as having a potential for occurrence of the American burying beetle.

Proposed Alternative Route 3-D crosses no major waterbodies but does cross 16 other waterbodies. Proposed Alternative Route 3-D traverses 1.07 miles (2.7%) of NWI-identified forested wetlands and 0.20 mile (0.5%) NWI-identified non-forested wetlands. None of these NWI-identified wetland crossings are more than 1,000 feet in length. Additionally, 3.67 miles (9.3%) of the route traverse 100-year floodplain, with five crossings more than 1,000 feet in width.

No NRHP sites are within 0.25 mile of Proposed Alternative Route 3-D; 14 recorded cultural sites are within 0.25 mile of Proposed Alternative Route 3-D.

Table 3-4 compares the Tier IV criteria of each Proposed Alternative Route with the corresponding portions of the Applicant Proposed Route and summarizes the Tier IV criteria for the Applicant Proposed Route in Region 3. In summary, Clean Line chose the Applicant Proposed Route rather than the Proposed Alternative Route 3-D because the Applicant Proposed Route:

- Has 33 fewer residences within 1,000 feet;

- Crosses fewer NWI-identified wetlands; and
- Crosses fewer waterbodies.

3.3.3.3.6 Proposed Alternative Route 3-E

Proposed Alternative Route 3-E is 8.52 miles in length with 4.10 miles (48.1%) paralleling existing linear infrastructure. Land cover is predominantly agricultural and open lands (5.09 miles [59.7%]) with forested lands (3.00 miles [35.2%]) and urban lands (0.32 mile [3.8%]) making up most of the remaining land cover.

Proposed Alternative Route 3-E is within 1,000 feet of 44 residences, within 250 feet of one residence, and within 100 feet of one residence. No schools, churches, or hospitals are within 1,000 feet of the route.

The route traverses 4.50 miles (52.8%) of lands with prime farmland soils. Proposed Alternative Route 3-E traverses 8.52 miles (100.0%) of lands the USFWS has documented as having a potential for occurrence of the gray bat and 8.10 miles (95.1%) of lands the USFWS has documented as having potential occurrence of the American burying beetle.

Proposed Alternative Route 3-E crosses no major waterbodies but does cross two other waterbodies. Proposed Alternative Route 3-E traverses 0.36 miles (4.2%) of NWI-identified forested wetlands. None of these NWI identified wetland crossings are more than 1,000 feet in length. Additionally, 0.83 miles (9.7%) of the route traverse 100-year floodplain, with one crossing more than 1,000 feet in width.

No NRHP sites are within 0.25 mile of Proposed Alternative Route 3-E; three recorded cultural sites are within 0.25 mile of Proposed Alternative Route 3-E.

Table 3-4 provides a comparison of the Tier IV criteria of each Proposed Alternative Route with the corresponding portions of the Applicant Proposed Route and summarizes the Tier IV criteria for the Applicant Proposed Route in Region 3. In summary, Clean Line chose the Applicant Proposed Route rather than Proposed Alternative Route 3-E because the Applicant Proposed Route:

- Parallels more linear infrastructure;
- Has 17 fewer residences within 1,000 feet; and
- Crosses fewer NWI-identified wetlands.

Additionally, from an engineering perspective, the Applicant Proposed Route provides for a more feasible crossing of several transmission lines at the crossing of the Arkansas River.

This page intentionally left blank.

Table 3.4
Region 3 Tier IV Criteria Comparison

Criterion	Unit	AR 3 A (37.74 miles)	Corresponding Links of APR (40.12 miles)	AR 3 B (47.90 miles)	Corresponding Links of APR (50.06 miles)	AR 3 C (121.93 miles)	Corresponding Links of APR (116.87 miles)	AR 3 D (89.39 miles)	Corresponding Links of APR (85.16 miles)	AR 3 E (8.52 miles)	Corresponding Links of APR (7.77 miles)	APR Total in Region 3 (162.11 miles)
Existing Infrastructure¹												
Electrical Transmission Lines (69KV and higher)	Miles	1.21	14.08	2.92	17.08	26.09	43.68	8.97	12.09	3.33	6.10	59.10
Transmission Pipelines	Miles	0.94	7.89	1.13	12.94	13.07	12.06	2.33	0.58	0.00	0.00	20.94
Railroads	Miles	0.19	0.24	0.19	0.24	0.62	0.61	0.20	0.22	0.00	0.00	0.85
Publically Maintained Federal, State, and County Roads	Miles	1.27	1.52	1.46	1.71	4.11	4.36	1.75	1.15	0.92	0.31	6.07
Total Paralleling Existing Linear Infrastructure	Miles	3.23	21.09	5.31	26.91	40.41	54.69	12.48	13.38	4.10	6.10	77.54
Land Cover												
Parcels and Parcel Boundaries	Number	125	128	159	176	425	449	123	136	35	38	593
Agriculture and Open Lands												
NLCD Pasture / Hay	Miles	0.22	0.22	1.10	0.66	32.12	38.22	20.51	19.18	4.13	3.21	38.80
NLCD Barren Land	Miles	0.00	0.00	0.00	0.00	0.00	0.12	0.00	0.00	0.00	0.00	0.12
NLCD Grassland / Herbaceous	Miles	20.64	19.95	26.75	25.19	42.72	33.90	7.51	7.39	0.96	1.02	55.83
NLCD Shrub / Scrub	Miles	0.00	0.00	0.00	0.00	0.00	0.00	0.00	0.00	0.00	0.00	0.00
NLCD Cultivated Crops	Miles	6.92	7.99	8.15	9.71	5.98	4.58	2.29	0.26	0.00	0.00	12.91
Total Agriculture and Open Lands	Miles	27.78	28.17	35.99	35.56	80.82	76.82	30.31	26.84	5.09	4.23	107.66
Forested Areas	Miles	8.11	9.92	9.61	12.12	36.99	36.53	7.55	6.48	3.00	3.05	46.75
Urban/Developed Areas	Miles	1.51	1.92	1.92	2.24	3.76	5.29	1.40	1.79	0.32	0.48	7.33
Structures												
K-12 Schools, Colleges and Universities												
0-100 ft	Number	0	0	0	0	0	0	0	0	0	0	0
100-250 ft	Number	0	0	0	0	0	0	0	0	0	0	0
250-500 ft	Number	0	0	0	0	0	0	0	0	0	0	0
500-1,000 ft	Number	0	0	0	0	0	0	0	0	0	0	0
Churches												
0-100 ft	Number	0	0	0	0	0	0	0	0	0	0	0
100-250 ft	Number	0	0	0	0	0	0	0	0	0	0	0
250-500 ft	Number	0	0	0	0	0	0	0	0	0	0	0
500-1,000 ft	Number	0	0	0	0	0	0	0	0	0	0	0
Hospitals												
0-100 ft	Number	0	0	0	0	0	0	0	0	0	0	0
100-250 ft	Number	0	0	0	0	0	0	0	0	0	0	0
250-500 ft	Number	0	0	0	0	0	0	0	0	0	0	0
500-1,000 ft	Number	0	0	0	0	0	0	0	0	0	0	0
Residences												
0-100 ft	Number	0	0	0	1	2	1	2	1	1	1	2
100-250 ft	Number	1	1	3	1	11	6	3	4	1	1	7
250-500 ft	Number	12	11	25	18	89	98	36	39	11	11	112
500-1,000 ft	Number	31	22	99	63	289	228	122	86	31	16	269

Table 3.4
Region 3 Tier IV Criteria Comparison

Criterion	Unit	AR 3 A (37.74 miles)	Corresponding Links of APR (40.12 miles)	AR 3 B (47.90 miles)	Corresponding Links of APR (50.06 miles)	AR 3 C (121.93 miles)	Corresponding Links of APR (116.87 miles)	AR 3 D (39.39 miles)	Corresponding Links of APR (35.16 miles)	AR 3 E (8.52 miles)	Corresponding Links of APR (7.77 miles)	APR Total in Region 3 (162.11 miles)
Agricultural, Commercial, and Industrial Structures	0-100 ft	1	1	2	1	7	3	2	1	0	1	4
	100-250 ft	4	7	13	10	16	16	2	5	0	2	24
	250-500 ft	8	22	32	30	56	36	6	4	1	2	63
	500-1,000 ft	29	38	53	66	139	121	14	15	1	4	170
Government Jurisdictions												
Cities and Towns	Miles	0.03	0.00	0.03	0.00	0.00	0.05	0.00	0.00	0.00	0.00	0.05
National Forests (USDA Forest Service) - Administrative Boundary	Miles	0.00	0.00	0.00	0.00	0.00	0.00	0.00	0.00	0.00	0.00	0.00
National Forests (USDA Forest Service) - Owned	Miles	0.00	0.00	0.00	0.00	0.00	0.00	0.00	0.00	0.00	0.00	0.00
National Wildlife Refuges (USFWS)	Miles	0.00	0.00	0.00	0.00	0.00	0.00	0.00	0.00	0.00	0.00	0.00
National Parks (National Park Service)	Miles	0.00	0.00	0.00	0.00	0.00	0.00	0.00	0.00	0.00	0.00	0.00
USACE Lands	Miles	0.00	0.00	0.00	0.00	0.00	0.00	0.00	0.00	0.00	0.00	0.00
DOD Lands	Miles	0.00	0.00	0.00	0.00	0.00	0.00	0.00	0.00	0.00	0.00	0.00
State Parks												
Oklahoma State Parks (Oklahoma Department of Tourism and Recreation Department)	Miles	0.00	0.00	0.00	0.00	0.00	0.00	0.00	0.00	0.00	0.00	0.00
Arkansas State Parks (Arkansas Department of Parks and Tourism)	Miles	0.00	0.00	0.00	0.00	0.00	0.00	0.00	0.00	0.00	0.00	0.00
Tennessee State Parks (Tennessee Department of Environment and Conservation, Division of Parks and Conservation, State Parks)	Miles	0.00	0.00	0.00	0.00	0.00	0.00	0.00	0.00	0.00	0.00	0.00
State-Owned WMAs												
Oklahoma WMAs (Oklahoma Department of Wildlife Conservation)	Miles	0.00	0.00	0.00	0.00	0.00	0.00	0.00	0.00	0.00	0.00	0.00
Arkansas WMAs (Arkansas Game and Fish Commission)	Miles	0.00	0.00	0.00	0.00	0.00	0.00	0.00	0.00	0.00	0.00	0.00
Tennessee WMAs (Tennessee Wildlife Resources Agency)	Miles	0.00	0.00	0.00	0.00	0.00	0.00	0.00	0.00	0.00	0.00	0.00
Arkansas Leased WMAs (Arkansas Game and Fish Commission)	Miles	0.00	0.00	0.00	0.00	0.00	0.00	0.00	0.00	0.00	0.00	0.00
Oklahoma School Lands (The Commissioners of the Land Office)	Miles	1.12	2.40	1.12	3.35	0.00	1.87	0.00	0.00	0.00	0.00	4.28
Arkansas Natural Areas (Arkansas Natural Heritage Commission)	Miles	0.00	0.00	0.00	0.00	0.00	0.00	0.00	0.00	0.00	0.00	0.00
Tennessee Natural Areas (Tennessee Department of Environment and Conservation, Division of Natural Areas, Natural Areas Program)	Miles	0.00	0.00	0.00	0.00	0.00	0.00	0.00	0.00	0.00	0.00	0.00
County-, City-, and Town-owned Lands that are managed for conservation or recreation	Miles	0.00	0.00	0.00	0.00	0.00	0.00	0.00	0.00	0.00	0.00	0.00
Tribal Trust Lands and Allotments	Miles	0.00	0.00	0.00	0.00	0.00	0.00	0.00	0.00	0.00	0.00	0.00

Table 3.4
Region 3 Tier IV Criteria Comparison

Criterion	Unit	AR 3 A (37.74 miles)	Corresponding Links of APR (40.12 miles)	AR 3 B (47.90 miles)	Corresponding Links of APR (50.06 miles)	AR 3 C (121.93 miles)	Corresponding Links of APR (116.87 miles)	AR 3 D (39.39 miles)	Corresponding Links of APR (35.16 miles)	AR 3 E (8.52 miles)	Corresponding Links of APR (7.77 miles)	APR Total in Region 3 (162.11 miles)
Conservation Easements or Areas												
Federal Conservation Easements	Miles	0.00	0.00	0.00	0.00	0.00	0.00	0.00	0.00	0.00	0.00	0.00
State Conservation Easements	Miles	0.00	0.00	0.00	0.00	0.00	0.00	0.00	0.00	0.00	0.00	0.00
TNC Conservation Easements	Miles	0.00	0.00	0.00	0.00	0.00	0.00	0.00	0.00	0.00	0.00	0.00
Soil, Geologic, or Topographic Resources												
Prime Farmland	Miles	13.87	15.45	18.88	20.43	64.85	63.87	27.81	26.14	4.50	4.39	80.43
Farmlands of Statewide Importance	Miles	0.00	0.00	0.00	0.00	0.00	0.00	0.00	0.00	0.00	0.00	0.00
Slopes Greater than 20%	Miles	0.06	0.06	0.06	0.10	0.98	0.54	0.17	0.13	0.14	0.16	0.60
Karst Areas	Miles	0.00	0.00	0.00	0.00	0.00	0.00	0.00	0.00	0.00	0.00	0.00
Airport / Airfields												
Military Airports	Miles	0.00	0.00	0.00	0.00	0.00	1.00	0.00	0.00	0.00	0.00	1.00
FAA-Registered Public Airports	Number	0	0	0	0	0	1	0	0	0	0	1
FAA-Registered Private Airports	Number	0	0	0	0	0	0	0	0	0	0	0
Other Private Airstrips and Helipads	Number	0	0	0	0	0	0	0	0	0	0	0
Biological Resources												
USFWS-Designated Critical Habitat	Miles	0.00	0.00	0.00	0.00	0.00	0.00	0.00	0.00	0.00	0.00	0.00
Native Prairies	Miles	16.41	14.36	17.67	14.36	10.87	28.49	0.46	0.00	0.00	0.00	42.85
State Natural Heritage Program Species Location Data – Occurrence Records	Number	0	2	0	1	4	6	3	2	3	2	9
Arkansas Natural Heritage Program Species Location Data – Focal Areas	Miles	0.00	0.00	0.00	0.00	0.00	0.00	0.00	0.00	0.00	0.00	0.00
Arkansas Natural Heritage Program Species Location Data – Sensitive Streams	Number	0	0	0	0	0	0	0	0	0	0	0
Arkansas Natural Heritage Program Species Location Data – Designated Streams	Number	0	0	0	0	0	0	0	0	0	0	0
LEPC Potential Habitat – ODWC OLEPCSPT	Miles	0.00	0.00	0.00	0.00	0.00	0.00	0.00	0.00	0.00	0.00	0.00
LEPC Potential Habitat – WGA SGP CHAT - Rank 1	Miles	0.00	0.00	0.00	0.00	0.00	0.00	0.00	0.00	0.00	0.00	0.00
LEPC Potential Habitat – WGA SGP CHAT - Ranks 2 and 3	Miles	0.00	0.00	0.00	0.00	0.00	0.00	0.00	0.00	0.00	0.00	0.00
Existing Impacted Areas within LEPC Habitat - CHAT Rank 1	Miles	0.00	0.00	0.00	0.00	0.00	0.00	0.00	0.00	0.00	0.00	0.00
Existing Impacted Areas within LEPC Habitat - CHAT Ranks 2 and 3	Miles	0.00	0.00	0.00	0.00	0.00	0.00	0.00	0.00	0.00	0.00	0.00
Existing Impacted Areas within LEPC Habitat - OLEPCSPT Ranks 4-8	Miles	0.00	0.00	0.00	0.00	0.00	0.00	0.00	0.00	0.00	0.00	0.00
GRPC Potential Habitat: ODWC OGRPCSPT	Miles	0.00	0.00	0.00	0.00	0.58	0.00	0.58	0.00	0.00	0.00	0.00
Whooping Crane Migratory Stopover Locations	Miles	0.00	0.00	0.00	0.00	0.00	0.00	0.00	0.00	0.00	0.00	0.00
Ozark Big-Eared Bat Potential Occurrence Areas	Miles	0.00	0.00	0.00	0.00	0.00	0.00	0.00	0.00	0.00	0.00	0.00
Indiana Bat Potential Occurrence Areas	Miles	0.00	0.00	0.00	0.00	0.00	0.00	0.00	0.00	0.00	0.00	0.00
Gray Bat Potential Occurrence Areas	Miles	0.00	0.00	0.00	0.00	39.35	36.00	39.39	35.16	8.52	7.77	36.00
Known Bat Caves	Number	0	0	0	0	0	0	0	0	0	0	0
American Burying Beetle Potential Occurrence Areas	Miles	0.00	0.00	0.00	0.00	87.89	86.28	35.56	33.05	8.10	7.29	86.28

Table 3.4
Region 3 Tier IV Criteria Comparison

Criterion	Unit	AR 3 A (37.74 miles)	Corresponding Links of APR (40.12 miles)	AR 3 B (47.90 miles)	Corresponding Links of APR (50.06 miles)	AR 3 C (121.93 miles)	Corresponding Links of APR (118.87 miles)	AR 3 D (39.39 miles)	Corresponding Links of APR (35.16 miles)	AR 3 E (8.52 miles)	Corresponding Links of APR (7.77 miles)	APR Total in Region 3 (162.11 miles)
Water Resources												
NWI Forested Wetlands	Miles	0.08	0.16	0.16	0.16	2.45	0.88	1.07	0.30	0.36	0.00	1.04
NWI Non-Forested Wetlands	Miles	0.03	0.00	0.03	0.00	0.25	0.01	0.20	0.00	0.00	0.00	0.01
NWI Forested Wetland Crossings >1,000 ft	Number	0	0	0	0	3	0	0	0	0	0	0
NWI Non-Forested Wetland Crossings >1,000 ft	Number	0	0	0	0	0	0	0	0	0	0	0
NLCD Forested Wetlands	Miles	0.00	0.00	0.00	0.00	0.00	0.00	0.00	0.00	0.00	0.00	0.00
NLCD Non-Forested Wetlands	Miles	0.00	0.00	0.00	0.00	0.00	0.00	0.00	0.00	0.00	0.00	0.00
NLCD Forested Wetland Crossings >1,000 ft	Number	0	0	0	0	0	0	0	0	0	0	0
NLCD Non-Forested Wetland Crossings >1,000 ft	Number	0	0	0	0	0	0	0	0	0	0	0
Floodplains - Length Crossed	Miles	1.75	3.89	2.45	5.04	12.62	8.05	3.67	1.70	0.83	0.00	11.97
Floodplains - Crossings Greater than 1,000 ft	Number	1	4	2	6	21	12	5	2	1	0	16
Major Waterbodies and Reservoirs - Number Intersected	Number	0	0	0	0	1	1	0	0	0	0	1
Major Waterbodies and Reservoirs - Distance Crossed	Miles	0.00	0.00	0.00	0.00	0.23	0.11	0.00	0.00	0.00	0.00	0.11
State-Designated Waterbodies with Special Significance	Number	5	0	5	0	3	6	0	0	0	0	6
Other Waterbodies	Number	17	6	22	10	39	54	16	10	2	3	64
Springs 0-250 ft	Number	0	0	0	0	0	0	0	0	0	0	0
Springs 250-500 ft	Number	0	0	0	0	0	0	0	0	0	0	0
Wild and Scenic Rivers	Number	0	0	0	0	0	0	0	0	0	0	0
Visual / Cultural Resources												
Federally and State-Designated Scenic Routes, Trails, and Byways	Number	0	0	0	0	0	0	0	0	0	0	0
Sites on the NRHP	Number	0	0	0	0	0	0	0	0	0	0	0
Recorded Cultural or Historical Sites												
Archaeological Sites	Number	0	0	1	0	10	6	2	2	1	2	6
GLO Sites	Number	0	0	0	0	14	11	12	7	2	7	11
Historical Sites	Number	0	0	0	0	0	0	0	0	0	0	0
Total Recorded Cultural or Historical Sites	Number	0	0	1	0	24	17	14	9	3	9	17
Cemeteries	Number	0	0	0	0	0	0	0	0	0	0	0
Environmentally Regulated Sites												
Known Contaminated Sites	Number	0	0	0	0	0	0	0	0	0	0	0
Engineering Considerations												
Total Length of the Transmission Line	Miles	37.74	40.12	47.90	50.06	121.93	118.87	39.39	35.16	8.52	7.77	162.11
Electrical Transmission Line Crossings												
69KV-345KV intersected by the representative centerline	Number	3	4	5	6	13	16	6	4	4	4	21
Greater than 345KV intersected by the representative centerline	Number	2	2	2	2	3	5	1	4	1	1	7
Transmission Pipeline Crossings	Number	4	7	6	10	28	30	4	3	0	0	38
Major Road Crossings	Number	3	3	4	4	8	9	4	4	0	0	13
Railroad ROW Crossings	Number	1	0	1	0	2	3	1	1	0	0	4

Notes:

Table 3 4
Region 3 Tier IV Criteria Comparison

Criterion	Unit	AR 3 A (37.74 miles)	Corresponding Links of APR (40.12 miles)	AR 3 B (47.90 miles)	Corresponding Links of APR (50.06 miles)	AR 3 C (121.93 miles)	Corresponding Links of APR (118.87 miles)	AR 3 D (39.39 miles)	Corresponding Links of APR (35.16 miles)	AR 3 E (8.52 miles)	Corresponding Links of APR (7.77 miles)	APR Total in Region 3 (162.11 miles)
-----------	------	-------------------------	--	-------------------------	--	--------------------------	---	-------------------------	--	------------------------	---	--

¹ Miles of existing infrastructure are determined by measuring the length of the representative centerline intersection with a 500-foot buffer to each side of existing infrastructure. Crossings of existing infrastructure are included in this total and can add approximately 1,000 to 1,500 feet of length per crossing, depending on the angle of intersection. The Engineering Considerations section presents the number of crossings for each type of existing infrastructure. The Routing Team considered this additional length during the route identification process and Paired-Node Analyses.

Key:
 APR = Applicant Proposed Route.
 AR = Alternative Route.
 DOD = (United States) Department of Defense.
 FAA = Federal Aviation Administration.
 ft = feet.
 GLO = General Land Office.
 GRPC = greater prairie-chicken.
 KV = Kivovot(s).
 LEPC = lesser prairie-chicken.
 NLCD = National Land Cover Dataset.
 NRRP = National Register of Historic Places.
 NWI = National Wetlands Inventory.
 ODWC = Oklahoma Department of Wildlife Conservation.
 OGRPCST = Oklahoma Greater Prairie-Chicken Spatial Planning Tool.
 OLEPCST = Oklahoma Lesser Prairie-Chicken Spatial Planning Tool.
 ROW = right-of-way.
 SGP CHAT = Southern Great Plains Crucial Habitat Assessment Tool.
 TNC = The Nature Conservancy.
 USACE = United States Army Corps of Engineers.
 USDA = United States Department of Agriculture.
 USFWS = United States Fish and Wildlife Service.
 WGA = Western Governors Association.
 WMA = Wildlife Management Area.

This page intentionally left blank.

3.3.3.4 Region 4 (Arkansas River Valley)

Region 4 begins approximately 0.6 mile north of Webbers Falls in Muskogee County, Oklahoma, continues east through Muskogee and Sequoyah counties, Oklahoma, and Crawford, Franklin, Johnson, and Pope Counties, Arkansas, for a distance of approximately 127 miles, and terminates approximately 13 miles north of Russellville, Arkansas. Land cover in Region 4 consists primarily of open lands, pasture, and mixed pine/hardwood forest or planted pine. Towns near the routes in this Region include Webbers Falls, Gore, Vian, Marble City, and Sallisaw, Oklahoma, and Cedarville, Van Buren, Alma, Kibler, Dyer, Mulberry, Ozark, Wiederkehr Village, and Clarksville, Arkansas.

Clean Line identified the Applicant Proposed Route and five Proposed Alternative Routes in Region 4. The locations of these routes in Region 4 are summarized below and are illustrated on Figures 3-2i through 3-2l.

- **Applicant Proposed Route** begins at the western boundary of Region 4 near the western bank of the Arkansas River in Muskogee County, Oklahoma, and parallels several existing electrical transmission lines across the Arkansas River. North of Gore, the route turns southeast to parallel OG&E's Muskogee-to-Fort Smith 345kV electrical transmission line for approximately 7 miles. The route then turns east to follow county roads and parcel lines, to the extent practicable, for approximately 21 miles. The route parallels the Gore-to-Alma 138kV transmission line for approximately 5 miles north of Van Buren, Arkansas, and then continues east to follow county roads and parcel lines, to the extent practicable, for 9 miles. West of Alma, Arkansas, the route parallels the Gore-to-Alma 138kV transmission line for approximately 1 mile before turning southeast and crossing Interstate (I) 40. The route continues southeast, east, and northeast to follow parcel lines, to the extent practicable, for approximately 16 miles before crossing I-40 a second time. North of I-40, the route turns east to follow I-40 and parcel boundaries, to the extent practicable, for approximately 13 miles before it turns northeast for approximately 3 miles to follow the Alma-to-Dardanelle 138kV electrical transmission line. Heading east, the route parallels the transmission line for approximately 5 miles. The route then continues east to follow parcel lines and county roads, to the extent practicable, for approximately 27 miles and then turns south after entering Pope County to parallel an existing electrical transmission line for approximately 3 miles. The Applicant Proposed Route then turns southeast and terminates at the eastern boundary of Region 4, approximately 5 miles northwest of Dover, Arkansas.

As shown on Figure 3-2k, portions of the Applicant Proposed Route are outside the 1-mile-wide area of Links H-I and H-5 of the Network of Potential Routes presented at scoping. The Applicant Proposed Route was sited outside of the Network of Potential Routes in this area to avoid residences and agricultural structures identified in comments submitted to the DOE during scoping. The Routing Team subsequently confirmed the presence and location of these structures through aerial reconnaissance.

- **Proposed Alternative Route 4-A** begins at an intersection with the Applicant Proposed Route approximately 2 miles northwest of Vian in Sequoyia County, Oklahoma, and turns northeast for approximately 9 miles. South of Marble City, Proposed Alternative Route 4-A turns east to follow parcel boundaries, to the extent practicable, for approximately 13 miles and then follows the Nicut-to-Brushy Switching Station 69kV electrical transmission line for approximately 3 miles. Proposed Alternative Route 4-A then continues southeast, east, and northeast for approximately 21 miles, then crosses I-540 north of Alma and continues generally southeast for approximately 13 miles, intersecting with the Applicant Proposed Route approximately 2 miles northeast of Mulberry in Crawford County, Arkansas. Proposed

Alternative Route 4-A provides a central route through Crawford County, Arkansas, south of the municipal boundaries of Cedarville, Arkansas.

As shown on Figure 3-2j, portions of Proposed Alternative Route 4-A are outside the 1-mile-wide area of Links G-2 and G-5 of the Network of Potential Routes presented at scoping to avoid residences and a municipality (Cedarville, Arkansas). These resources were identified in comments submitted to the DOE during scoping and through comments received during stakeholder meetings. The Routing Team subsequently confirmed the presence and location of these structures by reviewing aerial photography and performing aerial reconnaissance.

- **Proposed Alternative Route 4-B** begins at an intersection with the Applicant Proposed Route approximately 5 miles northwest of Vian in Sequoyia County, Oklahoma, and turns east and northeast for approximately 10 miles to intersect with Proposed Alternative Route 4-A. Proposed Alternative Route 4-B then continues with Proposed Alternative Route 4-A until approximately 5 miles west of the Oklahoma/Arkansas state line. Proposed Alternative Route 4-B then turns east, northeast, and southeast for approximately 20 miles, north of Cedarville, Arkansas, before it intersects Proposed Alternative Route 4-A west of I-540 in Crawford County, Arkansas. Proposed Alternative Route 4-B then continues with Proposed Alternative Route 4-A and intersects back with the Applicant Proposed Route approximately 2 miles northeast of Mulberry in Crawford County, Arkansas. Proposed Alternative Route 4-B provides a northern route (i.e., within the Ozark National Forest), in Crawford County, Arkansas.

As shown on Figure 3-2j, portions of Proposed Alternative Route 4-B are outside the 1-mile-wide area of Links G-2 and G-6 of the Network of Potential Routes presented at scoping. Proposed Alternative Route 4-B was sited outside of the Network of Potential Routes in this area to avoid residences and a municipality (Cedarville, Arkansas). These resources were identified in comments submitted to the DOE during scoping and through comments received during stakeholder meetings. The Routing Team subsequently confirmed the presence and location of these structures by reviewing aerial photography and performing aerial reconnaissance. The Routing Team also developed this alternative in response to comments received by the DOE during scoping to consider routes within the Ozark National Forest.

- **Proposed Alternative Route 4-C** begins at an intersection with the Applicant Proposed Route approximately 2 miles north of Van Buren in Crawford County, Arkansas, and continues south to follow parcel lines before turning southeast and east to follow parcel lines again. The route turns northeast for approximately 1 mile and returns to the Applicant Proposed Route approximately 2 miles north of Van Buren in Crawford County, Arkansas. The Routing Team developed Proposed Alternative Route 4-C to provide a southern alternative around a developing residential area identified during scoping comments.

As shown on Figure 3-2j, portions of Proposed Alternative Route 4-C are outside of the 1-mile-wide area of Link G-4 of the Network of Potential Routes presented at scoping. Proposed Alternative Route 4-C was sited outside of the Network of Potential Routes in this area in response to comments received by the DOE during the scoping period regarding the aforementioned residential area north of Van Buren.

- **Proposed Alternative Route 4-D** begins at an intersection with the Applicant Proposed Route approximately 2 miles northwest of Van Buren, Crawford County, Arkansas, and then turns northeast for approximately 4 miles before it joins Proposed Alternative Route 4-A. Proposed Alternative Route 4-D then follows Proposed Alternative Route 4-A to an intersection with the Applicant Proposed Route approximately 2 miles northeast of Mulberry, Arkansas. Proposed Alternative Route 4-D provides a northern alternative route near residentially-developed areas near Cedarville and Van Buren.

As shown on Figure 3-2j, portions of Proposed Alternative Route 4-D are outside the 1-mile-wide area of Link G-5 of the Network of Potential Routes presented at scoping to avoid residences. These residences were identified in comments submitted to the DOE during scoping and through comments received during stakeholder meetings. The Routing Team subsequently confirmed the presence and location of these structures by reviewing aerial photography and performing aerial reconnaissance.

- **Proposed Alternative Route 4-E** begins at an intersection with the Proposed Applicant Route approximately 3 miles northwest of Wiederkehr Village, Franklin County, Arkansas, and continues east to follow parcel lines, to the extent practicable, for approximately 1 mile before turning southeast to cross I-40. South of I-40 the route turns southeast and east to parallel the Dardanelle-to-Ozark 161kV electrical transmission line for approximately 8 miles. West of Clarksville, Proposed Alternative Route 4-E turns northeast to cross I-40 and continues in a stepped east and northeast direction north of Clarksville, following parcel boundaries, to the extent practicable. The route then turns northeast to follow the existing transmission line for approximately 0.5 mile and then continues northeast and southeast through the northern part of Clarksville. Northeast of Clarksville, the alternative route turns southeast and east to parallel the existing electric transmission line for approximately 5 miles before intersecting with the Applicant Proposed Route approximately 5 miles northwest of Dover, Pope County, Arkansas, at the eastern boundary of Region 4. Proposed Alternative Route 4-E provides a southern route for traversing eastern Arkansas outside of the Ozark National Forest.

The key Tier IV criteria for each route are presented below. Table 3-5 compares the Tier IV criteria of each Proposed Alternative Route with the corresponding portion of the Applicant Proposed Route and summarizes the Tier IV criteria for the Applicant Proposed Route in Region 4. Figures 3-2 through 3-7 identify the Tier IV criteria in Region 4.

3.3.3.4.1 Applicant Proposed Route

The Applicant Proposed Route is 126.67 miles in length with 37.30 miles (29.4%) paralleling existing linear infrastructure. Land cover is dominated by agricultural and open lands (65.67 miles [51.8%]) with forested lands (55.98 miles [44.2%]) and urban and developed areas (3.72 miles [2.9%]) making up most of the remaining land cover.

The Applicant Proposed Route is within 1,000 feet of 483 residences and within 250 feet of 20 residences; no residences are within 100 feet of the route. No schools or hospitals are within 1,000 feet of the route; however, two churches are within 1,000 feet of the route.

The Applicant Proposed Route traverses 3.20 miles (2.5%) within the municipal boundaries of Gore, Oklahoma, Vian, Oklahoma, and Mulberry, Arkansas. The Applicant Proposed Route also traverses 1.16 miles (0.9%) of United States Army Corps of Engineers (USACE) lands at the Arkansas River crossing; 0.10 mile (0.1%) of Arkansas Leased WMAs (i.e., Frog Bayou and Ozark Lake WMAs); and 0.37 mile (0.3%) of tribal trust lands and allotments in the vicinity of the Arkansas River.

The Applicant Proposed Route traverses 48.35 miles (38.2%) of prime farmland soils and 9.56 miles (7.5%) of land with slopes greater than 20%. One mile of the route is within the restricted airspace of Ozark Regional Airport but, because of local topography, the route and associated structures would not penetrate the restricted airspaces. The Applicant Proposed Route is within 1 mile of Ozark Regional Airport and a private airfield.

The Applicant Proposed Route traverses 88.48 miles (69.9%), 68.02 miles (53.7%), and 50.35 miles (39.7%) within counties the USFWS has documented as having a potential for occurrence of the Ozark big-eared bat, Indiana bat, and gray bat, respectively. Additionally, the Applicant Proposed Route

November 2013

traverses 61.19 miles (48.3%) within counties the USFWS has documented as having a potential for occurrence of the American burying beetle.

The Applicant Proposed Route crosses four major waterbodies (Arkansas River, Illinois River, Lee Creek, and Mulberry River) and 30 other waterbodies in Region 4. Additionally, the Applicant Proposed Route traverses five state-designated waterbodies with special significance and two Wild and Scenic Rivers (i.e., the Mulberry River and Piney Creek). The route traverses 0.41 (0.3%) mile of NWI-identified forested wetlands and 0.06 mile of NWI-identified non-forested wetlands. None of these NWI-identified wetland crossings are more than 1,000 feet in length. The route traverses 22.43 miles (17.7%) of 100-year floodplains, with 28 crossings more than 1,000 feet in length.

Eleven federally and/or state-designated scenic routes, trails or byways, including S.R. 59, I-40 (two crossings), S.R. 23 (Pig Trail Scenic Byway), S.R. 21 (Ozark Highlands Scenic Byway), and the Trail of Tears (four crossings), are traversed by the Applicant Proposed Route. No NRHP sites are within 0.25 mile of the Applicant Proposed Route; 30 recorded cultural sites are within 0.25 mile of the Applicant Proposed Route. Additionally, three cemeteries are within 500 feet of the route.

3.3.3.4.2 Proposed Alternative Route 4-A

The Proposed Alternative Route 4-A is 58.59 miles in length with 6.87 miles (11.7%) of the route paralleling existing linear infrastructure. Land cover is predominantly forested lands (31.11 miles [53.1%]) and agricultural and open lands (26.18 miles [44.7%]), with urban lands (1.14 miles [1.9%]) making up most of the remaining land cover.

Proposed Alternative Route 4-A is within 1,000 feet of 266 residences, within 250 feet of nine residences, and within 100 feet of four residences are within 100 feet of the route. No schools or hospitals are within 1,000 feet of the route; however, one church is within 1,000 feet of the route.

The route traverses 10.67 miles (18.2%) of prime farmland soils. Proposed Alternative Route 4-A traverses 7.44 miles (12.7%) of land with slopes greater than 20%. This route is within 1 mile of a private airfield.

Proposed Alternative Route 4-A traverses 58.59 miles (100%) within counties the USFWS has documented as having a potential for occurrence of the Ozark big-eared bat. This route also traverses 31.08 miles (53.0%) within counties that the USFWS has documented as having a potential for occurrence of the Indiana bat and gray bat. Lastly, Proposed Alternative Route 4-A traverses 31.59 miles (53.9%) within counties the USFWS has documented as having a potential for occurrence of the American burying beetle.

Proposed Alternative Route 4-A crosses three major waterbodies (Little Lee Creek, Lee Creek, and Mulberry River) and 19 other waterbodies in Region 4. Additionally, the route traverses one designated Wild and Scenic River (the Mulberry River). Proposed Alternative Route 4-A traverses 0.15 mile (0.3%) of NWI-identified forested wetlands. None of these NWI-identified wetland crossings are more than 1,000 feet in length. The route traverses 5.32 miles (9.1%) of 100-year floodplain, with six crossings more than 1,000 feet in length.

Proposed Alternative Route 4-A traverses five federally and/or state-designated scenic routes, trails or byways (S.R. 220, I-540 [Boston Mountain Scenic Loop], and U.S. 71 [Boston Mountain Scenic Loop], and the Trail of Tears [Two crossings]). No NRHP sites are within 0.25 mile of the Proposed Alternative Route 4-A; three recorded cultural sites are within 0.25 mile of the Proposed Alternative Route 4-A. Additionally, one cemetery is within 500 feet of the route.

Table 3-5 compares the Tier IV criteria of each Proposed Alternative Route with the corresponding portion of the Applicant Proposed Route and summarizes the Tier IV criteria for the Applicant

Proposed Route in Region 4. In summary, Clean Line chose the Applicant Proposed Route rather than Proposed Alternative Route 4-A because the Applicant Proposed Route:

- Parallels more linear infrastructure;
- Does not traverse counties having a potential for occurrence of the Ozark big-eared bat, Indiana bat, and American burying beetle; and
- Crosses fewer slopes and floodplains.

3.3.3.4.3 Proposed Alternative Route 4-B

Proposed Alternative Route 4-B is 78.89 miles in length, with 8.00 miles (10.1%) of the route paralleling existing linear infrastructure. Land cover is predominantly forested lands (52.18 miles [66.1%]), with agricultural and open lands (24.40 miles [30.9%]) and urban lands (2.00 miles [2.5%]) making up most of the remaining land cover.

Proposed Alternative Route 4-B is within 1,000 feet of 288 residences, within 250 feet of 19 residences, and within 100 feet of seven residences. No schools, churches, or hospitals are within 1,000 feet of the route.

This route traverses 10.65 miles (13.5%) of the Ozark National Forest Administrative Boundary and 4.21 miles (5.3%) of Ozark National Forest-owned lands.

The route traverses 12.05 miles (15.3%) of prime farmland soils and 11.52 miles (14.6%) of land with slopes more than 20%. This route is within 1 mile of a private airfield.

Proposed Alternative Route 4-B traverses 78.89 miles (100%), 34.22 miles (43.4%), and 34.22 miles (43.4%) within counties that the USFWS has documented as having a potential for occurrence of the Ozark big-eared bat, Indiana bat, and gray bat, respectively. Additionally, 52.30 miles (66.3%) of this route traverse counties that the USFWS has documented as having a potential for occurrence of the American burying beetle.

Proposed Alternative Route 4-B crosses two major waterbodies (Lee Creek and the Mulberry River, a Wild and Scenic River) and 10 other waterbodies. This route also traverses 0.18 mile of NWI-identified forested. Additionally, the route traverses 4.35 miles (5.5%) of 100-year floodplain, with five crossings more than 1,000 feet in length.

Proposed Alternative Route 4-B traverses six federally and/or state-designated scenic routes, trails or byways, including S.R. 59, I-540, and S.R. 71 (Boston Mountains Scenic Loop with two crossings), S.R. 23 (Pig Trail Scenic Byway), and the Trail of Tears (two crossings). No NRHP sites are within 0.25 mile of the Proposed Alternative route 4-B; one recorded cultural or historical site is within 0.25 mile of Proposed Alternative Route 4-B. Additionally, one cemetery is within 500 feet of the route.

Table 3-5 compares the Tier IV criteria of each Proposed Alternative Route with the corresponding portion of the Applicant Proposed Route and summarizes the Tier IV criteria for the Applicant Proposed Route in Region 4. In summary, Clean Line chose the Applicant Proposed Route rather than Proposed Alternative Route 4-B because the Applicant Proposed Route:

- Parallels more linear infrastructure;
- Traverses fewer forested lands;
- Does not traverse any National Forest lands, Arkansas State Park lands, or counties documented as having a potential for occurrence of the Ozark big-eared bat, Indiana bat, and American burying beetle; and

- Traverses fewer lands with slopes greater than 20% than Proposed Alternative Route 4-B.

3.3.3.4.4 Proposed Alternative Route 4-C

Proposed Alternative Route 4-C is 3.37 miles in length with 0.68 mile (20.2%) of the route paralleling existing linear infrastructure. Land cover is predominantly forested lands (2.23 miles [66.2%]), with agricultural and open lands (1.02 miles [30.3%]) and urban lands (0.11 mile [3.3%]) making up most of the remaining land cover.

Proposed Alternative Route 4-C is within 1,000 feet of 40 residences, within 250 feet of two residences, and within 100 feet of one residence. No schools, churches, or hospitals are within 1,000 feet of the route.

The route traverses 0.53 mile (15.7%) of prime farmland soils. Proposed Alternative Route 4-C traverses 0.27 mile (8.0%) of land with slopes more than 20%. This proposed route also traverses 3.37 miles (100%) within counties that the USFWS has documented as having a potential for occurrence of the Ozark big-eared bat.

Proposed Alternative Route 4-C traverses four other waterbodies, but no major ones.

Proposed Alternative Route 4-C traverses two federally and/or state-designated scenic route, S.R. 59, and the Trail of Tears. No NRHP sites or recorded cultural or historical sites are within 0.25 mile of Proposed Alternative Route 4-C.

Table 3-5 compares the Tier IV criteria of each Proposed Alternative Route with the corresponding portion of the Applicant Proposed Route and summarizes the Tier IV criteria for the Applicant Proposed Route in Region 4. In summary, Clean Line chose the Applicant Proposed Route rather than Proposed Alternative Route 4-C because the Applicant Proposed Route:

- Parallels more linear infrastructure; and
- Has 25 fewer residences within 1,000 feet.

3.3.3.4.5 Proposed Alternative Route 4-D

Proposed Alternative Route 4-D is 25.36 miles in length with 1.90 miles (7.5%) paralleling existing linear infrastructure. Land cover is dominated by agricultural and open lands (13.08 miles [51.6%]) and forested lands (11.55 miles [45.5%]), with urban and developed areas (0.65 miles [[2.6%]) making up most of the remaining land cover.

Proposed Alternative Route 4-D is within 1,000 feet of 210 residences, within 250 feet of two residences, and within 100 feet of three residences. No schools or hospitals are within 1,000 feet of the route; however, two churches are within 1,000 feet of the route and one church is within 100 feet of the route.

The route traverses 6.63 miles (26.1%) of prime farmland soils and 3.21 miles (12.7%) of land with slopes greater than 20%.

Proposed Alternative Route 4-D traverses 25.36 miles (100%) and 1.11 miles (4.4%) within counties the USFWS has documented as having a potential for occurrence of the Ozark big-eared bat and American burying beetle, respectively.

Proposed Alternative Route 4-D crosses one major waterbody (Mulberry River) and traverses three other waterbodies in Region 4. Additionally, the route traverses one designated Wild and Scenic River (the Mulberry River) and is within 500 feet of two springs. Proposed Alternative Route 4-D does not traverse any NWI-identified wetlands; however, Proposed Alternative Route 4-D traverses 0.02 mile

(0.1%) of NLCD-identified forested wetlands and 0.04 mile (0.2%) of NLCD-identified non-forested wetlands. None of these NLCD-identified wetland crossings are more than 1,000 feet in length. The route traverses 2.00 miles (7.9%) of 100-year floodplain with three crossings more than 1,000 feet in length.

Proposed Alternative Route 4-D traverses five federally and/or state-designated scenic routes, trails or byways (S.R. 220, I-540 [Boston Mountain Scenic Loop], U.S. 71 [Boston Mountain Scenic Loop]), and the Trail of Tears (two crossings). No NRHP sites are within 0.25 mile of the Proposed Alternative Route 4-D; six recorded cultural sites are within 0.25 mile of the Proposed Alternative Route 4-D.

Table 3-5 compares the Tier IV criteria of each Proposed Alternative Route with the corresponding portion of the Applicant Proposed Route and summarizes the Tier IV criteria for the Applicant Proposed Route in Region 4. In summary, Clean Line chose the Applicant Proposed Route rather than Proposed Alternative route 4-D because the Applicant Proposed Route:

- Parallels more linear infrastructure;
- Has 128 fewer residences within 1,000 feet;
- Is not within 500 feet of any springs;
- Crosses fewer slopes; and
- Crosses fewer floodplains.

3.3.3.4.6 Proposed Alternative Route 4-E

Proposed Alternative Route 4-E is 36.86 miles in length with 23.44 miles (63.6%) of the route paralleling existing linear infrastructure. Land cover is predominantly forested lands (17.50 miles [47.5%]) and agricultural and open lands (17.13 miles [46.5%]), with urban lands (1.69 miles [5.3%]) making up most of the remaining land cover.

Proposed Alternative Route 4-E is within 1,000 feet of 201 residences, within 250 feet of five residences, and within 100 feet of two residences. No schools or hospitals are within 1,000 feet of the route, but one church is within 1,000 feet. Proposed Alternative Route 4-E traverses 2.24 miles (6.1%) within the municipal boundaries of the city of Clarksville, Arkansas.

The route traverses 17.70 miles (48.0%) of prime farmland soils. This alternative route also traverses 2.61 miles (7.1%) of land with slopes more than 20%.

Proposed Alternative Route 4-E traverses 4.28 miles (11.6%), 28.92 miles (78.5%), and 3.66 miles (9.9%) within counties that the USFWS has documented as having a potential for occurrence of the Ozark big-eared bat, Indiana bat, and gray bat, respectively. Additionally, 3.99 miles (10.8%) of this route traverses counties that the USFWS has documented as having a potential for occurrence of the American burying beetle.

Proposed Alternative Route 4-E crosses one major waterbody (Piney Creek, a Wild and Scenic River that is a tributary to the Arkansas River) and 10 other waterbodies. Additionally, the route traverse 2.77 miles (7.5%) of 100-year floodplain, with five crossings more than 1,000 feet in length.

Proposed Alternative Route 4-E traverses four federally and/or state-designated scenic routes, trails or byways (I-40 and S.R. 292) and the Trail of Tears. Additionally, two NRHP sites (Lutherville School and Munger House) and 11 recorded cultural or historical sites are within 0.25 mile of Proposed Alternative Route 4-E. Additionally, three cemeteries are within 500 feet of the route.

Table 3-5 compares the Tier IV criteria of each Proposed Alternative Route with the corresponding portion of the Applicant Proposed Route and summarizes the Tier IV criteria for the Applicant

November 2013

Proposed Route in Region 4. In summary, Clean Line chose the Applicant Proposed Route rather than the Proposed Alternative Route 4-E because the Applicant Proposed Route:

- Has 60 fewer residences within 1,000 feet;
- Does not traverse in any municipal boundaries, and
- Does not traverse any NRHP sites.

Table 3 5
Region 4 Tier IV Criteria Comparison

Criterion	Unit	AR 4 A (58.59 miles)	Corresponding Links of APR (60.35 miles)	AR 4 B (78.89 miles)	Corresponding Links of APR (81.52 miles)	AR 4 C (3.37 miles)	Corresponding Links of APR (2.16 miles)	AR 4 D (25.36 miles)	Corresponding Links of APR (25.37 miles)	AR 4 E (36.86 miles)	Corresponding Links of APR (38.86 miles)	APR Total in Region 4 (126.67 miles)
Existing Infrastructure												
Electrical Transmission Lines (69 kV and higher)	Miles	3.27	12.24	2.79	15.47	0.00	0.20	0.40	2.16	17.76	8.09	25.75
Transmission Pipelines	Miles	0.00	2.05	1.56	3.87	0.49	0.35	0.19	2.05	6.87	1.87	5.53
Railroads	Miles	0.49	0.97	0.49	0.97	0.00	0.00	0.25	0.77	0.00	0.00	1.28
Publically Maintained Federal, State, and County Roads	Miles	3.13	3.43	3.31	5.08	0.19	0.20	1.06	2.10	1.78	1.78	7.09
Total Paralleling Existing Linear Infrastructure	Miles	6.87	18.14	8.00	24.51	0.68	0.74	1.90	6.79	23.44	10.54	37.30
Land Cover												
Parcels and Parcel Boundaries	Number	320	294.00	378	349.00	21	13	155	138	149	196	601
Agriculture and Open Lands												
NLCD Pasture / Hay	Miles	20.70	32.16	18.73	42.33	0.81	0.59	12.20	14.14	16.23	16.61	59.12
NLCD Barren Land	Miles	0.00	0.00	0.00	0.00	0.00	0.00	0.00	0.00	0.00	0.00	0.00
NLCD Grassland / Herbaceous	Miles	4.62	1.64	4.42	1.87	0.22	0.03	0.75	0.06	0.31	0.38	2.74
NLCD Shrub / Scrub	Miles	0.79	0.30	1.19	0.45	0.00	0.00	0.07	0.02	0.45	0.30	0.98
NLCD Cultivated Crops	Miles	0.06	2.65	0.06	2.65	0.00	0.00	0.06	2.65	0.13	0.08	2.83
Total Agriculture and Open Lands	Miles	26.18	36.76	24.40	47.31	1.02	0.62	13.08	16.87	17.13	17.37	65.67
Forested Areas	Miles	31.11	21.22	52.18	31.15	2.23	1.49	11.55	6.57	17.50	20.13	55.98
Urban/Developed Areas	Miles	1.14	1.80	2.00	2.27	0.11	0.06	0.65	1.34	1.69	1.16	3.72
Structures												
K-12 Schools, Colleges and Universities												
0-100 ft	Number	0	0	0	0	0	0	0	0	0	0	0
100-250 ft	Number	0	0	0	0	0	0	0	0	0	0	0
250-500 ft	Number	0	0	0	0	0	0	0	0	0	0	0
500-1,000 ft	Number	0	0	0	0	0	0	0	0	0	0	0
Churches												
0-100 ft	Number	0	0	0	0	0	0	1	0	0	0	0
100-250 ft	Number	0	0	0	0	0	0	0	0	0	0	0
250-500 ft	Number	0	0	0	0	0	0	0	0	1	1	1
500-1,000 ft	Number	1	1	0	1	0	0	2	0	0	0	1
Hospitals												
0-100 ft	Number	0	0	0	0	0	0	0	0	0	0	0
100-250 ft	Number	0	0	0	0	0	0	0	0	0	0	0
250-500 ft	Number	0	0	0	0	0	0	0	0	0	0	0
500-1,000 ft	Number	0	0	0	0	0	0	0	0	0	0	0
Residences												
0-100 ft	Number	4	0	7	0	1	0	3	0	2	0	0
100-250 ft	Number	14	14	19	15	2	0	2	3	5	5	20
250-500 ft	Number	83	69	80	77	3	2	60	16	40	36	118
500-1,000 ft	Number	165	187	182	211	34	13	145	63	154	100	345

Table 3 5
Region 4 Tier IV Criteria Comparison

Criterion	Unit	AR 4 A (58.59 miles)	Corresponding Links of APR (60.35 miles)	AR 4 B (78.89 miles)	Corresponding Links of APR (81.52 miles)	AR 4 C (3.37 miles)	Corresponding Links of APR (2.16 miles)	AR 4 D (25.36 miles)	Corresponding Links of APR (25.37 miles)	AR 4 E (36.86 miles)	Corresponding Links of APR (38.86 miles)	APR Total in Region 4 (126.67 miles)
Agricultural, Commercial, and Industrial Structures												
0-100 ft	Number	7	2	10	2	0	0	6	2	3	1	3
100-250 ft	Number	17	4	21	9	0	0	11	3	14	9	18
250-500 ft	Number	51	16	61	26	0	1	38	10	27	28	54
500-1,000 ft	Number	131	56	157	90	1	5	77	38	93	59	152
Government Jurisdictions												
Cities and Towns	Miles	0.00	2.36	0.00	2.63	0.00	0.00	0.00	2.38	2.24	0.00	3.20
National Forests (U.S. Forest Service) - Administrative Boundary	Miles	0.00	0.00	10.65	0.00	0.00	0.00	0.00	0.00	0.00	0.00	0.00
National Forests (U.S. Forest Service) - Owned	Miles	0.00	0.00	4.21	0.00	0.00	0.00	0.00	0.00	0.00	0.00	0.00
National Wildlife Refuges (USFWS)	Miles	0.00	0.00	0.00	0.00	0.00	0.00	0.00	0.00	0.00	0.00	0.00
National Parks (National Park Service)	Miles	0.00	0.00	0.00	0.00	0.00	0.00	0.00	0.00	0.00	0.00	0.00
USACE Lands	Miles	0.00	0.00	0.00	0.00	0.00	0.00	0.00	0.00	0.00	0.00	1.16
DOD Lands	Miles	0.00	0.00	0.00	0.00	0.00	0.00	0.00	0.00	0.00	0.00	0.00
State Parks												
Oklahoma State Parks (Oklahoma Tourism and Recreation Department)	Miles	0.00	0.00	0.00	0.00	0.00	0.00	0.00	0.00	0.00	0.00	0.00
Arkansas State Parks (Arkansas Department of Parks and Tourism)	Miles	0.00	0.00	0.00	0.00	0.00	0.00	0.00	0.00	0.00	0.00	0.00
Tennessee State Parks (Tennessee Department of Environment and Conservation, Division of Parks and Conservation, State Parks)	Miles	0.00	0.00	0.00	0.00	0.00	0.00	0.00	0.00	0.00	0.00	0.00
State-Owned WMAs												
Oklahoma WMAs (Oklahoma Department of Wildlife Conservation)	Miles	0.00	0.00	0.00	0.00	0.00	0.00	0.00	0.00	0.00	0.00	0.00
Arkansas WMAs (Arkansas Game and Fish Commission)	Miles	0.00	0.00	0.00	0.00	0.00	0.00	0.00	0.00	0.00	0.00	0.00
Tennessee WMAs (Tennessee Wildlife Resources Agency)	Miles	0.00	0.00	0.00	0.00	0.00	0.00	0.00	0.00	0.00	0.00	0.00
Arkansas Leased WMAs (Arkansas Game and Fish Commission)	Miles	0.00	0.10	9.46	0.10	0.00	0.00	0.00	0.10	0.00	0.00	0.10
Oklahoma School Lands (The Commissioners of the Land Office)	Miles	0.00	0.00	0.00	0.00	0.00	0.00	0.00	0.00	0.00	0.00	0.00
Arkansas Natural Areas (Arkansas Natural Heritage Commission)	Miles	0.00	0.00	0.00	0.00	0.00	0.00	0.00	0.00	0.00	0.00	0.00
Tennessee Natural Areas (Tennessee Department of Environment and Conservation, Division of Natural Areas, Natural Areas Program)	Miles	0.00	0.00	0.00	0.00	0.00	0.00	0.00	0.00	0.00	0.00	0.00

Table 3 5
Region 4 Tier IV Criteria Comparison

Criterion	Unit	AR 4 A (58.59 miles)	Corresponding Links of APR (60.35 miles)	AR 4 B (78.89 miles)	Corresponding Links of APR (81.52 miles)	AR 4 C (3.37 miles)	Corresponding Links of APR (2.16 miles)	AR 4 D (25.36 miles)	Corresponding Links of APR (25.37 miles)	AR 4 E (36.86 miles)	Corresponding Links of APR (38.86 miles)	APR Total in Region 4 (126.67 miles)
County-, City-, and Town-owned Lands that are managed for conservation or recreation	Miles	0.00	0.00	0.00	0.00	0.00	0.00	0.00	0.00	0.00	0.00	0.00
Tribal Trust Lands and Allotments	Miles	0.00	0.00	0.00	0.00	0.00	0.00	0.00	0.00	0.00	0.00	0.37
Conservation Easements or Areas												
Federal Conservation Easements	Miles	0.00	0.00	0.00	0.00	0.00	0.00	0.00	0.00	0.00	0.00	0.00
State Conservation Easements	Miles	0.00	0.00	0.00	0.00	0.00	0.00	0.00	0.00	0.00	0.00	0.00
TNC Conservation Easements	Miles	0.00	0.00	0.00	0.00	0.00	0.00	0.00	0.00	0.00	0.00	0.00
Soil, Geologic, or Topographic Resources												
Prime Farmland	Miles	10.67	22.35	12.05	28.10	0.53	0.31	6.63	14.77	17.70	19.20	48.35
Farmlands of Statewide Importance	Miles	2.13	3.97	2.24	6.06	0.22	0.00	1.41	3.72	4.11	3.33	9.04
Slopes Greater than 20%	Miles	7.44	3.27	11.52	4.18	0.27	0.45	3.21	0.87	2.61	4.48	9.56
Karst Areas	Miles	34.81	21.12	42.85	21.12	3.37	2.16	22.58	5.58	0.00	0.00	27.67
Airport / Airfields												
Military Airports	Miles	0.00	0.00	0.00	1.00	0.00	0.00	0.00	0.00	0.00	0.00	1
FAA-Registered Public Airports	Number	0	0	0	1	0	0	0	0	0	0	1
FAA-Registered Private Airports	Number	1	1	1	1	0	0	0	1	0	0	1
Other Private Airstrips and Helipads	Number	0	0	0	0	0	0	0	0	0	0	0
Biological Resources												
USFWS-Designated Critical Habitat	Miles	0.00	0.00	0.00	0.00	0.00	0.00	0.00	0.00	0.00	0.00	0.00
Native Prairies	Miles	0.00	0.00	0.00	0.00	0.00	0.00	0.00	0.00	0.00	0.00	0.00
State Natural Heritage Program Species Location Data – Occurrence Records	Number	2	8	1	9	0	0	2	1	2	0	11
Arkansas Natural Heritage Program Species Location Data – Focal Areas	Miles	0.00	0.00	0.00	0.00	0.00	0.00	0.00	0.00	0.00	0.00	0.00
Arkansas Natural Heritage Program Species Location Data – Sensitive Streams	Number	0	0	0	0	0	0	0	0	0	0	0
Arkansas Natural Heritage Program Species Location Data – Designated Streams	Number	0	0	0	0	0	0	0	0	0	0	0
LEPC Potential Habitat - ODWC	Miles	0.00	0.00	0.00	0.00	0.00	0.00	0.00	0.00	0.00	0.00	0.00
LEPC Potential Habitat - WGA SGP	Miles	0.00	0.00	0.00	0.00	0.00	0.00	0.00	0.00	0.00	0.00	0.00
LEPC Potential Habitat - WGA SGP CHAT - Rank 1	Miles	0.00	0.00	0.00	0.00	0.00	0.00	0.00	0.00	0.00	0.00	0.00
LEPC Potential Habitat - WGA SGP CHAT - Ranks 2 and 3	Miles	0.00	0.00	0.00	0.00	0.00	0.00	0.00	0.00	0.00	0.00	0.00
Existing Impacted Areas within LEPC Habitat - CHAT Rank 1	Miles	0.00	0.00	0.00	0.00	0.00	0.00	0.00	0.00	0.00	0.00	0.00
Existing Impacted Areas within LEPC Habitat - CHAT Ranks 2 and 3	Miles	0.00	0.00	0.00	0.00	0.00	0.00	0.00	0.00	0.00	0.00	0.00
Existing Impacted Areas within LEPC Habitat - OLEPCSPT Ranks 4-8	Miles	0.00	0.00	0.00	0.00	0.00	0.00	0.00	0.00	0.00	0.00	0.00

Table 3.5
Region 4 Tier IV Criteria Comparison

Criterion	Unit	AR 4 A (58.59 miles)	Corresponding Links of APR (60.35 miles)	AR 4 B (78.89 miles)	Corresponding Links of APR (81.52 miles)	AR 4 C (3.37 miles)	Corresponding Links of APR (2.16 miles)	AR 4 D (25.36 miles)	Corresponding Links of APR (25.37 miles)	AR 4 E (36.86 miles)	Corresponding Links of APR (38.86 miles)	APR Total in Region 4 (126.67 miles)
GRPC Potential Habitat: ODWC OGRPCST	Miles	0.00	0.00	0.00	0.00	0.00	0.00	0.00	0.00	0.00	0.00	0.00
Whooping Crane Migratory Stopover Locations	Miles	0.00	0.00	0.00	0.00	0.00	0.00	0.00	0.00	0.00	0.00	0.00
Ozark Big-Eared Bat Potential Occurrence Areas	Miles	58.59	60.55	78.89	81.52	3.37	2.16	25.36	25.37	4.28	4.24	88.48
Indiana Bat Potential Occurrence Areas	Miles	31.08	31.15	34.22	35.34	0.00	0.00	0.00	0.00	28.92	27.93	68.02
Gray Bat Potential Occurrence Areas	Miles	31.08	31.15	34.22	35.34	0.00	0.00	0.00	0.00	3.66	6.69	50.35
Known Bat Caves	Number	0	0	0	0	0	0	0	0	0	0	0
American Burying Beetle Potential Occurrence Areas	Miles	31.59	31.08	52.30	51.57	0.00	0.00	1.11	0.54	3.99	4.01	61.19
Water Resources												
NW1 Forested Wetlands	Miles	0.15	0.35	0.18	0.35	0.00	0.00	0.00	0.00	0.00	0.00	0.41
NW1 Non-Forested Wetlands	Miles	0.00	0.06	0.00	0.06	0.00	0.00	0.00	0.00	0.00	0.00	0.06
NW1 Forested Wetland Crossings >1,000 ft	Number	0	0	0	0	0	0	0	0	0	0	0
NW1 Non-Forested Wetland Crossings >1,000 ft	Number	0	0	0	0	0	0	0	0	0	0	0
NLCD Forested Wetlands	Miles	0.11	0.70	0.21	0.72	0.00	0.00	0.02	0.55	0.54	0.14	0.90
NLCD Non-Forested Wetlands	Miles	0.04	0.02	0.04	0.02	0.00	0.00	0.04	0.02	0.00	0.02	0.04
NLCD Forested Wetland Crossings >1,000 ft	Number	0	0	0	0	0	0	0	0	0	0	0
NLCD Non-Forested Wetland Crossings >1,000 ft	Number	0	0	0	0	0	0	0	0	0	0	0
Floodplains - Length Crossed	Miles	5.32	16.76	4.35	16.92	0.00	0.00	2.00	12.75	2.77	3.98	22.43
Floodplains - Crossings Greater than 1,000 ft	Number	6	22	5	22	0	0	3	14	5	4	28
Major Waterbodies and Reservoirs - Number Intersected	Number	3	2	2	2	0	0	2	1	1	1	4
Major Waterbodies and Reservoirs - Distance Crossed	Miles	0.15	0.15	0.24	0.15	0.00	0.00	0.05	0.11	0.04	0.03	0.43
State-Designated Waterbodies with Special Significance	Number	6	3	6	3	0	0	1	1	1	1	5
Other Waterbodies	Number	19	20	10	24	4	2	3	8	10	5	30
Springs 0-250 ft	Number	0	0	0	0	0	0	0	0	0	0	0
Springs 250-500 ft	Number	0	0	0	0	0	0	2	0	0	0	0
Wild and Scenic Rivers	Number	1	1	1	1	0	0	1	1	1	1	2
Visual / Cultural Resources												
Federally and State-Designated Scenic Routes, Trails, and Byways	Number	5	7	6	9	2	2	5	5	4	2	11
Sites on the NRHP	Number	0	0	0	0	0	0	0	0	2	0	0

Table 3.5
Region 4 Tier IV Criteria Comparison

Criterion	Unit	AR 4 A (58.59 miles)	Corresponding Links of APR (60.55 miles)	AR 4 B (78.89 miles)	Corresponding Links of APR (81.52 miles)	AR 4 C (3.37 miles)	Corresponding Links of APR (2.16 miles)	AR 4 D (25.36 miles)	Corresponding Links of APR (25.37 miles)	AR 4 E (36.86 miles)	Corresponding Links of APR (38.86 miles)	APR Total in Region 4 (126.67 miles)
Recorded Cultural or Historical Sites												
Archaeological Sites	Number	3	25	1	26	0	0	5	12	9	1	27
GLO Sites	Number	0	0	0	0	0	0	0	0	0	0	2
Historical Sites	Number	0	0	0	1	0	0	1	0	2	0	1
Total Recorded Cultural or Historical Sites	Number	3	25	1	27	0	0	6	12	11	1	30
Cemeteries	Number	1	1	1	1	0	0	0	0	3	2	3
Environmentally Regulated Sites												
Known Contaminated Sites	Number	0	0	0	0	0	0	0	0	0	0	0.00
Engineering Considerations												
Total Length of the Transmission Line	Miles	58.59	60.55	78.89	81.52	3.37	2.16	25.36	25.37	36.86	38.86	126.67
Electrical Transmission Line Crossings												
69kV-345kV intersected by the representative centerline	Number	3	9	1	12	0	1	2	4	8	2	18
Greater than 345kV intersected by the representative centerline	Number	1	1	0	2	0	0	0	0	0	0	3
Transmission Pipeline Crossings	Number	0	4	5	10	1	1	1	4	7	3	12
Major Road Crossings	Number	4	6	4	6	0	0	3	5	2	0	6
Railroad ROW Crossings	Number	3	4	3	4	0	0	1	3	0	0	5

Notes:

1. Miles of existing infrastructure are determined by measuring the length of the representative centerline intersection with a 500-foot buffer to each side of existing infrastructure. Crossings of existing infrastructure are included in this total and can add approximately 1,000 to 1,500 feet of length per crossing, depending on the angle of intersection. The Engineering Considerations section presents the number of crossings for each type of existing infrastructure. The Routing team considered this additional length during the route identification process, and Paired-Node Analyses.

Key:

APR = Applicant Proposed Route.
AR = Alternative Route.
DOD = (United States) Department of Defense.
FAA = Federal Aviation Administration.
ft = feet.
GLO = General Land Office.

GRPC = greater prairie-chicken.
KV = kilovolt(s).
LEPC = lesser prairie-chicken.
NLCD = National Land Cover Dataset.
NRRP = National Register of Historic Places.
NWI = National Wetlands Inventory.

ODWC = Oklahoma Department of Wildlife Conservation.
OGRPCSPT = Oklahoma Greater Prairie-Chicken Spatial Planning Tool.
OLEPCSPT = Oklahoma Lesser Prairie-Chicken Spatial Planning Tool.
ROW = right-of-way.
SGP CHAT = Southern Great Plains Crucial Habitat Assessment Tool.
TNC = The Nature Conservancy.

USACE = United States Army Corps of Engineers.
USFWS = United States Fish and Wildlife Service.
WGA = Western Governors' Association.
WMA = Wildlife Management Area.

This page intentionally left blank.

3.3.3.5 Region 5 (Central Arkansas)

Region 5 begins approximately 13 miles north of Russellville, in Pope County, Arkansas, continues east for a distance of approximately 113 miles through Pope, Conway, Van Buren, Faulkner, Cleburne, White, and Jackson counties, Arkansas, and terminates approximately 10 miles southwest of Newport, in Jackson County, Arkansas. Land cover in Region 5 comprises generally forested areas consisting of both mixed hardwoods and planted pine, open lands for pasture or cultivated crops, and rural residential development. Towns near the routes in this Region include Damascus, Quitman, Letona, Twin Groves, Guy, and Rose Bud.

Clean Line identified the Applicant Proposed Route and six Proposed Alternative Routes in Region 5. The locations of these routes are summarized below and illustrated on Figures 3-2k through 3-2n.

- **The Applicant Proposed Route** begins approximately 5 miles northwest of Dover, in Pope County, Arkansas, and traverses southeast across Pope County for approximately 19 miles. The route then turns east for approximately 65 miles and traverses through Conway, Van Buren, Cleburne, and White Counties, following parcel boundaries and section lines to the extent practicable. In White County, the route begins a northeast track, paralleling Entergy Arkansas, Inc.'s Independence-to-Genpower Keo 500kV electrical transmission line for approximately 4 miles, and then parallels a transmission pipeline for approximately 7 miles as it crosses into Jackson County. After crossing S.R. 87, the route continues east, following parcel boundaries, and then parallels an existing transmission pipeline for approximately 5 miles, to the northeast. The Applicant Proposed Route then terminates at the eastern boundary of Region 5.
- **Proposed Alternative Route 5-A** begins at the Applicant Proposed Route, at the western boundary of Region 5, west of Hector, in Pope County, Arkansas. Alternative Route 5-A then continues generally to the east and southeast for approximately 13 miles through Pope County before intersecting the Applicant Proposed Route south of the town of Hector, Arkansas. Alternative Route 5-A provides a northern route north of Dover, Arkansas.
- **Proposed Alternative Route 5-B** begins at the Applicant Proposed Route, approximately 2 miles west of where the Applicant Proposed Route intersects the Pope/Conway County line, and continues to the southeast for approximately 4 miles. The route then traverses east for approximately 8 miles before it parallels an existing transmission pipeline for approximately 9 miles. Proposed Alternative Route 5-B then continues east for approximately 47 miles through Conway, Faulkner, and White Counties, following a transmission pipeline and parcel boundaries to the extent practicable. Once the route enters White County, it begins a southeast and east stepped progression, following electrical transmission lines, parcel boundaries, and transmission pipelines for approximately 16 miles through White County. The route then turns northeast, east of S.R. 16, to parallel Entergy Arkansas, Inc.'s Independence-to-Genpower Keo 500kV electrical transmission line for approximately 5 miles before terminating at the Applicant Proposed Route, approximately 9 miles north of Searcy, in White County, Arkansas. Proposed Alternative Route 5-B provides a southern alternative in the vicinity of Damascus, Twin Groves, Guy, and Rosebud, Arkansas.
- **Proposed Alternative Route 5-C** begins at the Applicant Proposed Route approximately 1 mile northeast of Letona, Arkansas, and slightly east of Arkansas S.R. 16. It continues in a northeast direction for 3 miles and then generally parallels a transmission pipeline east of Clay, Arkansas, for approximately 3 miles. Proposed Alternative Route 5-C intersects with the Applicant Proposed Route approximately 0.3 miles east of Sunny Dale Road in White County, Arkansas. This route provides a northern alignment northeast of Letona, Arkansas.

- **Route Alternative Route 5-D** begins at the Applicant Proposed Route approximately 2 miles east-northeast of the community of Steprock, in White County, Arkansas, and then traverses northeast to meet Entergy Arkansas, Inc.'s Independence-to-Genpower Keo 500kV electrical transmission line, which it parallels for approximately 4 miles. At the White/Jackson County line, this route turns east, generally following parcel boundaries for 6 miles. Proposed Alternative Route 5-D bends south for approximately 3 miles before turning northeast to parallel transmission pipelines for 1 mile. This route then continues east for approximately 2 miles before turning northeast and following parcel boundaries to the extent practicable around an oxbow of the White River. After crossing the White River and U.S. Route 67, Proposed Alternative Route 5-D intersects with the Applicant Proposed Route at the eastern boundary of Region 5. This Proposed Alternative Route presents an alternative crossing of the White River.
- **Proposed Alternative Route 5-E** begins at the Applicant Proposed Route, approximately 6 miles east of Damascus and 8 miles southeast of the town of Bee Branch in Van Buren County, Arkansas. This route then traverses southeast, paralleling an existing transmission line for approximately 2 miles. At this location, approximately 3 miles northeast of Guy, in Faulkner County, this route converges with Proposed Alternative Route 5-B and shares a common alignment to its termination at the Applicant Proposed Route. This route provides an alternative that traverses Faulkner County to the south rather than Cleburne County.
- **Proposed Alternative Route 5-F** begins at the Applicant Proposed Route, east of S.R. 5 and approximately 3 miles northeast of Rose Bud, and traverses 1 mile south before converging with Proposed Alternative Route 5-B. This route shares the same alignment as Proposed Alternative Route 5-B until its termination at the Applicant Proposed Route. This route provides an alternative route south of Letona, Arkansas.

The key Tier IV criteria for each route are presented below. Table 3-6 compares the Tier IV criteria of each Proposed Alternative Route to the corresponding portion of the Applicant Proposed Route and summarizes the Tier IV criteria for the Applicant Proposed Route in Region 5. Figures 2-3 through 3-7 identify the Tier IV criteria in Region 5.

3.3.3.5.1 Applicant Proposed Route

The Applicant Proposed Route is 113.19 miles in length, with 35.03 miles (30.9%) of the route paralleling existing linear infrastructure. Land cover is dominated by forest lands (66.29 miles [58.6%]) and agricultural and open lands (42.72 [37.7%]), with urban lands (2.98 miles [2.6%]) making up most of the remaining land cover.

The Applicant Proposed Route is within 1,000 feet of 327 residences and within 250 feet of six residences; no residences are within 100 feet of the route. Two churches and no schools or hospitals are within 1,000 feet of the route. The Applicant Proposed Route traverses 0.30 mile of the Quitman, Arkansas, municipal boundaries. Additionally, the route traverses 3.24 miles (2.9%) of a leased Arkansas WMA, Cherokee WMA. The route traverses 42.18 miles (37.3%) of prime farmland soils.

The Applicant Proposed Route traverses 33.77 miles (29.8%) of lands the USFWS has documented as having a potential for occurrence of the of the gray bat.

The Applicant Proposed Route crosses one major waterbody (the White River) and 28 other waterbodies. The Applicant Proposed Route traverses 0.19 mile (0.2%) of NWI-identified forested wetlands and an additional 0.05 mile (0.04%) of NWI-identified non-forested wetlands. None of these crossings of NWI-identified wetlands is more than 1,000 feet in length. Additionally, the route traverses 4.52 miles (4.0%) of 100-year floodplain, with no crossing more than 1,000 feet in length.

No NRHP sites and 42 recorded cultural sites are within 0.25 mile of the Applicant Proposed Route.

3.3.3.5.2 Proposed Alternative Route 5-A

Proposed Alternative Route 5-A is 12.65 miles in length, with 0.98 mile (7.7%) paralleling existing linear infrastructure. Land cover is dominated by forested lands (9.31 miles [73.6%]), with agricultural and open lands (2.90 miles [22.9%]) and urban lands (0.44 mile [3.4%]) making up most of the remaining land cover.

Proposed Alternative Route 5-A is within 1,000 feet of 54 residences and within 250 feet of one residence; no residences are within 100 feet of the route. No schools, churches, or hospitals are within 1,000 feet of the route.

The route traverses 10.95 miles (86.6%) of prime farmland soils.

Proposed Alternative Route 5-A traverses 12.65 miles (100%) of lands the USFWS has documented as having a potential for occurrence of the gray bat.

Proposed Alternative Route 5-A crosses one major waterbody (Illinois Bayou) and no additional other waterbodies. No NWI-identified wetlands are traversed by Proposed Alternative Route 5-A. Additionally, the route traverses 0.58 mile (4.6%) of a 100-year floodplain, but the crossing is less than 1,000 feet in length.

No NRHP sites or recorded cultural or historical sites are within 0.25 mile of Proposed Alternative Route 5-A.

Table 3-6 compares the Tier IV criteria of each Proposed Alternative Route with the corresponding portion of the Applicant Proposed Route and summarizes the Tier IV criteria for the Applicant Proposed Route in Region 5. In summary, Clean Line chose the Applicant Proposed Route rather than Proposed Alternative Route 5-A because it:

- Has 18 fewer residences within 1,000 feet.

3.3.3.5.3 Proposed Alternative Route 5-B

Proposed Alternative Route 5-B is 71.20 miles in length, with 37.58 miles (52.8%) paralleling existing linear infrastructure. Land cover is dominated by forested lands (36.39 miles [51.1%]) and agricultural and open lands (33.00 miles [46.3%]), with urban lands (1.60 miles [2.2%]) making up most of the remaining land cover.

Proposed Alternative Route 5-B is within 1,000 feet of 236 residences, within 250 feet of six residences, and within 100 feet of two residences. One church is within 500 feet of Proposed Alternative Route 5-B. No schools or hospitals are within 1,000 feet of the route. Proposed Alternative Route 5-B traverses 2.13 miles of the Guy, Arkansas, municipal boundaries.

The route traverses 34.51 miles (48.5%) of prime farmland soils.

Proposed Alternative Route 5-B traverses 2.85 miles (4%) of lands the USFWS has documented as having a potential for occurrence of the gray bat.

Proposed Alternative Route 5-B crosses 13 waterbodies, but no major waterbody. Additionally, this route does not traverse any NWI-identified wetlands. Proposed Alternative Route 5-B traverses 6.56 miles (9.2%) of 100-year floodplain, with six crossings more than 1,000 feet in length.

One NRHP site (the Charlie Hall House in Twin Groves, Arkansas) and 43 recorded cultural or historical sites are within 0.25 mile of Proposed Alternative Route 5-B.

Table 3-6 compares the Tier IV criteria of each Proposed Alternative Route with the corresponding portion of the Applicant Proposed Route and summarizes the Tier IV criteria for the Applicant Proposed Route in Region 5. In summary, Clean Line chose the Applicant Proposed Route rather than Proposed Alternative Route 5-B because Applicant Proposed Route:

- Has 56 fewer residences within 1,000 feet;
- Traverses fewer miles within municipal boundaries;
- Traverses fewer miles of prime farmland soils;
- Crosses fewer miles of floodplain; and
- Is not within 0.25 mile of any NRHP sites.

3.3.3.5.4 Proposed Alternative Route 5-C

Proposed Alternative Route 5-C is 9.20 miles in length, with 5.69 miles (61.8%) paralleling existing linear infrastructure. Land cover is dominated by forested lands (6.00 miles [65.2%]), with agricultural and open lands (3.05 miles [33.1%]) and urban lands (0.16 mile [1.7%]) making up most of the remaining land cover.

Proposed Alternative Route 5-C is within 1,000 feet of 55 residences, with one residence lying within 100 feet of the route. No schools, churches, or hospitals are within 1,000 feet of the route.

The route traverses 6.24 miles (67.8%) of prime farmland soils.

Proposed Alternative Route 5-C crosses one major waterbody (Red River). Additionally, the route does not traverse any NWI-identified wetlands. The route traverses 0.79 mile (8.6%) of 100-year floodplain, with one crossing more than 1,000 feet in length.

No NRHP sites and 11 recorded cultural sites are within 0.25 mile of Proposed Alternative Route 5-C.

Table 3-6 compares the Tier IV criteria of each Proposed Alternative Route with the corresponding portion of the Applicant Proposed Route and summarizes the Tier IV criteria for the Applicant Proposed Route in Region 5. In summary, Clean Line chose the Applicant Proposed Route rather than Proposed Alternative Route 5-C because the Applicant Proposed Route:

- Parallels more linear infrastructure;
- Has 19 fewer residences within 1,000 feet; and
- Traverses less prime farmland soils.

3.3.3.5.5 Proposed Alternative Route 5-D

Proposed Alternative Route 5-D is 21.74 miles in length, with 6.69 miles (30.8%) paralleling existing linear infrastructure. Land cover is dominated by forested lands (14.03 miles [64.5%]), with agricultural and open lands (5.88 miles [27.0%]) and urban lands (0.97 mile [4.5%]) making up most of the remaining land cover.

Proposed Alternative Route 5-D is within 1,000 feet of 107 residences and within 250 feet of four residences; no residences are within 100 feet of the route. No schools, churches, or hospitals are within 1,000 feet of the route.

The route traverses 8.05 miles (37.0%) of prime farmland soils.

Proposed Alternative Route 5-D crosses one major waterbody (the White River) and four other waterbodies. The route traverses 0.22 mile (1.0%) of NWI-identified forested wetlands and an additional 0.04 mile (0.2%) of NWI-identified non-forested wetlands. None of these crossings of NWI-identified wetland are more than 1,000 feet in length. Additionally, the route traverses 0.17 mile (0.78%) of 100-year floodplain, with no crossing more than 1,000 feet in width.

No NRHP sites and 15 recorded cultural sites are within 0.25 mile of Proposed Alternative Route 5-D. Additionally, one cemetery is within 500 feet of the route.

Table 3-6 compares the Tier IV criteria of each Proposed Alternative Route with the corresponding portion of the Applicant Proposed Route and summarizes the Tier IV criteria for the Applicant Proposed Route in Region 5. In summary, Clean Line chose the Applicant Proposed Route rather than Proposed Alternative Route 5-D because the Applicant Proposed Route:

- Traverses fewer miles of forested land,
- Has 31 fewer residences within 1,000 feet, and
- Crosses fewer miles of floodplain.

Additionally, the Applicant Proposed Route crosses the White River while paralleling an existing transmission line and in proximity to where U.S. Highway 67 traverses the White River, while Proposed Alternative Route 5-D crosses the White River at a location where no other linear infrastructure is nearby.

3.3.3.5.6 Proposed Alternative Route 5-E

Proposed Alternative Route 5-E is 36.36 miles in length, with 18.51 miles (50.9%) paralleling existing linear infrastructure. Land cover is dominated by forested lands (18.07 miles [49.7%]) and agricultural and open lands (17.58 miles [48.3%]), with urban lands (0.71 mile [1.9%]) making up most of the remaining land cover.

Proposed Alternative Route 5-E is within 1,000 feet of 89 residences, within 250 feet of two residences, and within 100 feet of two residences. One church is within 500 feet of the route, but no schools or hospitals are within 1,000 feet of the route.

The route traverses 18.17 miles (49.9%) of prime farmland soils.

Proposed Alternative Route 5-E traverses 0.4 mile (2.5%) of lands the USFWS has documented as having a potential for occurrence of the gray bat.

Proposed Alternative Route 5-E crosses five other waterbodies and one major waterbody (Cadron Creek). The route does not traverse any NWI-identified wetlands. Additionally, the route traverses 3.83 miles (10.5%) of 100-year floodplain, with four crossings more than 1,000 feet in length.

No NRHP sites and nine recorded cultural sites are within 0.25 mile of Proposed Alternative Route 5-E.

Table 3-6 compares the Tier IV criteria of each Proposed Alternative Route with the corresponding portion of the Applicant Proposed Route and summarizes the Tier IV criteria for the Applicant Proposed Route in Region 5. In summary, Clean Line chose the Applicant Proposed Route rather than Proposed Alternative Route 5-E because the Applicant Proposed Route:

- Traverses fewer miles of forested lands;
- Traverses fewer miles of prime farmland soils; and
- Traverses fewer miles of floodplain.

3.3.3.5.7 Proposed Alternative Route 5-F

Proposed Alternative Route 5-F is 22.36 miles in length, with 8.01 miles (35.8%) paralleling existing linear infrastructure. Land cover is dominated by forested lands (11.76 miles [52.6%]) and agricultural and open lands (10.09 miles [45.1%]), with urban lands (0.52 mile [2.3%]) making up most of the remaining land cover.

Proposed Alternative Route 5-F is within 1,000 feet of 56 residences, within 250 feet of two residences, and within 100 feet of two residences. No schools, churches, or hospitals are within 1,000 feet of the route.

The route traverses 11.73 miles (52.5%) of prime farmland soils.

Proposed Alternative Route 5-F crosses one waterbody, but no major waterbody. The route does not traverse any NWI-identified wetlands. The route traverses 3.09 miles (13.8%) of 100-year floodplain, with two crossings more than 1,000 feet in length.

No NRHP sites and six recorded cultural or historical sites are within 0.25 mile of Proposed Alternative Route 5-F.

Table 3-6 compares the Tier IV criteria of each Proposed Alternative Route with the corresponding portion of the Applicant Proposed Route and summarizes the Tier IV criteria for the Applicant Proposed Route in Region 5. In summary, Clean Line chose the Applicant Proposed Route rather than Proposed Alternative Route 5-F because the Applicant Proposed Route:

- Crosses fewer miles of prime farmland soil, and
- Traverses less floodplain.

Table 3 6
Region 5 Tier IV Criteria Comparison

Criterion	Unit	AR 5 A (12.65 miles)	Corresponding Links of APR (12.31 miles)	AR 5 B (71.20 miles)	Corresponding Links of APR (67.37 miles)	AR 5 C (9.20 miles)	Corresponding Links of APR (9.40 miles)	AR 5 D (21.74 miles)	Corresponding Links of APR (20.52 miles)	AR 5 E (36.36 miles)	Corresponding Links of APR (33.26 miles)	AR 5 F (22.36 miles)	Corresponding Links of APR (18.82 miles)	APR Total in Region 5 (13.19 miles)
Existing Infrastructure¹														
Electrical Transmission Lines (69 kV and higher)	Miles	0.00	0.00	6.18	1.52	0.41	4.62	4.46	0.24	5.94	1.32	5.68	0.65	6.21
Transmission Pipelines	Miles	0.76	0.00	32.26	19.94	4.99	2.10	2.66	4.38	13.61	13.13	3.34	6.81	24.73
Railroads	Miles	0.00	0.00	0.00	0.00	0.00	0.00	0.27	0.23	0.00	0.00	0.00	0.00	0.23
Publically Maintained Federal, State, and County Roads	Miles	0.39	0.38	2.69	2.26	0.39	0.47	1.08	3.92	1.50	1.03	0.67	0.23	7.04
Total Paralleling Existing Linear Infrastructure	Miles	0.98	0.38	37.58	22.46	5.69	6.92	6.69	6.98	18.51	14.58	8.01	7.52	35.03
Land Cover														
Parcels and Parcel Boundaries	Number	61	66	220	204	42	52	108	110	102	53	90	33	463.00
Agriculture and Open Lands														
NLCD Pasture / Hay	Miles	2.15	2.04	29.61	24.40	2.89	3.02	1.33	4.01	15.41	13.92	8.35	5.54	32.21
NLCD Barren Land	Miles	0.00	0.00	0.18	0.19	0.00	0.00	0.01	0.00	0.13	0.19	0.12	0.00	0.19
NLCD Grassland / Herbaceous	Miles	0.65	0.47	1.10	2.27	0.14	0.10	0.83	0.29	0.38	1.42	0.31	1.05	3.26
NLCD Shrub / Scrub	Miles	0.11	0.06	0.23	0.42	0.00	0.00	0.00	0.00	0.00	0.14	0.00	0.14	0.48
NLCD Cultivated Crops	Miles	0.00	0.00	1.87	0.84	0.02	0.06	3.71	5.75	1.66	0.33	1.31	0.33	6.59
Total Agriculture and Open Lands	Miles	2.90	2.56	33.00	28.11	3.05	3.18	5.88	10.04	17.58	16.00	10.09	7.07	42.72
Forested Areas	Miles	9.31	9.50	36.39	37.51	6.00	5.67	14.03	8.45	18.07	16.37	11.76	11.11	66.29
Urban/Developed Areas	Miles	0.44	0.25	1.60	1.36	0.16	0.21	0.97	1.24	0.71	0.57	0.52	0.32	2.98
Structures														
K-12 Schools, Colleges and Universities														
0-100 ft	Number	0	0	0	0	0	0	0	0	0	0	0	0	0
100-250 ft	Number	0	0	0	0	0	0	0	0	0	0	0	0	0
250-500 ft	Number	0	0	0	0	0	0	0	0	0	0	0	0	0
500-1,000 ft	Number	0	0	0	0	0	0	0	0	0	0	0	0	0
Churches														
0-100 ft	Number	0	0	0	0	0	0	0	0	0	0	0	0	0
100-250 ft	Number	0	0	0	0	0	0	0	0	0	0	0	0	0
250-500 ft	Number	0	0	1	0	0	0	0	0	1	0	0	0	0
500-1,000 ft	Number	0	0	0	1	0	0	0	0	0	0	0	0	2.00
Hospitals														
0-100 ft	Number	0	0	0	0	0	0	0	0	0	0	0	0	0
100-250 ft	Number	0	0	0	0	0	0	0	0	0	0	0	0	0
250-500 ft	Number	0	0	0	0	0	0	0	0	0	0	0	0	0
500-1,000 ft	Number	0	0	0	0	0	0	0	0	0	0	0	0	0

Table 3 6
Region 5 Tier IV Criteria Comparison

Criterion	Unit	AR 5 A (12.65 miles)	Corresponding Links of APR (12.31 miles)	AR 5 B (71.20 miles)	Corresponding Links of APR (67.37 miles)	AR 5 C (9.20 miles)	Corresponding Links of APR (9.40 miles)	AR 5 D (21.74 miles)	Corresponding Links of APR (20.52 miles)	AR 5 E (36.36 miles)	Corresponding Links of APR (33.26 miles)	AR 5 F (22.36 miles)	Corresponding Links of APR (18.82 miles)	APR Total in Region 5 (13.19 miles)
Residences														
0-100 ft	Number	0	0	2	0	1	0	0	0	2	0	2	0	0
100-250 ft	Number	1	0	6	3	0	1	4	2	2	1	2	1	6
250-500 ft	Number	15	9	47	43	10	12	30	9	18	31	16	14	72
500-1,000 ft	Number	38	27	181	134	44	23	73	65	71	87	36	39	249
Agricultural, Commercial, and Industrial Structures														
0-100 ft	Number	0	0	3	0	1	0	0	0	2	0	0	0	1
100-250 ft	Number	0	1	15	10	0	0	0	0	4	6	2	2	11
250-500 ft	Number	14	12	58	28	3	2	6	1	16	19	6	7	43
500-1,000 ft	Number	30	18	134	105	6	4	17	9	50	62	28	26	144
Government Jurisdictions														
Cities and Towns	Miles	0.00	0.00	2.13	0.30	0.00	0.00	0.00	0.00	0.00	0.30	0.00	0.00	0.30
National Forests (U.S. Forest Service) - Administrative Boundary	Miles	0.00	0.00	0.00	0.00	0.00	0.00	0.00	0.00	0.00	0.00	0.00	0.00	0.00
National Forests (U.S. Forest Service) - Owned	Miles	0.00	0.00	0.00	0.00	0.00	0.00	0.00	0.00	0.00	0.00	0.00	0.00	0.00
National Wildlife Refuges (USFWS)	Miles	0.00	0.00	0.00	0.00	0.00	0.00	0.00	0.00	0.00	0.00	0.00	0.00	0.00
National Parks (National Park Service)	Miles	0.00	0.00	0.00	0.00	0.00	0.00	0.00	0.00	0.00	0.00	0.00	0.00	0.00
USACE Lands	Miles	0.00	0.00	0.00	0.00	0.00	0.00	0.00	0.00	0.00	0.00	0.00	0.00	0.00
DOD Lands	Miles	0.00	0.00	0.00	0.00	0.00	0.00	0.00	0.00	0.00	0.00	0.00	0.00	0.00
State Parks														
Oklahoma State Parks (Oklahoma Tourism and Recreation Department)	Miles	0.00	0.00	0.00	0.00	0.00	0.00	0.00	0.00	0.00	0.00	0.00	0.00	0.00
Arkansas State Parks (Arkansas Department of Parks and Tourism)	Miles	0.00	0.00	0.00	0.00	0.00	0.00	0.00	0.00	0.00	0.00	0.00	0.00	0.00
Tennessee State Parks (Tennessee Department of Environment and Conservation, Division of Parks and Conservation, State Parks)	Miles	0.00	0.00	0.00	0.00	0.00	0.00	0.00	0.00	0.00	0.00	0.00	0.00	0.00
State-Owned WMAs														
Oklahoma WMAs (Oklahoma Department of Wildlife Conservation)	Miles	0.00	0.00	0.00	0.00	0.00	0.00	0.00	0.00	0.00	0.00	0.00	0.00	0.00
Arkansas WMAs (Arkansas Game and Fish Commission)	Miles	0.00	0.00	0.00	0.00	0.00	0.00	0.00	0.00	0.00	0.00	0.00	0.00	0.00
Tennessee WMAs (Tennessee Wildlife Resources Agency)	Miles	0.00	0.00	0.00	0.00	0.00	0.00	0.00	0.00	0.00	0.00	0.00	0.00	0.00
Arkansas Leased WMAs (Arkansas Game and Fish Commission)	Miles	0.00	0.00	0.00	1.03	0.00	0.00	0.00	0.00	0.00	1.03	0.00	1.03	3.24
Oklahoma School Lands (The Commissioners of the Land Office)	Miles	0.00	0.00	0.00	0.00	0.00	0.00	0.00	0.00	0.00	0.00	0.00	0.00	0.00
Arkansas Natural Areas (Arkansas Natural Heritage Commission)	Miles	0.00	0.00	0.00	0.00	0.00	0.00	0.00	0.00	0.00	0.00	0.00	0.00	0.00

Table 3.6
Region 5 Tier IV Criteria Comparison

Criterion	Unit	AR 5 A (12.65 miles)	Corresponding Links of APR (12.31 miles)	AR 5 B (71.20 miles)	Corresponding Links of APR (67.37 miles)	AR 5 C (9.20 miles)	Corresponding Links of APR (9.40 miles)	AR 5 D (21.74 miles)	Corresponding Links of APR (20.52 miles)	AR 5 E (36.36 miles)	Corresponding Links of APR (33.26 miles)	AR 5 F (22.36 miles)	Corresponding Links of APR (18.82 miles)	APR Total in Region 5 (113.19 miles)
Tennessee Natural Areas (Tennessee Department of Environment and Conservation, Division of Natural Areas, Natural Areas Program)	Miles	0.00	0.00	0.00	0.00	0.00	0.00	0.00	0.00	0.00	0.00	0.00	0.00	0.00
County-, City-, and Town-owned Lands that are managed for conservation or recreation	Miles	0.00	0.00	0.00	0.00	0.00	0.00	0.00	0.00	0.00	0.00	0.00	0.00	0.00
Tribal Trust Lands and Allotments	Miles	0.00	0.00	0.00	0.00	0.00	0.00	0.00	0.00	0.00	0.00	0.00	0.00	0.00
Conservation Easements or Areas														
Federal Conservation Easements	Miles	0.00	0.00	0.00	0.00	0.00	0.00	0.00	0.00	0.00	0.00	0.00	0.00	0.00
State Conservation Easements	Miles	0.00	0.00	0.00	0.00	0.00	0.00	0.00	0.00	0.00	0.00	0.00	0.00	0.00
TNC Conservation Easements	Miles	0.00	0.00	0.00	0.00	0.00	0.00	0.00	0.00	0.00	0.00	0.00	0.00	0.00
Soil, Geologic, or Topographic Resources														
Prime Farmland	Miles	10.95	9.03	34.51	19.93	6.24	5.81	8.05	7.24	18.17	11.92	11.73	7.40	42.18
Farmlands of Statewide Importance	Miles	0.28	0.88	2.37	2.53	0.41	0.36	0.04	0.41	1.89	1.14	1.87	0.45	4.28
Slopes Greater than 20%	Miles	2.46	2.79	4.79	5.06	0.43	0.50	0.46	0.37	2.11	1.43	1.59	1.30	11.25
Karst Areas	Miles	0.00	0.00	0.00	0.00	0.00	0.00	15.98	12.64	0.00	0.00	0.00	0.00	12.64
Airport / Airfields														
Military Airports	Miles	0.00	0.00	0.00	0.00	0.00	0.00	0.00	0.00	0.00	0.00	0.00	0.00	0.00
FAA-Registered Public Airports	Number	0	0	0	0	0	0	0	0	0	0	0	0	0
FAA-Registered Private Airports	Number	0	0	0	0	0	0	0	0	0	0	0	0	0
Other Private Airstrips and Helipads	Number	0	0	0	0	0	0	0	0	0	0	0	0	0
Biological Resources														
USFWS-Designated Critical Habitat	Miles	0.00	0.00	0.00	0.00	0.00	0.00	0.00	0.00	0.00	0.00	0.00	0.00	0.00
Native Prairies	Miles	0.00	0.00	0.00	0.00	0.00	0.00	0.00	0.00	0.00	0.00	0.00	0.00	0.00
State Natural Heritage Program Species Location Data – Occurrence Records	Number	0	0	3	7	0	0	0	0	1	4	1	3	7
Arkansas Natural Heritage Program Species Location Data – Focal Areas	Miles	0.00	0.00	0.00	0.00	0.00	0.00	0.00	0.00	0.00	0.00	0.00	0.00	0.00
Arkansas Natural Heritage Program Species Location Data – Sensitive Streams	Number	0	0	0	0	0	0	0	0	0	0	0	0	0
Arkansas Natural Heritage Program Species Location Data – Designated Streams	Number	0	0	0	0	0	0	0	0	0	0	0	0	0
LEPC Potential Habitat-ODWC	Miles	0.00	0.00	0.00	0.00	0.00	0.00	0.00	0.00	0.00	0.00	0.00	0.00	0.00
OLEPCSPT	Miles	0.00	0.00	0.00	0.00	0.00	0.00	0.00	0.00	0.00	0.00	0.00	0.00	0.00
LEPC Potential Habitat-WGA SGP	Miles	0.00	0.00	0.00	0.00	0.00	0.00	0.00	0.00	0.00	0.00	0.00	0.00	0.00
CHAT - Rank 1	Miles	0.00	0.00	0.00	0.00	0.00	0.00	0.00	0.00	0.00	0.00	0.00	0.00	0.00
LEPC Potential Habitat - WGA SGP CHAT - Ranks 2 and 3	Miles	0.00	0.00	0.00	0.00	0.00	0.00	0.00	0.00	0.00	0.00	0.00	0.00	0.00
Existing Impacted Areas within LEPC Habitat - CHAT Rank 1	Miles	0.00	0.00	0.00	0.00	0.00	0.00	0.00	0.00	0.00	0.00	0.00	0.00	0.00
Existing Impacted Areas within LEPC Habitat - CHAT Ranks 2 and 3	Miles	0.00	0.00	0.00	0.00	0.00	0.00	0.00	0.00	0.00	0.00	0.00	0.00	0.00

Table 3.6
Region 5 Tier IV Criteria Comparison

Criterion	Unit	AR 5 A (12.65 miles)	Corresponding Links of APR (12.31 miles)	AR 5 B (71.20 miles)	Corresponding Links of APR (67.37 miles)	AR 5 C (9.20 miles)	Corresponding Links of APR (9.40 miles)	AR 5 D (21.74 miles)	Corresponding Links of APR (20.52 miles)	AR 5 E (36.36 miles)	Corresponding Links of APR (33.26 miles)	AR 5 F (22.36 miles)	Corresponding Links of APR (18.82 miles)	APR Total in Region 5 (13.19 miles)
Existing Impacted Areas within LEPC Habitat - OLEPCSPT Ranks 4-8	Miles	0.00	0.00	0.00	0.00	0.00	0.00	0.00	0.00	0.00	0.00	0.00	0.00	0.00
GRPC Potential Habitat: ODWC OGRPCSPT	Miles	0.00	0.00	0.00	0.00	0.00	0.00	0.00	0.00	0.00	0.00	0.00	0.00	0.00
Whooping Crane Migratory Stopover Locations	Miles	0.00	0.00	0.00	0.00	0.00	0.00	0.00	0.00	0.00	0.00	0.00	0.00	0.00
Ozark Big-Eared Bat Potential Occurrence Areas	Miles	0.00	0.00	0.00	0.00	0.00	0.00	0.00	0.00	0.00	0.00	0.00	0.00	0.00
Indiana Bat Potential Occurrence Areas	Miles	0.00	0.00	0.00	0.00	0.00	0.00	0.00	0.00	0.00	0.00	0.00	0.00	0.00
Gray Bat Potential Occurrence Areas	Miles	12.66	12.31	2.85	15.02	0.00	0.00	0.00	0.00	0.40	2.61	0.00	0.00	33.77
Known Bat Caves	Number	0	0	0	0	0	0	0	0	0	0	0	0	0
American Burying Beetle Potential Occurrence Areas	Miles	0.00	0.00	0.00	0.00	0.00	0.00	0.00	0.00	0.00	0.00	0.00	0.00	0.00
Water Resources														
NWI Forested Wetlands	Miles	0.00	0.00	0.00	0.00	0.00	0.00	0.22	0.19	0.00	0.00	0.00	0.00	0.19
NWI Non-Forested Wetlands	Miles	0.00	0.00	0.00	0.00	0.00	0.00	0.04	0.05	0.00	0.00	0.00	0.00	0.05
NWI Forested Wetland Crossings >1,000 ft	Number	0	0	0	0	0	0	0	0	0	0	0	0	0
NWI Non-Forested Wetland Crossings >1,000 ft	Number	0	0	0	0	0	0	0	0	0	0	0	0	0
NLCD Forested Wetlands	Miles	0.00	0.00	0.15	0.36	0.00	0.32	0.57	0.67	0.00	0.32	0.00	0.32	1.03
NLCD Non-Forested Wetlands	Miles	0.00	0.00	0.00	0.00	0.00	0.00	0.00	0.00	0.00	0.00	0.00	0.00	0.00
NLCD Forested Wetland Crossings >1,000 ft	Number	0	0	0	0	0	0	0	0	0	0	0	0	0
NLCD Non-Forested Wetland Crossings >1,000 ft	Number	0	0	0	0	0	0	0	0	0	0	0	0	0
Floodplains - Length Crossed	Miles	0.58	1.01	6.56	2.64	0.79	1.25	0.17	0.06	3.83	1.73	3.09	1.54	4.52
Floodplains - Crossings Greater than 1,000 ft	Number	0	2	6	4	1	1	0	0	4	2	2	2	0
Major Waterbodies and Reservoirs - Number Intersected	Number	1	1	0	1	1	1	1	1	1	1	0	0	1
Major Waterbodies and Reservoirs - Distance Crossed	Miles	0.02	0.03	0.00	0.03	0.03	0.03	0.12	0.13	0.02	0.03	0.00	0.00	0.13
State-Designated Waterbodies with Special Significance	Number	1	1	1	1	0	0	0	0	1	1	0	0	2
Other Waterbodies	Number	1	3	13	21	0	1	4	3	5	12	1	4	28
Springs 0-250 ft	Number	0	0	0	0	0	0	0	0	0	0	0	0	0
Springs 250-500 ft	Number	0	0	0	0	0	0	0	0	0	0	0	0	0
Wild and Scenic Rivers	Number	0	0	0	0	0	0	0	0	0	0	0	0	0

Table 3 6
Region 5 Tier IV Criteria Comparison

Criterion	Unit	AR 5 A (12.65 miles)	Corresponding Links of APR (12.31 miles)	AR 5 B (71.20 miles)	Corresponding Links of APR (67.37 miles)	AR 5 C (9.20 miles)	Corresponding Links of APR (9.40 miles)	AR 5 D (21.74 miles)	Corresponding Links of APR (20.52 miles)	AR 5 E (36.36 miles)	Corresponding Links of APR (33.26 miles)	AR 5 F (22.36 miles)	Corresponding Links of APR (18.82 miles)	APR Total in Region 5 (13.19 miles)
Visual / Cultural Resources														
Federally and State-Designated Scenic Routes, Trails, and Byways	Number	2	2	5	5	1	1	0	0	3	3	1	1	7
Sites on the NRHP	Number	0	0	1	0	0	0	0	0	0	0	0	0	0
Recorded Cultural or Historical Sites														
Archeological Sites	Number	0	0	39	22	8	15	14	6	6	21	3	21	33
GLO Sites	Number	0	0	0	0	0	0	0	0	0	0	0	0	0
Historical Sites	Number	0	0	4	7	3	5	1	2	3	6	3	6	9
Total Recorded Cultural or Historical Sites	Number	0	0	43	29	11	20	15	8	9	27	6	27	42
Cemeteries	Number	0	0	2	0	0	0	1	0	0	0	0	0	0
Environmentally Regulated Sites														
Known Contaminated Sites	Number	0	0	0	0	0	0	0	0	0	0	0	0	0
Engineering Considerations														
Total Length of the Transmission Line	Miles	12.65	12.31	71.20	67.37	9.20	9.40	21.74	20.52	36.36	33.26	22.36	18.82	113.19
Electrical Transmission Line Crossings														
69kV-345kV intersected by the representative centerline	Number	0	0	4	4	1	1	1	1	3	3	2	2	5
Greater than 345kV intersected by the representative centerline	Number	0	0	1	1	1	1	0	0	1	1	1	1	1
Transmission Pipeline Crossings	Number	1	0	42	35	8	6	11	10	19	19	8	10	47
Major Road Crossings	Number	0	0	2	1	0	0	4	4	0	0	0	0	5
Railroad ROW Crossings	Number	0	0	0	0	0	0	0	1	0	0	0	0	0

Notes:
1. Miles of existing infrastructure are determined by measuring the length of the representative centerline intersection with a 500-foot buffer to each side of existing infrastructure. Crossings of existing infrastructure are included in this total and can add approximately 1,000 to 1,500 feet of length per crossing, depending on the angle of intersection. The Engineering Considerations section presents the number of crossings for each type of existing infrastructure. The Routing Team considered this additional length during the route identification process, and Paired-Node Analyses.

Key:

- APR = Applicant Proposed Route.
- AR = Alternative Route.
- DOD = (United States) Department of Defense.
- FAA = Federal Aviation Administration.
- ft = feet
- GLO = General Land Office.
- GRPC = greater prairie-chicken.
- kV = kilovolt(s).
- LEPC = lesser prairie-chicken.
- NLCD = National Land Cover Dataset.
- NRHP = National Register of Historic Places.
- NWI = National Wetlands Inventory.
- ODWC = Oklahoma Department of Wildlife Conservation.
- OGRPCSPT = Oklahoma Greater Prairie-Chicken Spatial Planning Tool.
- OLEPCSPT = Oklahoma Lesser Prairie-Chicken Spatial Planning Tool.
- ROW = right-of-way.
- SGP CHAT = Southern Great Plains Crucial Habitat Assessment Tool.
- TNC = The Nature Conservancy.
- USACE = United States Army Corps of Engineers.
- USFWS = United States Fish and Wildlife Service.
- WGA = Western Governors Association.
- WMA = Wildlife Management Area.

This page intentionally left blank.

3.3.3.6 Region 6 (Cache River, Crowley's Ridge Area, and St. Francis Channel)

Region 6 begins just east of U.S. Route 67, approximately 10 miles southwest of Newport in Jackson County, Arkansas, continues northeast through Jackson, Cross, and Poinsett counties, Arkansas, for a distance of approximately 55 miles and terminates approximately 3 miles south of Marked Tree, in Poinsett County, Arkansas. With the exception of the Crowley's Ridge area, land cover in Region 6 consists primarily of cultivated crops such as rice, corn, and soybeans. Crowley's Ridge consists mostly of hardwood forest and planted pine. Towns near the routes in this Region include Amagon and Fisher, Arkansas.

Clean Line identified the Applicant Proposed Route and four Proposed Alternative Routes in Region 6. The locations of these routes in Region 6 are summarized below and illustrated on Figures 3-2n and 3-2o.

- **Applicant Proposed Route** begins east of U.S. Route 67, approximately 10 miles southwest of Diaz in Jackson County, Arkansas, and traverses in a stepped northeast and east direction for approximately 13 miles, following parcel boundaries to the extent practicable, to cross the Cache River. East of S.R. 37, the Applicant Proposed Route parallels a county road and parcel boundaries for approximately 3 miles, and then turns northeast and southeast for approximately 1 mile before turning east along parcel boundaries for 1 mile. East of the Jackson/Poinsett County line, the route turns southeast, paralleling Entergy Arkansas Inc.'s Fisher-to-Cherry Valley 161kV electrical transmission line for approximately 2 miles, and then turns east and south for 3.5 miles before paralleling the electric transmission line again for approximately 7 miles. South of the Poinsett/Cross County line, the Applicant Proposed route turns east to parallel county roads for approximately 6 miles and then continues generally east for approximately 4 miles to cross Crowley's Ridge. East of Crowley's Ridge, the Applicant Proposed Route continues east for approximately 3 miles and then turns northeast for 8 miles, paralleling the St. Francis Levee. The Applicant Proposed Route then turns east, northeast, and east again for approximately 4 miles before terminating at the eastern boundary of Region 6, approximately 3 miles south of Marked Tree, in Poinsett County, Arkansas.

As shown on Figures 3-2n and 3-2o, portions of the Applicant Proposed Route in Region 6 are outside the 1-mile-wide area of Links L-3, L-4, and L-5 of the Network of Potential Routes presented at scoping. These deviations outside of the Network of Potential Routes resulted from aligning the Applicant Proposed Route to follow an existing electrical transmission line into Cross County, Arkansas, to follow the St. Francis Levee (Ditch No. 60), and to avoid private airfields and aerial applicator operations in Poinsett County, Arkansas.

- **Proposed Alternative Route 6-A** begins at an intersection with the Applicant Proposed Route, approximately 3 miles northeast of Weldon, in Jackson County, Arkansas, and traverses generally in a stepped east, southeast, and northeast direction for approximately 6 miles, following parcel boundaries to the extent practicable and a private road, to cross the Cache River. East of S.R. 37, the Proposed Alternative Route 6-A turns generally in a stepped southeast and east direction for approximately 10 miles (following parcel boundaries to the extent practicable) before intersecting with the Applicant Proposed Route approximately 2 miles southeast of Fisher, in Cross County, Arkansas. Proposed Alternative Route 6-A provides a southern crossing alternative for the Cache River.

As shown on Figure 3-2n, portions of Proposed Alternative Route 6-A are outside of the 1-mile-wide area of Link L-4 of the Network of Potential Routes presented at scoping. Proposed Alternative Route 6-A was sited outside of the Network of Potential Routes in this area to follow parcel lines and traverse less forested wetlands.

- **Proposed Alternative Route 6-B** begins at an intersection with the Applicant Proposed Route, approximately 5 miles northeast of Weldon, in Jackson County, Arkansas, and continues north and northeast for approximately 4 miles, following parcel boundaries when traveling in a due north direction. Proposed Alternative Route 6-B then turns east and parallels S.R. 14 for approximately 3 miles and crosses the Cache River. East of the Cache River, Proposed Alternative Route 6-B turns southeast to parallel an existing electric transmission line for approximately 7 miles before terminating at an intersection with the Applicant Proposed Route, approximately 3 miles northwest of the town of Fisher, in Poinsett County, Arkansas. Proposed Alternative Route 6-B provides a northern crossing of the Cache River that is near an existing highway and existing transmission lines.

As shown on Figure 3-2n, portions of Proposed Alternative Route 6-B are outside of the 1-mile-wide area of L-2 and L-3 of the Network of Potential Routes presented at scoping. Proposed Alternative Route 6-B was sited outside of the Network of Potential Routes in this area to follow an existing electrical transmission line south of Amagon and to avoid private airfields, aerial spraying, and agricultural operations in Poinsett County.

- **Proposed Alternative Route 6-C** begins at an intersection with the Applicant Proposed Route, approximately 4 miles southeast of Fisher, in Poinsett County, Arkansas, and turns east for 6 miles, following parcel boundaries to the extent practicable. Proposed Alternative Route 6-C then turns southeast, then east (paralleling a local road and parcel boundaries), and then northeast for approximately 6 miles and crosses the L'Anguille River. East of the river, Proposed Alternative Route 6-C continues east for 6 miles, crossing Crowley's Ridge, and parallels a local road (for 2 miles) east of Crowley's Ridge. Proposed Alternative Route 6-C then turns northeast and parallels the St. Francis Levee (Ditch No. 23) for approximately 4 miles before it turns east for 2 miles and crosses Ditch No. 23 before intersecting with the Applicant Proposed Route, approximately 3 miles southwest of Marked Tree, in Poinsett County, Arkansas. Proposed Alternative Route 6-C provides a northern crossing alternative for Crowley's Ridge and a western alignment to parallel and cross the St. Francis Levee District ditches.
- **Proposed Alternative Route 6-D** begins at an intersection with the Applicant Proposed Route, southwest of the St. Francis Sunken Lands WMA, in Cross County, Arkansas, and turns northeast to parallel Ditch No. 23 for approximately 3 miles, traversing into Poinsett County and intersecting with Proposed Alternative Route 6-C. Proposed Alternative Route 6-D (and Proposed Alternative Route 6-C) parallel Ditch No. 23 for an additional 4 miles before turning east for 2 miles to intersect with the Applicant Proposed Route, approximately 3 miles southwest of Marked Tree, in Poinsett County, Arkansas. Proposed Alternative Route 6-D provides western alignment to parallel and cross the St. Francis Levee District ditches.

In the central portion of Region 6, the Routing Team eliminated from consideration any alternative along L-2 of the Network of Potential Routes presented at scoping. These alternatives were eliminated because of their proximity to several airfields, Lake Poinsett State Park, and residential development near Harrisburg.

The key Tier IV criteria for each route are presented below. Table 3-7 provides a comparison of the Tier IV criteria of each Proposed Alternative Route with the corresponding portion of the Applicant Proposed Route and summarizes the Tier IV criteria for the Applicant Proposed Route in Region 6. Figures 3-2 through 3-7 identify the Tier IV criteria in Region 6.

3.3.3.6.1 Applicant Proposed Route

The Applicant Proposed Route is 52.19 miles in length, with 12.93 miles (24.8%) of the Applicant Proposed Route paralleling existing linear infrastructure. Land cover is dominated by agricultural and open lands (41.20 miles [78.9%]), with forested lands (5.35 miles [10.3%]) and urban and developed areas (2.76 miles or [5.3%]) making up most of the remaining land cover.

The Applicant Proposed Route is within 1,000 feet of 45 residences and within 250 feet of 10 residences; no residences are within 100 feet of the route. No schools, churches, or hospitals are within 1,000 feet of the route.

The route traverses 12.39 miles (23.7%) of prime farmland soils.

The Applicant Proposed Route crosses one major waterbody (Cache River) and 11 other waterbodies in Region 6. NWI-identified forested wetlands are traversed by 0.19 mile (0.3%) of the Applicant Proposed Route and an additional 0.13 mile (0.2%) of NWI-identified non-forested wetlands. Three of these NWI-identified wetland crossings are more than 1,000 feet in length. Additionally, the route traverses 13.24 miles (25.4%) of a 100-year floodplain, with five crossings that are more than 1,000 feet in width.

The Applicant Proposed Route traverses one federally and/or state-designated scenic route, trail or byway (Crowley Ridge Parkway National Scenic Byway [S.R. 163]). No NRHP sites are within 0.25 mile of the Applicant Proposed Route; five recorded cultural sites are within 0.25 mile of the Applicant Proposed Route.

3.3.3.6.2 Proposed Alternative Route 6-A

Proposed Alternative Route 6-A is 16.24 miles in length with 0.81 miles (5.0%) paralleling existing linear infrastructure. Land cover is dominated by agricultural and open lands (13.58 miles [83.6%]), with urban and developed areas (1.16 miles or 7.1%) making up most of the remaining land cover.

Proposed Alternative Route 6-A is within 1,000 feet of nine residences, within 250 feet of one residence, and within 100 feet of one residence. No schools, churches, or hospitals are within 1,000 feet of the route.

The route traverses 4.71 miles (29.0%) of prime farmland soils.

Proposed Alternative Route 6-A crosses one major waterbody (Cache River) and five other waterbodies in Region 6. This route traverses 0.90 mile (5.5%) of NWI-identified forested wetlands. One of these NWI-identified wetland crossings is more than 1,000 feet in length. Additionally, the route traverses 5.35 miles (32.9%) of a 100-year floodplain, with three of the crossings more than 1,000 feet in length.

No NRHP sites and one recorded cultural site is within 0.25 mile of Proposed Alternative Route 6-A.

Table 3-7 compares the Tier IV criteria of each Proposed Alternative Route with the corresponding portion of the Applicant Proposed Route and summarizes the Tier IV criteria for the Applicant Proposed Route in Region 6. In summary, Clean Line chose the Applicant Proposed Route rather than Proposed Alternative Route 6-A, because the Applicant Proposed Route:

- Parallels more linear infrastructure; and
- Traverses fewer NWI-identified forested wetlands, floodplains, and waterbodies.

3.3.3.6.3 Proposed Alternative Route 6-B

Proposed Alternative Route 6-B is 14.10 miles in length, with 10.39 miles (73.7%) paralleling existing linear infrastructure. Land cover is predominantly agricultural and open lands (11.31 miles [80.2%]), with urban and developed areas (0.83 miles [5.9%]) making up most of the remaining land cover.

Proposed Alternative Route 6-B is within 1,000 feet of 36 residences, within 250 feet of two residences, and within 100 feet of one residence. No schools, churches, or hospitals are within 1,000 feet of the route.

The route traverses 5.37 miles (38.1%) of prime farmland soils.

Proposed Alternative Route 6-B crosses one major waterbody (Cache River) crosses four other waterbodies in Region 6. This route traverses 0.48 mile (3.4%) of NWI-identified forested wetlands. Three of these NWI-identified wetland crossings are more than 1,000 feet in length. Proposed Alternative Route 6-B does not traverse any 100-year floodplains.

Proposed Alternative Route 6-B traverses one federally and/or state-designated scenic route, trail or byway (S.R. 14). No NRHP sites are within 0.25 mile of Proposed Alternative Route 6-B; four recorded cultural sites are within 0.25 mile of Proposed Alternative Route 6-B. Additionally, one cemetery is within 500 feet of the route.

Table 3-7 compares the Tier IV criteria of each Proposed Alternative Route with the corresponding portion of the Applicant Proposed Route and summarizes the Tier IV criteria for the Applicant Proposed Route in Region 6. In summary, Clean Line chose the Applicant Proposed Route rather than Proposed Alternative Route 6-B, because the Applicant Proposed Route:

- Has 26 fewer residences are within 1,000 feet;
- Is not adjacent to Amagon, Arkansas;
- Traverses fewer NWI-identified forested wetlands and waterbodies and fewer forested wetlands at the central Cache River crossing;
- Does not traverse or parallel an Arkansas scenic trail; and
- Is 4.44 miles shorter in total length.

3.3.3.6.4 Proposed Alternative Route 6-C

Proposed Alternative Route 6-C is 23.22 miles in length, with 1.36 miles (5.9%) of the Proposed Alternative Route 6-C paralleling existing linear infrastructure. Land cover is dominated by agricultural and open lands (17.13 miles or 73.8%), with urban and developed areas (2.30 miles or 9.9%) and forested lands (2.22 miles or 9.6%) making up most of the remaining land cover.

Proposed Alternative Route 6-C is within 1,000 feet of 23 residences and within 250 feet of eight residences; no residences are within 100 feet of the route. No schools, churches, or hospitals are within 1,000 feet of the route.

The route traverses 7.32 miles (31.5%) of prime farmland soils.

Proposed Alternative Route 6-C does not cross any major waterbodies, but does cross four other waterbodies in Region 6. This route also does not traverse any NWI-identified wetlands; however, it does traverse 0.84 mile (3.6%) of NLCD-identified forested wetlands. None of these NLCD-identified wetland crossings are more than 1,000 feet in length. The route traverses 9.46 miles (40.7%) of a 100-year floodplain, with seven crossings more than 1,000 feet in length.

Proposed Alternative Route 6-C traverses one federally and/or state-designated scenic route, trail or byway (Crowley Ridge Parkway National Scenic Byway [S.R. 163]). No NRHP sites are within 0.25 mile of Proposed Alternative Route 6-C; 19 recorded cultural sites are within 0.25 mile of Proposed Alternative Route 6-C.

Table 3-7 compares the Tier IV criteria of each Proposed Alternative Route with the corresponding portion of the Applicant Proposed Route and summarizes the Tier IV criteria for the Applicant Proposed Route in Region 6. In summary, Clean Line chose the Applicant Proposed Route rather than Proposed Alternative Route 6-C because the Applicant Proposed Route:

- Parallels more linear infrastructure;
- Has three fewer residences within 1,000 feet;
- Traverses less prime farmland and floodplain; and
- Is within 0.25 mile of 12 fewer recorded cultural or historical sites.

3.3.3.6.5 Proposed Alternative Route 6-D

Proposed Alternative Route 6-D is 9.16 miles in length. Land cover is predominantly agricultural and open lands (8.52 miles [93.0%]) with forested lands (0.15 miles [1.6%]) and urban and developed areas (0.09 miles [1.0%]) making up most of the remaining land cover.

There are no residences, schools, churches, or hospitals within 1,000 feet of the route.

The route traverses 1.24 miles (13.5%) of prime farmland soils.

Proposed Alternative Route 6-D does not cross any waterbodies or NWI-identified wetlands in Region 6. However, it does traverse 0.39 mile (4.3%) of NLCD-identified forested wetlands. None of these NLCD-identified wetland crossings are more than 1,000 feet in length. The route traverses 7.63 miles (83.3%) of a 100-year floodplain, with four crossings more than 1,000 feet in length.

No NRHP sites and two recorded cultural sites are within 0.25 mile of the Proposed Alternative Route 6-D.

Table 3-7 compares the Tier IV criteria of each Proposed Alternative Route with the corresponding portion of the Applicant Proposed Route and summarizes the Tier IV criteria for the Applicant Proposed Route in Region 6. In summary, Clean Line chose the Applicant Proposed Route rather than Proposed Alternative Route 6-D, because the Applicant Proposed Route:

- Traverses less prime farmland; and
- Traverses fewer NLDC-identified forested wetlands and floodplains.

This page intentionally left blank.

Table 3 7
Region 6 Tier IV Criteria Comparison

Criterion	Unit	AR 6 A (16.24 miles)	Corresponding Links of APR (17.70 miles)	AR 6 B (14.10 miles)	Corresponding Links of APR (9.66 miles)	AR 6 C (23.22 miles)	Corresponding Links of APR (24.87 miles)	AR 6 D (9.16 miles)	Corresponding Links of APR (8.58 miles)	APR Total in Region 6 (52.19 miles)
Existing Infrastructure:										
Electrical Transmission Lines (69 kV and higher)	Miles	0.11	3.31	7.51	0.15	0.23	4.43	0.00	0.00	10.25
Transmission Pipelines	Miles	0.03	0.06	0.00	0.00	0.00	0.00	0.00	0.00	1.09
Railroads	Miles	0.19	0.21	0.00	0.00	0.19	0.20	0.00	0.00	0.41
Publicly Maintained Federal, State, and County Roads	Miles	0.64	0.93	3.89	0.42	1.11	0.38	0.00	0.00	1.70
Total Paralleling Existing Linear Infrastructure	Miles	0.81	4.02	10.39	0.57	1.36	5.01	0.00	0.00	12.93
Land Cover										
Parcels and Parcel Boundaries	Number	54	63	51	38	69	66	27	17	176
Agriculture and Open Lands										
NLCD Pasture / Hay	Miles	0.00	0.00	0.00	0.00	0.72	0.14	0.00	0.00	0.42
NLCD Barren Land	Miles	0.00	0.00	0.00	0.00	0.00	0.00	0.00	0.00	0.00
NLCD Grassland / Herbaceous	Miles	0.00	0.00	0.00	0.00	0.00	0.00	0.00	0.00	0.00
NLCD Shrub / Scrub	Miles	0.00	0.00	0.00	0.00	0.00	0.00	0.00	0.00	0.00
NLCD Cultivated Crops	Miles	13.58	15.40	11.31	7.95	16.41	18.45	8.52	8.11	40.78
Total Agriculture and Open Lands	Miles	13.58	15.40	11.31	7.95	17.13	18.59	8.52	8.11	41.20
Forested Areas	Miles	0.00	0.00	0.00	0.00	2.22	3.98	0.15	0.14	5.35
Urban/Developed Areas	Miles	1.16	1.45	0.83	0.98	2.30	0.42	0.09	0.05	2.76
Structures										
K-12 Schools, Colleges and Universities										
0-100 feet	Number	0	0	0	0	0	0	0	0	0
100-250 feet	Number	0	0	0	0	0	0	0	0	0
250-500 feet	Number	0	0	0	0	0	0	0	0	0
500-1,000 feet	Number	0	0	0	0	0	0	0	0	0
Churches										
0-100 feet	Number	0	0	0	0	0	0	0	0	0
100-250 feet	Number	0	0	0	0	0	0	0	0	0
250-500 feet	Number	0	0	0	0	0	0	0	0	0
500-1,000 feet	Number	0	0	0	0	0	0	0	0	0
Hospitals										
0-100 feet	Number	0	0	0	0	0	0	0	0	0
100-250 feet	Number	0	0	0	0	0	0	0	0	0
250-500 feet	Number	0	0	0	0	0	0	0	0	0
500-1,000 feet	Number	0	0	0	0	0	0	0	0	0
Residences										
0-100 feet	Number	1	0	1	0	0	0	0	0	0
100-250 feet	Number	1	2	2	2	7	8	0	0	10
250-500 feet	Number	3	6	9	5	9	8	0	0	15
500-1,000 feet	Number	4	7	24	3	6	10	0	0	20

Table 3 7
Region 6 Tier IV Criteria Comparison

Criterion	Unit	AR 6 A (16.24 miles)	Corresponding Links of APR (17.70 miles)	AR 6 B (14.70 miles)	Corresponding Links of APR (9.66 miles)	AR 6 C (23.22 miles)	Corresponding Links of APR (24.87 miles)	AR 6 D (9.16 miles)	Corresponding Links of APR (8.58 miles)	APR Total in Region 6 (52.19 miles)
Agricultural, Commercial, and Industrial Structures										
0-100 feet	Number	0	0	0	0	0	4	0	0	4
100-250 feet	Number	0	0	1	0	0	4	0	0	4
250-500 feet	Number	1	2	0	2	0	16	0	0	19
500-1,000 feet	Number	2	0	0	0	0	18	0	0	19
Government Jurisdictions										
Cities and Towns	Miles	0.00	0.00	0.00	0.00	0.00	0.00	0.00	0.00	0.00
National Forests (U.S. Forest Service) - Administrative Boundary	Miles	0.00	0.00	0.00	0.00	0.00	0.00	0.00	0.00	0.00
National Forests (U.S. Forest Service) - Owned	Miles	0.00	0.00	0.00	0.00	0.00	0.00	0.00	0.00	0.00
National Wildlife Refuges (USFWS)	Miles	0.00	0.00	0.00	0.00	0.00	0.00	0.00	0.00	0.00
National Parks (National Park Service)	Miles	0.00	0.00	0.00	0.00	0.00	0.00	0.00	0.00	0.00
USACE Lands	Miles	0.00	0.00	0.00	0.00	0.00	0.00	0.00	0.00	0.00
DOD Lands	Miles	0.00	0.00	0.00	0.00	0.00	0.00	0.00	0.00	0.00
State Parks										
Oklahoma State Parks (Oklahoma Tourism and Recreation Department)	Miles	0.00	0.00	0.00	0.00	0.00	0.00	0.00	0.00	0.00
Arkansas State Parks (Arkansas Department of Parks and Tourism)	Miles	0.00	0.00	0.00	0.00	0.00	0.00	0.00	0.00	0.00
Tennessee State Parks (Tennessee Department of Environment and Conservation, Division of Parks and Conservation, State Parks)	Miles	0.00	0.00	0.00	0.00	0.00	0.00	0.00	0.00	0.00
State Owned WMAs										
Oklahoma WMAs (Oklahoma Department of Wildlife Conservation)	Miles	0.00	0.00	0.00	0.00	0.00	0.00	0.00	0.00	0.00
Arkansas WMAs (Arkansas Game and Fish Commission)	Miles	0.00	0.00	0.00	0.00	0.00	0.00	0.00	0.00	0.00
Tennessee WMAs (Tennessee Wildlife Resources Agency)	Miles	0.00	0.00	0.00	0.00	0.00	0.00	0.00	0.00	0.00
Arkansas Leased WMAs (Arkansas Game and Fish Commission)	Miles	0.00	0.00	0.00	0.00	0.00	0.00	0.00	0.00	0.00
Oklahoma School Lands (The Commissioners of the Land Office)	Miles	0.00	0.00	0.00	0.00	0.00	0.00	0.00	0.00	0.00
Arkansas Natural Areas (Arkansas Natural Heritage Commission)	Miles	0.00	0.00	0.00	0.00	0.00	0.00	0.00	0.00	0.00
Tennessee Natural Areas (Tennessee Department of Environment and Conservation, Division of Natural Areas, Natural Areas Program)	Miles	0.00	0.00	0.00	0.00	0.00	0.00	0.00	0.00	0.00
County-, City-, and Town-owned Lands that are managed for conservation or recreation	Miles	0.00	0.00	0.00	0.00	0.00	0.00	0.00	0.00	0.00
Tribal Trust Lands and Allotments	Miles	0.00	0.00	0.00	0.00	0.00	0.00	0.00	0.00	0.00
Conservation Easements or Areas										
Federal Conservation Easements	Miles	0.00	0.00	0.00	0.00	0.00	0.00	0.00	0.00	0.00
State Conservation Easements	Miles	0.00	0.00	0.00	0.00	0.00	0.00	0.00	0.00	0.00

Table 3 7
Region 6 Tier IV Criteria Comparison

Criterion	Unit	AR 6 A (16.24 miles)		Corresponding Links of APR (17.70 miles)		AR 6 B (14.70 miles)		Corresponding Links of APR (9.66 miles)		AR 6 C (23.22 miles)		Corresponding Links of APR (24.87 miles)		AR 6 D (9.16 miles)		Corresponding Links of APR (8.58 miles)		APR Total in Region 6 (52.19 miles)		
		Miles	0.00	0.00	0.00	0.00	0.00	0.00	0.00	0.00	0.00	0.00	0.00	0.00	0.00	0.00	0.00	0.00	0.00	0.00
Soil, Geologic, or Topographic Resources																				
TNC Conservation Easements	Miles	0.00	0.00	0.00	0.00	0.00	0.00	0.00	0.00	0.00	0.00	0.00	0.00	0.00	0.00	0.00	0.00	0.00	0.00	0.00
Prime Farmland	Miles	4.71	4.30	5.37	3.76	7.32	3.49	1.24	1.24	7.32	3.49	1.24	1.24	7.32	3.49	1.24	1.24	7.32	3.49	12.39
Farmlands of Statewide Importance	Miles	1.04	1.94	0.29	0.29	2.11	7.47	1.93	6.15	2.11	7.47	1.93	6.15	2.11	7.47	1.93	6.15	2.11	7.47	10.23
Slopes Greater than 20%	Miles	0.00	0.00	0.00	0.00	0.00	0.00	0.00	0.00	0.00	0.00	0.00	0.00	0.00	0.00	0.00	0.00	0.00	0.00	0.00
Karst Areas	Miles	0.00	0.00	0.00	0.00	0.00	0.00	0.00	0.00	0.00	0.00	0.00	0.00	0.00	0.00	0.00	0.00	0.00	0.00	0.00
Airport / Airfields																				
Military Airports	Miles	0.00	0.00	0.00	0.00	0.00	0.00	0.00	0.00	0.00	0.00	0.00	0.00	0.00	0.00	0.00	0.00	0.00	0.00	0.00
FAA-Registered Public Airports	Number	0	0	0	0	0	0	0	0	0	0	0	0	0	0	0	0	0	0	0
FAA-Registered Private Airports	Number	0	0	0	0	0	0	0	0	0	0	0	0	0	0	0	0	0	0	0
Other Private Airstrips and Helipads	Number	1	2	0	0	0	0	0	0	1	0	0	0	0	0	0	0	0	0	3
Biological Resources																				
USFWS-Designated Critical Habitat	Miles	0.00	0.00	0.00	0.00	0.00	0.00	0.00	0.00	0.00	0.00	0.00	0.00	0.00	0.00	0.00	0.00	0.00	0.00	0.00
Native Prairies	Miles	0.00	0.00	0.00	0.00	0.00	0.00	0.00	0.00	0.00	0.00	0.00	0.00	0.00	0.00	0.00	0.00	0.00	0.00	0.00
State Natural Heritage Program Species Location Data - Occurrence Records	Number	0	0	0	0	0	0	0	0	1	1	1	1	1	1	1	1	1	1	8
Arkansas Natural Heritage Program Species Location Data - Focal Areas	Miles	0.00	0.00	0.00	0.00	0.00	0.00	0.00	0.00	0.00	0.00	0.00	0.00	0.00	0.00	0.00	0.00	0.00	0.00	0.00
Arkansas Natural Heritage Program Species Location Data - Sensitive Streams	Number	0	0	0	0	0	0	0	0	0	0	0	0	0	0	0	0	0	0	0
Arkansas Natural Heritage Program Species Location Data - Designated Streams	Number	0	0	0	0	0	0	0	0	0	0	0	0	0	0	0	0	0	0	0
LEPC Potential Habitat: ODWC OLEPCSPT	Miles	0.00	0.00	0.00	0.00	0.00	0.00	0.00	0.00	0.00	0.00	0.00	0.00	0.00	0.00	0.00	0.00	0.00	0.00	0.00
LEPC Potential Habitat -WGA SGP CHAT - Rank 1	Miles	0.00	0.00	0.00	0.00	0.00	0.00	0.00	0.00	0.00	0.00	0.00	0.00	0.00	0.00	0.00	0.00	0.00	0.00	0.00
LEPC Potential Habitat -WGA SGP CHAT - Ranks 2 and 3	Miles	0.00	0.00	0.00	0.00	0.00	0.00	0.00	0.00	0.00	0.00	0.00	0.00	0.00	0.00	0.00	0.00	0.00	0.00	0.00
Existing Impacted Areas within LEPC Habitat - CHAT Rank 1	Miles	0.00	0.00	0.00	0.00	0.00	0.00	0.00	0.00	0.00	0.00	0.00	0.00	0.00	0.00	0.00	0.00	0.00	0.00	0.00
Existing Impacted Areas within LEPC Habitat - CHAT Ranks 2 and 3	Miles	0.00	0.00	0.00	0.00	0.00	0.00	0.00	0.00	0.00	0.00	0.00	0.00	0.00	0.00	0.00	0.00	0.00	0.00	0.00
Existing Impacted Areas within LEPC Habitat - OLEPCSPT Ranks 4-8	Miles	0.00	0.00	0.00	0.00	0.00	0.00	0.00	0.00	0.00	0.00	0.00	0.00	0.00	0.00	0.00	0.00	0.00	0.00	0.00
Whooping Crane Migratory Stopover Locations	Miles	0.00	0.00	0.00	0.00	0.00	0.00	0.00	0.00	0.00	0.00	0.00	0.00	0.00	0.00	0.00	0.00	0.00	0.00	0.00
Ozark Big-Eared Bat Potential Occurrence Areas	Miles	0.00	0.00	0.00	0.00	0.00	0.00	0.00	0.00	0.00	0.00	0.00	0.00	0.00	0.00	0.00	0.00	0.00	0.00	0.00
Indiana Bat Potential Occurrence Areas	Miles	0.00	0.00	0.00	0.00	0.00	0.00	0.00	0.00	0.00	0.00	0.00	0.00	0.00	0.00	0.00	0.00	0.00	0.00	0.00
Gray Bat Potential Occurrence Areas	Miles	0.00	0.00	0.00	0.00	0.00	0.00	0.00	0.00	0.00	0.00	0.00	0.00	0.00	0.00	0.00	0.00	0.00	0.00	0.00
Known Bat Caves	Number	0	0	0	0	0	0	0	0	0	0	0	0	0	0	0	0	0	0	0
American Burying Beetle Potential Occurrence Areas	Miles	0.00	0.00	0.00	0.00	0.00	0.00	0.00	0.00	0.00	0.00	0.00	0.00	0.00	0.00	0.00	0.00	0.00	0.00	0.00
Water Resources																				
NWI Forested Wetlands	Miles	0.90	0.08	0.48	0.08	0.00	0.00	0.00	0.00	0.00	0.00	0.00	0.00	0.00	0.00	0.00	0.00	0.00	0.00	0.19
NWI Non-Forested Wetlands	Miles	0.00	0.00	0.00	0.00	0.00	0.00	0.00	0.00	0.00	0.00	0.00	0.00	0.00	0.00	0.00	0.00	0.00	0.00	0.13

Table 3.7
Region 6 Tier IV Criteria Comparison

Criterion	Unit	AR 6 A (16.24 miles)	Corresponding Links of APR (17.70 miles)	AR 6 B (14.10 miles)	Corresponding Links of APR (9.66 miles)	AR 6 C (23.22 miles)	Corresponding Links of APR (24.87 miles)	AR 6 D (9.16 miles)	Corresponding Links of APR (8.58 miles)	APR Total in Region 6 (52.19 miles)
NWI Forested Wetland Crossings > 1,000 feet	Number	0	0	1	0	0	0	0	0	0
NWI Non-Forested Wetland Crossings > 1,000 feet	Number	0	0	0	0	0	0	0	0	0
NLCD Forested Wetlands	Miles	0.92	0.70	1.70	0.58	0.84	1.74	0.39	0.23	2.52
NLCD Non-Forested Wetlands	Miles	0.00	0.00	0.11	0.00	0.00	0.06	0.00	0.00	0.06
NLCD Forested Wetland Crossings > 1,000 feet	Number	2	1	3	1	0	0	0	0	3
NLCD Non-Forested Wetland Crossings > 1,000 feet	Number	0	0	0	0	0	0	0	0	0
Floodplains - Length Crossed	Miles	5.35	4.23	0.00	0.00	9.46	6.97	7.63	6.19	13.24
Floodplains - Crossings Greater than 1,000 feet	Number	3	2	0	0	7	2	4	1	5
Major Waterbodies and Reservoirs - Number Intersected	Number	1	1	1	1	0	0	0	0	1
Major Waterbodies and Reservoirs - Distance Crossed	Miles	0.04	0.05	0.17	0.05	0.00	0.00	0.00	0.00	0.05
State-Designated Waterbodies with Special Significance	Number	0	0	0	0	0	0	0	0	0
Other Waterbodies	Number	5	1	4	4	4	3	0	0	11
Springs 0-250 feet	Number	0	0	0	0	0	0	0	0	0
Springs 250-500 feet	Number	0	0	0	0	0	0	0	0	0
Wild and Scenic Rivers	Number	0	0	0	0	0	0	0	0	0
Visual / Cultural Resources										
Federally and State-Designated Scenic Routes, Trails, and Byways	Number	0	0	1	0	1	1	0	0	1
Sites on the NLRHP	Number	0	0	0	0	0	0	0	0	0
Recorded Cultural or Historical Sites										
Archaeological Sites	Number	1	1	4	0	19	2	2	2	4
GLO Sites	Number	0	0	0	0	0	0	0	0	0
Historical Sites	Number	0	1	0	1	0	0	0	0	1
Total Recorded Cultural or Historical Sites	Number	1	2	4	1	19	2	2	2	5
Cemeteries	Number	0	0	1	0	0	0	0	0	0
Environmentally Regulated Sites										
Known Contaminated Sites	Number	0	0	0	0	0	0	0	0	0
Engineering Considerations										
Total Length of the Transmission Line	Miles	16.24	17.70	14.10	9.66	23.22	24.87	9.16	8.58	52.19
Electrical Transmission Line Crossings										
69kV-345kV intersected by the representative centerline	Number	0	1	1	0	1	1	0	0	3
Greater than 345kV intersected by the representative centerline	Number	0	0	0	0	0	0	0	0	0
Transmission Pipeline Crossings	Number	0	0	0	0	0	0	0	0	3
Major Road Crossings	Number	1	1	0	0	0	0	0	0	1
Railroad ROW Crossings	Number	1	1	0	0	1	1	0	0	2

Notes:
 1 Miles of existing infrastructure are determined by measuring the length of the representative centerline intersection with a 500-foot buffer to each side of existing infrastructure. Crossings of existing infrastructure are included in this total and can add approximately 1,000 to 1,500 feet of length per crossing, depending on the angle of intersection. The Engineering Considerations section presents the number of crossings for each type of existing infrastructure. The Routing Team considered this additional length during the route identification process and Paired-Node Analyses.

Table 3 7
Region 6 Tier IV Criteria Comparison

Criterion	Unit	AR 6 A (16.24 miles)	Corresponding Links of APR (17.70 miles)	AR 6 B (14.10 miles)	Corresponding Links of APR (9.66 miles)	AR 6 C (23.22 miles)	Corresponding Links of APR (24.87 miles)	AR 6 D (9.16 miles)	Corresponding Links of APR (8.58 miles)	APR Total in Region 6 (52.19 miles)
-----------	------	-------------------------	--	-------------------------	---	-------------------------	--	------------------------	---	---

Key:
 APR = Applicant Proposed Route.
 AR = Alternative Route.
 DOD = (United States) Department of Defense.
 FAA = Federal Aviation Administration.
 ft = feet.
 GLO = General Land Office.

GRPC = greater prairie-chicken.
 kv = Kilovolt(s).
 LEPC = lesser prairie-chicken.
 NLCD = National Land Cover Dataset.
 NIRHP = National Register of Historic Places.
 NWI = National Wetlands Inventory.

ODWC = Oklahoma Department of Wildlife Conservation.
 OGRPCSP = Oklahoma Greater Prairie-Chicken Spatial Planning Tool.
 OLEPCSP = Oklahoma Lesser Prairie-Chicken Spatial Planning Tool.
 ROW = right-of-way.
 SGP CHAT = Southern Great Plains Crucial Habitat Assessment Tool.
 TNC = The Nature Conservancy.

USACE = United States Army Corps of Engineers.
 USFWS = United States Fish and Wildlife Service.
 WGA = Western Governors Association.
 WMA = Wildlife Management Area.

This page intentionally left blank.

3.3.3.7 Region 7 (Arkansas Mississippi River Delta and Tennessee)

Region 7 begins approximately 3 miles south of Marked Tree, in Poinsett County, Arkansas, continues east and southeast through Poinsett and Mississippi counties, Arkansas, across the Mississippi River and into Tipton and Shelby Counties, Tennessee, for a distance of approximately 43 miles, terminating near the Tipton/Shelby County line south of Tipton, Tennessee. Land cover west of the Mississippi River is primarily cultivated, agricultural crops; land cover east of the Mississippi River is a mix of hardwood forests, residential and commercial development, and open land areas. Towns near the routes in this Region include Marked Tree, Tyrone, and Birdsong, Arkansas, and Drummonds, Millington, Tipton, Munford, and Atoka, Tennessee.

Clean Line identified the Applicant Proposed Route and four Proposed Alternative Routes in Region 7. The locations of these routes are summarized below and illustrated on Figure 3-2o.

- **Applicant Proposed Route** begins at the western boundary of Region 7, approximately 3 miles south of Marked Tree in Poinsett County, Arkansas. The Applicant Proposed Route continues east for approximately 2 miles before turning southeast to parallel Entergy Arkansas Inc.'s Marked Tree to Marion 161kV electrical transmission line for approximately 2 miles and then turns east to follow county roads, section lines, and parcel lines, to the extent practicable, for approximately 22 miles before crossing the Mississippi River at Frenchmen's Bayou. After crossing the Mississippi River, the route turns south and southeast to follow county roads and parcel boundaries, to the extent practicable, for 9 miles. The Applicant Proposed Route then turns east to parallel Walker Road in Millington, Tennessee, until crossing S.R. 3/U.S. 51, where it turns northeastward before terminating at the proposed converter station siting area located at the eastern boundary of Region 7.

As shown on Figure 3-2o, portions of the Applicant Proposed Route are outside of the 1-mile-wide area of Links M-2 and M-5 of the Network of Potential Routes presented at scoping. In Link M-2, the Routing Team identified a route that more closely follows Entergy Arkansas Inc.'s Marked Tree-to-Marion 161kV electric transmission line. In Link M-5, the Routing Team identified a route that more closely followed field lines and parcel boundaries and that avoided residential areas identified during aerial reconnaissance.

- **Proposed Alternative Route 7-A** begins at an intersection with the Applicant Proposed Route approximately 3 miles south of Marked Tree, in Poinsett County, Arkansas. Proposed Alternative Route 7-A then follows existing canals northeast for approximately 6 miles. The route turns east to follow county roads and section lines for approximately 11 miles. At I-55, the route turns northeast to parallel I-55 for approximately 4 miles until turning east to cross I-55 and parallel a county road for approximately 3 miles. The route turns northeast to follow parcel boundaries, field lines, and county roads, to the extent practicable, to a point approximately 5 miles north of Wilson, Arkansas. The route then turns south to follow field lines and parcel boundaries, to the extent practicable, for approximately 8 miles to its crossing of the Mississippi River. After crossing the river, the route parallels parcel boundaries, field lines, and county roads for approximately 4 miles before terminating at the Applicant Proposed Route. Proposed Alternative Route 7-A follows a northern alignment to cross the Mississippi River.

As shown on Figure 3-2o, portions of Proposed Alternative Route 7-A are outside of the 1-mile-wide area of Link M-1 of the Network of Potential Routes presented at scoping. Proposed Alternative Route 7-A was sited outside of the Network of Potential Routes in this area to avoid a center pivot irrigation system and a perpendicular crossing of an airfield observed during the aerial reconnaissance (see Section 3.3.2 and Appendix C). Although the GIS data sources used to identify airfields (see Appendix A) shows a private airfield east of Marie, the Routing

Team was not able to visually confirm the existence of any private airfields within 0.5 mile of the route (see Figure 3-3o) during the aerial reconnaissance.

- **Proposed Alternative Route 7-B** begins at an intersection with the Applicant Proposed Route east of the Mississippi River and 8 miles northwest of Millington, Tennessee. Proposed Alternative Route 7-B turns generally southeast, paralleling property lines where feasible, for approximately 6 miles. North of Millington, the route turns south before turning east and eventually paralleling Walker Road before intersecting again with the Applicant Proposed Route along Walker Road in Millington, Shelby County, Tennessee. Proposed Alternative Route 7-B provides a western alignment in Tipton County.

As shown on Figure 3-2o, portions of Proposed Alternative Route 7-B are outside of the 1-mile-wide area of Link M-5 of the Network of Potential Routes presented at scoping. The Routing Team proposed this alternative in response to scoping comments received by the DOE; these comments requested the analysis and identification of routes that were south of Millington, Tennessee.

- **Proposed Alternative Route 7-C** shares the same route as Proposed Alternative Route 7-B until just south of the Tipton/Shelby County line. At this location, Proposed Alternative Route 7-C continues south for approximately 5 miles before turning southeast and east to cross S.R. 3/U.S. Highway 51 in Millington. This alternative route then parallels Paul Barrett Parkway (S.R. 385) and TVA's Covington-to-Northeast Gate 161kV electrical transmission line in an easterly, southeasterly, and then northerly direction for approximately 10 miles. This alternative route then diverges west from the transmission line in the area south of the Shelby Substation to intersect the Applicant Proposed Route at the proposed converter station siting area. Proposed Alternative Route 7-C provides a southern route to the proposed converter station siting area.

As shown on Figure 3-2o, portions of Proposed Alternative Route 7-C are outside of the 1-mile-wide area of Link M-5 of the Network of Potential Routes presented at scoping. The Routing Team proposed this alternative in response to scoping comments received by the DOE; these comments requested the analysis and identification of routes south of the Millington Regional Airport that also would avoid Munford, Tipton, and Atoka.

- **Proposed Alternative Route 7-D** begins at an intersection of the Applicant Proposed Route approximately 3 miles west of Tipton, Tennessee. At this location Proposed Alternative Route 7-D traverses east, northeast, and east for approximately 2 miles before turning southeast to generally follow TVA's Shelby-to-Sans Souci 500kV electrical transmission line for approximately 4 miles. Proposed Alternative Route 7-D provides a northern alignment to the proposed converter station siting area.

As shown on Figure 3-2o, Proposed Alternative Route 7-D is outside of the Network of Potential Routes presented at scoping. The Routing Team developed Proposed Alternative Route 7-D in response to scoping comments received by the DOE expressing concerns about the existing and planned airspace north of the Millington Regional Airport; this alternative is a greater distance from the airport than the Applicant Proposed Route and follows the TVA Shelby-to-Sans Souci 500 kV existing transmission line for portions of its length.

The key Tier IV criteria for each route are presented below. Table 3-8 compares the Tier IV criteria of each Proposed Alternative Route with the corresponding portion of the Applicant Proposed Route and summarizes the Tier IV criteria for the Applicant Proposed Route in Region 7. Figures 3-2 through 3-7 identify the Tier IV criteria in Region 7.

3.3.3.7.1 Applicant Proposed Route

The Applicant Proposed Route is 42.91 miles in length with 5.34 miles (12.4%) paralleling existing linear infrastructure. Land cover is dominated by agricultural and open lands (31.98 miles [74.5%]), with most of the remaining land cover comprises urban and developed lands (4.34 miles [10.1%]) and forested lands (3.43 miles [8.0%]).

The Applicant Proposed Route is within 1,000 feet of 61 residences and within 250 feet of seven residences; no residences are within 100 feet of the route. No schools or hospitals within 1,000 feet of the route; however, two churches are within 1,000 feet of the route. Additionally, the Applicant Proposed Route traverses 1.32 miles (3.1%) within the municipal boundaries of Millington, Tennessee.

The route traverses 9.94 miles (23.2%) of prime farmland soils and 0.07 mile (0.2%) of federal conservation easements.

The Applicant Proposed Route traverses 16.41 miles (38.2%) of land the USFWS has documented as having a potential for occurrence of the Indiana bat.

The Applicant Proposed Route crosses one major waterbody (the Mississippi River) and nine other waterbodies in Region 7. NWI-identified forested wetlands are traversed by 1.49 miles (3.5%) of the Applicant Proposed Route, with an additional 0.15 mile (0.3%) of NWI-identified non-forested wetlands. Four of these NWI-identified wetland crossings are more than 1,000 feet in length. Additionally, the route traverses 20.18 miles (47.0%) of 100-year, with 18 crossings being more than 1,000 feet in length.

Three federally and/or state-designated scenic routes, trails, or byways (U.S. Route 63; the Great River Road National Scenic Byway or U.S. Route 61; and the Trail of Tears) are traversed by the Applicant Proposed Route. No NRHP sites and 22 recorded cultural sites are within 0.25 mile of the Applicant Proposed Route.

3.3.3.7.2 Proposed Alternative Route 7-A

Proposed Alternative Route 7-A is 43.23 miles in length with 14.18 miles (32.8%) paralleling existing linear infrastructure. Land cover is dominated by agricultural and open lands (33.19 miles [76.8%]), with urban and developed areas (4.85 miles [11.2%]) and forested lands (0.03 miles [0.1%]) making up most of the remaining land cover.

Proposed Alternative Route 7-A is within 1,000 feet of 29 residences, and within 250 feet of three residences; no residences are within 100 feet of the route. No schools, churches, or hospitals are within 1,000 feet of the route.

The route traverses 4.00 miles (9.3%) of prime farmland soils. Proposed Alternative Route 7-A is within 1 mile of a private airfield in Mississippi County, Arkansas.

Proposed Alternative Route 7-A traverses 4.19 miles (9.7%) of lands the USFWS has documented as having a potential for occurrence of the Indiana bat.

Proposed Alternative Route 7-A crosses one major waterbody (the Mississippi River) and six other waterbodies. NWI-identified forested wetlands are traversed by 0.65 mile (1.5%) of Proposed Alternative Route 7-A, with an additional 0.16 mile (0.4%) being NWI-identified non-forested wetlands. Seven of these NWI-identified wetland crossings are more than 1,000 feet in length. Additionally, the route traverses 17.15 miles (39.7%) of 100-year floodplains, with nine of the crossings being more than 1,000 feet in length.

Proposed Alternative Route 7-A traverses three federally and/or state-designated scenic routes, trails or byways (U.S. Route 63; the Great River Road National Scenic Byway or U.S. Route 61; and the Trail of Tears). No NRHP sites and 12 recorded cultural sites are within 0.25 mile of Proposed Alternative Route 7-A.

Table 3-8 compares the Tier IV criteria of each Proposed Alternative Route with the corresponding portion of the Applicant Proposed Route and summarizes the Tier IV criteria for the Applicant Proposed Route in Region 7. In summary, Clean Line chose the Applicant Proposed Route rather than Proposed Alternative Route 7-A because the Applicant Proposed Route:

- Has 17 fewer residences that are within 1,000 feet;
- Is not within 1.0 mile of any private airfields; and
- Is 14.56 miles shorter in total length in the agricultural lands in eastern Arkansas.

3.3.3.7.3 Proposed Alternative Route 7-B

Proposed Alternative Route 7-B is 8.56 miles in length with no portion of the route paralleling existing linear infrastructure. Land cover is dominated by agricultural and open lands (6.20 miles [72.4%]), with forested areas (1.95 miles [22.8%]) and urban and developed areas (0.40 miles [4.7%]) making up most of the remaining land cover.

Proposed Alternative Route 7-B is within 1,000 feet of 151 residences, and within 250 feet of nine residences; no residences are within 100 feet of the route. No schools, churches, or hospitals are within 1,000 feet of the route. Proposed Alternative Route 7-B traverses 1.70 miles (19.6%) within the municipal boundaries of Millington, Tennessee.

The route traverses 3.53 miles (45.9%) of prime farmland soils.

Proposed Alternative Route 7-B traverses 8.56 miles (100%) of lands the USFWS has documented as having a potential for occurrence of the Indiana bat.

Proposed Alternative Route 7-B does not cross any waterbodies. NWI-identified forested wetlands are traversed by 0.11 mile (1.3%) of Proposed Alternative Route 7-B. None of these NWI-identified wetland crossings are more than 1,000 feet in length. Additionally, the route traverses 2.06 miles (24.1%) of 100-year floodplains, with two floodplain crossings more than 1,000 feet in length.

No NRHP sites and six recorded cultural sites are within 0.25 mile of Proposed Alternative Route 7-B.

Table 3-8 compares the Tier IV criteria of each Proposed Alternative Route with the corresponding portion of the Applicant Proposed Route and summarizes the Tier IV criteria for the Applicant Proposed Route in Region 7. In summary, Clean Line chose the Applicant Proposed Route rather than Proposed Alternative Route 7-B because the Applicant Proposed Route:

- Has 113 fewer residences within 1,000 feet; and
- Traverses fewer NWI-identified forested wetlands and floodplains.

3.3.3.7.4 Proposed Alternative Route 7-C

Proposed Alternative Route 7-C is 23.76 miles in length with 11.69 miles (49.2%) of the route paralleling existing linear infrastructure. Land cover is dominated by agricultural and open lands (17.96 miles [75.6%]), with forested areas (2.61 miles [11.0%]) and urban and developed areas (2.59 miles [10.9%]) making up most of the remaining land cover.

Proposed Alternative Route 7-C is within 1,000 feet of 406 residences and within 250 feet of nine residences; no residences are within 100 feet of the route. No schools or hospitals are within 1,000 feet of the route. Three churches are within 1,000 feet of the route and one church is within 250 feet of the route. Proposed Alternative Route 7-C traverses 8.28 miles (34.8%) within the municipal boundaries of Millington, Tennessee.

The route traverses 15.81 miles (66.5%) of prime farmland soils. The Proposed Alternative Route 7-C is within 1 mile of a private airfield.

Proposed Alternative Route 7-C traverses 23.76 miles (100%) of counties the USFWS has documented having a potential for occurrence of the Indiana bat.

Proposed Alternative Route 7-C does not cross any major waterbodies, but it crosses three other waterbodies. NWI-identified forested wetlands are traversed by 0.52 mile (2.2%) of Proposed Alternative Route 7-C. None of these NWI-identified wetland crossings are more than 1,000 feet in length. Additionally, the route traverses 6.59 miles (27.7%) of 100-year floodplain; nine of the floodplain crossings are more than 1,000 feet in length.

No NRHP sites and 10 recorded cultural sites are within 0.25 mile of Proposed Alternative Route 7-C. Additionally, one cemetery is within 500 feet of the route.

Table 3-8 compares the Tier IV criteria of each Proposed Alternative Route with the corresponding portion of the Applicant Proposed Route and summarizes the Tier IV criteria for the Applicant Proposed Route in Region 7. In summary, Clean Line chose the Applicant Proposed Route rather than Proposed Alternative Route 7-C because the Applicant Proposed Route:

- Has 340 fewer residences within 1,000 feet;
- Traverse less municipal boundaries;
- Crosses less prime farmland;
- Traverses fewer NWI-identified forested wetlands and floodplain; and
- Is 10.58 miles shorter in total length.

3.3.3.7.5 Proposed Alternative Route 7-D

Proposed Alternative Route 7-D is 6.24 miles in length with 1.75 miles (28.0%) of the route paralleling existing linear infrastructure. Land cover is dominated by agricultural and open lands (5.13 miles [82.2%]), with forested areas (0.61 miles [9.8%]) and urban and developed areas (0.18 miles [2.9%]) making up most of the remaining land cover.

Proposed Alternative Route 7-D is within 1,000 feet of 182 residences; no residences are within 250 feet of the route. No schools, churches, or hospitals are within 1,000 feet of the route. Proposed Alternative Route 7-D traverses 1.21 mile (19.4%) within the municipal boundaries of Munford and Atoka, Tennessee.

The route traverses 3.44 miles (55.1%) of prime farmland soils.

Proposed Alternative Route 7-D traverses 16.41 miles (38.2%) of lands documented by the USFWS as having a potential for occurrence of the Indiana bat.

Proposed Alternative Route 7-D does not cross any waterbodies. NWI-identified forested wetlands are traversed by 0.29 mile (4.6%) of Proposed Alternative Route 7-D. None of these NWI identified wetland crossings are more than 1,000 feet in length. Additionally, the route traverses 2.33 miles (37.3%) of 100-year floodplains; five of the floodplain crossings are more than 1,000 feet in length.

No NRHP sites and six recorded cultural sites are within 0.25 mile of Proposed Alternative Route 7-D.

November 2013

Table 3-8 compares the Tier IV criteria of each Proposed Alternative Route with the corresponding portion of the Applicant Proposed Route and summarizes the Tier IV criteria for the Applicant Proposed Route in Region 7. In summary, Clean Line chose the Applicant Proposed Route rather than Proposed Alternative Route 7-D because the Applicant Proposed Route:

- Has 145 fewer residences within 1,000 feet; and
- Crosses fewer NWI-identified forested wetlands and floodplains.

Table 3 8
Region 7 Tier IV Criteria Comparison

Criterion	Unit	AR 7 A (43.23 miles)	Corresponding Links of APR (28.66 miles)	AR 7 B (8.56 miles)	Corresponding Links of APR (8.31 miles)	AR 7 C (23.76 miles)	Corresponding Links of APR (13.18 miles)	AR 7 D (6.24 miles)	Corresponding Links of APR (6.63 miles)	APR Total in Region 7 (42.91 miles)
Existing Infrastructure¹										
Electrical Transmission Lines (69 kV and higher)	Miles	2.95	2.50	0.00	0.00	10.99	0.00	1.34	0.00	2.71
Transmission Pipelines	Miles	0.68	0.48	0.00	0.00	0.00	0.00	0.00	0.00	0.48
Railroads	Miles	0.43	0.47	0.00	0.00	0.21	0.22	0.27	0.22	0.69
Publically Maintained Federal, State, and County Roads	Miles	10.76	2.18	0.00	0.00	4.60	0.33	0.28	0.33	2.51
Total Paralleling Existing Linear Infrastructure	Miles	14.18	4.58	0.00	0.00	11.69	0.55	1.75	0.55	5.34
Land Cover										
Parcels and Parcel Boundaries	Number	13	5	25	21	34	42	35	25	51
Agriculture and Open Lands										
NLCD Pasture / Hay	Miles	0.04	0.00	1.28	1.12	3.05	1.57	1.19	1.38	1.57
NLCD Barren Land	Miles	0.00	0.00	0.00	0.00	0.00	0.00	0.00	0.00	0.00
NLCD Grassland / Herbaceous	Miles	0.00	0.00	0.00	0.00	0.00	0.00	0.00	0.00	0.00
NLCD Shrub / Scrub	Miles	0.00	0.00	1.26	1.50	1.83	2.16	0.93	0.66	2.16
NLCD Cultivated Crops	Miles	33.14	22.13	3.66	3.18	13.07	5.39	3.00	3.01	28.26
Total Agriculture and Open Lands	Miles	33.19	22.13	6.20	5.80	17.96	9.12	5.13	5.05	31.98
Forested Areas	Miles	0.03	0.03	1.95	2.28	2.61	3.41	0.61	1.12	3.43
Urban/Developed Areas	Miles	4.85	3.58	0.40	0.21	2.59	0.42	0.18	0.24	4.34
Structures										
K-12 Schools, Colleges and Universities										
0-100 ft	Number	0	0	0	0	0	0	0	0	0
100-250 ft	Number	0	0	0	0	0	0	0	0	0
250-500 ft	Number	0	0	0	0	0	0	0	0	0
500-1,000 ft	Number	0	0	0	0	0	0	0	0	0
Churches	Number	0	0	0	0	0	0	0	0	0
0-100 ft	Number	0	0	0	0	0	0	0	0	0
100-250 ft	Number	0	0	0	0	0	0	0	0	0
250-500 ft	Number	0	0	0	0	2	1	0	1	1
500-1,000 ft	Number	0	0	0	0	1	1	0	1	1
Hospitals	Number	0	0	0	0	0	0	0	0	0
0-100 ft	Number	0	0	0	0	0	0	0	0	0
100-250 ft	Number	0	0	0	0	0	0	0	0	0
250-500 ft	Number	0	0	0	0	0	0	0	0	0
500-1,000 ft	Number	0	0	0	0	0	0	0	0	0
Residences	Number	0	0	0	0	0	0	0	0	0
0-100 ft	Number	0	0	0	0	0	0	0	0	0
100-250 ft	Number	3	2	9	1	9	5	0	5	7
250-500 ft	Number	7	8	40	6	67	13	30	9	18
500-1,000 ft	Number	19	7	102	31	330	48	152	23	55

Table 3.8
Region 7 Tier IV Criteria Comparison

Criterion	Unit	AR 7 A (43.23 miles)	Corresponding Links of APR (28.66 miles)	AR 7 B (8.56 miles)	Corresponding Links of APR (8.31 miles)	AR 7 C (23.76 miles)	Corresponding Links of APR (13.18 miles)	AR 7 D (6.24 miles)	Corresponding Links of APR (6.63 miles)	APR Total in Region 7 (42.91 miles)
Agricultural, Commercial, and Industrial Structures	0-100 ft	0	0	0	0	0	2	0	0	2
	100-250 ft	2	0	8	0	11	4	0	4	4
	250-500 ft	6	0	4	5	16	11	2	7	11
	500-1,000 ft	6	3	27	20	56	31	40	13	34
Government Jurisdictions										
Cities and Towns	Miles	0.00	0.00	1.70	0.11	8.28	1.32	1.21	1.32	1.32
National Forests (U.S. Forest Service) - Administrative Boundary	Miles	0.00	0.00	0.00	0.00	0.00	0.00	0.00	0.00	0.00
National Forests (U.S. Forest Service) - Owned	Miles	0.00	0.00	0.00	0.00	0.00	0.00	0.00	0.00	0.00
National Wildlife Refuges (USFWS)	Miles	0.00	0.00	0.00	0.00	0.00	0.00	0.00	0.00	0.00
National Parks (National Park Service)	Miles	0.00	0.00	0.00	0.00	0.00	0.00	0.00	0.00	0.00
USACE Lands	Miles	0.00	0.00	0.00	0.00	0.00	0.00	0.00	0.00	0.00
DOD Lands	Miles	0.00	0.00	0.00	0.00	0.00	0.00	0.00	0.00	0.00
State Parks	Miles	0.00	0.00	0.00	0.00	0.00	0.00	0.00	0.00	0.00
Oklahoma State Parks (Oklahoma Tourism and Recreation Department)	Miles	0.00	0.00	0.00	0.00	0.00	0.00	0.00	0.00	0.00
Arkansas State Parks (Arkansas Department of Parks and Tourism)	Miles	0.00	0.00	0.00	0.00	0.00	0.00	0.00	0.00	0.00
Tennessee State Parks (Tennessee Department of Environment and Conservation, Division of Parks and Conservation, State Parks)	Miles	0.00	0.00	0.00	0.00	0.00	0.00	0.00	0.00	0.00
State-Owned WMAs	Miles	0.00	0.00	0.00	0.00	0.00	0.00	0.00	0.00	0.00
Oklahoma WMAs (Oklahoma Department of Wildlife Conservation)	Miles	0.00	0.00	0.00	0.00	0.00	0.00	0.00	0.00	0.00
Arkansas WMAs (Arkansas Game and Fish Commission)	Miles	0.00	0.00	0.00	0.00	0.00	0.00	0.00	0.00	0.00
Tennessee WMAs (Tennessee Wildlife Resources Agency)	Miles	0.00	0.00	0.00	0.00	0.00	0.00	0.00	0.00	0.00
Arkansas Leased WMAs (Arkansas Game and Fish Commission)	Miles	0.00	0.00	0.00	0.00	0.00	0.00	0.00	0.00	0.00
Oklahoma School Lands (The Commissioners of the Land Office)	Miles	0.00	0.00	0.00	0.00	0.00	0.00	0.00	0.00	0.00
Arkansas Natural Areas (Arkansas Natural Heritage Commission)	Miles	0.00	0.00	0.00	0.00	0.00	0.00	0.00	0.00	0.00
Tennessee Natural Areas (Tennessee Department of Environment and Conservation, Division of Natural Areas, Natural Areas Program)	Miles	0.00	0.00	0.00	0.00	0.00	0.00	0.00	0.00	0.00
County-, City-, and Town-owned Lands that are managed for conservation or recreation	Miles	0.00	0.00	0.00	0.00	0.00	0.00	0.00	0.00	0.00
Tribal Trust Lands and Allotments	Miles	0.00	0.00	0.00	0.00	0.00	0.00	0.00	0.00	0.00
Conservation Easements or Areas										
Federal Conservation Easements	Miles	0.00	0.07	0.00	0.00	0.00	0.00	0.00	0.00	0.07
State Conservation Easements	Miles	0.00	0.00	0.00	0.00	0.00	0.00	0.00	0.00	0.00
TNC Conservation Easements	Miles	0.00	0.07	0.00	0.00	0.00	0.00	0.00	0.00	0.07
Soil, Geologic, or Topographic Resources										
Prime Farmland	Miles	4.00	2.72	3.93	3.94	15.81	6.15	3.44	3.84	9.94
Farmlands of Statewide Importance	Miles	0.27	0.57	0.00	0.00	0.00	0.00	0.00	0.00	0.57
Slopes Greater than 20%	Miles	0.00	0.00	0.32	0.68	0.32	0.68	0.00	0.00	0.68
Karst Areas	Miles	0.00	0.00	0.00	0.00	0.00	0.00	0.00	0.00	0.00

Table 3 8
Region 7 Tier IV Criteria Comparison

Criterion	Unit	AR 7 A (43.23 miles)	Corresponding Links of APR (28.66 miles)	AR 7 B (8.56 miles)	Corresponding Links of APR (8.31 miles)	AR 7 C (23.76 miles)	Corresponding Links of APR (13.18 miles)	AR 7 D (6.24 miles)	Corresponding Links of APR (6.63 miles)	APR Total in Region 7 (42.91 miles)
Airport / Airfields										
Military Airports	Miles	0.00	0.00	0.00	0.00	0.00	0.00	0.00	0.00	0.00
FAA-Registered Public Airports	Number	0	0	0	0	0	0	0	0	0
FAA-Registered Private Airports	Number	1	0	0	0	1	0	0	0	0
Other Private Airstrips and Helipads	Number	0	0	0	0	0	0	0	0	0
Biological Resources										
USFWS-Designated Critical Habitat	Miles	0.00	0.00	0.00	0.00	0.00	0.00	0.00	0.00	0.00
Native Prairies	Miles	0.00	0.00	0.00	0.00	0.00	0.00	0.00	0.00	0.00
State Natural Heritage Program Species Location Data – Occurrence Records	Number	21	13	10	10	28	10	0	0	27
Arkansas Natural Heritage Program Species Location Data – Focal Areas	Miles	0.00	0.00	0.00	0.00	0.00	0.00	0.00	0.00	0.00
Arkansas Natural Heritage Program Species Location Data – Sensitive Streams	Number	0	0	0	0	0	0	0	0	0
Arkansas Natural Heritage Program Species Location Data – Designated Streams	Number	0	0	0	0	0	0	0	0	0
LEPC Potential Habitat: ODWC OLEPCSPT	Miles	0.00	0.00	0.00	0.00	0.00	0.00	0.00	0.00	0.00
LEPC Potential Habitat – WGA SGP CHAT - Rank 1	Miles	0.00	0.00	0.00	0.00	0.00	0.00	0.00	0.00	0.00
LEPC Potential Habitat – WGA SGP CHAT - Ranks 2 and 3	Miles	0.00	0.00	0.00	0.00	0.00	0.00	0.00	0.00	0.00
Existing Impacted Areas within LEPC Habitat - CHAT Rank 1	Miles	0.00	0.00	0.00	0.00	0.00	0.00	0.00	0.00	0.00
Existing Impacted Areas within LEPC Habitat - CHAT Ranks 2 and 3	Miles	0.00	0.00	0.00	0.00	0.00	0.00	0.00	0.00	0.00
Existing Impacted Areas within LEPC Habitat - OLEPCSPT Ranks 4-8	Miles	0.00	0.00	0.00	0.00	0.00	0.00	0.00	0.00	0.00
GRPC Potential Habitat: ODWC OGRPCSPT	Miles	0.00	0.00	0.00	0.00	0.00	0.00	0.00	0.00	0.00
Whooping Crane Migratory Stopover Locations	Miles	0.00	0.00	0.00	0.00	0.00	0.00	0.00	0.00	0.00
Ozark Big-Eared Bat Potential Occurrence Areas	Miles	0.00	0.00	0.00	0.00	0.00	0.00	0.00	0.00	0.00
Indiana Bat Potential Occurrence Areas	Miles	4.19	2.16	8.31	8.31	23.76	13.18	6.24	6.63	16.41
Gray Bat Potential Occurrence Areas	Miles	0.00	0.00	0.00	0.00	0.00	0.00	0.00	0.00	0.00
Known Bat Caves	Number	0	0	0	0	0	0	0	0	0
American Burying Beetle Potential Occurrence Areas	Miles	0.00	0.00	0.00	0.00	0.00	0.00	0.00	0.00	0.00
Water Resources										
NWI Forested Wetlands	Miles	0.65	1.44	0.05	0.05	0.52	0.05	0.29	0.00	1.49
NWI Non-Forested Wetlands	Miles	0.16	0.15	0.00	0.00	0.00	0.00	0.00	0.00	0.15
NWI Forested Wetland Crossings >1,000 ft	Number	0	0	0	0	0	0	0	0	0
NWI Non-Forested Wetland Crossings >1,000 ft	Number	0	0	0	0	0	0	0	0	0
NLCD Forested Wetlands	Miles	4.60	2.15	0.00	0.00	0.41	0.22	0.28	0.22	2.37
NLCD Non-Forested Wetlands	Miles	0.00	0.00	0.00	0.00	0.20	0.02	0.04	0.00	0.02
NLCD Forested Wetland Crossings >1,000 ft	Number	7	0	0	0	0	0	0	0	4
NLCD Non-Forested Wetland Crossings >1,000 ft	Number	0	0	0	0	0	0	0	0	0
Floodplains - Length Crossed	Miles	17.15	16.72	1.77	1.77	6.59	2.38	2.33	1.43	20.18
Floodplains - Crossings Greater than 1,000 ft	Number	9	3	0	0	9	0	5	0	18
Major Waterbodies and Reservoirs - Number Intersected	Number	1	2	0	0	0	0	0	0	1
Major Waterbodies and Reservoirs - Distance Crossed	Miles	0.69	0.89	0.00	0.00	0.00	0.00	0.00	0.00	0.89

Table 3.8
Region 7 Tier IV Criteria Comparison

Criterion	Unit	AR 7 A (43.23 miles)	Corresponding Links of APR (28.66 miles)	AR 7 B (8.56 miles)	Corresponding Links of APR (8.31 miles)	AR 7 C (23.76 miles)	Corresponding Links of APR (13.18 miles)	AR 7 D (6.24 miles)	Corresponding Links of APR (6.63 miles)	APR Total in Region 7 (42.91 miles)
State-Designated Waterbodies with Special Significance	Number	1	0	0	0	0	0	0	0	1
Other Waterbodies	Number	6	8	0	0	3	1	0	1	9
Springs 0-250 ft	Number	0	0	0	0	0	0	0	0	0
Springs 250-500 ft	Number	0	0	0	0	0	0	0	0	0
Wild and Scenic Rivers	Number	0	0	0	0	0	0	0	0	0
Visual / Cultural Resources										
Federally and State-Designated Scenic Routes, Trails, and Byways	Number	3	3	0	0	0	0	0	0	3
Sites on the NRHP	Number	0	0	0	0	0	0	0	0	0
Recorded Cultural or Historical Sites										
Archaeological Sites	Number	9	3	6	5	9	5	6	1	9
GLO Sites	Number	0	0	0	0	0	0	0	0	0
Historical Sites	Number	3	0	0	0	1	13	0	13	13
Total Recorded Cultural or Historical Sites	Number	12	3	6	5	10	18	6	14	22
Cemeteries	Number	0	0	0	0	1	0	0	0	0
Environmentally Regulated Sites										
Known Contaminated Sites	Number	0	0	0	0	0	0	0	0	0
Engineering Considerations										
Total Length of the Transmission Line	Miles	43.23	28.66	8.56	8.31	23.76	13.18	6.24	6.63	42.91
Electrical Transmission Line Crossings										
69KV-345KV intersected by the representative centerline	Number	4	4	0	0	0	0	0	0	4
Greater than 345KV intersected by the representative centerline	Number	0	0	0	0	0	0	0	0	0
Transmission Pipeline Crossings	Number	3	2	0	0	0	0	0	0	2
Major Road Crossings	Number	5	5	0	0	2	2	2	2	7
Railroad ROW Crossings	Number	2	2	0	0	1	1	1	1	3

Notes:
1. Miles of existing infrastructure are determined by measuring the length of the representative centerline intersection with a 500-foot buffer to each side of existing infrastructure. Crossings of existing infrastructure are included in this total and can add approximately 1,000 to 1,500 feet of length per crossing, depending on the angle of intersection. The Engineering Considerations section presents the number of crossings for each type of existing infrastructure. The Routing Team considered this additional length during the route identification process, and Pair ed-Node Analyses.

Key:
APR = Applicant Proposed Route.
AR = Alternative Route.
DOD = (United States) Department of Defense.
FAA = Federal Aviation Administration.
GLO = General Land Office.
GRPC = greater prairie-chicken.
KV = kilovolt(s).
LEPC = lesser prairie-chicken.
NLCD = National Land Cover Dataset.
NRHP = National Register of Historic Places.
NWI = National Wetlands Inventory.
USACE = United States Army Corps of Engineers.
USFWS = United States Fish and Wildlife Service.
WGA = Western Governors Association.
WMA = Wildlife Management Area.

ODWC = Oklahoma Department of Wildlife Conservation.
OGRPCSP = Oklahoma Greater Prairie-Chicken Spatial Planning Tool.
OLEPCSPT = Oklahoma Lesser Prairie-Chicken Spatial Planning Tool.
ROW = right-of-way.
SGP CHAT = Southern Great Plains Crucial Habitat Assessment Tool.
TNC = The Nature Conservancy.

4.0 Geographic Information System Data Sources

The Routing Team made extensive use of information from existing GIS data that were obtained from a variety of sources during the Tier IV route identification process (see Section 5.0 for a complete list of references). These sources included federal, state, and municipal governments, and NGOs. Most information was obtained through official agency GIS data access websites or provided directly to Clean Line by government agencies. The Routing Team utilized the GIS data obtained previously during Tiers I, II, and III of the route study process (see Section 6.0 of the **Project Siting Narrative** [Clean Line 2013k]) and obtained updates to these data, or new data, as necessary and available, during the Tier IV route identification process. Some data were developed through aerial photo interpretation using best available data at the time; verified information from stakeholder comments received by Clean Line and scoping comments received by the DOE during the scoping period (see Section 3.3.2); and the findings of the aerial reconnaissance performed by the Routing Team in August 2013 (see Section 3.3.2 and Appendix C) or a combination of these three sources.

GIS information is an effective tool for broad planning studies, identifying landscape-level opportunities and sensitivities, and for comparison of environmental issues between alternatives. Due to variations in the age and specificity of some GIS data, however, the Routing Team exercised professional judgment when evaluating and interpreting the data and comparing alternatives.

This page intentionally left blank.

5.0 References

In addition to documentation, the following sources pertain to shapefiles and other data files used in this **Tier IV Routing Study**. Refer to Section 4.0, "Geographic Information System Data Source," for a full explanation.

- Arkansas Department of Environmental Quality (ADEQ). 2012. Extraordinary Resource Waters Segments.
<http://www.geostor.arkansas.gov/G6/Home.html?id=8f1a225ee4b8d1a830fefdd95b37890d>
Accessed July 2012.
- Arkansas Game and Fish Commission (AGFC). 2013. Google Earth KMZ of AGFC WMA Boundary Representation- Leased Lands Only. Arkansas Fish and Game Commission Website.
<http://www.agfc.com/resources/pages/googleearthmaps.aspx>.
- . 2005 (ongoing). Wildlife Management Area Boundary.
<http://www.geostor.arkansas.gov/G6/Home.html?id=34339f1b592d09c009dda083ef643329>.
Accessed December 3, 2012.
- Arkansas Natural Heritage Commission (ANHC). n.d.(a). Arkansas ANHC Element Occurrence Record Data File. Obtained July 16, 2013. Data considered confidential; graphical representation of data prohibited.
- . n.d.(b). Arkansas ANHC Natural Areas Within the Study Corridors. Obtained May 11, 2011. Data considered confidential; graphical representation of data prohibited.
- . n.d.(c). Arkansas ANHC Sensitive Streams Within the Study Corridors. Obtained July 16, 2013. Data considered confidential; graphical representation of data prohibited.
- . n.d.(d). Arkansas ANHC Special Designated Streams Within the Study Corridors. Data File. Obtained July 16, 2013. Data considered confidential; graphical representation of data prohibited.
- . n.d.(e). Arkansas ANHC Wetland Easement Areas Within the Study Corridors. Obtained May 11, 2011. Data considered confidential; graphical representation of data prohibited.
- Arkansas State Highway and Transportation Department (AHTD). 2006. Arkansas State Parks.
- . n.d. Scenic Highways and Byways. Obtained February 24, 2013.
- Bureau of Indian Affairs (BIA). n.d.(a). Iowa Nation Tribal Trust Land. Obtained from TetraTech 2013.
- . n.d.(b). Pawnee Surface Tracts. Obtained 2012. Data considered confidential; graphical representation of data prohibited.
- Bureau of Transportation Statistics. 2008. Public Use Airports, USA.
<http://geocommons.com/overlays/6054>.

November 2013

- Clean Line Energy Partners (Clean Line). 2012a. Digitized Parcel and Parcel Boundaries in Oklahoma and Arkansas, Created by Clean Line from Subcontracted Services and County Tax Roll Data.
- . 2012b. Digitized Parcel and Parcel Boundaries in Shelby and Tipton Counties, Tennessee. Created by Clean Line from Property Appraiser's Office Data.
- . 2013a. Aerial Reconnaissance Summary of Findings Report for the Plains & Eastern Clean Line. August 2013.
- . 2013b. Digitized Agricultural, Commercial, and Industrial Structures, and Residences Data Layer in the Vicinity of the Plains & Eastern Clean Line Project, Created by Clean Line via Stakeholder Comments Received by Clean Line (2010-2012) and Scoping Comments Received by DOE During the Scoping Period (December-March 2013), Supplemented With Aerial Photograph Interpretation and Field Verification Surveys Conducted From Public Roads in 2012 and 2013.
- . 2013c. Digitized American Burying Beetle Potential Occurrence Area Data Layer in the Vicinity of the Plains & Eastern Clean Line Project, Created by Clean Line via Selection of Certain USGS NLCD 2006 Categories Within Counties of Occurrence Based on Habitat Requirements Identified in the USFWS American Burying Beetle (*Nicrophorus americanus*) 5-Year Review: Summary and Evaluation (USFWS 2008).
- . 2013c. Digitized Cemeteries Data Layer in the Vicinity of the Plains & Eastern Clean Line Project, Created by Clean Line via Aerial Photograph Interpretation and Field Verification Surveys Conducted From Public Roads in 2012 and 2013.
- . 2013d. Digitized Churches, Hospitals, K-12 Schools, Colleges and Universities Data Layer in the Vicinity of the Plains & Eastern Clean Line Project, Created by Clean Line via ESRI 2010 Data Supplemented With Aerial Photograph Interpretation and Field Verification Surveys Conducted in 2012 and 2013.
- . 2013e. Digitized Private Airstrips and Helipads, Data Layer in the Vicinity of the Plains & Eastern Clean Line Project, Created by Clean Line via Stakeholder Comments Received by Clean Line (2010-2012) and Scoping Comments Received by DOE During the Scoping Period (December-March 2013), Supplemented With Aerial Photograph Interpretation.
- . 2013f. Digitized Transmission Structures and Derived Electrical Transmission Lines (69kV and higher) Data Layer in the Vicinity of the Plains & Eastern Clean Line Project, Created by Clean Line via Aerial Photograph Interpretation.
- . 2013g. Major Waterbodies Data Layer in the Vicinity of the Plains & Eastern Clean Line Project, Created by Clean Line via Aerial Photograph Interpretation and Review of Environmental Systems Resource Institute (ESRI). 2012. ArcMap 10.1. ESRI, Redlands, California.
- . 2013h. Oklahoma School Lands Data Layer in the Vicinity of the Plains & Eastern Clean Line Project, Created by Clean Line from Individual Property Appraiser's Office Data.
- . 2013i. Potential Tribal Trust Lands in the Vicinity of the Plains & Eastern Clean Line Project, Created by Clean Line via Consultation with the Bureau of Indian Affairs. Data considered confidential; graphical representation of data prohibited.

November 2013

———. 2013j. Preliminary Draft Project Description for the Plains & Eastern Clean Line. July 26, 2013.

———. 2013k. Project Siting Narrative for the Plains & Eastern Clean Line. May 2013.

Department of Energy. 2013. Plains and Eastern Project Scoping Summary Report, Draft Final Report, June 2013. Prepared by Tetra Tech, 1099 18th Street, Suite 580, Denver, Colorado, 80202.

Environmental Systems Resource Institute (ESRI). 2010. <http://www.esri.com/data/data-maps/data-and-maps-dvd.html>. ESRI, Redlands California.

———. 2012. ArcMap 10.0. ESRI, Redlands, California.

Federal Aviation Administration (FAA). 2010. Digital Aeronautical Flight Information File, 2010. <http://geocommons.com/overlays/6054>.

Federal Emergency Management Agency. 2013. Flood Maps. <https://msc.fema.gov/webapp/wcs/stores/servlet/FemaWelcomeView?storeId=10001&catalogId=10001&langId=-1>. Accessed July 2013.

Haufler, Jonathan B., Grant Beauprez, David Klute, Sean Kyle, Jim Pitman, Doug Schoeling, Bill Van Pelt, and Christian Hagan. April 1, 2013. *Range-wide Conservation Plan for the Lesser Prairie-chicken*. http://www.wafwa.org/documents/AprilDraftLEPCPlanSubmittedUSFWS04_02_2013.pdf.

Kyle, Sean. 2013. Wildlife Diversity Biologist, Texas Parks and Wildlife Department. Personal Communication (email) to Jason Thomas. June 6, 2013.

National Atlas of the United States. 2006. Federal Lands of the United States: National Atlas of the United States. <http://nationalatlas.gov/atlasftp.html?openChapters=chpbound#chpbound>.

National Geographic Society. 2013. United States Geographic Service 1:24,000 Topographic Quadrangle Maps.

National Park Service (NPS). 2010. National Register of Historic Places. South Region Points. <http://www.nps.gov/nr/research/>. Accessed 2010.

———. 2013. National Trails of the Intermountain Region, Designated Routes of the Santa Fe National Historic Trail, Old Spanish National Historic Trail, El Camino Real de Tierra Adentro National Historic Trail, El Camino Real de los Tejas National Historic Trail, Mormon Pioneer National Historic Trail, Pony Express National Historic Trail, California National Historic Trail, Oregon National Historic Trail, and Trail of Tears National Historic Trail. Obtained April 9, 2013. Data considered confidential; graphical representation of data prohibited.

Oklahoma Department of Wildlife Conservation (ODWC). 2010a. Oklahoma Greater Prairie Chicken Model. <http://www.wildlifedepartment.com/grpcdevelopmentplanning.htm>. Accessed 2013.

———. 2010b. Oklahoma Lesser Prairie Chicken Model. http://www.wildlifedepartment.com/spatial_planning/lepcdevelopmentplanninggis.htm. Accessed July 2012.

November 2013

———. 2012a. Oklahoma Lesser Prairie Chicken Management Plan: A Collaborative Strategy for Species Conservation. May, 2012.
http://www.wildlifedepartment.com/wildlifemgmt/lepc/OK_LEPC_Management_Plan.pdf.
Accessed July 2012.

———. 2012b. Oklahoma State Wildlife Management Areas. Obtained December 2012.

———. n.d. Oklahoma Conservation Easements. Obtained 2011.

Oklahoma Natural Heritage Inventory. n.d. Oklahoma Natural Heritage Inventory Species Occurrence Records. Obtained June 17, 2013. Data considered confidential; graphical representation of data prohibited.

Oklahoma Water Resources Board. 2011. Streams of Oklahoma.
http://www.owrb.ok.gov/maps/pmg/owrbdata_SW.html. Accessed 2013.

———. 2012. Lakes of Oklahoma. http://www.owrb.ok.gov/maps/pmg/owrbdata_SW.html. Accessed 2013.

SWCA Environmental Consultants. n.d. Archaeological, Historical, and GLO Sites in the Vicinity of the Plains & Eastern Clean Line Project.

Tennessee Department of Environmental Conservation (TDEC). 2011. Tennessee Natural Areas and State Park Boundaries. TDEC. Tennessee State Parks. January 20, 2011.
<http://www.tn.gov/environment/parks/gis/data/>. Accessed 2013.

———. n.d. Water Quality Assessment, Stream Use and Attainment, Siltation Impaired Streams and Waterbodies, Siltation Impaired Drainages, TDECLANDS, High Quality Streams, Water Pollution Monitoring Sites, and Water Pollution Permits.

Tennessee Natural Heritage Program. n.d. Tennessee Element Occurrence Polygons. Data considered confidential; graphical representation of data prohibited.

Tennessee Wildlife Resources Agency (TWRA). 2007. TWRA Lands Including Tennessee State Wildlife Management Areas.

The Conservation Registry. 2012. National Conservation Easement Database.
<http://www.conservationeasement.us/>. Accessed July 2013.

The Nature Conservancy (TNC). 2011. Ecoregional Portfolio. http://maps.tnc.org/gis_data.html.
Accessed July 2012.

The Nature Conservancy (TNC) Arkansas. n.d. Arkansas Natural Heritage Commission's Focal Areas for Acquisition and Conservation.

The Nature Conservancy (TNC) Oklahoma. 2002. Known Bat Caves. Obtained 2010. Data considered confidential; graphical representation of data prohibited.

———. 2008. Oklahoma Terrestrial Conservation Areas.

November 2013

United States Army Corps of Engineers (USACE), Little Rock District. n.d. Section 404 Mitigation Areas Near Cadron Creek, USACE mitigation banks, USACE district lines, and USACE-owned/managed property. Obtained February 5, 2013 (Section 404 Mitigation Areas Near Cadron Creek Only).

United States Army Corps of Engineers (USACE), Tulsa District. n.d. Dredge Disposal Sites for the Arkansas River Dredging Project and Tulsa District-Managed Lands and Future Approved Projects. Obtained February 27, 2013.

United States Department of Agriculture (USDA) National Resources Conservation Service (NRCS). 2012. Soil Survey Geographic (SSURGO) database. <http://soildatamart.nrcs.usda.gov>. Accessed 2012.

———. n.d. Wetland Reserve Program, Healthy Forests Reserve Program, and Grassland Reserve Program Easement Locations. Obtained February 5, 2013.

United States Department of Agriculture (USDA), United States Forest Service. 2003. Ozark National Forest Administrative Boundary.

———. 2009a. U.S. Forest Service Ownership Boundaries (Basic Ownership). <http://fsgeodata.fs.fed.us/vector/lrsr.php>. Accessed September 10, 2013.

———. 2009b. Wild and Scenic Rivers. USDA-Forest Service Recreation Solutions. <http://www.rivers.gov/maps.html>.

———. 2010. Cibola National Forest Ranger District Boundary.

United States Environmental Protection Agency (USEPA). 2013. Geospatial Data. http://www.epa.gov/enviro/geo_data.html. Accessed 2013.

United States Fish and Wildlife Service (USFWS). 2007. Indiana Bat (*Myotis sodalis*) Draft Recovery Plan: First Revision, USFWS (April 2007), Great Lakes-Big Rivers Region-Region 3, Fort Snelling, Minnesota.

———. 2008a. American Burying Beetle (*Nicrophorus americanus*) 5-Year Review; Summary and Evaluation, USFWS, New England Field Office, Concord, New Hampshire.

———. 2008b. Ozark Big-Eared Bat (*Corynorhinus townsendii ingens*), 5-Year Review: Summary and Evaluation, prepared by Richard Stark, USFWS, Oklahoma Ecological Services Field Office, Tulsa, Oklahoma.

———. 2009. Gray Bat (*Myotis grisescens*) 5-Year Review: Summary and Evaluation, Prepared by USFWS Midwest Region, Columbia, Missouri Ecological Services Field Office, Columbia, Missouri.

———. 2012a. FWS Critical Habitat for Threatened & Endangered Species. <http://criticalhabitat.fws.gov/crithab/>. Accessed July 2012.

———. 2012b. National Wetlands Inventory. <http://www.fws.gov/wetlands/>. Accessed July 2012.

———. 2012c. USFWS Cadastral Geodatabase. <http://www.fws.gov/GIS/data/CadastralDB/index.htm>. Accessed July 2012.

November 2013

- . 2013a. Letter Dated April 10, 2013 from Joy E. Nicholopoulos, Acting Regional Director, USFWS, Post Office Box 1306, Albuquerque, New Mexico, 87103 to Melissa Ardis Project Leader, DOE, Plains & Eastern Clean Line EIS.
- . March 2013b. Operational wind turbines. http://www.fws.gov/southwest/es/Energy_Wind_FAA.html. Accessed April 1, 2013.
- . n.d. Arkansas Karst Topography.
- United States Fish and Wildlife Service (USFWS) Nebraska Field Office. 2010. Incidental Sightings of Whooping Cranes during Migration. Cooperative Whooping Crane Tracking Project.
- United States Geological Service (USGS). 2005. Karst, Engineering Aspects. <http://nationalatlas.gov/atlasftp.html?openChapters=chpgeol#chpgeol>. Accessed July 2012.
- . 2006. Multi Resolution Land Characteristics Consortium. National Land Cover Database. <http://www.mrlc.gov/>. Accessed July 2012.
- . 2009. National Elevation Dataset. <http://ned.usgs.gov/downloads.asp>.
- . 2010. National Agricultural Imagery Program (NAIP), Aerial Imagery, 2010.
- . National Hydrography Dataset. 2012. <http://nhd.usgs.gov/data.html>. Accessed November 27, 2012.
- University of Kansas. Kansas Applied Remote Sensing (KARS) Program. 2013. Southern Great Plains Crucial Habitat Assessment Tool. <http://kars.ku.edu:80/geonetwork?uuid=e4cda6ca-00e6-425e-90e5-621f6379b4dc>. Accessed July 31, 2013.
- Ventyx. 2013. Existing and Proposed Intra- and Inter-State Transmission Pipelines. 2013. Distribution of data to entities outside of Clean Line prohibited.
- Whooping Crane Conservation Association. "Illustrating the Whooping Crane Migration Corridor in the Central Flyway." *Grus Americana* 48 (May 2009): 6. <http://whoopingcrane.com/wp-content/uploads/2011/05/Spring2009newsletter1.pdf>

Appendix A

Tier IV Siting Criteria

This page intentionally left blank.

Tier IV Siting Criteria

for the

PLAINS & EASTERN

CLEAN LINE

June 14, 2013
(Received DOE Approval)

*Revised October 2013
(Table 1)*

Prepared for:



Prepared by:



This page intentionally left blank.

Tier IV Siting Criteria

This document presents the process and criteria to be used by Clean Line Energy Partners LLC (Clean Line) to identify Proposed Alternative Routes (defined in Section 1.2 below) for the high-voltage direct current (HVDC) transmission line portion of the Plains and Eastern Clean Line Transmission Project (the Project). Clean Line developed this process and criteria in consultation with the Department of Energy (DOE) and the DOE's NEPA contractor, TetraTech.

1.0 Development Process for the HVDC Transmission Line Proposed Alternative Routes

After identifying the Network of Potential Routes published with the notice of intent (NOI) and following the completion of the DOE's National Environmental Policy Act (NEPA) public scoping process, Clean Line began the next level (Tier IV) of the HVDC transmission line route development process. Starting with the Network of Potential Routes, Clean Line will use the process described herein to develop Proposed Alternative Routes (each 1,000 feet wide). The Proposed Alternative Routes and the supporting data analysis will be provided to the DOE for its independent evaluation.

The Routing Team (defined in Section 1.1 below) met with DOE and Tetra Tech staff on April 29 & 30, 2013, to discuss this Tier IV process and review siting criteria. During that meeting, the Routing Team, DOE, and Tetra Tech agreed to the general principles and criteria to be used in the Tier IV process. This document memorializes those discussions and subsequent efforts (in May and early June 2013) between the Routing Team, DOE and TetraTech to refine and finalize the Tier IV process and criteria. This document is intended to confirm the common understanding between DOE, Tetra Tech and Clean Line with respect to the parameters and process to be used by the Routing Team in the Proposed Alternative Route development process.

1.1 Routing Team

Clean Line will continue to employ a multi-disciplinary team of professionals, referred to hereinafter as the "Routing Team," to undertake this Tier IV of the route development process. The Routing Team includes Clean Line employees and representatives from Clean Line's technical team, including members from Ecology and Environment, Inc. (general Environmental Consultant), SWCA Environmental Consultants (cultural and historical resources consultant), and Pike Energy Solutions (engineering and construction consultant).

1.2 Transmission Line Routing Terminology

During previous phases of the route development process, the Routing Team developed the following common terms to describe the components of the network. The following terms have been used throughout each Tier of the route development process, and will continue to be used during Tier IV:

- *Segments* – Geographic divisions of a network, generally where several Links overlap at a common Node.
- *Node* – A point of intersection of potential routes within a network.
- *Link* – A portion of a route between Nodes within a network.

The following terms correspond to degrees of refinement of the network through the route development process, starting with terms used to describe the Network of Potential Routes published with the NOI and narrowing to the Proposed Alternative Routes:

- *Network of Potential Routes* – The series of intersecting routes that was presented to the DOE for review in the NEPA scoping process.
- *Alternative Route* - An area 1000-feet wide generally located within and refined from the Network of Potential Routes using the Tier IV criteria and route development process.
- *Proposed Alternative Routes* – Several Alternative Routes proposed by Clean Line to DOE for analysis as the HVDC transmission line route alternatives in the Environmental Impact Statement.

In addition, throughout the Tier IV process, the Routing Team will continue to use the terms *opportunities* and *sensitivities*. As explained in the Project Siting Narrative (Clean Line, May 2013), *opportunities* encompass pre-existing linear infrastructure features along which transmission line development is considered generally compatible. Examples include existing federal, state and county roads; existing electric transmission lines; railroads; and existing transmission pipelines. *Sensitivities* encompass various resources that potentially limit or conflict with transmission line development. Examples include areas restricted by regulations or covenants/easements limiting transmission line development, pre-existing incompatible land uses, or other locations containing natural or man-made resources that are subject to protection and/or that are difficult to mitigate (e.g., threatened and endangered species habitat, residential and commercial development, cultural and historic resources, etc.).

1.3 Development Process for the Proposed Alternative Routes

This Section explains the process the Routing Team will use to develop the Proposed Alternative Routes. Section 1.3.1 identifies the General and Technical Guidelines developed by the Routing Team to guide the Alternative Route development process. Section 1.3.2 will describe the process and criteria used by the Routing Team to identify the Proposed Alternative Routes. The Tier IV analysis will integrate information from, and build upon, the information gained in the prior Tiers, as described in the Project Siting Narrative.

1.3.1 Development of General and Technical Guidelines

As explained in the Project Siting Narrative, the Routing Team has developed General and Technical Guidelines for use throughout the route development process, including the Tier IV process. The General Guidelines are intended to minimize conflicts with existing resources, developed areas, and existing incompatible infrastructure; to maximize opportunities for paralleling existing compatible infrastructure; and to take into consideration land use and other factors affecting route development and identification. The General Guidelines included the following:

- Utilize existing linear corridors to the extent practicable;
- Utilize areas with land uses/land cover that are consistent or compatible with linear utility uses, such as existing utility corridors and open lands, to the extent practicable;
- Avoid existing residences;
- Avoid nonresidential structures, including barns, garages, and commercial buildings;
- Minimize interference with the use and operation of existing schools, known places of worship, and existing facilities used for cultural, historical, and recreational purposes;

- Avoid cemeteries or known burial places;
- Minimize adverse effects to economic activities (e.g., impacts to existing residences, businesses and developed areas);
- Minimize crossing of designated public resource lands, including, but not limited to, national and state forests and parks, large camps and other recreation lands, designated battlefields or other designated historic resources and sites, and state-owned wildlife management areas;
- Minimize crossings of tribal trust lands and allotments;
- Minimize the number and length of crossings of large lakes, major rivers, large wetland complexes, or other sensitive water resources;
- Minimize adverse effects on protected species habitat, and adverse effects on other identified sensitive natural resources (e.g., forested areas, native prairies, and other areas as identified by Natural Heritage Commissions);
- Minimize visibility of transmission lines from residential areas and visually sensitive public locations (e.g., public parks, scenic routes or trails, and designated Wild and Scenic Rivers);
- Avoid areas of past environmental contamination to the extent practicable; and
- Minimize route length, circuitry, special design requirements and impractical construction requirements.

The Technical Guidelines are specific to the Project. These are based on technical limitations related to the design, right-of-way requirements, or reliability concerns. The Technical Guidelines are informed by: (1) technical expertise of industry professionals (e.g., civil, structural, and electrical engineers; transmission planners; and other Project Managers) responsible for the reliable and economical construction, operation, and maintenance of the Project and other electric system facilities to which the Project interconnects; (2) North American Electric Reliability Corporation reliability standards; and (3) industry best practices. The Technical Guidelines include the following:

- Minimize the crossing of transmission lines of 345 kilovolt (kV) or above;
- Minimize paralleling corridors with more than one existing circuit of 345 kV or above;
- Maintain 200 feet of centerline-to-centerline separation when paralleling existing transmission lines of 345 kV or above;
- Maintain 150 feet of centerline-to-centerline separation when paralleling 138 kV or lower voltage transmission lines;
- Minimize turning angles in the transmission line greater than 65 degrees¹;
- Minimize the length of the transmission line located on soils sloped more than 20 percent; and
- Minimize underbuild² or double circuit arrangements with existing alternating current infrastructure.

¹ The degrees expressed here represent the angle of a turn measured from a straight line. For example, a straight line is 0 degrees and a light angle would be 3 to 4 degrees.

² "Underbuild" refers to conductors from other circuits that are placed on the same structure, but below HVDC conductors.

1.3.2 Tier IV – Proposed Alternative Routes Development

Following completion of Tier III of the route development and identification process and the NEPA public scoping process, the Routing Team began the fourth round of the route development process (Tier IV). The Tier IV process is intended to narrow and refine the identified Network of Potential Routes to the Proposed Alternative Routes.

At the end of the Tier IV process, the Routing Team will identify the Proposed Alternative Routes, each 1,000 feet wide, which Clean Line will propose to DOE as the HVDC transmission line route alternatives to be evaluated in the EIS.

The steps in the Tier IV process are described below:

- 1. Review and consideration of Stakeholder and Scoping Comments.** Clean Line will review and consider stakeholder comments obtained by Clean Line from 2010 through 2012 and scoping comments received by DOE during the EIS scoping period. The Routing Team will review and verify locational and/or subject-specific information (e.g., residence locations, airstrips/aviation bases, pivot irrigation, planned subdivisions, planned commercial development, known plant and wildlife habitat, refined infrastructure information, commercial recreation areas, cultural resources, etc...) contained in those stakeholder and scoping comments to the extent practicable. Review and verification methods may include review and/or cross-reference with applicable third-party data to: confirm the physical location of features; validate other information provided; and/or obtain additional information pertaining to a specific comment. For example, the Routing Team will use best available aerial imagery to visually confirm the physical location of airstrips and pivot irrigation. Reviewed and verified information is used in developing the Tier IV criteria (step 2 below).
- 2. Development of Tier IV Criteria.** Building on the siting criteria used during Tiers 1 through III of the route development process (*see* Project Siting Narrative, Clean Line, May 2013), the Routing Team developed the Tier IV criteria in consultation with DOE and DOE's NEPA consultant, Tetra Tech. The Tier IV criteria focus on localized opportunities and sensitivities, and information gathered by Clean Line during stakeholder outreach and by the DOE during the EIS scoping period.
- 3. Identification of Alternative Routes.** Following development of the Tier IV criteria, the Routing Team will conduct an iterative route development process to identify Alternative Routes. This process will include identifying potential centerlines for Alternative Routes, reviewing those route centerlines in relation to the Tier IV criteria, completing GIS analysis of each Link in an Alternative Route to evaluate quantifiable siting criteria, comparing Alternative Routes using Paired Node Analysis (*see* 4 below), and eliminating from further consideration potential Links based on the results of the Paired Node Analysis.
- 4. Paired-Node Analysis of Alternative Routes.** As part of the process of identifying and evaluating potential Alternative Routes, the Routing team will compare pairs of Links or series of Links within a relatively small geographic area between two common endpoints. The Routing Team will apply the Tier IV criteria to each to determine their relative opportunities and sensitivities. Based on the results of these comparisons, the Routing Team will eliminate from further consideration Links with relatively fewer opportunities and/or greater sensitivities when compared to other Links within potential Alternative Routes.
- 5. Field Reconnaissance.** Clean Line will conduct field reconnaissance of the Alternative Routes to verify the feasibility of the Alternative Routes from an environmental, engineering, and/or constructability standpoint. Field reconnaissance will be conducted through aerial flyovers and/or ground reconnaissance. If ground reconnaissance is conducted, it will be completed from

a public right-of-way; the reconnaissance teams will not enter private property. Additional Alternative Routes may be identified and additional Paired Node Analysis may be performed (see 3 and 4 above) as a result of new information discovered during Field Reconnaissance.

6. **Development of the Proposed Alternative Routes (each 1,000 feet-wide).** Following Identification of centerlines for Alternative Routes and Field Reconnaissance, the route development process will continue with iterative rounds of Paired Node Analysis (see 3 through 5 above). The Routing Team will reduce the number of Route Alternatives to develop the Proposed Alternative Routes. A buffer of 500 feet will be added on each side of the centerline for each Proposed Alternative Route to create a 1,000 foot wide corridor.

The Routing Team will provide the Proposed Alternative Routes to DOE for DOE's independent evaluation in selecting the routes to be evaluated as alternatives in the Environmental Impact Statement.

1.3.3 Tier IV Criteria

Table 1
Summary of Tier IV Siting Criteria³¹

Criterion		Unit	Measure	Source ¹	Application of Siting Criterion
Existing Infrastructure					
Electrical Transmission Lines (69 Kilovolt [kV] and higher) (Figures 3-1, 3-2, 3-3, 3-5, and 3-6)	Miles	Within 500 feet of the representative centerline	Clean Line 2013 ²	Preference will be given to Alternative Routes that follow existing electrical transmission lines 69kV or greater to the extent practicable. In general, higher voltage electrical transmission lines will be given preference over lower voltage electrical transmission lines. Low-voltage (i.e., less than 69kV) electrical transmission or distribution lines will not be considered an opportunity.	
Transmission Pipelines (Figure 3-3, 3-5, and 3-6)	Miles	Within 500 feet of the representative centerline	Ventyx 2013 ³	Preference will be given to Alternative Routes that follow existing transmission pipelines to the extent practicable. In general, larger diameter transmission pipelines will be given preference over smaller diameter transmission pipelines. Collection and distribution pipelines will not be considered.	
Railroads (Figures 3-1, 3-2, 3-3, 3-5, and 3-6)	Miles	Within 500 feet of the representative centerline	ESRI 2010	Preference will be given to Alternative Routes that follow existing linear railroad rights-of-way (ROWs) to the extent practicable. In general, wider railroad ROWs will be given preference over narrower railroad ROWs.	
Publicly Maintained Federal, State, and County Roads (Figures 3-1, 3-2, 3-3, 3-4, 3-5, 3-6, and 3-7)	Miles	Within 500 feet of the representative centerline	ESRI 2010	Preference will be given to Alternative Routes that follow existing federal, state, and county roads to the extent practicable. In general, roads with a higher functional classification will be given preference over roads with a lower functional classification (e.g., highways will be given preference over collector roads). (Considered together with "Proximity to Existing Access Roads" below.)	
Total Paralleling Existing Linear Infrastructure	Miles	Within 500 feet of the representative centerline	Clean Line 2013 ² ; Ventyx 2013 ³ ; ESRI 2010	This criterion will quantify the total distance that each Alternative Route parallels the existing infrastructure described above.	

Table 1
Summary of Tier IV Siting Criteria³¹

Criterion		Unit	Measure	Source ¹	Application of Siting Criterion
Land Cover					
Parcels and Parcel Boundaries	Number	Intersected by the representative centerline		Clean Line 2012a ⁴ and 2012b ⁴	The Routing Team will consider both the number of parcels crossed by each Alternative Route and where the Alternative Route crosses in relation to the parcel boundaries. The Routing Team will attempt to minimize parcel segmentation by crossing parcels near existing property boundaries to the extent practicable. In addition, preference will be given to Alternative Routes that intersect the fewest number of parcels to the extent practicable.
Agriculture and Open Lands (Figure 3-4)	Miles	Distance along representative centerline		U.S. Geological Survey (USGS) National Aerial Imagery Program (NAIP)/Aerial Imagery 2010 and USGS National Land Cover Database (NLCD) 2006 ^{5, 6}	The USGS NLCD 2006 land cover data will be queried for the following categories to identify agriculture and open lands: Barren Land, Shrub/Scrub, Grassland/ Herbaceous, Pasture/Hay, and Cultivated Crops. Constructing transmission lines in agricultural areas or open lands does not typically require land cover conversion, except at the tower footprint. Preference will be given to Alternative Routes crossing agricultural or open lands as compared to forested and/or urban/developed areas. (Considered together with “Center Pivot Agricultural Fields” below.)
Forested Areas (Figure 3-4)	Miles	Distance along representative centerline		USGS NAIP Aerial Imagery 2010 and USGS NLCD 2006 ^{5, 6}	The USGS NLCD 2006 land cover data will be queried for the following categories to identify forested land cover: Deciduous Forest, Evergreen Forest, Mixed Forest, and Woody Wetlands. Constructing transmission lines within forested areas requires clearing of trees and continued maintenance of a permanent ROW, which may cause land cover conversion. Siting over/across forested areas will be avoided and/or minimized to the extent practicable.

Table 1
Summary of Tier IV Siting Criteria³¹

Criterion		Unit	Measure	Source ¹	Application of Siting Criterion
Urban/Developed Areas (Figure 3-4)	Miles	Distance along representative centerline	USGS NAIP Aerial Imagery 2010 and USGS NLCD 2006 ^{5, 6}	The USGS NLCD 2006 land cover data will be queried for the following categories to identify urban/developed areas: Developed, Open Space; Developed, Low Intensity; Developed, Medium Intensity; and Developed, High Intensity. Locating transmission lines within urban/developed areas as defined by the USGS NLCD may result in land use conflicts that are difficult to minimize or mitigate. Preference will be given to Alternative Routes that avoid urban and developed areas. (Considered together with "Planned Development" below.)	
Structures					
K-12 Schools, Colleges and Universities (Figure 3-4)	Number	0 to 100 feet from representative centerline	Clean Line 2013d ⁷		Schools are sensitive land use features. Preference will be given to Alternative Routes that maximize the distance from these schools.
		100 to 250 feet from representative centerline			
		250 to 500 feet from representative centerline			
		500 to 1,000 feet from representative centerline			
Churches (Figure 3-4)	Number	0 to 100 feet from representative centerline	Clean Line 2013d ⁷		Churches (and other known places of religious congregation) are sensitive land use features. Preference will be given to Alternative Routes that maximize the distance from churches and other known places of religious congregation.
		100 to 250 feet from representative centerline			

Table 1
Summary of Tier IV Siting Criteria³¹

Criterion		Unit	Measure	Source ¹	Application of Siting Criterion
Hospitals (Figure 3-4)	Number	250 to 500 feet from representative centerline	500 to 1,000 feet from representative centerline	Clean Line 2013d ⁷	Hospitals are sensitive land use features. Preference will be given to Alternative Routes that maximize the distance from hospitals.
		250 to 500 feet from representative centerline	500 to 1,000 feet from representative centerline		

Table 1
Summary of Tier IV Siting Criteria³¹

Criterion		Unit	Measure	Source ¹	Application of Siting Criterion
Residences	Number	0 to 100 feet from representative centerline	Clean Line 2013b ⁸		Residences are sensitive land use features. Preference will be given to Alternative Routes that maximize the distance from the greatest number of residences.
		100 to 250 feet from representative centerline			
		250 to 500 feet from representative centerline			
		500 to 1,000 feet from representative centerline			
Agricultural, Commercial, and Industrial Structures	Number	0 to 100 feet from representative centerline	Clean Line 2013b ⁸		The National Electrical Safety Code specifies minimum clearance distances between the conductors and structures. Alternative Routes that cross structures typically require removal or relocation of those structures, increasing ROW acquisition and Project construction costs without corresponding or offsetting benefits. Preference will be given to Alternative Routes that would avoid these structures to the extent practicable.
		100 to 250 feet from representative centerline			
		250 to 500 feet from representative centerline			
		500 to 1,000 feet from representative centerline			

Table 1
Summary of Tier IV Siting Criteria³¹

Criterion		Unit	Measure	Source ¹	Application of Siting Criterion
Government Jurisdictions⁹					
Cities and Towns (Figures 3-1, 3-2, 3-3, 3-4, 3-5, 3-6, and 3-7)	Miles	Distance along representative centerline	ESRI 2010	Locating transmission lines in areas of existing development within a city or town often results in land use conflicts that are difficult to minimize or mitigate. Preference will be given to Alternative Routes that avoid and/or minimize crossings within city or town limits, especially highly populated areas. (Considered together with “Planned Development” below.)	
National Forests (U.S. Forest Service [USFS]) ^{10(a)} (Figures 3-1 and 3-2)	Miles	Distance along representative centerline within the administrative boundary and USFS-owned lands. If within USFS-owned lands, intersections will be quantified by Management Area	USFS 2003, 2009a, 2010	National Forests typically have high resource, recreation, and/or conservation values to be enjoyed by the greater public. In addition, National Forests typically consist of distinct management areas, within which siting of a transmission line may not be considered compatible with the prescribed use of the management area (e.g., Wilderness Areas and Research Natural Areas.) Siting over/across National Forests will be avoided and/or minimized to the extent practicable.	
National Wildlife Refuges (NWRs) (U.S. Fish and Wildlife Service [USFWS]) ^{10(a)} (Figures 3-1 and 3-2)	Miles	Distance along representative centerline	USFWS 2012c	NWRs are established to conserve, manage, and, where appropriate, restore, fish, wildlife, and plant resources and their habitat. Siting over/across NWRs will be avoided and/or minimized to the extent practicable.	
National Parks (National Park Service [NPS]) ^{10(a)} (Figures 3-1 and 3-2)	Miles	Distance along representative centerline	ESRI 2010	National Park lands typically contain important recreational, natural, and/or cultural or historic resources. In addition, National Parks often have high utilization rates by the public for diverse public purposes (e.g., outdoor recreation, community and cultural events). Preference will be given to Alternative Routes that avoid and/or minimize crossing National Parks to the extent practicable.	

Table 1
Summary of Tier IV Siting Criteria³¹

Criterion		Unit	Measure	Source ¹	Application of Siting Criterion
U.S. Army Corps of Engineers (USACE) Lands ^{10(a)} (Figures 3-1 and 3-2)		Miles	Distance along representative centerline	USACE Little Rock District and USACE Tulsa District n.d.	USACE-owned lands include certain water supply reservoirs, hydroelectric facilities, flood control structures, and lands near navigable waterways. USACE-owned lands often include natural and manmade sensitive and/or important resources (e.g., recreational uses, wildlife habitat, flood control and other civil infrastructure). Preference will be given to Alternative Routes that minimize crossing and/or impacts to USACE-owned lands to the extent practicable.
U.S. Department of Defense (DOD) Lands ^{10(a)} (Figures 3-1 and 3-2)		Miles	Distance along representative centerline	ESRI 2010	DOD lands represent specific resources utilized by our nation's military. Siting over/across or near DOD lands often triggers irreconcilable land use conflicts. DOD lands are also typically subject to access restrictions that would affect Project construction, operation, and maintenance. Siting over/near DOD lands will be avoided to the extent practicable.

Table 1
Summary of Tier IV Siting Criteria³¹

Criterion		Unit	Measure	Source ¹	Application of Siting Criterion
State Parks ^{10(b,c,d)} (Oklahoma Tourism and Recreation Department, Arkansas Department of Parks and Tourism, and Tennessee Department of Environment and Conservation (TDEC), Division of Parks and Conservation, State Parks) (Figures 3-1 and 3-2)	Miles	Oklahoma State Parks, distance along representative centerline	ESRI 2010; U.S. Department of Energy (DOE) Scoping Comments 2013; Arkansas State Highway and Transportation Department 2006; TDEC 2011		Lands owned by state governments for conservation and/or recreation, such as State Parks, contain important and/or sensitive natural and recreational resources. In addition, many of these areas have high utilization rates by the public for diverse purposes (e.g., outdoor recreation, community and cultural events). Siting over/across State Parks land will be avoided and/or minimized to the extent practicable.
		Arkansas State Parks, distance along representative centerline			
State-Owned Wildlife Management Areas (WMAs) ^{10(b,c,d)} (owned by Oklahoma Department of Wildlife	Miles	Oklahoma state-owned WMAs, distance along representative centerline	ODWC 2012b; AGFC 2005; TWRA 2007		State agencies own and manage WMAs to preserve and/or protect fish and wildlife resources. All or portions of state-owned WMAs may be managed or designated for public hunting areas, fishing, game management areas, migratory bird refuges, recreational uses, wildlife habitat, and/or waterfowl refuges. Siting over/across state-owned WMAs will be avoided and/or minimized to the extent practicable.
		Arkansas state-owned WMAs, distance along representative centerline			

Table 1
Summary of Tier IV Siting Criteria³¹

Criterion	Unit	Measure	Source ¹	Application of Siting Criterion
Conservation [ODWC], Arkansas Game and Fish and Fish Commission [AGFC], and Tennessee Wildlife Resources Agency [TWRA]) (Figures 3-1 and 3-2)		Tennessee state-owned WMAs, distance along representative centerline		
Arkansas WMAs (leased by AGFC) ^{10(b)} (Figures 3-1 and 3-2)	Miles	Distance along representative centerline	AGFC 2013	Lands leased by Arkansas include WMAs leased by AGFC for hunting or outdoor recreational purposes. Siting over/across these AGFC-leased WMAs will be minimized to the extent practicable.
Oklahoma School Lands (The Commissioners of the Land Office [CLO]) ^{10(c)} (Figures 3-1 and 3-2)	Miles	Distance along representative centerline	Clean Line 2013h	The CLO, also known as the School Land Trust, is an Oklahoma state agency created by the Oklahoma Constitution. The CLO oversees the sale, rental, disposal, and management of school lands and other public lands, as well as funds and proceeds derived thereof. Use of these lands for energy infrastructure is not prohibited by the CLO rules and regulations and could provide additional income for Oklahoma schools. Oklahoma School Lands will not be identified as an opportunity or sensitivity in the Alternative Route development process.

Table 1
Summary of Tier IV Siting Criteria³¹

Criterion	Unit	Measure	Source ¹	Application of Siting Criterion
Arkansas Natural Areas (Arkansas Natural Heritage Commission [ANHC]) ^{10(b), 12} (Figures 3-1 and 3-2)	Miles	Distance along representative centerline	ANHC n.d.(b)	The ANHC holds fee title or conservation easements on lands in Arkansas referred to as Natural Areas. Natural Areas contain naturally significant and sensitive areas that are often unique examples of natural communities within the state. Natural Areas are subject to restrictions on development, including utility use/crossing. Siting over/across Natural Areas will be avoided and/or minimized to the extent practicable.
Tennessee Natural Areas ^{10(d)} (TDEC, Division of Natural Areas, Natural Areas Program) (Figures 3-1 and 3-2)	Miles	Distance along representative centerline	TDEC 2011	Tennessee Natural Areas are components of the Tennessee Outdoor Recreation Area System (TORAS) that include lands that exhibit significant natural, historical, cultural, or recreational resources. Siting over/across Tennessee Natural Areas will be avoided and/or minimized to the extent practicable.
County, City, and Town owned Lands that are managed for conservation or recreation (Figures 3-1 and 3-2)	Miles	Distance along representative centerline	ESRI 2010; DOE 2013; Oklahoma Tourism and Recreation Department 2013 ¹¹	Lands owned by local governments for conservation and/or recreation purposes, such as city and county parks, contain important and/or sensitive natural and/or recreational resources. In addition, many of these areas are utilized by the public for diverse purposes (e.g., outdoor recreation, community and cultural events). Siting over/across local government-owned lands will be avoided and/or minimized to the extent practicable.
Tribal Trust Lands and Allotments ¹³	Miles	Distance along representative centerline	Clean Line 2013; BIA n.d.(a) and n.d.(b)	Tribal Trust lands are held by the federal government for the beneficial interest of Native Americans. These lands may contain religious and/or cultural resources. Siting over/across Tribal Trust lands and allotments will be avoided and/or minimized to the extent practicable.

Table 1
Summary of Tier IV Siting Criteria³¹

Criterion		Unit	Measure	Source ¹	Application of Siting Criterion
Conservation Easements or Areas¹⁴					
Federal Conservation Easements (Figures 3-1 and 3-2)	Miles	Distance along representative centerline	USDA Natural Resources Conservation Service (NRCS) n.d.; The Conservation Registry 2012		Conservation easements are in place to protect, enhance and restore ecosystem resources, wildlife, and habitat. Preference will be given to Alternative Routes that avoid and/or minimize crossing lands known to be subject to federal conservation easements to the extent practicable.
State Conservation Easements ¹⁵ (Figures 3-1 and 3-2)	Miles	Distance along representative centerline	ODWC n.d.; ANHC n.d.(e)		Conservation easements are in place to protect, enhance, and restore ecosystem resources, wildlife, and habitat. Preference will be given to Alternative Routes that avoid and/or minimize crossing lands known to be subject to state conservation easements to the extent practicable.
The Nature Conservancy (TNC) Conservation Easements	Miles	Distance along representative centerline	TNC Oklahoma 2008		TNC Conservation Easements represent areas of high conservation value and often include ecosystem resources, wildlife, and habitat. Preference will be given to Alternative Routes that avoid and/or minimize crossing lands known to be subject to TNC Conservation Easements to the extent practicable.
Soil, Geologic, or Topographic Resources					
Prime Farmland	Miles	Distance along representative centerline	USDA NRCS (Soil Survey Geographic [SSURGO] database) 2012		Prime farmlands are federally or state-designated soil types that have the best combination of physical and chemical characteristics for producing crops. Preference will be given to Alternative Routes that minimize crossing prime farmlands to the extent practicable.
Farmlands of Statewide Importance	Miles	Distance along representative centerline	USDA NRCS (SSURGO database) 2012		Farmlands of Statewide Importance are identified by the NRCS as the most suitable land for producing food, feed, fiber, forage, and oilseed crops within a state. Preference will be given to Alternative Routes that minimize the crossing of Farmlands of Statewide Importance to the extent practicable.

Table 1
Summary of Tier IV Siting Criteria³¹

Criterion		Unit	Measure	Source ¹	Application of Siting Criterion
Slopes Greater than 20%	Miles	Distance along representative centerline	USGS 2009	Areas with steep slopes have a higher risk of erosion. Potential mass movement can cause instability affecting structure locations, can pose construction constraints, and can increase maintenance hazards. Preference will be given to Alternative Routes that avoid and/or minimize crossing slopes greater than 20% to the extent practicable.	
Karst Areas (Figure 3-5)	Miles	Distance along representative centerline	USGS 2005 ¹⁶ ; USFWS n.d.	Karst geology may include areas of subsurface hazards, surface subsidence, and sinkhole development, which impact the engineering integrity of structures. Additionally, subsurface caverns/caves provide potential wildlife habitat, particularly for bat species. Preference will be given to Alternative Routes that avoid and/or minimize crossing karst areas to the extent practicable.	
Airport / Airfields					
Military Airports, Federal Aviation Administration (FAA)-Registered Public Airports, and FAA-Registered Private Airports (will be reported separately for Military, Public, and Private) (Figures 3-1, 3-2, and 3-3)	Miles	Within FAA-restricted airspace	FAA 2010: Bureau of Transportation Statistics Public Use Airports 2008	Vertical obstructions, such as transmission structures, in proximity to military airports or airfields may intrude on regulated or commonly used airplane flight/glide paths. Preference will be given to Alternative Routes that minimize interference with FAA-restricted airspace, and known flight paths and glide slopes to the extent practicable.	
	Number	Within 1 mile of the representative centerline			

Table 1
Summary of Tier IV Siting Criteria³¹

Criterion		Unit	Measure	Source ¹	Application of Siting Criterion
Other Private Airstrips and Helipads (Figures 3-1, 3-2, and 3-3)	Number	Within 1 mile of the representative centerline		Clean Line 2013e ¹⁷	Vertical obstructions, such as transmission structures, in proximity to private airstrips and helipads may intrude on commonly used aircraft flight/glide paths. Preference will be given to Alternative Routes that minimize interference with flight paths and glide slopes associated with known private airstrips or helipads to the extent practicable.
Biological Resources					
USFWS-Designated Critical Habitat (Figures 3-1, 3-2, and 3-5)	Miles	Distance along representative centerline		USFWS 2012a	Critical habitat has been designated by the USFWS to help support endangered or threatened species. Preference will be given to Alternative Routes that avoid and/or minimize crossings of USFWS-designated critical habitat for federally threatened or endangered species to the extent practicable.
Native Prairies (Figure 3-5)	Miles	Distance along representative centerline		TNC 2011	Native prairies are ecosystems that provide habitat for plants and wildlife. Siting transmission lines within native prairies may contribute to habitat fragmentation. Siting over/across remaining native prairies will be avoided and/or minimized to the extent practicable.
State Natural Heritage Program Species Location Data-Occurrence Records	Number of Occurrence Records	Within 1 mile of the representative centerline		ANHC n.d.(a); Oklahoma Natural Heritage Inventory n.d.; Tennessee Natural Heritage Program n.d. ¹⁸	The Natural Heritage occurrence data identify the location of known occurrences of sensitive species. Preference will be given to Alternative Routes that include fewer occurrences of species sensitive to electric transmission infrastructure to the extent practicable.
Arkansas Natural Heritage Program Species Location Data-Focal Areas	Miles	Distance along representative centerline		TNC n.d.	The ANHC designates focal areas of conservation interest as a planning tool. Preference will be given to Alternative Routes that avoid and/or minimize crossing such focal areas to the extent practicable.

Table 1
Summary of Tier IV Siting Criteria³¹

Criterion		Unit	Measure	Source ¹	Application of Siting Criterion
Arkansas Natural Heritage Program Species Location Data-Sensitive Streams	Number	Intersected by the representative centerline	ANHC n.d.(c)	ANHC-designated Sensitive Streams include those streams in the state that are known to support globally rare species (i.e., those species with an Arkansas Natural Heritage Program Rank of GI-G3 ¹⁹). Preference will be given to Alternative Routes that avoid and/or minimize crossing Sensitive Streams to the extent practicable.	
Arkansas Natural Heritage Program Species Location Data-Designated Streams	Number	Intersected by the representative centerline	ANHC n.d.(d)	ANHC-Designated Streams include those listed on the Arkansas registry or system of natural and scenic rivers or included in the Arkansas Department of Environmental Quality's (ADEQ's) Regulation No. 2 that establishes water quality standards for the state. Preference will be given to Alternative Routes that avoid and/or minimize crossing Designated Streams to the extent practicable.	
Lesser Prairie-Chicken (LEPC) Potential Habitat: ODWC Oklahoma Lesser Prairie-Chicken Spatial Planning Tool (OLEPCSPT) ²⁰ (Figure 3-6)	Miles	Distance along representative centerline	ODWC 2010b	The ODWC developed the OLEPCSPT 2010 Model as a tool for planning site development with consideration to LEPC conservation. The Routing Team will use the inventory of ranked areas within each corridor to assess the relative value of LEPC habitat. Preference will be given to Alternative Routes that minimize crossing high-value habitat areas (Ranks 4 to 8) to the extent practicable. (Considered together with "Existing Infrastructure Paralleled in LEPC Habitat" below.)	
LEPC Potential Habitat – Western Governors Association (WGA) Southern Great Plains (SGP) Crucial Habitat Assessment Tool (CHAT) ²¹ (Figure 3-5)	Miles	Distance along representative centerline within Rank 1 (Focal Areas)	University of Kansas 2013	WGA SGP CHAT is a tool to identify the relative value of LEPC habitat and to support the Rangewide Conservation Plan for the LEPC (Interstate Working Group 2013). The Routing Team will use the inventory of ranked areas within each corridor to assess the relative value of LEPC habitat. Preference will be given to 1) Alternative Routes that avoid Rank 1 (also known as Focal Areas) to the extent practicable and, 2) Alternative Routes that minimize crossing high-value habitat areas (Ranks 2 and 3) to the extent practicable. (Considered together with "Existing Infrastructure Paralleled in LEPC Habitat" below.)	
		Distance along representative centerline within Ranks 2 and 3			

Table 1
Summary of Tier IV Siting Criteria³¹

Criterion		Unit	Measure	Source ¹	Application of Siting Criterion
Existing Impacted Areas within LEPC Habitat	Miles	Distance along representative centerline ²²	Clean Line 2013f; ESRI 2012; University of Kansas 2013; ODWC OLEPCST 2010	Where high-value LEPC habitat areas are unavoidable, following existing electrical transmission lines and primary roadways may provide an opportunity to minimize impacts. Preference will be given to Alternative Routes that follow existing linear infrastructure when located in high-value habitat areas as identified by OLEPCST and CHAT. (Considered together with "the ODWC OLEPCST" and the "WGA SGP CHAT" criteria above).	
Greater Prairie Chicken (GRPC) Potential Habitat: ODWC Oklahoma Greater Prairie-Chicken Spatial Planning Tool (OGRPCST) ²³ (Figure 3-6)	Miles	Distance along representative centerline	ODWC 2010a	The ODWC developed the OGRPCST 2010 Model as a tool for planning site development with consideration for GRPC conservation. The Routing Team will use the inventory of ranked areas within each corridor to assess the relative value of GRPC habitat. Preference will be given to Alternative Routes that minimize crossing high value habitat areas (Ranks 4 to 8) to the extent practicable.	
Whooping Crane Migratory Stopover Locations	Miles	Distance within a buffer of 1 mile of known stopover locations	USFWS Nebraska Field Office 2010 ²⁴	The whooping crane is a federally endangered species that migrates through Oklahoma. During migration, whooping cranes stop over in palustrine wetlands to rest and forage. Preference will be given to Alternative Routes that avoid and/or minimize impacts to documented stopover habitat.	
Potential Occurrence Areas for Federally Threatened and/or Endangered Bats (Figure 3-5)	Miles	Distance along representative centerline (Ozark big-eared bat potential occurrence areas)	USFWS 2007 ²⁵ ; USFWS 2008b ²⁵ ; USFWS 2009 ²⁵	The Ozark big-eared bat, gray bat, and Indiana bat are federally endangered bat species. Preference will be given to Alternative Routes that avoid and/or minimize potential occurrence areas to the extent practicable (Considered together with "Forested Area" above).	
	Miles	Distance along representative centerline (Indiana bat potential occurrence areas)			

Table 1
Summary of Tier IV Siting Criteria³¹

Criterion		Unit	Measure	Source ¹	Application of Siting Criterion
Known Bat Caves	Miles	Distance along representative centerline (Gray bat potential occurrence areas)	TNC Oklahoma 2002 ²⁶ ; USFWS 2013a ¹⁴	Known bat caves or hibernacula may represent bat habitat for sensitive or protected bat species. Siting within 500 feet of documented locations will be minimized to the extent practicable.	
	Number	Intersections of 500-foot buffers around known bat caves ¹⁴			
	Miles	Distance along representative centerline			
American Burying Beetle Potential Occurrence Areas (Figure 3-6)	Miles	Distance along representative centerline	USFWS 2008; USGS NLCD 2006 ^{5, 6, 27}	The American burying beetle is a federally listed endangered species. While the Project cannot avoid the species' range, preference will be given to Alternative Routes that avoid and/or minimize potential occurrence areas to the extent practicable.	
Water Resources					
Wetlands (Figure 3-7)	Miles	Distance along representative centerline (non-forested wetlands)	USFWS 2012b ²⁸ ; USGS NLCD 2006 ^{5, 6}	The Clean Water Act and other federal laws and programs promote wetland protection. Wetlands often serve important ecosystem functions, including as habitat for plants and wildlife, and filtering systems within watersheds. Preference will be given to Alternative Routes that avoid and/or minimize the number and length of crossings of wetlands systems, particularly forested wetlands.	
	Miles	Distance along representative centerline (forested wetlands)			
	Number	Non-forested wetland crossings greater than 1,000 feet			
	Number	Forested wetland crossings greater than 1,000 feet			

Table 1
Summary of Tier IV Siting Criteria³¹

Criterion		Unit	Measure	Source ¹	Application of Siting Criterion
Floodplains	Miles	Distance along representative centerline (100-year floodplain)	Federal Emergency Management Agency 2013		Construction within a floodplain may impair the ability of land to store and dissipate floodwaters and may require special engineering or construction methods. While the Project cannot entirely avoid floodplains, preference will be given to Alternative Routes that minimize the length of crossings of mapped floodplains to the extent practicable.
	Number	Floodplain crossings greater than 1,000 feet			
Major Waterbodies and Reservoirs (Figures 3-1, 3-2, 3-3, 3-4, 3-5, 3-6, and 3-7)	Number	Intersected by the representative centerline	ESRI 2012; USGS 2010; Clean Line 2013g		Crossing a major waterbody (generally defined as greater than 100 feet wide) may result in additional environmental impacts when compared to smaller waterbodies or upland areas, and/or may require special engineering or construction methods. While the Project cannot entirely avoid these waterbodies, preference will be given to Alternative Routes that minimize the number and lengths of crossings of major waterbodies and reservoirs.
	Miles	Distance along representative centerline			
State-Designated Waterbodies with Special Significance (Figure 3-7)	Number	Intersected by the representative centerline	OWRB 2012; OWRB 2011; TDEC, Outstanding National Resource Waters and Exceptional Tennessee Waters n.d.; ADEQ 2012 ²⁹		Crossing a state-designated waterbody with special significance may result in additional environmental impacts or require special engineering or construction methods. While the Project cannot entirely avoid these waterbodies, preference will be given to Alternative Routes that minimize the number of crossings of state-designated waterbodies.
Other Waterbodies (Figure 3-7)	Number	Intersected by the representative centerline	USGS 2012		Other Waterbodies are defined as all hydrographic categories in the StreamRiver feature of the NHD. Crossing a waterbody may result in additional environmental impacts and/or may require special engineering or construction methods. Preference will be given to Alternative Routes that minimize the number of crossings of Other Waterbodies.

Table 1
Summary of Tier IV Siting Criteria³¹

Criterion		Unit	Measure	Source ¹	Application of Siting Criterion
Springs (Figure 3-7)	Number	Within 250 feet of the representative centerline	Within 500 feet of the representative centerline	USGS 2012; DOE 2013	Natural springs are environmentally sensitive areas and often provide headwaters of streams or contribute to stream flow. Preference will be given to Alternative Routes that avoid and/or minimize crossing natural springs to the extent practicable.
		Intersected by the representative centerline			
Wild and Scenic Rivers (Figure 3-7)	Number	Intersected by the representative centerline		USFS 2009b	The Wild and Scenic Rivers System was created to preserve certain rivers with outstanding natural, cultural, and recreational values. Preference will be given to Alternative Routes that avoid and/or minimize crossings of river segments designated as Wild and Scenic Rivers to the extent practicable.
Visual / Cultural Resources					
Federally and State-Designated Scenic Routes, Trails, and Byways ¹⁰ (Figure 3-7)	Number	Intersected by the representative centerline		ESRI 2010; AHTD n.d.; NPS 2013	Federally and state-designated scenic routes, trails, and byways have been designated because of exceptional cultural, historical, visual, and/or aesthetic resources. Preference will be given to Alternative Routes that avoid scenic routes, trails, and byways to the extent practicable.
Sites on the National Register of Historic Places (NRHP) (Figure 3-1, 3-2, and 3-7)	Number	Within 0.25 mile of the representative centerline		NPS 2010	Sites are listed on the NRHP because of their cultural and historical value. Preference will be given to Alternative Routes that avoid and/or minimize impacts to registered NRHP sites.
Recorded Cultural or Historical Sites	Number	Within 0.25 mile of the representative centerline		SWCA Environmental Constraints n.d.	Recorded Cultural and Historical Sites represent cultural and historical resources. Preference will be given to Alternative Routes that avoid and/or minimize impacts to these cultural and historical sites.

Table 1
Summary of Tier IV Siting Criteria³¹

Criterion		Unit	Measure	Source ¹	Application of Siting Criterion
Cemeteries (Figure 3-7)	Number	Within 500 feet of the representative centerline		Clean Line 2013c ⁷ , ESRI 2010	Cemeteries have cultural, historical, and social value. Preference will be given to Alternative Routes that avoid known cemeteries to the extent practicable.
Environmentally Regulated Sites					
Known Contaminated Sites (Figure 3-5)	Number	Within 0.25 mile of the representative centerline		U.S. Environmental Protection Agency 2013	Ground disturbance during construction, maintenance and/or decommissioning in or near known contaminated sites, waste cleanup areas, and sites in need of remediation may expose the environment, construction workers, and/or the general population to contaminants. Also, these sites may require temporary or permanent removal/relocation of transmission lines during future site remediation. Preference will be given to Alternative Routes that avoid known contaminated sites to the extent practicable.
Engineering Considerations					
Total Length of the Transmission Line	Miles	Distance along representative centerline		Calculated by ESRI ArcMap	Total length of the transmission line will be used as a criterion to correlate to land requirements and construction impacts. Preference will be given to Alternative Routes of shorter overall length.
Electrical Transmission Line Crossings	Number	69kV - 345kV intersected by the representative centerline		Clean Line 2013f ²	Crossing over other high-voltage transmission lines can result in greater ROW requirements, the need for specialty structures, and increased maintenance hazards for both lines. Preference will be given to Alternative Routes with fewer crossings of other transmission lines greater than 69 kV, and especially lines greater than 345 kV.
		Greater than 345kV intersected by the representative centerline			

Table 1
Summary of Tier IV Siting Criteria³¹

Criterion		Unit	Measure	Source ¹	Application of Siting Criterion
Transmission Pipeline Crossings ³	Number	Intersected by the representative centerline	Intersected by the representative centerline	Ventyx 2013 ³	Crossing transmission pipelines with an electrical transmission line can result in greater ROW requirements, the need for specialty structures, special construction methods, and increased maintenance hazards for both facilities. Preference will be given to Alternative Routes with fewer pipeline crossings to the extent practicable.
Major Road Crossings	Number	Intersected by the representative centerline	Intersected by the representative centerline	ESRI 2010	Crossing major roads (defined as interstates; freeways; U.S. and state highways; major streets and roads; primary, secondary, and local roads; access ramps; ferry crossings; and other major thoroughfares within the United States) with an electrical transmission line can result in greater ROW requirements, the need for specialty structures, special construction methods, and increased maintenance hazards for both facilities. Preference will be given to Alternative Routes with fewer major road crossings to the extent practicable.
Railroad ROW Crossings	Number	Intersected by the representative centerline	Intersected by the representative centerline	ESRI 2010	Crossing railroad ROWs with an electrical transmission line can result in greater ROW requirements, the need for specialty structures, special construction methods, and increased maintenance hazards for both facilities. Preference will be given to Alternative Routes with fewer railroad crossings to the extent practicable.
Criteria Without Standardized Geographic Information System (GIS) Datasets or Requiring Combined Use of a GIS Dataset and Other Non-GIS Sources³⁰					
Topography/Digital Elevation Data	N/A	N/A	N/A	National Geographic Society 2013	Topographic features (e.g. hills, valleys, ravines, plains) can affect constructability and engineering design; the effect these features have on routing is site-dependent and context-sensitive. The Routing Team will use professional judgment while reviewing topographic maps to evaluate the alignment of each Alternative Route in relation to topography.

Table 1
Summary of Tier IV Siting Criteria³¹

Criterion	Unit	Measure	Source ¹	Application of Siting Criterion
Center Pivot Agricultural Fields	N/A	N/A	USGS 2010; DOE 2013	Obstructing the movement of a center pivot irrigation system can interfere with the efficacy and operation of these systems. Preference will be given to Alternative Routes that avoid and/or minimize interference with center pivot irrigation systems. (Considered together with "Agriculture and Open Lands" above.)
Planned Development	N/A	N/A	DOE 2013	Locating transmission lines within areas planned for commercial and/or residential development (e.g., office parks or residential subdivisions) often results in land use conflicts that are difficult to minimize or mitigate. Planned development will be identified by review of information provided by stakeholders and review of scoping comments. Preference will be given to Alternative Routes that avoid and/or minimize crossings of known planned development to the extent practicable. (Considered together with "Cities and Towns and Urban/Developed Areas" above.)
Proximity to Existing Access Roads	N/A	N/A	USGS 2010; National Geographic Society 2013; ESRI 2010	Siting an electric transmission line ROW in proximity to existing roads that could be used during construction and operation would require fewer new access roads, likely resulting in fewer environmental and land use impacts. Preference will be given to Alternative Routes with greater access or proximity to existing roads. (Considered together with "Publicly Maintained Federal, State, and County Roads" above.)
Aerial Imagery	N/A	N/A	USGS 2010	The Routing Team will review aerial imagery to evaluate and verify siting criteria as appropriate.

Notes:

1. The source information reflects data available to Clean Line as of the date of this publication. If newer data are made available, Clean Line may rely upon those data instead, subject to providing DOE with notice of that change prior to implementation.
2. Clean Line created this dataset based on aerial photo interpretation of existing transmission lines and transmission lines under construction in 2013.
3. The Ventyx dataset (2013) includes both intrastate and interstate pipelines. Each pipeline has been assigned pipeline operator and diameter attributes. This dataset also includes information about proposed pipeline projects.
4. Digital parcel data for Oklahoma and Arkansas were obtained by a subcontracted service in 2012 and provided to Clean Line. Digital data gaps were filled manually through available county tax roll data. Parcel data for Tipton and Shelby Counties, Tennessee, were obtained directly from the individual county property appraiser's offices in 2012.
5. The Routing Team will compare the USGS NLCD data against aerial imagery. The USGS NLCD 2006 land cover data will be queried for the following categories to identify

- forested wetlands: 90-Woody Wetlands. The USGS NLCD 2006 land cover data will be queried for the following categories to identify forested wetlands: 90-Woody Wetlands. The USGS NLCD 2006 land cover data will be queried for the following categories to identify non-forested wetlands: 95- Emergent Herbaceous Wetlands. According to the USGS Fact Sheet (<http://pubs.usgs.gov/fs/2012/3020/fs2012-3020.pdf> accessed on May 21, 2013) posted on February 23, 2012, the NLCD 2006 Land Use Land Cover (LULC) data are the most recent data available: "The next version of NLCD, entitled NLCD 2011, is currently (2012) in production. NLCD 2011 will update NLCD products to a nominal year of 2011 in all 50 States and Puerto Rico, and will continue to provide a national assessment of land cover change back to either 2001 or 2002." NLCD 2011 will update NLCD products to a nominal year of 2011 in all 50 States and Puerto Rico, and will continue to provide a national assessment of land cover change back to either 2001 or 2002.
6. Clean Line created a data layer based on ESRI 2010 data supplemented with aerial photointerpretation and field verification surveys conducted in 2012 and 2013.
 7. Structure data were compiled through a review of stakeholder comments obtained by Clean Line (2010-2012) and scoping comments received by DOE during the scoping period, digitization of structure rooftops based on aerial photointerpretation, and subsequent field verification surveys conducted from public roads in 2012 and 2013.
 8. Clean Line considered crossings of and proximity to lands owned or managed by federal, state, and/or local governments amongst its siting criteria in recognition of the fact that such properties contain natural and manmade resources (such as sensitive animal habitat, cultural/historical resource sites, heavily used recreational areas, and civil infrastructure). Clean Line considered these resources as just one criterion out of many in its route development process; no higher or lower priority is assigned to these resources compared to any of the other siting criteria.
 9. (a) Federal Lands included: National Forests, National Wildlife Refuges, National Parks, USACE owned lands, Non-USACE Department of Defense owned lands, Bureau of Reclamation owned lands. National Forests included: Ozark and Ouachita National Forests and East Fork Wilderness. National Wildlife Refuges included: Cache River NWR, Bald Knob NWR, Big Lake NWR, Deep Fork NWR, Holla Bend NWR, Little River NWR, Lower Hatchie NWR, Optima NWR, Sequoyah NWR, and Wapanocca NWR). National Parks included: Buffalo National River, Buffalo National River (Lower Buffalo Unit) Wilderness, Buffalo National River (Ponca Unit) Wilderness, Hot Springs National Park, and Pea Ridge National Military Park. US Army Corps of Engineers Lands included: Arcadia Lake, Beaver Lake, Blue Mountain Lake, Broken Bow Lake, Bull Shoals Lake, Cache River Mitigation Project, Canton Lake, Dardanelle Lake, DeGray Lake, DeQueen Reservoir, Dierks Reservoir, Eufaula Lake, Fort Gibson Lake, Fort Supply Lake, Gilham Lake, Greers Ferry Lake, Heyburn Lake, Hugo Lake, Lake Greeson, Nimrod Lake, Norfork Lake, Optima Lake, Ozark Lake, Pat Mayse Lake, Pine Creek Lake, Robert S. Kerr Lake, Tenkiller Ferry Lake, and Webbers Falls Reservoir. Non-USACE Department of Defense owned lands included: Fort Chaffee (U.S. Army), Naval Support Activity Mid-South (U.S. Navy), Pine Bluff Arsenal (U.S. Army), and Vance Air Force Base (U.S. Air Force). Bureau of Reclamation owned land included McGee Creek Reservoir.
 10. (b) Arkansas State Lands included: Arkansas State Parks, Arkansas Wildlife Management Areas, and Arkansas Natural Areas. Arkansas State Parks included: Bull Shoals White River State Park, Crater of Diamonds State Park, Daisy State Park, De Gray State Park, Lake Catherine State Park, Lake Dardanelle State Park, Lake Fort Smith State Park, Lake Poinsett State Park/Conservation Management Area, Jacksonport State Park, Lake Catherine State Park, Lake Dardanelle State Park, Lake Fort Smith State Park, Lake Poinsett State Park, Mount Magazine State Park, Mount Nebo State Park, Petit Jean State Park, Pinnacle Mountain State Park, Prairie Grove Battlefield State Park, Toltec Mounds Archeological State Park, Village Creek State Park, Withrow Springs State Park, and Woolly Hollow State Park. Arkansas Wildlife Management Areas included: AGFC – Forrest L. Wood/Crowley's Ridge Nature Center, Beaver Lake WMA, Big Lake WMA, Big Creek WMA, Big Timber WMA, Blue Mountain WMA, Brewer Lake/Cypress Creek WMA, Brushy Creek WMA, Buffalo National River WMA, Camp Robinson WMA, Cherokee Prairie Natural Area WMA, Cherokee WMA, Cove Creek Natural Area WMA, Cypress Bayou WMA, Dardanelle WMA, Dagmar WMA, DeGray Lake WMA, Departee Creek WMA, Departee Creek WMA - Estep Unit, Devil's Knob Natural Area WMA, Earl Buss Bayou DeView WMA, Ed Gordon/Point Remove WMA, Electric Island WMA, Fort Chaffee WMA, Frog Bayou WMA, Galla Creek WMA, Gene Rush/Bufalo River WMA, Greers Ferry Lake WMA, Gulf Mountain WMA, Harris Brake WMA, Henry Gray/Hurricane Lake WMA, Hobbs State Park Conservation Area WMA, Howard County WMA, J. Perry Mikles Blue Mountain SUA, Jamestown WMA, Jim Kress WMA, John Tully WMA, Jones Point WMA, Kelly's Slab WMA, Lake Greeson WMA, Lee County WMA, Loافر's Glory WMA, Madison County WMA, Maumelle River WMA, Maumelle River WMA, McIlroy Madison County WMA, Mt. Magazine WMA, Nimrod/Lloyd Millwood WMA, Norfork Lake WMA, Ouachita Wildlife Management Area - McCurtain Unit, Ozark Lake WMA, Ozark National Forest WMA, Petit Jean River WMA, Pine Tree Wildlife Demonstration Area, Piney Creek WMA, Prairie Bayou WMA, Provo WMA, Railroad Prairie Natural Area WMA, Rainey WMA, Rex Hancock/Black Swamp WMA, Ring Slough WMA, River Bend WMA, Scott Henderson Gulf Mountain WMA, Slippery Hollow Natural Area WMA, Shirley Bay-Rainey Brake WMA, St. Francis Sunken Lands WMA, Sweden Creek Natural Area WMA, Sylamore WMA, Wattensaw WMA, Wedington WMA, White Hall WMA, and Winona WMA. Arkansas Natural Areas included: Baker Prairie Natural Area, Bear Hollow Natural Area, Benson Creek Natural Area, Big Creek Natural Area, Cave Springs Cave Natural Area, Cheney Prairie Natural Area, Cherokee Prairie Natural Area, Cove Creek Natural Area, Cow Shoals Riverfront Forest Natural Area, Dardanelle Rock Natural Area, Devil's Knob – Devil's Backbone Natural Area, Downs Prairie Natural Area, Goose Pond Natural Area, H.E. Flanagan Prairie Natural Area, Konecny Prairie Natural Area, Lorance Creek Natural Area, Mills Park Natural Area (easement), Railroad Prairie Natural Area, Searles Prairie Natural Area, Singer Forest Natural Area (easement), Slippery Hollow Natural Area, Smoke Hole Natural Area, Stone Road Glade

- Natural Area, and Sweden Creek Falls Natural Area.
- (c) Oklahoma State Lands included: Oklahoma State Parks and Oklahoma Wildlife Management Areas. Oklahoma State Parks included: Alabaster Caverns State Park, Beaver Dunes State Park, Beavers Bend State Park, Boggy Depot State Park, Brushy Lake State Park, Burnt Cabin Ridge State Park, Cherokee Landing State Park, Greenleaf State Park, Heyburn State Park, Hochatown State Park, Lake Schultz State Park, Little Sahara State Park, Gloss Mountain State Park, Boiling Springs State Park, Lake Eufaula State Park, Raymond Gary State Park, Fountainhead State Park, Fort Cobb State Park, McGee Creek State Park (also associated with Bureau of Reclamation's McGee Creek Reservoir), Okmulgee State Park, Pine Creek Cove State Park, Red Rock Canyon State Park, Roman Nose State Park, Sequoyah State Park, and Hugo Lake State Park. Oklahoma Wildlife Management Areas included: Atoka WMA, Beaver River WMA, Canton WMA, Cherokee-Gruber WMA, Cimarron Bluff WMA, Cimarron Hills WMA, Cookson WMA, Cooper WMA, Deep Fork WMA, Dewey County WMA, Drummond Flats WMA, Ellis County WMA, Eufaula WMA, Fort Gibson WMA, Fort Supply WMA, Grassy Slough WMA, Hugo WMA, Heyburn WMA, Honobia Creek WMA, Hugo WMA, Keystone WMA, Lower Illinois River Public Fishing and Hunting Area, Lunceford Playa, Major County WMA, McClellan-Kerr WMA, McGee Creek WMA, Okmulgee Public Hunting Area, Optima WMA, Ouachita WMA, Ozark Plateau Wildlife Management Area, Pine Creek WMA, Schultz WMA, Sparrowhawk WMA, Stringtown WMA, Tenkiller WMA, and Whitegrass WMA.
- (d) Tennessee State Lands include State Parks, Wildlife Management Areas and a State Natural Area. State Parks include: Fort Pillow State Historic Park and Meeman-Shelby Forest State Park. Wildlife Management Areas include: Eagle Lake Refuge Wildlife Management Area and John Tully Wildlife Management Area. Meeman-Shelby Forest State Natural Area is also included.
- Refers to comments received by the DOE on March 15, 2013, from the Oklahoma Tourism and Recreation Department regarding Oklahoma State Parks and municipal parks located within the state of Oklahoma.
11. The ANHC holds fee title or conservation easements on lands in Arkansas referred to as Natural Areas.
 12. This criterion includes Arkansas Riverbed Authority lands.
 13. The Routing Team chose a conservative 500-foot buffer around Known Bat Caves based on the USFWS's request to establish a natural area of 300 feet or greater around any cave. The 300-foot buffer was requested in a letter dated April 10, 2013, to Melissa Ardis, Project Leader, DOE, Plains & Eastern Clean Line EIS, from Joy E. Nichopoulos, Acting Regional Director, USFWS, Post Office Box 1306, Albuquerque, New Mexico 87103 (USFWS 2013).
 14. No known State of Tennessee conservation easements occur in the Project area; therefore, no data sources for this criterion in this state are listed.
 15. The Routing Team relied upon a national dataset of karst and pseudokarst topography (areas of karst-like terrain produced by processes other than the dissolution of rock) produced by the USGS.
 16. Clean Line created a Private Airstrips and Helipads data layer based on aerial photointerpretation, comments obtained during Clean Line stakeholder outreach (2010-2013), and DOE Scoping Comments (2013).
 17. Each state's Natural Heritage Program provided recorded occurrence locations of species that are considered endangered, threatened, rare, or imperiled, as well as outstanding natural communities, geologic features, and colonial bird nesting sites.
 18. The Arkansas Natural Heritage Program Species Location Data-Sensitive Streams data include streams in the state of Arkansas that are known to support globally rare species (i.e., those species within the Arkansas Natural Heritage Program Rank of G1-G3). Global ranks are conservation ranks used by State Heritage Programs and NatureServe. The rank indicates the relative rarity of an element throughout its range.
 19. The ODWC OLEPCSPT model classifies LEPC habitat value from 1 to 8 with higher numbers indicating higher value habitat. Ranks are determined by comparing the habitat against a set of eight criteria: historical range, current range, leks, habitat suitability, core habitat patch, core buffer habitat, managed/protected land, and avoided structures. Analysis will measure miles along centerline within higher-value habitat (i.e., Ranks 4 to 8).
 20. The WGA SGP CHAT 2013 (also known as Version 2.0) classifies habitat into five categories: 1-Focal Areas, 2-Connectivity Zones, 3-Maxent Model Areas, 4-Within Estimated Occupied Range (EOR) plus 10 miles, and 5-Common. CHAT 3 describes those areas within the EOR that had the highest potential for nesting and brood rearing habitat based on Maxent modeling. CHAT 4 includes the EOR with an additional 10 mile-buffer for potential habitat expansion.
 21. See Attachment A.
 22. These data are only available for Oklahoma. The ODWC OGRPCSPT model classifies GRPC habitat value from 1 to 8. The higher the rank, the more valuable the habitat is to the GRPC. Ranks are determined by comparing the habitat against a set of eight criteria: historical range, current range, habitat suitability, core habitat, core buffer habitat, leks, managed/protected land, and avoidance areas. Analysis characterized miles along centerline within higher-value habitat (i.e., Ranks 4 to 8).
 23. The Cooperative Whooping Crane Tracking Project-GIS will be updated annually following the fall migration and distributed to state cooperators and USFWS Ecological Services Field Offices in the Central Flyway.

25. Ozark big-eared, Indiana, and gray bat sources include the Indiana Bat (*Myotis sodalis*) Draft Recovery Plan: First Revision, USFWS (April 2007), Great Lakes-Big Rivers Region-Region 3, Fort Snelling, Minnesota (USFWS 2007); Ozark Big-Eared Bat (*Corynorhinus townsendii ingens*), 5-Year Review: Summary and Evaluation, prepared by Richard Stark, USFWS, Oklahoma Ecological Services Field Office, Tulsa, Oklahoma (USFWS 2008); and Gray Bat (*Myotis grisescens*) 5-Year Review: Summary and Evaluation, prepared by USFWS Midwest Region, Columbia, Missouri Ecological Services Field Office, Columbia, Missouri (USFWS 2009).
26. Clean Line received a bat cave dataset from the TNC Oklahoma (2008). The ANHC Species Location Data-Species Occurrences and Species Location Data-Focal Areas datasets (ANHC 2011) contain information on bat occurrences and bat caves in Arkansas. Clean Line also received a Species Location Data-Species Occurrences dataset from the Tennessee Natural Heritage Inventory Program that did not identify any bat caves or bat occurrences in the Project area (TDEC 2011).
27. Clean Line created an American Burying Beetle Potential Occurrence Area data layer by selecting certain categories from the NLCD 2006 data within the counties of occurrence based on habitat requirements identified in the American Burying Beetle (*Nicrophorus americanus*) 5-Year Review: Summary and Evaluation, USFWS, New England Field Office, Concord, New Hampshire (USFWS 2008). Areas considered as potential occurrence areas included the following NLCD 2006 categories: Deciduous Forest, Evergreen Forest, Mixed Forest, Barren Land, Shrub/Scrub, Grassland/Herbaceous, Pasture/Hay.
28. The USFWS NWI 2012 data will be queried for the following categories to identify forested wetlands: PF01 through PF07. The USFWS NWI 2012 data will be queried for the following categories to identify nonforested wetlands: PEM1, PEM2, and PEM5, and PSS1 through PSS7.
29. Contaminated, high-quality waters, water protection areas, and sensitive fisheries habitat will be avoided to the extent possible.
30. The Routing Team will use GIS analysis to compare the criteria in the table, except those criteria denoted by "N/A" in the Unit and Measure columns above. GIS data are not available to quantify criteria listed as "N/A" in the Unit and Measure column. For example, center pivots were identified through interpretation of aerial photos and review of stakeholder comments obtained by Clean Line from 2010 through 2012 and scoping comments received by DOE during the scoping period. When evaluating these criteria, the Routing Team will apply the General and Technical Guidelines.
31. This October 2013 version of Table 1 differs slightly from the version included in the June 14, 2013, document. The October 2013 changes were not substantive and included a renumbering of footnotes for chronological presentation, an acronym key, an inclusion of figure numbers for each criterion, a data source revision, and negligible editorial changes to maintain consistency throughout the table.

Key:

ADEQ = Arkansas Department of Environmental Quality	NWR = National Wildlife Refuge
AGFC = Arkansas Game and Fish Commission	ODEQ = Oklahoma Department of Environmental Quality
ANHC = Arkansas Natural Heritage Commission	ODWC = Oklahoma Department of Wildlife Conservation
BPA = Bonneville Power Administration	OGRPCSPT = Oklahoma Greater Prairie-Chicken Spatial Planning Tool
CHAT = Crucial Habitat Assessment Tool	OLEPCSPT = Oklahoma Lesser Prairie-Chicken Spatial Planning Tool
CLO = Commissioners of the Land Office	SGP = Southern Great Plains
DOD = (United States) Department of Defense	SHPO = State Historic Preservation Office
EOR = Estimated Occupied Range	SSURGO = Soil Survey Geographic (database)
FAA = Federal Aviation Administration	TDEC = Tennessee Department of Environment and Conservation
GRPC = greater prairie-chicken	TNC = The Natural Conservancy
LEPC = lesser prairie-chicken	TORAS = Tennessee Outdoor Recreation Area System
NAIP = National Agricultural Imagery Program	TWRA = Tennessee Wildlife Resources Agency
NHD = National Hydrography Dataset	USACE = United States Army Corps of Engineers
NLCD = National Land Cover Database	USFS = United States Forest Service
NPS = National Park Service	USFWS = United States Fish and Wildlife Service
NRHP = National Register of Historic Places	USGS = United States Geological Service
NRCS = Natural Resources Conservation Service	WAPA = Western Area Power Administration
	WGA = Western Governors Association
	WMA = Wildlife Management Area

This page intentionally left blank.

Attachment A

Draft Anthropogenic Impact Types and Buffer Establishment for “Existing Impacted Areas within LEPC Habitat” Criterion

<i>Type of Impact</i>	<i>Buffer ft(m)</i> ¹	<i>Definitions</i> ²
Wind turbines ³	2,165 (667)	For wind turbines greater than 150 feet tall. Utilize the wind turbine location as the basis for the buffer.
Transmission lines >69 kV ⁴	1300 (400)	Use the centerline of the of the right-of-way as the basis for the impact buffer
Secondary roads ⁵	215 (67)	Public roads maintained by counties or municipalities
Primary roads ⁵	1,625 (500)	Public roads maintained by State or Federal entities or privately-maintained public toll roads. Use the center line of the road as the basis for the impact buffer

Notes:

- 1 Source: Haufler, Jonathan B., Grant Beauprez, David Klute, Sean Kyle, Jim Pitman, Doug Schoeling, Bill Van Pelt, and Christian Hagan. April 1, 2013. *Range-wide Conservation Plan for the Lesser Prairie-chicken*. [Online]. Available: http://www.wafwa.org/documents/AprilDraftLEPCPlanSubmittedUSFWS04_02_2013.pdf [04/01/2013].
- 2 Source: Kyle, Sean. Wildlife Diversity Biologist, Texas Parks and Wildlife Department. Personal Communication (email) to Jason Thomas. June 6, 2013.
- 3 Source: US Fish and Wildlife Service (USFWS). March 2013. Operational wind turbines. [Online]. Available: http://www.fws.gov/southwest/es/Energy_Wind_FAA.html [April 1, 2013].
- 4 Source: Clean Line 2013.
- 5 Source: ESRI 2012.

APPENDIX H

CONSTRUCTION EMISSION CALCULATIONS



This page intentionally left blank.

List of Tables

Table 1:	HVDC Line Non-Road Construction Equipment Criteria Pollutant Emissions	1
Table 2:	HVDC Line Non-Road Construction Equipment Greenhouse Gas Pollutant Emissions	2
Table 3:	AC Line Non-Road Construction Equipment Criteria Pollutant Emissions	3
Table 4:	AC Line Non-Road Construction Equipment Greenhouse Gas Pollutant Emissions.....	4
Table 5:	Converter Station Non-Road Construction Equipment Criteria Pollutant Emissions	5
Table 6:	Converter Station Non-Road Construction Equipment Greenhouse Gas Pollutant Emissions.....	6
Table 7:	Portable Concrete Batch Plant Non-Road Construction Equipment Criteria Pollutant Emissions.....	7
Table 8:	Converter Station Non-Road Construction Equipment Greenhouse Gas Pollutant Emissions.....	7
Table 9:	HVDC Line On-Road Construction Equipment/Vehicles Emissions.....	8
Table 10:	AC Line On-Road Construction Equipment/Vehicles Emissions.....	9
Table 11:	Converter Station On-Road Construction Equipment/Vehicles Emissions.....	10
Table 12:	Portable Concrete Batch Plant On-Road Construction Equipment/Vehicles Emissions.....	10
Table 13:	HVDC Line On-Road Commute Vehicle Emissions	11
Table 14:	AC Line On-Road Commute Vehicle Emissions	11
Table 15:	Converter Station On-Road Commute Vehicle Emissions	12
Table 16:	On-Road Vehicle Exhaust Emission Factors.....	12
Table 17:	Fugitive Dust Emissions Roads.....	13
Table 18:	Fugitive Dust General Construction	13

APPENDIX H
CONSTRUCTION EMISSION CALCULATIONS

This page intentionally left blank.

Table 1:
HVDC Line Non-Road Construction Equipment Criteria Pollutant Emissions

Equipment Type	Fuel	Source Category ¹	Engine Rating (hp)	No.	Load Factor ²	Operating Schedule (hours)	Pollutant Emission Factor (g/hp-hour) ³						Pollutant Emissions (tons)					
							CO	NO _x ³	SO ₂ ³	VOC ³	PM _{10f} /PM _{2.5} ⁴	CO	NO _x	SO ₂	VOC	PM _{10f} /PM _{2.5}		
3-Drum Puller (Heavy)	Diesel	2270002081	240	4	0.21	2,392	0.86	2.63	0.00	0.23	0.17	0.46	1.40	0.002	0.12	0.09		
3-Drum Puller (Medium)	Diesel	2270002081	160	4	0.21	2,392	1.11	2.83	0.00	0.25	0.25	0.39	1.00	0.002	0.09	0.09		
Air Compressor	Diesel	2270006015	197	7	0.59	4,102	0.57	2.68	0.00	0.22	0.12	2.08	9.84	0.02	0.81	0.44		
All-Terrain Vehicle (ATV)	Diesel	2270001040	22	3	0.21	3,256	2.47	4.46	0.01	0.48	0.36	0.12	0.22	0.00	0.02	0.02		
Backhoe	Diesel	2270002066	106	7	0.59	3,132	2.60	4.37	0.01	0.70	0.51	3.93	6.61	0.01	1.06	0.77		
Bobcat	Diesel	2270002072	49	7	0.59	1,687	3.48	4.82	0.01	0.78	0.15	1.31	1.81	0.00	0.29	0.22		
Bulldozer (D-8 Cat or Equivalent)	Diesel	2270002069	305	13	0.59	1,338	1.00	2.53	0.00	0.18	0.15	3.46	8.72	0.02	0.61	0.52		
Chipper	Diesel	2270004056	85	2	0.59	1,248	2.19	4.00	0.01	0.43	0.39	0.30	0.55	0.00	0.06	0.05		
Crane (30-ton)	Diesel	2270002045	152	4	0.43	2,392	0.65	2.48	0.00	0.22	0.16	0.45	1.71	0.00	0.15	0.11		
Crane (Rubber Tired)	Diesel	2270002045	235	20	0.43	4,496	0.49	2.27	0.00	0.20	0.10	4.92	22.75	0.04	1.98	1.03		
Double Bull-Wheel Tensioner (Heavy)	Diesel	2270002081	130	2	0.21	2,392	1.11	2.83	0.00	0.25	0.25	0.16	0.41	0.00	0.04	0.04		
Double Bull-Wheel Tensioner (Light)	Diesel	2270002081	85	2	0.21	2,392	2.86	3.24	0.00	0.32	0.40	0.27	0.30	0.00	0.03	0.04		
Drill Rig	Diesel	2270002033	325	5	0.43	2,248	1.36	4.50	0.00	0.31	0.21	2.35	7.78	0.01	0.54	0.37		
Excavator	Diesel	2270002036	159	11	0.59	1,248	0.80	1.82	0.00	0.18	0.19	1.13	2.59	0.01	0.26	0.28		
Feller Buncher	Diesel	2270007015	243	2	0.59	1,248	0.50	2.09	0.00	0.16	0.09	0.20	0.83	0.00	0.06	0.04		
Flail mower or Bush hog	Diesel	2270002081	50	2	0.21	936	1.19	4.02	0.00	0.24	0.19	0.03	0.09	0.00	0.01	0.00		
Fork Lift	Diesel	2270002057	300	15	0.59	3,992	0.80	2.42	0.00	0.22	0.16	9.33	28.28	0.05	2.51	1.83		
Generator	Diesel	2270006005	43	15	0.59	4,680	1.92	4.73	0.01	0.50	0.37	3.77	9.29	0.01	0.98	0.72		
Hydra-Ax or Mulcher	Diesel	2270002081	210	2	0.59	1,248	0.86	2.63	0.00	0.23	0.17	0.29	0.90	0.00	0.08	0.06		
Loader	Diesel	2270002066	369	11	0.21	1,980	2.12	4.10	0.01	0.61	0.40	3.94	7.63	0.01	1.14	0.74		
Motor Grader	Diesel	2270002048	297	4	0.59	2,210	0.62	1.82	0.00	0.18	0.12	1.06	3.11	0.01	0.31	0.21		
Office Trailer	Diesel	2270006005	43	2	0.59	10,998	1.92	4.73	0.01	0.50	0.37	1.18	2.91	0.00	0.31	0.23		
Plate Compactor	Gasoline	2265002009	7.9	5	0.43	2,248	355.80	1.45	0.02	5.48	0.11	14.97	0.06	0.00	0.23	0.00		
Road Sweeper	Diesel	2270003030	50	5	0.43	3,618	0.84	3.76	0.00	0.21	0.14	0.36	1.61	0.00	0.09	0.06		
Roller Compactor	Diesel	2270002015	133	2	0.43	1,248	0.96	2.38	0.00	0.22	0.23	0.15	0.37	0.00	0.03	0.04		
Scraper	Diesel	2270002018	407	2	0.59	936	1.03	2.58	0.00	0.18	0.21	0.51	1.28	0.00	0.09	0.11		
Single-Drum Puller (Large)	Diesel	2270002081	210	2	0.21	2,990	0.86	2.63	0.00	0.23	0.17	0.25	0.76	0.00	0.07	0.05		
Skidder	Diesel	2270002061	182	2	0.59	1,248	0.86	2.63	0.00	0.23	0.17	0.25	0.78	0.00	0.07	0.05		
Wagon Drill	Diesel	2270002033	450	5	0.43	1,686	1.36	4.50	0.00	0.31	0.21	2.44	8.08	0.01	0.56	0.38		
Wire Reel Trailer	Diesel	2270002081	450	12	0.21	598	1.56	3.58	0.00	0.24	0.22	1.17	2.68	0.00	0.18	0.16		
Total Heavy Equipment Tailpipe Emissions												61.24	134.35	0.21	12.79	8.73		

1 Source: EPA (2005)
2 Source: EPA (2009, ACTIVITY.DAT input file)
3 Source: EPA (2009, run for calendar year)
4 PM_{2.5} emissions are conservatively estimated as being equal to PM₁₀ emissions for combustion sources.

Table 2:
HVDC Line Non-Road Construction Equipment Greenhouse Gas Pollutant Emissions

Equipment Type	Fuel	Source Category ¹	Engine Rating (hp)	No.	Load Factor ²	Operating Schedule (hours)	Pollutant Emission Factor (g/hp-hour)				Pollutant Emissions (tons)			
							CO ₂ ³	CH ₄ ⁴	N ₂ O ⁴	CO ₂ e ⁵	CO ₂	CH ₄	N ₂ O	CO ₂ e
3-Drum Puller (Heavy)	Diesel	2270002081	240	4	0.21	2,392	536	0.030	0.014	541	285	0.016	0.007	288
3-Drum Puller (Medium)	Diesel	2270002081	160	4	0.21	2,392	536	0.030	0.014	541	190	0.011	0.005	192
Air Compressor	Diesel	2270006015	197	7	0.59	4,102	530	0.030	0.014	535	1,951	0.111	0.050	1,969
All-Terrain Vehicle (ATV)	Diesel	2270001060	22	3	0.21	3,256	595	0.034	0.015	600	30	0.002	0.001	30
Backhoe	Diesel	2270002066	106	7	0.59	3,132	713	0.040	0.018	719	1,077	0.061	0.027	1,087
Bobcat	Diesel	2270002072	49	7	0.59	1,687	694	0.039	0.018	700	261	0.015	0.007	263
Bulldozer (D-8 Cat or Equivalent)	Diesel	2270002069	305	13	0.59	1,338	536	0.030	0.014	541	1,850	0.105	0.047	1,867
Chipper	Diesel	2270004056	85	2	0.59	1,248	589	0.033	0.015	594	81	0.005	0.002	82
Crane (30-ton)	Diesel	2270002045	152	4	0.43	2,392	530	0.030	0.014	535	366	0.021	0.009	369
Crane (Rubber Tired)	Diesel	2270002045	235	20	0.43	4,496	530	0.030	0.014	535	5,313	0.302	0.135	5,361
Double Bull-Wheel Tensioner (Heavy)	Diesel	2270002081	130	2	0.21	2,392	536	0.030	0.014	541	77	0.004	0.002	78
Double Bull-Wheel Tensioner (Light)	Diesel	2270002081	85	2	0.21	2,392	595	0.034	0.015	601	56	0.003	0.001	57
Drill Rig	Diesel	2270002033	325	5	0.43	2,248	530	0.030	0.014	535	918	0.052	0.023	926
Excavator	Diesel	2270002036	159	11	0.59	1,248	536	0.030	0.014	541	761	0.043	0.019	768
Feller Buncher	Diesel	2270007015	243	2	0.59	1,248	536	0.030	0.014	541	212	0.012	0.005	213
Fall mower or Bush hog	Diesel	2270002081	50	2	0.21	936	595	0.034	0.015	601	13	0.001	0.000	13
Fork Lift	Diesel	2270002057	300	15	0.59	3,992	536	0.030	0.014	541	6,264	0.356	0.160	6,321
Generator	Diesel	2270006005	43	15	0.59	4,680	589	0.033	0.015	594	1,156	0.066	0.029	1,166
Hydra-Ax or Mulcher	Diesel	2270002081	210	2	0.59	1,248	536	0.030	0.014	541	183	0.010	0.005	184
Loader	Diesel	2270002066	297	4	0.59	1,980	625	0.035	0.016	630	1,162	0.066	0.030	1,173
Motor Grader	Diesel	2270002048	369	11	0.21	2,210	536	0.030	0.014	541	916	0.052	0.023	924
Office Trailer	Diesel	2270006005	43	2	0.59	10,998	589	0.033	0.015	594	362	0.021	0.009	365
Plate Compactor	Gasoline	2265002009	7.9	5	0.43	2,248	1,046	0.059	0.026	1,055	44	0.002	0.001	44
Road Sweeper	Diesel	2270003030	50	5	0.43	3,618	590	0.034	0.015	595	253	0.014	0.006	255
Roller Compactor	Diesel	2270002015	133	2	0.43	1,248	536	0.030	0.014	541	84	0.005	0.002	85
Scraper	Diesel	2270002018	407	2	0.59	936	536	0.030	0.014	541	266	0.015	0.007	268
Single-Drum Puller (Large)	Diesel	2270002081	210	2	0.21	2,990	536	0.030	0.014	541	156	0.009	0.004	157
Skidder	Diesel	2270002061	182	2	0.59	1,248	536	0.030	0.014	541	158	0.009	0.004	160
Wagon Drill	Diesel	2270002033	450	5	0.43	1,686	530	0.030	0.014	535	953	0.054	0.024	962
Wire Reel Trailer	Diesel	2270002081	450	12	0.21	598	536	0.030	0.014	541	401	0.023	0.010	404
Total Heavy Equipment Tailpipe Emissions							147	25,799	1.47	0.66	26,031			

1 Source: EPA (2005)
2 Source: EPA (2009, ACTIVITY.DAT input file)
3 Source: EPA (2009 run for calendar year)
4 Ratios based on default emission factors from The Climate Registry (2012).
5 The global warming potentials used for CO₂, CH₄, and N₂O are 1, 25, and 298, respectively.

Table 3:
AC Line Non-Road Construction Equipment Criteria Pollutant Emissions

Equipment Type	Fuel	Source Category	Engine Rating (hp)	No.	Load Factor ²	Operating Schedule (hours)	Pollutant Emission Factor (g/hp-hour) ³				Pollutant Emissions (tons)					
							CO	NOx ³	SO ₂ ³	VOC ³	PM ₁₀ ⁴	PM _{2.5⁴}	CO	NO _x	SO ₂	VOC
3-Drum Puller (Heavy)	Diesel	2270002081	240	4	0.21	680	0.86	2.63	0.00	0.23	0.17	0.13	0.40	0.00	0.03	0.03
3-Drum Puller (Medium)	Diesel	2270002081	160	4	0.21	680	1.11	2.83	0.00	0.25	0.25	0.11	0.28	0.00	0.03	0.02
Air Compressor	Diesel	2270006015	197	7	0.59	1,336	0.57	2.68	0.00	0.22	0.12	0.68	3.21	0.01	0.27	0.14
All-Terrain Vehicle (ATV)	Diesel	2270001060	22	3	0.21	812	2.47	4.46	0.01	0.48	0.36	0.03	0.06	0.00	0.01	0.00
Backhoe	Diesel	2270002066	106	7	0.59	792	2.60	4.37	0.01	0.70	0.51	0.99	1.67	0.00	0.27	0.19
Bobcat	Diesel	2270002072	49	7	0.59	621	3.48	4.52	0.01	0.78	0.59	0.48	0.67	0.00	0.11	0.08
Bulldozer (D-8 Cat or Equivalent)	Diesel	2270002069	305	13	0.59	448	1.00	2.83	0.00	0.18	0.15	1.16	2.92	0.01	0.20	0.17
Chipper	Diesel	2270004056	85	2	0.59	270	2.19	4.00	0.01	0.43	0.39	0.07	0.12	0.00	0.01	0.01
Crane (30-ton)	Diesel	2270002045	152	4	0.43	680	0.65	2.48	0.00	0.22	0.16	0.13	0.49	0.00	0.04	0.03
Crane (Rubber Tired)	Diesel	2270002045	235	20	0.43	1,288	0.49	2.27	0.00	0.20	0.10	1.41	6.52	0.01	0.57	0.29
Double Bull-Wheel Tensioner (Heavy)	Diesel	2270002081	130	2	0.21	680	1.11	2.83	0.00	0.25	0.25	0.05	0.12	0.00	0.01	0.01
Double Bull-Wheel Tensioner (Light)	Diesel	2270002081	85	2	0.21	680	2.86	3.24	0.00	0.32	0.40	0.08	0.09	0.00	0.01	0.01
Drill Rig	Diesel	2270002033	325	5	0.43	640	1.36	4.50	0.00	0.31	0.21	0.67	2.22	0.00	0.15	0.11
Excavator	Diesel	2270002036	159	11	0.59	360	0.80	1.82	0.00	0.18	0.19	0.33	0.75	0.00	0.08	0.08
Feller Buncher	Diesel	2270007015	243	2	0.59	360	0.50	2.09	0.00	0.16	0.09	0.06	0.24	0.00	0.02	0.01
Flail mower or Bush hog	Diesel	2270002081	50	2	0.21	270	1.19	4.02	0.00	0.24	0.19	0.01	0.03	0.00	0.00	0.00
Fork Lift	Diesel	2270002057	300	15	0.59	1,144	0.80	2.42	0.00	0.22	0.16	2.67	8.10	0.01	0.72	0.53
Generator	Diesel	2270006005	43	15	0.59	1,340	1.92	4.73	0.01	0.50	0.37	1.08	2.66	0.00	0.28	0.21
Hydra-Ax or Mulcher	Diesel	2270002081	210	2	0.59	360	0.86	2.63	0.00	0.23	0.17	0.08	0.26	0.00	0.02	0.02
Loader	Diesel	2270002066	369	11	0.21	567	2.12	4.10	0.01	0.61	0.40	1.13	2.18	0.00	0.33	0.21
Motor Grader	Diesel	2270002048	297	4	0.59	630	0.62	1.82	0.00	0.18	0.12	0.30	0.89	0.00	0.09	0.06
Office Trailer	Diesel	2270006005	43	2	0.59	3,150	1.92	4.73	0.01	0.50	0.37	0.34	0.83	0.00	0.09	0.06
Plate Compactor	Gasoline	2265002009	79	5	0.43	640	355.80	1.45	0.02	5.48	0.11	4.26	0.02	0.00	0.07	0.00
Road Sweeper	Diesel	2270003030	50	5	0.43	1,032	0.84	3.76	0.00	0.21	0.14	0.10	0.46	0.00	0.03	0.02
Roller Compactor	Diesel	2270002015	133	2	0.43	360	0.96	2.38	0.00	0.22	0.23	0.04	0.11	0.00	0.01	0.01
Scraper	Diesel	2270002018	407	2	0.59	270	1.03	2.58	0.00	0.18	0.21	0.15	0.37	0.00	0.03	0.03
Single-Drum Puller (Large)	Diesel	2270002081	210	2	0.21	850	0.86	2.63	0.00	0.23	0.17	0.07	0.22	0.00	0.02	0.01
Skidder	Diesel	2270002061	182	2	0.59	360	0.86	2.63	0.00	0.23	0.17	0.07	0.22	0.00	0.02	0.01
Wagon Drill	Diesel	2270002033	450	5	0.43	480	1.36	4.50	0.00	0.31	0.21	0.70	2.30	0.00	0.16	0.11
Wire Reel Trailer	Diesel	2270002081	450	12	0.21	170	1.56	3.58	0.00	0.24	0.22	0.33	0.76	0.00	0.05	0.05
Total Heavy Equipment Tailpipe Emissions												17.70	39.14	0.06	3.71	2.53

1 Source: EPA (2005)
2 Source: EPA (2009, ACTIVITY.DAT input file)
3 Source: EPA (2009, run for calendar year)
4 PM_{2.5} emissions are conservatively estimated as being equal to PM₁₀ emissions for combustion sources.

Table 4:
AC Line Non-Road Construction Equipment Greenhouse Gas Pollutant Emissions

Equipment Type	Fuel	Source Category ¹	Engine Rating (hp)	No.	Load Factor ²	Operating Schedule (hours)	Pollutant Emission Factor (g/hp-hour)				Pollutant Emissions (tons)			
							CO ₂ ³	CH ₄ ⁴	N ₂ O ⁴	COe ⁵	CO ₂	CH ₄	N ₂ O	COe
3-Drum Pulver (Heavy)	Diesel	2270002081	240	4	0.21	680	536	0.030	0.014	541	81	0.005	0.002	82
3-Drum Pulver (Medium)	Diesel	2270002081	160	4	0.21	680	536	0.030	0.014	541	54	0.003	0.001	54
Air Compressor	Diesel	2270006015	197	7	0.59	1,336	530	0.030	0.014	535	635	0.036	0.016	641
All-Terrain Vehicle (ATV)	Diesel	2270001060	22	3	0.21	792	595	0.034	0.015	600	7	0.000	0.000	7
Backhoe	Diesel	2270002066	106	7	0.59	792	713	0.040	0.018	719	272	0.015	0.007	275
Bobcat	Diesel	2270002072	49	7	0.59	621	694	0.039	0.018	700	96	0.005	0.002	97
Bulldozer (D-8 Cat or Equivalent)	Diesel	2270002069	305	13	0.59	448	536	0.030	0.014	541	620	0.035	0.016	625
Chipper	Diesel	2270004056	85	2	0.59	270	589	0.033	0.015	594	18	0.001	0.000	18
Crane (30-ton)	Diesel	2270002045	152	4	0.43	680	530	0.030	0.014	535	104	0.006	0.003	105
Crane (Rubber Tired)	Diesel	2270002045	235	20	0.43	1,288	530	0.030	0.014	535	1,522	0.086	0.039	1,536
Double Bull-Wheel Tensioner (Heavy)	Diesel	2270002081	130	2	0.21	680	536	0.030	0.014	541	22	0.001	0.001	22
Double Bull-Wheel Tensioner (Light)	Diesel	2270002081	85	2	0.21	680	595	0.034	0.015	601	16	0.001	0.000	16
Drill Rig	Diesel	2270002033	325	5	0.43	640	530	0.030	0.014	535	261	0.015	0.007	264
Excavator	Diesel	2270002036	159	11	0.59	360	536	0.030	0.014	541	220	0.012	0.006	222
Feller Buncher	Diesel	2270007015	243	2	0.59	360	536	0.030	0.014	541	61	0.003	0.002	62
Flat mower or Bush hog	Diesel	2270002081	50	2	0.21	270	595	0.034	0.015	601	4	0.000	0.000	4
Fork Lift	Diesel	2270002057	300	15	0.59	1,144	536	0.030	0.014	541	1,795	0.102	0.046	1,811
Generator	Diesel	2270006005	43	15	0.59	1,340	589	0.033	0.015	594	331	0.019	0.008	334
Hydra-Ax or Mulcher	Diesel	2270002081	210	2	0.59	360	536	0.030	0.014	541	53	0.003	0.001	53
Loader	Diesel	2270002066	369	11	0.21	567	625	0.035	0.016	630	333	0.019	0.008	336
Motor Grader	Diesel	2270002048	297	4	0.59	630	536	0.030	0.014	541	261	0.015	0.007	263
Office Trailer	Diesel	2270006005	43	2	0.59	3,150	589	0.033	0.015	594	104	0.006	0.003	105
Plate Compactor	Gasoline	2265002009	7.9	5	0.43	640	1,046	0.059	0.026	1,055	13	0.001	0.000	13
Road Sweeper	Diesel	2270003030	50	5	0.43	1,032	590	0.034	0.015	595	72	0.004	0.002	73
Roller Compactor	Diesel	2270002015	133	2	0.43	360	536	0.030	0.014	541	24	0.001	0.001	25
Scraper	Diesel	2270002018	407	2	0.59	270	536	0.030	0.014	541	77	0.004	0.002	77
Single-Drum Pulver (Large)	Diesel	2270002081	210	2	0.21	850	536	0.030	0.014	541	44	0.003	0.001	45
Skidder	Diesel	2270002061	182	2	0.59	360	536	0.030	0.014	541	46	0.003	0.001	46
Wagon Drill	Diesel	2270002033	450	5	0.43	480	530	0.030	0.014	535	271	0.015	0.007	274
Wire Reel Trailer	Diesel	2270002081	450	12	0.21	170	536	0.030	0.014	541	114	0.006	0.003	115
Total Heavy Equipment Tailpipe Emissions											7,530	0.43	0.19	7,598.1

1 Source: EPA (2005)
2 Source: EPA (2009, ACTIVITY DAT input file)
3 Source: EPA (2009, ton for calendar year)
4 Ratios based on default emission factors from The Climate Registry (2012).
5 The global warming potentials used for CO₂, CH₄, and N₂O are 1, 25, and 298, respectively.

Table 5:
Converter Station Non-Road Construction Equipment Criteria Pollutant Emissions

Equipment Type	Fuel	Source Category ¹	Engine Rating (hp)	No.	Load Factor ²	Operating Schedule (hours)	Pollutant Emission Factor (g/hp-hour) ³						Pollutant Emissions (tons)					
							CO	NO _x ⁴	SO ₂ ³	VOC ³	PM ₁₀ /PM _{2.5} ⁴	CO	NO _x	SO ₂	VOC	PM ₁₀ /PM _{2.5}		
Air Compressor	Diesel	2270006015	197	5	0.59	1,992	0.57	2.68	0.00	0.22	0.12	0.72	3.41	0.01	0.28	0.15		
All-Terrain Vehicle (ATV)	Diesel	2270001060	22	6	0.21	1,880	2.47	4.46	0.01	0.48	0.36	0.14	0.26	0.00	0.03	0.02		
Bobcat/Skid Loader	Diesel	2270002072	49	8	0.59	2,082	3.48	4.82	0.01	0.78	0.59	1.85	2.56	0.00	0.41	0.31		
Boom Lift	Diesel	2270002057	110	4	0.43	2,346	1.04	2.62	0.00	0.24	0.15	0.51	1.28	0.00	0.12	0.07		
Bulldozer (D-8 Cat or Equivalent)	Diesel	2270002069	305	1	0.59	2,800	1.00	2.53	0.00	0.18	0.15	0.56	1.40	0.00	0.10	0.08		
Builder (D-4 Cat or Equivalent)	Diesel	2270002069	85	1	0.59	2,800	2.35	2.45	0.00	0.23	0.31	0.36	0.38	0.00	0.03	0.05		
Concrete Line Pump	Diesel	2270006010	40	3	0.59	1,476	1.64	4.54	0.01	0.40	0.32	0.19	0.52	0.00	0.05	0.04		
Excavator Mini	Diesel	2270002036	20	8	0.59	2,776	2.38	4.46	0.01	0.47	0.36	0.69	1.29	0.00	0.14	0.10		
Excavator 100 Series	Diesel	2270002036	81	10	0.59	2,776	2.16	2.19	0.00	0.20	0.29	3.17	3.21	0.01	0.29	0.43		
Excavator 300 Series	Diesel	2270002036	115	4	0.59	2,800	0.80	1.82	0.00	0.18	0.19	0.67	1.53	0.00	0.15	0.16		
Forklift (Telescopic)	Diesel	2270002057	100	10	0.59	2,264	2.75	3.05	0.00	0.30	0.37	4.04	4.50	0.01	0.44	0.54		
Generator	Diesel	2270006005	43	6	0.59	2,160	1.92	4.73	0.01	0.50	0.37	0.70	1.71	0.00	0.18	0.13		
Wheel Loader (5 CY)	Diesel	2270002060	300	6	0.59	2,704	0.72	2.17	0.00	0.20	0.14	2.29	6.88	0.01	0.63	0.45		
Loader Backhoe	Diesel	2270002066	80	17	0.21	2,472	5.70	4.65	0.01	0.97	0.84	4.44	3.62	0.00	0.76	0.66		
Motor Grader	Diesel	2270002048	297	4	0.59	2,100	0.62	1.82	0.00	0.18	0.12	1.01	2.96	0.01	0.29	0.20		
Office Trailer	Diesel	2270006005	43	5	0.21	3,610	1.92	4.73	0.01	0.50	0.37	0.35	0.85	0.00	0.09	0.07		
Plate Compactor	Gasoline	2265002009	7.9	14	0.43	2,004	355.80	1.45	0.02	5.48	0.11	37.38	0.15	0.00	0.58	0.01		
Road Sweeper	Diesel	2270003030	50	1	0.43	1,400	0.84	3.76	0.00	0.21	0.14	0.03	0.12	0.00	0.01	0.00		
Scraper	Diesel	2270002018	407	8	0.59	2,800	1.03	2.58	0.00	0.18	0.15	6.08	15.28	0.03	1.06	0.90		
Trencher	Diesel	2270002030	80	6	0.21	2,688	2.88	3.28	0.00	0.33	0.40	0.86	0.98	0.00	0.10	0.12		
Articulated Dump Truck	Diesel	2270002051	1300	2	0.43	2,800	1.11	3.11	0.00	0.24	0.13	3.82	10.72	0.01	0.84	0.45		
Vibratory Compactor	Diesel	2270002015	133	8	0.43	2,784	0.96	2.38	0.00	0.22	0.23	1.35	3.34	0.01	0.31	0.32		
Total Heavy Equipment Tailpipe Emissions												71.19	66.94	0.11	6.88	5.28		

1 Source: EPA (2005)
2 Source: EPA (2009, ACTIVITY DAT input file)
3 Source: EPA (2009, run for calendar year)
4 PM_{2.5} emissions are conservatively estimated as being equal to PM₁₀ emissions for combustion sources.

Table 6:
Converter Station Non-Road Construction Equipment Greenhouse Gas Pollutant Emissions

Equipment Type	Fuel	Source Category ¹	Engine Rating (hp)	No.	Load Factor ²	Operating Schedule (hours)	Pollutant Emission Factor (g/hp-hour)				Pollutant Emissions (tons)			
							CO ₂ ³	CH ₄ ⁴	N ₂ O ⁴	CO ₂ e ⁵	CO ₂	CH ₄	N ₂ O	CO ₂ e
Air Compressor	Diesel	2270006015	197	5	0.59	1,992	530	0.030	0.014	535	677	0.038	0.017	683
All-Terrain Vehicle (ATV)	Diesel	2270001060	22	6	0.21	1,880	595	0.034	0.015	600	34	0.002	0.001	34
Bobcat/Skid Loader	Diesel	2270002072	49	8	0.59	2,082	694	0.039	0.018	700	368	0.021	0.009	371
Boom Lift	Diesel	2270002057	110	4	0.43	2,346	536	0.030	0.014	541	262	0.015	0.007	265
Bulldozer (D-8 Cat or Equivalent)	Diesel	2270002069	305	1	0.59	2,800	536	0.030	0.014	541	298	0.017	0.008	301
Bulldozer (D-4 Cat or Equivalent)	Diesel	2270002069	85	1	0.59	2,800	595	0.034	0.015	601	92	0.005	0.002	93
Concrete Line Pump	Diesel	2270006010	40	3	0.59	1,476	589	0.033	0.015	594	68	0.004	0.002	68
Excavator Mini	Diesel	2270002036	20	8	0.59	2,776	595	0.034	0.015	600	172	0.010	0.004	173
Excavator 100 Series	Diesel	2270002036	81	10	0.59	2,776	596	0.034	0.015	601	871	0.049	0.022	879
Excavator 300 Series	Diesel	2270002036	115	4	0.59	2,800	536	0.030	0.014	541	449	0.026	0.011	453
Forklift (Telescopic)	Diesel	2270002057	100	10	0.59	2,264	595	0.034	0.015	601	876	0.050	0.022	884
Generator	Diesel	2270006005	43	6	0.59	2,160	589	0.033	0.015	594	213	0.012	0.005	215
Wheel Loader (5 CY)	Diesel	2270002060	300	6	0.59	2,704	536	0.030	0.014	541	1,697	0.096	0.043	1,713
Loader Backhoe	Diesel	2270002066	80	17	0.21	2,472	693	0.039	0.018	699	539	0.031	0.014	544
Motor Grader	Diesel	2270002048	297	4	0.59	2,100	536	0.030	0.014	541	870	0.049	0.022	878
Office Trailer	Diesel	2270006005	43	5	0.21	3,610	589	0.033	0.015	594	106	0.006	0.003	107
Plate Compactor	Gasoline	2265002009	7.9	14	0.43	2,004	1,046	0.059	0.026	1,055	110	0.006	0.003	111
Road Sweeper	Diesel	2270003030	50	1	0.43	1,400	590	0.034	0.015	595	20	0.001	0.000	20
Scrapper	Diesel	2270002018	407	8	0.59	2,800	536	0.030	0.014	541	3,180	0.181	0.081	3,208
Trencher	Diesel	2270002030	80	6	0.21	2,688	595	0.034	0.015	601	178	0.010	0.005	179
Articulated Dump Truck	Diesel	2270002048	1300	2	0.43	2,800	536	0.030	0.014	541	1,850	0.105	0.047	1,867
Vibratory Compactor	Diesel	2270006005	133	8	0.43	2,784	536	0.030	0.014	541	753	0.043	0.019	760
Total Heavy Equipment Tailpipe Emissions											13,683	0.78	0.35	13,806.6

1 Source: EPA (2005)
2 Source: EPA (2009, ACTIVITY.DAT input file)
3 Source: EPA (2009, run for calendar year)
4 Source: The Climate Registry (2012)
5 Ratios based on default emission factors from The Climate Registry (2012)
6 The global warming potentials used for CO₂, CH₄, and N₂O are 1, 25, and 298, respectively.

Table 7:
Portable Concrete Batch Plant Non-Road Construction Equipment Criteria Pollutant Emissions

Equipment Type	Fuel	Source Category ¹	Engine Rating (hp)	No.	Load Factor ²	Operating Schedule (hours)	Pollutant Emission Factor (g/hp-hour) ³						Pollutant Emissions (tons)				
							CO	NO _x ³	SO ₂ ³	VOC ³	PM ₁₀ ⁴	PM _{2.5} ⁴	CO	NO _x	SO ₂	VOC	PM ₁₀
Generator	Diesel	2270006005	43	1	0.59	678	1.92	4.73	0.01	0.50	0.37	0.04	0.09	0.00	0.01	0.01	
Wheel Loader (5 CY)	Diesel	2270002060	300	1	0.21	678	0.72	2.17	0.00	0.20	0.14	0.03	0.10	0.00	0.01	0.01	
Office Trailer	Diesel	2270006005	43	1	0.59	678	1.92	4.73	0.01	0.50	0.37	0.04	0.09	0.00	0.01	0.01	
Dump Truck	Diesel	2270002051	450	2	0.43	678	0.64	1.63	0.00	0.16	0.10	0.18	0.47	0.00	0.04	0.03	
Total Heavy Equipment Tailpipe Emissions												0.29	0.752	0.0016	0.07	0.05	

- 1 Source: EPA (2005).
- 2 Source: EPA (2009, ACTIVITY.DAT input file)
- 3 Source: EPA (2009, run for calendar year)
- 4 PM_{2.5} emissions are conservatively estimated as being equal to PM₁₀ emissions for combustion sources.

Table 8:
Converter Station Non-Road Construction Equipment Greenhouse Gas Pollutant Emissions

Equipment Type	Fuel	Source Category ¹	Engine Rating (hp)	No.	Load Factor ²	Operating Schedule (hours)	Pollutant Emission Factor (g/hp-hour)						Pollutant Emissions (tons)				
							CO ₂ ³	CH ₄ ⁴	N ₂ O ⁴	CO _{2e} ⁵	CH ₄	N ₂ O	CO _{2e}	CH ₄	N ₂ O	CO _{2e}	
Generator	Diesel	2270006005	43	1	0.59	678	589	0.033	0.015	594	11	0.001	0.000	0.000	11		
Wheel Loader (5 CY)	Diesel	2270002060	300	1	0.21	678	536	0.030	0.014	541	25	0.001	0.001	0.001	25		
Office Trailer	Diesel	2270006005	43	1	0.59	678	589	0.033	0.015	594	11	0.001	0.000	0.000	11		
Dump Truck	Diesel	2270002051	450	2	0.43	678	536	0.030	0.014	541	155	0.009	0.004	0.004	157		
Total Heavy Equipment Tailpipe Emissions											203	0.01	0.01	0.01	205		

- 1 Source: EPA (2005)
- 2 Source: EPA (2009, ACTIVITY.DAT input file)
- 3 Source: EPA (2009, run for calendar year)
- 4 Source: The Climate Registry (2012)
- 5 The global warming potentials used for CO₂, CH₄, and N₂O are 1, 25, and 298, respectively.

Table 9:
HVDC Line On-Road Construction Equipment/Vehicles Emissions

Vehicle	Fuel	Equipment Engine Size (hp)	Load (%)	No. of Units	Round Trips per Day per Unit	Total Round Trips per Day	Roads		Unpaved Roads	Total Working Days per Unit	Total VMT for Construction Period						Emissions (tons)					
							Paved Roads	Unpaved Roads			Paved Roads	Unpaved Roads	Total	NO _x	VOCs	CO	SO ₂	PM ₁₀	PM _{2.5}	CO ₂		
Boom Truck	Diesel	355	21	5	2	10	22.5	7.5	499	112,275	37,425	149,700	0.32	0.03	0.13	0.001	0.013	0.007	0.012	146		
Concrete Truck	Diesel	450	59	15	4	60	45	15	281	758,700	252,900	1,011,600	2.17	0.21	0.91	0.0067	0.085	0.083	989			
Crane (20-ton)	Diesel	235	43	14	1.0	14.0	22.5	7.5	290	91,350	30,450	121,800	0.26	0.02	0.11	0.0008	0.010	0.010	119			
Cranes (120- to 300-ton)	Diesel	245	43	10	1.00	10.00	0.05	0.45	562	281	2,529	2,810	0.006	0.001	0.003	0.00002	0.000	0.000	3			
Dump Truck	Diesel	455	21	19	4.0	76.0	22.5	7.5	385	658,350	219,450	877,800	1.88	0.18	0.79	0.0058	0.074	0.072	858			
Fuel Truck	Diesel	450	21	2	4	83	0	10	624	149,760	49,920	199,680	0.43	0.04	0.18	0.0013	0.017	0.016	195			
Mechanics' Truck	Diesel	400	43	2	2.00	42.00	6.25	8.75	611	64,155	21,385	85,540	0.19	0.02	0.14	0.0004	0.001	0.001	60			
Pick-up Truck	Diesel	400	43	114	1	11	430	10	414	1,415,880	471,960	1,887,840	3.30	0.36	2.47	0.0089	0.143	0.139	1,332			
Splicing Truck	Diesel	400	21	4	1.0	40.0	0.1	0.9	299	120	1,076	1,196	0.003	0.0003	0.002	0.00001	0.00002	0.00001	1			
Steel Haul Truck	Diesel	455	43	10	4	40	30	10	499	598,800	199,600	798,400	5.45	0.20	1.24	0.0120	0.204	0.198	1,764			
Truck (1-ton)	Diesel	400	43	10	4.0	40.0	22.5	7.5	421	378,900	126,300	505,200	1.12	0.14	0.82	0.0024	0.006	0.006	354			
Truck (2-ton)	Diesel	400	43	20	4.0	80.0	22.5	7.5	562	1,011,600	337,200	1,348,800	2.89	0.27	1.21	0.0089	0.114	0.110	1,319			
Truck (5-ton)	Diesel	325	43	8	4.0	32.0	22.5	7.5	299	215,280	71,760	287,040	0.62	0.06	0.26	0.0019	0.024	0.023	281			
Water Truck	Diesel	325	21	4	6.0	24.0	7.5	7.5	390	70,200	70,200	140,400	0.30	0.03	0.13	0.0009	0.012	0.011	137			
									TOTAL	5,525,651	1,892,155	7,417,806	19	1.55	8.4	0.05	0.70	0.68	7,557			

Table 10:
AC Line On-Road Construction Equipment/Vehicles Emissions

Vehicle	Fuel	Equipment Engine Size (hp)	Load (%)	No. of Units	Round Trips per Day per Unit	Total Round Trips per Day	Paved Roads	Unpaved Roads	Total Working Days per Unit	Total VMT for Construction Period			Emissions (tons)						
										Paved Roads	Unpaved Roads	Total	NO _x	VOCs	CO	SO ₂	PM ₁₀	PM _{2.5}	CO ₂
Boom Truck	Diesel	355	21	5	2	10	22.5	7.5	14.3	32,079	10,693	42,771	0.09	0.01	0.04	0.0003	0.004	0.003	42
Concrete Truck	Diesel	450	59	15	4	60	45	15	80	216,771	72,257	289,029	0.62	0.06	0.26	0.0019	0.024	0.024	283
Crane (20-ton)	Diesel	235	43	14	1	14	22.5	7.5	83	26,100	8,700	34,800	0.07	0.01	0.03	0.0002	0.003	0.003	34
Cranes (120- to 300-ton)	Diesel	245	43	10	1	10	0.05	0.45	161	80	723	803	0.002	0.000	0.001	0.00001	0.000	0.000	1
Dump Truck	Diesel	455	21	19	4	76	22.5	7.5	110	188,100	62,700	250,800	0.54	0.05	0.22	0.0017	0.021	0.020	245
Fuel Truck	Diesel	450	21	2	4	8	30	10	178	42,789	14,263	57,051	0.12	0.01	0.05	0.0004	0.005	0.005	56
Mechanics' Truck	Diesel	400	43	2	2	4	26.25	8.75	175	18,330	6,110	24,440	0.05	0.01	0.04	0.0001	0.000	0.000	17
Pick-up Truck	Diesel	400	43	114	1	114	30	10	118	404,537	134,846	539,383	0.94	0.10	0.71	0.0026	0.041	0.040	381
Splicing Truck	Diesel	400	21	4	1	4	0.1	0.9	85	34	308	342	0.001	0.0001	0.001	0.00002	0.000004	0.000004	0.2
Steel Haul Truck	Diesel	455	43	10	4	40	30	10	143	171,086	57,029	228,114	1.56	0.06	0.35	0.0034	0.058	0.057	504
Truck (1-ton)	Diesel	400	43	10	4	40	22.5	7.5	120	108,257	36,086	144,343	0.32	0.04	0.23	0.0007	0.002	0.002	101
Truck (2-ton)	Diesel	400	43	20	4	80	22.5	7.5	161	289,029	96,343	385,371	0.83	0.08	0.35	0.0025	0.032	0.031	377
Truck (5-ton)	Diesel	325	43	8	4	32	22.5	7.5	85	61,509	20,503	82,011	0.18	0.02	0.07	0.0005	0.007	0.007	80
Water Truck	Diesel	325	21	4	6	24	7.5	7.5	III	20,057	20,057	40,114	0.09	0.01	0.04	0.0003	0.003	0.003	39
									TOTAL	1,578,757	540,616	2,119,373	5.4	0.44	2.4	0.01	0.20	0.19	2,159

Table 11:
Converter Station On-Road Construction Equipment/Vehicles Emissions

Vehicle	Fuel	Equipment Engine Size (hp)	Load (%)	No. of Units	Round Trips per Day per Unit	Total Round Trips per Day	Paved Roads	Unpaved Roads	Total Working Days per Unit	Total WMT for Construction Period		Emissions (tons)							
										Paved Roads	Unpaved Roads	NO _x	VOCs	CO	SO ₂	PM ₁₀	PM _{2.5}	CO ₂	
Concrete Truck	Diesel	450	59%	7	5	35	28.5	1.5	226	225,435	11,865	237,300	0.509	0.0480	0.213	0.00157	0.01998	0.19380	232.0
Concrete Pump Truck	Diesel	450	59%	2	1	2	28.5	1.5	314	17,998	942	18,840	0.040	0.0038	0.017	0.00012	0.00159	0.00154	18.4
Crane (15-ton Boom Truck)	Diesel	215	43%	3	2	1	28.5	1.5	391	11,144	587	11,730	0.025	0.0024	0.011	0.00008	0.00099	0.00096	11.5
Crane (30-ton)	Diesel	235	43%	2	1	1	28.5	1.5	391	11,144	587	11,730	0.025	0.0024	0.011	0.00008	0.00099	0.00096	11.5
Crane (120- to 300-ton)	Diesel	245	43%	4	1	4	28.5	1.5	32	36,480	1,920	38,400	0.082	0.0078	0.0344	0.00025	0.00323	0.00314	37.5
Dump Truck	Diesel	455	21%	15	6	90	28.5	1.5	343	879,795	46,305	926,100	1.987	0.188	0.830	0.00613	0.07799	0.07564	905
Fuel Truck	Diesel	450	21%	3	2	6	28.5	1.5	351	60,021	3,159	63,180	0.136	0.013	0.057	0.00042	0.00532	0.00516	62
Welder Truck	Diesel	300	43%	4	2	8	28.5	1.5	391	89,148	4,692	93,840	0.209	0.025	0.152	0.00044	0.00118	0.00109	66
Lowboy Truck	Diesel	455	21%	4	6	24	28.5	1.5	332	227,088	11,952	239,040	0.513	0.048	0.214	0.00158	0.02013	0.01952	234
Mechanics' Truck	Diesel	400	43%	4	2	8	28.5	1.5	332	75,696	3,984	79,680	0.177	0.021	0.129	0.00038	0.00100	0.00092	56
Pick-up Truck	Gasoline	400	43%	45	2	90	28.5	1.5	353	905,445	47,655	953,100	0.706	0.114	5.214	0.00683	0.07229	0.01135	453
Splicing Truck	Diesel	400	21%	1	1	1	28.5	1.5	25	7,125	375	7,500	0.017	0.002	0.012	0.00004	0.00009	0.00009	5.2
Truck (1-ton)	Diesel	300	43%	16	4	64	28.5	1.5	6	10,944	576	11,520	0.026	0.003	0.019	0.00005	0.00014	0.00013	8.1
Truck (2-ton)	Diesel	400	43%	8	2	16	28.5	1.5	353	160,968	8,472	169,440	0.363	0.034	0.152	0.00112	0.01427	0.01384	166
Utility Van	Diesel	300	43%	4	2	8	28.5	1.5	25	57,000	3,000	60,000	0.133	0.016	0.097	0.00028	0.00075	0.00069	42.0
Water Truck	Diesel	400	21%	2	5	10	28.5	1.5	35	99,750	5,250	105,000	0.225	0.021	0.094	0.00069	0.00884	0.00858	103
TOTAL										2,875,080	151,320	3,026,400	5.2	0.55	7.3	0.020	0.17	0.16	2,410

Table 12:
Portable Concrete Batch Plant On-Road Construction Equipment/Vehicles Emissions

Vehicle	Fuel	Equipment Engine Size (hp)	No. of Units	Round Trips per Day per Unit	Total Round Trips per Day	Paved Roads	Unpaved Roads	Total Working Days per Unit	Total WMT for Construction Period		Emissions (tons)							
									Paved Roads	Unpaved Roads	NO _x	VOCs	CO	SO ₂	PM ₁₀	PM _{2.5}	CO ₂	
Concrete Red-Mix Truck	Diesel	400	4	4	4	45	15	113	20,340	6,780	27,120	0.06	0.006	0.024	0.0002	0.0023	0.0022	27
Dump Truck	Diesel	450	1	1	22.5	7.5	113	113	2,543	848	3,390	0.01	0.001	0.003	0.00002	0.0003	0.0003	3
Pick-up Truck	Diesel	400	1	1	30	10	113	113	3,390	1,130	4,520	0.01	0.001	0.006	0.00002	0.0003	0.0003	3
Bulk Cement Tanker Truck	Diesel	450	1	1	30	10	113	113	3,390	1,130	4,520	0.03	0.001	0.007	0.00007	0.0012	0.0011	10
TOTAL									29,663	9,888	39,550	0.10	0.008	0.040	0.0003	0.004	0.004	43

Table 13:
HVDC Line On-Road Commute Vehicle Emissions

Construction Activity	Vehicle Total Days		Daily Trip Totals (VMT/Day)		Construction Trip Totals (VMT)			Emissions (tons)							
	150	150	Paved Roads	Unpaved Roads	Paved Roads	Unpaved Roads	Total	NOx	VOCs	CO	SO ₂	PM ₁₀	PM _{2.5}	CO ₂	
															600
ROW Clearing	150	150	420	140	63,000	21,000	84,000	0.040	0.006	0.335	0.001	0.001	0.001	34	
Access Roads & Pads	150	150	420	140	63,000	21,000	84,000	0.040	0.006	0.335	0.001	0.001	0.001	34	
Foundation Construction	300	300	683	228	204,750	68,250	273,000	0.131	0.021	1.087	0.002	0.003	0.002	112	
Tower Lacing (assembly)	550	550	3360	1120	1,848,000	616,000	2,464,000	1.184	0.189	9.814	0.015	0.024	0.023	1009	
Tower Sealing (erection)	550	550	1050	350	577,500	192,500	770,000	0.370	0.059	3.067	0.005	0.008	0.007	315	
Restoration	525	525	105	35	55,125	18,375	73,500	0.035	0.006	0.293	0.000	0.001	0.001	30	
Materials Management	600	600	525	175	315,000	105,000	420,000	0.202	0.032	1.673	0.003	0.004	0.004	172	
Mechanic & Equipment Mgmt.	600	600	105	35	63,000	21,000	84,000	0.040	0.006	0.335	0.001	0.001	0.001	34	
Refueling	600	600	105	35	63,000	21,000	84,000	0.040	0.006	0.335	0.001	0.001	0.001	34	
Watering & Dust Control	600	600	105	35	157,500	52,500	210,000	0.101	0.016	0.836	0.001	0.002	0.002	86	
Sanitation/ Cleanup	600	600	263	88	3,472,875	1,157,625	4,630,500	2.2	0.35	18	0.029	0.046	0.042	1,896	
				TOTAL											

Table 14:
AC Line On-Road Commute Vehicle Emissions

Construction Activity	Vehicle Total Days	Daily Trip Totals (VMT/Day)		Construction Trip Totals (VMT)			Emissions (tons)							
		Paved Roads	Unpaved Roads	Paved Roads	Unpaved Roads	Total	NOx	VOCs	CO	SO ₂	PM ₁₀	PM _{2.5}	CO ₂	
														43
ROW Clearing	43	420	140	18,000	6,000	24,000	0.012	0.002	0.10	0.00015	0.0002	0.0002	10	
Access Roads & Pads	43	420	140	18,000	6,000	24,000	0.012	0.002	0.10	0.00015	0.0002	0.0002	10	
Foundation Construction	86	683	228	58,500	19,500	78,000	0.037	0.006	0.31	0.00048	0.0008	0.0007	32	
Tower Lacing (assembly)	157	3360	1120	528,000	176,000	704,000	0.34	0.054	2.80	0.0043	0.0070	0.0064	288	
Tower Sealing (erection)	157	1050	350	165,000	55,000	220,000	0.106	0.017	0.88	0.00136	0.0022	0.0020	90	
Restoration	150	105	35	15,750	5,250	21,000	0.010	0.002	0.08	0.00013	0.0002	0.0002	9	
Materials Management	171	525	175	90,000	30,000	120,000	0.058	0.009	0.48	0.00074	0.0012	0.0011	49	
Mechanic & Equipment Mgmt.	171	105	35	18,000	6,000	24,000	0.012	0.002	0.10	0.00015	0.0002	0.0002	10	
Refueling	171	105	35	18,000	6,000	24,000	0.012	0.002	0.10	0.00015	0.0002	0.0002	10	
Watering & Dust Control	171	105	35	18,000	6,000	24,000	0.012	0.002	0.10	0.00015	0.0002	0.0002	10	
Sanitation/ Cleanup	171	263	88	45,000	15,000	60,000	0.029	0.005	0.24	0.00037	0.0006	0.0005	25	
			TOTAL	992,250	330,750	1,323,000	0.6	0.10	5	0.008	0.013	0.012	542	

Table 15:
Converter Station On-Road Commute Vehicle Emissions

Construction Activity	Vehicle Total Days		Daily Trip Totals (WMT/Day)				Construction Trip Totals (WMT)				Emissions (tons)							
	Paved Roads	Unpaved Roads	Paved Roads	Unpaved Roads	Total	NOx	VOCs	CO	SO ₂	PM ₁₀	PM _{2.5}	CO ₂						
Site Management	264	599	158,136	8,448	166,584	0.08	0.013	0.7	0.0010	0.0017	0.0015	68						
Site Development	704	399	280,896	14,784	295,680	0.14	0.023	1.2	0.0018	0.0029	0.0027	121						
Equipment Footings	176	1530	269,280	14,256	283,536	0.14	0.022	1.1	0.0018	0.0028	0.0026	116						
Cable Trench, Conduits, Grounding	572	466	266,552	14,300	280,852	0.13	0.022	1.1	0.0017	0.0028	0.0026	115						
Steel Structures, Electrical Equipment	594	732	434,808	23,166	457,974	0.22	0.035	1.8	0.0028	0.0045	0.0042	188						
Control Building and Wiring	440	599	263,560	14,080	277,640	0.13	0.021	1.1	0.0017	0.0028	0.0025	114						
Traffic Control	572	67	38,324	2,288	40,612	0.02	0.003	0.2	0.0003	0.0004	0.0004	17						
			1,711,556	91,322	1,802,878	0.87	0.14	7.2	0.011	0.018	0.016	738						
			TOTAL															

Table 16:
On-Road Vehicle Exhaust Emission Factors

Vehicle	Fuel Type	Emission Factor* (g/WMT)							
		NOx	VOCs	CO	SO ₂	PM ₁₀	PM _{2.5}	CO ₂	
Passenger Car	Gasoline	0.2	0.03	2.264	0.0047	0.0063	0.0058	312	
Passenger Truck	Gasoline	0.672	0.109	4.963	0.0065	0.0117	0.0108	431	
Passenger Truck	Diesel	1.584	0.171	1.187	0.0043	0.0689	0.0669	640	
Light Commercial Truck	Diesel	2.017	0.244	1.471	0.0043	0.0114	0.0105	635	
Single Unit Short-Haul Truck	Diesel	1.946	0.184	0.813	0.0060	0.0764	0.0741	887	
Combination Long-Haul Truck	Diesel	6.194	0.222	1.411	0.0136	0.2318	0.2249	2004	

1 Emissions factors obtained from the EPA's MOVES2010b model (EPA 2012)

Table 17:
Fugitive Dust Emissions Roads

Construction Activity	Vehicle Type	Road Type	Total Mileage (VMT)	Emission Factor (lb/VMT)		Emissions (tons)	
				PM ₁₀	PM _{2.5}	PM ₁₀	PM _{2.5}
DC Transmission Line Segment (140-miles)	Construction	Paved	5,525,651	0.0040	0.0010	11.1	2.7
	Commuter	Unpaved	1,892,155	0.12	0.012	117.3	11.7
AC Transmission Line Segment (40-miles)	Construction	Paved	3,472,875	0.0040	0.0010	7.0	1.7
		Unpaved	1,157,625	0.12	0.012	71.8	7.2
	Commuter	Paved	1,578,757	0.0040	0.0010	3.2	0.8
		Unpaved	540,616	0.12	0.012	33.5	3.4
	Converter Station	Paved	330,750	0.12	0.012	20.5	2.1
		Unpaved	2,875,080	0.0040	0.0010	5.8	1.4
Concrete Batch Plant	Paved	151,320	0.12	0.012	9.4	0.9	
	Unpaved	1,711,556	0.0040	0.0010	3.4	0.8	
AC Transmission Line Segment (1-miles)	Construction	Paved	91,322	0.12	0.012	5.7	0.6
		Unpaved	29,663	0.0040	0.0010	0.06	0.01
	Commuter	Paved	9,888	0.12	0.012	0.61	0.06
HVDC/AC 1-mile Representative Segment	Construction	Paved	39,469	0.0040	0.0010	0.1	0.0
		Unpaved	13,515	0.12	0.012	0.8	0.1
	Commuter	Paved	24,806	0.0040	0.0010	0.0	0.0
		Unpaved	8,269	0.12	0.012	0.5	0.1

Source: EPA (2008, Sections 13.2.1, 13.2.2)

Table 18:
Fugitive Dust General Construction

Name	Affected Acres	Dust Control Efficiency ¹	Duration (Months)	Construction ^{2,3}		Controlled Emissions (tons/year)	
				PM ₁₀	PM _{2.5}	PM ₁₀	PM _{2.5}
Converter Station	70,00000	50%	12	0.11000	0.01100	46.20	4.62
HVDC 140-mile Representative Segment	3,393.96	50%	12	0.11000	0.01100	2,240.02	224.00
AC Line 40-mile Representative Segment	969.70	50%	12	0.11000	0.01100	640.00	64.00
HVDC/AC 1-mile Representative Segment	24.24	50%	1	0.11000	0.01100	1.3	0.1

1 Water and other approved dust suppressants would be used at construction sites.

2 Source: Countess Environmental (2006)

3 PM_{2.5}/PM₁₀ = 0.10 (from Countess Environmental (2006), p. 3-11)

This page intentionally left blank.

REFERENCES

- EPA (U.S. Environmental Protection Agency). 2009. *NONROAD2008a Model*. Last updated 2009.
<<http://www.epa.gov/otag/nonrdmdl.htm>>. Accessed June 17, 2014.
- . 2008. "AP-42 Compilation of Emission Factors." <<http://www.epa.gov/ttn/chief/ap42/>>. Accessed September 19, 2014.
- . 2005. User's Guide for the Final NONROAD 2005 Model. EPA420-R-05-013. December.
<<http://www.epa.gov/otag/models/nonrdmdl/nonrdmdl2005/420r05013.pdf>>. Accessed September 19, 2014.
- Countess Environmental. 2006. *WRAP Fugitive Dust Handbook*. Prepared for the Western Governors' Association (Denver, CO) under WGA Contract No. 30204-111. September 7.
<http://www.wrapair.org/forums/dejf/fdh/content/FDHandbook_Rev_06.pdf>. Accessed June 3, 2014.
- The Climate Registry. 2012. *Climate Registry Default Emission Factors*. Table 13.7, US Default CH 4 and N2O Emission Factors for Non-Highway Vehicles. January 6.
<<http://www.theclimateregistry.org/downloads/2012/01/2012-Climate-Registry-Default-Emissions-Factors.pdf>>. Attached September 19, 2014.

APPENDIX H
CONSTRUCTION EMISSION CALCULATIONS

This page intentionally left blank.