



Investigation of Micro- and Macro-Scale Transport Processes for Improved Fuel Cell Performance

2010 DOE Hydrogen Program Fuel Cell Project Kick-Off

Jon Owejan (PI)

General Motors

Electrochemical Energy Research Lab

September 28, 2010

This presentation does not contain any proprietary, confidential, or otherwise restricted information

Overview

Timeline

- Project start date: June 2010
- Project end date: May 2013
- Percent complete: 0%

Budget

- Total project funding
 - DOE share: \$4.391M
 - Contractor share: \$1.097M
- Funding received in FY10: \$0 of 527K
- Funding for FY11: \$1.618M

Barriers

- Barriers addressed
 - D. Water Transport within the Stack
 - E. System Thermal and Water Management
 - G. Start-up and Shut-down Time and Energy/Transient Operation

Partners

- Project lead: General Motors
- Subcontract Partners:
 - Rochester Inst. of Tech.
 - Univ. of Tenn. Knoxville
 - Penn State Univ.
- Other collaborations with material suppliers

Relevance

- **Objective:** Using a predefined pseudo-2D down-the-channel model architecture our work will refine component level physics such that the model can predict performance under wet and dry conditions with different material sets.
- **Topic 4a - Applications should address:**
 - Generation of near- and long-term materials (chemical, physical, and microstructural) property data to develop/validate models.
 - Development of understanding of cell component interactions and interfaces/structures.
 - Generation of experimental data on species movement in the cell/stack during operation and transients.
 - Development of test protocols and tools for *in situ observation of transport* behavior.
 - Modeling/study of the ionomer/catalyst/support interfaces
 - Macroscopic and nanoscale (molecular level) interface characterization (property and composition distribution such as hydrophobicity gradients).
 - Methods to quantify internal surface properties of porous materials (porosity, structure, permeability, capillary forces, hydrophobicity/hydrophilicity, etc.)
- **Topic 4a - Expected Outcomes:**
 - Validated transport model including all component physical and chemical properties
 - Down-the-channel pseudo-2D model will be refined and validated with data generated in the project
 - Public dissemination of the model and instructions for exercise of the model
 - Project website to include all data, statistics, observation, model code, and detailed instructions
 - Compilation of the data generated in the course of model development and validation
 - Reduced data used to guide model physics to be published and described on project website
 - Identification of rate-limiting steps and recommendations for improvements to the plate-to-plate fuel cell package.
 - Model validation with baseline and auto-competitive material sets will provide key performance limiting parameters

Approach - Overview

Material property characterization and micro-scale component models will be combined to output interfacial and bulk transport resistances into a simplified 1+1-D down-the-channel model. In separate experiments, a comprehensive macro-scale validation database will be generated with fully integrated material sets and down-the-channel resolution.

Component Studies for Model Refinement

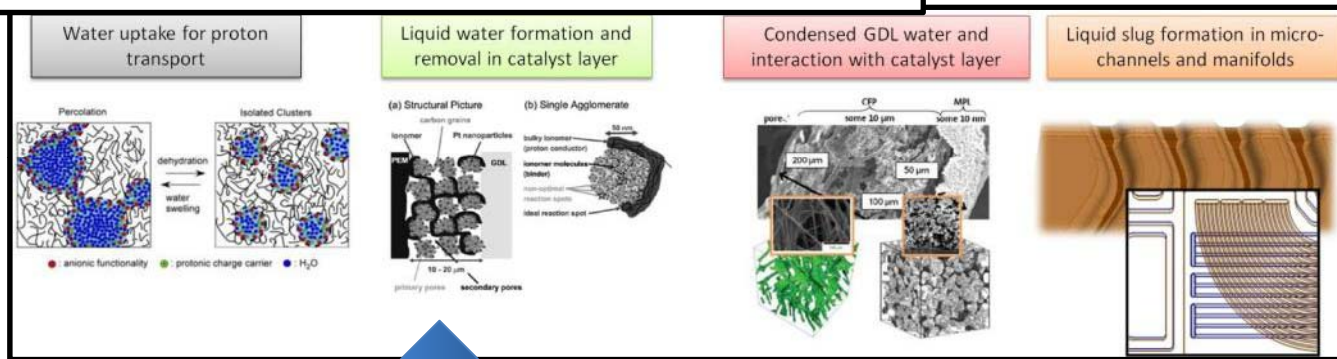

Down-the-Channel Validation

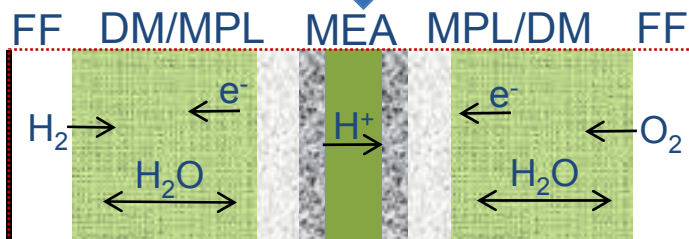
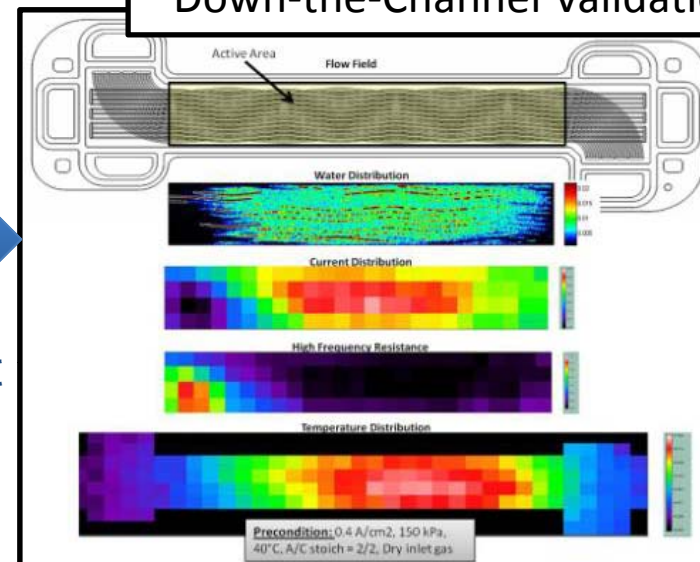

1D Model Including Interfacial Water Transport

Approach - Organization

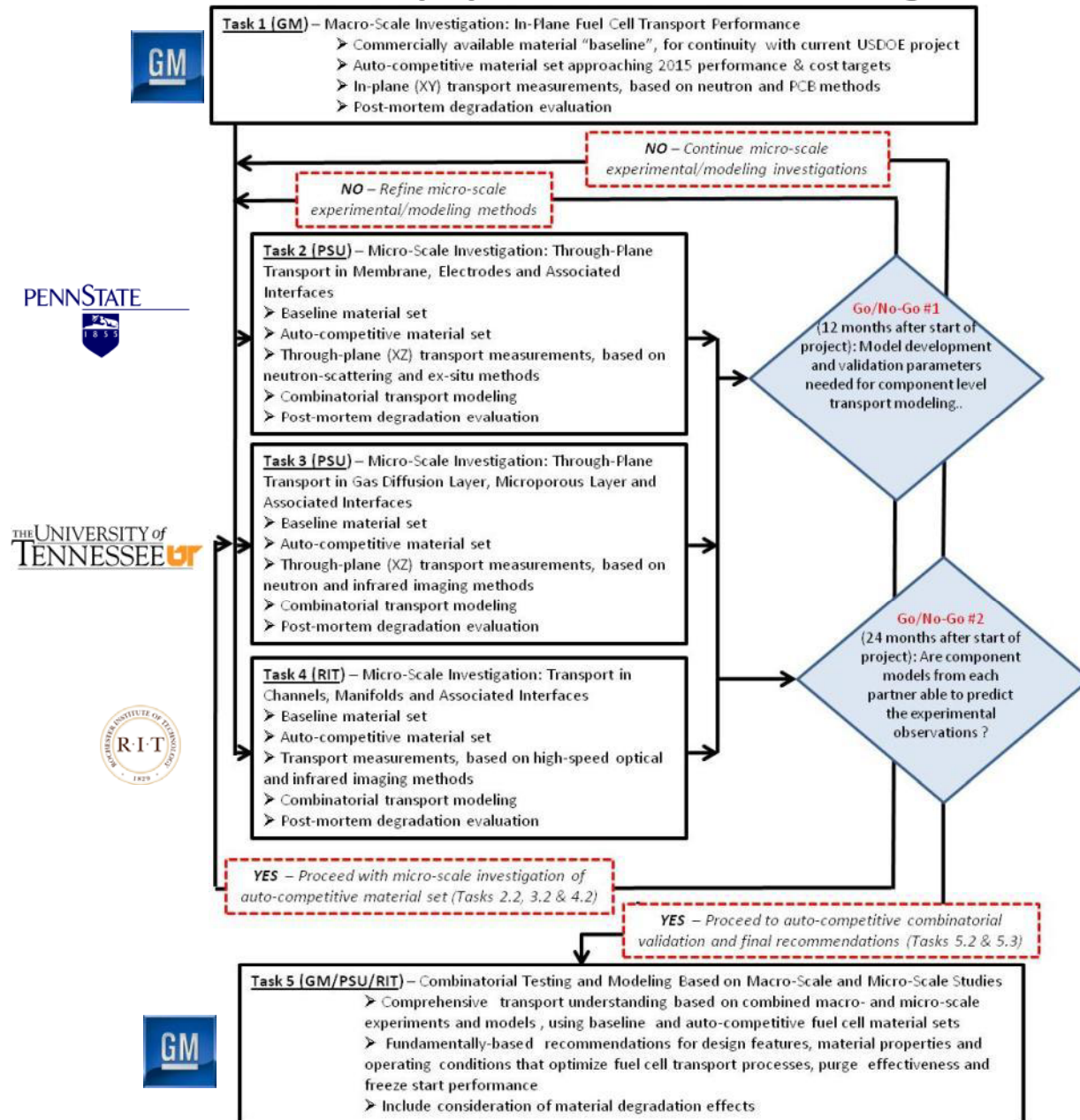

Go/No-Go #1

The decision for continuing into Budget Period 2 will be based on, in part micro-scale **measurement methods being capable of supplying all parameters needed for through-plane membrane/electrode, GDL, and channel/manifold component level transport modeling** and validation. Parameters measured for both wet and dry operating conditions should include:

- local proton resistance and swelling characteristics as a function of ionomer water content for bulk and thin layers
- through-plane GDL saturation and temperature profiles as a function of current density and GDL type
- current distribution and water saturation profiles along the channel, steady state water balance (anode vs. cathode)
- channel slug formation, removal frequency, and two-phase dP
- channel to manifold interactions and water accumulation and removal rates for transients and purge

Go/No-Go #2

The decision for continuing into Budget Period 3 will be based on, in part, the **component models from each partner being able to predict the experimental observations** made at all conditions in the standard protocol with the baseline and auto-competitive material sets as well as the component level models allowing for boundary conditions and output parameters to be linked together into a comprehensive down-the-channel model. This model shall predict the saturation state along the channel for both wet and dry operating conditions within the experimental uncertainty of validation data reported in year 1.

Project Timing

Program Activities		# months	GM	PSU	RIT	2010				2011				2012				2013			
						Q1	Q2	Q3	Q4	Q1	Q2	Q3	Q4	Q1	Q2	Q3	Q4	Q1	Q2	Q3	Q4
Task 1	Macro-Scale Investigation: In-Plane Fuel Cell Transport Performance	12																			
1.1	Measurement and modeling of baseline material set	6	★																		
1.2	Measurement and modeling of auto-competitive material set	9	★																		
		Go/No-Go #1																			
Task 2	Micro-Scale Investigation: Through-Plane Transport in Membrane, Electrodes and Associated Interfaces	30																			
2.1	In-situ and ex-situ measurements of baseline material set	6	●	★																	
2.2	In-situ and ex-situ measurements of auto-competitive material set	18	●	★																	
2.3	Material characterization and degradation assessment	12		★																	
2.4	Transport process modeling	30	●	★	●																
		Go/No-Go #1																			
		Go/No-Go #2																			
Task 3	Micro-Scale Investigation: Through-Plane Transport in Gas Diffusion Layer, Microporous Layer and Associated Interfaces	30																			
3.1	In-situ and ex-situ measurements of baseline material set	6	●	★																	
3.2	In-situ and ex-situ measurements of auto-competitive material set	18	●	★																	
3.3	Material characterization and degradation assessment	12		★																	
3.4	Transport process modeling	30	●	★	●																
		Go/No-Go #1																			
		Go/No-Go #2																			
Task 4	Micro-Scale Investigation: Transport in Channels, Manifolds and Associated Interfaces	30																			
4.1	In-situ and ex-situ measurements of baseline hardware design and material set	6	●		★																
4.2	In-situ and ex-situ measurements of auto-competitive hardware designs and material set	18	●		★																
4.3	Performance improvement analysis and modifications	12			★																
4.4	Transport process modeling	30	●	●	★																
		Go/No-Go #1																			
		Go/No-Go #2																			
Task 5	Comprehensive Testing and Modeling Based on Macro-Scale and Micro-Scale Studies	30																			
5.1	Comprehensive validation testing of models and interfacial behavior from Tasks 2.1, 3.1 and 4.1	6	★	●	●																
5.2	Comprehensive validation testing of models and interfacial behavior from Tasks 2.2, 3.2 and 4.2	18	★	●	●																
5.3	Recommendation on materials, design and operating conditions for optimal fuel cell transport performance	6	★	●	●																
		Go/No-Go #2																			
Task 6	Project Management	36	★	●	●																

Legend ★ Task Lead ◆ Go/No-Go Decis Go/No-Go Decision Point
 ● Task Participant ◇ Deliverable Deliverable



Pseudo-2D Down-the-Channel Model

- Assume equipotential at a bipolar plate
- Calculate current distribution along flow direction

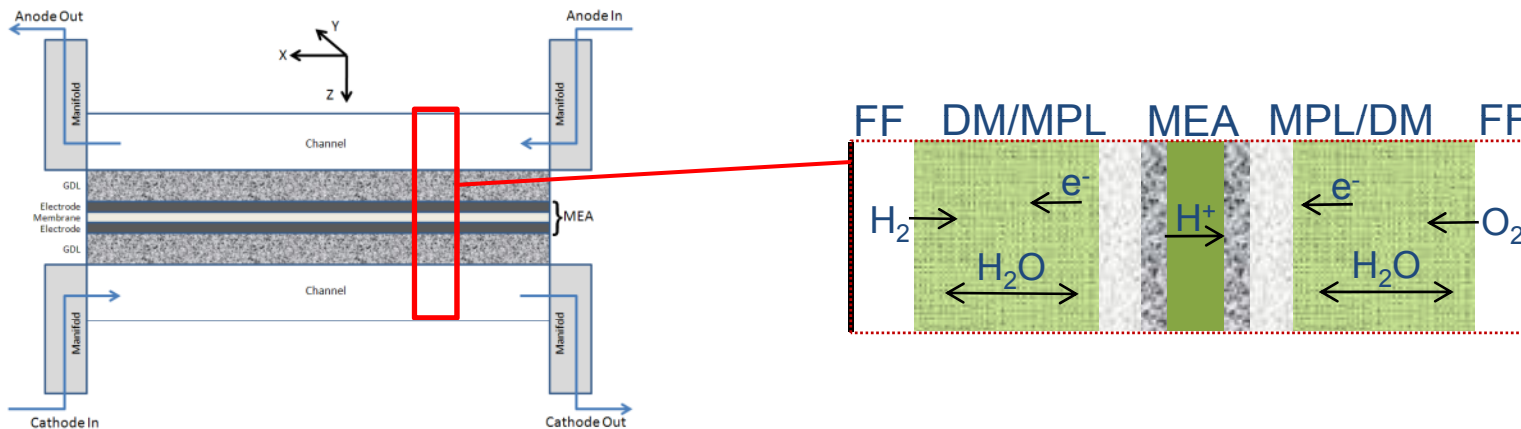

$$E_{cell} = E_{rev} - i \cdot R_{\Omega} - \eta_{HOR} - \eta_{ORR} - i \cdot (R_{H^+,cath} + R_{H^+,an}) - \eta_{tx}$$

- 1D kinetic and transport coupled cell model
 - non-isothermal water transport from anode to cathode
 - local oxygen transport resistance within cathode
- 1D down-the-channel flow model
 - single- or two-phase pressure drop in flow channel
 - transitions between active and non-active areas

Model Input Parameters

- Electrode kinetics

- Anode hydrogen oxidation reaction (HOR)
 - ✓ Neyerlin et al, *J. Electrochem. Soc.*, 154, B631 (2007)
- Cathode oxygen reduction reaction (ORR)
 - ✓ Neyerlin et al, *J. Electrochem. Soc.*, 153, A1955 (2006)

- Ohmic resistance

- Electrical resistance
- Membrane resistance as a function of RH

- Electrode resistance

- Proton conductivity of electrolyte film on catalyst surface
 - ✓ dependence of film thickness and local RH

- Reactant transport resistance

- Effective diffusivity_{of} porous components (DM, MPL and CL)
 - ✓ dependence of liquid water saturation
- Effective transport resistance in flow channel
 - ✓ dependence of gas-liquid interaction

- Heat transfer resistance

- Component thermal conductivity
 - ✓ dependence of water content



✧ Improved water transport model in the presence of liquid water

Dissemination of Results

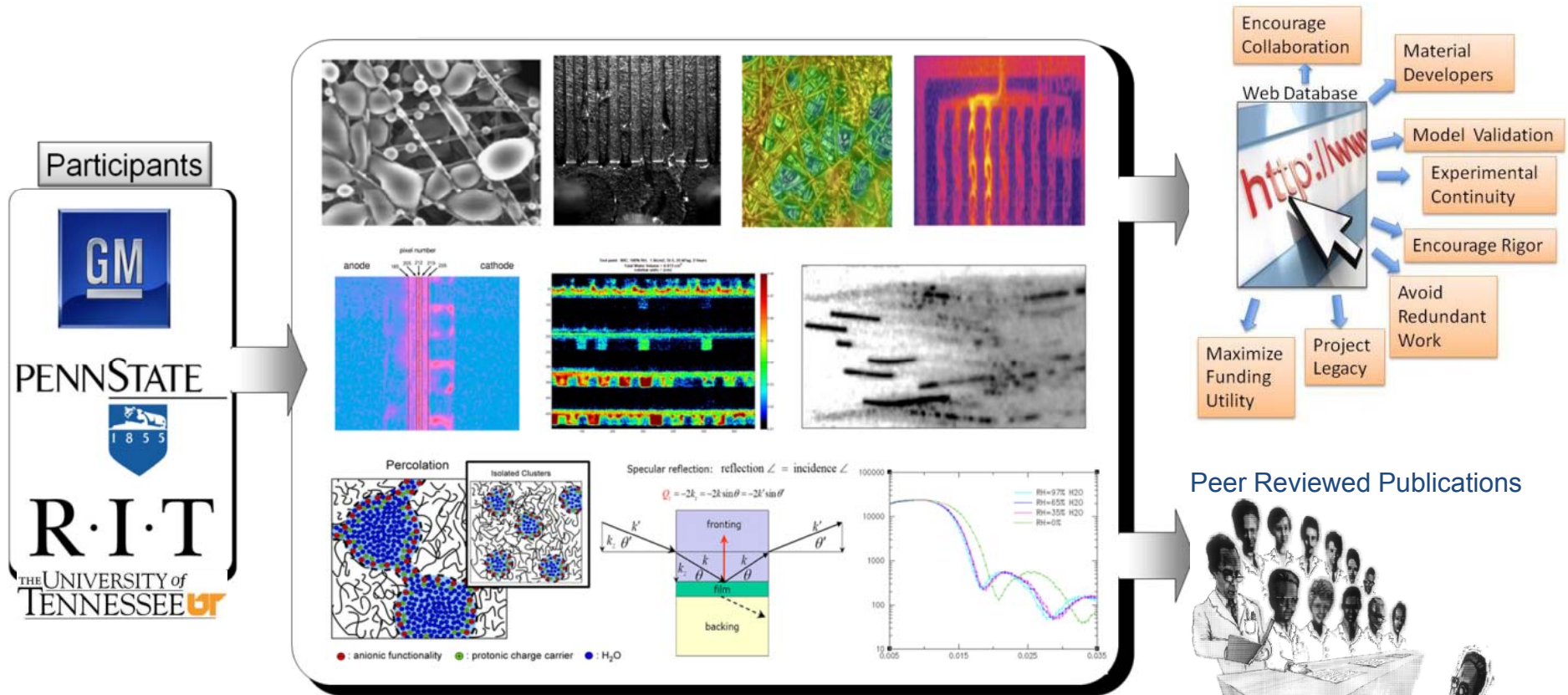

The model and validation data generated during the course of this project will have complete transparency through the project website, peer reviewed publications and conference presentations. We anticipate our database will be sufficient for validating any multi-dimensional fuel cell model.



Task 1 Key Activities

J.P. Owejan, J.J. Gagliardo, W. Gu

- Define standard protocols
- Generate down-the-channel validation data for Baseline and Auto-competitive material sets.
- Develop web database for dissemination of results.
- Initial evaluation of single phase model to identify key transport parameters needed.



Task 1. Macro-Scale Investigation: In-Plane Fuel Cell Transport Performance

Down-the-Channel Transport Performance of Fully Integrated Cell Under Wet and Dry Conditions

Key questions: Can a comprehensive data set for a wide operating space be generated in the 2-D active area plane with discrete measurements of water, current, ohmic resistance, and temperature?

Techniques employed:

- High temporal resolution neutron imaging
- Modular PCB plate design for distributed 2-D current, HFR, and temperature data
- State-of-the-art and calibrated in-situ fuel cell measurements and control
- Ex-situ electrochemical and material characterization

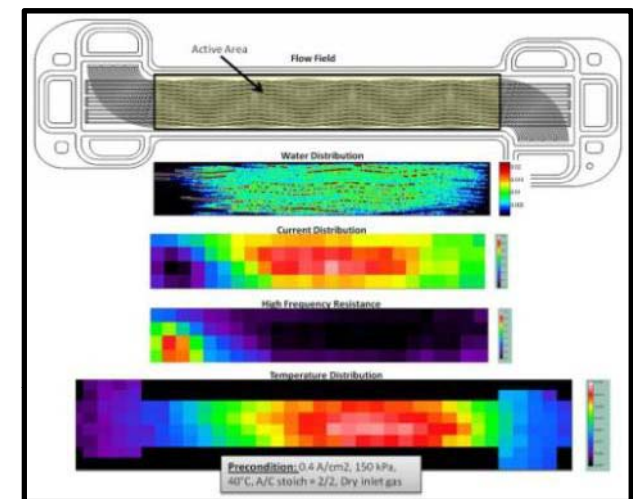
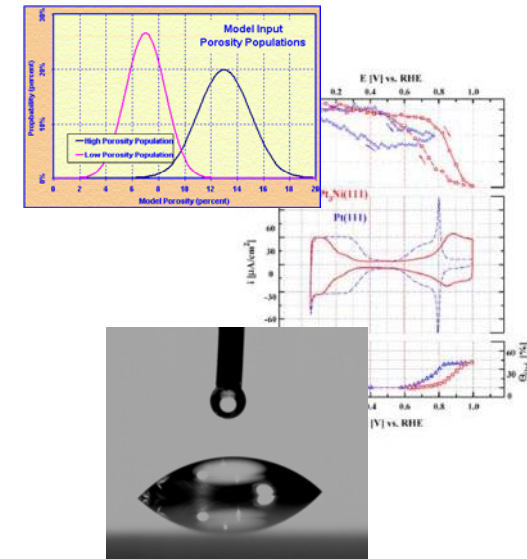



Task 1 (GM) Macro-Scale Investigation: In-Plane Fuel Cell Transport Performance

- 9/28/10
- Baseline material set DTC validation data (2010 Q4)
 - Current and temperature distributions for standard protocol.
 - 10% complete, GM and NIST test stand temperature control upgraded for liquid coolant. Currently calibrating dT based on coolant flow and current density. Standard protocol currently being debugged. Baseline material set ordered.
 - Water distributions for standard protocol
 - 0% complete, will follow GM testing.
 - Upload data to project database
 - 0% complete, evaluating best development path.
- Auto-competitive material set DTC validation data (2011 Q2)
 - Current and temperature distributions for standard protocol.
 - % complete, status
 - Water distributions for standard protocol
 - % complete, status
 - Upload data to project database
 - % complete, status

Task 2 Key Activities

M.A. Hickner

- Investigate fundamental transport phenomena at the micro-scale in the MEA and develop material property models and constitutive relationships that can be interfaced with GM's pseudo-2D fuel cell performance model.
- Characterize the “baseline” material set.
- Characterize “auto-competitive” material set and compare to baseline.
- Focus on mass (water, oxygen) and ionic transport properties of thin films in catalyst layer.

Task 2. Micro-Scale Investigation: Through-Plane Transport in Membrane, Electrodes and Associated Interfaces

Transport Properties and Modeling of Thin Ionic Films

Key questions: How do thin ionomer film properties compare to bulk samples and how can we describe the properties of the ionomer films in the catalyst layer in fuel cell performance models?

Techniques employed:

- Small-angle neutron scattering, atomic force microscopy (ionic morphology)
- Neutron reflectometry (substrate interactions)
- Spectroscopic ellipsometry (swelling, diffusion)
- Vibrational spectroscopy - IR, Raman (degradation)
- Thin film conductivity (ion transport)

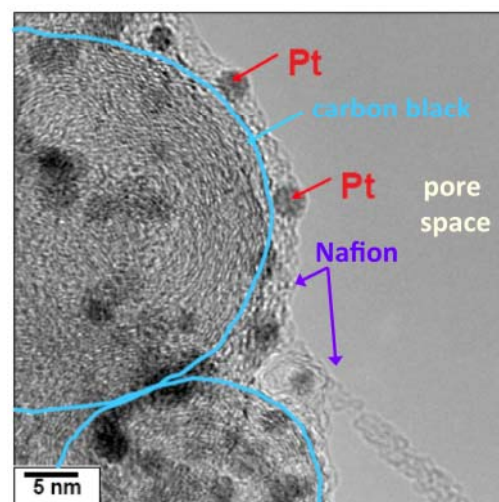

KL More, DOE Report 2005.

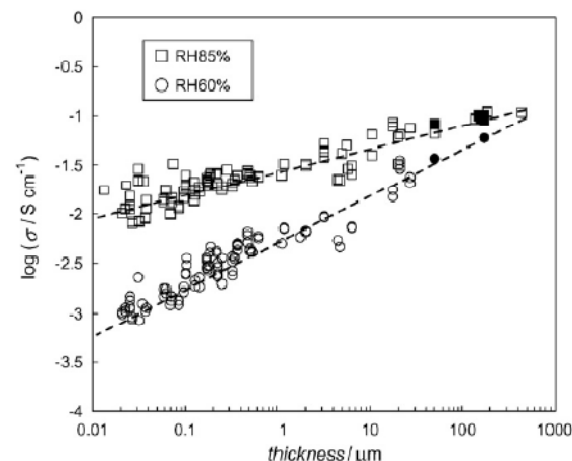

K Yasuda, et al. *J. Power Sources* 2009.

Thin Film Morphology and Swelling

RH and T controlled ellipsometry for controlled swelling experiments

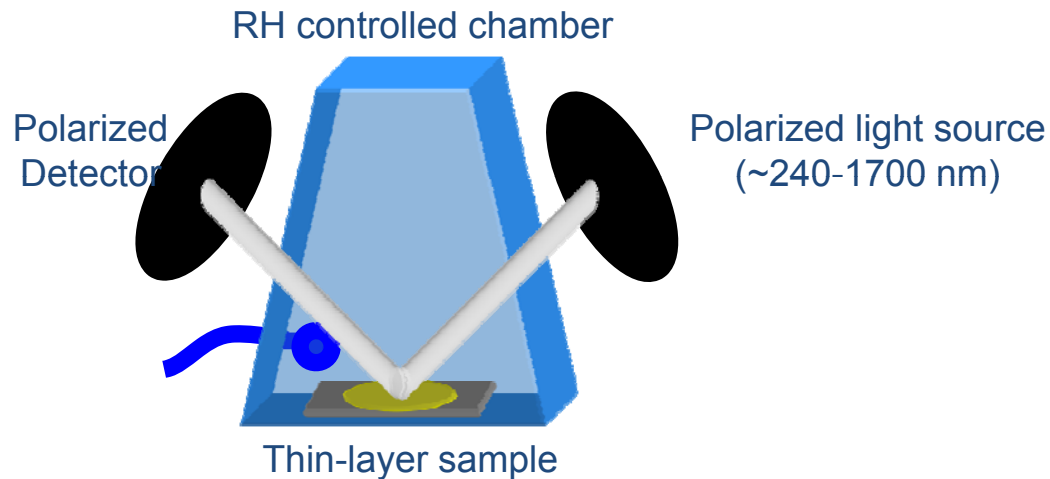

AFM measurements of polymer morphology to determine transport domain connectivity

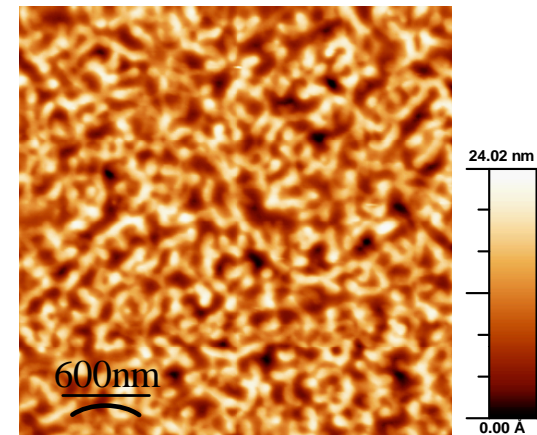

Cross-section of a thin ionomer film sample on a substrate

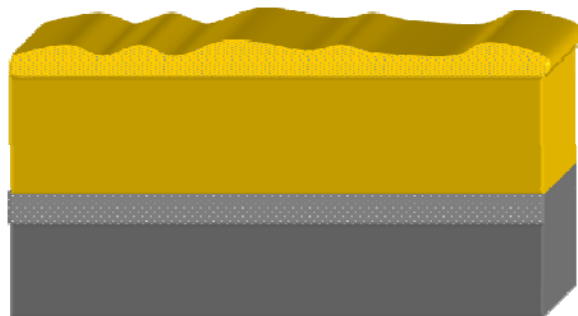

Surface Roughness < 1 nm
Ionomer Film
Surface treatment
Substrate

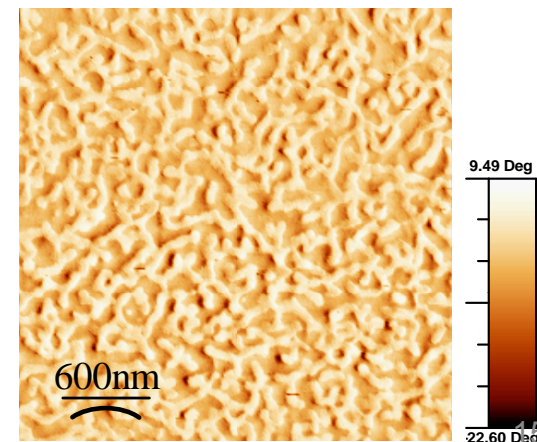

Thin vs. Thick Films on Different Substrate Treatments

Thin films ~ 25 nm

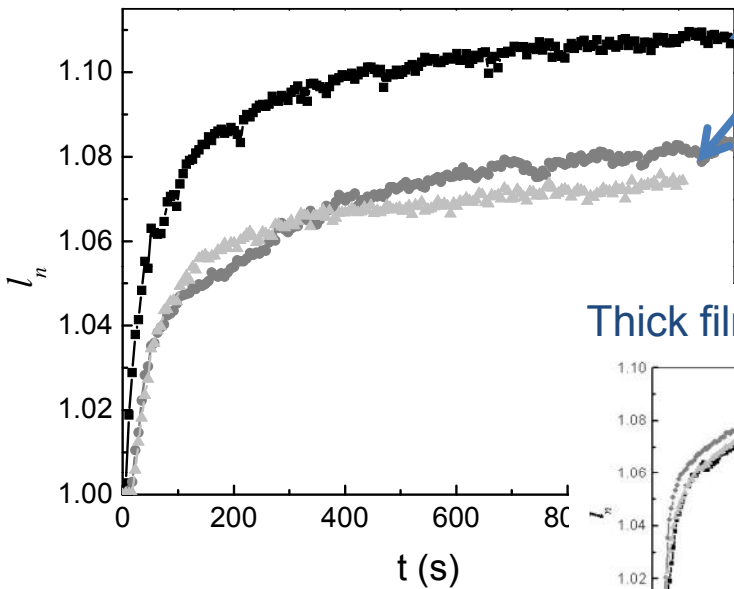

For the 50-75 % RH step thin films swell a greater percent of their original thickness, especially on HMDS.

Not a large difference in thick film behavior.

Thick films ~ 350 nm

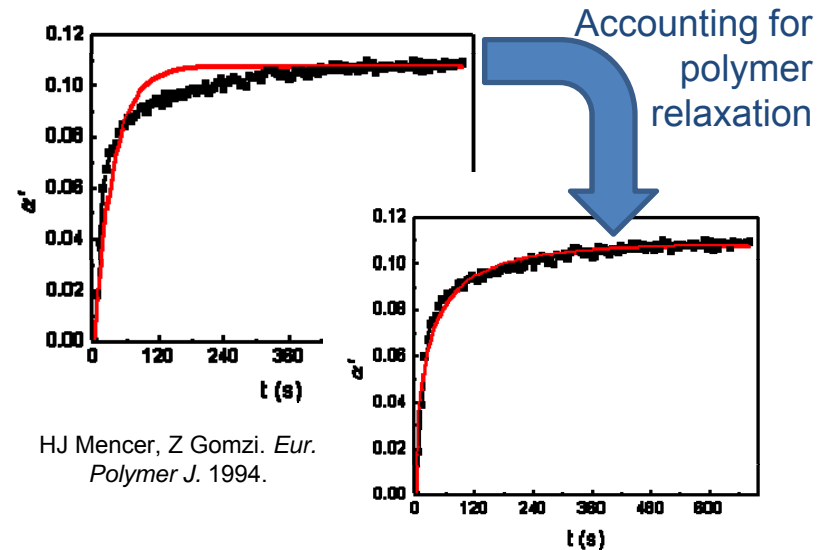
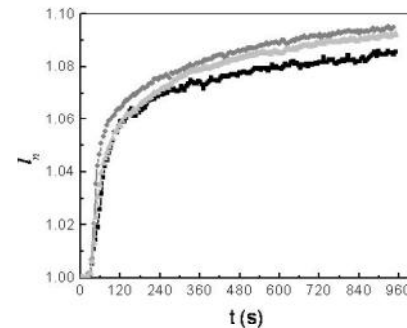

HJ Mencer, Z Gomzi. *Eur. Polymer J.* 1994.

Substrate treatments

- HMDS
- Bare
- ▲ APTMS

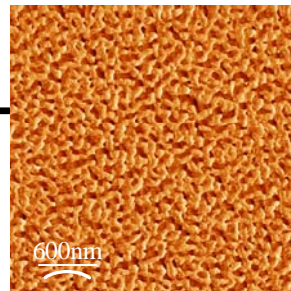
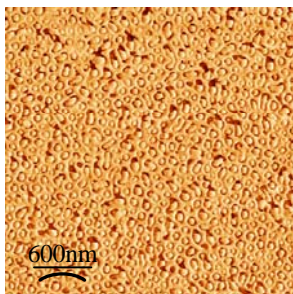

Modeling the swelling rate of thin films: need to account for polymer relaxation

This relaxation process is one mechanism by which thin film properties are different than bulk films.

Task 2 (PSU) Micro-Scale Investigation: Through-Plane Transport in Membrane, Electrodes and Associated Interfaces

- Date
- Baseline material set characterization (2010 Q4)
 - Membrane water uptake, water diffusivity and hydraulic permeability
 - % complete, status
 - Oxygen and water transport as a function of ionomer layer thickness
 - % complete, status
 - Degradation parameters and rates
 - % complete, status
 - Upload data to project database
 - % complete, status
- Auto-competitive material set candidate characterization (2012 Q2)
 - Membrane water uptake, water diffusivity and hydraulic permeability
 - % complete, status
 - Catalyst layer liquid water pressure as a function of saturation, pore size, and hydrophobicity
 - % complete, status
 - Oxygen and water transport as a function of ionomer layer thickness
 - % complete, status
 - Degradation parameters and rates
 - % complete, status
 - Upload data to project database
 - % complete, status
- Component model development (2012 Q4)
 - Fundamental component model development (GM leading this subtask)
 - % complete, status
 - Output transport resistances for MEA into DTC model
 - % complete, status
 - Upload component model and derivation of transport resistances to project database
 - % complete, status

Task 3 Key Activities

M.M. Mench

- Investigate fundamental transport phenomena in the porous media and interfaces to develop understanding, models and constitutive relationships that can be integrated and interfaced in GM's pseudo-2D fuel cell performance model.
- Characterize heat and mass transport in baseline and auto-competitive material virgin and degraded material sets to provide detailed validation data for community.
- New diagnostics of acoustic microscopy and the use of contrasting agents will be evaluated as a new diagnostic tool to enhance in situ interfacial visualization.

Task 3. Micro-Scale Investigation: Through-Plane Transport in Gas Diffusion Layer, Microporous Layer and Associated Interfaces

Transport Properties and Modeling of Porous Layers

Key questions: How to incorporate impact of phase change in porous layers and associated interfaces on heat and mass transfer? How can directionally opposed modes of transport be leveraged in practical fuel cell systems?

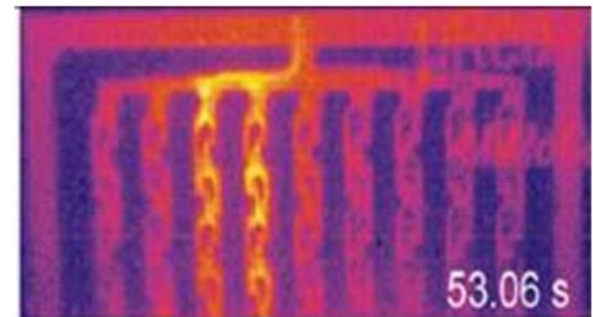

Techniques employed:

- Modular PCB plate design for distributed 2-D current and HFR data.
- Neutron Imaging compatible in plane and through plane.
- Embedded RTD devices for 2-D temperature data.
- Coolant bath temperature control with D2O for NR imaging.
- IR camera access through compatible windows
- Full detailed experimental evaluation of various polarization losses
- Other ex situ and in situ measurements to be employed

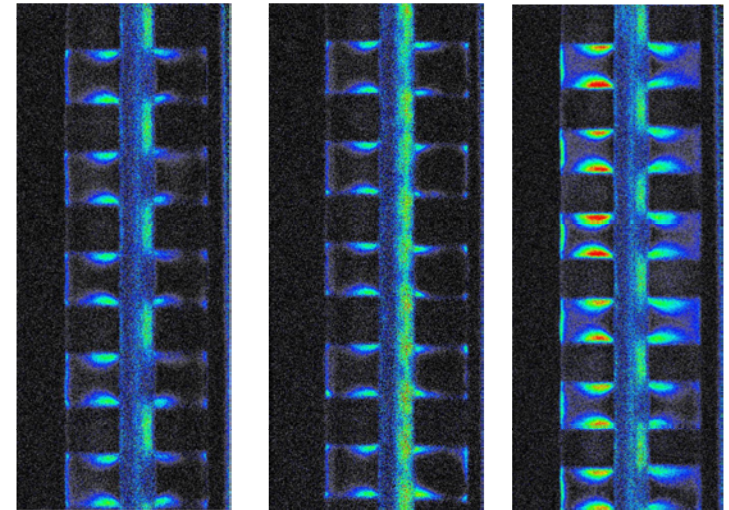

Diagnostic Approach

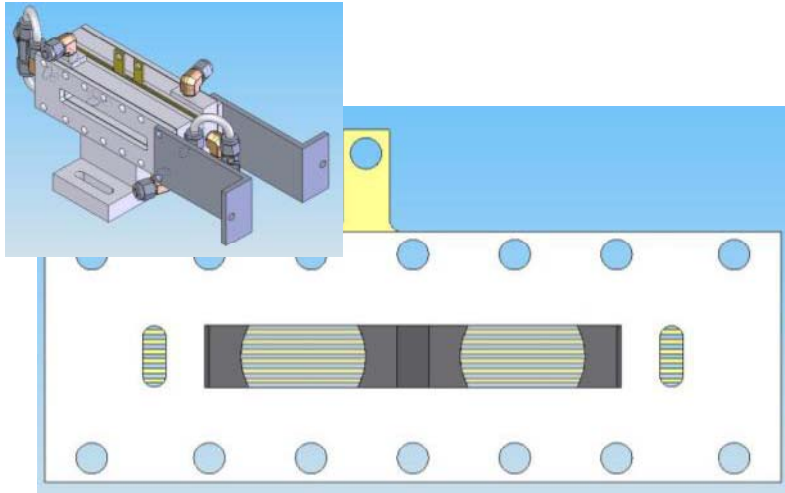

Sapphire windows for IR measurement
New design will be through plane

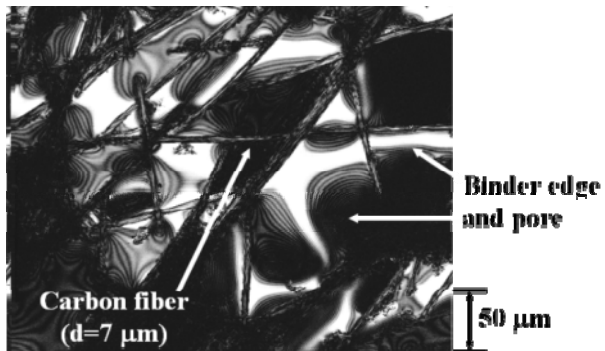

Acoustic microscopy and use of contrasting agents will be explored

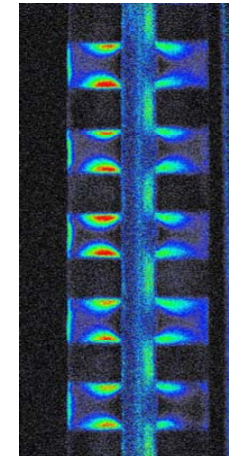
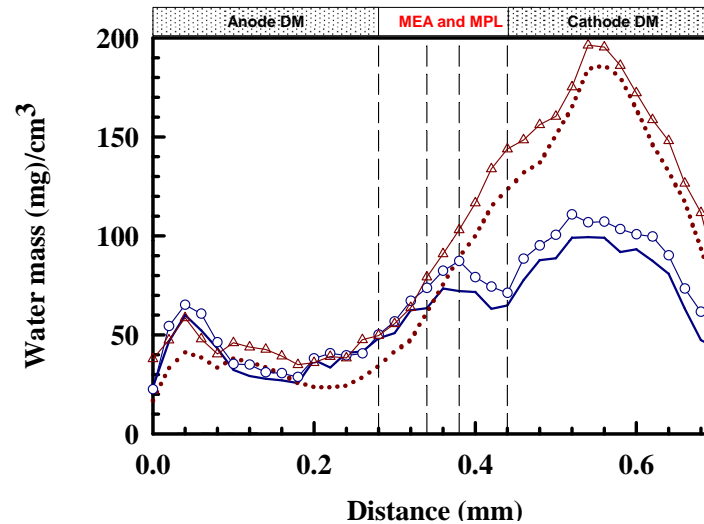

Through-plane high resolution quantified neutron imaging

Modeling Approach:

1. Multi-phase model with advanced capillary and temperature gradient driven flow measured relationships in membrane and porous media.
2. Scanned and reduced virtual CL|MPL interface effects.
3. Updated electrode model with oxide coverage and film impedance.
4. Provide transport resistances to GM's along the channel model

Task 3 (UTK) Micro-Scale Investigation: Through-Plane Transport in Gas Diffusion Layer, Microporous Layer and Associated Interfaces

- Date
- Baseline material set characterization (2010 Q4)
 - MPL thermal conductivity and D/D_{eff}
 - % complete, status
 - Catalyst layer liquid water pressure as a function of saturation, pore size, and hydrophobicity
 - % complete, status
 - CFP thermal conductivity (wet and dry) and D/D_{eff} as a function of saturation
 - % complete, status
 - Through-plane saturation and wet region boundary as a function of dT and operating temp.
 - % complete, status
 - Degradation parameters and rates
 - % complete, status
 - Upload data to project database
 - % complete, status
- Auto-competitive material set candidate characterization (2012 Q2)
 - MPL thermal conductivity and D/D_{eff}
 - % complete, status
 - CFP thermal conductivity (wet and dry) and D/D_{eff} as a function of saturation
 - % complete, status
 - Through-plane saturation and wet region boundary as a function of dT and operating temp.
 - % complete, status
 - Degradation parameters and rates
 - % complete, status
 - Upload data to project database
 - % complete, status
- Component model development (2012 Q4)
 - Fundamental component model development
 - % complete, status
 - Output water transport resistance in wet region of CFP
 - % complete, status
 - Upload component model and derivation of transport resistance to project database
 - % complete, status



Task 4 Key Activities

S.G. Kandlikar, T.A. Trabold

- Investigate fundamental transport phenomena at the microscale at (a) GDL-channel interface; (b) within anode and cathode flow field channels; and (c) channel-manifold interface
- Construct component-level models that can be interfaced with GM's pseudo-2D down-the-channel fuel cell performance model.
- Characterize the “baseline” material set performance.
- Characterize “auto-competitive” material set performance and design features, and compare to baseline.
- Evaluate water and temperature distributions at critical interfaces, and their impact on air and hydrogen flow distributions.



Task 4. Micro-Scale Investigation: Transport in Channels, Manifolds and Associated Interfaces

S.G. Kandlikar, T.A. Trabold
Rochester Institute of Technology

Key questions: What parameters are required to capture the impact of GDL-to-flow field and channel-to-manifold properties on transport resistance in the channels? How does the down-the-channel condition correlate to transport resistance in the channel?

Techniques employed:

- High-speed optical imaging
- Infrared imaging and thermometry
- High spatial resolution neutron imaging
- Flow dynamics measurement

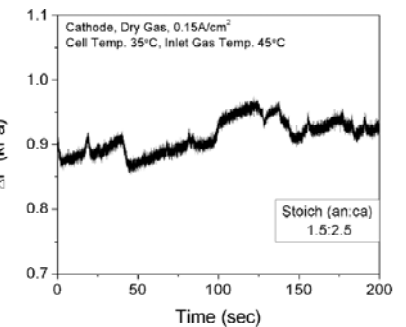
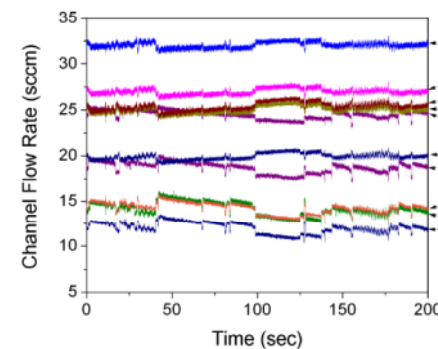
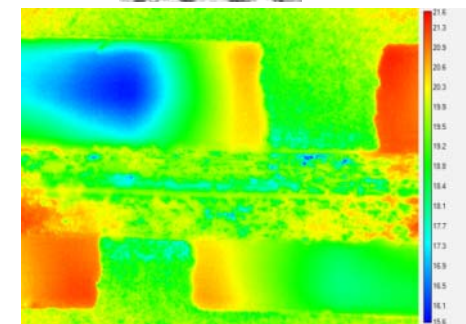
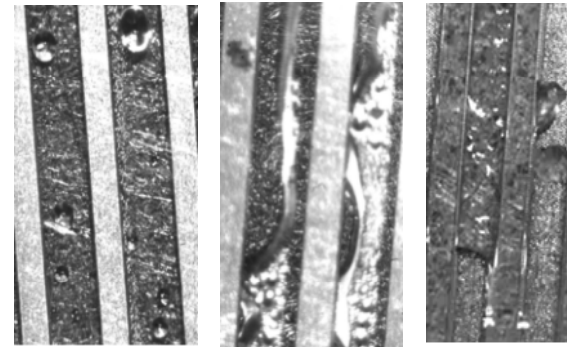



Task 4 (RIT) Micro-Scale Investigation: Transport in Channels, Manifolds and Associated Interfaces

- Date
- Baseline material set characterization (2010 Q4)
 - CFP to channel interfacial transport resistance as a function of channel saturation
 - % complete, status
 - Channel dP as a function of saturation, temperature, flow, and current density
 - % complete, status
 - Manifold dP as a function of saturation, temperature, flow, and current density
 - % complete, status
 - Upload data to project database
 - % complete, status
- Auto-competitive material set candidate characterization (2012 Q2)
 - CFP to channel interfacial transport resistance as a function of channel saturation
 - % complete, status
 - Channel dP as a function of saturation, geometry, temperature, flow, and current density
 - % complete, status
 - Manifold dP as a function of saturation, temperature, flow, and current density
 - % complete, status
 - Performance improvement analysis and modifications
 - % complete, status
 - Upload data to project database
 - % complete, status
- Component model development (2012 Q4)
 - Fundamental component model development
 - % complete, status
 - Output water transport resistances from CFP to channel and in the channel
 - % complete, status
 - Upload component model and derivation of transport resistances to project database
 - % complete, status



Task 5. Comprehensive Modeling and Validation Based on Macro-Scale and Micro-Scale Studies

W. Gu, J.P. Owejan, J.J. Gagliardo, T.A. Trabold

Integrate and Validate Component Transport Models

Key questions: Can the model predict the saturation state along the channel and the overall water balance for both wet and dry operating conditions within the experimental uncertainty of the validation data?

Techniques employed:

- Optimized numerical methods
- Integrating component models by synthesizing data from the 3 distinct experimental tasks (Tasks 2 – 4) and condensing this information obtained at different length scales
- Refined user interface and input method for model
- Direct comparison of model output to experimental data
- Organized statistical study

Collaborations

Currently investigating several collaborations within the DOE
Fuel Cell Program



Summary

- Characterization of key parameters in baseline and auto-competitive material sets
- Generate comprehensive validation data set
- Comprehensive component studies that identify key transport parameters
- Develop and validate component level models that output bulk and interfacial transport resistances
- Integrate component model outputs into a two-phase down-the-channel 1 + 1-D model
- Compare down-the-channel model prediction with comprehensive database
- Publish all data and method descriptions on a publically available project website

