

Environmental Assessment for Commercialization of the Mound Plant

RECEIVED
DEC 27 1994
OSTI



Prepared By:

The U.S. Department of Energy
Miamisburg Area Office

October 26, 1994

MASTER

DISTRIBUTION OF THIS DOCUMENT IS UNLIMITED

DISTRIBUTION OF THIS DOCUMENT IS UNLIMITED ^{DT}

DISCLAIMER

This report was prepared as an account of work sponsored by an agency of the United States Government. Neither the United States Government nor any agency thereof, nor any of their employees, make any warranty, express or implied, or assumes any legal liability or responsibility for the accuracy, completeness, or usefulness of any information, apparatus, product, or process disclosed, or represents that its use would not infringe privately owned rights. Reference herein to any specific commercial product, process, or service by trade name, trademark, manufacturer, or otherwise does not necessarily constitute or imply its endorsement, recommendation, or favoring by the United States Government or any agency thereof. The views and opinions of authors expressed herein do not necessarily state or reflect those of the United States Government or any agency thereof.

DISCLAIMER

Portions of this document may be illegible in electronic image products. Images are produced from the best available original document.

Table of Contents

| | |
|---|-----------|
| 1. PURPOSE AND NEED FOR AGENCY ACTION | 1 |
| 2. PROPOSED ACTION AND ALTERNATIVES | 3 |
| 2.1 PROPOSED ACTION - MIXED-USE COMMERCIALIZATION OF THE MOUND PLANT | 3 |
| 2.2 ALTERNATIVE 1 - COMMERCIALIZATION RESTRICTED TO EXISTING PLANT CAPABILITIES AND USES | 8 |
| 2.3 NO ACTION ALTERNATIVE | 8 |
| 2.4 ALTERNATIVES CONSIDERED BUT DISMISSED AS UNREASONABLE..... | 9 |
| 3. AFFECTED ENVIRONMENT AND ENVIRONMENTAL CONSEQUENCES OF THE PROPOSED ACTION AND ALTERNATIVES | 10 |
| 3.1 ENVIRONMENTAL RESTORATION..... | 19 |
| 3.2 SOCIOECONOMICS | 21 |
| 3.3 AIR EMISSIONS | 23 |
| 3.3.1 <i>Non radiological Air Emissions</i> | 23 |
| 3.3.2 <i>Radiological Air Emissions</i> | 28 |
| 3.4 EFFLUENT DISCHARGES | 30 |
| 3.4.1 <i>Non radiological Discharges</i> | 30 |
| 3.4.2 <i>Radiological Liquid Effluents</i> | 32 |
| 3.5 WASTE MANAGEMENT CAPACITY | 34 |
| 3.6 WATERS | 40 |
| 3.6.1 <i>Water Demand</i> | 40 |
| 3.6.2 <i>Groundwater</i> | 41 |
| 3.7 THREATENED AND ENDANGERED SPECIES | 43 |
| 3.8 ACCIDENT ANALYSIS | 43 |
| 3.8.1 <i>Inadvertent Ignition of 10 lbs of High Explosive in Building 27</i> | 44 |
| 3.8.2 <i>Inadvertent Ignition of Thermite Powder During Machining Operations</i> | 44 |
| 3.8.3 <i>Spill Lab Quantity (1 gallon) of Concentrated Acid in the Environmental Analysis Lab</i> | 45 |
| 4. AGENCIES, ORGANIZATIONS, AND PERSONS CONSULTED | 46 |
| 5.0 REFERENCES | 47 |
| 6.0 LIST OF ACRONYMS AND ABBREVIATIONS | 48 |
| 7.0 GLOSSARY | 51 |

APPENDICES

- Appendix A: Lease Exhibit and Ohio EPA Concurrence Letter**
- Appendix B: Letters of Correspondence with Federal, State and Local Agencies**
- Appendix C: NPDES Permit Requirements for the Mound Plant (1993); Organic Compounds Detected in Mound Effluent**
- Appendix D: Reference Tables from Nonnuclear Consolidation Environmental Assessment**
- Appendix E: Conformity Analysis Data and Calculations**

List of Figures

| | |
|---|-----------|
| Figure 2-1: Mound Plant Site..... | 4 |
| Figure 2-2: Economic Development Roles & Responsibilities..... | 6 |
| Figure 3-1: Southwestern Ohio And Location Of Mound Plant..... | 12 |
| Figure 3-2: Site Map With Facility Locations | 14 |
| Figure 3-3: Location Of Mound Operable Units..... | 20 |
| Figure 3-4: NPDES Sampling Locations..... | 31 |

List of Tables

| | |
|---|-----------|
| Table 3-1: Mound Plant Building Summary | 15 |
| Table 3-2: Criteria Pollutant Emissions for the Mound Plant for 1993..... | 24 |
| Table 3-3: Hazardous Air Pollutants (HAP's) for the Mound Plant in 1993 | 25 |
| Table 3-4: Mound Plant Radiological Air Emissions in 1993 | 28 |
| Table 3-5: Mound Plant Radiological Effluents in 1993 | 33 |
| Table 3-6: 1993 Waste Generation at Mound | 35 |
| Table 3-7: Low-Level Waste Facilities at Mound | 36 |
| Table 3-8: Mound Plant Low-Level Mixed Waste Types and Quantities in Storage..... | 37 |
| Table 3-9: Mound Plant Hazardous/Toxic Waste Nature and Handling Procedures | 38 |
| Table 3-10: Mound Plant Hazardous Waste Storage and Treatment Facilities | 39 |
| Table 3-11: Radionuclide Concentrations in Mound Production Wells (1993) | 42 |
| Table 3-12: Volatile Organic Compound Concentrations in Mound Production Wells (1993)..... | 42 |

FINDING OF NO SIGNIFICANT IMPACT
COMMERCIALIZATION OF THE MOUND PLANT
MIAMISBURG, OHIO

Proposed Action: On November 22, 1993, the U.S. Department of Energy decided to phase out operations at the Mound Plant in Miamisburg, Ohio, with the goal of releasing the site for commercial use. The goal of the Secretary of Energy's Economic Development Initiative is to make Departmental resources available to community partnerships for local business development that supports the President's broader objective of stimulating economic growth. To facilitate implementation of the Secretary's Economic Development Initiative, the Mound Reuse Committee (MRC) was formed. The MRC is the recognized Community Reuse Organization (CRO), and represents a broad cross-section of Mound Plant stakeholders, including the general public, local citizens action groups, State environmental regulatory personnel, local industries, the City of Miamisburg and Mound Plant employees. One objective of the MRC is to redirect the Mound Plant's advanced manufacturing capabilities for defense production to the private sector. The broad concept is to transform the plant into an advanced manufacturing center with the main focus on commercializing products, process development, and identifying other firms interested in commercializing products and other technology.

The Department proposes, therefore, to lease portions of the Mound Plant to commercial enterprises, excluding land associated with the south property. Leasing would be between the Department and a lessee including, but not limited to, Miamisburg Mound Community Improvement Corporation (MMCIC) as the distinct private entity to coordinate administrative

function for the City of Miamisburg. The MMCIC would, in turn, administer its lease with the Department and sublet parcels of the Plant to other potential business enterprises for commercial uses consistent with the "Mound Plant Future Use Plan" and the environmental assessment for the proposed action. Although the MMCIC is a private entity which would act on behalf of the City of Miamisburg, it would operate within the confines of MRC recommendations. The MMCIC would also present any proposals from potential sublessees to the Department for approval before any subleases would take effect.

The Future Use Plan presents a combination of uses, similar to ongoing activities, processes, and operations new to the Plant that would represent a governmental presence and a private industry technology partnership to enable the Plant to become a high technology, self-sustaining manufacturing mall with one or more anchor tenants that would attract other tenants to the facility. Potential operations could be similar to those analyzed in the Mound Plant Alternative described in the June 1993 Nonnuclear Consolidation Environmental Assessment, D'OE/EA-0792. In addition to the ongoing activities at the Mound Plant, that alternative considered consolidation of the nonnuclear functions at the Plant from other Departmental sites to include: 1) nonnuclear electrical/mechanical manufacturing functions from the Kansas City, Pinellas, and Rocky Flats Plants, 2) lithium ambient batteries from Los Alamos National Laboratory, and 3) special products, such as nuclear grade steels, safe secure trailers, weapons trainer shop, and metrology capabilities from the Rocky Flats Plant. Leases or subleases for any uses not similar to those outlined above are outside the scope of the proposed action and would be subject to additional National Environmental Policy Act review before the Department's approval of the lease or sublease. Any new construction at the Plant (except for equipment and plant layout rearrangements, renovation activities, and other routine maintenance activities or replacements and upgrades consistent with facilitating

the conversion to commercial use) would also be outside the scope of the proposed action and subject to additional National Environmental Policy Act review.

The Department has prepared an environmental assessment (DOE/EA-1001) that compares impacts of the proposed action with those of 1) not leasing the Plant to commercial enterprises (the "no action" alternative) and 2) limiting leasing activities strictly to non-DOE enterprises that are purely administrative or engage in essentially similar activities in scope and scale to those currently in existence at the Plant. The Department considered, but dismissed as unreasonable, the alternatives of 1) selling the Plant and all associated structures upon completion of environmental restoration activities, 2) demolishing the Plant and all associated structures upon completion of environmental restoration activities, and 3) continuing Departmental or other government-funded operations at the Plant. The first two alternatives were considered unreasonable because they would fail to provide sustained employment opportunities to the community and would result in restoration costs above those identified for the proposed action; the third alternative was considered unreasonable because it would not be consistent with the Department's decision to consolidate and streamline operations as described in the Nonnuclear Consolidation Environmental Assessment and would not support commercialization of the Mound Plant.

Environmental Impacts: The proposed action would not impact the small wetland areas that are found on the facility grounds and would not impact the groundwater in terms of usage or potential contamination. A small portion of the south property falls within the 100 year flood plain of the Great Miami River, however, the south property is outside the scope of the environmental assessment. Therefore, no impact on the floodplain would result from the proposed action. The Mound Plant site does not contain any prime or unique farmlands, and

no archaeological sites eligible for the National Register would be affected by the proposed action. Based on the analysis in the environmental assessment, the proposed action would not result in any substantive change in level of service for transportation links or in noise levels in the area of the Plant. Racial minority and low income families do reside in the Miamisburg community, however, Miamisburg is not a racial minority or low income community. The proposed action and alternatives will, therefore, not have any unique effects on these groups.

Cumulative air impacts from tenant emissions would not exceed the Threshold Limit Values (TLV) for Hazardous Air Pollutants (HAP), both in combination or for any single pollutant, as defined in the Clean Air Act, Section 112 and the Ohio Administrative Code 3745-77-01(w). Emissions of specific chemicals used in new processes may increase current emission levels for those chemicals, but increases would not be allowed to exceed applicable State regulatory standards or permitted limits through lease conditions. No net increases in radiological air emissions over existing emissions would be anticipated from the proposed action. Total radiological air emissions from the Plant in 1993 included 664 curies of tritium, 1.2×10^{-5} curies of plutonium-238, 4.0×10^{-8} curies of plutonium-239, 6.3×10^{-8} curies of uranium-233,234 and 5.7×10^{-8} curies of uranium-238. The Maximum Effective Dose Equivalent (EDE) to individuals in the population was 0.04 mrem for radioactive airborne releases. Therefore, Mound's radiological air emissions in 1993 represented 0.4% of the Environmental Protection Agency (EPA) dose standard of 10 mrem. All leases and subleases would contain restrictive lease conditions to ensure no new radionuclides would be introduced to the site and that potential tenants' air impacts would not exceed the baseline estimates provided in the environmental assessment.

Under conditions of the lease, nonradiological effluent discharges from the proposed action would be limited to levels currently permitted under the discharge standards, as established by the Mound Plant's National Pollutant Discharge Elimination System (NPDES) permit. If the proposed processes are substantially different than ongoing operations, the current wastewater permit may require modification. However, impacts would be not greater than increased stormwater runoff of up to 132 million gallons per year of additional wastewater as stated in the Nonnuclear Consolidation Environmental Assessment. Release levels of radiological liquid effluents would remain at or below current levels (2.5 x 10⁻⁴ curies of plutonium-238, 3.4 curies of tritium, 3.5 x 10⁻⁴ curies of uranium-233,234 and 8.9 x 10⁻⁶ curies of plutonium-239 in 1993). All leases and subleases would contain restrictive lease conditions to ensure compliance with regulatory requirements and to ensure that the proposed uses are within the bounds of the environmental assessment.

Commercial enterprises that lease space at the Plant would be bound through lease agreements to conduct their waste management operations independent of Mound's Hazardous Waste Operating Permit, however, an effort would be made to bring in processes with wastestreams that are compatible with the current permit. Regardless, tenant operations would not exceed the total volumes of waste generated at Mound shown in Table 3-6 of the environmental assessment. The proposed action would allow for employment at the facility of up to 1,500 workers in addition to the anticipated 1,100 workers for ongoing operations associated with environmental restoration and Nuclear Energy Radioisotopic Thermoelectric Generator (RTG) missions.

Environmental impacts from the no action alternative would be limited to those from ongoing environmental restoration activities and Nuclear Energy RTG missions. The no action alternative would retain 900 workers for environmental restoration and 200 workers for ongoing RTG missions at the Plant.

The alternative of limiting leasing activities strictly to non-DOE enterprises which are purely administrative or engage in essentially similar activities in scope and scale to those currently in existence at the Plant would not introduce any new environmental impacts from the established Mound Plant baseline. This alternative would generate an additional 200 workers at the Plant.

For further information contact: For further information on the proposed action (including a copy of the environmental assessment) or the National Environmental Policy Act review program concerning proposals at the Mound Plant, please contact:

Sue Smiley, NEPA Compliance Officer
Ohio Field Office
U.S. Department of Energy
P.O. Box 3020
Miamisburg, Ohio 45343-3020
(513) 865-3987

For general information on the Department's National Environmental Policy Act process, please contact:

Carol M. Borgstrom, Director
Office of NEPA Oversight, EH-25
U.S. Department of Energy
1000 Independence Avenue, SW
Washington, DC 20585
(202)586-4600 or (800)472-2756

Finding: Based on the analysis of impacts in the environmental assessment, the proposed action to lease all or portions of the Mound Plant to commercial enterprises for sublease to other potential business enterprises for commercial uses consistent with the "Mound Plant Future Use Plan" and the environmental assessment for the proposed action would not significantly affect the quality of the human environment within the meaning of the National Environmental Policy Act, 42 U.S.C. 4321, et seq. Therefore, the Department is issuing this finding of no significant impact and an environmental impact statement is not required.

Signed in Miamisburg, Ohio this 27th day of October, 1994.

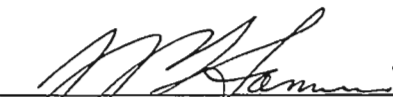

J. Phil Hamric
Manager, Ohio Field Office

1. Purpose and Need for Agency Action

On September 14, 1993, the U.S. Department of Energy (DOE) issued the Finding of No Significant Impact (FONSI) on the Proposed Action to consolidate certain nonnuclear component manufacturing operations of the Nation's Nuclear Weapons Complex. The direct consequences of the Proposed Action presented in the Nonnuclear Consolidation Environmental Assessment (EA) is the close-out of Nuclear Weapons Complex defense missions at the Mound Plant (Ref 1 and 2). DOE decided on December 23, 1991 to phase out the Mound Plant and transition the Plant to the Office of Environmental Restoration and Waste Management (EM) , with the goal of releasing the site for commercial use (Ref 2).

The DOE Miamisburg Area Office (MB) seeks to fulfill the Secretary's Economic Development Initiative to commercialize surplus facilities such as the Mound Plant. The goal of the Secretary's Economic Development Initiative is to make DOE resources available to community partnerships for local business development that supports the President's broader objective of stimulated economic growth, (Ref 3 and Ref 4). This Economic Development Initiative established clear objectives concerning future use of surplus DOE Facilities. DOE/MB's strategy for implementing the Secretary's initiative identified the following key objectives:

- 1) To mitigate the potential adverse impacts resulting from displacement of Mound Plant employees and subcontractors.
- 2) To minimize the impact of defense downsizing on the local economy.
- 3) To transfer technologies that have been developed at the Mound Plant to the private sector.
- 4) To utilize the plant facilities for constructive purposes to retain the value of DOE's investment.

To address this situation, the local Miamisburg communities and community organizations formed the Mound Reuse Committee (MRC), which now includes representation from all stakeholders, including public, private, and employee interests. This organization is the recognized Community Reuse Organization (CRO) and focuses on defining the common concerns of the members. An additional stakeholder organization represented by a partnership of the City of Miamisburg, Department of Energy (DOE), and EG&G Mound Applied Technologies formulated a unified plan of action to address concerns through the development of the "Mound Plant Future Use Plan," dated December 21, 1993 (Ref. 5). Both organizations identified the Miamisburg Mound Community Improvement Corporation (MMCIC) as the distinct private entity to coordinate administrative function for the City of Miamisburg while implementing the Future Use Plan. The Plan identifies the challenges, needs, and opportunities associated with closing out the defense mission at the plant and describes a comprehensive strategy designed to mitigate the impact of plant closure on the community. The Plan allows the facility to preserve the economic viability of the communities who contributed to the DOE's Nuclear Weapons Program. Mound has a unique history of accomplishment and diversity that set it apart as a scientific organization. It was not just a production site, but rather a research and development site that was integrated with component production (Ref 6). The DOE recognizes that the true value of the facility is not limited to site property and its physical structure, but resides in the personnel, their technology-based skills and experience, and the quality of the equipment and products that have been developed at the Mound Plant.

One objective of the MRC is to redirect the facility's advanced manufacturing capabilities for defense production to the private sector. The broad concept is to transform the Mound Plant into an advanced manufacturing center with the main focus on commercializing products, process development, and identifying other firms interested in commercializing products such as flexible printed circuits, explosive components, ceramic components, and other technology such as nondestructive evaluation and analysis of materials. (Ref. 5).

2. Proposed Action and Alternatives

2.1 Proposed Action - Mixed-Use Commercialization of the Mound Plant

The Proposed Action is to lease portions of the Mound Plant to commercial enterprises, excluding land associated with the south property (see Figure 2-1 for location of the south property) since it may be sold rather than leased. Leasing would be between the DOE and a lessee including, but not limited to, MMCIC. MMCIC would, in turn, administer its lease with DOE, and sublet parcels of the plant to other potential business enterprises for commercial uses consistent with the "Mound Plant Future Use Plan." MMCIC would present any proposals from potential subleases to DOE for approval in accordance with DOE/OFO Economic Development, OH-5.5.01 prior to any subleases taking effect. Key elements of the Mound Commercialization effort include, but are not limited to, the following goals:

- Maintain core instrumentation and equipment resources during the transition period. The transition would be implemented in several phases over a period of five years. This would allow the Mound Plant to continue to contribute to the nation's leadership role in high technology in the future.
- Attract one or more technology-based anchor tenants to provide immediate job opportunities for displaced workers, and to provide additional revenue to help support overhead costs associated with the Mound Plant transition.
- Develop Small Business Incubator tenants to foster the growth of small and medium sized entrepreneurial technology-based businesses.

The Future Use Plan presents a combination of uses similar to ongoing activities, processes, and operations new to the plant that would represent a governmental presence and a vibrant private industry technology partnership, working in concert to promote energy, environment, manufacturing, science and technological competitiveness for the commercial marketplace (Ref. 5). Proposed uses may also include the continued manufacturing of flexible printed circuits, explosive components, and ceramic components. The general design and manufacturing processes for these product lines would be very similar or identical to those processes used in the manufacture of existing products. Proposed processes and operations may also include operations that are not currently conducted at Mound Plant, such as environmentally acceptable printed circuit board fabrication processes. Proposed processes and operations not currently conducted at the Mound Plant may be similar to those analyzed in the Mound Plant Alternative described in Section 3.1.2.1 of the Nonnuclear Consolidation EA (Ref. 1) and their impacts would be bounded by that analysis.

In addition to the ongoing activities at Mound Plant, the Mound Plant Alternative in the Nonnuclear Consolidation EA would have consolidated the nonnuclear functions at Mound Plant from other DOE sites to include: 1) nonnuclear electrical/mechanical manufacturing functions would be transferred from the Kansas City, Pinellas, and Rocky Flats Plant, 2) lithium ambient batteries would be transferred from Los Alamos National Laboratory (LANL), and 3) special products, such as nuclear grade steels, safe secure trailers, weapons trainer shop, and metrology capabilities would be transferred from the Rocky Flats Plant. Any new construction required by proposed uses (except as described below) is outside the scope of the Mound Plant Alternative in the Nonnuclear Consolidation EA and is outside the scope of the Proposed Action in this EA. Any new construction at the Mound Plant would be subject to additional National Environmental Policy Act (NEPA) review. Leases or subleases for any uses not similar to those outlined in the Mound Plant

Alternative of the Nonnuclear Consolidation EA or similar to past operations would be subject to additional NEPA review before DOE's approval of the lease or sublease.

All leases issued as part of the Proposed Action would clearly define the DOE and tenant responsibilities with respect to compliance with all Federal, State, and local requirements. All leases would contain restrictive lease conditions to ensure compliance with regulatory requirements and to ensure that the proposed uses are within the bounds of this EA. Certain restrictive conditions imposed by regulatory permits, such as Mound Plant's air emissions, wastewater, and hazardous waste permits are already identified. Requirements for additional restrictive conditions would be evaluated, as needed. The existing environmental conditions of the proposed plant lease space would be certified by DOE prior to leasing to the prospective tenant, (DOE/OH) Economic Development, OH-5.5.01). The National Defense Authorization Act for Fiscal Year 1994 requires consultation with and concurrence from the United States Environmental Protection Agency (USEPA) in determining whether the environmental conditions of DOE property and the terms and conditions of the lease agreement are consistent with safety and the protection of public health and the environment prior to entering into a leasing agreement. Appendix A provides an example of the generic leasing agreement and a letter from the USEPA concurring with the use of the general purpose lease agreement. No adverse impacts are expected from any cleanup required in order to make building certifications pursuant to the Appendix A of the general lease. The level of cleanup will vary based on prospective uses and contractual requirements.

Commercialization at Mound will be implemented in a phased approach following a process which establishes the roles and responsibilities of the MMCIC, DOE-OH, DOE-MB and EG&G Mound Applied Technologies. Figure 2-2 is an economic development flow sheet that outlines the roles of the organizations noted above.

During each phase the MMCIC, would review proposals from commercial entities that want to utilize the site and would recommend tenants to DOE for occupancy based on their suitability to site requirements. The leases would include legally binding agreements between the lessor and the tenants regarding issues, such as payment of utilities costs, compliance with environmental regulations, and security at the facility. Activities and processes planned by tentative lessees would require oversight review by the MMCIC, or its equivalent, to assist DOE in determining the need for additional NEPA review. DOE would conduct additional NEPA reviews as necessary.

All leasing activities would be coordinated through the MMCIC. It is expected that the DOE or its representative would initially maintain common-use areas such as the utilities, wastewater treatment system, and waste storage areas.

Depending on specific tenant requirements, activities associated with commercialization may include equipment and plant layout rearrangements, renovation activities, and other routine maintenance activities or replacements and upgrades consistent with facilitating the conversion of the Mound Plant buildings identified in Chapter 3 of this EA to the extent necessary to facilitate commercial use. These preparation activities would be consistent with those activities that DOE has determined do not individually or cumulatively have a significant effect on the human environment (10 CFR 1021.410 and Appendices B1.3, B1.4, B1.7, B1.21, B1.22, B2.1-2.5, B4.6, B4.7, B4.11, B5.1, B6.3-6.6, and B6.8 of 10 CFR 1021).

Optionally, DOE might only allow limited scale activities that involve new manufacturing and new research processes; these processes would be screened per DOE-OH Economic Development, OH-5.5.01 prior to introduction onto the Mound Plant site. The Proposed Action would allow for

Economic Development Flowsheet Establishment of Roles and Responsibilities

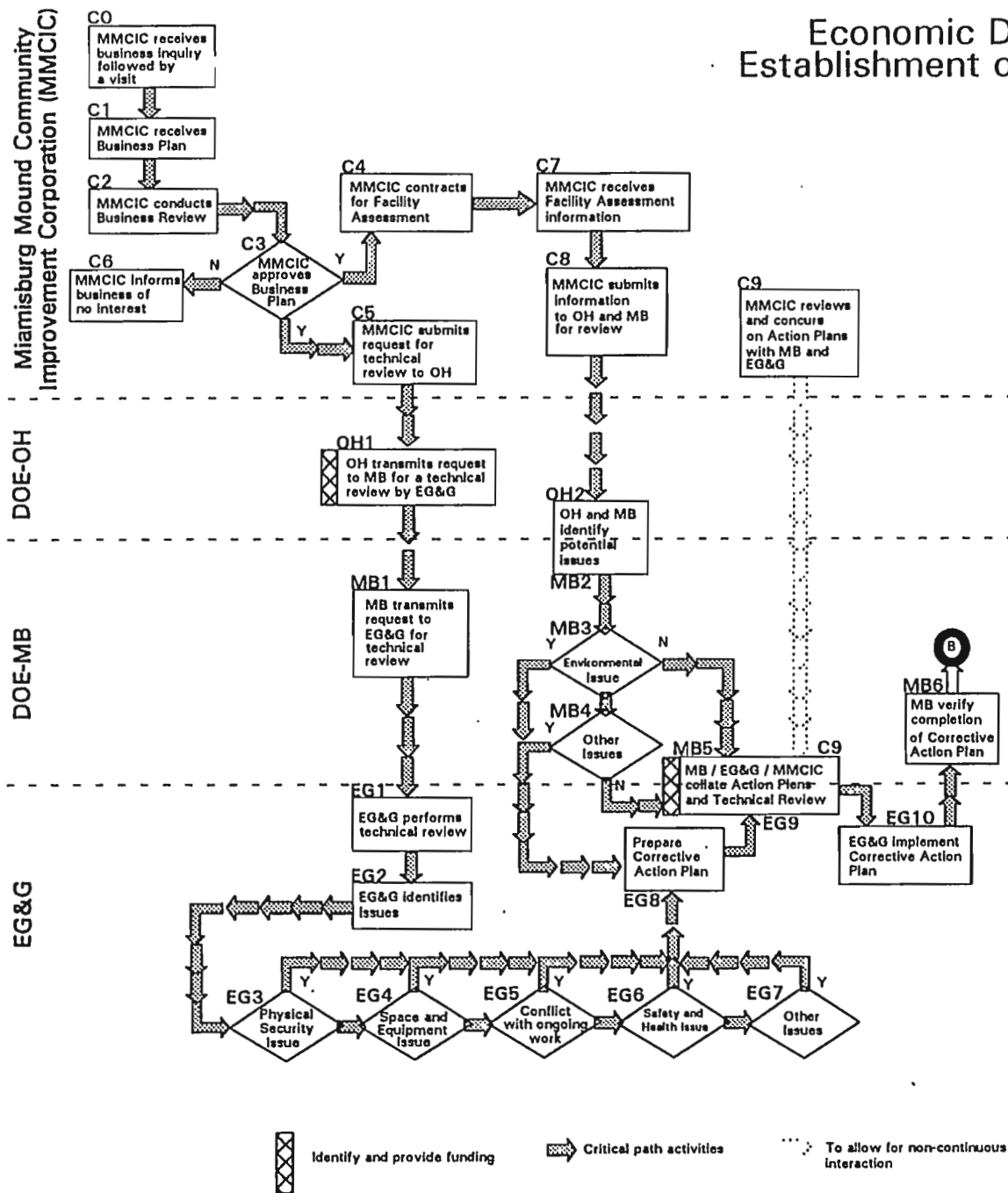
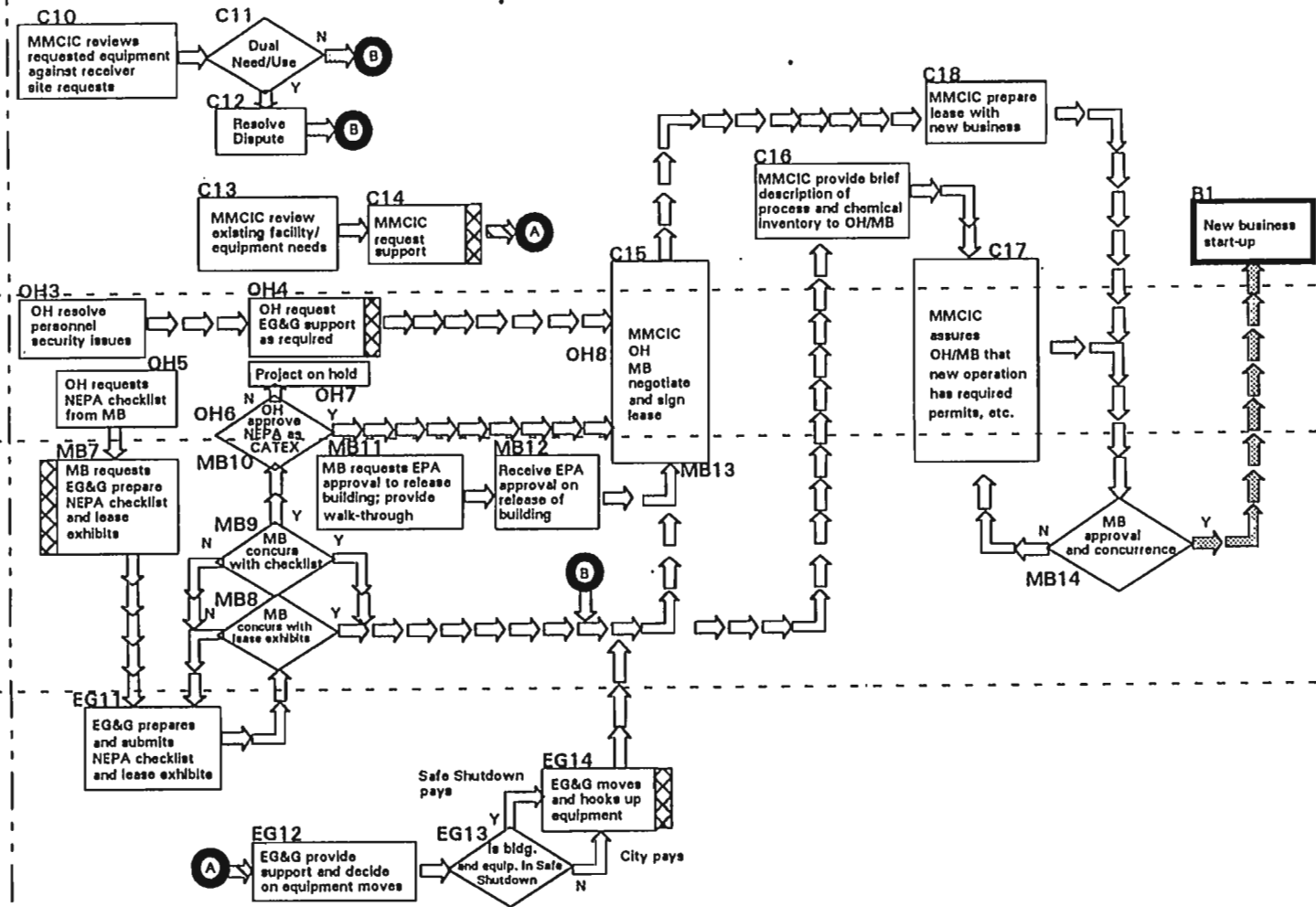

Figure 2-2: Economic Development Roles & Responsibilities





 Directional activities
  Ongoing activities feeding into critical activities

Figure 2-2: Economic Development Roles & Responsibilities (Continued)

additional employment at the facility of up to 1,500 workers in addition to the anticipated 1,100 workers for ongoing operations associated with environmental restoration and Nuclear Energy (NE) Radioisotopic Thermoelectric Generator (RTG) missions.

2.2 Alternative 1 - Commercialization Restricted to Existing Plant Capabilities and Uses

The primary alternative to the Proposed Action would be leasing portions of the Mound Plant to commercial enterprises engaged in processes and activities similar to those processes and activities currently performed at the plant. These processes and operations are described in Section 3.2.2 of the Nonnuclear Consolidation EA, (Ref. 1) and Section 3 of this EA. This would be achieved through the lessee arrangement described for the Proposed Action above. The lessee would be the MMCIC . All arrangements for commercial use of the facilities would be limited strictly to commercial enterprises which are purely administrative or engage in essentially similar activities in scope and scale to those currently in existence. This alternative would not introduce any new environmental impacts that exceed the operating envelopes established in the numerous Mound Plant environmental permits. Such permits include the plant's air and water permits as discussed in the Mound Site Environmental Monitoring Report for Calendar Year 1993, August 1994 (Ref 7).

The primary difference between this alternative and the Proposed Action is that this alternative would not allow leasing space for operations that differ substantially from ongoing operations. This alternative would have the potential to generate up to 200 jobs at the facility. This number is considerably lower than the employment estimate for the Proposed Action because there is limited demand for commercial activities that consist only of those currently being conducted at the site.

2.3 No Action Alternative

In this alternative, no attempts would be made to open up the Mound Plant for the local business community. Current research, development, and manufacturing activities would cease in 1995, and the Mound Plant would be transferred to the Department of Energy's Office of Environmental Restoration and Waste Management (EM) for future administration. All plant facilities and equipment would be brought to safe shutdown and/or removed for an undetermined future use or surplused. Decontamination and Decommissioning (D&D) of contaminated facilities would be a continuing activity which originated in the DOE Surplus Facilities Management Program. As chemically and/or radiologically contaminated facilities are determined to be surplus to the needs of the DOE, the facilities are placed under a surveillance and maintenance plan included in the D&D program. Mound D&D activities are performed in accordance with the technical, cost, and schedule baselines maintained for the D&D program and reflected in the Activity Data Sheets prepared and reviewed annually as part of the DOE budget and planning process and DOE Order 5820.2A. As discussed in Section 4.4 of the Nonnuclear Consolidation EA, additional NEPA review would be performed as the nature of the specific D&D project activities are identified (Ref. 1).

This action would not provide employment opportunities or otherwise stimulate the local economy. Ongoing activities at the plant would be limited to maintenance of buildings and essential utilities, environmental restoration activities, and security for grounds and buildings. Personnel requirements would be limited to 900 workers for environmental restoration and 200 workers for ongoing Nuclear Energy RTG missions. Implementation of this alternative would have considerable economic impacts to the community. Long-term environmental impacts of this alternative would include an overall decrease in emissions from the plant.

2.4 Alternatives Considered but Dismissed as Unreasonable

Three additional alternatives were considered but were dismissed as unreasonable because they fail to meet the four tenets of the Economic Development Initiative identified in Section 1.0, Purpose and Need for Agency Action. The first of these alternatives would be to sell the plant and all associated physical structures upon completion of environmental restoration activities. The second alternative considered and also deemed unreasonable would be to demolish the plant and all associated physical structures.. It has been estimated that the cost associated with cleaning up all Mound Plant facilities for subsequent sale of the real estate would be 1.1 billion dollars. The costs associated with completely demolishing the facilities would cost approximately an additional 300 million dollars. The costs associated with completing work on the Mound Plant Operable Units (see section 3.1) has been estimated to cost approximately 300 million dollars. Therefore, the additional environmental restoration costs associated with the above two alternatives would result in considerable additional costs above those identified for the Proposed Action, Alternative 1, and the No Action Alternatives These alternatives would also fail to provide sustained employment opportunities to the community. The third alternative is to continue DOE or other government-funded operations (such as Department of Defense) at the Mound Plant. This alternative was dismissed as unreasonable because it is not consistent with DOE's desire to consolidate and streamline operations as described in the Nonnuclear Consolidation EA (Ref. 1) and does not support commercialization of facilities. The above three alternatives would fail to achieve the Secretary's goals of the Economic Development Initiative.

3. Affected Environment and Environmental Consequences of the Proposed Action and Alternatives

Resources discussed in this chapter are limited to those which may be affected by the Proposed Action and alternatives. The resources listed below are discussed in brief, but are not analyzed in detail in this environmental assessment:

- Agricultural and Recreational Areas
- Wild and Scenic Rivers
- Transportation
- Noise
- Archaeological
- Wetlands and Floodplains

The region surrounding the Mound plant is predominantly agricultural, used for growing corn and soybeans. Prime and unique farmlands are not located at the Mound Plant. The proposed action and alternatives do not require use of additional land other than that already encompassed by the current site boundaries and therefore no impact to adjacent agricultural areas would occur. The Mound plant does not contain any recreational resources on its property, however, across the road is a city owned golf course and an Indian Burial Mound: Past and present plant operations at the Mound Facility have had and continue to have minor traffic and noise impacts on these areas. The proposed action has the potential to result in an increase of employment level up to historic employment highs at the Mound site, (Approximately 2,600, employees, 1984). Therefore, the proposed action and alternatives would not be expected to result in any additional impacts to these publicly utilized areas above those which currently exist, or have existed in the past. There are no wild and scenic rivers located in the vicinity of the Mound plant, (Letter, Lewis 1992: see Appendix B). In 1987 Wright State University conducted a field survey and examination of the Mound facility and it appeared that there were no significant archaeological remains on the Mound Plant site due to previous disturbance. No archaeological sites eligible for the National Register will be affected, (Letter, Kitchen 1992: see Appendix B). A small portion of the south property, (see Figure 3-1) falls within the 100 year flood plain of the Great Miami River. The south property is outside the scope of this environmental assessment, therefore, the proposed action will not be impacted. A wetlands investigation was initiated in response to terms set forth in the Federal Facilities Agreement (FFA) with DOE, U.S. EPA and Ohio EPA. The results of the wetlands assessment indicate that the Mound site does contain small areas onsite that meet the Army Corps of Engineers and EPA definition of wetlands, (Ref 8). These areas will not be disturbed by any activities involved with the proposed action or any of the alternatives.

As noted above, it has been estimated that the proposed action discussed in this Environmental Assessment has the potential to generate up to 1,500 jobs in addition to the estimated 1,100 employees needed to support proposed future programs. Total employment at the site is therefore not expected to increase above the past maximum employment levels. Therefore the impacts of the proposed action and alternatives discussed in this EA are not expected to result in any additional traffic and noise impacts above those which currently exist, or have existed in the past.

Description of the Mound Plant Site

The Mound Plant is located on 123 hectares (306 acres) in Montgomery County, Ohio, partially within the Miamisburg city limits (population 17,770) and 0.8 km (0.5 mi) east of the Great Miami River. The plant is 16 km (10 mi) south-southwest of Dayton and 80 km (31 mi) north-northeast of Cincinnati (Figure 3-1). Approximately 76,000 people live within an 8-km (5-mi) radius of the site.

The Mound Plant lies on high bedrock bluffs overlooking the city of Miamisburg, the Great Miami River, and the river plain to the west. The plant incorporates two high hills divided by a minor northeast-to-southwest-trending valley that feeds into the Great Miami River. Most of the buildings on the plant site occupy the northwest hill crest (Main Hill). A smaller group of buildings lies in the valley and on the valley slopes. Other buildings occupy the southeastern SM-PP Hill, (Figure 2-1).

The Mound Plant is owned by the DOE. It is operated by EG&G Mound Applied Technologies as a prime contractor for the DOE. Mound has been operating since 1948. The facility has been part of the nuclear weapons production administered by the DOE Albuquerque Operations Office. The plant was originally built to manufacture nonnuclear components for nuclear weapons assembled at other DOE sites. Production of these devices necessitated the development of several uniquely specialized areas of competence and supporting facilities. These capabilities led to the assignment of other weapons application products. There are currently 158 buildings and facilities at Mound. Total floor area at Mound is approximately 1.4 million square feet (Ref. 9). The workforce at Mound in September 1994 was approximately 1350 employees. In addition to manufacturing, production development capability is maintained at the Mound Plant. Mound's primary historical missions have been:

Operations Scheduled to Continue (estimated to require 1,100 workers)

- Design and production of calorimeters
- Stable isotope separation and sales
- Isotope heat source piece part fabrication
- Radioisotopic Thermoelectric Generator (RTG) heat source fabrication and qualification
- Commercial Tritium sales/inertial confinement fusion target loading.
- Tritiated aqueous Waste recovery
- Nuclear materials safeguards
- Pollution prevention
- Waste management
- Storage of nuclear materials
- Maintenance of standards and calibration facility
- Decontamination and Decommissioning
- Environmental Restoration (CERCLA)

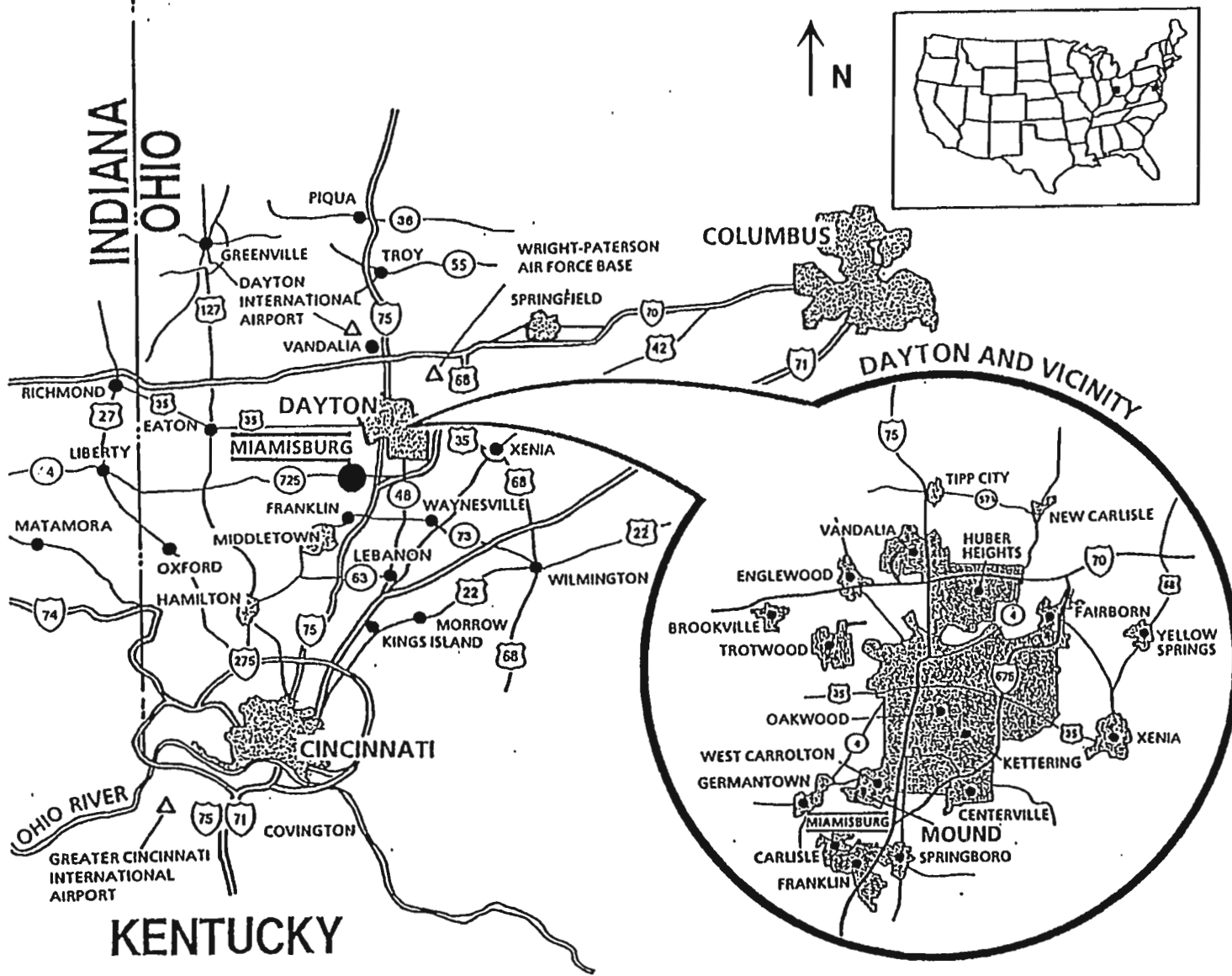

Figure 3-1: Southwestern Ohio and Location of Mound Plant

Operations Scheduled to End (Ref 10)

- Fabrication, assembly, and procurement of:
 - Detonators, firesets, and pyrotechnic devices.
 - Flexible circuits
 - Explosively Actuated timers
- Powder and thermite processing
- Explosive and reservoir surveillance testing
- Savannah River Operations Operational Capability Contingency
- Solid storage transfer systems
- Performance of surveillance activities to ensure reliability of nuclear stockpile
- Maintenance of process capability program
- Development of production engineering support

The majority of the work done at Mound has been done for Defense Programs (DP). As a result of the November 22, 1993 Department of Energy decision to phase out the Mound Plant and transition the Plant to the Office of Environmental Restoration and Waste Management (EM), Mound is currently in the process of phasing out the DP mission (Ref 2). The site will be transferred to EM for environmental cleanup under the provisions of a Federal Facility Agreement (FFA) entered into with the EPA and the sale under section 120 of the Comprehensive Environmental Response Compensation and Liability Act (CERCLA). A substantial infrastructure will remain to support environmental cleanup activities conducted by DOE EM.

Non-DP activities would continue to receive support related to security, non-destructive testing, waste disposal and management, public relations, finance, plant engineering and environmental health and safety programs. Lessees have the option to receive support for maintenance activities.

The types of hazards identified at the Mound Plant include energy sources, such as electrical, explosive, kinetic, lasers, and high pressure, non radioactive hazardous materials, like flammable materials, reactive materials, acids, toxic materials, cryogenic gases, plating solutions, and radioactive materials. Solid, liquid, and gaseous wastes, both radioactive and non radioactive, generated at the site are stringently controlled. This is accomplished by a variety of treatment, control, and monitoring systems.

The plant buildings and their functions are listed in Table 3-1. Figure 3-2 is a site map showing facilities available for lease.

Table 3-1. Mound Plant Building Summary

| Building | Function | Square Feet |
|-----------------|--|--------------------|
| A | Administration/quality | 55,582 |
| B | Inert production | 27,735 |
| C | Record Storage | 13,403 |
| COS | Development/production | 64,654 |
| DS | Development/standards/testing | 47,810 |
| Eb | Analytical services/production/analytical laboratory | 47,755 |
| EG1 | Emergency generators | 240 |
| EG2 | Emergency generators | 240 |
| EG4 | Emergency generators | 148 |
| EG6 | Emergency generators | 240 |
| EG7 | Emergency generators | 80 |
| G | Garage | 7,518 |
| GH | Human Resources | 5,347 |
| GP44 | Record Storage | 365 |
| GIS | Guard island entrance | 166 |
| GP1 | Change Rooms/firing range | 7,792 |
| GW | Bonded stores/receiving inspection | 9,782 |
| H | Environmental laboratories/laundry/change rooms | 17,334 |
| HH | Isotope separation | 15,276 |
| I | Explosives/pyrotechnics production | 25,736 |
| M | Tooling fabrication/Ceramics machining/Electroplating/ electronics | 56,018 |
| OSE | Engineering/DOE/cafeteria/auditorium/computer facility | 90,072 |
| OSW | Accounting/management information/drafting/central computer facility | 54,280 |
| PH | Storage | 646 |
| P | Powerhouse - [steam/chilled water/compressed air/breathing air] | 15,143 |
| PS | Paint shop | 2,288 |
| R | Nuclear laboratories/offices/library/D&D program | 55,003 |
| SD | D&D program | 1,593 |

| | | |
|-----------------|--|---------|
| SM | D&D program | 21,700 |
| SST | Salt storage for road treatment | 590 |
| SW | Tritium development/surveillance | 43,066 |
| T | Nuclear operations/tritium development/laboratories/health physics | 172,963 |
| W | Maintenance | 32,484 |
| WD | Radioactive waste treatment | 16,216 |
| WH1 | Well house | 374 |
| WH2 | Well house | 374 |
| WH3 | Well house | 128 |
| 1 | Explosives processing | 986 |
| 2 | Test fire | 6,291 |
| 3 | Test fire | 12,391 |
| 5 | Magazine | 314 |
| 6 | Magazine | 90 |
| 7 | Magazine | 387 |
| 8 | Magazine | 66 |
| 10 | Magazine | 66 |
| 11 | Magazine | 372 |
| 13 | Firing shed | 47 |
| 14 | Metal melting | 53 |
| 16 | Production storage | 480 |
| 17 | Production storage | 1,120 |
| 19 | Property management/surplus/property disposal | 4,480 |
| 20 ^b | Magazine | 303 |
| 21 | D&D program | 4,069 |
| 22 | Development/warehousing | 9,090 |
| 23 | Waste material staging area | 3,422 |
| 24 | Water treatment (potable) | 840 |
| 25 | Weather station | 430 |
| 26 | Maintenance | 800 |
| 27 | Energetic materials production | 5,285 |
| 28 | Ceramics production | 11,329 |

| | | |
|----|---|--------|
| 29 | Plastics production | 6,601 |
| 30 | Health Physics | 740 |
| 31 | TRU waste staging | 8,740 |
| 33 | D&D operations | 1,344 |
| 34 | Emergency brigade training | 1,110 |
| 35 | Non-Destructive Testing (NDT) Laboratory | 2,500 |
| 36 | Support functions for RTG assembly and testing operations | 4,255 |
| 37 | Organic Materials Development | 2,463 |
| 38 | Nuclear programs/D&D program | 44,327 |
| 39 | Engineering | 3,515 |
| 40 | Print shop/technical manuals/publications | 12,227 |
| 42 | Pyrotechnics production | 2,892 |
| 43 | Development | 1,516 |
| 44 | Cafeteria | 2,480 |
| 45 | Health Physics | 9,500 |
| 46 | Welding development | 2,439 |
| 47 | Security | 3,611 |
| 48 | Surveillance | 7,950 |
| 49 | Timer fabrication | 14,929 |
| 50 | RTG assembly and testing | 14,849 |
| 51 | Development | 3,541 |
| 52 | Magazine | 78 |
| 53 | Magazine | 239 |
| 54 | Magazine | 331 |
| 55 | Waste management | 330 |
| 56 | Fire pump and water tank | 613 |
| 57 | Sanitary sewage treatment | 510 |
| 58 | Filter bank | 6,110 |
| 59 | Neutron radiography | 668 |
| 60 | Ceramics | 3,958 |
| 61 | Warehousing/procurement/contracting | 45,490 |
| 63 | Quality/product tester/design/development | 16,461 |

| | | |
|-----|---|--------|
| 64 | Magazine | 72 |
| 65 | Production | 2,400 |
| 66 | Development | 600 |
| 67 | Energetic material support | 3,787 |
| 68 | D&D staging area | 1,990 |
| 69 | Production/Tritium Surveillance | 1,620 |
| 70 | Quality | 3,366 |
| 71 | Flammable liquids storage | 800 |
| 72 | Hazardous waste staging | 2,400 |
| 73 | Gas cylinder storage | 2,200 |
| 74 | Production storage | 400 |
| 79 | Waste Management Support | 1,650 |
| 80 | Magazine | 314 |
| 81 | Magazine | 314 |
| 82 | Magazine | 314 |
| 83 | Magazine | 314 |
| 84 | Magazine | 314 |
| 85 | Powder blending/processing | 3,160 |
| 87 | Destructive testing | 38,882 |
| 88 | Support functions for RTG assembly and testing operations | 7,200 |
| 89 | Detonator (Long term surveillance) | 4,830 |
| 90 | Retort (explosives waste) | 656 |
| 91 | Environmental, Safety & Health/training | 8,065 |
| 92 | Production training | 1,600 |
| 93 | Standards | 2,936 |
| 94 | Materials compatibility | 1,240 |
| 95 | Utilities operations | 2,000 |
| 96 | Disintegrator/storage | 432 |
| 98 | Fire Station | 8,517 |
| 99 | Security operations | 11,412 |
| 100 | Security | 6,292 |
| 101 | Engineering | 1,815 |

| | | |
|-----|----------------------------------|--------|
| 102 | Engineering (D&D) | 10,982 |
| 104 | Test Fire maintenance | 1,800 |
| 105 | Production machining | 38,027 |
| 106 | Production storage | 180 |
| 112 | Sand filters | 785 |
| 113 | Dewatering | 547 |
| 114 | Nitrogen separation | 432 |
| 120 | Health Physics storage | 350 |
| 122 | Hazardous Waste Storage Facility | 15,000 |

(Taken From the Mound Plant Construction Plan, 1993)
See Figure 3-2 for Facilities Available for Lease.

3.1 Environmental Restoration

Affected Environment

In compliance with the Comprehensive Environmental Compensation and Liability Act (CERCLA) and the Federal Facilities Agreement (FFA) signed by DOE, USEPA and Ohio EPA, the Mound Plant has undertaken environmental restoration (ER) activities to clean up contamination at the site. The Mound site had nine operable units (OU's) which have since been consolidated into six OU's that are being investigated at the Mound Plant. Figure 3-3 shows the locations of the six operable units. The following is a brief description of each OU at the Mound Plant.

Operable Unit 1, Area B

Addresses possible chemical and radioactive contamination of the portion of the Buried Valley Aquifer (BVA) which underlies the southwest corner of the original Mound plant. The main concern in OU 1 is volatile organic compounds (VOCs) migrating in groundwater. Crushed empty thorium drums and waste from cleaning filters in Mound's Waste Disposal Building are also included in OU 1.

Operable Unit 2, Main Hill

Addresses the source and pathways of possible groundwater contaminants on Mound's Main Hill. Historical Tritium releases have been tracked since the 1970's; the extent of VOC contamination is uncertain. Off-site groundwater seeps on Mound's north hillside are also included in OU 2.

Operable Unit 4, Miami Erie Canal

Addresses contamination of the old Miami-Erie canal bed in Miamisburg resulting from plant runoff, including an accidental plutonium spill in 1969. Tritium is also a contaminant of concern in the canal.

Mound CERCLA Operable Units – 1993

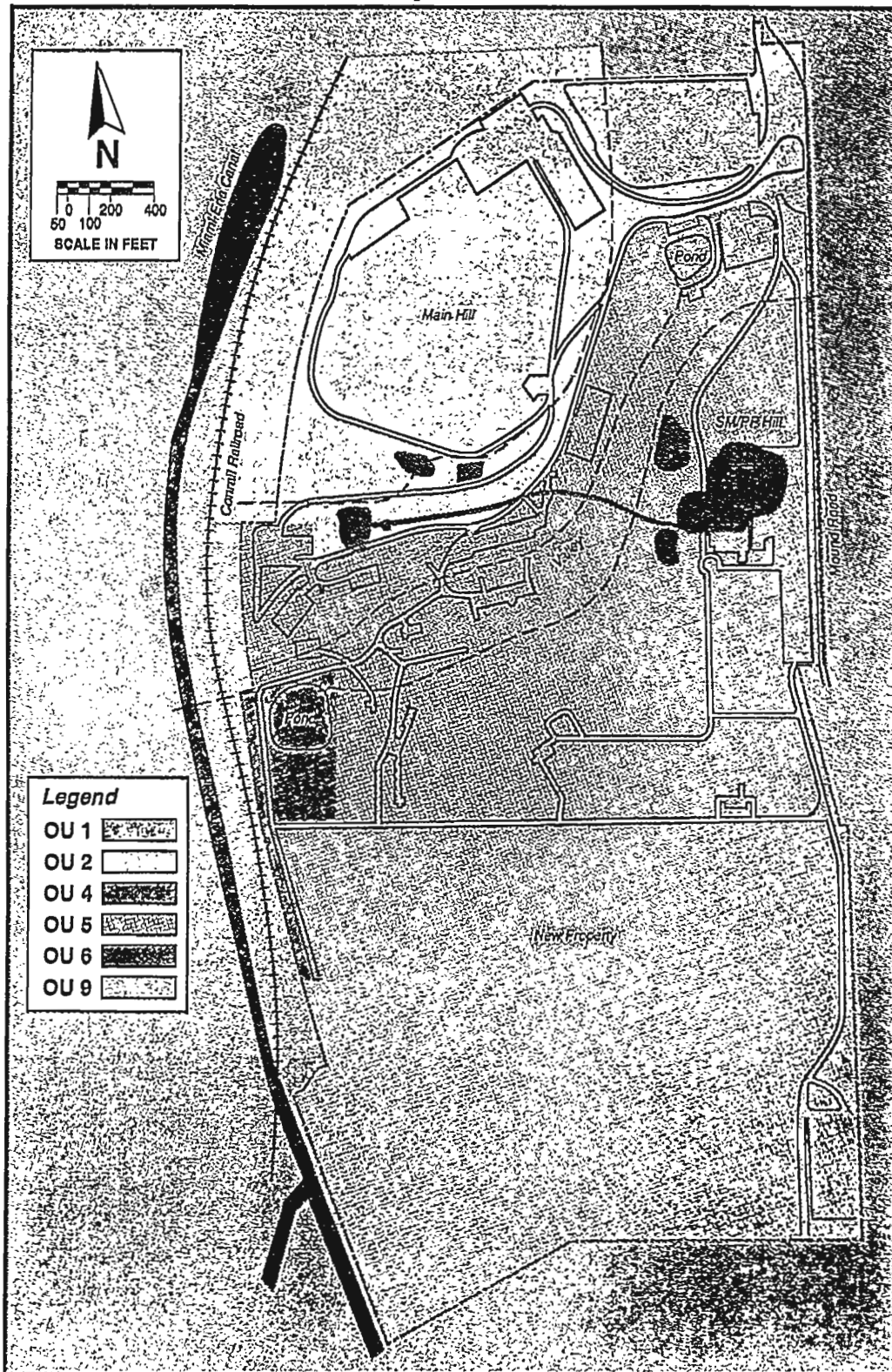

Operable Unit 6 shows only those D&D sites currently active; other areas will be added as the D&D program at Mound progresses. Limited on-site OU9 investigations are not shown on this map.

Figure 3-3: Location of Mound Operable Units

Operable Unit 5, South Property

Addresses on-site soil areas in the southern portions of Mound Plant known or suspected of being contaminated with radionuclides or chemicals. OU 5 will fully characterize the sources of contamination and migration within its geographical boundaries. Available data indicate that most of OU 5 is uncontaminated. However a number of areas within OU 5 are known to be contaminated with radioactive materials, principally thorium and plutonium. The areas were contaminated by disposal of contaminated soil or debris.

Operable Unit 6, Verification of Sites Under the Management of the Decontamination & Decommissioning Program

Addresses residual contaminants from Mound's ongoing D&D of unusual radiological facilities on-site. The current D&D program at Mound began in 1978 and presently addresses surplus plutonium facilities and underground waste pipelines. The D&D program is independent of the CERCLA Program and is not routinely subjected to EPA oversight. However upon completion of D&D activities, every site will be evaluated by the CERCLA Program under OU 6.

Operable Unit 9, Site-Wide/Off-Site

Addresses the total environmental effects of contamination attributed to Mound plant that may be found in the air, groundwater, soils, surface water and sediments: includes all ecological concerns. OU 9 encompasses the cumulative impact of all other Operable Units on-site and in the off-site environment, including characterization of possible contamination in the Buried Valley Aquifer and the Plant drainage system. Presently, site-wide investigations encompass the entire plant and the area within a 20-mile radius of the plant.

Impacts of the Proposed Action, Alternative 1, and the No Action Alternative

The Proposed Action, Alternative 1, and the No Action Alternative would be consistent with and would not impact ongoing environmental restoration activities at the Mound Plant. The environmental restoration activities are conducted per the FFA and would proceed independently of commercialization activities under the oversight of the U.S. and State EPA's.

3.2 Socioeconomics

Affected Environment

The discussion of socioeconomics of Mound is based on a Region of Interest (ROI) where 88% of Mound's employees lived in 1991. The ROI includes Butler (9%), Montgomery (65%) and Warren (14%) counties in Ohio. Mound is located within the city limits of the city of Miamisburg where light industry, office complexes and residential areas are located near the plant. 1990 census data show the population estimates for the ROI of 979,197. Table E3.6-1b of the Nonnuclear Consolidation Environmental Assessment of 1993 shows the regional growth pattern estimates at the Mound plant from 1970 through 2040, (Ref 1, Table E3.6-1b), (see Appendix D).

The Mound Plant currently employs over 1,300 employees. The average annual income with benefits included is approximately \$80,000 per year. More than 1,700 indirect (community employees) are needed to support operations and associated spending from the Mound Plant and its

employees. Direct payroll at Mound was estimated to be more than \$48.4 million (personal communication with Mr. Thomas Hughes, Manager EG&G Mound Applied Technologies (Ref 11).

The City of Miamisburg had total tax collections of \$7.5 million in 1992 of which \$1.6 million (approximately 21% of the total) was contributed by Mound employees. Mound employees have consistently played an important role in community affairs with individuals involved in educational outreach programs at local schools, and other important community needs.

Impacts of the Proposed Action

The impacts of the Proposed Action would be the potential for producing up to 1500 jobs at the Mound Plant within ten years of implementation. In terms of socioeconomic impacts, the Proposed Action would achieve the Secretary's initiative to commercialize Mound Plant facilities and meet the following objectives of DOE and MRC: 1) create high-caliber job opportunities, 2) stimulate local economic growth, 3) promote the commercialization of site-developed technology, and 4) reuse Department facilities compatibly with the continuing mission (Ref. 6). The Proposed Action would maximize the DOE's past investment in the facility, and in its human and technology resources. At a minimum, the Proposed Action would preserve the current economic viability of the employees, local suppliers, and the community that have served the nation's defense needs for the past 47 years in the Mound Plant area.

The Proposed Action is the alternative that is most consistent with the MRC's critical requirement that the facility succeed in attracting a major large high-technology anchor tenant to the site. In addition to providing continued job opportunities in the area, it would continue the Mound Plant's role in fueling the growth of technology and manufacturing firms in the area. Additionally the educational outreach programs supported by Mound's technical staff would continue to benefit the local school systems. The Proposed Action would result in the least severe adverse economic impact on the community due to cessation of the Defense Programs mission at the plant. Depending on the number of similar high-technology firms attracted to the area by the favorable commercialization activities at the Mound Plant, the positive socioeconomic benefits to the community presented by the Proposed Action may actually exceed the positive impacts resulting from ongoing activities at the plant. Through leasing procedures, activities at the Mound Plant would be conducted to ensure that leasing activities do not have the effect of excluding persons (including populations) from participation in, denying persons (including populations) the benefits of, or subjecting persons (including populations) to discrimination under the economic development activities at the Mound Plant because of their race, color, or national origin. The DOE is committed to the EPA's policy regarding environmental equity issues. Environmental equity refers to the distribution of environmental risks across population groups. The DOE will evaluate, in NEPA documents, the impact of departmental actions on racial minority and low-income populations to insure that these groups are not bearing a disproportionate share of environmental risk. The proposed action and alternatives discussed in this EA will take place within the city limits of Miamisburg, Ohio. Racial minority and low income families do reside in the Miamisburg community, however, Miamisburg is not a racial minority or low income community. The proposed action and alternatives will therefore not have any unique affects on these groups, (Ref 12).

Impacts of Alternative 1

The impacts from Alternative 1 would be the potential for creating up to 200 jobs at the Mound Plant. The corresponding benefit to the community would be valued at considerably less than that of the proposed action.

Impacts of the No Action Alternative

The impacts from the No Action Alternative would be the potential for retaining approximately 900 jobs at the Mound Plant in support of environmental restoration program work and Nuclear Energy (NE) Radioisotopic Thermoelectric Generator (RTG) heat source program work. The no action alternative would result in some displacement of households, businesses, and support contractors. In addition, it would have the effect of stifling the potential for the economic growth of the community that would result from productive use of Mound Plant facilities.

3.3 Air Emissions

3.3.1 *Non radiological Air Emissions*

Affected Environment

Mound is located within the Metropolitan Dayton Intrastate Air Quality Control Region (AQCR). The region is under the authority of the Regional Air Pollution Control Agency (RAPCA), which conducts a program to monitor ambient levels of criteria pollutants. This AQCR is designated as attainment by the Environmental Protection Agency (EPA) with respect to SO_x , NO_x , and CO (40 CFR 81.336). However, several counties within the AQCR, have been classified as non attainment for Total Suspended Particulate (TSP) and ozone (O_3). The Ohio EPA has standards for existing pollutants regulated by National Emission Standards for Hazardous Air Pollutants (NESHAP). Ambient air quality near Mound is monitored by the RAPCA monitoring program and that of the Southwestern Ohio Air Pollution Control Agency. The principal sources of criteria air pollutants at Mound are the two boilers associated with the steam plant. Other sources include fugitive particulates from process emissions, emissions from laboratory operations, and vehicular emissions. Table 3-2 summarizes the criteria pollutants emissions from the Mound plant for calendar year 1993. This information in this table was obtained from the Mound Air Emissions Inventory for Calendar Year 1993

Table 3-2 Criteria Pollutants Emissions for the Mound Plant for 1993

| Source | TSP ^a (lbs/yr) | SO _x (lbs/yr) | NO _x (lbs/yr) | VOC's ^b (lbs/yr) | CO (lbs/yr) | Lead (lbs/yr) |
|--|------------------------------|-----------------------------|-----------------------------|--------------------------------|----------------|------------------|
| Internal Combustion Engines | 1304 | 1254 | 20678 | 9055 | 250,000 | NA |
| Gasoline Dispensing Stations | NA | NA | NA | 628.6 | NA | NA |
| Energetic Material Disposal | 39.5 | 0.0 | 0.4 | 0.0 | 441 | 0.0 |
| Paint Spray | NA | NA | NA | 587 | NA | NA |
| Power House | 4111 | 243 | 42014 | 174.7 | 10,503 | NA |
| Underground Storage Tanks | NA | NA | NA | 0.2 | NA | NA |
| Roadways and Parking Lots | 17,808 | NA | NA | NA | NA | NA |
| Miscellaneous Particulates | 138.2 | NA | NA | NA | NA | NA |
| Miscellaneous VOC's | NA | NA | NA | 8529 | NA | NA |
| | | | | | | |
| Total of Pollutant (lbs/yr) (a) | 22096 | 243 | 42,0142 | 9919 | 10944 | 0 |
| Total of Pollutant (tons/yr) (a) | 11.0 | 0.12 | 21 | 4.95 | 5.47 | 0 |
| Major Emitter Threshold Limit (tons/yr) ^b | 100 | 250 | 100 | 100 | 250 | 0.6 |
| Percent of Threshold Limit | 11.0 | 0.04 | 21 | 4.95 | 2.18 | 0 |

a excluding mobile emission sources contained in internal combustion engine source

b Clean Air Act Sec 112, Ohio Administrative Code 3745-77-01 (w)

As of July 1994, the Ohio EPA has not promulgated standards for the additional 189 Hazardous Air Pollutants (HAPs) specified in the Clean Air Act (CAA). However, the Ohio EPA uses the American Conference of Governmental Industrial Hygienists (ACGIH) list of pollutant Threshold Limit Value (TLV). The HAPs/toxics described in this section are those currently used at Mound or those anticipated to be used under the proposed action. Hazardous Air pollutants (HAPs) are regulated under NESHAPS. HAP/toxic emissions from Mound are derived based on detailed documented process knowledge from air permits and/or applications filed with the Ohio EPA. The emission inventories for Mound HAPs are presented in Table 3-3.

Table 3-3 Hazardous Air Pollutants (HAP's) for the Mound Plant in 1993

| Chemical (HAP) | Estimated Emission (lbs/yr) (a) |
|---------------------------|---------------------------------|
| Acetonitrile | 0.61 |
| Acrylonitrile | 12.6 |
| Asbestos | 7.88 |
| Benzene | 24.98 |
| Carbon Disulfide | 9.68 |
| Carbon Tetrachloride | 0.02 |
| Chlorine | 0.96 |
| Chlorobenzene | 0.19 |
| Chloroform | 6.24 |
| Cumene | 0.58 |
| Dichlorobenzene | 11.52 |
| Diethanolamine | 0.05 |
| Dimethyl Formamide | 25.85 |
| Dioxane | 28.23 |
| Epichlorohydrin | 30.10 |
| Ethylene Glycol | 1.04 |
| Hexane | 545.88 |
| Hydrochloric Acid | 774.58 |
| Hydrofluoric Acid | 17.42 |
| Methanol | 2383.17 |
| Methyl Isobutyl Ketone | 38.4 |
| Methylene Chloride | 13,690 |
| Phosphine | 0.0 |
| Polychlorinated Biphenyls | 96 |
| Tetrachloroethylene | 1.92 |
| Toluene | 37.11 |
| Toluene diisocyanate | 54 |
| Trichloroethane | 1,820 |

| | |
|--|-----------|
| Trichloroethylene | 44.74 |
| Xylene | 194.08 |
| Arsenic Compounds | 8.74 |
| Cadmium Compounds | 0.19 |
| Chromium Compounds | 8.98 |
| Cyanide Compounds | 26.28 |
| Lead Compounds | 9.30 |
| Mercury Compounds | 0.58 |
| Nickel Compounds | 166.82 |
| | |
| Total HAPs (lbs/yr) (c) | 20,078.72 |
| Total HAPs Threshold Limit (b) | 50,000 |
| Total HAPs Percent of Threshold (%) | 40.1 % |
| | |
| Maximum Individual HAP (lbs/yr) | 13,690 |
| Maximum Individual HAP, Threshold Limit (b) | 20,000 |
| Maximum Individual HAP, Percent of Threshold (%) | 68.4 % |

- a quantity released is based upon documented process knowledge from air permits and/or applications filed with the Ohio EPA.
- b The Threshold Limits for regulation as a major source are:
 - > 50,000 lbs/yr (25 tons/yr) of combination of HAPs
 - > 20,000 lbs/yr (10 tons/yr) of any single HAP
 (Clean Air Act, Sect 112; Ohio Administrative Code 3745-77-01 (w))
- c excluding radionuclides

Impacts of the Proposed Action

Tenants will be required to obtain and comply in all respects with regulatory agency permits, regarding air emissions, during the term of the lease. Processes that are proposed would be reviewed by MMCIC and DOE with respect to their impacts on air emissions, and DOE would conduct additional NEPA review, if appropriate.

Both the Proposed Action and Alternative 1 may be affected by proposed regulations, such as National Emissions Standards for Hazardous Air Pollutants (NESHAPS), 40 CFR Part 83, Halogenated Solvent Cleaning Processes, and Clean Air Act (CAA), Section 112g, Title V permitting requirements. Affected processes would be subject to evaluation to ensure that they meet the new requirements.

Potential tenants whose air impact estimates would exceed the baseline emissions estimates provided for the Mound Plant (Tables 3-2 and 3-3, pages 24, 25 & 26) would either be rejected as tenants or would be required to undergo additional DOE NEPA analysis prior to being permitted onsite as a tenant. Because the emissions from the Mound Plant associated with the Proposed Action would be within Ohio EPA standards, no adverse human health effects from the Proposed Action would be anticipated. It is possible that emissions due to specific chemicals brought in to support new processes would be increased beyond baseline emissions (Table 3-2 and 3-3) for those chemicals, but these increases would not be allowed to exceed applicable State regulatory standards or permitted limits.

Conformity and the Proposed Action

The CAA requires Federal actions to conform to any SIP approved or promulgated under Section 110 of the CAA. Montgomery County is presently designated as a moderate non attainment area for ozone. Using conservative assumptions on potential employee commutes and mobile source emission factors, an emissions estimate of cumulative direct and indirect VOC emissions associated with the Proposed Action was determined to be 13.8 tons per year (TPY). The data and calculations are provided in Appendix E. These emissions were comprised of 5 TPY of stationary source permitted emissions representing present baseline conditions (Table 3-2) and 8.8 TPY attributed to cumulative annual employee commutes to and from the Mound Plant. Based on this estimate, a formal determination of conformity is not required at this time Pursuant to the general conformity requirements of 40 CFR Part 51, Subpart W, a formal determination of conformity may be required at a future date should the cumulative effects of the Proposed Action change.

Impacts of Alternative 1

The impacts of Alternative 1 present no effects that would differ from the existing Mound Plant air emissions baseline as provided in Tables 3-2 and 3-3. Since all processes would be administrative in nature or limited to activities similar to ongoing processes, air emissions would not differ, in quantity or characteristics, from current air emissions. It is anticipated that an overall reduction in plant air emissions would result from implementation of this alternative because the type of work being performed would be at a reduced scale from historical operations (prior to 1993). Since the total number of anticipated employees would be less than that associated with the

proposed action, the cumulative direct and indirect emissions from the implementation of this alternative would be below those identified in the Proposed Action.

Impacts of the No Action Alternative

The D&D and close-out activities associated with the No Action Alternative are expected to result in an overall long-term reduction in air emissions generated by the Mound Plant (i.e. below those identified in Tables 3-2 and 3-3. Emissions would be reduced as the processes that involve chemicals are discontinued.

3.3.2 Radiological Air Emissions

Affected Environment

Normal operations in 1993 resulted in radionuclide emissions to the air from operations at the Mound Plant. These emissions included 664 curies of tritium, 1.2×10^{-5} curies of plutonium -238, 4.0×10^{-8} curies of plutonium-239,240, 6.3×10^{-8} curies of uranium-233,234 and 5.7×10^{-8} curies of uranium-238,(Ref 7). Maximum Committed Effective Dose Equivalent (CEDE) were calculated for these radiological air emissions. Table 3-4 summarizes the radiological emissions to the air and the hypothetical consequences of the releases.

Table 3-4 Mound Plant Radiological Air Emissions in 1993

| Radionuclide | Activity (curies) | Maximum Committed Effective Dose Equivalent to a Hypothetical Individual in 1993 (mrem) ^b |
|-------------------|----------------------|--|
| Tritium | 664 ^a | 0.005 |
| Plutonium-238 | 1.2×10^{-5} | 0.13 |
| Plutonium-239,240 | 4.0×10^{-8} | 0.005 |
| Radon-222 | 1.1 | c |
| Uranium-238 | 5.7×10^{-8} | c |
| Uranium-233,244 | 6.3×10^{-8} | c |

^a Tritium in air consists of: tritium oxide, 522 Ci and Elemental tritium, 142 Ci

^b Hypothetical individual is assumed to remain at the site boundary 24 hours per day throughout 1993. This individual was assumed to have:

- breathed only air containing the highest average radionuclide concentrations measured at an onsite air sampling station
- drawn all of his/her drinking water from the offsite well with the highest average concentration, and
- consumed produce exhibiting the concentrations measured in the samples collected from the Miamisburg area.

^c Many tritium, plutonium, and uranium measurements were below their respective reagent blanks or environmental levels and, due to the extremely low levels, it is standard practice not to include measurements at these levels

Maximum Effective Dose Equivalents (EDE) to individuals in the population were calculated for radionuclide air releases using the EPA's computer code CAP-88, (Ref 13). The maximum EDE from airborne releases was 0.04 mrem. The EPA's annual dose limit for airborne releases is 10 mrem. Therefore Mound's releases in 1993 represented 0.4% of the EPA dose standard. CAP-88 was also used to evaluate the population dose from the radiological releases. The population within a radius of 80 km of Mound received an estimated 2.1 person rem from plant operations in 1993. The average collective dose from background sources of ionizing radiation within an 80 km radius of the Mound Plant is approximately one million person rem. A discussion on the methods used to calculate offsite radiation dose is presented in both the Appendix and section 4.7 of the Mound Site Environmental Report for Calendar Year 1993, (Ref 7).

In addition to setting limits on the dose equivalent to any member of the public from Mound operations, DOE has established Derived Concentration Guidelines (DCG) for individual radionuclides. The DCG for a radionuclide is defined as the concentration of that radionuclide in air or water that will give a 50 year CEDE of 100 mrem if taken into the body by inhalation or ingestion. The concentrations of radionuclides from Mound found in all environmental media during 1993 were only small fractions of the DCG's for the respective radionuclides, (Mound Site Environmental Monitoring Report for Calendar Year 1993). The DOE DCG values for individual isotopes (in air) of concern are: DCG Tritium Oxide (10^{-12} $\mu\text{Ci/mL}$), DCG plutonium-238 (10^{-18} $\mu\text{Ci/mL}$), DCG plutonium-239,240 (10^{-18} $\mu\text{Ci/mL}$), DCG Radon-222 (No DOE DCG for Radon-222 exists), DCG uranium 238 (2×10^{-12} $\mu\text{Ci/mL}$), DCG uranium 233, 234 (2×10^{-12} $\mu\text{Ci/mL}$)

Impacts of the Proposed Action

No net increases in radiological air emissions over existing emissions (Table 3-4) would be anticipated from the Proposed Action. Radioactive air emissions would be expected to decrease as the DP mission is phased out, (there may be slight increases in radionuclide air emissions due to D&D activities).

Under the conditions of the lease, tenant effluent discharges would be limited to the current plant baseline radionuclide emissions to the air, (Table 3-4). No new radionuclides will be introduced to the site. Potential tenants whose air impact estimates would exceed the baseline emissions estimates provided for the Mound Plant (Tables 3-4) would either be rejected as tenants or would be required to undergo additional DOE NEPA analysis prior to being permitted onsite as a tenant.

Impacts of Alternative 1

The impacts from Alternative 1 on radiological air emissions would be essentially the same as from current Mound Plant emissions (Table 3-4) as documented in the Mound Site Environmental Report for Calendar Year 1993, (Ref 7). Operations that result in radiological air emissions would not be changed significantly from similar ongoing operations.

Impacts of the No Action Alternative

The impact of the No Action Alternative would be an overall reduction in radiological air emissions. Radiological air emissions would be generated through activities associated with the operations scheduled to continue (see page 11 of this EA) and would not be expected to rise above the baseline conditions (Table 3-3). These emissions would also eventually decrease as the operations are completed.

3.4 Effluent Discharges

3.4.1 Non radiological Discharges

Affected Environment

Mound releases waste water to offsite surface waters via three discharge systems. In 1993 Mound discharged an average of 2.78 million liters of water per day to the Great Miami River. The average flow rate of the Great Miami River is greater than that of Mound's effluents and therefore releases from Mound can be expected to have a minimal impact on river quality.

Mound discharges are regulated by a National Pollution Discharge Elimination System (NPDES) permit. Mound's permit was renewed in October of 1992; it will remain valid through March of 1997.

Mound's NPDES permit requires scheduled collection and analysis of plant effluents at four onsite locations. Additional sampling requirements are required for one offsite outfall and three Great Miami River locations.

During calendar year 1993, Mound collected 1574 samples for analysis of NPDES parameters. One exceedance did occur. On August 5, 1993, Mound recorded a chlorine concentration of 0.76 mg/L in the effluent discharged by the sewage treatment plant; the daily limit for Mound at that location is 0.5 mg/L. The exceedance was reported and corrective action was taken in the form of replacing a faulty solenoid valve. The incident did not reoccur, and the Ohio EPA did not issue a notice of violation or noncompliance.

The NPDES requirements can be found in Appendix C for calendar year 1993. Figure 3-4 shows the locations of the outfalls (NPDES sampling locations). Appendix C also contains a summary table showing the organic compounds detected in Mound effluents in 1993.

Impacts of the Proposed Action

Under the conditions of the lease tenant effluent discharges would be limited to levels currently permitted under the discharge standards, as established under by the Mound Plant's NPDES permit. Potential commercial tenants would be required to demonstrate that proposed operations involving effluent discharges would meet the existing Mound Plant discharge standards.

Processes that are proposed to be brought on site would be reviewed by MMCIC and DOE with respect to their impacts on non radiological effluent discharges, and DOE would conduct additional NEPA review, if appropriate. If the processes proposed to be brought on site are substantially different than ongoing operations, the current waste water permit may require modification. Impacts from effluent discharges, however, will be no greater than the impacts stated in the Nonnuclear Consolidation EA for the Mound Plant Alternative (Ref 1). These stated impacts are increased storm water runoff of up to 132 million gallons per year(Ref 1, page 4-198) of additional waste water.. Any modifications of the NPDES permit must be approved by the Ohio EPA.

NPDES Sampling Locations

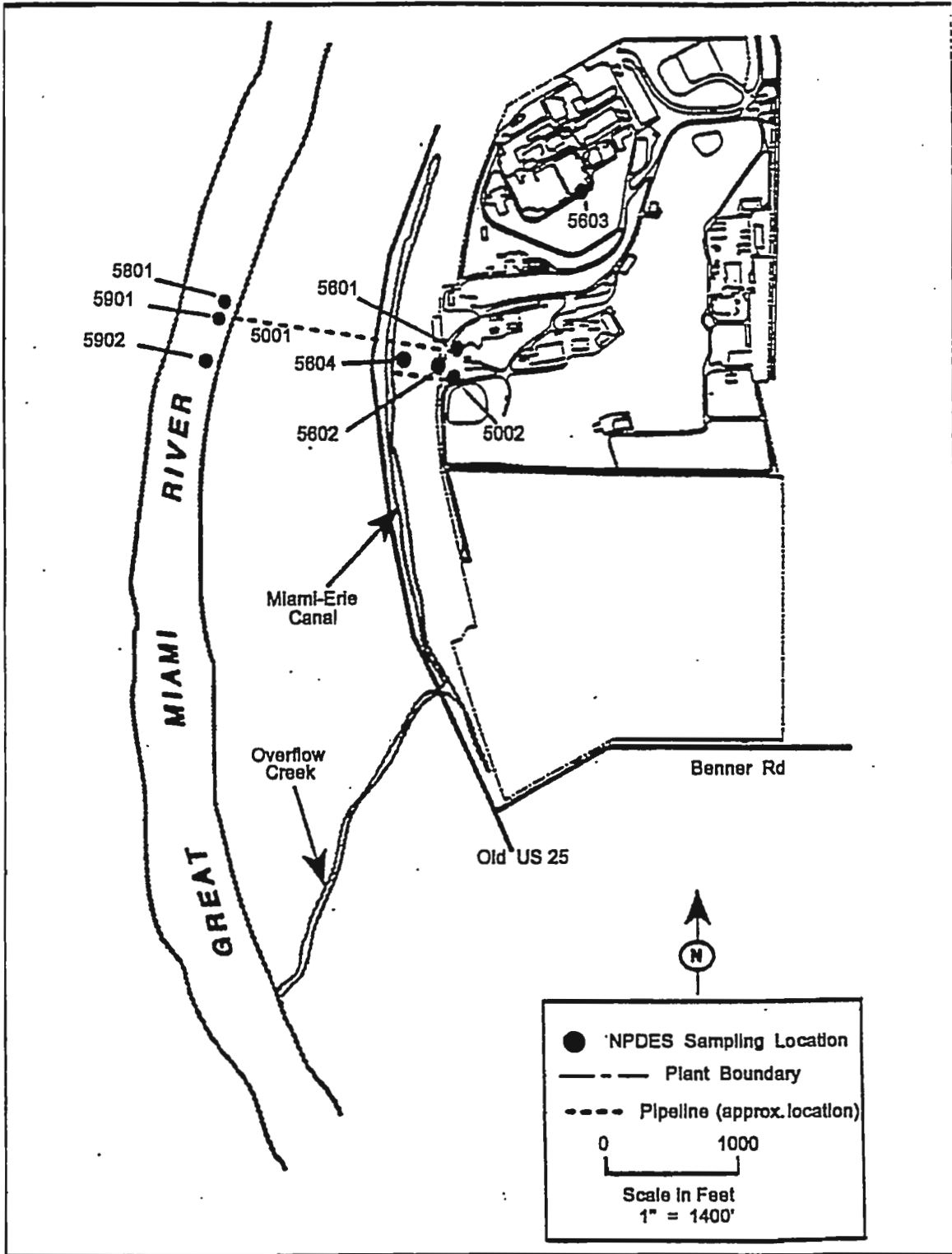

Figure 3-4: NPDES Sampling Locations

Impacts of Alternative 1

The impact of Alternative 1 on non radiological liquid effluents would be essentially the same as the current Mound Plant effluent, (Appendix C). Operations that result in liquid effluents would not be changed significantly from similar ongoing operations and would be within the parameters of the current NPDES permit. Under Alternative 1, administrative activities may be moved to the plant to replace the industrial activities that are removed as the DP mission is phased out. As a result, the ratio of industrial waste water to sanitary waste water would decrease. It is expected that this would result in a decrease in the concentrations of various constituents, such as metals and toxic organics, in the Mound Plant liquid effluent.

Impacts of the No Action Alternative

The impacts from the No Action Alternative on the liquid effluent released from the Mound Plant would be an overall long-term decrease in both quantity and concentration of industrial constituents, such as metals and toxic organics. As the industrial operations are removed, the liquid effluent from the plant would be primarily sanitary waste water. The quantity of the sanitary waste water would be anticipated to decrease due to the reduction in the workforce.

3.4.2 Radiological Liquid Effluents

Affected Environment

Radionuclide concentrations in the Great Miami River are shown in Figures 4-6 through 4-9 of the Mound Site Environmental Report for Calendar Year 1993. Total discharges to the Great Miami River during 1993 consisted of 2.5×10^{-4} Ci of plutonium-238, 3.4 Ci of tritium, 3.5×10^{-4} Ci of uranium-233,234 and 8.9×10^{-6} Ci of plutonium-239 (Ref 7). Table 3-5 summarizes the radiological effluents to the water and the hypothetical consequences of the releases.

Averages for 1993 were on the order of one-thousandth of a DCG or less. The primary use of DCG's for liquid releases is to control exposure received from drinking water supplies. Since the Great Miami River is not a source of drinking water, the DCG's only serve to help put the values in perspective. The DOE DCG values for individual isotopes (in water) of concern are: DCG Tritium ($2000 \times 10^{-6} \mu\text{Ci/mL}$), DCG plutonium-238 ($40,000 \times 10^{-12} \mu\text{Ci/mL}$), DCG plutonium-239,240 ($30,000 \times 10^{-12} \mu\text{Ci/mL}$), DCG Radon-222 (NO DOE DCG for radon-222 exists), DCG uranium 238 ($6 \times 10^{-7} \mu\text{Ci/mL}$), DCG uranium 233,234 ($5 \times 10^{-7} \mu\text{Ci/mL}$)

The Mound Plant's processing of radiological effluents is conducted in compliance with DOE Order 5400.5 through implementation of the As Low As Reasonably Achievable (ALARA) Program. The objective of the ALARA Program is to limit the release of radiological effluents and limit potential worker exposure to radioactive materials through conservative use of these materials, containment of radiological materials and equipment, and use of personal protective equipment.

Impacts of the Proposed Action

In the Proposed Action, release levels of radioactive effluents would be expected to remain at or below the current levels identified in 1993 Mound Environmental Report and noted above in Table 3-5. These levels comply with release standards that were developed by DOE to protect public health and safety. Any potential tenant processes that result in release of radiological liquid

Table 3-5 Mound Plant Radiological Effluent in 1993

| Radionuclide | Activity (curies) | Maximum Committed Effective Dose Equivalent to a Hypothetical Individual in 1993 (mrem) ^a |
|-------------------|----------------------|--|
| Tritium | 3.4 | 0.04 |
| Plutonium-238 | 2.5×10^{-4} | b |
| Plutonium-239,240 | 8.9×10^{-6} | b |
| Uranium-233,244 | 3.5×10^{-4} | b |

^a Hypothetical individual is assumed to remain at the site boundary 24 hours per day throughout 1993. This individual was assumed to have:

- breathed only air containing the highest average radionuclide concentrations measured at an onsite air sampling station
 - drawn all of his/her drinking water from the offsite well with the highest average concentration, and
 - consumed produce exhibiting the concentrations measured in the samples collected from the Miamisburg area.
- b Many tritium, plutonium, and uranium measurements were below their respective reagent blanks or environmental levels and, due to the extremely low levels, it is standard practice not to include measurements at these levels

effluents would be subject to the same discharge limits that currently apply at the Mound Plant. These limits would be specified in the conditions of the lease agreement. Processes proposed to be brought on site with the potential for radiological effluent releases higher than the levels shown in 1993 Mound Environmental Report, or releasing different radionuclides, may be rejected as a potential tenant or would be subject to additional NEPA review by DOE.

Impacts of Alternative 1

The impact of Alternative 1 on radiological liquid effluents would be essentially the same as the current Mound Plant baseline (Table 3-5) and in the Mound Environmental Report for Calendar Year 1993, (Ref 7). Operations that result in radiological liquid effluents would not be changed significantly from similar ongoing operations and would be controlled under DOE and State of Ohio radiological liquid effluent levels..

Impacts of the No Action Alternative

The impacts of the No Action Alternative on radiological liquid effluents released from the Mound Plant would be an eventual decrease in their quantity and concentration. This would result from the removal of processes that generate the radiological liquid effluent. Initially, D&D activities may result in a period of increased (still below DOE Guidelines) discharge of radiological liquid effluent. Radiological liquid effluent would be generated through D&D activities associated with cleaning contaminated building material and consolidating contaminated equipment . After D&D activities are completed, the quantity of radioactive liquid effluent would be expected to approach zero.

3.5 Waste Management Capacity

Affected Environment

Waste management operations at Mound consist of five broad waste types: Transuranic (TRU) (> 100 nCi/gram, atomic # > 92 and half life > 20 years), Low Level Waste (LLW) (< 100 nCi/gram), mixed waste, hazardous/toxic waste, and non-hazardous waste. In calendar year 1993 there was no TRU waste generated at the Mound site. Mound has a backlog of TRU waste of 8904 cubic feet. The waste is currently in storage as no disposal alternative currently exists. Table 3-6 presents the 1993 waste generation at Mound.

Source: Nonnuclear Consolidation Environmental Assessment and Mound Waste Management

Radioactive Waste Streams and Management.

LLW consists of paper, wood, building debris, and soil contaminated with Pu-238, Pu-239, and thorium; and paper, wood, plastic, and scrap equipment contaminated with tritium. Currently, approximately 70 percent of the LLW generated at Mound is a result of ongoing D&D activities. The liquid waste at Mound contaminated with Pu-238 is treated in the Waste Disposal (WD) Facility. The precipitant Pu-238 forms a sludge which is put in drums for disposal. The low-level tritium-contaminated liquid waste is solidified with cement in 55-gal steel drums. Additional low-level management facilities are described in Table 3-7. All solid LLW is transported by commercial carriers in closed vans to a DOE acceptable site. Prior to shipment, LLW is staged in Building 31. As of the end of August 1994, there were approximately 210,000 cubic feet of LLW at the plant awaiting shipment.

Mixed Waste.

Mound's backlog of low-level mixed waste was generated from scintillation vials, lead residue and bricks, PCBs, and contaminated mercury, (Table 3-8). Low-level mixed waste is containerized and stored in Building 23 at Mound pending completion of waste characterization and identification of an acceptable waste treatment/disposal option by DOE. As is the case with all DOE sites, Mound is finding it difficult to comply with land disposal restrictions and waste storage time limits for its mixed wastes, since disposal options are not available. It is anticipated that Mound's glass melter thermal treatment unit, with a treatment capacity of 740 cubic feet per year, would be available in 1997 for treatment of much of Mound's backlog waste. This unit would be used to process mixed waste and vitrify the bottom ash. A RCRA Part B permit application and a Trial Burn Plan for the glass melter have been submitted for Ohio EPA approval. Mound has no current or planned onsite disposal facilities for mixed wastes. Table 3-8 lists the low-level mixed waste types and quantities in storage.

Table 3-6: 1993 Waste Generation at Mound

| Waste Type | Quantity Generated | Storage Capacity | Treatment Capacity | Disposal Method |
|-----------------|--|-------------------------|--------------------|-----------------------|
| LLW | | | | |
| Liquid | (1.5 million gallons alpha waste water) (30,000 gallons of tritium contaminated waste water) ^c | c | c | c |
| Solid | 210,000 ft ³ | 700,000 ft ³ | d | Offsite-DOE |
| TRU | 0 | | | |
| Liquid | 0 | 0 | none | none |
| Solid | 0 | 8950 ft ³ | none | none |
| Mixed | | | | |
| Liquid | 79 gal | 25,000 gal | None | None |
| Solid | 4.5 ft ³ | 1,600 ft ³ | None ^e | None |
| Hazardous/Toxic | | | | |
| Liquid | 19,000 gal | 13,365 gal | None | Offsite |
| Solid | 2,825 ft ³ | 2,880 ft ³ | a | Offsite |
| Non hazardous | | | | |
| Liquid | 47,400,000 gal | b | 47.5 MGY | Offsite-NPDES Outfall |
| Solid | 140,130 ft ³ | 21,492 ft ³ | None | Offsite |

- a Burn Area has treated an average of 42 ft³/yr of explosive/reactive wastes.
- b Additional capacity is obtained as required by renting commercial trailers.
- c The Waste Disposal Plant has four influent tanks having a combined storage capacity of 120,000 gallons of alpha waste water. On the average, 30,000 gallons per week of alpha waste water are treated and discharged to the great Miami River. Low-Level tritium contaminated liquid wastes (30,000 gallons per year) are solidified and disposed of as solid LLW.
- d Sludges produced in the clariflocculator from the above process are held in two 1,000-gallon tanks until solidified in 55-gallon drums.
- e If available, the glass melter thermal treatment unit would have a treatment capacity of 740 ft³/yr.

Table 3-7 Low-Level Waste Facilities at Mound

| Facility | Waste Managed | Facility Description |
|---|---|---|
| Waste Disposal Solidification (WD Bldg.) | Liquid Alpha Waste (Pu-238), Beta Waste | Equipment for coprecipitation/flocculation of waste, solidification of sludge, and adsorption/filtration of supernatant liquid |
| Staging Area (Bldg. 23) | Mixed Waste | One-story concrete block building, 14 ft high x 30 ft wide x 117 ft long, having a gross area of 3,500 ft ² |
| Staging Area (Bldg. 31) | Tritiated waste; TRU waste; non-TRU alpha waste | One-story sheet metal building, 12 ft high x 60 ft wide x 102 ft long having a gross area of 6,100 ft ² |
| | | |
| Waste Solidification Facility (SE-149) | Tritiated Waste | Tritiated liquid solidification and packaging for off-site shipment and burial |
| Effluent Removal System (SW) | Tritiated Waste | Air detritiation system removes tritium from process effluent streams before they are released to the atmosphere |
| Compactor (T-Bldg.) | Low Specific Activity (beta) | Hydraulic-ram compactor |
| Glass Melter (WDA) | (alpha, beta, gamma) | Development refractory chamber containing molten glass over which waste is burned, wet off-gas treatment system, and high efficiency filter used for line-generated wastes (Mound expects to permit the unit for use with radioactive mixed) |
| Compactor (SW Bldg.) | Low Specific Activity (beta) | Hydraulic-ram compactor |
| Equipment at Various Waste Generating Areas | Low-level alpha solid waste | Where practical, compactors are used to reduce waste volume in drums prior to shipment |

Source: Nonnuclear Consolidation Environmental Assessment and Mound Waste Management

Table 3-8 Mound Plant Low-Level Mixed Waste Types and Quantities in Storage

| Waste Type | Quantity |
|----------------------------------|--|
| Liquid Scintillation (vials) | 189 drums (1,418 ft ³) containing closed vials |
| Lead Residue and Bricks | One 30-gal drum of residue, two 30-gal drums of bricks; one 55-gal drum of lead scrap, two 5-gal 37-A cans of bricks and scrap, two 55-gal drums of RCRA corrosive TRU waste, two plywood boxes (strong, tight) containing waste batteries, one steel box (U.S. DOT 7A) containing lead waste; total volume waste lead - 185 ft ³ |
| Polychlorinated Biphenyls (PCBs) | 20 drums of solid, 14 drums of liquid, 1 box of solid (equipment-machine press); total volume PCBs - 250 ft ³ |
| Contaminated Mercury | Four containers totaling less than 3 liters |

Source: Nonnuclear Consolidation Environmental Assessment and Mound Waste Management

Hazardous/Toxic Waste Streams and Management.

Hazardous/toxic wastes are generated in several production and laboratory facilities at Mound. The quantity of the wastes can be found in Table 3-6 and are summarized as follows: 19,000 gallons and 2,825 cubic feet of liquid and solid hazardous waste; 47,400,000 gallons and 140,130 cubic feet of liquid and solid non hazardous waste; 30,000 gallons and 210,000 cubic feet of radioactive low level waste; 79 gallons and 4.5 cubic feet of liquid and solid mixed waste; and 8904 cubic feet of TRU waste. The disposal methods for each are summarized in Table 3-6 and the current storage/treatment facilities at Mound are listed in Table 3-10. Mound has submitted a revised RCRA Part A and B permit application which is currently being processed by the State. There are no active onsite disposal facilities for hazardous wastes at Mound. Wastes currently treated onsite are explosives and pyrotechnics. Approximately three hundred pounds of these materials are treated annually by open burning on a hearth inside a facility and by use of a retort (a vessel or chamber in which substances are distilled or decomposed by heat in a controlled manner). All other hazardous wastes (Table 3-6) are treated and disposed of offsite by RCRA-permitted commercial contractors. Prior to offsite shipment, all hazardous/toxic waste is packaged in DOT-approved containers, mostly 55-gal drums, manifested and shipped under contract with DOT-registered transporters to RCRA- or TSCA-permitted facilities for treatment or disposal depending on the waste form. Approximately 2,000 pounds per year of lead-acid batteries are also sent offsite for recycle or reuse. Mound has a program to monitor the offsite management of its hazardous wastes by commercial facilities on a regular basis. Records and manifests are maintained for all hazardous wastes picked up from Mound generators that are shipped offsite for treatment or disposal.

Table 3-9 Mound Plant Hazardous/Toxic Waste Nature and Handling Procedures

| Waste Stream and Quantity | Nature of Waste | Handling of Waste |
|---|---|---|
| Organic Solvents (approximately 80- 55 gallon drums) | Flammable Liquids | Picked up weekly, consolidated at staging area, and stored in steel drums in Bldg. 72 prior to offsite disposal |
| Waste Oils (approximately 36- 55 gallon drums) | Flammable or combustible liquids | Consolidated in 55-gal drums at operating area, and stored in Bldg. 72 for offsite disposal |
| Discarded Excess Paints and Thinners(approximately 25- 55 gallon drums) | Flammable or combustible liquids | Consolidated in 55-gal drums at operating area, and stored in Bldg. 72 for offsite disposal |
| Waste Corrosive Solutions(approximately 53- 55 gallon drums) | Mostly caustic and acid solutions | Consolidated in 55-gal or other size drums at operating area, and stored in Bldg. 72 for offsite disposal |
| Spent Plating-Bath Solution(approximately 75- 55 gallon drums) | Toxic liquid containing heavy metals | Consolidated in 55-gal or other size drums at operating area, and stored in Bldg. 72 for offsite disposal |
| Waste PCBs(approximately 107- 55 gallon drums) | Toxic liquid | Stored in marked cans or drums labeled and placed in Bldg. 72 for offsite disposal |
| Toxicity Characteristic Waste(approximately 8- 55 gallon drums) | Various liquid and solid wastes | Consolidated in 55-gal or other size drums at operating areas, and stored in Bldg. 72 for offsite disposal |
| Photo-Processing Waste(approximately 14- 55 gallon drums) | Waste containing precious metals, caustic solution, and acetic acid | Picked up weekly, consolidated into polyethylene-lined 55-gal drums and stored in Bldg. 72 for offsite disposal |
| Laboratory Wastes(approximately 122- 55 gallon drums) | Solvents; flammable, reactive, toxic liquids in small quantities | Packed in steel containers with vermiculite for incineration of Land-filling |

Source: Nonnuclear Consolidation Environmental Assessment and Mound Waste Management

Table 3-10 Mound Plant Hazardous Waste Storage and Treatment Facilities

| Facility | Use | Approximate Dimensions |
|---|---|--|
| Hazardous Waste Storage Facility (Bldg. 72) | Principal hazardous waste storage area | 40 ft x 60 ft; 10 ft high |
| Explosive Waste Storage Magazine 53 | Explosive waste storage bunker | 10 ft x 15.5 ft; 10 ft high |
| Pyro Shed Storage | Storage area for pyrotechnic materials | 9 ft x 15 ft; 7 ft high |
| Thermal Treatment of Explosive Waste | Drum unit for burning explosives-contaminated materials | 55-gallon drum in 10 ft x 10 ft x 10 ft structure |
| Open Burning of Explosive Waste | Apparatus for burning solid explosives-contaminated materials/scrap | Located in same structure with drum unit (above) |
| Retort | Unit for burning fabricated components/assemblies containing explosives | 3 ft diameter, 10 ft long |
| Pyro Waste Conversion Unit | Apparatus for treatment of pyrotechnic cleanup solutions | 1 ft diameter, 2 ft high cylinder in a 30 in x 30 in x 6 in tray |

Source: Nonnuclear Consolidation Environmental Assessment and Mound Waste Management

Non hazardous Waste Streams and Management.

Non hazardous wastes are generated routinely and include general plant refuse such as paper, cardboard, glass, wood, plastics, scrap, metal containers, etc. Non hazardous wastes are segregated and recycled whenever possible. Metallic and wood waste, stored in a salvage area, is sold periodically by lot sale as surplus. Trash is accumulated onsite and taken to the local sanitary landfill on a regular basis. For calendar year 1993 Mound generated approximately 59,500 cubic yards of uncompacted non-hazardous waste.

Impacts of the Proposed Action For Waste Management

Commercial enterprises that lease space at the Mound Plant would be bound through lease agreements to conduct their waste management operations independent of Mound's hazardous waste operations permit. Mound's treatment, storage and facilities would not be available to tenants. Any individual permits would be obtained by tenants prior to operations as required by Part I, 8A of the General Lease (Appendix A).

Emphasis would be placed on attracting operations to the plant that have already shown success with replacing hazardous process materials with non hazardous materials. An effort will be made to bring in processes with waste streams that are safe and compatible with Mound operations. It is expected that the Proposed Action would result in a slight change in specific types of hazardous

wastes, for example, manufacture of plastics may result in plastic resin wastes. Tenant operations that would exceed the total volumes show in Table 3.6 would not be considered as potential tenants or would be subject to further DOE NEPA review. Although tenants would not be expected to have waste volumes in excess above those listed in Table 3-6, the volumes will not go above those for the Mound Plant Alternative of the Nonnuclear Consolidation EA, (Ref 6), (Appendix D).

Volumes of radioactive wastes are expected to remain similar to those produced by current activities (30,000 gallons per week and 210,000 cubic feet of liquid and solid Low Level Waste), (Table 3-6).on page 35. Additional procedures and rules would be developed that apply to the specific waste types being generated. The subleases with prospective tenants would ensure adherence to these rules. All waste handling activities would be conducted in compliance with applicable Federal, State, and local requirements.

Impacts of Alternative 1

The impacts from Alternative 1 on generation of solid, hazardous, and radioactive wastes would be essentially the same as the current Mound Plant baseline shown in Table 3-6, (page 35). Waste reduction would be conducted as a continuation of ongoing waste minimization activities and would include, as appropriate, use of replacement materials for hazardous chemicals. If administrative activities replace current industrial operations, the volume of hazardous and radioactive wastes would be reduced in proportion to the contribution of the industrial operations that are removed. All waste handling activities would be conducted in compliance with all applicable Federal, State, and local requirements.

Impacts of the No Action Alternative

The impacts from the No Action Alternative would be a gradual decrease in the volume of solid, hazardous, and radioactive wastes. After D&D activities are completed, the volume of production-related hazardous and radioactive wastes would be reduced to near zero. The volume of solid wastes would be reduced to those nominal levels necessary to support maintenance, security, and ER activities.

3.6 Waters

3.6.1 Water Demand

Affected Environment

Three deep wells which extend into a Buried Valley Aquifer supply the plant with all water needs. . During 1993, the Mound Plant utilized approximately 231 million gallons of water (State of Ohio Water Withdrawal Facility Registration Annual Report Form, facility registration # 01572 EG&G Mound Applied Technologies).

Impacts of the Proposed Action

The impacts of the Proposed Action on water usage are not expected to be substantially different than those associated with operations currently being conducted at the Mound Plant. Lease agreements would be written so that new plant tenants would be financially responsible for a

proportional share of the water utility charges, (Appendix A). With the tenants' water usage costs directly proportioned to water utilization, it is expected that tenants would conserve water in order to be more cost effective. The MMCIC would be responsible for determining the share of water costs that are applicable to each tenant. The overall impact of the Proposed Action on Mound Plant water utilization would be to maintain, or slightly decrease, the current consumption rate.

Impacts of Alternative 1

The impacts from Alternative 1 on water usage would be essentially the same as the current Mound Plant consumption rate (i.e., the recent maximum water demand represented by the 231 million gallons used in 1993).

Impacts of the No Action Alternative

The impact from the No Action Alternative on water usage would be a gradual reduction of water utilization. D&D activities may require an initial period of increased water usage. After D&D activities are completed, water requirements would be limited to those associated with maintenance, security, and ER activities.

3.6.2 Groundwater

Municipal and industrial water supplies in the vicinity of the site depend upon high capacity wells drilled into unconsolidated sand and gravel aquifers. The principal aquifer in the area, the Buried Valley Aquifer, is composed of Pleistocene sand, gravel, and fine grained till. The Buried Valley Aquifer is located immediately west of the Mound facility, and does underlie the southwestern portion of the property. The maximum known thickness of the aquifer within the site boundary is approximately 70 ft. The aquifer thickens towards the Great Miami River and reaches a maximum thickness of approximately 150 ft near the river channel. Recharge to the Buried Valley Aquifer is available from direct infiltration from the great Miami River, leakage along the valley walls at the bedrock-outwash contact, precipitation and induced infiltration caused by hydraulic sinks due to pumping.

Water samples are periodically collected from community supplies in the surrounding area, private wells, and Mound's onsite wells. The wells onsite at Mound are analyzed for plutonium-238, uranium-233/234,-238, and tritium. Analyses show that plutonium concentration levels in all cases are well below DOE and EPA limits. Samples from some locations have been analyzed for uranium; concentrations and isotopic ratios are typical of naturally occurring background levels in the shales and other rocks of the area. Tritium levels are within EPA maximum contaminant levels. Table 3-11 summarizes the radionuclide concentrations found in the onsite production wells in 1993, (Ref 7).

Non radioactive pollutant levels are also within water quality criteria. The non radioactive (VOC) contaminant concentrations in onsite production wells are summarized in Table 3-12, (Ref 7).

Table 3-11 Radionuclide Concentrations in Mound Productions Wells, 1993

| Radionuclide | Well ID | No. of Samples | Max Concentration | Average Concentration | Average as % of EPA Standard |
|-------------------|---------|----------------|--------------------------------|--------------------------------|------------------------------|
| Tritium | 0071 | 40 | 3.2nCi/L | 1.4nCi/L | 7.0 |
| | 0271 | 39 | 2.1nCi/L | 1.6nCi/L | 8.0 |
| | 0076 | 46 | 1.7nCi/L | 1.1nCi/L | 5.5 |
| Plutonium-238 | 0071 | 11 | 3.28 x10 ⁻¹² µCi/mL | 0.88 x10 ⁻¹² µCi/mL | 0.06 |
| | 0271 | 10 | 4.03 x10 ⁻¹² µCi/mL | 0.46 x10 ⁻¹² µCi/mL | 0.03 |
| | 0076 | 12 | 3.0 x10 ⁻¹² µCi/mL | 0.47 x10 ⁻¹² µCi/mL | 0.03 |
| Plutonium-239,240 | 0071 | 11 | 2.45 x10 ⁻¹² µCi/mL | 0.82 x10 ⁻¹² µCi/mL | 0.07 |
| | 0271 | 10 | 3.35 x10 ⁻¹² µCi/mL | 0.60 x10 ⁻¹² µCi/mL | 0.05 |
| | 0076 | 12 | 1.15 x10 ⁻¹² µCi/mL | 0.20 x10 ⁻¹² µCi/mL | 0.02 |
| Uranium-233,234 | 0071 | 11 | 0.26 x10 ⁻⁹ µCi/mL | 0.22 x10 ⁻⁹ µCi/mL | 1.1 |
| | 0271 | 10 | 0.23 x10 ⁻⁹ µCi/mL | 0.19 x10 ⁻⁹ µCi/mL | 1.0 |
| | 0076 | 12 | 0.27 x10 ⁻⁹ µCi/mL | 0.23 x10 ⁻⁹ µCi/mL | 1.2 |
| Uranium-238 | 0071 | 11 | 0.22 x10 ⁻⁹ µCi/mL | 0.19 x10 ⁻⁹ µCi/mL | 0.8 |
| | 0271 | 10 | 0.20 x10 ⁻⁹ µCi/mL | 0.16 x10 ⁻⁹ µCi/mL | 0.7 |
| | 0076 | 12 | 0.24 x10 ⁻⁹ µCi/mL | 0.20 x10 ⁻⁹ µCi/mL | 0.8 |

Table 3-12 VOC Concentration in Mound Production Wells, 1993

| Well I.D | Compound | No. of Samples | Maximum concentration (µg/L) | MCL ^a (µg/L) |
|----------|----------------------------|----------------|------------------------------|-------------------------|
| 0071 | 1,1,1 - Trichloroethane | 7 | 1.4 | 200 |
| | cis - 1,2 - Dichloroethane | 7 | 17 | 70 |
| | Trichloroethene | 7 | 5.2 | 5 |
| | Tetrachloroethene | 7 | 0.7 | 5 |
| 0271 | Freon 113 | 7 | 3.0 | b |
| | 1,1,1 - Trichloroethane | 7 | 1.2 | 200 |
| | cis - 1,2 - Dichloroethane | 7 | 7.2 | 70 |
| | Trichloroethene | 7 | 1.8 | 5 |
| | Tetrachloroethene | 7 | 0.5 | 5 |
| 0076 | Freon 113 | 7 | 2.0 | b |
| | 1,1,1 - Trichloroethane | 7 | 0.6 | 200 |
| | cis - 1,2 - Dichloroethane | 7 | 3.0 | 70 |
| | Trichloroethene | 7 | 2.0 | 5 |

a MCL = Maximum Contaminant Level (based on EPA Primary Drinking Water Standards),(40 CFR 141-143).

b there is no MCL for Freon 113

Impacts of the Proposed Action, Alternative 1, and the No Action Alternative

The plant currently has a drainage control system which is capable of isolating and containing spills which may occur onsite. Therefore the Proposed Action, Alternative 1, and the No Action Alternative are not expected to have any impact on groundwater at the Mound Plant. Only environmental restoration activities, which are consistent through implementation of all three alternatives, would have any effect on groundwater systems, (a positive impact by removal or reduction of low level VOC contamination). The impact, therefore, of all three alternatives on site groundwater would be the same and would be negligible.

3.7 Threatened and Endangered Species

According to the Fish and Wildlife Service of the U.S. Department of the Interior (Letter, Kroonmeyer 1991; see Appendix B), the Mound Plant lies within the range of the Indiana Bat (*Myotis sodalis*), a federally listed endangered species. The bat has not been seen on-site. Shagbark hickories (common to southwest Ohio) and other live or dead trees with exfoliating bark may host the bat from May 1 through August 31. However, according to the Dayton Museum of Natural History, a field survey in April 1991 did not locate any shagbark hickories on-site (Letter, Hissong 1991; see Appendix B). During the time from May 1 through August 31, preconstruction site inspections are conducted to assess whether any potential host trees are present.

During ecological assessment activities conducted under the CERCLA program at the Mound Plant, a single specimen of Inland Rush (*Juncas interior weig*) was discovered growing on the Mound south property (Ref 14). The Inland Rush has been designated a state "endangered species" by the Ohio Division of Natural Areas and Preserves. Since the specimen is located on the south property which is outside the scope of this EA it has not been further considered.

According to existing records, no other rare or endangered species have been found at the proposed site or any alternative site (Letters, Hillmer 1992 and Kroonmeyer 1992; see Appendix B).

Impacts of the Proposed Action, Alternative 1, and the No Action Alternative

The Proposed Action, Alternative 1, and the No Action Alternative would not be expected to have any effect on threatened or endangered species in the area of the Mound Plant. Such species (other than the single specimen of Inland Rush, (*Juncas interior weig*) are not observed on the plant site, nor are they likely to be dependent on the site for food and habitat due to the commercial and residential development surrounding the plant.

3.8 Accident Analysis

Three accident scenarios have been analyzed which adequately characterize the risks associated with likely economic development business proposals. The proposals involve three different types of operations, with different hazards for each operations. The accident scenarios analyzed provide a spectrum of accidents in terms of the probability and consequence found in DOE Order 5481.1B Safety Analysis and Review System. The accidents analyzed include: 1) inadvertent ignition of 10 pounds of High Explosive during operations in Building 27, 2) inadvertent ignition of thermite powder during machining operations in Building 43 and 3) a spill of laboratory quantities of acid in the environmental analysis laboratory of E-Building. Greater detail on each of these scenarios is provided in sections 3.8.1, 3.8.2 and 3.8.3 of this EA.

One additional accident scenario involving the potential release of plutonium-238 Radioisotopic Thermoelectric Generator (RTG) fuel was examined for the NE operations which are scheduled to continue at the Mound Facility. The RTG plutonium-238 fuel is encapsulated in clads which have been designed to survive space shuttle launch and reentry accidents, (Ref 15). A safety analysis of the fuel clads concluded that the probability associated with breaching the cladding and subsequently exposing the fuel is less than 1×10^{-6} events/year; as a result of this extremely low probability of occurrence, the consequences of the accident were not further evaluated for the purposes of this EA. The facility in which the NE operations take place is a nuclear facility equipped to handle radioactive materials and operational accidents involving these materials. The conclusions of the safety analysis indicate that these NE operations can be conducted safely without considerable risk to the workers, public and environment. These operations are not expected to have any impacts on the proposed action described in this EA, nor is it anticipated that the proposed action would impact the NE operations.

Many types of hazards exist at the Mound Plant, (chemical, radiological, electrical, etc.) and management of these hazards, through the use of administrative and engineering controls, helps ensure that the risk associated with these hazards is low. In the event that the Mound Plant does experience an emergency condition, in compliance with DOE 5500.1B, Emergency Management System, and 5500.3A, Planning and Preparedness for Operational Emergencies, the Mound Plant has prepared a Site Emergency Plan. The emergency plan describes the site emergency management program, defines the plants emergency response capabilities, and integrates the response plans for specific types of accidents.

The Department of Energy and/or its representative will not provide safety oversight for tenant operations. Tenants will be required to comply with all applicable safety criteria as implemented through Occupational Safety and Health Agency (OSHA) regulations:

3.8.1 Inadvertent Ignition of 10 lbs of High Explosive in Building 27

Explosive operations conducted in Building 27 are conducted in individual bays. Operations include re-crystallization and wet blending of high explosives and oven or freeze drying of explosives. The explosive limits for these bays are administratively controlled at a maximum of 10 pounds of High Explosive. Additionally, no other personnel are permitted in the facility except those working directly in the operating bay and only one operation is allowed to be performed in the building at any given time. The inadvertent ignition of 10 pounds of high explosive is the maximum credible event for Building 27. The inadvertent ignition of 10 pounds of high explosive is considered an extremely unlikely event with resulting high consequences. The consequences of this event would result in considerable structural damage to the bay, over pressures sufficient to cause death to any workers in the bay at the time of ignition, and fragments being thrown from the facility as a result of perforation of the exterior structural walls. A fragment arc analysis shows that none of the fragments thrown from the facility would impact adjacent facilities (Ref 16).

3.8.2 Inadvertent Ignition of Thermite Powder During Machining Operations

Operations in Building 43 include the machining of consolidated metal-like thermites. Machining operations may involve removal of burrs, flashing or drilling holes into the consolidated

thermite. Operators performing the machining use a lathe or mill, both of which are protected within interlocked barriers. The inadvertent ignition of thermite during machining operations has been determined to be approximately 1×10^{-4} ignitions / operation with approximately 200 thermite machining operations / year, for a final annual frequency of inadvertent ignition of 0.02 ignitions / year. Assuming the interlock fails (highly unlikely) the consequences from an inadvertent ignition have been approximated at a 0.5 probability of severe injury or death to the operator. Occupants in the room farther than 3 meters away would most likely be safe (Ref 17). This accident would not have any effects on adjacent facilities or personnel outside of the thermite machining facility.

3.8.3 Spill Lab Quantity (1 gallon) of Concentrated Acid in the Environmental Analysis Lab

Lab quantities of chemicals are routinely handled in the environmental analysis laboratory located in E-Building. For this accident scenario, a technician is assumed to spill a 1 gallon container of concentrated acid onto the lab floor. This type of accident would be considered a high probability, low consequence event. The accident would be expected to potentially cause chemical burns to the technicians skin, and potential inhalation of toxic vapors. These consequences are mitigated by standard lab practices including protective clothing, safety glasses, safety showers and eye wash stations. The spill would initiate a response from Industrial Hygiene and would be cleaned up using standard lab hazardous material response techniques. This accident would not impact any adjacent facilities and would most likely involve only temporary evacuation of the lab in which the spill occurred.

4. Agencies, Organizations, and Persons Consulted

The Federal, State, and local agencies and other private organizations that were contacted during the preparation of this EA, or documents referenced in this EA, are listed below:

- City of Miamisburg, Richard Church, Mayor
- City of Miamisburg, Micheal Grauwelman, Manager of Mound Transition
- City of Miamisburg, Community Development Department
- Miamisburg Mound Community Improvement Corporation
- United States Department of Interior, Fish and Wildlife Service, Reynoldsburg Ohio Field Office, Mr. Kent Kroonemeyer, Field Supervisor
- Dayton Museum of Natural History, Mr. Thomas Hissong, Curator of Education.
- Ohio Department of Natural Resources, Ms. Jennifer Hillmer, Ecological Analyst, Division of Natural Areas and Preserves
- Ohio Department of Natural Resources, Mr. Stuart Lewis, Administrator, Ohio Scenic Rivers program, Division of Natural Areas and Preserves
- Ohio Historical Society, Ohio Historic Preservation Office, Ms. Judith Kitchen, Department Head Technical Review Services.
- U.S Army Corps of Engineers and U.S. Fish and Wildlife Service, Discussions on Delineation of Wetlands.

5.0 References

1. DOE/EA-0792, Nonnuclear Consolidation Environmental Assessment, Volumes I and II, U.S. Department of Energy Office of Defense Programs, June 1993.
2. Letter from Richard Claytor, (Assistant Secretary for Defense Programs), to Bruce Twinning, (Manager Albuquerque Field Office), regarding the Nonnuclear Consolidation Implementation Plan (Discussed the closing of the Mound, Pinellas and Rock Flats Plants), December 23, 1991
3. Memorandum for Headquarters and Field Elements of November 30, 1993, Subject: Future of the Task Force on Worker and Community Transition, From: Hazael R. O'Leary, The Secretary of Energy.
4. 1994 and 1995 National Defense Authorization Acts: Authorizes Federal Funding for Economic development Activities
5. Mound Plant Future Use Plan, EG&G Mound Applied Technologies, 12/21/93
6. Capabilities at Mound, Technology for the Future of this Country: EG&G Mound Applied Technologies, July 1993
7. Mound Site Environmental Report for Calendar Year 1993, August 1994.
8. Operable Unit 9, Hydrogeologic Investigation: Wetlands Determination Report, Mound Plant, U.S. Department of Energy, Albuquerque Operations Office, 1/94.
9. MLM-ML-93-0002, Mound Plant Construction Plan: EG&G Mound Applied Technologies, March 1993
10. Workforce Restructuring Plan, (3161 Plan), Dayton Area Office, May 2, 1994.
11. Personal communication with Mr. Thomas Hughes, Manager, EG&G Mound Applied Technologies, 9/94.
12. Executive Order 12898 of February 11, 1994, Federal Actions To Address Environmental Justice in Minority Populations and Low-Income Populations, Title 3 - The President.
13. 402-B-92-001, Users Guide for CAP88-PC, Version 1.1, U.S Environmental Protection Agency, March 1992.
14. Operable Unit 9, Ecological Characterization Report, U.S. Department of Energy, Albuquerque Operations Office, 3/94
15. Summary of General Purpose Heat Source Safety Tests, Letter from R.W. Zoicher, (Los Alamos National Laboratory), to Mr. James Lombardo,(DOE), March 11, 1986.
16. MLM-ML-94-42-0001, Structural and Operational Evaluation of Building 27, EG&G Mound Applied Technologies, Feb, 1994.
17. MLM-ML-93-47-0001, Safety Assessment of Building 43, EG&G Mound Applied Technologies, July, 1993.
18. Mound Plant Environmental Monitoring Plan, EG&G Mound Applied Technologies, July 18, 1994

6.0 List of Acronyms and Abbreviations

| | |
|--------|--|
| ACGIH | American conference of Governmental Industrial Hygienists |
| ALARA | As Low As Reasonably Achievable |
| ARAC | Atmospheric Release Advisory Capability |
| A AQCR | Air Quality Control Region |
| BOD | Biochemical Oxygen Demand |
| BVA | Buried Valley Aquifer |
| CAA | Clean Air Act |
| CEDE | Committed Effective Dose Equivalents |
| CERCLA | Comprehensive Environmental Response, Compensation and Liability Act |
| CFR | Code of Federal Regulations |
| Ci | Curie |
| CO | Carbon Monoxide |
| CRO | Community Reuse Organization |
| DCG | Derived Concentration Guidelines |
| D&D | Decontamination and Decommissioning |
| DOE | Department of Energy |
| DOT | Department of Transportation |
| DP | Defense Programs |
| EA | Environmental Assessment |
| EDE | Effective Dose Equivalent |
| EIS | Environmental Impact Statement |
| EM | Environmental Restoration and Waste Management |
| EOC | Emergency Operations Center |
| EPA | Environmental Protection Agency |

| | |
|--------|---|
| ER | Environmental Restoration |
| FBI | Federal Bureau of Investigations |
| FEIS | Final Environmental Impact Statement |
| FFA | Federal Facilities Agreement |
| FONSI | Finding of No Significant Impact |
| FY | Fiscal Year |
| HAP | Hazardous Air Pollutants |
| LANL | Los Alamos National Laboratory |
| LLW | Low Level Waste |
| MB | Miamisburg Area Office |
| MCL | Maximum Contaminant Level |
| MEDE | Maximum Effective Dose Equivalent |
| MMCIC | Miamisburg Mound Community Improvement Corporation |
| MRC | Mound Reuse Committee |
| NAAQS | National Ambient Air Quality Standards |
| NE | Office of Nuclear Energy |
| NEPA | National Environmental Policy Act |
| NESHAP | National Emission Standards for Hazardous Air Pollutant Sources |
| NOx | Nitric oxides |
| NPDES | National Pollutant Discharge Elimination System |
| OSHA | Occupational Safety and Health Act |
| OU | Operable Unit |
| PCB | Polychlorinated Biphenols |
| RAPCA | Regional Air Pollution Control Agency |
| RCRA | Resource Conservation and Recovery Act |
| ROI | Region of Interest |

| | |
|-----------------|---|
| RTG | Radioisotopic Thermoelectric Generator |
| SO _x | Sulfur dioxide |
| SIP | State Implementation Plan |
| TPY | Tons Per Year |
| TRU | Transuranic |
| TSCA | Toxic Substances Control Act |
| TSP | Total Suspended Particulate |
| TLV | Threshold Limit Value |
| USEPA | United States Environmental Protection Agency |
| VOC | Volatile Organic Compound |
| WD | Waste Disposal |

7.0 GLOSSARY

Administrative Controls: Procedures and standards that promote the safe operation of equipment or the safe performance of an operation.

Air Quality Control Region: An interstate area designated by the Environmental Protection Agency (EPA) for the attainment and maintenance of National Ambient Air Quality Standards.

Air Quality Standards: The level of pollutants prescribed by regulations that may not be exceeded during a specified time in a defined area.

Ambient Air: The surrounding atmosphere, as it exists around people, plants, and structures.

Aquatic Biota: The sum total of living organisms within any designated aquatic area.

Aquifer: A saturated geologic unit through which significant quantities of water can migrate under natural hydraulic gradients.

Archaeological sites (resources): Any location where humans have pre historically or historically altered terrain or discarded artifacts.

Atmospheric dispersion: The process of air emissions being dispersed in the atmosphere. This occurs by the wind that carries the pollutants away from their source and by turbulent air motion that results from solar heating of the earth's surface and air movement over rough terrain and surfaces.

Attainment Area: An area considered to have air quality as good as, or better than, the national ambient air quality standards as defined in the Clean Air Act (CAA). An area may be an attainment area for one pollutant and a non attainment area for others.

Baseline: A quantitative expression of conditions, costs, schedule, or technical progress to serve as a base or standard for measurement during the performance of an effort; the established plan against which the status of resources and the progress of a project can be measured. The environmental baseline is the site environmental conditions as they are projected to occur in a special time period.

Biochemical Oxygen Demand: The quantity of oxygen utilized in the biochemical oxidation of organic matter.

Carbon Monoxide (CO): A colorless, odorless gas that is toxic if inhaled in high concentration over a period of time.

Categorical Discharge Standard: A list of limits for a particular constituent in waste water that is associated with a specific type (category) of industrial process or activity. The EPA defines these limits. The limits are associated with compliance with 40 CFR Part 403, General Pre treatment Regulations for Existing and New Sources of Pollution.

Clean Air Act: Federal law mandating and enforcing air pollutant emissions standards for stationary sources and motor vehicles.

Clean Air Act Amendments (CAAA) of 1990: Expands the EPA enforcement powers and adds restrictions on air toxics, ozone depleting chemicals, stationary and mobile emissions sources, and emissions implicated in rain and global warming.

Clean Water Act (CWA): This law makes it illegal to discharge pollutants and dredged and fill material from a point source into navigable water of the U.S. except in compliance with the National Pollutant Discharge Elimination Standard (NPDES).

Code of Federal Regulations (CFR): All Federal regulations in force are published in codified form in the Code of Federal Regulations.

Committed Dose Equivalent (CDE): The predicted total dose equivalent to a tissue or organ over a 50-year period after intake of radionuclide into the body. It does not include external dose contributions. Committed dose equivalent is expressed in units of rem or (Sv).

Committed Effective Dose Equivalent (CEDE): The sum of the committed dose equivalents to various tissues in the body, each multiplied by the appropriate weighing factor. Committed effective dose equivalent is expressed in units of rem or (Sv).

Comprehensive Environmental Response, Compensation, and Liability Act (CERCLA or Superfund): A statutory framework for remediation of past contamination from hazardous waste.

Criteria Pollutants: Six air pollutants for which national ambient air quality standards are established by EPA: sulfur dioxide, nitric oxides, carbon monoxide, ozone, particulate matter (smaller than 10 microns in diameter), and lead.

Cumulative Impacts: An impact on the environment that results from the incremental impact of the action when added to other past, present, and reasonably foreseeable future actions regardless of what organization or person undertakes such other actions. Cumulative impacts can result from individually minor but collectively significant actions taking place over a period of time.

Curie: The official unit of radioactivity, defined as exactly 3.70×10^{10} disintegrating atoms per second. This decay rate is nearly equivalent to that exhibited by one gram of radium in equilibrium with its disintegration products.

Decommissioning: Removing facilities contaminated with radiation, such as processing plants, waste tanks, and burial grounds, from service and reducing or stabilizing radioactive contamination. Decommissioning includes the following concepts: 1) decontamination, dismantling, and return of an area to its original condition without restrictions on use or occupancy, and 2) partial decontamination, isolation of remaining residues, and continued surveillance and restrictions on use or occupancy.

Decontamination: The removal of radioactive or chemical contamination from facilities, equipment, or soils by washing, heating, chemical or electrochemical action, mechanical cleaning, or other techniques.

Derived Concentration Guide: The concentration of a radionuclide in air or water which, under conditions of continuous exposure by one exposure mode (i.e., ingestion of water or submersion or inhalation of air), for one year, a "Reference man" would receive the most restrictive of 1) and

effective dose equivalent or 100 mrem (1mSv), or 2) a dose equivalent of 5 mrem (50 mSv) to any tissues, including skin and lens of the eye.

Direct Economic Effects: The initial increases in output from different sectors of the economy resulting from some new activity within a predefined geographic region.

Dose Equivalent: The product of absorbed dose in rad (or Gy) in tissue (quality factor). Dose equivalent is expressed in units of rem (or Sv, where 1 rem = 0.01 Sv)The dose equivalent to an organ, tissue, or the whole body will be that received from the direct exposure plus the 50-year committed dose equivalent received from the radionuclides taken into the body during the year.

Drinking Water Standards: The prescribed level of constituents or characteristics in a drinking water supply that cannot be exceeded legally.

Effective Dose equivalent (EDE): The summation of the products of the dose equivalent received by specified tissues of the body and a tissue-specific weighting factor. This sum is a risk-equivalent value and can be used to estimate the health effects risk of the exposed individual. The tissue-specific weighting factor represents the fraction of the total health risk resulting from uniform whole-body irradiation that would be contributed by that particular tissue. The EDE includes the CEDE from the internal deposition of radionuclides, and the EDE due to penetrating radiation from sources external to the body. EDE is expressed in units of rem (or Sv)

Effluent: A gas or fluid discharged into the environment.

Emission Standards: Legally enforceable limits on the quantities and/or kinds of air contaminants that can be emitted into the atmosphere.

Energetic Materials: high explosives, pyrotechnics, and propellants.

Engineering Controls: Designed systems or modifications that are made to equipment, utilities, or ergonomic features within a workplace that promote the safe use of such equipment or reduce the possibility that an accident will occur involving the equipment.

Endangered Species Act: Established in 1973, this act requires Federal Agencies, with the consultation and assistance of the Secretaries of the Interior and Commerce, to insure that their actions will not likely jeopardize the continued existence of any endangered or threatened species of adversely affect the habitat of such species.

Endangered Species: Animals, birds, fish, plants, or other living organisms threatened with extinction by man-made changes in their environment. Requirements for declaring endangered species are contained in the Endangered Species Act.

Environmental Assessment (EA): A written environmental analysis which is prepared pursuant to the National Environmental Policy Act (NEPA) to determine whether a proposed Federal action may significantly affect the environment and thus require preparation of a more detailed Environmental Impact Statement (EIS). If the proposed action would not significantly affect the environment, then a FONSI is prepared.

Environmental Impact Statement (EIS): A document required of Federal agencies by NEPA for major proposals or legislation significantly affecting the environment. A tool for decision making, it describes the positive and negative effects of the undertaking and alternative of actions.

Exceedance: Violation of environmental protection standards by exceeding allowable limits or concentration levels.

Finding of No Significant Impact: A document by a Federal agency briefly presenting the reasons why a proposed action, not otherwise excluded, would not have a significant effect on the human environment and would not require preparation of an Environmental Impact Statement.

Floodplain: The lowlands adjoining inland and coastal waters and relatively flat areas including at a minimum that area inundated by a 1 percent chance or greater chance of flood in any given year. The base floodplain is defined as the 100 year (1 percent) floodplain. The critical floodplain is defined as the 500 year (0.2 percent) floodplain. "Critical Action" means any activity for which even a slight chance of flooding would be too great. Such actions may include the storage of highly volatile, toxic, or water reactive materials.

General Public: Individuals who are normally at and beyond the DOE facility boundary; includes individuals who are on DOE facility open-access way (roads, rivers, creeks, railways, etc.)

Glass Melter: A development refractory chamber containing molten glass over which the waste is burned.

Groundwater: The supply of fresh water found beneath the Earth's surface, usually in aquifers, which is often used for supplying wells.

Guideline Level: A suggested, desired level of concentration. it is not a regulatory value, but is a value offered as desirable by an agency to protect human health or the environment.

Hazardous Material: A substance or material, including a hazardous substance, which poses a risk to health, safety, and property when transported or handled.

Hazardous/toxic waste: Any solid waste (can also be semisolid or liquid, or contain gaseous material) having the characteristics of ignitability, corrosivity, toxicity, or reactivity, defined by the RCRA and identified or listed in 40 CFR 261 or by the Toxic Substances Control Act (TSCA).

Historic Resources: Archaeological sites, architectural structures, and objects produced after the advent of written history dating to the time of the first Euro-American contact in the area.

Low Level Waste (LLW): Waste that contains radioactivity, but is not classified as high-level waste, transuranic waste, spent nuclear fuel, or "11e(2) by-product material" as defined by DOE 5820.2. Test specimens of fissionable material irradiated for research and development only, and not for the production of power or plutonium, may be classified as low-level waste, provided the concentration of transuranic waste is less than 100 nCi/g. Some LLW is considered classified because of the nature of the generating process and/or constituents, as the waste would tell too much about the process.

Maximum Contaminant Level (MCL): The maximum permissible level of a contaminant in water delivered to any user of a public water system. MCLs are enforceable standards.

Millirem: A unit used to represent the radiation dose for biological absorption. It is one-millionth of a rem (see rem in this glossary).

Mixed Wastes: Waste that contains both hazardous and radioactive waste

National Environmental Policy Act (NEPA, 1969): The basic national charter for the protection of the environment. Its main purpose is to provide environmental information to federal decision makers so that their actions are based on an understanding of the potential environmental consequences of a proposed action and its reasonable alternatives.

National Ambient Air Quality Standards (NAAQS): Air quality standards established by the Clean Air Act. The primary NAAQS are intended to protect the public health with an adequate margin of safety, and the secondary NAAQS are intended to protect the public welfare from any known or anticipated adverse effects of a pollutant.

National Emission Standards for Hazardous Air Pollutants: A set of national emission standards for listed hazardous pollutants emitted from specific classes or categories of new and existing sources. These were introduced in the Clear Air Act Amendments of 1977.

National Pollutant Discharge Elimination System (NPDES): Federal permitting system required for hazardous effluents regulated through the Clean Water Act.

Nonattainment Area: An air quality control region, or portion thereof, in which the U.S. Environmental Protection Agency has determined that ambient air concentrations exceeded national ambient air quality standards for one or more criteria pollutants.

Nuclear Production: production operations for components of nuclear weapons that are not fabricated from plutonium, uranium, or other special materials. Raw material stock may include tritium.

NOx: Refers to the oxides of nitrogen, primarily NO and NO₂. These are produced in the combustion of fossil fuels and can constitute an air pollution problem.

Outfall: The discharge point of a drain, sewer, or pipe as it empties into a body of water.

Ozone (O₃) The triatomic form of oxygen; in the stratosphere, ozone protects the earth from the sun's ultraviolet rays, but in lower levels of the atmosphere, ozone is considered an air pollutant.

pH: A measure of the hydrogen ion activity in an aqueous solution; specifically, the negative logarithm of the hydrogen ion concentration. Acidic solutions have a pH from 0 to 7; basic solutions have a pH greater than 7.

picocuries (pCi): One picocurie is equal to 1 x 10⁻¹² curies.

Plume: The elongated pattern of contaminated air or water originating at a point-source, such as a smokestack or a hazardous waste disposal site.

Plutonium: A heavy, radioactive, metallic element with the atomic number 94. It is produced artificially in a reactor by bombardment of uranium and is used in the production of nuclear weapons.

Pyrotechnic: physical mixture of finely divided fuels and oxidizer powders which produce a rapid exothermic reaction when ignited

Radioisotopic Thermoelectric Generators (RTG): An electric generator using a thermocouple with the decaying heat of encapsulated plutonium-238 as its heat source.

Radioactive Waste: Materials from nuclear operations that are radioactive or are contaminated with radioactive materials, for which use, reuse, or recovery are impractical.

Radiological/Radionuclide: A radioactive element characterized according to its atomic mass and atomic number which can be man-made or naturally occurring. Radioisotopes can have a long life as soil or water pollutants, and are believed to have potentially mutagenic effects on the human body.

Rem: The unit of radiation dose for biological absorption: equal to the product of the absorbed dose in rads, a quality factor, and a distribution factor.

Resource Conservation Recovery Act: A "cradle to grave" regulatory program for hazardous waste which established, among other things, a system for managing hazardous waste from its generation to its ultimate disposal.

Retort: A container in which substances are distilled or decomposed by heat.

Risk: A term used to identify the combination of the likelihood (probability) and the consequence (severity) of an accident. Risk is typically quantified into the categories of low, medium, and high.

Sanitary Wastes: Any waste, liquid or solid (includes sludge), which is neither a RCRA regulated waste, a TSCA regulated waste, nor radioactive.

Scientific Notation: A form of numerical notation used to describe extremely high or extremely low values in a systematic manner. Scientific notation is written as the product of a factorial of ten and a base numerical value. For example, 5,000 is written as 5×10^4 , while 0.005 is written as 5×10^{-3} .

Sulfur Dioxide (SO₂): A heavy, pungent, colorless gas (formed in the combustion of coal), which is considered a major air pollutant.

Surplus: Any equipment, facility, building, or site that has no identified or planned programmatic use as determined by the program secretarial office currently administering the program.

Threshold limit values (TLV): The recommended concentration of airborne contaminants workers may be exposed to according to the American Council of Governmental Industrial Hygienists.

Tritium: A radioactive isotope of the element hydrogen with two neutrons and one proton. Common symbols for the isotope are H³ and T.

Transuranic (TRU) Waste: Waste contaminated with alpha-emitting radionuclides with half-lives greater than 20 years and concentrations greater than 100 nanocuries/gram at a time of assay. It is not a mixed waste.

Uranium: A heavy (atomic mass = 238.03) silvery-white metal with 14 radioactive isotopes. Uranium-235 is most commonly used as a fuel for nuclear fission. Another isotope, uranium-238, is transformed into fissionable plutonium-239 following its capture of a neutron in a nuclear reactor.

Water Quality Standard and Criteria: Concentration limit of constituents or characteristics allowed in water; often based on water use classifications (e.g. , drinking water, recreation use, propagation of fish and aquatic life, and agricultural and industrial use).

Wetland: Wetlands are defined by the Corps of Engineers and EPA as:

"Areas that are inundated or saturated by surface water or groundwater at a frequency and duration sufficient to support, and that under normal circumstances do support, a prevalence of vegetation typically adapted for life in saturated soil conditions. Wetlands generally include swamps, marshes, bogs, and similar areas' (40 CFR 230.3 and 33 CFR 328.3)

Volatile Organic Compounds (VOC): A broad range of organic compounds, often halogenated, that vaporize at ambient or relatively low temperatures, such as benzene, chloroform, and methyl alcohol.

Appendix A

Lease Exhibit and Ohio EPA Concurrence Letter

U. S. DEPARTMENT OF ENERGY
GENERAL PURPOSE LEASE
PART I

This Lease, entered into this ____ day of _____, 1994, between the UNITED STATES OF AMERICA, acting by and through the Department of Energy, hereinafter referred to as the "GOVERNMENT," and The Miamisburg Mound Community Improvement Corporation, hereinafter referred to as the "LESSEE,"

W I T N E S E T H:

1. That the Secretary of Energy, under the authority of Section 649 of the Department of Energy Organization Act (Public Law 95-91), and the National Defense Authorization Act of 1994 (Public Law 103-160) Section 3154, having determined that the property hereby leased is not excess property as defined by Section 3(e) of the Federal Property and Administrative Services Act of 1949, as amended (40 U.S.C. 472), is not for the time needed for public use, and the leasing thereof will be advantageous to the Government and in the public interest, hereby leases to the Lessee the property described in Exhibit "A", as may be amended from time to time by the parties by designation Amendment A1, Amendment A2, etc. each of which to be included herein, (hereinafter referred to as the "LEASED PROPERTY") located at the Government's Mound Facility, One Mound Road, Miamisburg, Ohio (hereinafter referred to as the "INSTALLATION,") as described in Exhibit "B," as may be amended by the parties from time to time as Amendment B1, Amendment B2, etc., attached hereto and made a part hereof.
2. Included within Exhibit A, as appropriate, is a map and description of the land and improvements (herein after referred to as "REAL PROPERTY") (Article 1), inventory of personal property and related personal property (Article 2), limits of operations within the Leased Property not addressed in Part II, General Provisions (Article 3), description and charges for utility, maintenance, and other services not covered under Part II, General Provisions (Article 4), real property condition report (Article 5), and a Phase I Environmental assessment (Article 6). Sections are subdivided by building or predominate building within a logical grouping of buildings, as appropriate.
3. Included within Exhibit B, as appropriate, is a map of the installation depicting common areas to include means of ingress and egress, and restricted areas (Article 1), limits of operations within common areas (Article 2), and a map depicting potential environmental release sites (Article 3).
4. The term of this Lease shall begin on _____, 1994 and end on _____, 1999, unless sooner terminated in accordance with the provisions of section E or F of Part II of this Lease, General Provisions.
5. The Lessee shall pay the Government an annual rate of \$ 1.00. The rent shall be payable \$1.00 per year in advance , in conformity with the provisions of Article X of Part II of this Lease, General Provisions. This Lease may be renewed at the option of the Lessee for an additional term of five (5) years at the following rentals: option to renew for the five (5) year period at One Dollar (\$1.00) per year, provided the Lessee delivers a written notice of intent to the Local Government Representative at least ninety (90) days before the end of the then current term.

6. The sole purpose for which the Lessee shall use the Leased Property is: To support Economic Development as part of the mission of the Department of Energy. For the purpose of this lease, Economic Development includes, but shall not be limited to the following: activities relating to furthering the employment of current employees; creating or enhancing new business opportunities at the facility or in the surrounding community; providing funding for such activities; and educating the employees or the community regarding such activities. The Lessee must obtain the written approval of the Department of Energy prior to using the Leased Property for any other purpose other than that specified above. The Government hereby gives the Lessee the permission to sublease the Leased Property. The Lessee shall present any potential subleases to the Government for approval prior to any sublease taking effect. Subleasing the Leased Property does not release the Lessee of any responsibilities stated in this Lease. The approval of the Government shall be related to requirements specified in this Lease and ancillary documents, and shall not be unreasonably withheld.
7. Lessee shall procure and maintain, at its own expense, the following insurance coverage: (1) Leased Property loss and damage; (2) Individual Bodily Injury and Property Damage, and (3) Business Interruption Insurance in accordance with the provisions of Section B of Part II, General Provisions.
8. There are hereby incorporated into this Lease, the following specified provisions which shall be controlling in the event of any conflict with Part II, General Provisions of this Lease:
 - A. It is agreed that the Sub-lessee shall obtain and comply in all respects with regulatory agency permits during the term of this Lease. Any excursion of permit requirements that are the fault of the Lessee or its Sub-lessee or Sublessees and that result in fines or penalties will be the responsibility of the Lessee to the extent caused by the Lessee or its Sublessee or Sublessees. If the Lessee should fail to comply with the terms of any operating permits and thereafter fails to take appropriate measures to achieve compliance, DOE shall have the right to stop operations. Operations will resume only after review and approval by DOE, which approval shall be based upon reasons directly related to the failure, and shall not be unreasonably withheld based upon that criteria.
 - B. The government is charging the Lessee \$1 annually for the lease, plus utility, maintenance, and other service charges as specified in Exhibit A, Article 4, and summarized in Exhibit C. The charges will not begin until the property is subleased. In the event of default by a Sublessee, Lessee shall have the option of holding the property, or returning the property back Government for decommission and decontamination, in which case, the charges will cease. In the event the Lessee holds the property, the utility, maintenance, and other service charges will continue to be paid, and the Government will undertake all reasonable measures to reduce these charges. The Lessee is permitted to charge rent for its subleased property, but any rent that is collected which exceeds Lessee's cost must be reinvested into economic development endeavors in the Mound Surrounding Community. The Lessee shall report semi-annually to the DOE its uses for such economic redevelopment and associated dollars.

C. It is agreed by the Lessee that all leased property will be returned to the same state of environmental cleanliness which was defined in Exhibit A, Article 6. The state of environmental cleanliness shall be determined by a Phase I environmental assessment and, if deemed necessary by the Government in the exercise of reasonable discretion, by a Phase II environmental assessment. The Facility Condition Report will be provided to the DOE within 30 days after the termination of sub-leases. All cost associated with determining the environmental status and remedies associated to bring the facility to the same environmental state as defined in Exhibit A, Article 6 are the responsibility of the Lessee.

D. Security measures will be determined on a building-by-building basis according to the nature of the activities undertaken by the DOE within the particular security zone. Detailed in Exhibit A, Article 3 are the particular requirements for the Leased Property. Reasonable access to all buildings and areas involved in this Lease shall be available at all times, including twenty-four (24) hours per day. The Leased Property is subject to searches, vehicles must be registered, and security badges may be required as by the Government.

9. For the purpose of this Lease, the Local Government representative is Larry D. Kirkman, Director, Miamisburg Area Office, Department of Energy and notices as required hereunder shall be forwarded to U.S. Department of Energy, Miamisburg Area Office, P.O. Box 66, Miamisburg, Ohio, 45343.

For the purpose of this Lease, the Lessee Representative is John Weithofer and notices as required hereunder shall be forwarded to C/O Miamisburg Mound Community Improvement Corporation, 10 N. First St., P.O. Box 570, Miamisburg, Ohio 45343.

IN WITNESS WHEREOF, the parties hereto have caused this Lease to be executed on their behalf by their duly authorized representative as of this date first above written.

Signed and Acknowledged
in the Presence of:

MIAMISBURG MOUND COMMUNITY IMPROVEMENT CORPORATION

By _____
Title _____

THE UNITED STATES OF AMERICA

By _____
Title _____

STATE OF)
) SS:
COUNTY OF)

The foregoing instrument was acknowledged before me this ___ day of
_____, 1994 by _____ as _____ of The
Miamisburg Mound Community Improvement Corporation, a _____ corporation, on
behalf of the corporation.

Notary Public

STATE OF)
) SS:
COUNTY OF)

The foregoing instrument was acknowledged before me this ___ day of
_____, 1994 by _____, as _____ of The
United States of America, on behalf of the United States of America.

Notary Public

U.S. DEPARTMENT OF ENERGY
GENERAL PURPOSE LEASE

GENERAL PROVISIONS
PART II

A. General Maintenance Obligation

- (1) The government at its own expense, shall provide maintenance services at the level associated with facilities in a long term reserve state. These services are limited to the minimum maintenance measures necessary to preserve the exterior superstructure of all buildings in their present condition, as defined by Exhibit A, Article 5. Additionally, the government, at its own expense shall maintain, repair and replace as necessary all common means of ingress or egress within the installation; provided, however, that the Government and Lessee recognize that the roads do not meet the Department of Transportation's load bearing standards. The Lessee at its own expense shall, maintain, and repair the Leased Property, that the same will at all times be kept in at least as good condition as when received hereunder, subject, however, to ordinary wear and tear and loss or damage for which Lessee is not liable hereunder. Lessee shall insure the structure(s) as provided in section 7 on page two of Part I of the Lease.
- (2) In the event that the Government shall furnish the Lessee with maintenance services over and above the minimum services as defined above, then the Lessee shall pay the government the charges therefor in addition to the cash rent required under this Lease.

Such charges are defined in detail in Exhibit A, Article 4. A summarization of such charges as well as the details for payment are described in Exhibit C.

B. Insurance

- (1) Lessee shall procure and maintain, at its own expense, insurance on the Leased Property in such initial amounts and types to cover the estimated replacement value of the Leased Property and Personal Property as defined in Exhibit A, liability associated with bodily injury individual property, and continuance of government services in the event of business interruption. The following minimum amounts shall be provided:

| TYPE | MINIMUM AMOUNTS |
|--|---|
| Property Damage and Loss (incl. fire, extended coverage, malicious mischief) | - \$100/SF Leased Property structures (per Exhibit A, Article 1) or an amount agreed to by the Local Government Representative - Personal Property Book Value (per Exhibit A, Article 2) |
| Individual Bodily Injury and Property Damage | - \$300,000/\$500,000 |
| Business Interruption Insurance | - 4 months of utility, maintenance, other service charge (by building or logical grouping of buildings as established in Exhibit A) |

- (2) All insurance which this Lease requires to be carried on the Leased Property shall be with such insurers as the Government may from time to time approve. Each policy of insurance shall contain a provision for thirty (30) days written notice to the Local Government Representative prior to the making of any material change in or the cancellation of the policy. Lessee shall deliver promptly to the Local Government Representative a certificate of insurance or a certified copy of each insurance policy required by this Lease and shall also deliver to him, no later than thirty (30) days prior to the expiration of any such policy, a certificate of insurance or a certified copy of each renewal policy covering the same risks. All insurance required or carried by Lessee on any of the Leased Property shall be for the protection of the Government and Lessee against their respective risks and liabilities in connection with the Leased Property.

Each policy of insurance against loss of or damage to the Leased Property shall contain a loss payable clause reading as follows:

"Loss, if any, under this policy shall be adjusted with the Lessee and the Government and shall be payable to the Government; and proceeds not needed for any repair or replacement shall belong to the Government.

C. Condition of Leased Property

- (1) Lessee has examined, knows, and accepts the condition and state of repair of the Leased Property and the Installation of which it forms a part, and acknowledges that except as set forth in Exhibit A, Part 2 the Government has made no representation concerning such condition and state of repair, nor any agreement or promise to alter, improve, adapt, repair, or keep in repair the same, or any item thereof, which has not been fully set forth in this Lease which contains all agreements made and entered into between Lessee and the Government.
- (2) The Government has provided Lessee with all current information concerning environmental conditions on the Leased Property. Such information is and has been readily available in a CERCLA reading room in the City of Miamisburg. The Government makes no representation concerning the environmental condition of the Leased Property outside the information provided in said reading room or in the Condition Report as shown in Exhibit A as appropriate for the particular structure.
- (3) The Government has entered a Federal Facilities Agreement (FFA) which describes the activities the Government intends to undertake in regard to environmental conditions at the Installation. No representations are made concerning further activity on behalf of the Government, either in regard to environmental conditions or otherwise. Financial responsibility for compliance with the FFA shall remain with the Government, except as noted in paragraph (H) (2) of this part.

D. Existing and Future Easements and Rights of Way

This Lease is subject to all outstanding easements and rights of way over, across, in, and upon the Leased Property, or any portion thereof, and to the right of the Government to grant such additional easements and rights of way over, across, in, and upon the Leased Property as the Government shall determine to be in the public interest, provided, that any such additional easement or right of way shall not unreasonably interfere with Lessee's right of peaceful occupancy. There is hereby reserved to the holders of such easements and rights of way as are presently outstanding or which may hereafter be granted, to any workers officially engaged in the construction, installation, maintenance, operation, repair, or replacement of facilities located thereon, to operations under any Federal Contract, and to any Federal, State, or local official engaged in the official inspection thereof, such reasonable rights of ingress and egress over the Leased Property as shall be necessary for the performance of their duties with regard to such facilities. The Government makes no representation of the capability of any right of way or easement for any purpose.

E. Termination by Government

The Government may terminate this Lease under the terms and conditions of this Article E.

- (1) If Lessee fails to perform any of the terms or conditions of this Lease and not cure the failure within thirty (30) calendar days after receipt of written notice from the Government specifying the failure, the Government may elect to terminate this Lease and no adjustment of any advance rentals paid by Lessee shall be made, and the Government shall be entitled to recover and Lessee shall pay to the Government:
 - (a) The costs incurred in resuming possession of the Leased Property.
 - (b) The costs incurred in performing any obligation on the part of Lessee to be performed hereunder.
 - (c) An amount equal to the aggregate of all rents and charges assumed hereunder and not theretofore paid or satisfied, less the net rentals, if any, collected by the Government on the reletting of the Leased Property, which amounts shall be due and payable at the time when such rents, obligations, and charges would have accrued or become due and payable under this Lease.
- (2) In the event of a National Emergency and the Government requires immediate possession of the Leased Property or a portion thereof, the Government may terminate this Lease, and Lessee shall be entitled to:
 - (a) An equitable adjustment of any advance rentals or charges paid by Lessee hereunder.
 - (b) Lessee may also be entitled to reimbursement or the following expenses when caused to vacate the Leased Property under provisions of this Article E (2):
 1. Packing and unpacking, crating and uncrating of personal property.

2. Storage of personal property for a period generally not to exceed three (3) months, when the Local Government Representative determines that storage is necessary in connection with the relocation. The three (3) month period shall be counted from the date of receipt by Lessee of written notice from the Local Government Representative to vacate.
3. Transportation of personal property from the Leased Property to the replacement site, not to exceed a distance of fifty (50) miles, except where the Local Government Representative determines that relocation beyond fifty (50) miles is justified.
4. Insurance premiums covering loss and damage of personal property while in storage or transit.
5. Other reasonable expenses determined to be allowable and approved by the Local Government Representative.
6. Prior to the payment of expense, Lessee shall be required to agree, in writing, that (i) the property is personalty and (ii) that the Government is released from any additional claims for reimbursement of relocation expenses.

F. Damage or Destruction. If, during the term of this Lease, the Leased Property, or any part thereof, is damaged by fire or other casualty so as to be rendered untenable either in whole or in part, and cannot reasonably be restored to substantially its former condition within one hundred twenty (120) days following such fire or other casualty, then either the Government or the Lessee may terminate this Lease as to the portion of the Leased Property so damaged effective the date of such casualty by giving notice to the other within thirty (30) days following such casualty. If the Lease is so terminated, the proceeds of insurance shall belong to the Government. In the event of any such damage which does not render all or any portion of the Leased Property untenable, either in whole or in part, or if neither party terminates pursuant to the preceding provisions, Government shall, with all due diligence, repair and restore the damaged area or areas to substantially the same condition they were in prior to such casualty. Such restoration shall be commenced and completed as quickly as is reasonably possible. In making such restoration, the Government is entitled to use the proceeds of the insurance specified in Part 1 section 7. Also during the time of such restoration, the rent shall be abated to the extent that all or any portion of the Leased Property is not usable by the Lessee.

G. Surrender

Upon the expiration of this Lease or its prior termination, Lessee shall quietly and peacefully remove itself and its property from the Leased Property and surrender the possession thereof to the Government; provided, in the event the Government shall terminate this Lease upon less than sixty (60) days notice, Lessee shall be allowed a reasonable period of time, as reasonably determined by the Local Government Representative, but in no event to exceed sixty (60) days from receipt of notice of termination, in which to remove all of its property from and terminate its operations on the Leased Property. During such period prior to surrender, all obligations assumed by Lessee under this Lease shall remain in full force and effect; provided, however, that if the Local Government Representative shall, in his sole discretion, determine that such action is equitable under the circumstances, he may suspend, in whole or in part, any further accruals of rent between the date of termination of the Lease and the date of final surrender of the Leased Property.

H. Restoration of Leased Property

Before the expiration or prior termination of this Lease, at the direction of the Local Government Representative, Lessee shall restore the Leased Property and each item thereof to the condition in which it was received, or to such improved condition as may have resulted from any improvement made therein by the Government or by Lessee during the Lease term, subject however, to ordinary wear and tear and loss or damage for which Lessee is not liable hereunder; provided, in the event the Government shall terminate this lease upon less than sixty (60) days notice Lessee shall have sixty (60) days from receipt of notice of termination to accomplish such restoration, or such additional time as the Local Government Representative may determine is fair and reasonable.

I. Installation, Alterations, and Removals

- (1) It is expressly agreed and understood that Lessee will make no permanent alterations, additions, or betterments to or installations upon the Leased Property without the prior written approval of the Local Government Representative, and then only subject to the terms and conditions of such approval which may include an obligation of removal and restoration upon the expiration or termination of this Lease, as the Local Government Representative may direct. Except insofar as said terms and conditions may expressly provide otherwise, all such alterations, additions, betterments, and installations made by Lessee shall remain the property of Lessee.
- (2) During the term of this Lease, or any extension thereof, with the prior written approval of the Local Government Representative, Lessee shall have the right, at its own expense, to install such improvements and additions and to attach such removable fixtures in or upon the Leased Property pursuant to this Lease, and to remove same at any time prior to the expiration or termination of this Lease or any extension thereof; provided, that in the event of termination by the Government upon less than sixty (60) days notice Lessee shall, as may be directed by the Local Government Representative and at the sole discretion of the Local Government Representative remove such items within sixty (60) days from the receipt of notice of termination. All property not so removed shall be deemed abandoned by Lessee and may be used or disposed of by the Government in any manner whatsoever without any liability to account to Lessee therefor, but such abandonment shall in no way reduce any obligation of Lessee to perform restoration under Article H of this Part II. In the event that the Leased Property is not restored to the condition at the time of Lease commencement, ordinary wear and tear excepted, then the Government may cause the Leased Property to be restored at the sole expense of Lessee.
- (3) The Government and the Lessee agree that the Lessee may erect one or more monument signs in appropriate locations on government property. These signs will be at one or more locations and will be consistent with size and quantity sign regulations of the City of Miamisburg. The number and location of these signs shall be decided by mutual agreement between the Government and the Lessee, and both parties shall be reasonable in reaching that mutual agreement.

J. Allocation of Liability.

- (1) Lessee covenants that it shall indemnify the Government with respect to any and all claims, demands, causes of action, proceedings, judgments or suits, and all liabilities, losses, damages, costs or expenses (including without limitation technical consultant fees and reasonable attorneys fees) which may arise from or be incident to (i) the use and occupancy by Lessee of the Leased Property; (ii) damages to the Leased Property or injuries to or death of the person of Lessee's officers, agents, servants, employees, or others who may be on said premises at their invitation or the invitation of any one of them, while this Lease is in effect; (iii) any "release" as defined in Section 101(22) of CERCLA of any "hazardous substance" as defined in Section 101(14) of CERCLA or petroleum (including crude oil or any fraction thereof) onto or from the Leased Property at any time while this Lease is in effect; (iv) failure of Lessee to comply with applicable environmental laws; and (v) the transportation, deposit, storage, or disposal by Lessee of hazardous substances or petroleum off-site of the Leased Property.
- (2) Lessee further covenants that any property of the Government damaged or destroyed by Lessee incident to Lessee's use and occupancy of the Leased Property shall be promptly repaired and replaced by Lessee to the satisfaction of the Local Government Representative, or in lieu of such repair or replacement, Lessee shall, if so required by the said officer, pay to the Government money in an amount sufficient to compensate for the loss sustained by the Government by reason of the destruction of the property.
- (3) The Government accepts that, without conditions, the Lessee shall not be responsible for any claims, damages, causes of action, proceedings, judgments or suits, and all liabilities, losses, costs or expenses, including without limitation technical consultant fees and reasonable attorneys fees) which may arise from or be incident to (i) any "release" as defined in section 101(22) of CERCLA or any "hazardous substance" as defined in Section 101(14) of CERCLA, or petroleum (including crude oil or any fraction thereof) onto or from the Leased Property at any time prior to the effective date of this Lease; (ii) the failure of the Government to comply with applicable environmental laws; (iii) the transportation, treatment, deposit, storage or disposal by the Government of hazardous substances or petroleum off-site of the Leased Property; or (iv) a breach of a certification set forth in Exhibit A2 to this Lease.

K. Utilities and Services

- (1) In the event that the Government shall furnish Lessee with any utilities and services maintained by the Government which Lessee may require in connection with its use of the Leased Property, Lessee shall pay the Government the charges therefor in addition to the cash rent required under this Lease. Such charges are defined in detail in Exhibit A, Article 4. A summarization of such charges as well as the details for payment are described in Exhibit C. It is expressly agreed and understood that the Government in no way warrants the continued maintenance or adequacy of any utilities or services furnished by it to Lessee.

- (2) Utilities to be provided by the Government and the charges for them as detailed in Exhibit A, Article 4 and summarized in Exhibit C, as amended from time to time by the parties. The charge for such utilities will be adjusted yearly beginning on October 1, 1995. Adjustments will be based on a number factors including apportionment of plant operating costs, energy indexes, and plant utility contract changes, etc.. Based on current projections an escalation of between the range of eight (8) and twelve (12) percent is likely in each of the next three years.
- (3) In the event that the Lessee obtains utilities from an appropriate supplier other than the Government; the charges and the method of payment thereof shall be determined by the appropriate supplier of such services, in accordance with applicable laws and regulations. The appropriate supplier of such service may require establishing a new easement and the installation of adequate connecting and metering equipment at the sole cost and expense of Lessee. Such action will be subject to the approval of the Local Government Representative.
- (4) Notwithstanding and in modification of the foregoing, Lessee may terminate this Lease this Lease in whole or in part if utilities are not being adequately supplied to all or any supplied to all or any part of the Leased Property. No such termination shall be allowed if the lack of supply is for any less than forty-eight (48) calendar hours, and no termination shall be allowed if the cut-off of utilities is the fault of the Lessee or Sublessee or Sublessees.

L. Liens

Lessee shall promptly discharge or cause to be discharged any valid lien, right in rem, claim of demand or any kind, caused by Lessee and/or any Sublessee or Sublessees which at any time may arise or exist with respect to the Leased Property or materials or equipment furnished therefor, or any part thereof, on behalf of Lessee and if the same shall not be promptly discharged by Lessee, the Government may discharge, or cause to be discharged, the same at the expense of Lessee.

M. Access

The Government shall have access to the Leased Property at all reasonable times for any purposes not inconsistent with the quiet enjoyment thereof by Lessee, including, but not limited to, the purpose of inspection and activities of the DOE its agents or assigns. Wherever practicable, the Government shall give advance notice of such inspection to Lessee and offer the opportunity to accompany the Local Government Representative. The Lessee shall provide the Government with a schedule of operation hours and holidays.

N. State and Local Taxes

In the event that as a result of any future Act of Congress subjecting Government-owned property to taxation, any taxes, assessment or similar charges are imposed by State or local authorities upon the Leased property (other than upon Lessee's possessory interest therein), Lessee shall pay the same when due and payable.

O. Equal Employment Opportunity

In connection with the performance of work under this Lease, Lessee agrees not to discriminate against any employee or applicant for employment because of race, religion, color, age, sex, or national origin or disability. The aforesaid provision shall include, but not be limited to, the following: employment, upgrading, demotion or transfer; recruitment or recruitment advertising; layoff or termination; rates of pay or other forms of compensation; and selection for training, including apprenticeship. Lessee agrees to post hereafter in conspicuous places available for employees and applicants for employment, notices setting forth the provisions of the nondiscrimination clause. Lessee further agrees to insert the foregoing provision in all subcontracts hereunder, except subcontracts for standard commercial supplies or raw materials.

P. Covenant Against Contingent Fees

Lessee warrants that no person or selling agency has been employed or retained to solicit or secure this Lease upon an agreement or understanding for a commission, percentage, brokerage, or contingent fee, excepting bonafide employees or bonafide established commercial or selling agencies maintained by Lessee for the purpose of securing business. For breach or violation of this warranty the Government shall have the right to annul this Lease without liability or in its discretion to add to the rental price or consideration, or otherwise recover, the full amount of such commission, percentage, brokerage, or contingent fee. (Licensed real estate agents or brokers having listings on property for rent, in accordance with general business practices, and who have not obtained such licenses for the sole purpose of effecting this Lease, may be considered as bonafide employees or agencies within the exception contained in this clause).

Q. Officials Not to Benefit

No member of or delegate to Congress, or resident commissioner, shall be admitted to any share or part of this Lease, or to any benefit arising from it. However, this clause does not apply to this Lease to the extent that this Lease is made with a corporation for the corporation's general benefit.

R. Failure of Government to Insist on Compliance

The failure of the Government to insist, in any one or more instances, upon performance of any of the terms, covenants, or conditions of this Lease shall not be construed as waiver or relinquishment of the Government's right to the future performance of any such terms, covenants, or conditions and Lessee's obligations with respect to such future performance shall continue in full force and effect.

S. Assignment or Subletting

Lessee shall not transfer or assign this Lease or any interest herein nor sublet or otherwise make available to any third party or parties any portion of the Leased Property or rights therein without the prior written consent of the Government. Under any assignment made, with or without consent, the assignee shall be deemed to have assumed all of the obligations of Lessee hereunder, but no assignment shall relieve the assignor of any of Lessee's obligations hereunder except for an extension of the lease term beginning after such assignment, and then only if the Government shall have consented thereto. The Government agrees to reply to a request to sublet within thirty (30) days of the request. Should no reply be forthcoming in said 30 days, Lessee may sublet under the terms of the request.

T. Gratuities

- (1) The right of Lessee to proceed may be terminated by written notice if, after notice and hearing, the agency head or a designee determines that Lessee, its agents, or another representative:
 - (a) Offered or gave a gratuity (e.g., an entertainment or gift) to an officer, official, or employee of the Government; and
 - (b) Intended, by the gratuity, to obtain a lease or favorable treatment under a lease.
- (2) The facts supporting this determination may be reviewed by any court having lawful jurisdiction.
- (3) If this Lease is terminated under paragraph (1) above, the Government is entitled to pursue the same remedies as in a breach of the lease.
- (4) The rights and remedies of the Government provided in this clause shall not be exclusive and are in addition to any rights and remedies provided by law or under this Lease.

U. Government Rules and Regulations

Lessee shall strictly comply with such reasonable rules and regulations regarding Installation security, ingress, egress, safety, and sanitation as may be prescribed, from time to time, and provided to Lessee by the Local Government Representative.

V. Notices

No notice, order, direction, determination, requirement, consent, or approval under this Lease shall be of any effect unless in writing. All notices required under this lease shall be addressed to Lessee, or to the Local Government Representative, as may be appropriate, at the addresses thereof specified in this Lease or at such other addresses as may from time to time be agreed upon by the parties hereto.

W. Payments

All payments to the Government required under this Lease shall be made by check or money order made payable to the Department of Energy and delivered to the Local Government Representative.

X. Interest

Notwithstanding any other provision of this Lease, all amounts that become payable by Lessee to the Government under this Lease shall bear interest from the date due until paid. The interest rate per annum shall bear the interest rate in effect which has been established by the Secretary of the Treasury pursuant to Public Law 92-42; 85 STAT 97 for the Renegotiation Board, as of the date the amount becomes due as herein provided. Amounts shall be due upon the earliest one of (i) the date fixed pursuant to this Lease; (ii) the date of the first written demand for payment, consistent with this Lease, including demand consequent upon default termination; (iii) the date of transmittal by the Government to the Lessee of a proposed supplemental agreement to confirm completed negotiations fixing the amount; or (iv) if this lease provides for revision of prices, the date of written notice to the Lessee stating the amount of refund payable in connection with a negotiated pricing agreement not confirmed by Lease amendment.

Y. Administration

The Local Government Representative specified in Part I, Section 9 of this Lease shall have complete charge of the administration of this Lease, and shall exercise full supervision and general direction thereof insofar as the interests of the Government are affected.



UNITED STATES ENVIRONMENTAL PROTECTION AGENCY

REGION 5

77 WEST JACKSON BOULEVARD

CHICAGO, IL 60604-3590

JUL 12 1994

REPLY TO THE ATTENTION OF:

H-7J

Mr. Larry D. Kirkman
Department of Energy
Dayton Area Office
P.O. Box 66
Miamisburg, OH 45343-0066

Dear Mr. Kirkman:

Thank you for your letter dated June 13, 1994, addressed to Mr. Valdas V. Adamkus, which transmitted a copy of the general purpose lease agreement relating to the U.S. Department of Energy (U.S. DOE) Mound Plant in Miamisburg, Ohio. The letter has been referred to me for response. The U.S. Department of Energy (U.S. DOE) is currently seeking to enter into a leasing agreement for the property known as Building 29. As stated in our letter to you dated March 28, 1994, the U.S. Environmental Protection Agency (U.S. EPA) was previously unable to concur with your decision to proceed with the transitioning of Building 29.

The National Defense Authorization Act for Fiscal Year 1994, requires consultation with and concurrence from the U.S. EPA in determining whether the environmental conditions of U.S. DOE property and the terms and conditions of the lease agreement are consistent with safety and the protection of public health and the environment prior to entering into a leasing agreement. The U.S. EPA requested additional information regarding several noted observations of environmental conditions in Building 29, as well as a copy of the U.S. DOE lease agreement.

The U.S. EPA has carefully reviewed the submitted lease agreement, as well as a facsimile of the Status Report on Building 29, also dated June 13, 1994. The Status Report indicates that environmental conditions previously noted as U.S. EPA concerns have been addressed and remedied or have been placed on a schedule for completion of the action, i.e. asbestos abatement. Ms. Diane M. Spencer, of my staff, noted during her June 22 plant visit that asbestos abatement work was currently being conducted at the building. According to the report, the abatement work was scheduled to have been completed on June 26, 1994. All other noted concerns have been addressed in the submitted Status Report.

The U.S. EPA fully supports redevelopment and reuse of the structures and equipment available at the Mound Plant. Upon

completion of the asbestos abatement in Building 29, the U.S. EPA concurs with the proposed leasing of the building. If you have any questions or concerns about this or future economic development issues at the site, please contact me at (312) 886-7578 or Ms. Spencer at (312) 886-5867.

Sincerely,

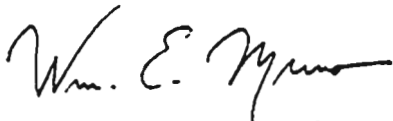
A handwritten signature in black ink, appearing to read "Wm. E. Muno". The signature is fluid and cursive, written over a few lines.

William E. Muno, Director
Waste Management Division

cc: Tom Winston, OEPA

Appendix B

Letters of Correspondence with Federal, State and Local Agencies



George V. Voinovich • Governor
Frances S. Buchholzer • Director

August 4, 1992

Mark Gilliat, Engineer
EG&G Mound Applied Technologies
P.O. Box 3000
Miamisburg, OH 45343-3000

Dear Mr. Gilliat:

After reviewing our maps and files, I find the Division of Natural Areas and Preserves has no records of rare and endangered species in the Department of Energy Mound Facilities project area.

There are no existing or proposed nature preserves or scenic rivers in the project area, and we are unaware of any other unique ecological sites in the vicinity of the Miamisburg, Montgomery County site.

Because our inventory program relies on information supplied by a number of individuals and organizations, a lack of records for any particular area is not a statement that special plant or animal species are absent from a site. Please note that we inventory only high-quality plant communities and do not maintain an inventory of all Ohio wetlands.

I have included a copy of our plant and animal lists for your information. The invoice for this search has been sent separately to Beverly Peters in the EG&G Mound Applied Technologies Library. Please contact me if I can be of further assistance.

Sincerely,

JENNIFER A. HILLMER

Jennifer Hillmer, Ecological Analyst
Division of Natural Areas & Preserves

JH/slc



Dayton Museum of Natural History
2629 Ridge Avenue
Dayton, Ohio 45414
Phone (513) 275-7431

April 25, 1991

Mr. Mark Gilliat
EG&G Mound Applied Technologies
P.O. Box 3000 - Mound Road Bldg. 69
Miamisburg, Ohio 45343 - 3000

Mr. Mark Gilliat:

I hope that my visit to the EG&G Mound Applied Technologies facility on Friday - April 12, 1991 was beneficial to your efforts in identifying and protecting any Shagbark Hickory (*Carya ovata*) trees on your site that might provide protective cover for the endangered Indiana Myotis (*Myotis sodalis*) bat. I commend your company for their concerns in the protection of our endangered wildlife.

After walking the EG&G Mound site to examine several woodlots, we found that the vast majority of trees on location are second growth hardwoods including: Eastern Cottonwood - Populus deltoides, Box Elder - Acer negundo, Wild Black Cherry - Prunus serotina, Ash sps., Elm sps. and others. Also various honeysuckle species were found throughout the understory. Shagbark Hickory (*Carya ovata*) was not found to be present in any of the wooded areas examined on the EG&G Mound site.

I found the morning to be very productive in providing you with an opportunity to better understand the vegetational cover at the EG&G Mound site. It was my pleasure to show you a Shagbark Hickory (*Carya ovata*) tree growing in a local park so that you could become familiar with the identification of this species. I am sure that you will now be able to identify any Shagbark Hickory (*Carya ovata*) that you might encounter in the future at the EG&G Mound site.

If I can ever be of further help to you please contact me any time.

Sincerely yours,

Thomas R. Hissong
Curator of Education



United States Department of the Interior



FISH AND WILDLIFE SERVICE

Reynoldsburg Field Office
6950-H Americana Parkway
Reynoldsburg, Ohio 43068-4115
(614) 469-6923

IN REPLY REFER TO:

April 4, 1991

Mr. Mark D. Gilliat
EG&G Mound Applied Technologies
P. O. Box 3000
Miamisburg, OH 45343-0987

Dear Mr. Gilliat:

This responds to your April 4, 1991 telephone conversation with Ken Multerer of my staff regarding the construction of roadways at your facility. As you stated, roadways are being constructed in some new growth wooded areas on your property. This wooded area may contain some trees which may provide potential habitat for the Indiana bat.

These comments are provided under the authority of the Endangered Species Act of 1973, as amended.

ENDANGERED SPECIES COMMENTS: The proposed project lies within the range of the Indiana bat, a Federally listed endangered species. Summer habitat requirements for the species are not well defined but the following are thought to be of importance:

1. Dead trees and snags along riparian corridors especially those with exfoliating bark which may be used as maternity roost areas.
2. Live trees (such as shagbark hickory) which have exfoliating bark.
3. Stream corridors, riparian areas, and nearby woodlots which provide forage sites.

Considering the above items, we recommend that if trees with exfoliating bark (which could be potential roost trees) are encountered along the proposed right-of-way, they not be cut between May 1 and August 31.

If the above recommendations are incorporated into the project, this precludes the need for further action on this project as required by the 1973 Endangered Species Act, as amended. Should the project be modified or new information become available that indicates listed or proposed species may be affected, consultation/conferring, as appropriate, should be initiated.

If the above described time restriction is unacceptable, mist netting will need to be done to determine whether Indiana bats are actually present. If they are found to be present, specific recommendations will need to be made at that time.

Sincerely,

Kent E. Kroonemeyer
for Kent E. Kroonemeyer
Supervisor

cc: Chief, Ohio Division of Wildlife, Columbus, OH
ODNR, Outdoor Recreation Service, Attn: M. Colvin, Columbus, OH
Ohio EPA, Water Quality Monitoring, (L. Merchant), Columbus, OH
U.S.EPA, Office of Environmental Review, Chicago, IL

Ohio Historic Preservation Office

Ohio Historical Center
1982 Velma Avenue
Columbus, Ohio 43211-2497
(614) 297-2470



OHIO
HISTORICAL
SOCIETY
SINCE 1885

March 15, 1991

Mark D. Gilliat
EG&G Mound Applied Technologies
P.O. Box 3000
Miamisburg, Ohio 45343-0987

Dear Mr. Gilliat:

Re: Mound Facility, Miamisburg, Ohio

This is in response to your letter dated February 21, 1991 concerning the Miamisburg facility. Based on the field survey and examination of the Mound Facility undertaken by Dr. Robert Riordan, Wright State University, in 1987 it appears that there are no significant archaeological remains on the Mound Facility due to previous disturbance. No archaeological sites eligible for the National Register will be affected. Please note that the buildings comprising the facility have not been evaluated in regard to National Register criteria. In order to do this we must have photographs of the buildings, their ages, and a brief history of the facility.

Any questions concerning this matter should be addressed to Julie Quinlan at (614) 297-2470. Her hours are from 5-11 a.m. Thank you for your cooperation.

Sincerely,

A handwritten signature in cursive script that reads "Judith Kitchen".

Judith Kitchen, Department Head
Technical and Review Services

JLK/JAQ:jq



United States Department of the Interior

Fish and Wildlife Service
Reynoldsburg Field Office
6950-H Americana Parkway
Reynoldsburg, Ohio 43068-4115



(614) 469-6923/FAX (614) 469-6919

June 16, 1992

In Reply Refer to:

Mr. Mark Gilliat
EG&G
Mound Applied Technologies
P.O. Box 3000
Miamiesburg, Ohio 45343-3000

Dear Mr. Gilliat:

Per our telephone conversation on June 15, 1992, regarding endangered and threatened species, I wish to inform you that the only Federally listed species in Montgomery county is the Indiana bat.

These comments are provided under the authority of the Endangered Species Act of 1973, as amended.

Sincerely,

Ken Kroonemeyer
for Kent Kroonemeyer
Supervisor



George V. Voinovich • Governor
Frances S. Buchholzer • Director

July 14, 1992

Mr. Mark Gilliat
EG&G M.A.T.
P.O. Box 3000
Miamisburg, OH 45343-3000

Dear Mr. Gilliat:

In response to our recent phone conversation and your follow up letter requesting a statement that the Mound Facility has no impact on a State or National Wild and Scenic River, I can verify that the Great Miami River is not a component of the State or National Wild and Scenic Rivers System.

The Mound Facility is not located near a designated State or National Scenic River. The Stillwater State Scenic River is a tributary to the Great Miami and enters the river at Dayton. Since the Stillwater is upstream of the Mound Facility, no impact would be anticipated.

Thank you for providing me the opportunity to comment.

Sincerely,

Stuart Lewis, Administrator
Ohio Scenic Rivers Program
Division of Natural Areas & Preserves

SL/slc

Appendix C

NPDES Permit Requirements for the Mound Plant (1993)

Appendix C National Pollutant Discharge Elimination System Data (1993)

| | No. of Samples | Annual Averag e | Maximum Monthly Average | NPDES Daily Average Permit Limit | NPDES Weekly Average Permit Limit | NPDES Monthly Average Permit Limit |
|--|-------------------|-----------------------|-------------------------------|--|---|--|
| Outfall 5601 Parameters | a | | | | | |
| Flow Rate, MGD | 198 | 0.08 | 0.10 | n/a | n/a | n/a |
| pH, S.U. | 101 | 7.7 | 7.9 | 6.5-9.0 | n/a | n/a |
| Chlorine: total ^b , mg/L | 102 | 0.12 | 0.16 | 0.50 | n/a | n/a |
| suspended solids, mg/L | 26 | 1.9 | 4.5 | n/a | 30 | 15 |
| Fecal coliform ^b , n/100mL | 6 | 25 | 83 | n/a | 2000 | 1000 |
| <i>Escherichia coli</i> ^b , n/100mL | 25 | 48.5 | 270 | n/a | n/a | n/a |
| Ammonia, mg/L as N | 102 | 0.10 | 0.17 | n/a | n/a | n/a |
| BOD ^c , mg/L | 4 | 1.7 | 2.6 | n/a | 15 | 10 |
| Oil and Grease ^d , mg/L | 12 | 1.31 | 5.23 | n/a | n/a | n/a |
| Cadmium, µg/L | 12 | <10 | <10 | n/a | n/a | n/a |
| Chromium, µg/L | 12 | <50 | <50 | n/a | n/a | n/a |
| Copper, µg/L | 12 | 49.8 | 132 | n/a | n/a | n/a |
| Nickel, µg/L | 12 | <50 | <50 | n/a | n/a | n/a |
| Lead, µg/L | 12 | 13.6 | 57 | n/a | n/a | n/a |
| Zinc, µg/L | 12 | 60.7 | 115 | n/a | n/a | n/a |
| Mercury ^e , µg/L | 2 | <0.2 | ,0.2 | n/a | n/a | n/a |
| Outfall 5602 Parameters | | | | | | |
| Flow Rate, MGD | a | 0.19 | 0.36 | n/a | n/a | |
| pH, S.U. | 51 | 8.2 | 8.4 | 6.5-9.0 | n/a | |
| Suspended solids ^f , mg/L | 51 | 6.9 | 12.8 | 45 | n/a | 30 |
| COD ^g , mg/L | 51 | 95.2 | 182 | n/a | n/a | n/n |
| Oil and grease, mg/L | 12 | 0.75 | 7.6 | 10 | n/a | n/n |

| | | | | | | |
|--|----|-------|-------|--------------------|-----|-------|
| Outfall 5603 Parameters | | | | | | |
| Flow Rate, MGD | a | 4769 | 4769 | n/a | n/a | n/n |
| pH, S.U. | 24 | 7.9 | 8.1 | 6.5-9.0 | n/a | n/n |
| Cyanide, mg/L | 26 | <0.1 | ,0.1 | 1.0 | n/a | 0.65 |
| Cadmium, µg/L | 24 | <10 | ,10 | 100 | n/a | n/a |
| Chromium, µg/L | 24 | <50 | ,50 | 500 | n/a | n/a |
| Copper, µg/L | 24 | 229 | 320 | 500 | n/a | n/a |
| Nickel, µg/L | 24 | <50 | <50 | 500 | n/a | n/a |
| Zinc, µg/L | 24 | <50 | <50 | n/a | n/a | n/a |
| Total toxic organics ^d , mg/L | 4 | <0.05 | <0.05 | 2.13 | n/a | n/a |
| Outfall 5002 Parameters | | | | | | |
| Flow Rate, MGD | a | 0.48 | 0.70 | n/a | n/a | n/a |
| pH, S.U. | 51 | 8.3 | 8.6 | 6.5-9.0 | n/a | n/a |
| Suspended solids, mg/L | 51 | 13.5 | 19.6 | 45 | n/a | 30 |
| Outfall 5001 Parameters | | | | | | |
| Flow Rate, MGD | a | 0.25 | 0.42 | n/a | n/a | n/a |
| pH, S.U. | 27 | 8.1 | 8.4 | 6.5-9.0 | n/a | n/a |
| Residual chlorine ^b , mg/L | 26 | 0.04 | 0.06 | 0.033 ^h | n/a | n/a |
| Cyanide, mg/L | 12 | <0.01 | ,0.01 | 0.083 | n/a | 0.023 |
| Pentachlorophenol, µg/L | 12 | <4 | <4 | n/a | n/a | n/a |
| Bis(2-ethylhexyl) phthalate, µg/L | 12 | 26 | 232 | n/a | n/a | |
| Cadmium, µg/L | 51 | 1.9 | ,10 | 43 | n/a | n/a |
| Chromium, µg/L | 51 | <50 | ,50 | 878 | n/a | n/a |
| Copper, µg/L | 51 | 44.5 | 93 | 120 | n/a | 546 |
| Nickel, µg/L | 51 | <50 | ,50 | 1261 | n/a | n/a |
| Lead, µg/L | 51 | <50 | 79 | 305 | n/a | 760 |
| Zinc, µg/L | 51 | <50 | 76 | n/a | n/a | 191 |
| <i>Ceiodaphnia dubia</i> | | | | | | n/a |
| acute TU ⁱ | 8 | 0.6 | 1.7 | n/a | n/a | |
| chronic TU | 4 | 1.3 | 1.3 | n/a | n/a | |

| | | | | | | |
|--------------------------------|----|------|------|-----|-----|-----|
| <i>Pimephales promelas</i> | | | | | | |
| acute TU ⁱ | 8 | <0.1 | 0.4 | n/a | n/a | n/a |
| chronic TU | 4 | 0 | 0 | n/a | n/a | n/a |
| | | | | | | |
| Outfall 5801 Parameters | | | | | | |
| % affected: | | | | | | |
| <i>Ceiodaphnia dubia</i> | | | | | | |
| 48 hour acute TU ⁱ | 12 | 2.9 | 10 | n/a | n/a | n/a |
| <i>Pimephales promelas</i> | | | | | | |
| 96 hour acute TU ⁱ | 12 | 2.5 | 17.5 | n/a | n/a | n/a |
| | | | | | | |
| Outfall 5901 Parameters | | | | | | |
| % affected: | | | | | | |
| <i>Ceiodaphnia dubia</i> | | | | | | |
| 48 hour acute TU ⁱ | 12 | 19.2 | 1000 | n/a | n/a | n/a |
| <i>Pimephales promelas</i> | | | | | | |
| 96 hour acute TU ⁱ | 12 | 2.9 | 30 | n/a | n/a | n/a |
| | | | | | | |
| Outfall 5902 Parameters | | | | | | |
| % affected: | | | | | | |
| <i>Ceiodaphnia dubia</i> | | | | | | |
| 7 day chronic TU | 4 | 5.0 | 10 | n/a | n/a | n/a |
| <i>Pimephales promelas</i> | | | | | | |
| 7 day chronic TU | 4 | 9.4 | 22.5 | n/a | n/a | n/a |

- a continuous
 - b summer months only (May 1 through October 31)
 - c BOD = Biochemical oxygen demand
 - d Quarterly samples collected in March, June, August, and December
 - e biannual samples collected in June and December
 - f limits n/a when 0.25 inches of rain occur three days during the week
 - g COD - Chemical oxygen demand
 - h Limit not imposed until October 1, 1995
 - i TU = Toxicity unit
- n/a = not applicable

Summary of Organic Compounds Detected in Mound Effluent in 1993

| Outfall | Parameter | Concentration, µg/L | | | | MDL ^a |
|---------|----------------------------|---------------------|-------------|-------------|----------------|------------------|
| | | 1st Quarter | 2nd Quarter | 3rd Quarter | 4th Quarter | |
| 5601 | chloroform | ND ^b | 2.2 | ND | ND | 1 |
| | bis(2-ethylhexyl)phthalate | ND | ND | ND | 5 ^c | 4 |
| | Napthalene | ND | ND | 39 | ND | 4 |
| | Trichloroethene | ND | ND | ND | 1.6 | 1 |
| | | | | | | |
| 5602 | Bromoform | 2.1 | 1.0 | ND | ND | 1 |
| | Dibromochloromethane | 1.9 | ND | ND | ND | 1 |
| | bis(2-ethylhexyl)phthalate | ND | 7.0 | ND | ND | 4 |
| | | | | | | |
| 5603 | Tetrachloroethene | ND | ND | ND | 2.7 | 1 |
| | Bromoform | 5.0 | 2.0 | 5.8 | 1.3 | 1 |
| | Dibromochloromethane | 5.1 | 2.3 | 3.6 | 1.7 | 1 |
| | bis(2-ethylhexyl)phthalate | ND | ND | ND | 9.0 | 4 |
| | Bromodichloromethane | 2.1 | 1.0 | ND | ND | 1 |
| | trichloroethene | ND | ND | ND | 5.9 | 1 |
| | | | | | | |
| 5002 | bis(2-ethylhexyl)phthalate | 5.0 | ND | 13 | ND | 4 |

a MDL = Method Detection Limit

b ND = None Detected

c This compound was present in the extraction blank at a concentration of 5 µg/L

APPENDIX D

Reference Tables from the Nonnuclear Consolidation Environmental Assessment

Indicators of Regional Growth at Mound Plant, 1970 - 2040

| Local Region-of-Influence (ROI) | 1970 | 1980 | 1990 | 2000 | 2020 | 2040 |
|---------------------------------|----------------|----------------|----------------|------------------|------------------|------------------|
| Civilian Labor Force | 380,253 | 427,787 | 481,700 | 521,680 | 523,780 | 502,189 |
| Unemployment Rate (%) | 5.1 | 7.9 | 5.3 | 5.6 | 5.6 | 5.9 |
| Personal Income (thousand \$) | 3,802,566 | 9,141,306 | 16,594,092 | 22,344,200 | 27,930,592 | 33,139,543 |
| Per Capita Income (\$/person) | 4,132 | 9,821 | 16,947 | 22,146 | 25,772 | 30,048 |
| Three County Population | | | | | | |
| Butler County, OH | | | | | | |
| Butler County, OH | 226,207 | 258,787 | 291,479 | 296,762 | 322,832 | 329,934 |
| Middletown | 48,767 | 43,719 | 46,022 | 46,856 | 50,972 | 52,094 |
| | | | | | | |
| Montgomery County, OH | | | | | | |
| Montgomery County, OH | 606,148 | 571,697 | 573,809 | 595,964 | 635,941 | 645,480 |
| Centerville | 10,333 | 18,886 | 21,082 | 21,896 | 23,365 | 23,715 |
| Dayton | 242,917 | 203,741 | 182,044 | 189,073 | 201,756 | 204,782 |
| Germantown | 4,088 | 5,015 | 4,916 | 5,106 | 5,448 | 5,530 |
| Kettering | 71,864 | 61,186 | 60,596 | 62,908 | 67,127 | 68,134 |
| Miamisburg | 14,797 | 15,304 | 17,834 | 18,523 | 19,765 | 20,062 |
| West Carrolton | 10,748 | 13,148 | 14,404 | 14,959 | 15,963 | 16,202 |
| | | | | | | |
| Warren County, OH | | | | | | |
| Warren County, OH | | | | | | |
| Carlisle | 3,821 | 4,276 | 4,872 | 4,970 | 5,345 | 5,452 |
| Franklin | 10,075 | 10,711 | 11,026 | 11,249 | 12,097 | 12,339 |
| ROI (County Total) | 917,280 | 929,760 | 979,197 | 1,008,937 | 1,083,742 | 1,102,883 |

total employment includes only civilian employment. Personal Income and Per Capita Income are in current \$ for 1970-1990 and are in constant 1992 \$ for 2000-2040.

See Ref 1 for Sources

Mound Plant Alternative: Waste Management of Additional Hazardous/Toxic Waste

| Waste Stream | Disposal Method | Volume (ft³/year)^a |
|---|--------------------------|---|
| Acid Liquid Bulk | incineration/recovery | 420 |
| Alkaline | incineration/recovery | 970 |
| Oil/Coolants | incineration | 1810 |
| Halogenated and Non-Halogenated solvent | incineration | 1550 |
| Resin, Paint, Curing Agent, Adhesive and Rubber | incineration | 70 |
| Toluene Diisocyanate | incineration | 40 |
| Cyanide, Liquid | cyanide destruction | 10 |
| Mercury Contaminated Debris | landfilled | 20 |
| F006, F009 Sludge | landfilled | 4200 |
| Batteries (others) | recovery/landfilled | 100 |
| Classified Hazardous | declassified/landfilled | 10 |
| Acid Chromate Contaminated Debris | incineration | 160 |
| Cyanide Alkaline Contaminated Debris | incineration | 100 |
| Miscellaneous lab reagent/Off Spec. Product | incineration/landfilled | 70 |
| Non-Empty Aerosol Cans | incineration | 590 |
| Solvent/Oil Contaminated Debris and Miscellaneous | incineration | 6960 |
| Compressed Gas Cylinders | destruction/incineration | 30 |
| Total | | 18,620 |

a projected for 1995 workload

APPENDIX E

Conformity Analysis Supporting Data and Calculations

Mobile Source Emission Factors and Estimate of Mobile Source Emissions From Implementation of Proposed Action

| | |
|--|--|
| Emissions from passenger vehicles emission Factors from USEPA AP-42, Fourth Edition Volume II, Appendix A VOC's (grams/mile) | 0.41 grams/mile |
| Estimated Maximum Mound Plant Commuting Vehicle Population Accounting for Maximum Potential Jobs Generated from Implementation of the Proposed Action: | Continuing Operations: 1,100 Additional Employees Due to Proposed Action: 1,500 Total Commuting Commuting Vehicle Population: 2,600 |
| Estimated Average Commute to the Mound Facility | 30 miles/day |
| Estimated Mound Plant Commute (days/year) for Full Commuting Population | 250 |

Estimated Mobile Source (indirect) Emissions (tons/year):
 (2,600 vehicles) x (30 miles/day) x (250 commutes/year) x (0.41 grams VOC's /mile) = 8.8 tons/year