

Aerosol Envelope Sealing of New Residences

December 2020





NOTICE

This work was prepared as an account of work sponsored by an agency of the United States Government. Neither the United States Government nor any agency thereof, nor any of their employees, nor any of their contractors, subcontractors or their employees, makes any warranty, express or implied, or assumes any legal liability or responsibility for the accuracy, completeness, or any third party's use or the results of such use of any information, apparatus, product, or process disclosed, or represents that its use would not infringe privately owned rights. Reference herein to any specific commercial product, process, or service by trade name, trademark, manufacturer, or otherwise, does not necessarily constitute or imply its endorsement, recommendation, or favoring by the United States Government or any agency thereof or its contractors or subcontractors. The views and opinions of authors expressed herein do not necessarily state or reflect those of the United States Government or any agency thereof, its contractors or subcontractors.

*Available electronically at Office of Scientific and Technical Information website
(www.osti.gov)*

*Available for a processing fee to U.S. Department of Energy
and its contractors, in paper, from:*

U.S. Department of Energy
Office of Scientific and Technical Information
P.O. Box 62
Oak Ridge, TN 37831-0062

OSTI www.osti.gov
Phone: 865.576.8401
Fax: 865.576.5728
Email: reports@osti.gov

Available for sale to the public, in paper, from:

U.S. Department of Commerce
National Technical Information Service
5301 Shawnee Road
Alexandria, VA 22312

NTIS www.ntis.gov
Phone: 800.553.6847 or 703.605.6000
Fax: 703.605.6900
Email: orders@ntis.gov



Aerosol Envelope Sealing of New Residences

Prepared for:

U.S. Department of Energy Building America Program
Office of Energy Efficiency and Renewable Energy

Prepared by:

Dave Bohac
Center for Energy and Environment
212 3rd Avenue North, Suite 560
Minneapolis, MN 55401

Curtis Harrington
UC Davis Western Cooling Efficiency Center
215 Sage St., Suite 100
Davis, CA 95616

December 2020

Suggested Citation

Bohac, Dave, and Curtis Harrington. 2020. *Aerosol Envelope Sealing of New Residences*. Minneapolis, MN. DOE/GO-102020-5475. www.nrel.gov/docs/fy21osti/78112.

This material is based upon work supported by the Department of Energy's Office of Energy Efficiency and Renewable Energy (EERE) under the Building Technologies Office under Award Number EE0007573.

The work presented in this EERE Building America report does not represent performance of any product relative to regulated minimum efficiency requirements.

The laboratory and/or field sites used for this work are not certified rating test facilities. The conditions and methods under which products were characterized for this work differ from standard rating conditions, as described.

Because the methods and conditions differ, the reported results are not comparable to rated product performance and should only be used to estimate performance under the measured conditions.

FOREWORD



The U.S. Department of Energy (DOE) Building America Program has been a source of innovations in residential building energy performance, durability, quality, affordability, and comfort for more than 20 years. This world-class research program partners with industry to bring cutting-edge innovations and resources to market.

In cooperation with the Building America Program, the Center for Energy and Environment team is one of many [Building America teams](#) working to drive innovations that address the challenges identified in the program's [Research-to-Market Plan](#).

This report, *Aerosol Envelope Sealing of New Residences*, explores the process for integrating aerosol envelope sealing in new homes, and evaluates sealing performance relative to conventional sealing methods. A total of eight

builders in Minnesota and California participated in the research, providing homes for testing and feedback on appropriate stages of construction to apply the sealing.

As the technical monitor of the Building America research, the National Renewable Energy Laboratory encourages feedback and dialogue on the research findings in this report as well as others. Send any comments and questions to building.america@ee.doe.gov.



ACKNOWLEDGMENTS

The work presented in this report was funded by the U.S. Department of Energy (DOE), Office of Energy Efficiency and Renewable Energy, Building Technologies Office.

Photo Credits

Cover, from top to bottom: Photos from iStock 182149008, 178447161, 184944590, 467972591;

Page ii and iii: Photo from iStock 182149008;

Page v: Photo by Dennis Schroeder, NREL 28764;

Page vi: Photo from iStock 183245764;

Page vii: Photo from iStock 496703961;

Page viii: Photo from iStock 148484827;

Page ix and xi: Figures from Center for Energy and Environment;

Page x, xii, xiii, xiv: Photos from Center for Energy and Environment

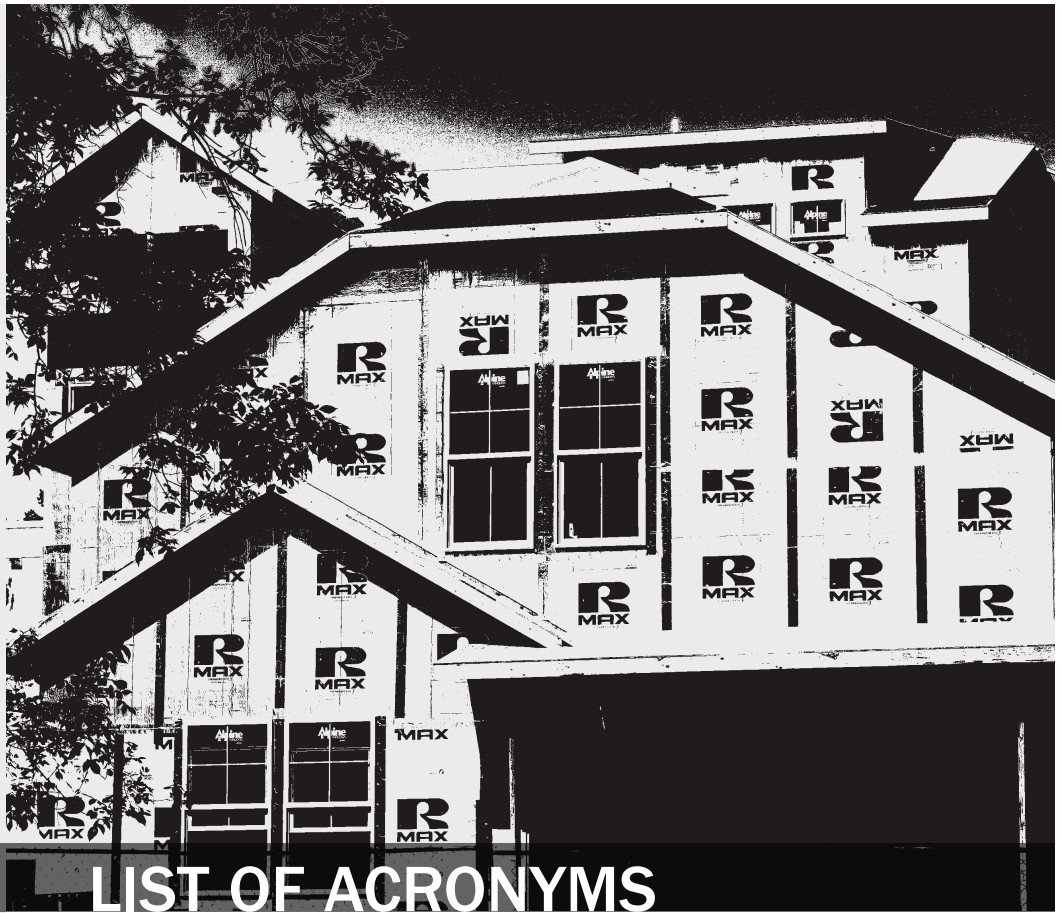

LIST OF ACRONYMS

ACH₅₀	leakage flow rate in air changes per hour at an induced pressure of 50 pascals
CFM₅₀	leakage flow rate in cubic feet per minute at an induced pressure of 50 pascals
cfm	cubic feet per minute
DOE	U.S. Department of Energy
HERS	Home Energy Rating System
HVAC	heating, ventilating, and air conditioning
ICC	International Code Council
IECC	International Energy Conservation Code
WCEC	Western Cooling Efficiency Center at UC Davis

EXECUTIVE SUMMARY

This project investigated the use of an aerosol-based sealing method to reduce air leakage of new homes in the United States. The process involves pressurizing the building while dispersing an aerosol sealant “fog” to the building interior. As air escapes the building through leaks in the envelope, the sealant particles are carried to the leaks where they make contact and stick, sealing the leaks. A standard blower door and connected laptop are used to facilitate the sealing process and to provide real-time feedback and a permanent record of the sealing. The technology is thus capable of simultaneously measuring, locating, and sealing leaks in a building automatically.

The project team worked directly with builders to identify the best stages for incorporating aerosol sealing from the perspectives of cost, performance, and seamless integration into the construction process. A total of eight builders in Minnesota and California participated in the research, providing homes for testing and feedback on appropriate stages of construction to

apply the sealing. The cost of the aerosol sealing and resulting house tightness were compared to a similar group of houses that used conventional sealing methods. Aerosol sealing produced tighter houses overall. Researchers also evaluated conventional sealing methods to determine whether they can be eliminated or reduced to improve cost-effectiveness.

Methodology

The project team used a stepwise, iterative approach to develop and refine aerosol envelope sealing guidelines. This approach allowed experience from sealing each builder’s initial set of houses to inform and refine sealing methods for their second set of houses, as shown in Figure 1.

Visual inspections of the homes showed an overall high quality of sealing work. Several locations were identified as being appropriate to seal with the aerosol approach. Although aerosol sealing can seal leaks that have a width of up to 0.5 in., the method is most effective and efficient at sealing narrower, distributed leaks of 0.25 in. or less. With aerosol sealing, hundreds of linear feet of these narrow leaks can all be sealed simultaneously, reducing the amount of time needed for manual inspection and sealing.

Results

Aerosol sealing was performed on 11 homes in California and 15 homes in Minnesota. The sealing was very effective at sealing air leaks in the homes. Many of the

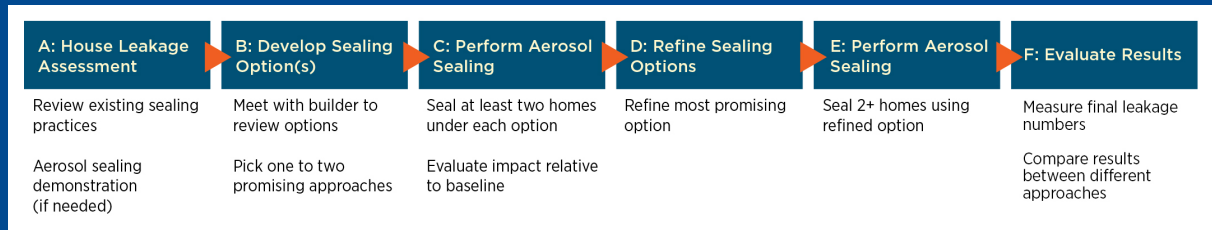

Figure 1. Iterative approach to evaluating aerosol sealing options

demonstrations resulted in a tightness below 1.0 ACH₅₀, which is well below the California Energy Code target of 5.0 ACH₅₀ and Minnesota Energy Code requirement of 3.0 ACH₅₀. Furthermore, the low air leakage was often achieved at an early stage of construction before much of the manual sealing was performed. This project demonstrated the ability to seal homes at various stages of construction, including before or after drywall is installed.

California Homes

In California, the aerosol sealing demonstrations were split into two categories: homes with unvented attics and homes with vented attics. The unvented attic demonstrations looked at the performance of aerosol sealing when applied in conjunction with both open-cell spray foam insulation at the roof deck as well as with cellulose insulation at the roof deck. In both cases, the homes were sealed before wall insulation and drywall was installed and after all of the exterior penetrations were made. Results showed that the aerosol sealing did a better job of air sealing the homes, allowing the builder to choose lower-cost insulation products. The combination of open-cell spray foam and aerosol sealing resulted in tighter homes overall compared to homes insulated with cellulose. The homes with spray foam achieved leakage rates of 1.1 ACH₅₀ compared to 2.6 ACH₅₀ for the homes with cellulose; however, challenges with integrating the aerosol sealing process due to the cellulose-insulated homes' design differences contributed to the higher leakage rates. The control homes that were not sealed with aerosols showed higher leakage rates for the homes using cellulose, with an average leakage of 5.1 ACH₅₀ compared to 1.8 ACH₅₀ for the homes with open-cell foam.

The vented attic demonstrations in California were performed after drywall was installed and taped, because that is when the air barrier is in place.

The aerosol sealing process was very effective at this stage of construction,

sealing more than 70% of the envelope air leakage. The homes sealed with aerosols were 33% tighter (3.1 ACH₅₀) than the control homes (4.6 ACH₅₀).

There were significant increases in the measured leakage from the test conducted after the aerosol sealing was complete to the test at the end of construction. The vented attic homes showed significant increases in leakage after the aerosol sealing installation.

Several leak sites were taped over and unsealed by aerosol sealing material, including fire sprinklers and exhaust ventilation systems. Fire sprinklers are required in homes built in California, and air leakage measurements were

taken on a small sample of sprinklers in

the homes, showing an average air leakage of around 10 cfm₅₀ each. These sprinklers had to be taped over during the aerosol sealing installation to prevent damage and maintain functionality of the equipment. Considering that homes can have more than 10 sprinklers, this results in 100 cfm₅₀ of leakage to the attic that cannot be sealed. For homes with unvented attics, the air barrier is at the roof deck, above the sprinklers, so the air leakage of sprinklers to the attic does not affect the overall leakage rate. Leakage was found through the backdraft dampers in the exhaust systems, with 200–300 cfm₅₀ of leakage. These leaks accounted for a significant fraction of the increase in leakage measured and cannot be sealed by design; rather, better-designed ventilation and sprinkler systems are needed to accommodate tighter homes.

Minnesota Homes

The homes sealed in Minnesota all had vented attics, but a strategy was developed for aerosol sealing the homes before insulation and drywall.



The builder's standard practice is to install reinforced polyethylene (poly) sheets on the second-floor ceiling to complete the house's air barrier and allow pressurization for the aerosol sealing to be performed. The poly installation was at a slightly different stage of construction than occurs normally, and for some houses required an additional visit to the house by the insulation contractor. Prior to the aerosol sealing, spray foam was applied at the rim joists and can foam was used to seal around windows and attic penetrations. The California builders do not install poly sheets on the interior, so this was not an option for the vented attic homes without incurring additional costs. Additionally, some sealing demonstrations in Minnesota residences occurred after drywall toward the end of construction.

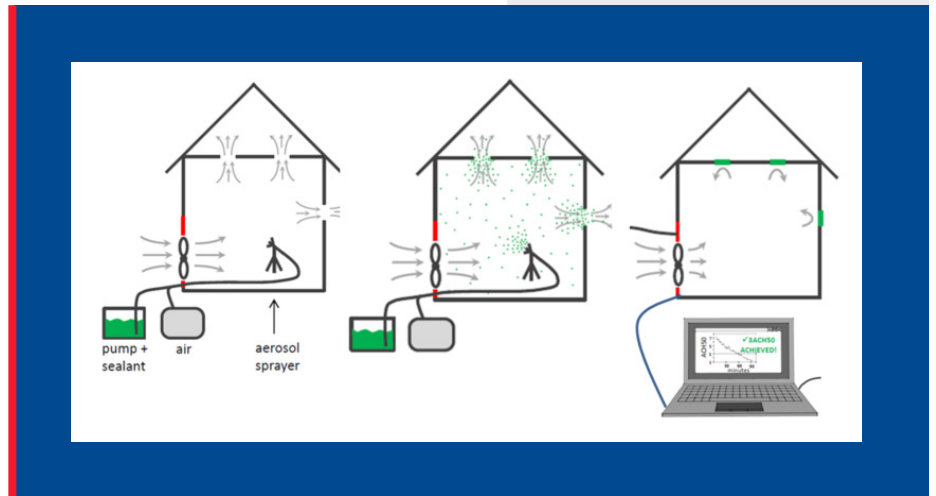

The first builder was a large, national builder with multiple developments in the Minneapolis-St. Paul metropolitan area. Seven houses were sealed, all before drywall was installed and after reinforced poly was installed at the second-floor ceiling. This builder had already been achieving high levels of air sealing, with the initial assessment showing leakage of 1.2–1.5 ACH₅₀, so the goal was to find opportunities to reduce the costs of conventional sealing work. Several features or products were identified as possible to eliminate from the conventional sealing process. Two of the homes had wall insulation installed prior to the aerosol installation, which significantly reduced the effectiveness of the sealing process and increased the injection time. For the houses without wall insulation present, the aerosol sealing reduced leakage by 80%, and the houses ended up 70% tighter than the 3.0 ACH₅₀ code requirement.

The second builder was a midsize residential builder with multiple developments in the Minneapolis-St. Paul metropolitan area. This builder already had a high quality of air sealing with four of their homes, with



manual sealing testing of 0.9–2.0 ACH₅₀ during the initial assessment. Four homes were sealed for this builder, including one demonstration. The sealing demonstration performed at the end of construction was extremely successful. The house leakage was reduced from 0.7 ACH₅₀ to 0.35 ACH₅₀. The remaining three homes were sealed at a similar stage of construction as the first builder, before drywall was installed and after reinforced poly was placed at the second-floor ceiling. The aerosol sealing successfully reduced the house leakage by more than 70%. The end-of-construction testing for four of the homes showed an average air leakage of 0.8 ACH₅₀ compared to 1.4 ACH₅₀ for the control homes that were not sealed with aerosol.

The project also included homes for four additional builders that had a type of construction or an air sealing approach that was used somewhat often in Minnesota that had not already been included in the houses of the first two builders. This included houses with slab-on-grade foundations, flat roofs, and spray foam wall insulation. The sealing was successful in each of these

cases, sealing nearly 80% of the leakage and achieving an average leakage of 0.8 ACH₅₀ at the end of construction.

Builder Interviews

The builders who participated in this study were interviewed after completion of the project to get their feedback on the advantages and disadvantages of aerosol sealing and how they could see it being incorporated into the construction process. The builders in Minnesota generally saw the value of the aerosol sealing service to get their homes well below code. Additionally, they identified sealing processes and materials that could potentially be removed when applying aerosol sealing, but they were hesitant to change their construction methods for a small number of their production houses. The primary concern was around vapor intrusion, which has been mitigated in part by using poly wrap on the interior of the home. Removing poly wrap was one suggestion, but one

builder mentioned that they already deal with a number of warranty issues that include moisture intrusion and would be concerned about removing that product.

The California builders had a very different perspective, considering that the California Building Energy Efficiency Standards do not require a specific level of measured air leakage. Instead, there is a process through which the state inspects air sealing processes in the home, and based on that process it is assumed that the builders achieve 5.0 ACH₅₀ for their homes. There are performance credits and utility incentives for verifying that their homes are getting below 5.0 ACH₅₀; however, the builders perceived that these benefits did not justify the additional cost of air sealing. If the models used to evaluate the performance of a home design associated more energy savings to building envelope sealing, then there could be cost-effective tradeoffs that builders could use to justify the additional cost (i.e., downsized heating, ventilating, and air-conditioning [HVAC] equipment).



Energy Savings

Energy savings from air sealing homes in the United States is highly dependent on climate zone. The project team performed a BEopt™ analysis that looked at the impact on heating and cooling energy use when sealing a 2,400-ft² home in 16 U.S. climate zones. The results showed that colder climates had the highest source of energy savings, with 18% total savings in Fairbanks, Alaska (climate zone 8), when sealing the home from the B10 Benchmark of 7.0 ACH₅₀ to 2.0 ACH₅₀. Climate zones 4A, 5A, 5B, 6A, 6B, and 7 achieved total energy savings of 10% or higher in the same scenario, whereas the remaining climate zones saved 1%–8%. The savings ranged from 1%–10% when sealing homes from 5.0 ACH₅₀ to 2.0 ACH₅₀.

The primary driver for energy savings is reduced heating energy use in the homes, which is why colder climates show a higher percentage of savings. Cooling energy use for climate zones 3B-CA, 3C, 4C, 5B, 6B, 7, and 8 went up due to the reduced infiltration during periods when the air temperature outside was cooler than inside during the cooling season; however, the relative amount of energy used for cooling was small compared to that for heating. Only one climate zone (3B-CA) showed an increase in total electricity energy use for the home. Opening the windows in the cooling season at times when the outdoor air is cooler than inside would minimize or eliminate increased cooling energy use.

Conclusions and Recommendations

Aerosol envelope sealing was very effective at sealing air leaks in new homes. Many of the demonstrations resulted in a tightness below 1.0 ACH₅₀, which is well below the California and Minnesota Energy Code requirements of 5.0 ACH₅₀ and 3.0 ACH₅₀, respectively. The technology demonstrated versatility in sealing homes at various stages of construction, including before and after drywall is installed. Even with changes to installation protocols, the process consistently reduced envelope leakage by 70% or more when evaluating the leakage before and after sealing.

The aerosol envelope sealing process produced tighter homes and demonstrated a potential opportunity for cost savings in the construction process. A review of the standard air sealing efforts performed by U.S. builders shows several areas where efforts can be reduced or eliminated by applying aerosol sealing. By reducing other sealing work, builders can: (1) minimize material used for sealing a building, because aerosol sealing only applies material where leaks are present; (2) reduce the possibility of redundant sealing (e.g., sealing on both external and internal wall surfaces) while ensuring a continuous air barrier is applied; and (3) reduce the number of trades involved in the air sealing process so that the responsibility for creating a successful air barrier is clearly



defined; fewer trades need to be trained and supervised; and less time is wasted sealing leaks that do not impact envelope leakage.

This research has demonstrated that builders can use the aerosol sealing technology to meet their air leakage targets without requiring close attention to detailed air sealing work. The technology seals smaller, distributed leaks in a home very efficiently, and these leaks are harder to address with conventional sealing techniques. Builders still have concerns about cost and a hesitancy to reduce current sealing efforts, but the ability for the aerosol sealing process to meet even the most stringent leakage targets gives builders the confidence that their air leakage goals can be met without fundamental changes to their regular construction practices. As codes become more stringent, it is expected that builders will be more likely to adopt the aerosol sealing technology as a cost-effective tool for meeting future air leakage goals.

Table of Contents

1	Introduction.....	1
2	Background.....	2
2.1	Development of the Aerosol Envelope Sealing Method.....	4
2.1.1	Envelope Sealing of the Honda Smart Home	6
2.1.2	Production-Scale New Home Envelope Sealing.....	8
2.1.3	Aerosol Sealing Commercialization	10
2.2	Non-Energy Impacts	10
2.3	Envelope Air Leakage Requirements.....	11
2.3.1	International and Minnesota Energy Conservation Codes.....	11
2.3.2	California Energy Code	12
3	Objectives	13
4	Methodology	16
4.1	House Selection Criteria.....	16
4.2	Technical Approach	17
4.3	Envelope Leakage Assessment	19
4.3.1	House Envelope Leakage Test.....	20
4.3.2	Visual Inspection	21
4.3.3	Individual Leakage Sites.....	22
4.3.4	Guarded Leakage Test of Triplex Units.....	23
4.3.5	Infrared Inspection	25
4.3.6	Sealing Cost Estimates.....	25
5	Results and Discussion	27
5.1	California Houses.....	29
5.1.1	Unvented Attics: Phase I.....	29
5.1.2	Unvented Attics: Phase II	34
5.1.3	Unvented Attics: Discussion.....	38
5.1.4	Vented Attics	39
5.2	Minnesota Houses	44
5.2.1	First Minnesota Builder (#3).....	46
5.2.2	Second Minnesota Builder (#4)	62

5.2.3	Phase I Aerosol Sealing	63
5.2.4	Phase II Aerosol Sealing	64
5.2.5	End-of-Construction Leakage	65
5.2.6	Minnesota Builders 5–8	65
5.3	Illinois Triplex	71
5.3.1	End-of-Construction Leakage	77
5.4	Builder Interviews	78
5.5	Energy Modeling	86
5.5.1	Energy Savings	88
6	Conclusions and Recommendations	92
	References	95
	Appendix A. Builder Interview Script and Questions	98
	Appendix B. Code Requirements for Vapor Retarders and Air Barriers	100
	Appendix C. Air Sealing Assessment Tables	106
	Appendix D. Content for the Building America Solution Center	111

List of Figures

Figure 1. Iterative approach to evaluating aerosol sealing options.....	ix
Figure 2. Measured envelope leakage of new homes in six states; the red dashed lines indicate the code requirement.....	3
Figure 3. Distribution of envelope leakage of new homes in Maryland.....	4
Figure 4. The progression of the sealing process from the start (left) to the end (right)	5
Figure 5. Photos of the Honda Smart Home before aerosol envelope sealing application.....	6
Figure 6. Photos of aerosol sealing installation on a single-family home, including examples of seals formed	7
Figure 7. Summary of results from the aerosol envelope sealing demonstration in the Honda Smart Home	8
Figure 8. Iterative approach to evaluate aerosol sealing options	19
Figure 9. Test equipment configuration for a compartmentalization leakage test.....	23
Figure 10. Test equipment configuration for guarded leakage test	24
Figure 11. Photos of homes sealed under Option A showing open-cell spray foam at roof deck (left) and rim joist (right)	30
Figure 12. Sealing profile for both houses under Option A.....	30
Figure 13. Photos of houses sealed under Option B	32
Figure 14. Sealing profile for both houses sealed under Option B (pre-foam).....	32
Figure 15. Air leakage results summary for all homes at each stage of the process	33
Figure 16. Large gaps at eaves between foam and roof structure were sealed prior to aerosol sealing	34
Figure 17. Bibs attached to roof deck left hanging (left); photo of home sealed with ridged foam on exterior (right).....	35
Figure 18. Air barrier wrap above drywall to seal house attic from garage attic	36
Figure 19. Sealing profile for both houses sealed for Phase II with California Builder 2.....	37
Figure 20. Phase II air leakage results for all homes, including end of construction	38
Figure 21. Air leakage results summary for all homes for Phase I and II at each stage of process	39
Figure 22. State of vented attic homes at time of sealing	40
Figure 23. Aerosol equipment set up in garage with kerosene heater (left); houses 10 and 11 sealed during rain (right).....	41
Figure 24. Additional preparation required in houses 9, 10, and 11 to protect installed trim, including baseboards and shelves (left) and windowsills (right).....	41
Figure 25. Sealing profile for all five homes with vented attics sealed with California Builder A	42
Figure 26. Air leakage results for all vented attic homes, including end of construction	43
Figure 27. Damaged seal in electrical outlet after aerosol sealing installation.....	44
Figure 28. Closed-cell spray foam at rim joist and duct penetrations (left); caulk at seams where wood is joined (right).....	45

Figure 29. Can foam at wire penetrations (left); foam gasket/caulk at sill plate and airtight electric box (right)..... 46

Figure 30. Interior poly sheet on top floor ceilings and exterior walls..... 46

Figure 31. Typical air sealing details: can foam around bottom plate duct and electrical penetration (left), airtight electric box at exterior wall and caulk bottom plate/subfloor (middle), and can foam at plumbing penetration and caulk between framing 47

Figure 32. Temporary sealing preparations: shower base, 1-in. holes in subfloor over garage, and exhaust fan outlet 48

Figure 33. Manual sealing prior to aerosol: poly on second floor ceiling, foam at electrical penetrations to garage, and foam gap at top of garage drywall 48

Figure 34. Sealing profile for Minnesota Builder 3 (House #12) demonstration sealing..... 49

Figure 35. Example aerosol seals: gap between drywall sheets (left), gap between framing and sheathing (middle), and rim joist gaps (right)..... 50

Figure 36. Sealing profile for the first four houses in Minnesota Builder 3’s Phase I 53

Figure 37. Air leakage results for Minnesota Builder 3..... 55

Figure 38. Example aerosol seals: between framing (left); between sill plate/sheathing; between sill plate/subfloor 55

Figure 39. Sealing profile for House #14 (no wall insulation) and #15 (insulated) 57

Figure 40. Poly sheet pulled away from framing..... 58

Figure 41. Sealing profile for two Phase II houses 60

Figure 42. Sealing profile for three houses for Minnesota Builder #4 62

Figure 43. Air leakage results for Minnesota Builder #4..... 64

Figure 44. Sealing profile for Minnesota Builder 5 (House #23), 6 (#24), and 8 (#26)..... 67

Figure 45. Air leakage results for Minnesota Builders 5–8 68

Figure 46. Sealing profile for Minnesota Builder #7 (House #25) 70

Figure 47. Sealing profile for Minnesota Builder #8 house (#26)..... 71

Figure 48. Sealing profile for Illinois Triplex..... 74

Figure 49. Air leakage results for Illinois triplex..... 75

Figure 50. Builder-reported typical (top) and target (bottom) leakage rates 79

Figure 51. Biggest challenge to using aerosol sealing..... 80

Figure 52. Current sealing that could be eliminated 82

Figure 53. Best type of construction for aerosol sealing 83

Figure 54. Energy-efficient home marketing..... 84

Figure 55. Beneficial information for home buyers..... 85

Figure 56. Use home comfort and/or energy efficiency as talking point with potential homeowners 86

Figure 57. Geometry of home used for infiltration modeling..... 88

Figure 58. Total energy savings from reducing air leakage in the model home in each U.S. climate zone 89

Figure 59. Cooling energy savings from reducing air leakage in the model home in each U.S. climate zone 90

Figure 60. Heating energy savings from reducing air leakage in the model home in each U.S. climate zone 90

Figure 61. Cooling energy intensity reduction from reducing air leakage in the model home in each U.S. climate zone..... 91

Figure 62. Heating energy intensity reduction from reducing air leakage in the model home in each U.S. climate zone..... 91

Figure 63. Aerosol sealing process 112

Figure 64. Aerosol fog from spray head 113

Figure 65. Aerosol sealant build-up on edge of leak 114

Figure 66. Blower door, sealant pump, and sealant setup in attached garage 114

Figure 67. Temporary cover over sprinkler head..... 115

Figure 68. Temporary cover over open plumbing pipes..... 115

Figure 69. Temporary cover over tub and plumbing fixture 116

Figure 70. Seal (gray material) formed between gap in foam 117

Figure 71. Seal around electric box on exterior wall..... 117

Figure 72. Seal between electrical box and drywall; the seal on the sides of the box is made further back in the crevice and not visible on the surface..... 118

Figure 73. Seal between plumbing penetration and drywall..... 118

Figure 74. Seal gap between framing 119

Figure 75. Seal between sheathing and framing 119

List of Tables

Table 1. Summary of Aerosol Envelope Sealing Results	9
Table 2. Summary of Time Required for Each Step in Sealing Process	10
Table 3. Visual Inspection Checklist: Categories and Components	22
Table 4. Key Characteristics and Leakage Results for Aerosol-Sealed Residences.....	28
Table 5. Time and Materials Used to Manually Seal Homes Prior to Aerosol Sealing	31
Table 6. Summary of Phase I Sealing Results	33
Table 7. Summary Table of Aerosol Sealing Results: Phase II—Before Drywall.....	37
Table 8. Summary Table of Aerosol Sealing Results	42
Table 9. Current Air Sealing That Could Possibly Be Eliminated With Aerosol Sealing	51
Table 10. Summary of Minnesota Builder 3 Sealing Results.....	54
Table 11. Summary of Minnesota Builder 4 Phase I Sealing Results	63
Table 12. Summary of Sealing Results for Minnesota Builders 5–8.....	67
Table 13. Summary of Sealing Results for Illinois Triplex	74
Table 14. Detailed Illinois Triplex Leakage	76
Table 15. Benefits of Using Aerosol Sealing.....	81
Table 16. Table R702.7.1: Class III Vapor Retarders Permitted For the Following	102
Table 17. Table R402.4.1.1: Air Barrier and Insulation Installation Criteria.....	104
Table 18. California: Air Unvented Attics With Spray Foam Insulation	106
Table 19. California: Air Unvented Attics With Netted Insulation	107
Table 20. California: Vented Attics	108
Table 21. First Minnesota Builder (#3).....	109
Table 22. Second Minnesota Builder (#4)	110

1 Introduction

In many parts of the United States, house envelopes are notoriously leaky with unintended flows between conditioned and unconditioned spaces that result in additional space heating and cooling equipment loads. Although voluntary codes and standards for envelope tightness have existed for decades, only recently have these codes included mandatory envelope leakage requirements with verification by performance testing. Builders now need to integrate envelope sealing into their construction process. Current state-of-the-art methods for envelope air sealing rely on contractor personnel to manually seal typical leakage locations. The achieved airtightness levels can be highly variable and are based on the time allotted, accessibility of leaks, as well as the vigilance and experience of the contractor who performs the work. Although mid-construction leakage testing and diagnostics can help identify air barrier deficiencies earlier in the construction process, it is common for airtightness verification to be performed by a different contractor after the sealing and after the construction is mostly or entirely complete. This provides limited opportunity for feedback on the effectiveness of the air sealing, making it difficult for the sealing contractor to ensure that a specific level of leakage has been achieved. If the house leakage is greater than acceptable, additional sealing at later stages of construction is more expensive and may not be possible or effective.

The aerosol envelope sealing technology developed by the Western Cooling Efficiency Center (WCEC) at UC Davis uses an automated method to satisfy the envelope sealing requirement. The process involves pressurizing the building using a standard blower door for an hour or two while multiple spray nozzles are used to disperse an aerosol sealant “fog” to the building interior. As air escapes the building through leaks in the envelope, the sealant particles are carried to the leaks where they impact and stick, sealing the leaks. The blower door is used to facilitate the sealing process, and provide real-time feedback and a permanent record of the sealing. The technology is thus capable of simultaneously measuring, locating, and sealing leaks in a building.

At the start of this project, the WCEC technology was in the early stages of commercialization. The project team worked directly with builders to identify the best stages for incorporating aerosol sealing, from the perspectives of cost, performance, and seamless integration into the construction process. In addition to producing tighter houses, conventional sealing methods were evaluated to determine whether they could be eliminated or reduced to further improve cost-effectiveness. A stepwise, iterative process was used with multiple builders, so that lessons learned from the first houses could be applied to later ones. The ultimate outcome of this project was to provide builders with procedures to easily integrate the aerosol sealing technique into standard construction practices. This will economically produce more consistent sealing performance and improved house airtightness to reliably meet stringent air leakage requirements.

2 Background

The residential sector is responsible for about 23% of energy use in the United States, and 43% of that is due to heating and cooling (DOE 2014). For homes, 29% of space conditioning use is due to air infiltration—which means that about 12% of total use, or 2.85 quads, is due to air infiltration (DOE 2014). In many parts of the United States, this unintended air infiltration results in excess space heating and cooling equipment energy consumption. For example, the 135,000 U.S. homes in Lawrence Berkeley National Laboratory’s Residential Leakage Database (ResDB) had a geometric mean leakage of 11 air changes per hour at a pressure difference of 50 pascals (ACH_{50}) (Chan et al. 2013).

Although voluntary standards for measured envelope tightness have existed for decades, these have only recently become a code requirement in some states, and tightness requirements are typically moderate. The 2009 version of the International Energy Conservation Code (ICC 2009) included an option for measured envelope air leakage testing less than 7.0 ACH_{50} . The 2012 version changed to a mandatory testing requirement with leakage less than 3.0 or 5.0 ACH_{50} depending on climate zone. A 2015 Department of Energy (DOE) six-state residential energy code study (DOE 2015) reported that for the five states with a code tightness requirement of 5.0 or 7.0 ACH_{50} , the state level compliance ranged from 70% to 97% (see Figure 2). For five states combined, there was a relatively high compliance rate of 87%. For the state of Maryland, which had recently implemented a lower requirement of 3.0 ACH_{50} , the compliance rate was only 48%—almost a third of the houses exceeded the code requirement by 50% or more (i.e., 4.5 ACH_{50}), and none of the houses had a leakage less than 1.9 ACH_{50} (Figure 3). In addition, only 10% of the houses in the six states would have met the DOE Zero Energy Ready tightness requirement of 1.5 to 3.0 ACH_{50} (DOE 2019).¹

The results suggest that although mainstream contractors can achieve 5.0 or 7.0 ACH_{50} , they are often not able to seal houses to a required tightness level of 3.0 ACH_{50} , and that there is significant potential for tighter new houses with better sealing methods. Custom homebuilders can meet the Passive House standard of 0.6 ACH_{50} , but this typically requires comprehensive sealing methods and quality control that could be achieved more easily with aerosol sealing. Aerosol sealing has the potential produce tight homes with reduced labor and material costs compared to conventional sealing, in addition to reducing contractor training and quality control for assuring that target house tightness values are achieved. This would reduce the need for skilled or experienced labor.

¹ The requirement is 3 in climate zones 1 and 2, 2.5 in zones 3 and 4, 2 in zones 5 to 7, and 1.5 in zone 8.

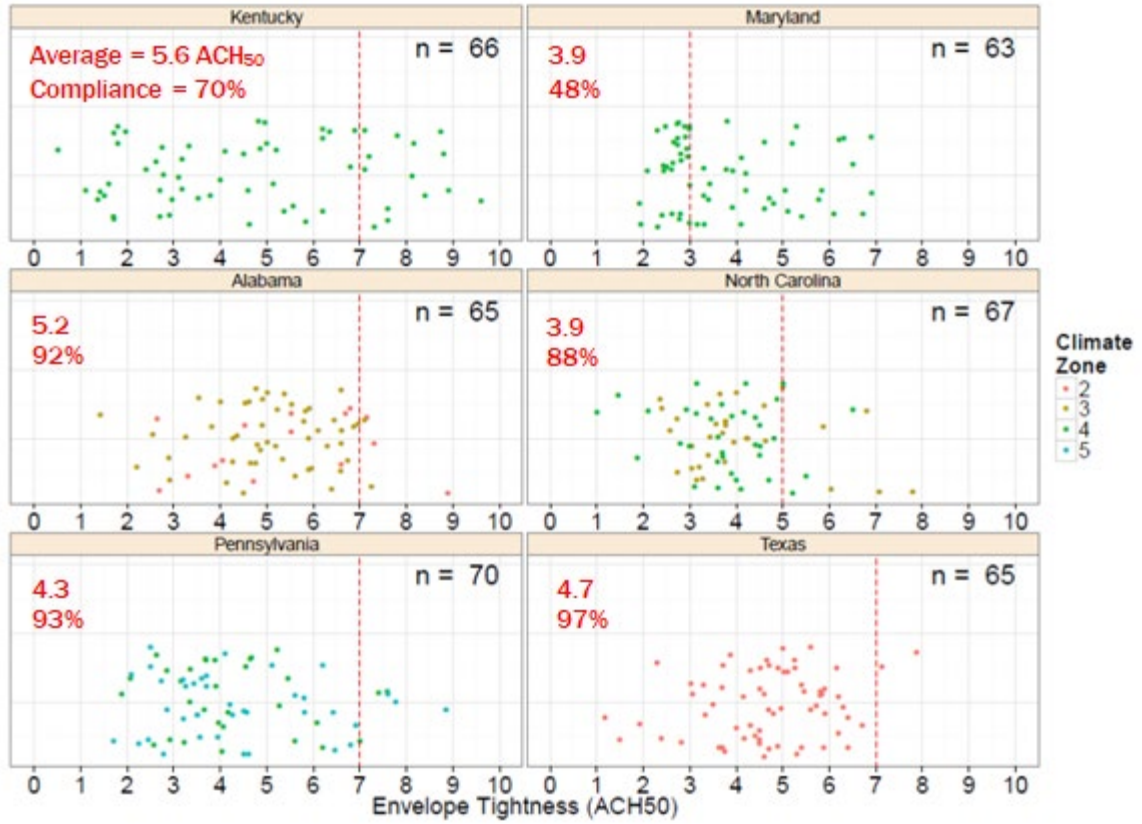

Figure 2. Measured envelope leakage of new homes in six states; the red dashed lines indicate the code requirement

Source: Building Energy Codes Program, Single Family Residential Energy Code Field Study, DOE 2015

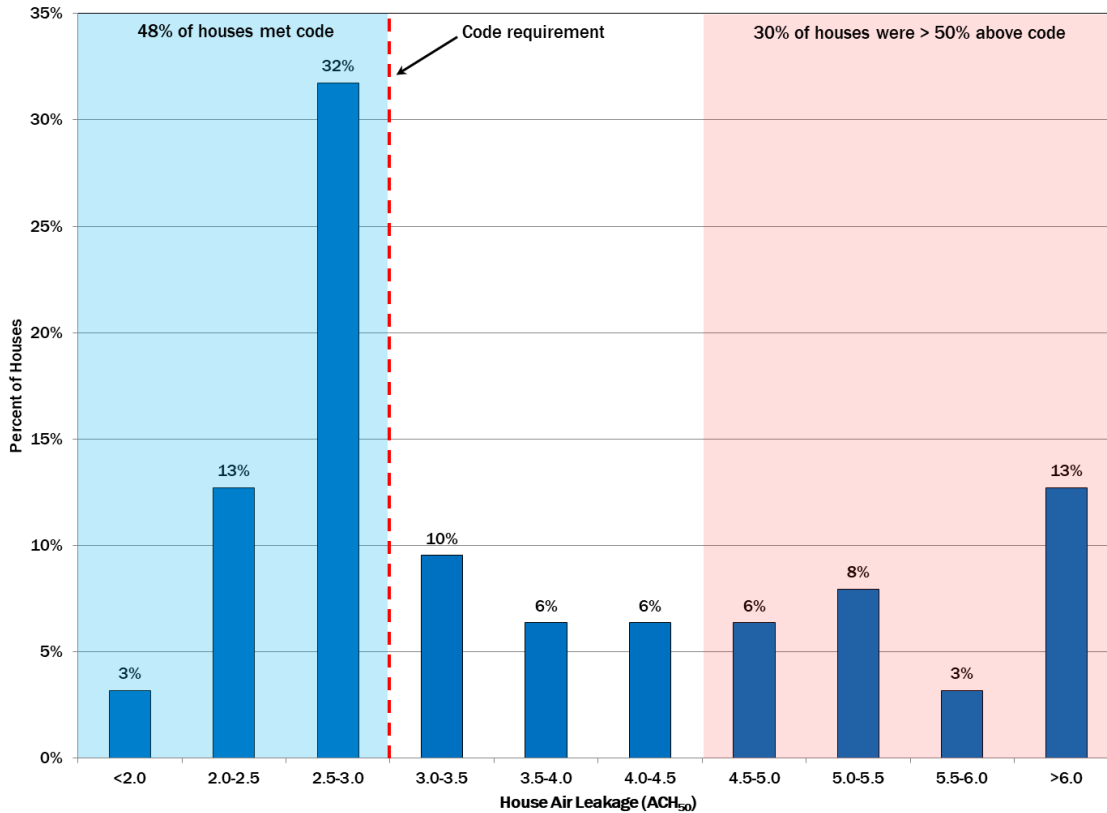

Figure 3. Distribution of envelope leakage of new homes in Maryland

Source: Building Energy Codes Program, Single Family Residential Energy Code Field Study, DOE 2015

2.1 Development of the Aerosol Envelope Sealing Method

Aerosol sealing has been used successfully for residential duct sealing for more than 15 years, where it has been shown to seal duct leaks with a width of up to 5/8 in. (Modera et al. 1996). This technology was adapted by the WCEC for sealing leaks in the building envelope. The process involves pressurizing the building while dispersing an aerosol sealant “fog” to the building interior (see Figure 4). As air escapes the building through leaks in the envelope, the sealant particles are carried to the leaks where they make contact and stick, sealing the leaks. The sealant particles require an impact to adhere to a surface, so sealant material does not deposit on walls or ceilings except for at leak sites; sealant will settle onto horizontal surfaces due to gravity, so to avoid unwanted deposition these surfaces should be covered. Initial proof-of-concept testing of the aerosol sealing process showed excellent results, sealing 40 in.² of leakage in a small-scale enclosure in less than 10 minutes (Harrington and Modera 2012).

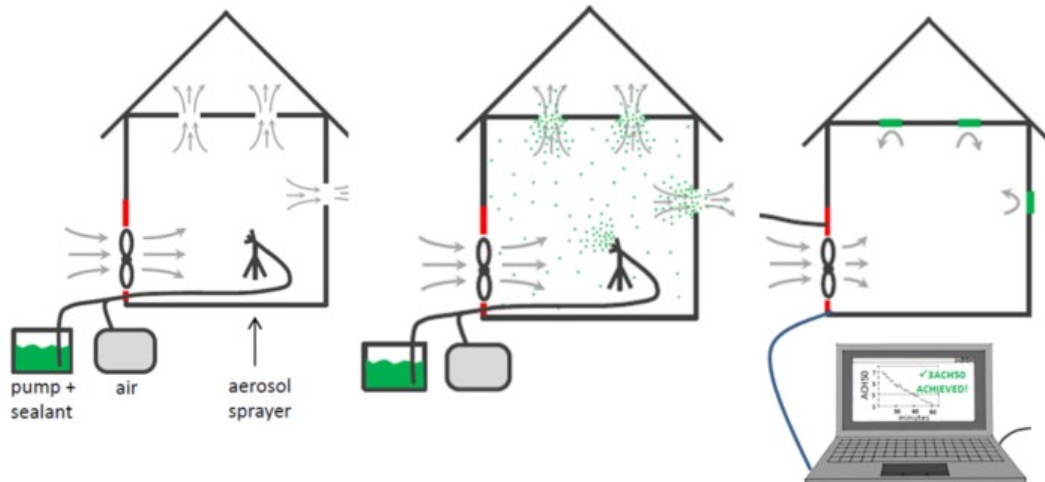

Figure 4. The progression of the sealing process from the start (left) to the end (right)

When the process is applied to envelopes, all openings not intended to be sealed are blocked with tape or plastic (e.g., exhaust ducts, gaps around doors, and open plumbing connections). Depending on the condition of the house during application, horizontal surfaces such as floors and countertops may need to be covered with plastic to protect them from sealant that settles during the process. There is usually no noticeable deposition on vertical surfaces or on the underside of horizontal surfaces. A standard blower door fan is used to pressurize the house, and provides real-time feedback and a permanent record of the sealing that occurred.

The sealant used for this project is a diluted version of a synthetic acrylic elastomeric material used as a spray or roll-on exterior air barrier. The sealant is GREENGUARD Gold Certified, meaning that it meets the strict certification criteria required for use in California schools and healthcare facilities. The sealant is tested according to various ASTM standards; however, because the sealant is atomized, the contractor should wear appropriate personal protective equipment and avoid entering the building during installation if possible. If entering the building is necessary, the contractor should wear a fitted respirator to prevent breathing the aerosol. No one else should be in the building during the sealing. When the installation is complete, the remaining aerosol is flushed out of the home by continuing to pressurize the space for several minutes after stopping the sealant injection.

Subsequent field demonstration projects showed the viability of the technology in larger spaces and practical application in real buildings. Because this project focused on new home construction, the following sections describe two single-family field demonstrations. However, there have also been demonstrations of the technology for multifamily applications (Bohac et al. 2016; Maxwell et al. 2015), showing the potential for larger-scale application of the technology to different building types as well as modularity of the process for isolating individual compartments within a building.

2.1.1 Envelope Sealing of the Honda Smart Home

Several projects were completed during the development of the aerosol sealing method, including work on the Honda Smart Home in Davis, California. The Honda Smart Home is a net zero energy, two-story single-family home built to showcase some of the most advanced strategies to reduce the carbon footprint of U.S. homes. WCEC worked with Honda Motor Company to design the mechanical systems for the home and to demonstrate the aerosol envelope sealing process to reduce building shell leakage for better ventilation control and lower infiltration loads.

This building was initially sealed using standard methods, and the following photos show areas where the aerosol sealant found and sealed leaks that had not been properly sealed with foam and caulk. A demonstration of the aerosol envelope sealing process on the Honda Smart Home achieved a reduction in building air leakage from 5.5 ACH₅₀ to 1.0 ACH₅₀.² Photographs from this installation, including examples of seals formed, are shown in Figure 5 and Figure 6. The ultimate goal was to meet the very aggressive Passive House standard of 0.6 ACH₅₀ (Passive House Institute 2016), which requires that the air barrier be applied to the external building envelope.



Figure 5. Photos of the Honda Smart Home before aerosol envelope sealing application

² These envelope sealing results have not been published.



Figure 6. Photos of aerosol sealing installation on a single-family home, including examples of seals formed

The contractor was asked to use standard methods to seal leaks with a gap width greater than 0.25 in. (smallest dimension), because the time required to aerosol seal a leak has been shown to increase with the square of the smallest dimension (length or width) of the leak (e.g., it takes four times longer to seal a leak that is 0.5 in. across than to seal a leak that is 0.25 in. across). Figure 7 summarizes the results of the demonstration, highlighting the three discrete phases in the sealing process. The first aerosol sealing application used an airless nozzle injection system with five injection points and without any temperature/humidity control. This injection reduced the building leakage from 4.2 ACH₅₀ to 2.6 ACH₅₀. After the first application, three contractors spent 24 person-hours attempting to further seal the building manually with expanding foam and caulk, resulting in an almost negligible impact on the overall tightness of the building shell. Finally, the aerosol envelope sealing process was applied again, this time using air-atomization nozzles and temperature/humidity control. That process reduced the building leakage from 2.6 ACH₅₀ to 0.8 ACH₅₀ in about 4 hours of total injection time. In summary, the Honda Smart Home demonstration revealed the advantage of using the aerosol envelope sealing process over standard manual sealing methods. Relying on manual sealing to accomplish the level of airtightness desired would have required a substantial amount of time and labor.

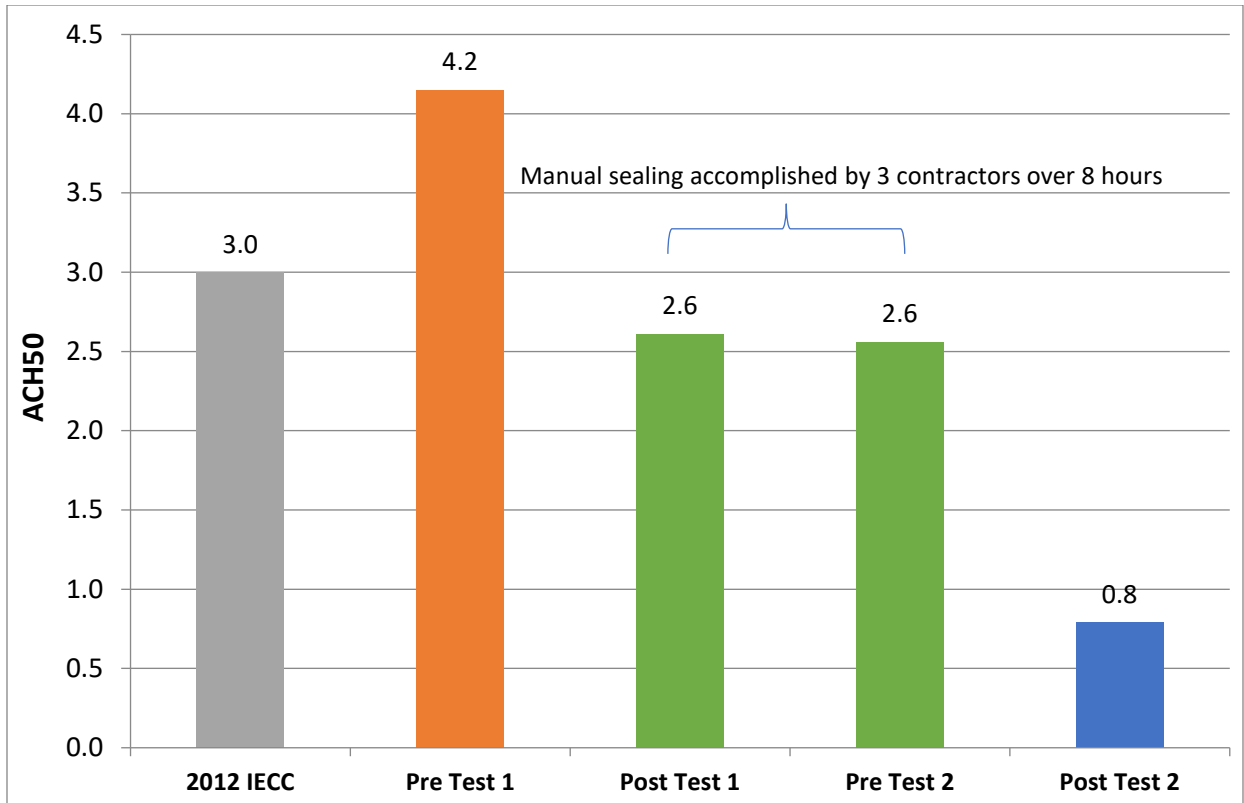

Figure 7. Summary of results from the aerosol envelope sealing demonstration in the Honda Smart Home

This demonstration provided a superb comparison of the performance difference between airless and air-atomization nozzles, as well as the impact of temperature/humidity control. Researchers found that while the airless atomization nozzles created a uniform particle size distribution, the air-atomization nozzles projected the aerosol with more initial momentum, allowing the aerosol to better fill the building space and promote evaporation of water from the sealant particles. However, the largest performance improvement resulted from controlling the relative humidity within the space. This was accomplished during the air-atomization application by simply heating the inlet air and controlling the liquid sealant flow rate. Evaporation of water contained in the sealant mixture is critical to allow the particles to reach the proper size and to adhere to leak sites.

In subsequent demonstrations, the performance of the air-atomization system significantly improved as work was expanded to multiple injection points, compared to the single injector nozzle that had to be moved around in the Honda Smart Home.

2.1.2 Production-Scale New Home Envelope Sealing

Another Building America-funded project was conducted to evaluate production-scale envelope sealing of new single-family homes (Harrington and Springer 2015). Table 1 presents the house leakage measurements performed pre- and post-aerosol sealing. The envelope leakage of the houses was reduced by 62% to 85%, with an average of 74%. Because the process was applied at a rough-in stage of new construction, it would be expected that a significant amount of the

existing leakage would be sealed manually in later stages of construction, the exception being duct leakage. The leakage data presented in Table 1 show the leakage measurement performed with HVAC ducts blocked and large holes temporarily covered.

Table 1. Summary of Aerosol Envelope Sealing Results

Test #	Pre-Sealing Leakage (ACH₅₀)	Post-Sealing Leakage (ACH₅₀)	Leakage Reduction (%)
1	9.1	3.4	62%
2	13.7	5.0	63%
3	11.5	1.7	85%
4	8.5	1.8	79%
5	12.4	2.5	80%
6	13.2	3.2	76%
Average	11.4	2.5	74%

The time required for setup, sealing, and cleanup was closely tracked. Most of the installation crew was the same for each installation. The process required an average of 11 person-hours to complete (see Table 2). It is reasonable to assume that with experienced personnel and commercialized equipment, the time required could be reduced to two people working 4 to 5 hours.

Table 2. Summary of Time Required for Each Step in Sealing Process

Test #	# Floors	Floor Area (ft ²)	Time Required (person-hrs)			
			Setup	Sealing	Cleanup	Total
1	2	3,550	6.3	1.5	5.0	12.8
2	1	2,019	5.9	1.4	3.4	10.6
3	1	2,324	6.7	1.2	4.2	12.1
4	2	3,550	6.9	1.9*	4.0	12.8
5	1	2,324	3.5	1.4	1.9	6.8
6	1	2,324	4.6	1.3	3.4	9.3
Average	1.3	2,682	5.7	1.4	3.7	10.7

* The air compressor ran out of fuel, causing a pause in the sealing.

2.1.3 Aerosol Sealing Commercialization

Following the success of initial demonstrations of the aerosol sealing process, WCEC pursued a licensing agreement with the sealing company AeroSeal. In 2014, UC Davis’s intellectual property office marketed the process to look for companies interested in licensing the technology. AeroSeal beat out several other entities based on their proposed business model for the technology. The aerosol envelope sealing technology was officially licensed to AeroSeal in 2016 and received the International Air-Conditioning, Heating, Refrigerating Expo (known as AHR Expo) “Product of the Year” award. It also received the 2018 International Builders’ Show “Best in Show” and “Most Innovative Building Product” awards. The technology is being commercialized under the name AeroBarrier. There are currently more than 75 dealers in the United States and Canada.

2.2 Non-Energy Impacts

In addition to lower energy costs from reduced heating and cooling loads, a tighter house envelope may have numerous other effects:

- The control of air movement with a tight assembly is necessary for proper moisture control. High-R building envelope assemblies are commonly designed to withstand moisture diffusion through the assembly. However, water vapor diffusion is often an insignificant source of envelope moisture transport (Straube 2007). Moisture condensation from winter exfiltrating air and summer infiltrating air through air leaks in wall and other envelope cavities is one of the two major sources of moisture in above-grade enclosures (rain is the other). In other words, “vapor is principally transported by air flow not by vapor diffusion” (Lstiburek 2015). Aerosol sealing of envelope air leaks

will reduce the convective movement of air and moisture through envelope cavities. This will help assure that high-R enclosures perform as predicted, therefore improving wall moisture control and reducing risks for long-term moisture damage.

- A tighter envelope reduces air infiltration, which can improve occupant comfort by reducing drafts. Reducing infiltration can improve indoor air quality by reducing the intrusion of outdoor air contaminants into the house. For example, Logue et al.'s (2012) estimate of the health impact of indoor air pollutants found that particulate matter (PM_{2.5}), acrolein, and formaldehyde accounted for more than 80% of the health impact (e.g., disability-adjusted life years lost), and that indoor PM_{2.5} is due to both indoor sources and infiltration of outdoor PM_{2.5}. Reducing outdoor PM_{2.5} infiltration and improved filtration of indoor air can greatly reduce indoor PM_{2.5}. However, air infiltration can significantly reduce concentrations of pollutants that are predominantly due to indoor sources when there is not sufficient mechanical ventilation. Mechanical ventilation is required for the Minnesota and California houses in this study, and in Minnesota the ventilation system must be balanced. This project did not monitor indoor pollutant levels to evaluate the impact of house tightness and mechanical ventilation system operation, as that was beyond the project scope.
- A tighter envelope can create greater house depressurization when exhaust fans and appliances are operated. This can lead to combustion spillage issues for natural and induced draft combustion appliances. However, builders are typically aware of this concern and have not included natural or induced draft combustion appliances in moderately tight or tighter houses. For example, power and direct vent combustion appliances are now the norm for Minnesota new construction.

2.3 Envelope Air Leakage Requirements

2.3.1 International and Minnesota Energy Conservation Codes

The 2009 version of the International Energy Conservation Code (IECC 2009) was the first version to include envelope air leakage testing. Air sealing details could be confirmed with visual inspections or an air leakage test performed to confirm that the leakage is less than 7.0 ACH₅₀. In 2012, the International Energy Conservation Code (IECC) changed the envelope leakage test from being an option to a requirement (IECC 2012):

R402.4.1.2 Testing. The building or dwelling unit shall be tested and verified as having an air leakage rate of not exceeding 5 air changes per hour in Climate Zones 1 and 2, and 3 air changes per hour in Climate Zones 3 through 8. Testing shall be conducted with a blower door at a pressure of 0.2 inches water gauge (50 Pa). Where required by the code official, testing shall be conducted by an approved third party. A written report of the results of the test shall be signed by the party conducting the test and provided to the code official. Testing shall be performed at any time after creation of all penetrations of the building thermal envelope.

The 2015 and 2018 versions (IECC 2015 and IECC 2018) of the testing and leakage requirement is identical to 2012 version, except the phrase “with a blower door” is replaced with “in accordance with ASTM E 779 or ASTM E 1827 and reported...”

A Minnesota state law was enacted in 1975 to require building design and construction standards consistent with the most efficient use of energy (Minnesota Department of Labor and Industry 2017). In response, an energy code became effective on January 30, 1976, as part of the state building code. In 1979, individual counties outside of the seven-county Minneapolis-St. Paul area as well as incorporated cities with populations of less than 2,500 were given the option of enforcing a statewide building code. Many elected to have no enforcement within their area. Currently, enforcement occurs for about 80% of the population base. In 2015, Minnesota adopted the 2012 version of the International Energy Conservation Code with state amendments. Section R402.4.1.2 was adopted without amendments. Because Minnesota is in climate zones 6 and 7, all new single-family houses must be tested for envelope leakage and have an air leakage rate no greater than 3.0 ACH₅₀.

A majority of the homes built in Minnesota are served by utilities that have residential new construction energy efficiency programs. In general, the programs provide a tiered financial incentive for high-efficiency houses based on a modeled comparison of the house’s annual energy use vs. the use for the same house that only meets code-minimum requirements. Reducing the envelope leakage to below the code-required level of 3.0 ACH₅₀ will make it more likely that a house will qualify for the program and produce a higher incentive. For example, the current Xcel Energy Efficient New Home Construction program provides incentives for houses that exceed Minnesota’s energy code and baseline requirements by at least 10% (Xcel 2019). For natural gas heated houses, the incentive starts at \$250 and increases to \$2,000 for houses with total energy savings that are at least 35% above the baseline.

2.3.2 California Energy Code

California’s Title 24 building codes have been around for more than 40 years and reduce building energy consumption in the state. The code is updated on a three-year cycle, with 2019 code going into effect in January 2020. Title 24 code has yet to require specific levels of air leakage in new single-family homes. The default value used in the compliance modeling software is 5.0 ACH₅₀, and builders can earn additional energy credits by reducing leakage below 5.0 ACH₅₀. Although air leakage testing is not required for standard construction, air leakage testing is required when claiming credits for reducing air leakage below the default value. Additionally, California utilities offer incentives for builders achieving a high-performance home. The California Advanced Home Program provides builders with up to \$1,950 in incentives for reducing energy use compared to the baseline model, with an additional \$100–\$300 for reducing building air leakage.

3 Objectives

Almost all previous new construction applications of aerosol sealing involved applying the sealant after wall and ceiling drywall was installed and taped. Aerosol sealing had been used to augment manual sealing methods used to create a tight envelope. This process resulted in limited surface preparation, an air barrier at interior surfaces, and 60% to 90% improvements in envelope tightness. This project was designed to address a number of questions to optimize the application of aerosol sealing for the single-family new construction process:

- **In what situations is it effective to perform aerosol sealing prior to drywall?**

Performing the aerosol sealing while the interior surface of the exterior wall sheathing is still exposed (i.e., before insulation and drywall is installed) creates an air barrier at the sheathing. Because a large fraction of the seals will be encased in the wall cavity after the drywall is installed, the seals will be well protected for the remainder of the construction process. Seals encased in cavities may have greater long-term durability, but that was not studied as part of this project.³ In order to perform pre-drywall aerosol sealing, an air barrier must be in place at the top of the house, and that may not occur until the ceiling drywall is installed. That may require modifications to the builder's construction process. If this is feasible, there would be a trade-off between any negative impact on the construction process and the benefit of the aerosol sealing occurring at the exterior wall sheathing.

As noted previously, the two major sources of wall moisture are rain and condensation from winter exfiltrating air and summer infiltrating air through air leaks (Straube 2007). A tighter envelope will reduce the convective movement of air and moisture from the inside to the outside (or vice versa) of the envelope regardless of whether the air barrier is located at the exterior or interior portion of the envelope. However, air can move into and out of a wall cavity from the same side of the cavity. Wind-washing occurs when outside air enters one section of the wall and exits back to the outside through another due to differences in wind-induced pressure at the different locations. An air barrier located at the exterior portion of the envelope will help reduce wind-washing, which can be a concern for air-conditioned residences in hot-humid climates.

Pre-drywall aerosol sealing is not the only approach that creates an air barrier at the exterior portion of walls. Exterior air barriers can be created with sealed house wraps and exterior sheathing sealed with joint tapes, liquid-applied membranes, or fully adhered membranes. The drawback to exterior air barriers is that air can move into and out of cavities from the inside of the house, leading to the potential of condensation occurring on the exterior sheathing under cold ambient conditions. However, significant pressure

³ Long-term sealant durability is an important issue that was studied in a separate WCEC project (Modera and Harrington 2018). That project measured the change in house leakage from the time the sealant is applied to the end of the construction process.

differences between envelope cavities and the house interior are only likely to occur when cavities are used as ducts or leaky ducts are located in envelope cavities.

- **In what situations is it effective to perform aerosol sealing after drywall?** The amount of construction work completed before aerosol sealing impacts sealing costs and envelope tightness. Sealing immediately after drywall installation minimizes surface preparation and clean-up times, but maintaining the achieved tightness requires manual sealing of any additional penetrations to the air barrier or disturbances to the aerosol seals. The additional penetrations can be due to additional electrical (e.g., recessed can lights), HVAC (e.g., exhaust fans), or plumbing (e.g., shower fixtures) work. Completed seals can be disturbed by numerous construction activities that come in contact with the seals, including final wiring of devices in electric boxes and installing trim. Delaying the aerosol sealing reduces manual sealing and increases the labor and material costs for protecting any finished horizontal surfaces that are in place when the sealing is performed. The optimal time for the aerosol sealing depends on the trade-off between manual sealing and surface protection costs.
- **What conventional sealing can be eliminated?** Aerosol sealing is highly effective at sealing narrow diffuse envelope leaks, producing tightness levels well below code requirements. The cost-effectiveness of aerosol sealing can be improved by eliminating conventional manual sealing methods, particularly those used to seal small gaps in air barrier penetrations and joints between sections of air barriers. For example, minor leaks that are sealed by caulk or foam are good candidates to be sealed by the aerosol method when applied at the appropriate stage of construction. Spray foam insulation of rim joists could potentially be replaced by aerosol sealing and less expensive batt insulation and vapor retarder. The aerosol sealing would provide the air barrier, so the vapor retarder would not need to be air sealed. Aerosol sealing has the potential to reduce labor and material costs for conventional sealing, in addition to reducing contractor training and quality control for assuring that code required tightness is achieved.
- **Can aerosol sealing address “challenge” areas?** Another opportunity is to examine specific sections of the air barrier that are often a challenge (e.g., areas with numerous penetrations, surfaces that do not intersect at right angles, and staircases or other framing that interrupt the air barrier surface) to determine ways that the aerosol method can more reliably and effectively seal those sections. Aerosol sealing of single-family new construction houses has been performed on a limited sample of houses. Not all types of challenge areas have been included in previous studies. This project performed aerosol sealing on a greater variety of challenge areas.
- **Can the aerosol sealing process be improved?** Experience from aerosol envelope sealing of the test houses in this project helped improve aerosol sealing protocols and equipment. The process in place at the start of the project evolved with feedback from additional field demonstrations. There had been recent, significant improvements to allow

for automated control of each component. It was expected that automated variation of the injection rate would more reliably produce the desired relative humidity of the inside air while reducing technician oversight. Experience from test houses helped refine the automation process and equipment. Feedback provided additional guidance on issues such as injection nozzle placement and the maximum and minimum areas for each nozzle. Finally, for many homes, aerosol sealing continued after the code required or target leakage was achieved. When the sealing rate was above a specified level, the sealing continued to determine the feasibility and cost-effectiveness of sealing beyond code requirements.

4 Methodology

This project provided the research needed to successfully integrate aerosol envelope sealing into the home building process. The project team worked directly with builders to identify the best stages for incorporating aerosol sealing, from the perspectives of net cost, performance, and ease of integration into the construction process. The cost of the aerosol sealing and resulting house tightness was documented for a sample of houses and compared to a similar group of houses using conventional sealing methods. Conventional sealing methods were evaluated to determine whether they could be eliminated or reduced to further improve cost-effectiveness while still achieving the required house tightness. For typical builders, the tightness goal is the level required by code—5.0 ACH₅₀ is the assumed building airtightness in California when following the prescriptive sealing process, and 3.0 ACH₅₀ is the code requirement in Minnesota. These were the target values for the two California builders and most of the Minnesota builders, but two of the Minnesota builders had a target of 1.0 ACH₅₀, and the project had a stretch goal of 0.6 ACH₅₀ for all of the Minnesota builders. The different levels of required tightness helped identify the difference in sealing approaches (i.e., the extent of conventional sealing and quality control) needed to achieve each level. The results should better inform sealing approaches needed to achieve tightness levels required for high-performance houses.

4.1 House Selection Criteria

The objective was to work with national and local production home builders that use common construction methods so that results would be applicable to a large percentage of new construction houses. The number of houses sealed for this project was not expected to provide a statistically representative sample to determine the distribution of house tightness for various house types. Instead, the number of houses was expected to determine the feasibility of achieving a tightness target for the aerosol sealing applied at a particular time of construction and eliminating some conventional sealing. Standard air leakage test methods were used to accurately measure pre/post changes in leakage. Systematic inspection procedures documented the location and quality of the seal of individual envelope air leaks.

The project did not apply a rigid definition of “common construction,” but the team expected that the houses would be site-built, wood-framed, cavity-insulated structures with conventional sheathings, typical exterior water management (such as building paper or house wrap), and interior air barrier and vapor retarder (such as poly or smart vapor retarder). Researchers wanted the houses to include air sealing details that were well suited for aerosol sealing as well as “challenge” areas where aerosol sealing may have a competitive price advantage over conventional sealing. These areas could include rim joists that are being sealed with spray foam, bump outs, cantilevers, tuck-under garages, and attached garages.

The initial target was single-family detached houses. Houses with the following construction types were not included:

1. Structural insulated panels
2. Exterior air barrier using self-adhered modified bituminous membrane sheets
3. Exterior air barrier using liquid-applied sealant
4. Exterior air barrier system using precast, site-cast or tilt-up concrete panel.

Builders selected for the project needed to have a sufficient number of houses under construction that met the construction type requirements described above. The first builder in each state needed to provide seven houses of similar construction that could be sealed within a 10-month period and four control houses of similar type that would be constructed during the same period. In order to provide scheduling flexibility, it was expected that the builder would be constructing at least 40 to 60 houses per year. The second builder in each state could be a lower-volume builder—they only needed to provide four houses to be sealed over 10 months and four control houses. Each builder needed to be willing to provide sealing cost estimates and to eliminate some sealing methods from their test houses. Researchers initially recruited builders who attended a builder kick-off meeting and others who expressed interest in the aerosol envelope sealing technology.

4.2 Technical Approach

The project team used a stepwise, iterative approach to develop and refine aerosol envelope sealing guidelines. This approach allowed experience from an initial set of houses sealed for the first builder to refine sealing methods for a second set of houses for the same builder. The work was staged so that as the second set of houses was being completed for the first builder, the planning started for an initial set of houses for the second builder. Parallel efforts were used for two builders in California and two in Minnesota. The work in Minnesota was later expanded to include an additional five builders to evaluate sealing methods for types of construction that were not included with the first two builders.

The multistep process for each builder is shown in Figure 8 and described in more detail here:

1. **Hold initial meeting and assess houses.** The project team met with the builder to discuss their typical manual air sealing practices and review the field work timeline. The project team then performed air leakage assessments and tests on two or three representative houses.⁴ At least one of the houses was at the pre-drywall stage of construction, after the insulation and air sealing had been completed. When feasible, the second house was at the framing inspection stage to identify air leakage locations, and the third house was close to occupancy. Additionally, the builder provided

⁴ Section 4.3 Envelope Leakage Assessment provides a description of the assessments.

- available air leakage test results for houses built within the past year that were in close proximity and type to the houses used in the study.
2. **Demonstrate aerosol sealing.** Aerosol envelope sealing was demonstrated on one house that was under construction. It was preferred that the demonstration house would be at the same stage of construction as that for the first set of houses for the builder. Appropriate builder representatives were on-site to observe the sealing process and participate in the visual identification of remaining leakage after the sealing was complete. The demonstration was not performed for builders that already had experience with the aerosol envelope sealing process.
 3. **Develop options for aerosol sealing.** Project team members met with builders to review findings and identify sealing options. The options considered the findings from the baseline leakage assessment, the initial feedback from the builder, and the results from sealing work conducted on houses already sealed for the project. The protocol considered the stage of construction during which the aerosol sealing was applied and the conventional sealing that was eliminated. Although the sealing options were specific to each builder, experience from one builder was applied to improving the process for the others. Two sealing options were identified for the first builder in each state, and one option was used for the other builders.
 4. **Perform aerosol sealing and evaluate impact.** Each of the aerosol sealing options was applied and evaluated. Assessments of the aerosol-sealed houses were performed (1) prior to sealing, (2) immediately after sealing, and (3) after construction was complete. An assessment was also conducted after construction was complete for each control house that received conventional sealing. Sealing experience, pre/post/finished assessments, and pre/post/finished leakage tests of aerosol and conventionally sealed houses were summarized in a report for the builder's houses.
 5. **Review results with builder and generate updated sealing option.** An in-person meeting was conducted with the builder to get feedback from the first set of houses sealed. The project team and builder considered the advantages and disadvantages of the sealing options. The sealing options were revised as necessary to establish an updated approach.
 6. **Perform aerosol sealing and evaluate impact.** The revised aerosol sealing options were applied and evaluated. Similar to Step 4, assessments of the aerosol-sealed houses were performed (1) prior to sealing, (2) immediately after sealing, and (3) after construction is complete. An assessment was also conducted after construction was complete for each control house that received conventional sealing. Sealing experience, pre/post/finished assessments, and pre/post/finished leakage tests of aerosol and conventionally sealed houses were summarized.

7. **Review results with builder.** An end-of-project interview was conducted with each builder to get their feedback about the aerosol envelope sealing process. The objectives were to get the builder’s perceptions of the advantages and disadvantages about the process as well as how they see it being incorporated into their construction process. Project staff conducted the interviews using 12 open-ended questions to initiate an informal discussion. The script and questions are included in Appendix A.

For the first builder in each state, four or five houses were sealed in Step 4 to accommodate two different sealing options. The refined method for Step 6 was applied to two or three houses. It was expected that the sealing options would be narrowed for the second builders in each state. For those builders, one or two houses were sealed for Step 4 and another two or three for Step 6. It was expected that at least 11 houses would be sealed in each state. Ultimately, the sealing included 11 houses in California, 15 houses in Minnesota,⁵ and one triplex in Illinois. The experience from all the sealing was used to identify best sealing practices based on the type of construction and builder’s air sealing goals.

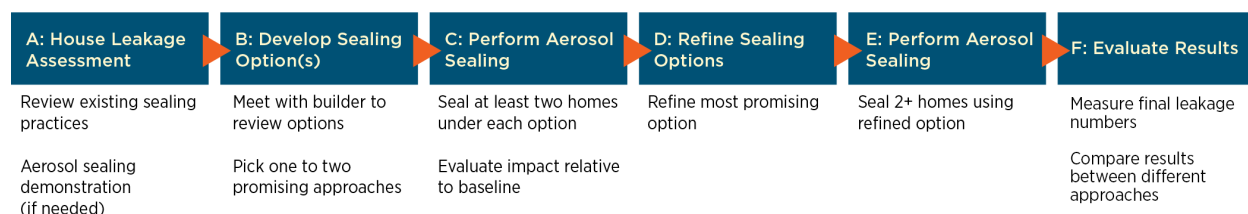

Figure 8. Iterative approach to evaluate aerosol sealing options

4.3 Envelope Leakage Assessment

Short-term house assessments used quantitative and qualitative methods to evaluate envelope leakage at three points in the construction process: (1) prior to aerosol sealing, (2) after aerosol sealing, and (3) after construction is complete. In addition, staff worked with AeroBarrier to estimate the cost of aerosol sealing and with the builders to determine avoided cost of conventional sealing. No continuous monitoring was conducted for this project.

Every house envelope air leakage assessment included a quantitative whole-house envelope leakage (e.g., blower door) test and qualitative visual assessment of leakage. When weather conditions and house availability allowed, an infrared scan was used to assist with leakage identification. Additionally, the leakage of individual spots or sections of the envelope was measured by guarded leakage tests, or individual leakage site tests. These additional measurements were conducted when conditions allowed, and there was significant value in the more detailed information. The following subsections provide a description of the assessment methods.

⁵ The 15 houses in Minnesota included two demonstration houses.

4.3.1 House Envelope Leakage Test

A whole-house envelope leakage test (i.e., blower door test) was the primary method for quantifying house leakage. Almost all of the tests were conducted as a multipoint test in accordance with either the RESNET 380 Procedure for Measuring Air Tightness of Building Enclosure (RESNET/ICC 380 2016) or ASTM E 779-10 Standard Test Method for Determining Air Leakage Rate by Fan Pressurization (2010).⁶ All tests of California houses and end-of-construction tests of Minnesota houses were conducted as depressurization tests, because a depressurization test is most commonly used to measure house envelope leakage. The pre- and post-aerosol sealing tests of Minnesota houses were conducted as pressurization tests to avoid damaging the exposed poly sheets on the second floor ceilings.⁷ The envelope leakage was reported as the leakage rate at a pressure difference of 50 Pa (CFM₅₀). The leakage was divided by the house volume to generate a normalized house leakage in units of air changes per hour at 50 Pa (ACH₅₀).

The house setup and test procedures were followed as specified in the test standards. However, in some cases, the house mechanical and plumbing systems were not complete at the time of the aerosol sealing. For the pre- and post-aerosol sealing tests it was necessary to temporarily seal openings such as clothes dryer exhaust vents, heat recovery ventilator terminations and inlets not connected to the system, exhaust fan ducts, supply ventilation ducts, and open plumbing waste pipes without filled traps. Except for inlet and exhaust ducts without dampers of continuously operating ventilation systems, the temporary seals in place at the time of the aerosol sealing were not in place for the end-of-construction tests. Consequently, for each house the setup and type of test (e.g., pressurization or depressurization) was always the same for the pre- and post-aerosol sealing tests. There was no change in test procedure that biased the reduction in house leakage due to aerosol sealing. However, the unsealed openings could have been a source of increased leakage at the end-of-construction test, and for the Minnesota houses the switch from a pressurization to depressurization test could have impacted the leakage measurement. All baseline and depressurization or pressurization measurements were averaged over a period of at least 15 seconds. Each multipoint leakage test typically included eight points for pressure differences ranging from 20 to 60 Pa. The change in pressure between points was usually 10 Pa, with 5 Pa differences for measurements closer to 50 Pa and a duplicate measurement at 50 Pa. A common sequence was to record measurements at 20, 30, 40, 45, 50, 50, 55, and 60 Pa. The baseline pressure difference was recorded before and after the fan-on points. The elevation, inside air temperature, and outside air temperature were used to adjust the flow rates to standard conditions. The multipoint analysis specified by ASTM E 779-10 for a power law relationship was used to report the leakage flow rate at a pressure difference of 50 Pa.

⁶ A single-point test at 50 Pa was used to measure pre-aerosol sealing leakage for half of the Minnesota houses. The accuracy of the leakage at the start of the process was less important than the leakage after sealing and at the end of construction.

⁷ There were two houses where the poly sheeting was covered by drywall, but a pressurization test was performed for those houses so that the procedure was consistent for all Minnesota houses.

The envelope leakage tests were conducted using two types of variable-speed calibrated test fans. The larger fan (TEC Model 3 fan) has a capacity from approximately 300 to 6,300 cfm, and the capacity of the smaller fan (TEC Duct Blaster) is approximately 10 to 1,500 cfm. The fans have a manufacturer-specified accuracy of 3% of the flow rate. Pressure measurements were performed using a two-channel digital micromanometer (TEC DG-1000 or DG-700) that was calibrated in accordance with manufacturer guidelines and has a specified accuracy of the greater of 0.15 Pa or 1.0% of the measurement.

4.3.2 Visual Inspection

The visual inspections qualitatively evaluated the tightness of the house air barrier. The inspection included the use of a smoke puffer to help estimate the relative magnitude of the air leakage. Researchers developed a checklist of common leakage sites to guide the inspection process and provide structure to the results. The visual inspection checklist is based on the Air Leakage section of the EPA ENERGY STAR® Rater Field Checklist (EPA ENERGY STAR 2015) and the 2015 IECC Table R402.4.1.1 Air Barrier and Insulation Installation Air Barrier Criteria.

Table 3 shows the seven categories and 26 components that were included in the checklist. The inspections provided information about the quality of sealing work (excellent, acceptable, poor, no attempt), who performed the sealing, what material was used, and the potential for aerosol sealing to replace traditional methods. A list of predefined responses was provided to reduce data collection time and aid the interpretation, normalization, and reporting of results. Field staff recorded notes and pictures of key sealing details. The results for one of the builders are included in Table 3, and Appendix C includes the results for all of the builders.

Table 3. Visual Inspection Checklist: Categories and Components

Category	Component	Who Does Sealing?	Material Used for Sealing?	Can AeroBarrier Replace?	Quality of Seal Work
Ceiling/Attic	Attic access panels	N/A	Gasketed door	No	Excellent
	Drop down stairs	N/A	N/A	N/A	N/A
	Whole-house fans	N/A	N/A	N/A	N/A
	Recessed lighting fixtures	N/A	Gasketed fixture	Yes	Excellent
	Drop ceiling/soffit	Insulation contractor	Closed cell spray foam	Yes	Excellent
Walls	Exterior walls	Insulation contractor	Gasket/OSB	N/A	Excellent
	Sill plate	Carpentry contractor	Gasket/OSB	Yes	Acceptable
	Top plate	Insulation contractor	Gasket	Yes	Acceptable
	Drywall to top plate	Insulation contractor	Gasket	Yes	Excellent
	Interior partition wall to exterior wall	Carpentry contractor/ Insulation contractor	Solid blocking/ can foam	Yes	Excellent
	Knee walls	Carpentry contractor	OSB	N/A	Excellent
Windows, Skylights and Doors	Rough openings	Insulation contractor	Can foam	Yes	Excellent
Rim Joists		Insulation contractor	Open-cell spray foam	Yes	Excellent
Shafts, Penetrations to Unconditioned Spaces	Ducts	Insulation contractor	Can foam/ open-cell spray foam	No	Excellent
	Flues	Insulation contractor	Can foam/ open-cell spray foam	No	Excellent
	Shafts	Insulation contractor	Can foam/ open-cell spray foam	No	Excellent
	Plumbing	Insulation contractor	Can foam/ open-cell spray foam	Yes	Excellent
	Piping	Insulation contractor	Can foam/ open-cell spray foam	Yes	Excellent
	Wiring	Insulation contractor	Can foam/ open-cell spray foam	Yes	Excellent
	Exhaust fans	Insulation contractor	Can foam/ open-cell spray foam	Yes	Excellent
	Other	N/A	N/A	N/A	N/A
Garage Separation Walls	Floor cavities aligned with garage separation walls	Carpentry contractor/ insulation contractor	Blocking/ open-cell spray foam	No	Excellent
Other	Shower/tub on exterior wall	Carpentry contractor/ insulation contractor	OSB/ open-cell spray foam	Yes	Excellent
	Stair stringer on exterior wall	N/A	None	Yes	N/A
	Fireplace on exterior wall	N/A	N/A	N/A	N/A
	Electrical/low voltage boxes on exterior walls	Insulation contractor	Can foam/ open-cell spray foam	Yes	Excellent
	HVAC register boots that penetrate building thermal envelope	Insulation contractor	Open-cell spray foam	Yes	N/A

4.3.3 Individual Leakage Sites

The leakage of individual isolated sites located on a flat surface can be measured by placing an airflow metering device over the area during a whole-house depressurization leakage test. This is an accepted method to measure the leakage of a variety of sites, including plumbing penetrations, duct penetrations, recessed light cans, and electric outlet boxes. A flow measurement device was placed over the leakage site at the house interior (e.g., wall or ceiling surface) while a blower door was used to depressurize the house to -50 Pa. Leakage flow rate measurements greater than 10 cfm were conducted with a TEC FlowBlaster airflow device, a powered flow hood that

creates approximately zero pressure difference across the meter during the measurement. Consequently, the measured flow rate is the flow through the leak at the induced envelope pressure. A custom calibrated TEC Exhaust Fan Flow Meter was used for lower flow rates. An orifice plate with multiple 1-in. diameter holes was placed over the standard opening. The relationship between the pressure across the plate and the flow rate was determined for one and multiple open holes. For the leakage measurement, a sufficient number of holes were opened to minimize the pressure difference across the box while still providing a reasonably accurate measurement.

4.3.4 Guarded Leakage Test of Triplex Units

A compartmentalization air leakage test measured the total (exterior and interior) air leakage of the triplex units. The change in total leakage was the primary assessment to determine the impact of the air sealing on envelope leakage of the unit. A TEC Duct Blaster was installed in the hallway door of the unit being tested, and the adjoining units were opened to the hallway, which in turn was opened to the outside (see Figure 9). A multipoint leakage test was conducted in accordance with the RESNET 380 Procedure for Measuring Air Tightness of Building Enclosure (RESNET/ICC 380 2016). All tests (e.g., pre-aerosol sealing, post-aerosol sealing, and end of construction) were conducted as depressurization tests. The mechanical system penetrations (e.g., clothes dryer vent, exhaust fans, heat recovery ventilator ducts, combustion air) were configured according to RESNET 380. If an appliance or damper was not in place for the test, the opening was temporarily sealed. The envelope leakage was reported as the leakage rate at a pressure difference of 50 Pa (CFM_{50}). The leakage was divided by the unit volume to generate a normalized leakage in units of air changes per hour at 50 Pa (ACH_{50}), and was divided by the envelope surface area to generate a per area leakage (CFM_{50}/ft^2). The compartmentalization test does not distinguish between the exterior and interior leakage.

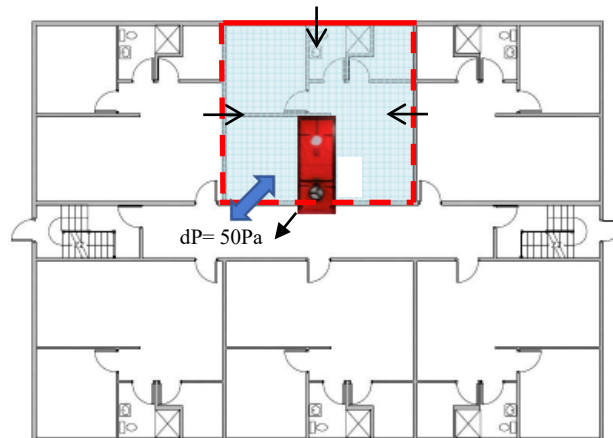

Figure 9. Test equipment configuration for a compartmentalization leakage test.

Figure from Paul Morin, TEC

A guarded air leakage test measured the air leakage through the exterior portion of the envelope. The diagram in Figure 10 shows the building and test equipment setup for conducting a guarded test of an individual unit (top/center) using additional fans located in a main entry. To measure the exterior leakage of the test unit, the main entry fans are operated to depressurize the whole building by 50 Pa. Except for the test unit, the hallway doors to all of the units are opened so that the building acts as a single zone. A blower door fan is located in the hallway door of the test unit. That fan is operated to maintain a zero pressure difference between the test unit and the hallway adjoining the test unit. With this configuration, the only airflow into the test unit is from the exterior. Consequently, the flow through the test fan in the unit is equal to the exterior envelope leakage of the unit.

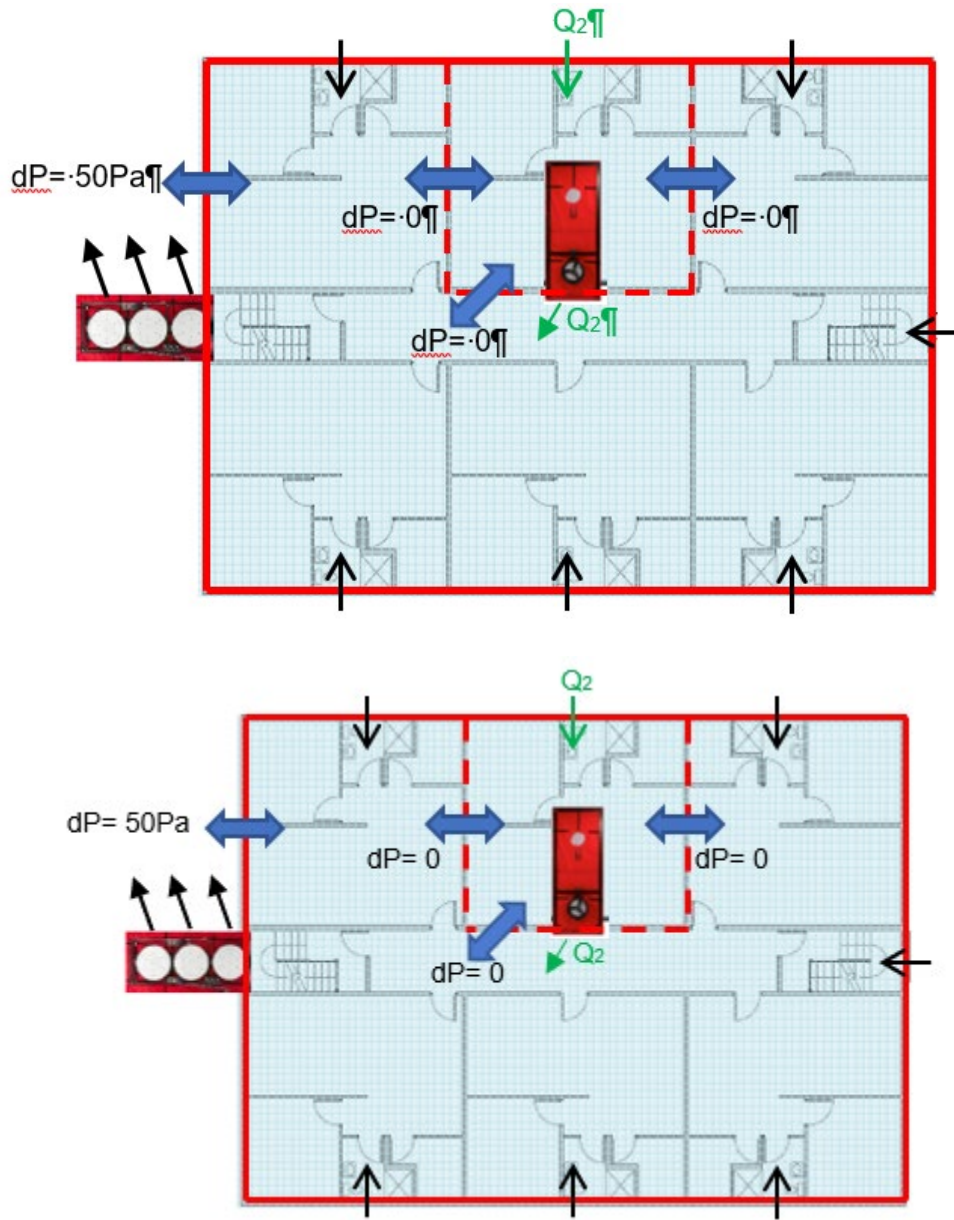

Figure 10. Test equipment configuration for guarded leakage test

Figure from Paul Morin, TEC

There are no standards that provide a protocol for conducting guarded leakage tests. Procedures developed for a DOE-funded project to conduct whole-building guarded tests of low-rise multifamily buildings were adapted for this project.

4.3.5 Infrared Inspection

An infrared scan assists in the identification of significant envelope air leaks. The infrared scan covers large sections of the enclosure surface in a relatively short amount of time to identify likely leakage locations. When an infrared scan was conducted for this research, it was typically performed from the house interior as a two-step process to differentiate between insulation deficiencies and envelope air leaks (ASTM E1186-17 2017). For the first step of the process, a scan of the interior surface of the envelope was performed with the house in “as-found” conditions. This documents thermal anomalies from insulation deficiencies (e.g., voids) and significant air leakage from wind and stack effects. The scan was then repeated with the house depressurized 15 to 25 Pa by a test fan. When the outside temperature was lower than the inside temperature, surfaces that were colder than observed during the initial scan indicated air leakage. When the outside air was warmer than inside, air leaks appeared as new warm spots. Depending on the sensitivity of the infrared camera and other variables (e.g., wind speed and solar heating of exterior surfaces), a difference in outdoor to indoor air temperature of at least 10°F was needed for the scan to be useful. Although an infrared scan cannot quantify air leakage, it is sometimes useful for quickly identifying leakage locations. Infrared scans were occasionally used in this research as a method for documenting envelope leakage, although aerosol sealing contractors do not typically use infrared scans for their sealing process.

4.3.6 Sealing Cost Estimates

Sealing costs were estimated for both conventional and aerosol sealing methods in order to determine the potential cost savings of replacing some conventional sealing work with the aerosol sealing technology. Based on past experiences, it was expected that the cost breakdown for conventional sealing in a home would be difficult to determine. Subcontractor bids for work generally do not include the details on labor and materials for specific tasks related to air sealing. In addition, the sealing can be conducted by multiple trades (e.g., insulation/air sealer, drywall installer, carpenter, electrician, plumber, and siding installer), and the trade responsible for the sealing tasks can vary by builder.

During the first round of builder meetings, there was a discussion of what sealing work is performed in a typical home. The research team conducted visual inspections of the leakage sites and asked the builder which trade was responsible for each of the sealing methods. The project staff estimated conventional sealing costs by speaking with the various trades responsible for air sealing work.

Because aerosol sealing is now a commercialized service available from AeroBarrier dealers, AeroBarrier staff and the dealers who participated in this project were consulted regarding their

cost estimating strategy. In general, the cost is primarily based on the house floor area. Similar to many construction tasks, there are other variables that also impact aerosol sealing costs, including: (1) manual pre-sealing to be performed by the dealer, (2) extent of surface protection required prior to sealing, (3) air leakage target, (4) pre-sealing air leakage, (5) stage of construction, (6) the proximity of a second house so that two houses can be sealed on the same day, (7) travel time, (8) single-family versus multifamily, and (9) the number of houses or multifamily units to be sealed. Currently, AeroBarrier estimates that aerosol sealing cost ranges from \$1 to \$2 per square foot of floor area for typical new home construction. The range and typical time to perform aerosol sealing were estimated for a subset of the homes by recording the time required to prep, seal, and cleanup.

5 Results and Discussion

Aerosol sealing was performed on 11 houses in California, 15 houses in Minnesota, and a triplex in Illinois. Table 4 displays key characteristics and sealing results for the project residences. For the two builders in California and first two builders in Minnesota, the sealing work was first conducted on a group of one to four houses that were designated as the Phase I group.

Experience gained from the Phase I houses was used to adjust sealing approaches or house characteristics for the group of Phase II houses. That work was performed for two builders in California on slab-on-grade houses with unvented and vented attics. The initial work with two builders in Minnesota for vented attic houses with basements was expanded to a total of six builders in order to help evaluate sealing methods for types of construction that were not included with the first two builders. Finally, a residence in Illinois was included to document the effectiveness of aerosol sealing process for slab-on-grade, two-story triplexes for which the builder historically had difficulty meeting an envelope leakage requirement. Table 4 also includes the stage of construction for the application of the aerosol sealing. In general, the sealing was either performed at a relatively early stage (e.g., before installation of wall insulation and drywall) or near the end of construction (e.g., post-drywall).

Table 4. Key Characteristics and Leakage Results for Aerosol-Sealed Residences

House #	Builder #	Sealing Phase	Floor Area (ft ²)	Attic Type	Foundation Type	Const. Stage for Sealing	Aerosol Leakage Reduction	End Const. Leakage (ACH ₅₀)	Sealing Time (Hours)
CA									
1	1	I-A	2,569	Unvented	Slab	Pre-Drywall & Post-Foam	75%	1.24	1.6
2	1	I-A	2,032	Unvented	Slab	Pre-Drywall & Post-Foam	73%	1.16	1.0
3	1	I-B	2,569	Unvented	Slab	Pre-Drywall & Pre-Foam	86%	1.00	3.1
4	1	I-B	2,223	Unvented	Slab	Pre-Drywall & Pre-Foam	84%	1.07	2.4
5	2	II	2,100	Unvented	Slab	Pre-Drywall	80%	1.77	1.1
6	2	II	1,900	Unvented	Slab	Pre-Drywall	81%	3.42	1.5
7	1	I	2,223	Vented	Slab	Post-Drywall	80%	3.35	1.4
8	1	I	2,223	Vented	Slab	Post-Drywall	80%	1.69	1.5
9	1	II	2,569	Vented	Slab	Post-Drywall	54%	3.97	1.1
10	1	II	1,595	Vented	Slab	Post-Drywall	70%	*	0.9
11	1	II	1,595	Vented	Slab	Post-Drywall	66%	3.26	1.1
MN									
12	3	Demo	3,338	Vented	Basement	Pre-Drywall	84%	0.76	2.4
13	3	I-A	4,361	Vented	Basement	Pre-Drywall	72%	0.90	2.3
14	3	I-A	3,913	Vented	Basement	Pre-Drywall	82%	0.92	1.8
15	3	I-B	4,186	Vented	Basement	Pre-Drywall & Post-Wall Insul	46%	0.82	4.8
16	3	I-B	4,428	Vented	Basement	Pre-Drywall & Post-Wall Insul	66%	**	4.6
17	3	II	3,972	Vented	Basement	Pre-Drywall	83%	0.77	1.8
18	3	II	4,360	Vented	Basement	Pre-Drywall	79%	1.09	1.6
19	4	Demo	4,135	Vented	Basement	Post-Drywall	50%	0.61	0.6
20	4	I	4,603	Vented	Basement	Pre-Drywall	78%	0.42	1.1

21	4	II	3,698	Vented	Basement	Pre-Drywall	82%	1.07	2.1
22	4	II	3,243	Vented	Basement	Pre-Drywall	70%	1.08	1.2
23	5	I	2,592	Vented	Basement	Post-Drywall	73%	0.96	1.5
24	6	I	2,074	Flat Roof	Slab	Pre-Drywall	74%	0.96	1.8
25	7	I	3,334	Vented	Basement	Pre-Drywall & Pre-Foam	88%	0.70	2.0
26	8	I	3,882	Vented	Basement	Pre-Drywall	81%	0.77	1.2
IL									
27	9	I	778	NA1	Slab	Post-Drywall	54%	3.82	1.5
28	9	I	778	NA	Slab	Post-Drywall	52%	2.97	2.1
29	9	I	1,282	Flat Roof	NA2	Post-Drywall	73%	2.51	1.2

5.1 California Houses

The houses sealed in California were split into two groups: unvented attics and vented attics. The unvented attic design is not commonly adopted by home developers but results in significant performance credits for meeting California code energy requirements, whereas the vented attic design is much more common for single-family homes. The iterative approach for working with contractors differed slightly from the approach described in the Methodology section (see Figure 8). Phase I for the homes with unvented attics was performed with California Builder 1, and Phase II was performed with California Builder 2. There were some differences in general construction style and insulation approach for the two builders, which impacted the aerosol sealing strategy. All homes sealed with vented attics were performed with California Builder 1.

5.1.1 Unvented Attics: Phase I

The project team conducted visual inspections of homes under various stages of construction, from installation of exterior sheathing to the drywall stage. The inspections, which were based on the ENERGY STAR Rater checklist for building air sealing, showed a high quality of air sealing. The homes were designed with unvented attics and used open-cell spray foam at the rim joist and under the roof deck to both insulate and provide air sealing. After the initial assessment, the project team met with the builder and determined two options for applying the aerosol sealing. Four homes were sealed, two using Option A and two using Option B (described next). The homes were all two stories and ranged in size from 2,030–2,570 ft².

Option A

Aerosol envelope sealing for Option A occurred after open-cell spray foam was installed at the rim joist and below the roof deck, but prior to the installation of drywall on the walls and ceiling (see Figure 11). No additional sealing was performed prior to the aerosol sealing. The pre-sealing results showed air leakage of 4.39 and 3.47 ACH₅₀ for the two homes during this stage of construction.



Figure 11. Photos of homes sealed under Option A showing open-cell spray foam at roof deck (left) and rim joist (right)

The aerosol sealing proved very successful. The overall time to seal each home, including prep and cleanup, took about 3 hours to complete. The leakage at the start of the sealing was between 3.5 and 4.4 ACH₅₀. Figure 12 shows the sealing profile for both sealing demonstrations under Option A. There were slight differences in the time required for sealing and the starting leakage rate, which is likely due to differences in the floorplan for the homes. For both houses, the rate of sealing is greatest at the start of the sealing and gradually decreases over time. The unique feature of aerosol sealing is that all leaks are sealed simultaneously as long as the sealant is dispersed uniformly through the house. Narrower leaks are quickly sealed, and wider leaks take longer to seal. The greater rate of sealing at the start of the process suggests that both houses had a large length of narrow gap leaks. The leakage dropped by 50% within 30 to 35 minutes. In both cases, the aerosol sealing reduced the leakage by about 75%, bringing them down to 1.11 and 0.95 ACH₅₀, which is roughly 80% below the California target of 5.0 ACH₅₀.

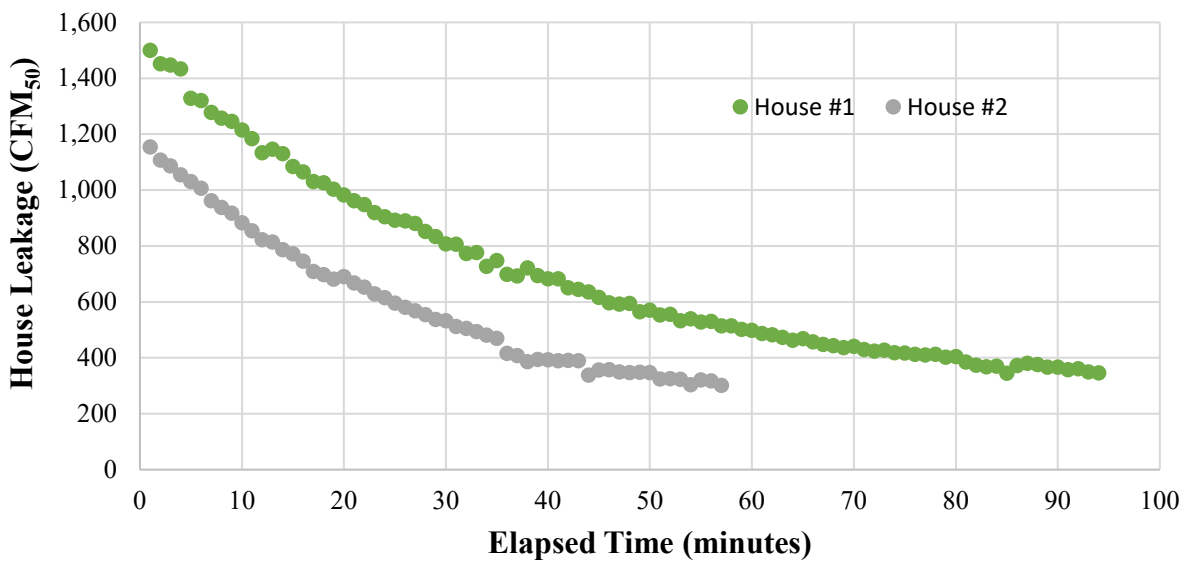

Figure 12. Sealing profile for both houses under Option A

Option B

For Option B, the aerosol envelope sealing occurred before open-cell spray foam was installed and represents the first opportunity to seal the homes, because the building shell is largely complete (Figure 13). Some manual sealing prior to aerosol sealing was required to block larger penetrations that would not be sealed efficiently with the aerosol. The time and materials required to perform that sealing were documented. There were some issues coordinating the sealing demonstrations with the home builder, which led to gaps at the eaves of the home that would normally have been blocked prior to the aerosol sealing. Additionally, there was manual sealing of other large penetrations. In the first house (#3) the pre-sealing effort was focused primarily on penetrations that were much too large to seal with the aerosol technology, whereas in the second house (#4), more care was taken to seal all gaps that were easily identifiable (could see daylight penetrating) regardless of whether the leak could be sealed with the aerosol technology. The time required and materials used are outlined in Table 5.

Table 5. Time and Materials Used to Manually Seal Homes Prior to Aerosol Sealing

		Sealing Penetrations		Sealing Gap at Eaves	
Stage	House #	Time for Manual Sealing (person-hrs.)	Cans of Foam Used	Time for Manual Sealing (person-hrs.)	Cans of Foam Used
Pre-Foam	3	1.5	3	1.5	4
Pre-Foam	4	4.5	6	1	4

After the two pre-sealing efforts, the leakage of the homes was 15.14 ACH₅₀ and 9.01 ACH₅₀ for houses #3 and #4, respectively. Clearly, the additional manual sealing effort for House #4 resulted in improved initial airtightness with an increased cost. Ultimately, builders and their AeroBarrier contractor need to evaluate the additional cost of manual sealing compared to the aerosol sealing performance differences and cost for their specific houses.

The aerosol sealing proved very successful at this stage of construction. The sealing injection time increased from the sealing under Option A, requiring 2–3 hours to complete. The overall time to seal each home, including prep and cleanup, took 4–5 hours to complete. Due to slight changes in the manual pre-sealing efforts in each building, the leakage at the start of the sealing was around 5,800 CFM₅₀ in one case and about 3,000 CFM₅₀ in the other. Figure 14 shows the sealing profile for both sealing demonstrations under Option B. The rate of air sealing was faster at the beginning of the installation and slowed as the process continued. The aerosol sealing reduced the leakage in both cases by about 85%, bringing them down to 2.15 and 1.43 ACH₅₀ before spray foam installation was installed. That is roughly 60%–70% below the California prescriptive target of 5.0 ACH₅₀.



Figure 13. Photos of houses sealed under Option B

Another leakage test on each home was performed after the spray foam installation to determine the additional sealing due to the insulation. After spray foam, the measured air leakage of the homes were 1.25 and 1.06 ACH₅₀, representing an additional leakage reduction of 6% and 4%, respectively, relative to the initial leakage of the homes. This result is only slightly higher than the result for using aerosol sealing after the spray foam installation under Option A.

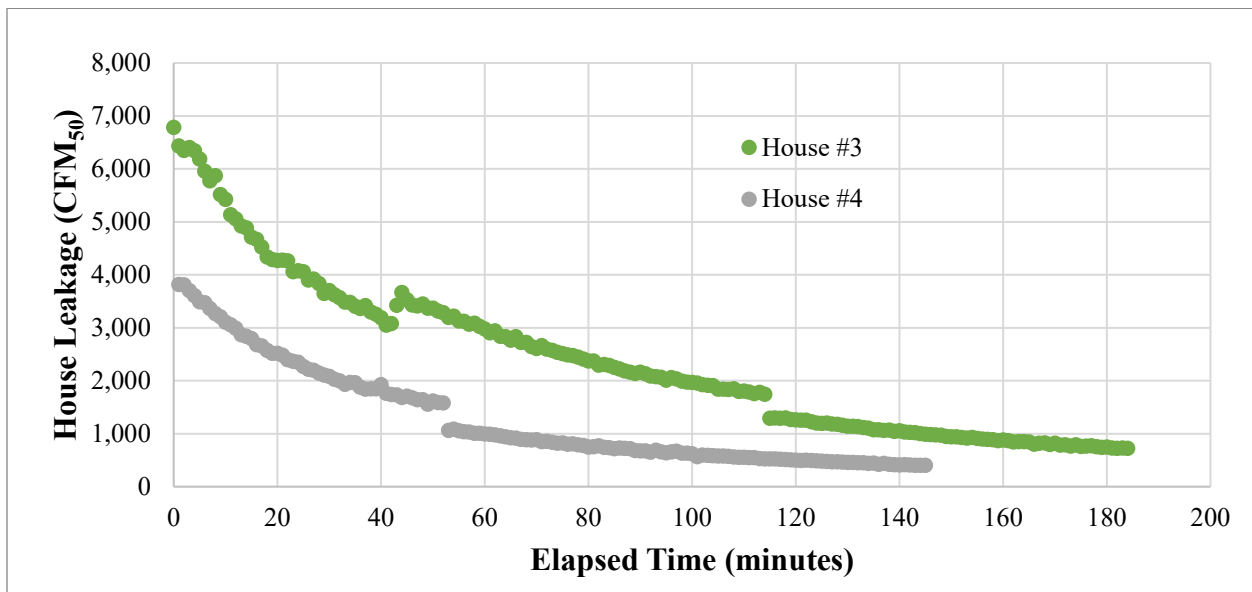

Figure 14. Sealing profile for both houses sealed under Option B (pre-foam)

Table 6 and Figure 15 provide a summary of all aerosol sealing results for the first round of tests for the Phase I homes. Overall, nearly 10,000 CFM₅₀ of air leakage was sealed in 8 hours of total injection time over 2 days. The average airtightness achieved was 1.09 ACH₅₀ before drywall was installed in the homes. Final air leakage tests were performed after the end of construction, showing very little change in air leakage (average of 1.12 ACH₅₀). The homes sealed with aerosol sealing were 39% tighter than homes sealed with only conventional methods. All homes

were under 2.0 ACH₅₀, suggesting that the open-cell foam did a good job of sealing. Post-occupancy tests were not within the scope of this project. However, lab durability testing showed an overall increase of less than 0.1% of the sealed area when aerosol seals were subjected to 1,900 cycles of 100 Pa pressure change (Modera and Harrington 2018). The sealant is a diluted version of a synthetic acrylic elastomeric material that is typically used as an exterior air barrier and is expected to “flex” with movement in building materials.

Table 6. Summary of Phase I Sealing Results

Stage/ House #	Floor Area (ft ²)	Volume (ft ³)	Pre-Seal		Post-Seal			After Foam		
			CFM ₅₀	ACH ₅₀	CFM ₅₀	ACH ₅₀	% Reduction	CFM ₅₀	ACH ₅₀	% Reduction
Post-Foam: 1	2,569	23,121	1,690	4.39	429	1.11	75%			
Post-Foam: 2	2,032	22,215	1,286	3.47	351	0.95	73%			
Pre-Foam: 3	2,569	23,121	5,836	15.14	828	2.15	86%	483	1.25	42%
Pre-Foam: 4	2,223	20,007	3,005	9.01	477	1.43	84%	352	1.06	26%

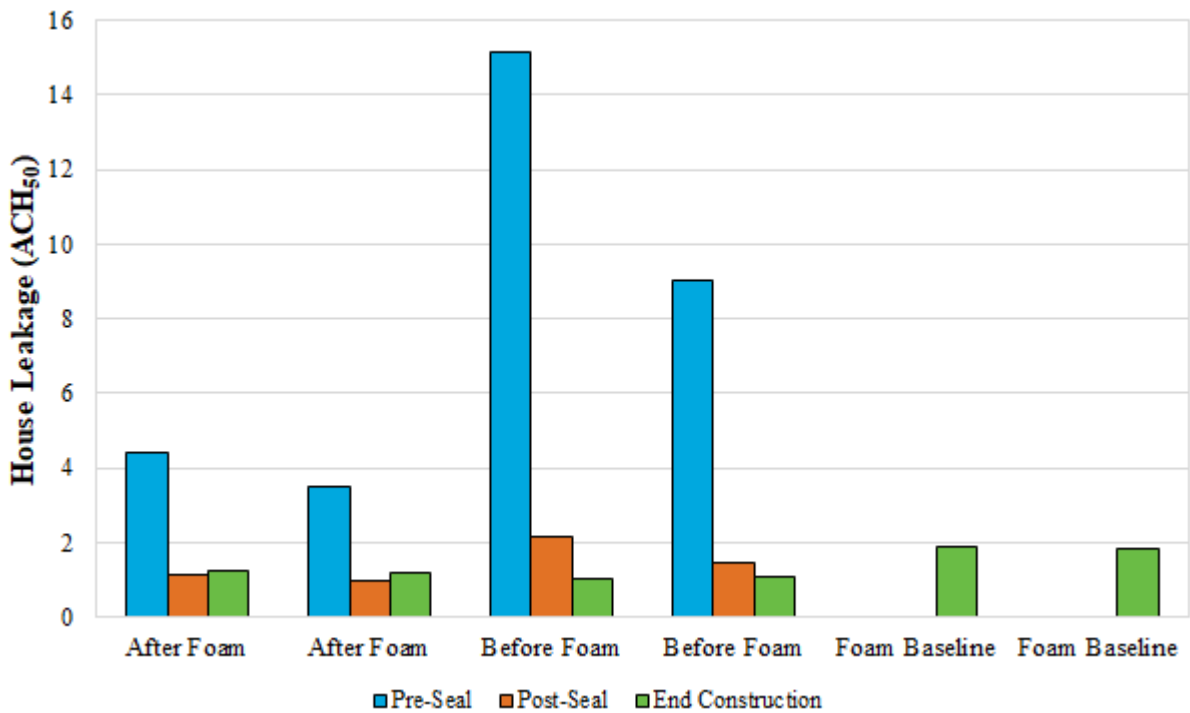

Figure 15. Air leakage results summary for all homes at each stage of the process

5.1.2 Unvented Attics: Phase II

Phase II of the aerosol sealing demonstrations aimed at further developing the air sealing approach for homes designed with unvented attics. The homes sealed for Phase II were built by a different builder (#2) in California than in Phase I, but many of the same sealing strategies were used by both builders. The Phase II homes were designed with blown-in cellulose insulation at the roof deck, which differed from the spray foam insulation used in the Phase I testing. In both cases the air barrier is formed at the roof deck. This allowed researchers to assess the airtightness achieved under both approaches. It is understood that spray foam does a better job than blown-in cellulose of sealing air leaks, in addition to providing insulation for the homes. The Phase II demonstrations assessed whether the aerosol sealing process could achieve high levels of airtightness without using spray foam insulation.

Builder 2 for Phase II took some specific measures in order to facilitate the aerosol sealing in their homes. They modified the schedule to allow the insulation to be installed after exterior rigid foam as opposed to before, which would normally be the case. Additionally, the builder installed drywall earlier in the construction process than normal between the garage and the living space to complete the air barrier of the home (the garage is not typically included in air leakage assessments of homes). An air barrier wrap was installed to block the garage attic from the house attic. These modifications were fairly minor and could be avoided if aerosol sealing was planned for the homes at the design phase.

Based on our experience in Phase I, the exterior rigid foam was expected to close the gaps left at the eaves where the roof meets the wall; however, observations at homes for California Builder 2 showed that some of the gaps were still larger than expected (Figure 16). The areas where large gaps existed were manually foamed by the aerosol contractor prior to the aerosol sealing process. The contractor was able to address this leakage in about 0.5 person-hours.



Figure 16. Large gaps at eaves between foam and roof structure were sealed prior to aerosol sealing

The aerosol envelope sealing demonstrations were completed by a local aerosol distributor on July 24–25, 2018, for houses located at a net zero energy community in Clovis, California.

Building America project team members Curtis Harrington and Daniel Reif were present, and they performed pre- and post-aerosol sealing air leakage testing as well as assisting with building preparation activities. Two single-story homes with attached garages were sealed and ranged in size from 1,900–2,100 ft². Figure 17 shows the stage of construction the homes were in at the time of the aerosol sealing.



Figure 17. Bibs attached to roof deck left hanging (left); photo of home sealed with ridged foam on exterior (right)

During the initial pressurization for the first home, the team uncovered a significant air leak between the home and garage. It was not noticed initially, but was uncovered when the team had trouble pressurizing the home. The construction methods did not allow aerosol sealing to be applied without minor modifications and resulted in the builder having to install an air barrier wrap to block the garage attic from the home attic spaces (Figure 18). There was a relatively small section of this barrier that was not installed continuously up to the roof. The bib material for insulation and the house wrap looked similar, and in one section there was a significant leak through the porous bib netting. After identifying the leak path, the project team installed poly wrap to block the leak.



Figure 18. Air barrier wrap above drywall to seal house attic from garage attic

After addressing the bulk air leakage, the aerosol sealing process went very well. The sealing was conducted for about 1–1.5 hours. The overall time to seal each home including prep and cleanup was about 7 hours for the first home (due to the additional prep required to block the attic leak) and about 5 hours for the second home. The leakage of the homes started at 5,900 CFM₅₀ and 6,900 CFM₅₀, and they were sealed by about 80% to 1,200 CFM₅₀ and 1,300 CFM₅₀, respectively. Figure 19 shows the sealing profiles for both homes sealed in Phase II, and the results of the air leakage tests performed by the Building America team are summarized in Table 7.

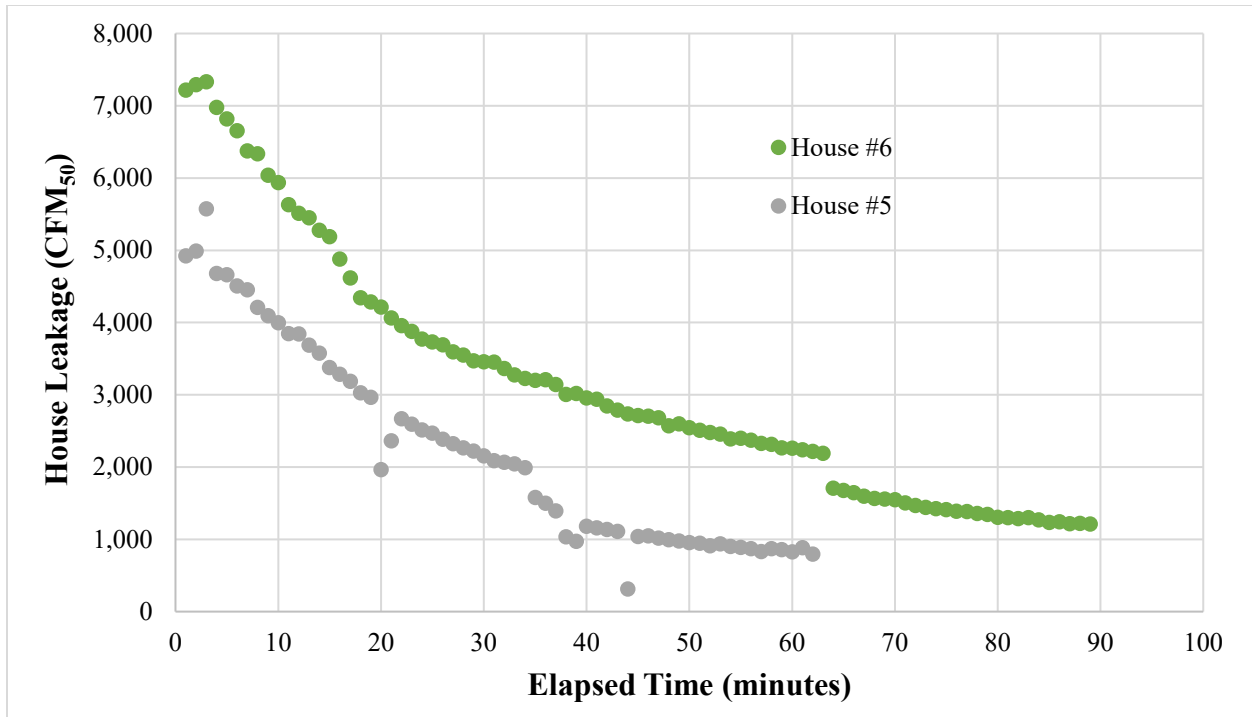

Figure 19. Sealing profile for both houses sealed for Phase II with California Builder 2

Table 7. Summary Table of Aerosol Sealing Results: Phase II—Before Drywall

Stage/ House #	Floor Area (ft ²)	Volume (ft ³)	Pre-Seal		Post-Seal		
			CFM ₅₀	ACH ₅₀	CFM ₅₀	ACH ₅₀	% Reduction
Pre-Drywall: 5	2,100	26,250	5,906	13.50	1,193	2.73	80%
Pre-Drywall: 6	1,900	23,750	6,911	17.46	1,288	3.25	81%

Figure 20 presents the end-of-construction leakage results for homes sealed in Phase II. The homes with aerosol sealing were about 50% tighter than the baseline homes, with an average leakage of 2.6 ACH₅₀ compared to 5.1 ACH₅₀ for the homes not aerosol sealed. There was a significant difference between the leakages measured for the two homes with aerosol sealing. One home tested at 1.8 ACH₅₀, whereas the other tested at 3.4 ACH₅₀. The difference is attributed to the fact that the attic between the garage and the conditioned space were connected, and it was difficult to install an air barrier to deal with the bulk airflow path between them. A plastic barrier was installed to create the air barrier, but there was significant leakage around the plastic. The builder had not planned the design of the home around the use of aerosol sealing, so this issue could be avoided by using a different attic system design. In addition, the final leakage

number for the leakier home was slightly higher than the post-sealing result, indicating that the work completed in the home after sealing (e.g., drywall, installing appliances and flooring) resulted in a net increase in building leakage. No other home sealed for the two phases of this project showed an increase in leakage after the aerosol sealing.

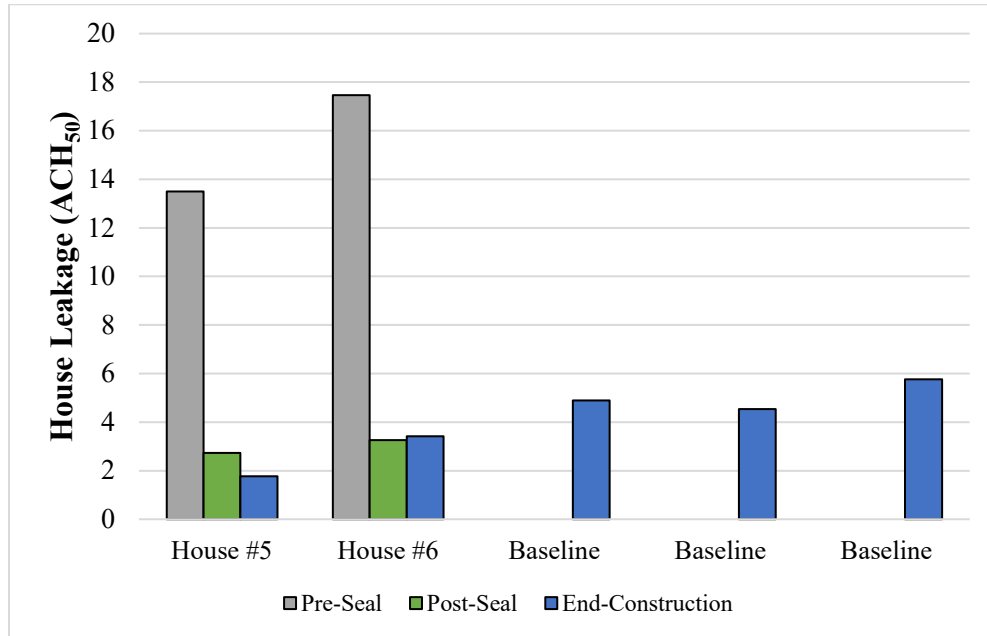

Figure 20. Phase II air leakage results for all homes, including end of construction

5.1.3 Unvented Attics: Discussion

Figure 21 presents the results from both phases of this project for aerosol work on homes designed with unvented attics. The results for the homes that used spray foam insulation showed generally tighter construction. The higher levels of air leakage for homes that used fibrous insulation was partly due to the differences in construction technique, such as the fact that in Phase I, California Builder 1 installed OSB around the entire building envelope. The air barrier wrap installed between the garage attic and the house attic was another source of leakage in homes in Phase II that were not sealed as effectively with the aerosol. One home sealed in Phase II had significant trouble getting bulk air leakage blocked prior to aerosol, and this home ended up with the highest leakage of the homes sealed. The construction approach taken by California Builder 2 resulted in leakier buildings in general, with the baseline homes that were sealed with conventional methods testing out at 5.1 ACH₅₀. The aerosol process demonstrated the ability to seal one of the homes with fibrous insulation down to 1.8 ACH₅₀, which is a significant improvement. This level of leakage roughly matches the airtightness achieved in the baseline homes for California Builder 1 using spray foam, suggesting that aerosol with fibrous insulation could be used in place of open-cell spray foam.

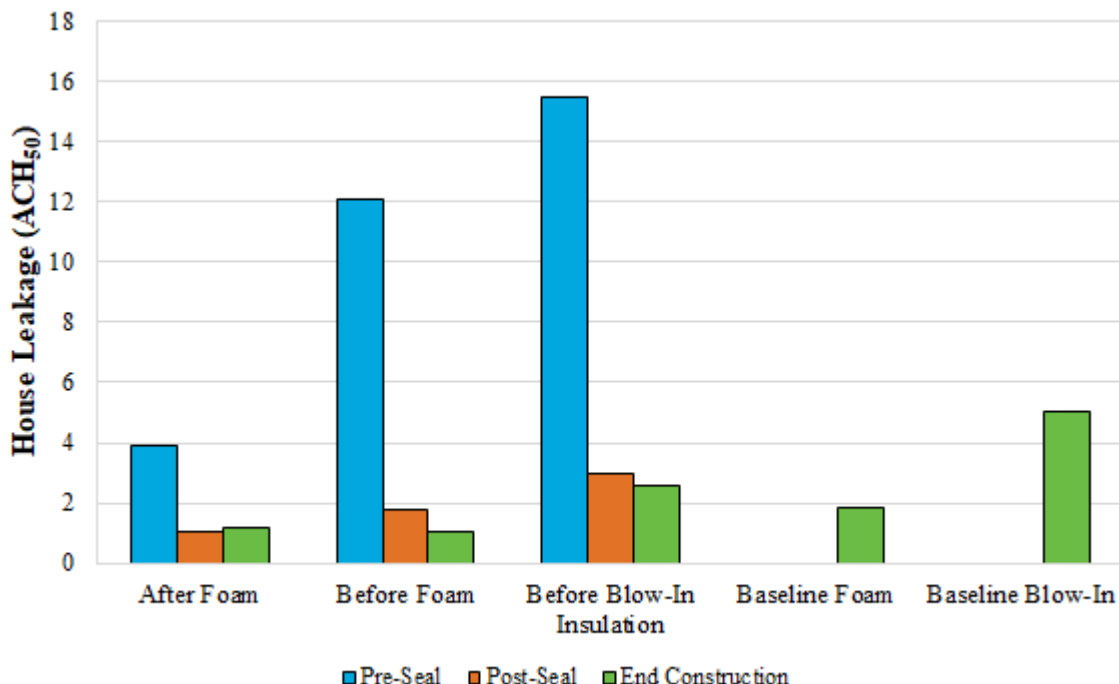

Figure 21. Air leakage results summary for all homes for Phase I and II at each stage of process

5.1.4 Vented Attics

The next set of aerosol sealing looked at the application process for sealing homes with vented attics. The homes sealed in this final phase were built by the same builder from Phase I; some of the homes had the same floor plans as the homes with unvented attics. No spray foam insulation was used in these homes as a cost-saving measure by the builder. Instead, fiberglass and cellulose were used in the walls and above ceilings. The aerosol sealing was applied after drywall was installed, before wall texturing and after texturing and trim installation. No major changes were required to apply aerosol at this stage of construction.

An air sealing assessment for California Builder 1 on homes designed with vented attics was performed by Curtis Harrington and Daniel Reif. Several houses in a subdivision in Lodi, California were inspected on May 17, 2018. The inspection results were identical to the unvented attic homes in Phase I, showing a high quality of air sealing. California Builder 1 stopped building homes with unvented attics due to low demand and to reduce costs. This and the insulation methods were the only major changes made in the design of these homes. Methods for sealing homes with vented attics during rough-in (before drywall is installed) were discussed with California Builder 1 during the site visit. Applying at that stage would have required installing drywall at the ceiling-attic interface to complete the bulk air barrier. This would be a major shift in standard practice for this builder and their contractors, and therefore was not performed for this project. The advantages of sealing before most of the drywall and insulation is installed is that seals would form at the exterior building shell, reducing the amount of air infiltration in the wall cavity. In addition, this would reduce the chance of seals getting damaged

from other work in the home (e.g., electrical work damaging seals formed on outlet boxes). Ultimately, it was decided that the best time to seal would be after drywall was taped. There is some flexibility at this stage that allows the sealing to occur after mud or after texture is installed. Sealing at the internal wall surface also minimizes moisture transfer into the wall cavity from inside sources.

The aerosol demonstrations were completed by the same local aerosol distributor from Phase II of the unvented attic tests. One home was sealed each day on June 26, 2018, July 2, 2018, and January 4, 2019. Two homes were sealed on January 16, 2019, with a majority of the prep work completed the previous day. As in previous phases, Building America researchers were present to measure pre- and post-aerosol air leakage, and to assist with building prep. Three of the five homes sealed were two stories and 2,223–2,569 ft². The remaining two homes were one story and 1,595 ft². Figure 22 shows the stage of construction the homes were in at the time of the aerosol installation.



Figure 22. State of vented attic homes at time of sealing

The final two homes were sealed during light rain showers (Figure 23). High humidity and very cold temperatures reduce the amount of sealant that can be injected due to the limited capacity for water to be evaporated into the air, which reduces sealing rates. To supplement the electric resistance heaters used with the standard aerosol system, a kerosene forced air heater in the garage was placed at the fan inlet. While direct-fire heating adds some moisture to the space, the overall impact can reduce the relative humidity of the air under certain conditions, and the contractor had noticed positive results when using a kerosene heater to supplement the electric resistance heaters integrated in the aerosol equipment. The additional heat was used to increase the sealant injection rates and improve sealing time.



Figure 23. Aerosol equipment set up in garage with kerosene heater (left); Houses #10 and #11 sealed during rain (right)

The overall time to seal each home including prep and cleanup was about 5 hours for the first two homes (houses #7 and #8). Total time for sealing, prep, and cleanup was 7 hours for the third home (#9), and 6 hours each for the fourth and fifth homes (#10 and #11). The last three homes required additional time to prep because some finishings were already installed, including windowsills, baseboards, and shelving in closets. These surfaces were temporarily covered during sealing to prevent sealant deposition, as shown in Figure 24. The sealing was conducted for about 1–1.5 hours in each home. Figure 25 shows the sealing profiles for all five homes with vented attics sealed, and the results of the air leakage tests performed by the Building America team are summarized in Table 8.



Figure 24. Additional preparation required in Houses #9, #10, and #11 to protect installed trim, including baseboards and shelves (left) and windowsills (right)

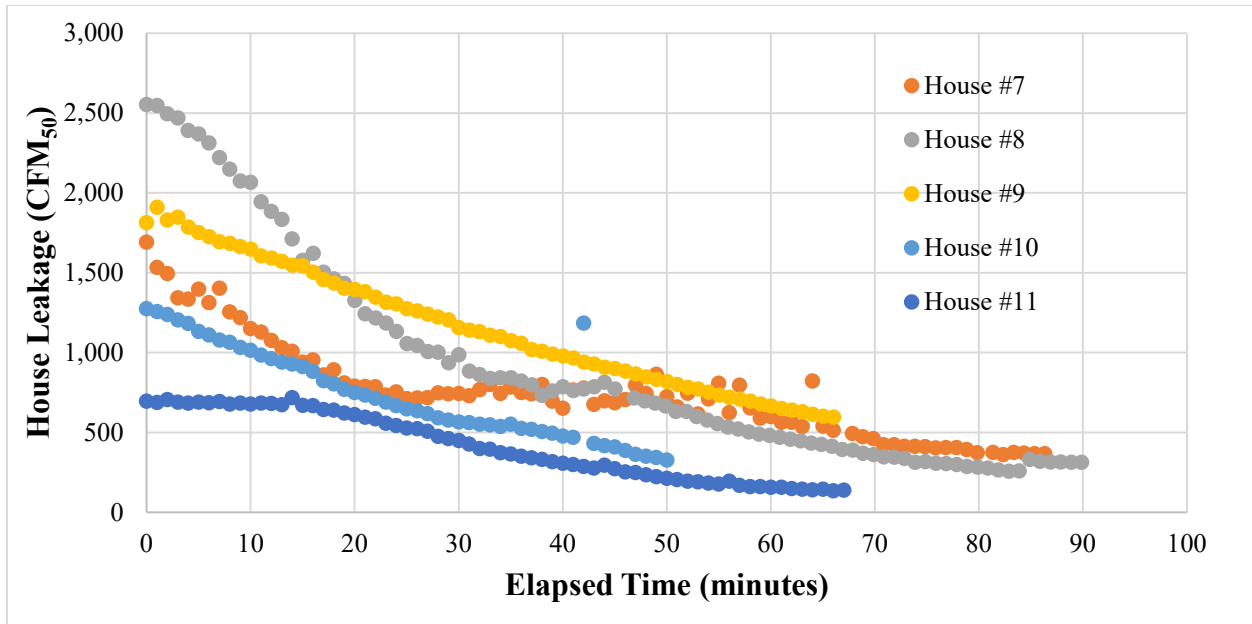

Figure 25. Sealing profile for all five homes with vented attics sealed with California Builder A

Table 8. Summary Table of Aerosol Sealing Results

Stage Option	House	Floor Area (ft ²)	Volume (ft ³)	Pre-Seal		Post-Seal		
				CFM ₅₀	ACH ₅₀	CFM ₅₀	ACH ₅₀	% Reduction
After Drywall	7	2,223	20,007	2,480	7.44	499	1.50	80%
After Drywall	8	2,223	20,007	2,433	7.30	477	1.43	80%
After Drywall	9	2,569	23,121	1,918	4.98	890	2.31	54%
After Drywall	10	1,595	14,355	1,378	5.76	409	1.71	70%
After Drywall	11	1,595	14,355	1,130	4.72	386	1.62	66%

Figure 25 includes the house leakage after the aerosol sealing was completed (post-seal) and at the end of construction. Tests were not conducted at one home because the tenants moved in before the test could be conducted. In general, there was a significant increase in leakage from the end of the aerosol sealing to the end of construction, and that increase was somewhat greater than the increase for the unvented attic houses. A few sources for the increased leakage are fire

sprinklers, backdraft dampers on exhaust systems, and electrical outlets. The sprinklers and dampers were blocked during the post-seal tests and would be an issue for conventionally sealed homes as well. Fire sprinklers are required in homes built in California, and air leakage measurements were taken on a small sample of sprinklers in the homes, showing an average air leakage of around 10 CFM₅₀ each. Considering homes can have more than 10 sprinklers, this results in 100 CFM₅₀ of leakage to the attic that cannot be sealed by any method because that would affect the functionality of the sprinkler. For homes with unvented attics, the air barrier is above the sprinkler at the roof deck so the air leakage of sprinklers to the unvented attic does not affect the overall leakage rate. Additional leakage was found through the backdraft dampers in the exhaust systems with 200–300 CFM₅₀ of leakage. Seals formed in electrical outlets and switches showed visible signs of disruption from electrical work after sealing, but the air leakage testing showed it had a minimal impact on air leakage (Figure 26). Ultimately, homes sealed with aerosol were 33% tighter than the baseline homes. The aerosol-sealed homes ended up at 3.1 ACH₅₀ compared to the baseline homes at 4.6 ACH₅₀.

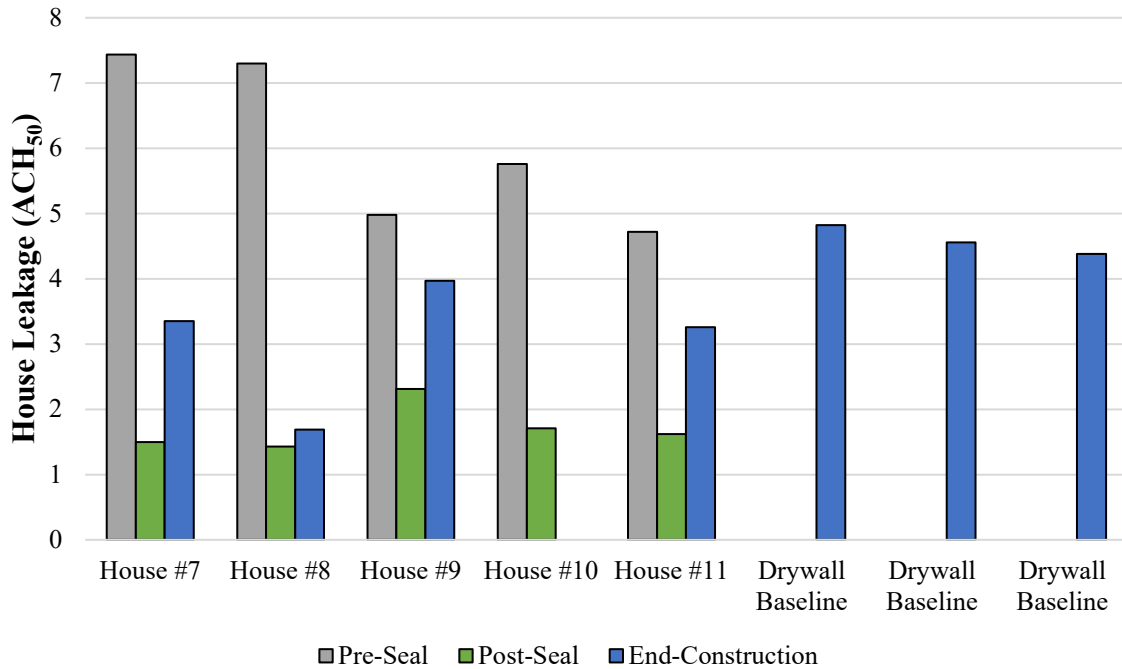

Figure 26. Air leakage results for all vented attic homes, including end of construction

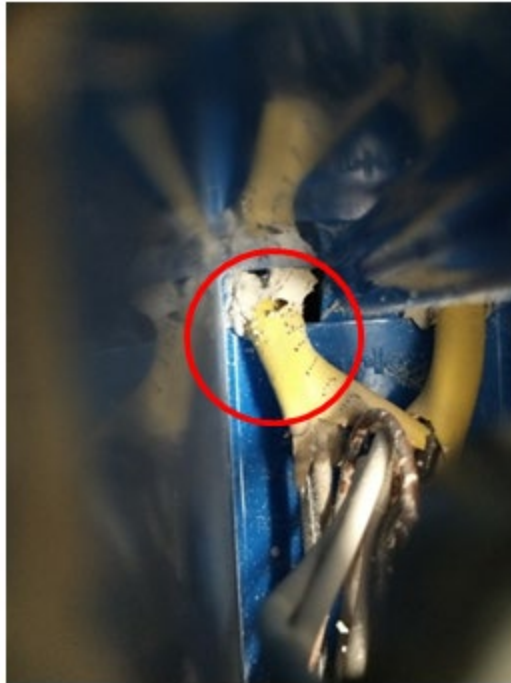

Figure 27. Damaged seal in electrical outlet after aerosol sealing installation

5.2 Minnesota Houses

The field work in Minnesota started with two builders using the stepwise, iterative approach for evaluating sealing methods as described in the Methodology section. The number of builders was later expanded to include an additional four Minnesota builders to help evaluate sealing methods for types of construction that were not included with the first two builders. A total of 15 houses were sealed for the six builders.

Almost all of the Minnesota houses had the following construction characteristics:

- Vented attic, attached (typically tuck-under) garage, and poured concrete basement
- House wrap as the weather resistive barrier on the exterior of the wall sheathing
- Fiberglass or mineral wool batts in 2x6 exterior wall cavities
- Blown fiberglass or fiberglass batts at the ceiling in all attic spaces
- Code-required balanced ventilation most often served using an energy recovery ventilator or heat recovery ventilator.

Deviations from these characteristics for individual buildings are noted in the descriptions of the results.

The houses were required to meet the Minnesota Energy Code envelope leakage requirement of 3.0 ACH₅₀ as measured with an envelope air leakage (i.e., blower door) test. The houses were typically participating in a utility energy efficiency program that provided tiered incentives for

modeled annual energy use below energy code minimum requirements. In order to meet the code-required envelope leakage and achieve higher utility program incentives, the builders typically used the following air sealing methods:

- Closed-cell spray foam used to seal/insulate rim and band joists (Figure 28)
- Caulk joints where wood framing meets on exterior walls and flooring (Figure 28 and Figure 29)
- Electrical, plumbing, and other penetrations sealed with can foam (Figure 29)
- Airtight electric boxes on exterior walls (Figure 29)
- Interior 6-mil polyethylene sheeting with acoustical sealant on exterior walls; top floor ceiling serves as vapor retarder and air barrier (Figure 30).

Most of the Minnesota builders in this project had a target to meet the energy code leakage requirement of 3.0 ACH₅₀, but two of the builders had a target of 1.0 ACH₅₀, and the project had a stretch goal of 0.6 ACH₅₀ for all of the Minnesota builders.



Figure 28. Closed-cell spray foam at rim joist and duct penetrations (left); caulk at seams where wood is joined (right)



Figure 29. Can foam at wire penetrations (left); foam gasket/caulk at sill plate and airtight electric box (right)



Figure 30. Interior poly sheet on top floor ceilings and exterior walls

5.2.1 First Minnesota Builder (#3)

The first Minnesota builder was a large, national builder with multiple developments in the Minneapolis-St. Paul metropolitan area. Field inspections of two houses were conducted to qualitatively assess the envelope air barrier. One of the houses was at the rough-in stage of construction and the other was at the pre-drywall stage. The results from those inspections and experience from other houses constructed by this builder were used to generate the table of air sealing components included in Appendix C. Photos of a sample of the sealing details are shown in Figure 31. The inspections showed an overall high quality of air sealing. The level of quality for all except three components was either excellent (18) or not applicable (5). Only the sealing of the attic access panel was considered to be poor.⁸ This qualitative assessment is consistent with the air leakage test results from Home Energy Rating System (HERS) rater reports for four of the builder's houses with similar floor plans. The envelope leakage of those four houses ranged from 1.19 to 1.47 ACH₅₀. The average leakage of 1.31 ACH₅₀ is 56% below the State of Minnesota code requirement of 3.0 ACH₅₀. The reports indicated limited air sealing concerns

⁸ The sealing is accomplished by the texture coat being applied to the ceiling. If someone were to use the access panel, the sealing will be broken. Code requires the attic hatch to be weatherstripped.

with the following possible air leakage issues noted: fan housing, ceiling electric box, garage service door trim, front of game room leakage into cavity wall, attic access not sealed, and infrared indicating cold spots at the owner's closet ceiling.



Figure 31. Typical air sealing details: can foam around bottom plate duct and electrical penetration (left), airtight electric box at exterior wall and caulk bottom plate/subfloor (middle), and can foam at plumbing penetration and caulk between framing

Demonstration Aerosol Sealing

A demonstration of the aerosol envelope sealing process was completed by AeroBarrier staff on May 30, 2017, for one of the builder's houses. At that time almost all house envelope demonstration aerosol sealing had been performed near or at the end of construction. Aerosol sealing at that stage typically seals an air barrier that is at or near the interior surface of the envelope cavity. Because one of the project's objectives was to evaluate sealing performed at various stages of construction, the house was sealed early in the construction process—soon after the exterior enclosure of the house was mostly complete. Applying the aerosol sealing at that stage of construction was expected to seal an air barrier at or near the exterior surface of the envelope cavity. That typically produces an air barrier at the sheathing and wood framing of exterior walls. The insulation, drywall, and rim joist spray foam had not been installed. Electrical and duct penetrations between floors and at exterior walls were sealed. In addition, foam had been sprayed in the gaps around almost all of the windows. Reinforced polyethylene sheets were installed on the second floor ceiling in order to complete the house air barrier and allow pressurization for the aerosol sealing to be performed. The sheets were caulked and stapled to the framing. The ceiling poly would typically have been installed at the same time that poly would be installed on the exterior walls. Consequently, the materials and amount of labor were not changed. The work was done somewhat out of sequence for their insulation subcontractor, and this would result in an added trip cost if the ceiling poly cannot be installed at the same time as other insulation and air sealing work. The following items were temporarily sealed: bathroom exhaust fan duct outlet, kitchen exhaust fan duct, energy recovery ventilator inlet and exhaust

ducts, 1-in. holes in the second floor bedroom subfloor⁹ above the garage, combustion air duct, furnace vent, water heater vent, sealed combustion gas fireplace vent, and clothes dryer vent. Photos of some of the sealing preparations and manual sealing are shown in Figure 32 and Figure 33.



Figure 32. Temporary sealing preparations: shower base, 1-in. holes in subfloor over garage, and exhaust fan outlet



Figure 33. Manual sealing prior to aerosol: poly on second floor ceiling, foam at electrical penetrations to garage, and foam gap at top of garage drywall

The aerosol envelope sealing proved very successful. As shown in Figure 34, the sealing was conducted for approximately 2.5 hours with a starting leakage of about 2,500 CFM₅₀. However, some leaks between the garage and living area were manually sealed during the first 10 to 15 minutes of the aerosol sealing. If it is assumed that 300 CFM₅₀ sealing was due to the manual sealing, the “initial” house leakage for the aerosol sealing would have been approximately 2,200 CFM₅₀. The sealing was paused after 90 minutes; the leakage was 662 CFM₅₀ at that time. The sealing continued for another 60 minutes. The red line in Figure 34 shows the rate of sealing. The sealing begins within 5 to 10 minutes after the house is pressurized and the sealant fog is dispersed. The rate of sealing starts at about 50 CFM₅₀/min and slowly drops over time. It

⁹ 1-in. holes were used during construction to move floor panels. Plastic caps were inserted later in construction.

reaches 10 CFM₅₀/min after about 1 hour and 15 minutes and drops to 5 CFM₅₀/min after about 2 hours. It is likely that a large number of narrow gaps are sealed quickly while the larger leaks take longer to fully seal. Photos of aerosol seals are shown in Figure 35. It is evident that most of the sealing occurs for long lengths of narrow gaps.

A multipoint house leakage measurement at the end of the aerosol sealing resulted in a tightness of 358 CFM₅₀ or 0.64 ACH₅₀. The reduction of 84% is consistent with the reductions obtained for previous projects. This is 79% below the State of Minnesota code requirement of 3.0 ACH₅₀. Additionally, it is 51% less than the average house tightness of 1.31 ACH₅₀ for the four completed HERS rated houses and only 7% higher than the Passive House standard of 0.6 ACH₅₀. This very tight construction was achieved without the poly vapor/air barrier in place on the walls and without the spray foam insulation/air sealing of the rim joists. This suggests that the current level of house tightness of 1.3 ACH₅₀ could be produced without much of the current air sealing when aerosol sealing is applied.

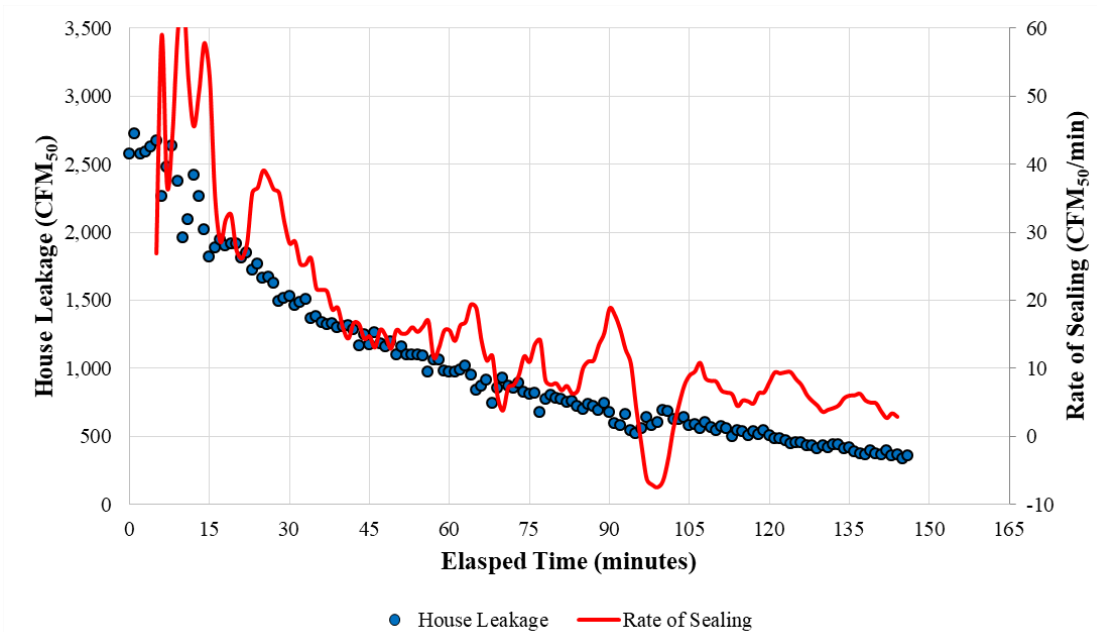

Figure 34. Sealing profile for Minnesota Builder 3 (House #12) demonstration sealing

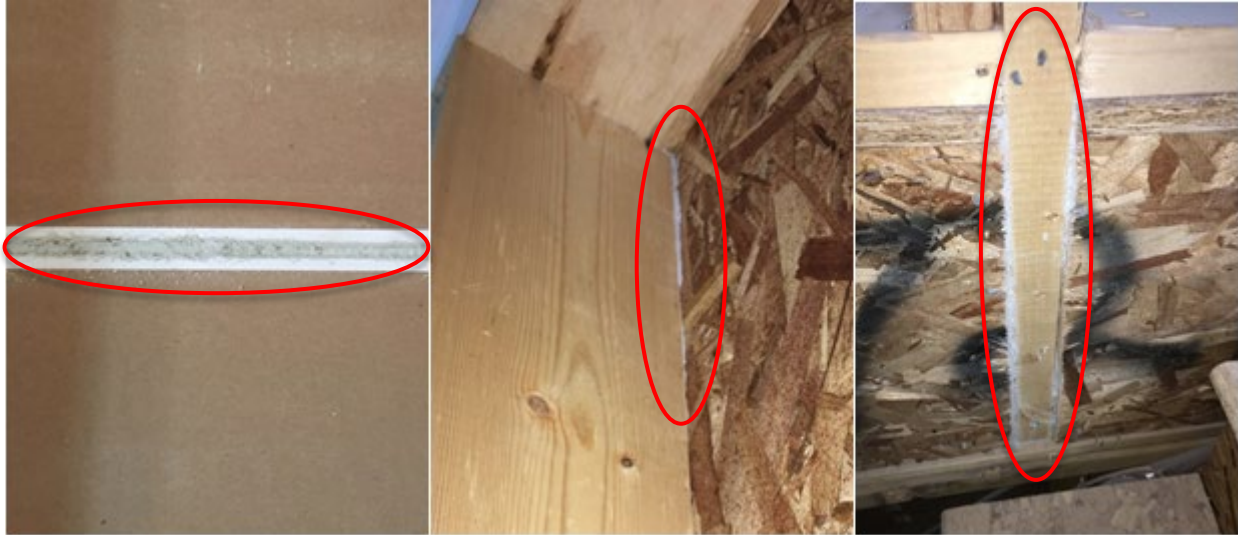

Figure 35. Example aerosol seals: gap between drywall sheets (left), gap between framing and sheathing (middle), and rim joist gaps (right)

Phase I Aerosol Sealing Options

The major goal of this project was to determine the best stage(s) of construction to apply aerosol envelope sealing and identify any current sealing methods that could be eliminated when aerosol sealing is used. Although there were some opportunities for the aerosol sealing method to produce tighter houses for this builder, it was expected that the greatest benefit would be a possible reduction in overall sealing costs by eliminating many of the current sealing practices. The identification of air sealing that might be eliminated was based on an understanding of how each building component was being sealed, whether the component air leaks would be accessible during the aerosol sealing process, and whether the leakage gaps would be small enough to be sealed by the aerosol process. It was assumed that the aerosol sealing would be performed at an early stage of construction, prior to the installation of drywall. Table 9 lists the 13 types of leaks that were judged to have current sealing methods that might be eliminated or significantly reduced by aerosol sealing. The leaks are grouped by the contractor that typically performs the manual sealing of the type of leak. Insulation contractors seal the greatest number of leak types (seven), but carpenters also seal four types and insulation/electrical contractors seal three. A complete description of the types of leaks is included in Appendix C.

Table 9. Current Air Sealing That Could Possibly Be Eliminated With Aerosol Sealing

Type of Leak	Category	Material Used for Sealing?
Carpentry Contractor		
Shower/tub on exterior wall	Other	OSB/polyethylene sheet
Stair stringer on exterior wall	Other	Polyethylene sheet
Interior partition wall to exterior wall	Walls	Polyethylene sheet/caulk
Sill plate	Walls	Sill seal/caulk
Insulation Contractor		
Top plate	Walls	Polyethylene sheet/caulk
Rough openings	Windows, skylights and doors	Can foam
Plumbing penetrations	Shafts and penetrations to unconditioned spaces	Can foam
Piping penetrations	Shafts and penetrations to unconditioned spaces	Can foam
Wiring penetrations	Shafts and penetrations to unconditioned spaces	Can foam
HVAC register boots that penetrate building thermal envelope	Other	Can foam
Rim joists	Rim joists	Closed-cell spray foam
Insulation Contractor/Electrician		
Electrical/low-voltage boxes on exterior walls	Other	Polyethylene sheet/caulk/gasketed boxes
Recessed lighting fixtures	Ceiling/attic	Polyethylene sheet/gasketed fixture
Electrical/low-voltage boxes on exterior walls	Other	Polyethylene sheet/caulk/gasketed boxes

Project staff met with builder representatives to discuss when to apply the aerosol sealing and identify sealing methods that could be eliminated. The builder was hesitant to eliminate any of their sealing methods for the first set of houses, but indicated that they would consider changes for the next set of houses based on results from additional houses. Although the aerosol sealant was shown to seal gaps at the rim joist, they were not comfortable with other options available to replace the insulating and vapor retarder functions of the spray foam. There was concern that the aerosol sealant would not satisfy fire code requirements being provided by can foam at the penetrations. They considered the poly sheeting on exterior walls to be a historically proven vapor retarder and were unsure whether code officials would allow them to replace the sheeting with low-perm paint on the drywall.

The builder agreed to have the aerosol sealing performed after the following work was completed: (1) closed-cell spray foam applied to the rim joists and (2) can foam used to seal plumbing, piping, electrical, and other penetrations. The sealing was to be performed before three work items were performed: (1) wall insulation, (2) poly sheeting applied to the exterior walls, and (3) caulking of the framing joints. Fortunately, there were some variations in the aerosol envelope sealing applications for the first set of houses. Two of the four houses had wall insulation in place on the day of the sealing, and one house had almost no can foam sealing of electrical and plumbing penetrations to the attic.

Phase I Aerosol Sealing

In the fall of 2017, four houses in the Twin Cities metropolitan area were aerosol sealed. The sealing profiles for the houses are shown in Figure 36. For the two houses with no wall insulation (#13¹⁰: blue and #14: green), the sealing proceeded fairly smoothly and was completed in about 2 hours. The starting envelope leakages were 3.81 and 3.78 ACH₅₀, respectively, and those were reduced by 72% and 82% to 1.05 and 0.67 ACH₅₀ (Figure 37 and Table 10). The average post-sealing leakage of 0.86 ACH₅₀ was 71% below the code requirement of 3.0 ACH₅₀ and 34% below the average leakage of 1.32 ACH₅₀ for the eight control houses at the end of construction. When the sealing was stopped, it appeared that the rate of sealing had decreased significantly; the leakage was already 65% and 78% below the code-required leakage of 3.0 ACH₅₀. A visual inspection showed that the gaps between the sheathing/top plate, sheathing/sill plate, sill plate/subfloor, and vertical framing were sealed (Figure 38). Although these gaps were typically narrow, there are hundreds of feet of these gaps in each house. This suggests that the total leakage area of those gaps could be significant and responsible for a majority of the leakage reduction. In addition, a tight air barrier was created at the exterior side of the wall cavities that produced low leakage levels of 1.05 and 0.67 ACH₅₀. This eliminates the need for an interior air barrier¹¹ that consists of a number of sealing components including poly sheeting and airtight electric boxes.

¹⁰ See Table 4 for information on house characteristics and stage of construction the sealing was performed.

¹¹ This assumes that there are no significant driving forces from the house interior that would force interior house air to circulate through the wall cavities.

Aerosol Envelope Sealing of New Residences

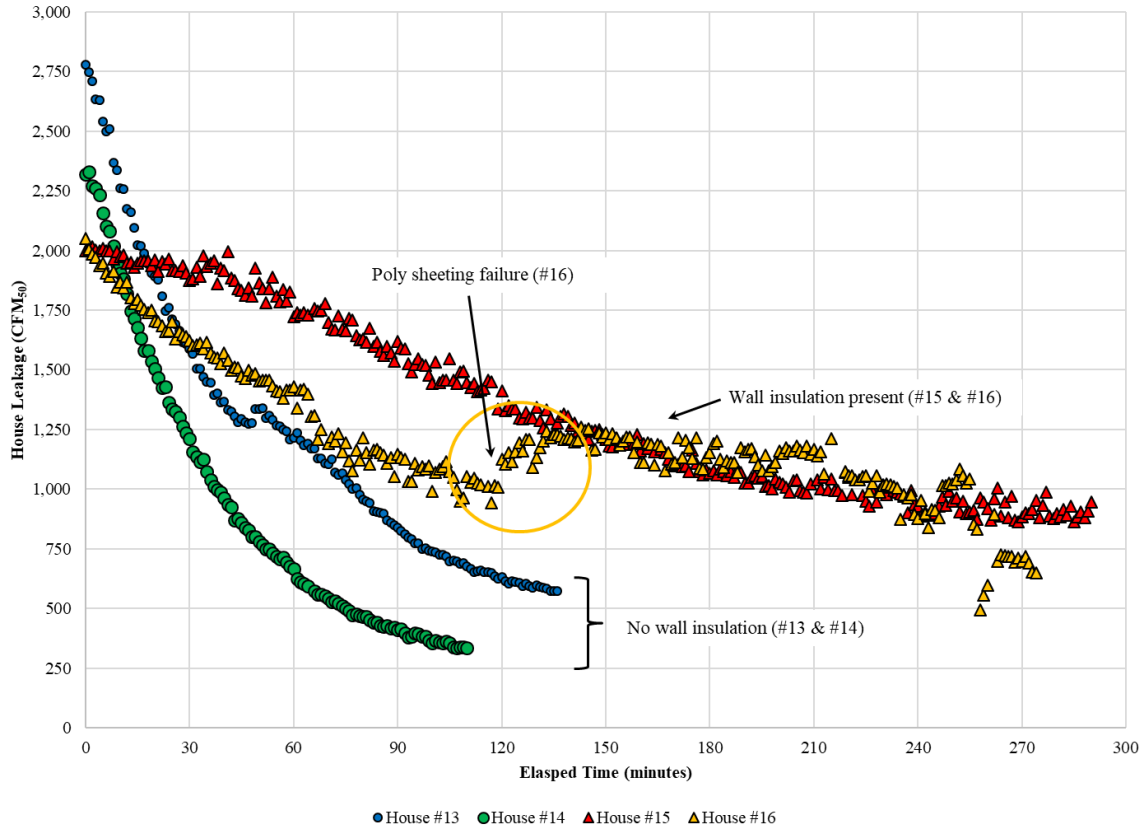

Figure 36. Sealing profile for the first four houses in Minnesota Builder 3's Phase I

Table 10. Summary of Minnesota Builder 3 Sealing Results

House #	Floor Area (ft ²)	Volume (ft ³)	Pre-Seal		Post-Seal			End of Construction		
			CFM ₅₀	ACH ₅₀	CFM ₅₀	ACH ₅₀	% Reduction	CFM ₅₀	ACH ₅₀	Change (CFM ₅₀)
12	3,338	33,518	2,200	3.94	358	0.64	84%	423**	0.76	65
13	4,361	41,504	2,637	3.81	728	1.05	72%	623	0.90	-105
14	3,913	36,469	2,300	3.78	409	0.67	82%	560	0.92	151
15 ⁺	4,186	39,533	1,893	2.87	1,023	1.55	46%	541	0.82	-482
16 ⁺	4,428	41,743	1,959	2.82	674	0.97	66%	*	*	*
17	3,972	35,955	1,690	2.82	279	0.47	83%	574	0.96	295
18	4,360	39,727	1,487	2.25	311	0.47	79%	719**	1.09	408

* The garage was converted to a sales office. It was not possible to test the house using the same configuration as that for the post-sealing test.

** Project staff did not conduct an end-of-construction test. The leakage is based on a HERS rater report. The house configuration for the test could not be confirmed to be the same as for the post-sealing test.

⁺ Wall insulation in place when the aerosol sealing started.

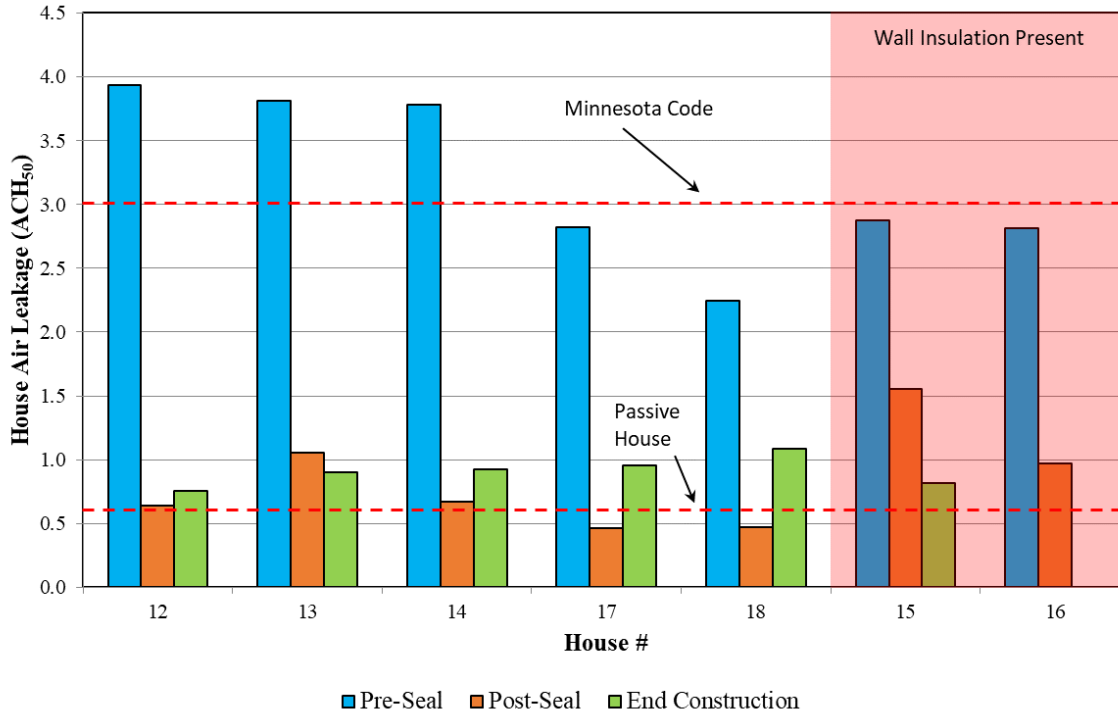

Figure 37. Air leakage results for Minnesota Builder 3



Figure 38. Example aerosol seals: between framing (left); between sill plate/sheathing; between sill plate/subfloor

It was expected that the electric wire and plumbing penetrations from the house to the attic would be sealed with can foam. However, for House #13, the insulation contractor had not sealed the penetrations prior to the aerosol sealing. The penetrations were left unsealed to evaluate the effectiveness of aerosol sealing of the penetrations. A visual inspection with a smoke puffer was performed on the penetrations after the aerosol sealing. There were no noticeable gaps and no smoke movement at any of the penetrations. After the post-sealing air leakage test was completed, the penetrations were sealed with can foam and the leakage test repeated. The house

leakage decreased by only 15 CFM₅₀. That indicates that the aerosol sealing effectively sealed electrical and plumbing penetrations to the attic.

Due to a miscommunication with the insulation contractor, batt insulation was installed in the exterior walls of houses #15 and #16 prior to the aerosol sealing. The smaller reductions in leakage for these two houses indicate that aerosol sealing should not be conducted when exposed batt insulation covers exterior sheathing. The results from these two houses are excluded from the summary results for the Minnesota houses. However, a description of the results is included in this section to document the impact of the wall insulation on the aerosol sealing effectiveness. For the first house (#15), the wall insulation was left in place for the start of the sealing. Figure 39 shows a comparison of the sealing profiles for a house with wall insulation (#15) and without (#14). The wall insulation resulted in a much longer sealing time and lower sealing. The house without insulation started with a sealing rate of almost 50 CFM₅₀/min (green solid line in Figure 39) and slowly decreased to 5 CFM₅₀/min after 90 minutes of sealing. In less than 2 hours the house leakage was reduced by 82%. In contrast, for the house with wall insulation, the sealing rate was never above 15 CFM₅₀/min (red solid line) and averaged about 5 CFM₅₀/min for the first 3 hours of sealing. Four hours of sealing only produced a leakage reduction of 46%. During the aerosol sealing it was observed that the gap around an electrical box installed in the drywall between the house and garage was not being sealed. Sealant started to form in the gap as soon as the batt insulation around the box was removed. For the last 1 to 2 hours of sealing, some of the insulation batts were pulled from the top of the cavities with the lower section of the batt left in place. This appeared to marginally improve the sealing rate for a short period of time.

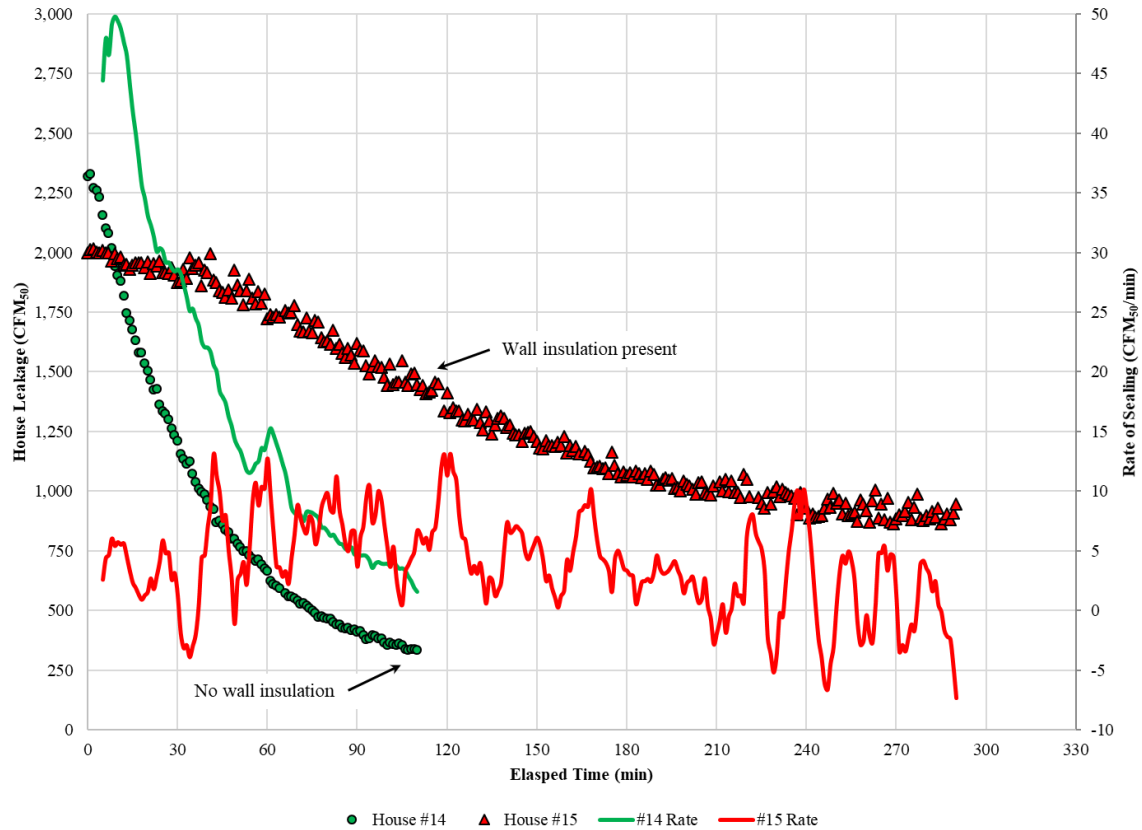

Figure 39. Sealing profile for House #14 (no wall insulation) and #15 (insulated)

For the second house with wall insulation (#16), many of the insulation batts were completely removed from the cavities and some were simply pulled down from the top with the bottoms left in place. As shown in Figure 36, the sealing rate for House #16 was better than that for the house with all batts in place (#15), but worse than the two with no wall insulation. For #16, the initial leakage of 2.82 ACH₅₀ was reduced by 66% to 0.97 ACH₅₀. This shows that batt insulation acts as a filter to the sealant for gaps at the exterior sheathing. This suggests that when aerosol sealing is performed before drywall is in place, a significant fraction of the aerosol sealing occurs between the sheathing and other construction. In addition, when aerosol sealing is performed after drywall and wall insulation is in place, aerosol sealant that is able to enter into the wall cavity will likely be filtered by the insulation and will not seal gaps at the sheathing.

Although the aerosol sealing for House #13 was completed within 2 hours, there were minor issues that extended the time for the other three houses. The compressor pressure control malfunctioned, which resulted in additional time diagnosing the issue and limited the number of sprayers that could be used for the three houses. In addition, for two of the houses (#13 and #16) the poly sheet on the ceiling came loose from the framing, which caused a large air leakage (Figure 40). For House #16, the opening in the sheet is evident by an increase in the leakage at about 120 minutes (Figure 36). The sheets were caulked and stapled to the framing, but the

stapling process needed to be more robust to hold the sheets in place against the high sealing pressure of 100 Pa.

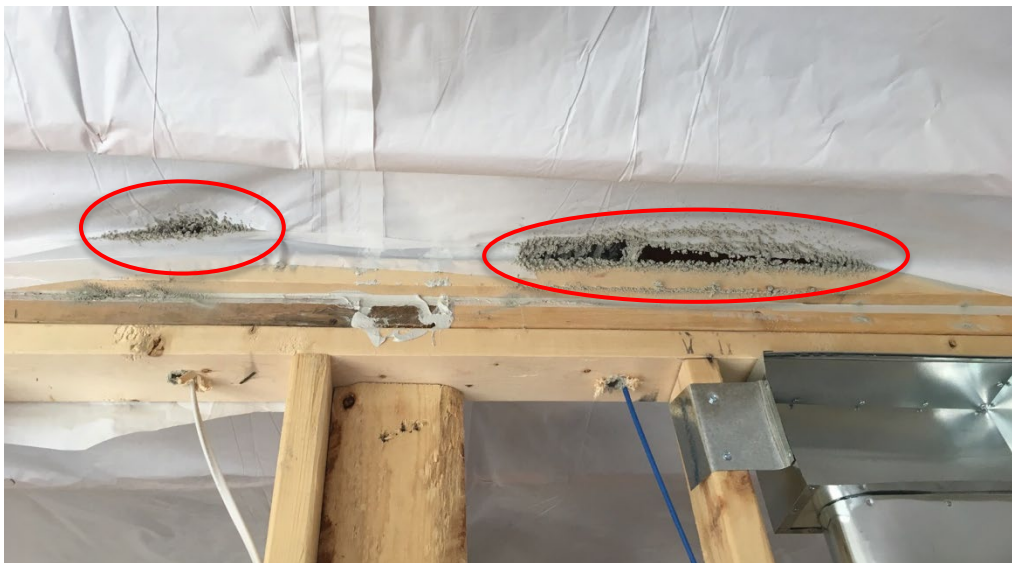

Figure 40. Poly sheet pulled away from framing

Phase II Aerosol Sealing

The project team met with builder representatives to review the sealing approach for the two Phase II houses. It was agreed that the time of construction for the aerosol sealing for the Phase I houses was successful and would not change. It would be performed after spray foam was applied to the rim joists, poly sheeting caulked/stapled in place on the second floor ceilings, and can foam used to seal electrical and other penetrations. The wall insulation and drywall would not be in place. It was agreed that more careful installation of the ceiling poly would be a point of emphasis with the insulation contractor and that the poly would be carefully inspected prior to the sealing. The builder and project team established a goal to achieve leakage less than the Passive House requirement of 0.6 ACH₅₀.

It was noted that the average leakage of 0.8 ACH₅₀ for the three demo and Phase I houses without wall insulation was well below the 3.0 ACH₅₀ code requirement and below the range of 1.0 to 1.5 ACH₅₀ typically achieved by the builder. Given the success of the Phase I sealing, the leakage goal for the Phase II houses was the Passive House standard of 0.6 ACH₅₀. Because the leakage for the Phase I houses was achieved prior to application of the interior poly sheeting on the walls, the poly was not necessary to meet their leakage goals. The poly could be eliminated and the vapor retarder requirements met by low-perm paint (see discussion of air barrier and vapor retarder requirements in Appendix B). The builder tentatively agreed to not use poly and airtight electric boxes on the two Phase II houses as long as their construction managers and code officials agreed to this change. The necessity for interior poly sheeting on exterior walls has been a point of emphasis for Minnesota builders and code officials for many years. The construction managers were not comfortable with eliminating the poly, so it was used for both houses.

The aerosol envelope sealing of the two Phase II houses was extremely successful. The sealing profiles for the houses are shown in Figure 41. The rate of sealing started at about 25 CFM₅₀/min for House #17 and 45 CFM₅₀/min for #18. Similar to previous houses without wall insulation, the rate of sealing decreased slowly over time. The sealing was stopped after 95 and 105 minutes when the rate of sealing dropped below about 5 CFM₅₀/min. There were no interruptions due to equipment malfunctions or issues with the ceiling poly. The starting envelope leakages were 2.82 and 2.25 ACH₅₀, and those were reduced by 83% and 79%, respectively. Both houses had a leakage of 0.47 ACH₅₀ (Figure 41 and Table 10) after sealing, which was 84% below the code requirement of 3.0 ACH₅₀ and 64% below the average leakage of 1.32 ACH₅₀ for the eight control houses at the end of construction. Additionally, the average for the houses was 22% lower than the Passive House standard of 0.6 ACH₅₀ and 77% below the DOE Zero Energy Ready standard of 2.0 ACH₅₀ for climate zone 6 (DOE 2019). This was further documentation that aerosol envelope sealing applied prior to wall insulation and drywall can produce a very tight air barrier at the exterior side of the wall cavity.

The builder showed interest in a demonstration of aerosol envelope sealing under cold outdoor weather conditions to determine whether there would be any restrictions to the application during Minnesota winters. Due to scheduling constraints for the AeroBarrier contractor and houses, the houses were not sealed under extreme weather conditions. For both houses the overnight low temperature prior to sealing was 23°F, and the temperature during sealing was 30° to 35°F. The houses were kept warm with temporary furnaces prior to the sealing (common practice for this builder). There were no temperature-related issues for the sealing of the two houses. The houses were pre-heated for application of spray foam.¹² The interior house temperature required for spray foam application was sufficient for effective aerosol sealing

¹² During the heating season, Minnesota insulators typically use a closed-cell spray foam that can be applied at an ambient and substrate temperature down to 23°F.

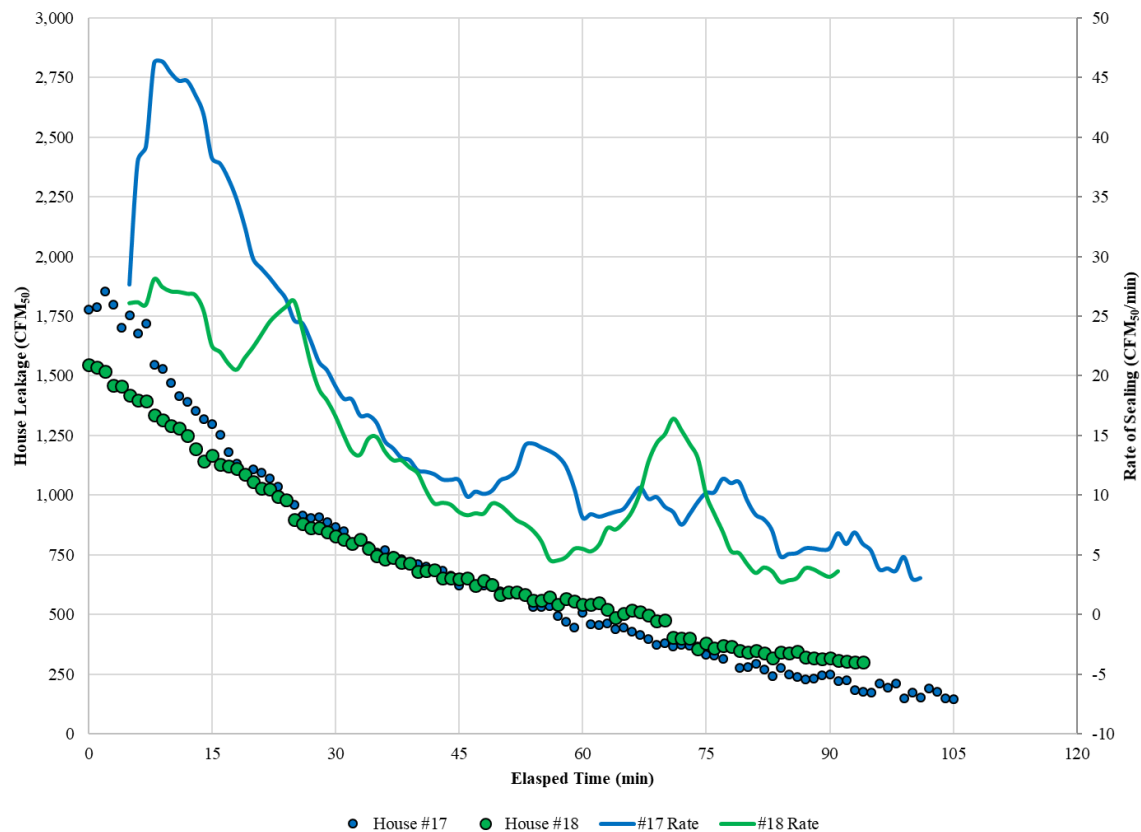

Figure 41. Sealing profile for two Phase II houses

End-of-Construction Leakage

The house assessments and air leakage tests were repeated at the end of construction for six of the seven¹³ aerosol-sealed houses. The tests were performed to determine whether the houses became tighter or leakier through the rest of the construction process. It was possible that completion of the interior air barrier could cause the houses to be tighter. Houses could become leakier if there was inadequate sealing of any additional penetrations or seals created by the aerosol sealing were disturbed by the remaining construction. The measured leakages are included in Table 10 and represented by green bars in Figure 37.

When evaluating the change in leakage from the post-aerosol test to the end-of-construction test, it is important to consider that it was necessary to temporarily seal numerous openings for the post-sealing test¹⁴ that were left open for the end-of-construction test. These may have included clothes dryer vents, bathroom exhaust fan ducts, kitchen exhaust fan ducts, heat recovery ventilator inlet/exhaust ducts, furnace vent pipes, and water heater vent pipes. In addition, the post-sealing test was conducted as a pressurization test, whereas the end-of-construction was

¹³ House #16's garage was converted to a sales office. It was not possible to test the house using the same configuration as the post-sealing test.

¹⁴ Such openings were sealed when there was not an appliance or backdraft damper in place that would be present at the end of construction.

conducted as a depressurization test. In order to evaluate the impact of the different test procedures, at the end of construction, six of the Minnesota builder houses were tested with two different procedures: (1) pressurization with sealed openings—similar to the post-sealing test—and (2) depressurization with unsealed openings. The increase in measured leakage using the unsealed procedure varied from -1 to 176 CFM₅₀ and averaged 81 CFM₅₀. This suggests that increases in leakage from the post-sealing to the end-of-construction up to 150–200 CFM₅₀ could be due to the differences in the test procedure and not an increase in leakage. The results for the change in leakage from the post-sealing measurement were mixed. For four of the houses the change ranged from -105 to 295 CFM₅₀ and averaged 102 CFM₅₀ or 0.18 ACH₅₀. The change was similar to the average difference in the test procedures (81 CFM₅₀). This suggests little change in the leakage of the air barrier that was created by aerosol sealing or that any significant leakage increase in that barrier was offset by leakage reduction from completion of the interior air barrier. One house had an increase in leakage of 408 CFM₅₀ or 0.62 ACH₅₀. However, the reported leakage is based on a HERS rater measurement and the house setup could not be confirmed to be the same as for the post-sealing test. Some of the increase in leakage could have been a result of differences between the post-sealing and HERS rater's house setup.

Finally, the leakage for first house with exposed wall insulation (#15) decreased by 482 CFM₅₀ or 0.73 ACH₅₀. The house had wall insulation batts installed at the start of aerosol sealing and the post-sealing leakage was the highest of all sealed houses—1.55 ACH₅₀. It appears that the interior air barrier installed after the aerosol sealing significantly reduced the house leakage. For the second house with exposed wall insulation (#16), the garage was converted to a sales office. The end-of-construction air leakage test could not be conducted for the same portion of the structure that was tested after the aerosol sealing was completed.

Project staff conducted end-of-construction envelope leakage tests for three houses that did not have wall insulation in place for the aerosol sealing.¹⁵ Sealed houses ranged from 0.90 to 0.96 ACH₅₀ with an average of 0.93 ACH₅₀. This average is 69% below the energy code requirement of 3.0 ACH₅₀, 54% below the DOE Zero Energy Ready standard of 2.0 ACH₅₀ for climate zone 6, and 30% below the average end-of-construction leakage for the eight control houses.

The leakage of exhaust fan inlets, heat recovery ventilator intakes/exhausts, and electric boxes was measured using a custom calibrated TEC Exhaust Fan Flow Meter with multiple 1-in. diameter holes. The exhaust fan inlet leakage varied from 5 to 18 CFM₅₀. The leakage of the heat recovery ventilator intakes/exhausts was only 4 and 12 CFM₅₀ for one unit, but much higher (42 and 56 CFM₅₀) for a second unit. There was no measurable leakage for any of the electric boxes tested.

¹⁵ The end-of-construction tests were conducted by a HERS rater for Houses #12 and #18. Houses #15 and #16 had wall insulation in place at the start of the aerosol sealing.

5.2.2 Second Minnesota Builder (#4)

The second builder was a midsize residential builder with multiple developments in the Minneapolis-St. Paul metropolitan area. Project staff had conducted field inspections of many of this builder’s homes and was familiar with the approaches to and quality of their air barrier sealing. That experience was used to generate the table of air sealing components included in Appendix C. The results were similar to those for the first Minnesota builder. Experience indicated an overall high quality of air sealing that was confirmed by the low envelope leakage of their recently completed houses. For example, the envelope leakage of four similar houses ranged from 0.86 to 1.97 ACH₅₀. The average leakage of 1.36 ACH₅₀ is 55% below the State of Minnesota code requirement of 3.0 ACH₅₀.

The aerosol envelope sealing demonstration was very successful. The house had drywall in place, and the construction was nearly complete with a low leakage of only 419 CFM₅₀ (0.70 ACH₅₀) prior to sealing. As a result, the sealing rate over the first 30 minutes was only 5 and 10 CFM₅₀/min (Figure 42; House #19). The 40 minutes of sealing reduced the leakage by 50% to 209 CFM₅₀ or 0.35 ACH₅₀. The low leakage at the start of sealing suggests that for this builder, the primary benefit of the aerosol sealing would likely be to reduce sealing costs by eliminating current sealing methods.

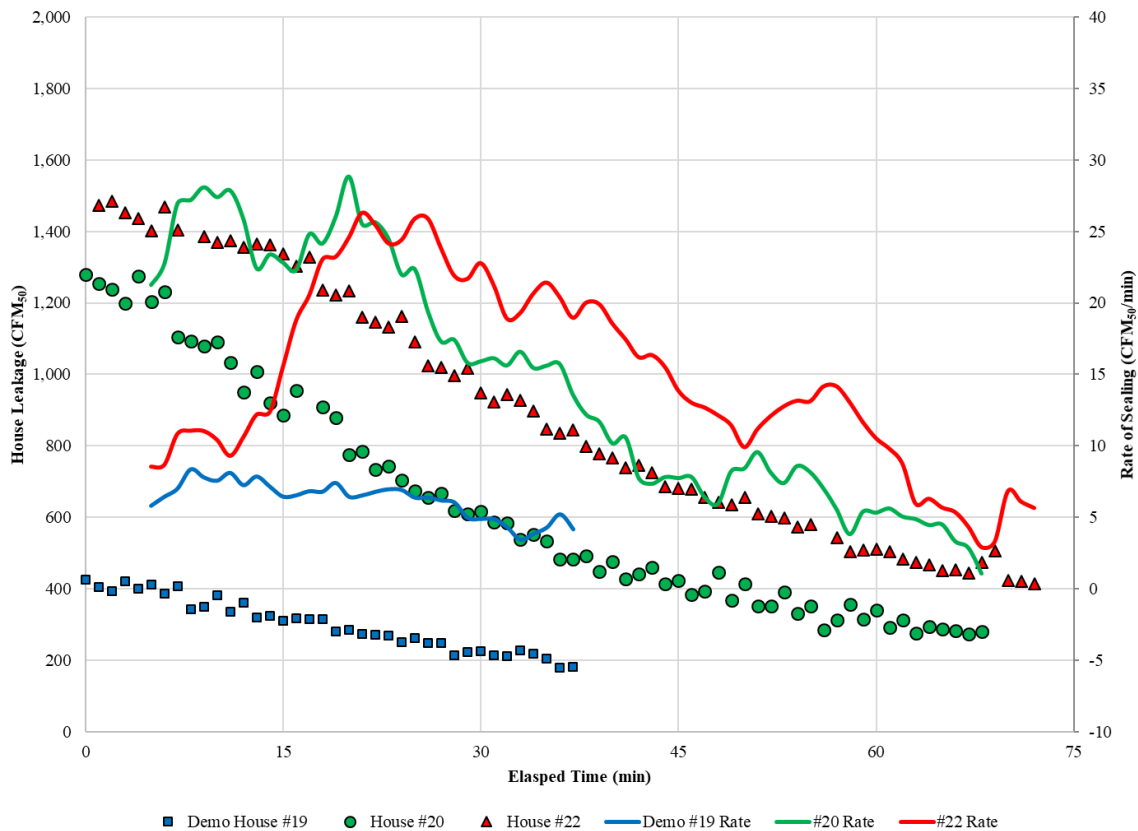

Figure 42. Sealing profile for three houses for Minnesota Builder #4

The project team met with builder representatives to review the results of the house assessments and demonstration sealing. It was agreed that the Phase I houses would be sealed at the same time of construction and the same preparation as that used for the first builder—post-rim/band joist sealing/prior to wall insulation and sheetrock. The goal was to meet or exceed the Passive House standard of 0.6 ACH₅₀. The builder was hesitant to eliminate any of their sealing methods for the Phase I houses, however, but indicated that they would consider changes for Phase II houses based on results from the additional houses.

5.2.3 Phase I Aerosol Sealing

The team expected that there would be two houses available to seal at the end of March 2018, but only one house was at the appropriate stage of construction when the AeroBarrier staff were in Minnesota to perform the work.¹⁶ The sealing for House #20 proceeded fairly smoothly and was completed in 70 minutes (Figure 42; #20, green). The sealing rate continued at about 25 CFM₅₀/min for about 20 minutes and dropped below 5 CFM₅₀/min when the leakage was about 350 CFM₅₀. The starting envelope leakage was 1.91 ACH₅₀ and was reduced by 78% to 0.42 ACH₅₀ (Figure 43 and Table 11). The post-sealing leakage was 86% below the code requirement of 3.0 ACH₅₀, 77% below the DOE Zero Energy Ready standard of 2.0 ACH₅₀, and 25% lower than the Passive House standard of 0.6 ACH₅₀. Finally, it was 61% below the average leakage of 1.06 ACH₅₀ for the four control houses at the end of construction. Similar to the pre-drywall sealing for Minnesota Builder 4, visual inspection showed that the gaps between the sheathing/top plate, sheathing/sill plate, sill plate/subfloor, and vertical framing were sealed. This reinforced the observation that aerosol sealing before the application of drywall and insulation can eliminate the need for an interior air barrier for reducing air leakage through the envelope.

Table 11. Summary of Minnesota Builder 4 Phase I Sealing Results

House #	Floor Area (ft ²)	Volume (ft ³)	Pre-Seal		Post-Seal			End of Construction		
			CFM ₅₀	ACH ₅₀	CFM ₅₀	ACH ₅₀	% Reduction	CFM ₅₀	ACH ₅₀	Change (CFM ₅₀)
19	4,135	35,916	419	0.70	209	0.35	50%	548	0.92	339
20	4,603	41,497	1,323	1.91	290	0.42	78%	429	0.62	139
21	3,698	33,358	2,270	4.08	407	0.73	82%	597	1.07	190
22	3,243	28,875	1,593	3.31	474	0.98	70%	519	1.08	45

¹⁶ A local AeroBarrier contractor was trained and became available to perform aerosol envelope sealing in August 2018. This provided significantly more flexibility to schedule the remaining sealing work.

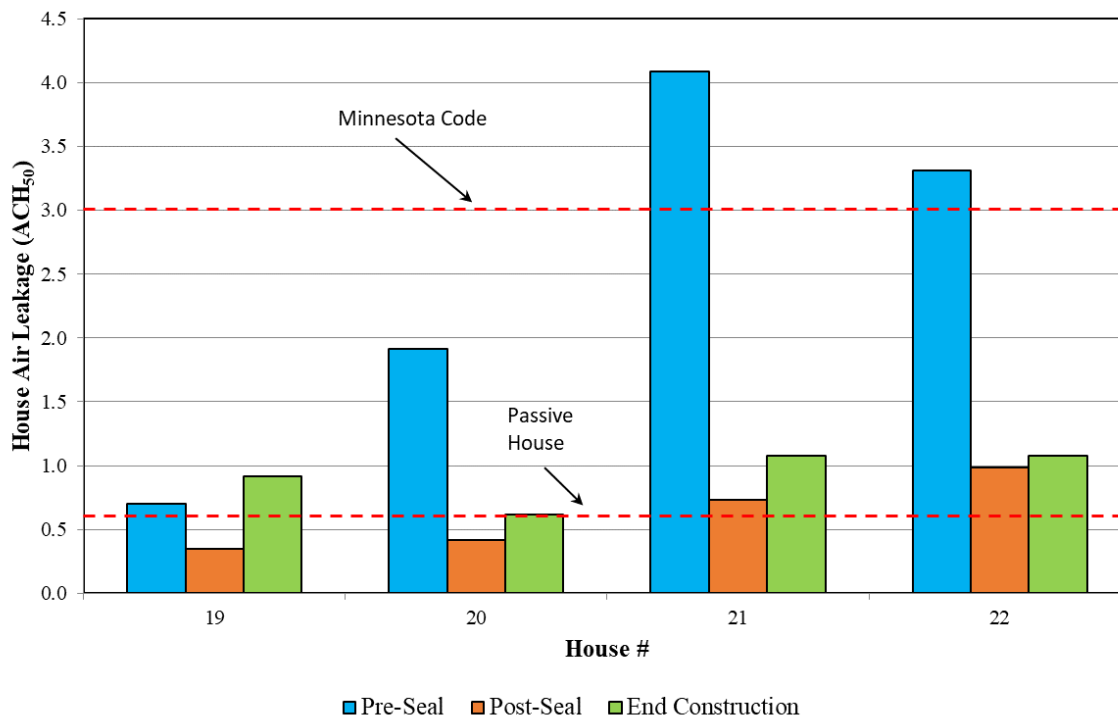

Figure 43. Air leakage results for Minnesota Builder #4

5.2.4 Phase II Aerosol Sealing

The project team met with builder representatives to review the sealing approach for the two Phase II houses. They agreed that the timeline of the sealing approach used in Phase I had been successful, and elected to apply sealing at the same time of construction for Phase II. Similar to the timeline for the first Minnesota builder, it would be performed after spray foam was applied to the rim joists, poly sheeting was caulked and stapled in place on the second floor ceilings, and can foam was used to seal electrical and other penetrations. The wall insulation and drywall would not yet be in place. The builder and project teams aimed to achieve leakage below the Passive House requirement of 0.6 ACH₅₀.

The aerosol envelope sealing of the two Phase II houses was very successful. The sealing profile for House #22¹⁷ is shown in Figure 42. The rate of sealing started at only 10 CFM₅₀/min, but increased to 25 CFM₅₀/min after 20 minutes. The sealing rate slowly decreased to 5 CFM₅₀/min after 65 minutes, when the house leakage had dropped to about 450 CFM₅₀ or a little less than 1.0 ACH₅₀. The sealing was stopped shortly after that time. As noted previously, the stretch goal for these houses was to achieve an envelope leakage of 0.6 ACH₅₀ or less. However, the sealing crew determined when the leakage had “bottomed out” and stopped the sealing at that point. While the rate of sealing is not computed and displayed for the crew, for the Minnesota houses the sealing was typically stopped when the rate of sealing dropped below about 5 CFM₅₀/min.

¹⁷ The airflow rate data was not recorded properly for House #21 for most of the sealing process.

There were no interruptions due to equipment malfunctions or issues with the ceiling poly. The starting envelope leakages were 4.08 and 3.31 ACH₅₀, and those were reduced by 82% and 70%, respectively, with post-sealing leakages of 0.73 and 0.98 ACH₅₀ (Figure 42 and Table 12). The leakages were 76% and 67% below the code requirement of 3.0 ACH₅₀, and 31% and 7% below the average leakage of 1.06 ACH₅₀ for the four control houses at end of construction.

Additionally, the leakages were 63% and 51% below the DOE Zero Energy Ready standard of 2.0 ACH₅₀. This was further documentation that aerosol envelope sealing applied prior to wall insulation and drywall can produce a tight air barrier at the exterior side of the wall cavity. However, the sealing fell somewhat short of the stretch goal to achieve leakages less than 0.6 ACH₅₀.

5.2.5 End-of-Construction Leakage

The house assessments and air leakage tests were repeated at the end of construction for four the houses that were aerosol sealed for Minnesota Builder 4. The tests were performed to determine whether the houses became tighter or leakier through the rest of the construction process. The measured leakages are included in Table 12 and represented by green bars in Figure 43. For three of the houses, there were moderate increases in leakage (45, 139, and 189 CFM₅₀), which could be explained by the difference in the test procedure.¹⁸ This suggests little change in the leakage of the air barrier that was created by aerosol sealing or that any significant leakage increase in that barrier was offset by leakage reduction from completion of the interior air barrier. It is not clear why there would have been a 339 CFM₅₀ (0.57 ACH₅₀) increase in leakage for the demonstration house (#19). The house was sealed near the end of construction. A pressurization test with openings sealed was conducted pre-sealing (419 CFM₅₀), post-sealing (209 CFM₅₀), and at end of construction (448 CFM₅₀). The house was tight prior to the sealing (0.70 ACH₅₀), and the limited reduction of 210 CFM₅₀ from the sealing was countered by added leakage from the time of aerosol sealing to the end of construction. The end-of-construction assessment did not identify any significant air leakage.

5.2.6 Minnesota Builders 5–8

The project team recruited four more Minnesota builders to evaluate sealing methods for: (1) a type of construction and (2) an air sealing approach that are used somewhat often in Minnesota but were not represented in the first two Minnesota builders' houses. The additional houses used continuous exterior insulation, spray foam wall insulation, and a flat roof with slab-on-grade floor. Three of the houses selected are located in the Twin Cities metropolitan area (Minnesota Builders 5, 6, and 8) and the house for Minnesota Builder 7 is located in the Rochester area.

Minnesota Builder 5 is an affordable housing developer. The 2,592 ft² house that was sealed is similar in construction to those for the two previous Minnesota builders, except that a portion of the labor is provided by volunteers and the rim joists were insulated and sealed with rigid insulation board cut to fit between the joists. In addition, this house provided another opportunity

¹⁸ As noted in the description of the results for the first Minnesota builder, the differences in the post-sealing and end-of-construction test procedures could result in an increase in leakage of up to 150–200 CFM₅₀.

to evaluate the effectiveness of post-drywall aerosol envelope sealing. As shown in Figure 44, the sealing rate started between 15 and 20 CFM₅₀/min, but dropped to 5 CFM₅₀/min after about 10 minutes, and slowly decreased from that time until sealing was stopped after 85 minutes. A lower sealing rate of 5 CFM₅₀/min shortly after sealing starts is consistent with the results for the other house that was sealed post-drywall (#12). The envelope leakage started at a relatively low level of 1.62 ACH₅₀, and the sealing reduced that by 73% to 0.44 ACH₅₀ (Table 12 and Figure 45). That is 85% below the code requirement of 3.0 ACH₅₀ and 27% below the Passive House standard of 0.6 ACH₅₀. Four similar houses constructed by this builder had envelope leakage that varied from 1.04 to 1.63 ACH₅₀, with an average of 1.29 ACH₅₀. The aerosol-sealed house leakage was 66% less than the average for the builder's houses that did not have aerosol sealing. All of the builder's houses participated in a utility new home efficiency program with tiered incentives based on modeled space conditioning energy use. Additional modeling showed that if the four houses with conventional sealing would have had aerosol sealing that produced a leakage of 0.5 ACH₅₀ or less, the builder would have received an additional \$200 in utility new home efficiency program incentives for each house. A leakage of 0.5 ACH₅₀ was not a target for this builder, but in the future it would be helpful to demonstrate to the builder that the additional leakage reduction would provide a greater utility program incentive. The work for this builder shows that aerosol envelope sealing can decrease leakage even for relatively tight houses by more than 70% and allow them to achieve Passive House leakage requirements.

Aerosol Envelope Sealing of New Residences

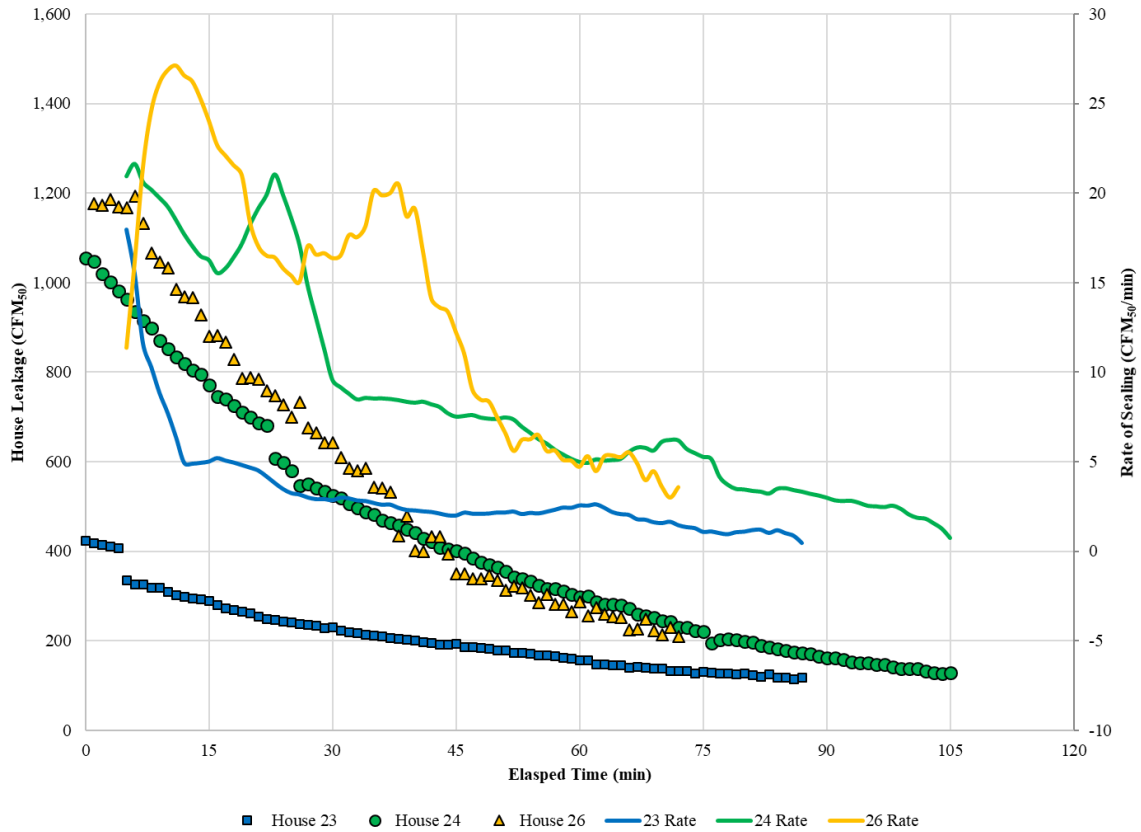

Figure 44. Sealing profile for Minnesota Builder 5 (House #23), 6 (#24), and 8 (#26)

Table 12. Summary of Sealing Results for Minnesota Builders 5–8

House #	Floor Area (ft ²)	Volume (ft ³)	Pre-Seal		Post-Seal			End of Construction		
			CFM ₅₀	ACH ₅₀	CFM ₅₀	ACH ₅₀	% Reduction	CFM ₅₀	ACH ₅₀	Change (CFM ₅₀)
23	2,592	23,274	628	1.62	170	0.44	73%	374	0.96	204
24	2,074	19,896	1,137	3.43	292	0.88	74%	319	0.96	27
25	3,334	33,418	6,405	11.5	738	1.33	88%	392	0.70	-346
26	3,882	42,896	1,230	1.72	232	0.32	81%	547	0.77	315

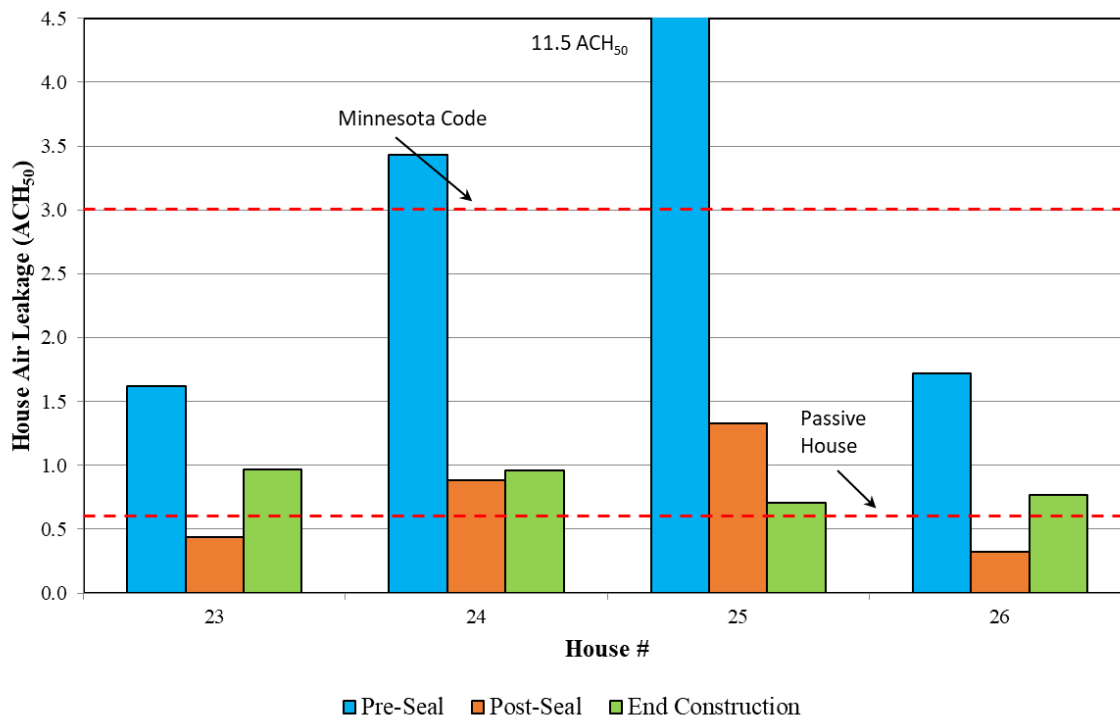

Figure 45. Air leakage results for Minnesota Builders 5–8

Minnesota Builder 6 is a small residential builder who wanted their houses to be tighter than 1.0 ACH₅₀. The two-story, 2,074 ft² house is slab-on-grade with a flat roof and 2”x6” stud walls. The walls have batt insulation in the cavities, 0.5-in. plywood sheathing, building paper with taped joints as the air barrier, and two layers of 1-in. rigid insulation. The house was designed for batt insulation in the 20-in. ceiling cavities and three layers of rigid insulation above the roof deck. When the house was aerosol sealed, the wall and ceiling batt insulation had not yet been installed and the electrical penetrations were not sealed. In addition, the roof membrane had not been adhered to the wood blocking at the top of the exterior walls. Rigid insulation needed to be installed and sealed between the living space and garage before the aerosol sealing was performed.

As shown in Figure 44 (#24), the sealing rate started at about 20 CFM₅₀/min and slowly dropped to 5 CFM₅₀/min after 60 to 75 minutes, except for a brief increase when some leakage was manually sealed at the 20-minute mark. Sealing continued for another half hour so that the house leakage would be at least 10% below the target leakage of 1.0 ACH₅₀. During the sealing, aerosol sealant could be seen blowing out the area under the roofing membrane. After the sealing was completed, a visual inspection found that the aerosol sealant filled gaps between the roof deck and the band joist. The envelope leakage started at a relatively low level of 3.43 ACH₅₀, and the sealing reduced that by 74% to 0.88 ACH₅₀ (Table 12 and Figure 45). That is 71% below the code requirement of 3.0 ACH₅₀. This shows that aerosol envelope sealing can produce slab-on-grade houses with leakages of less than 1.0 ACH₅₀. Two similar (e.g., control) houses constructed by this builder had envelope leakages of 0.94 and 1.29 ACH₅₀ with an average of

1.12 ACH₅₀. The aerosol-sealed house leakage was 21% less than the average for the control houses that were not sealed.

This builder typically participated in a utility tiered new home efficiency program. If the leakages of the two control houses were reduced to 0.5 ACH₅₀ or less, the builder's incentives would have increased by \$500 and \$300, respectively. For the aerosol-sealed house, reducing the leakage from the code requirement of 3.0 ACH₅₀ to 0.88 ACH₅₀ increased the incentive by \$500 for a total of \$3,500. Reducing the leakage to 0.5 ACH₅₀ would have further increased the incentive by \$500 to \$4,000, and the 2020 update to the program would increase the incentive to \$4,500. An added incentive of \$500 to \$1,000 could pay for a significant portion of the aerosol sealing work.

Minnesota Builder 7 is a small-volume builder who was starting to produce high-performance houses. The builder was planning to use spray foam on exterior walls and under the roof decking of the slanted attic roof for thermal insulation and to reduce the typical leakage of their houses. The envelope leakage averaged 1.37 ACH₅₀ for three similar houses that they had recently constructed. The objective was to evaluate whether aerosol envelope sealing—along with batt insulation in the walls and blown-in insulation in the attic—could provide the desired house leakage and give the builder a more cost-effective insulation approach. The house was aerosol-sealed prior to the application of spray foam insulation. Drywall or poly was installed on the second floor ceiling so that the house could be pressurized for aerosol sealing. Because it was expected that the spray foam would seal larger gaps in the envelope, more extensive can foam sealing was necessary than for the other project houses in Minnesota. However, the electrical wire penetrations were judged to be small enough to be sealed by the aerosol process.

The sealing profile is shown in Figure 46 (#25). The rate of sealing started at a high level of 150 CFM₅₀/min, and then after 15 minutes decreased to between 40 and 60 CFM₅₀/min for the next 35 minutes. This higher level of sealing was due to the higher starting envelope leakage of 11.5 ACH₅₀. With the aerosol sealing process, it is expected that all of the envelope leaks will be sealed simultaneously and, as a result, leakier houses will have higher sealing rates. The duration of sealing should largely be determined by the width of the leaks to be sealed and not the number or total length of the leaks. Prior research has shown that the time required for sealing a leak is proportional to the square of the leak width (shortest dimension for a two-dimensional slot leak), and the total amount of leakage (length of the leak) does not impact sealing time (Carrie and Modera 1998). The total leakage, however, will impact sealant injection rates to maintain particle concentration in the building and appropriate application humidity. Another contributing factor is the house leakage goal and whether it is necessary to continue to seal leaks with wider gaps (which take longer to seal) in order to meet the leakage goal.

After about 65 to 70 minutes, the sealing rate dropped below zero. The AeroBarrier crew investigated the source of the problem and found that there was a large leak past the poly on the ceiling of one of the bathrooms. In addition, a number of large leaks in the attic space were identified and sealed. The aerosol sealing then resumed. The 2 hours of aerosol sealing reduced

the house leakage by 88% down to 1.33 ACH₅₀ (Table 12 and Figure 45). The level was 56% below code, but similar to the value achieved for the builder's other houses. However, the leakage of 1.33 ACH₅₀ was achieved without spray foam wall or attic insulation and incomplete preparation for the aerosol sealing. At the end of construction after the spray foam was applied, the house leakage was further reduced to 0.7 ACH₅₀. It is likely that better preparation would have allowed the aerosol sealing to achieve the desired house leakage without the need for spray foam insulation. In addition, the interim airtightness testing provides the builder with valuable insight into whether leakage targets are on track to be met during an earlier stage of construction when certain sources of leakage are still accessible.

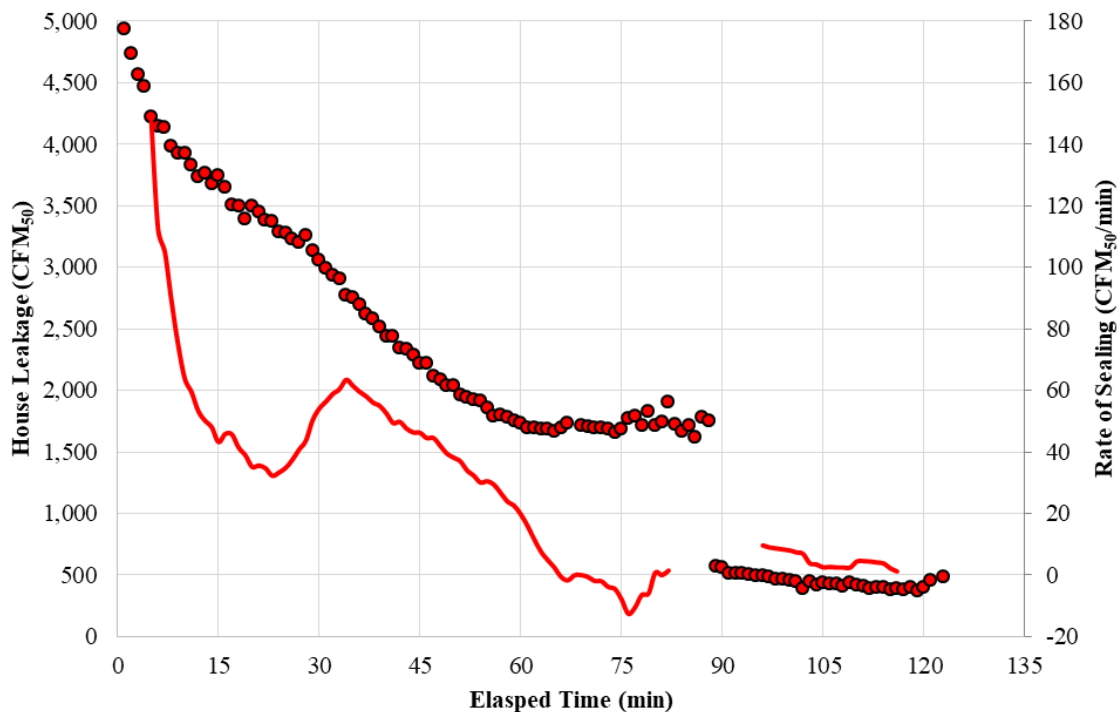

Figure 46. Sealing profile for Minnesota Builder #7 (House #25)

Minnesota Builder 8 is a high-performance house builder strongly interested in using aerosol envelope sealing for all of their houses. The house was sealed prior to the installation of wall insulation and drywall. As shown in Figure 47 (#26), the sealing rate started at 20 CFM₅₀/min, but dropped below 10 CFM₅₀/min after about 40 minutes and slowly decreased from that time until sealing was stopped after 90 minutes.

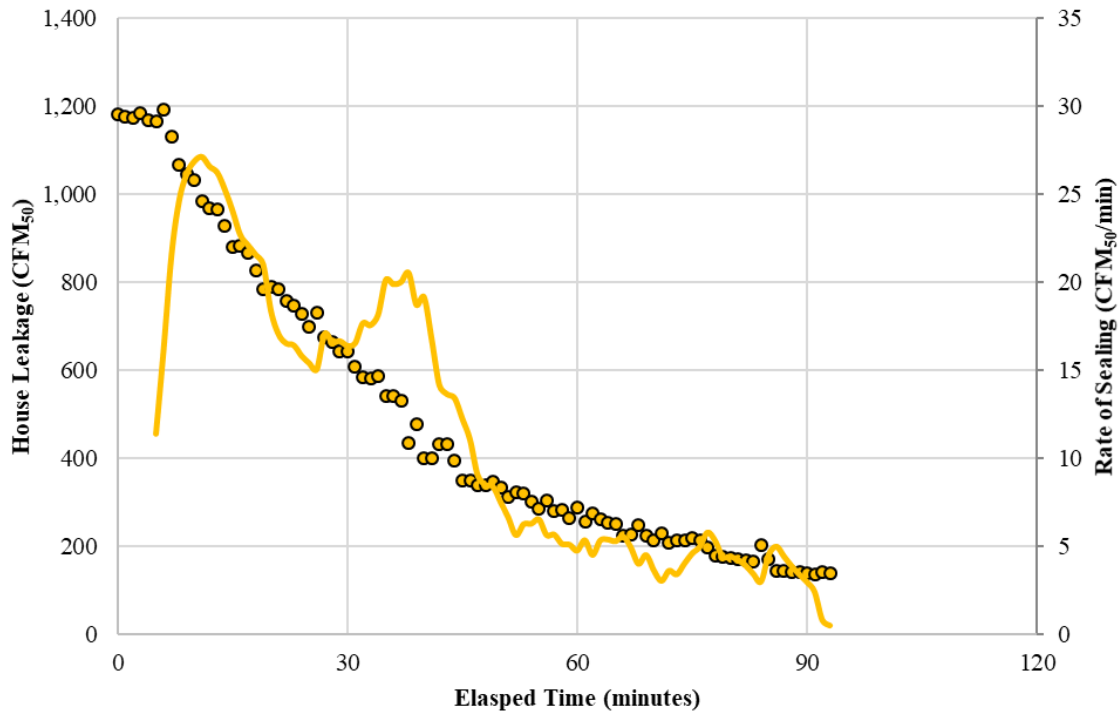

Figure 47. Sealing profile for Minnesota Builder #8 house (#26)

The envelope leakage started at a low level of 1.72 ACH₅₀, and the sealing reduced that by 81% to 0.32 ACH₅₀ (Table 12 and Figure 45). That is 89% below the code requirement of 3.0 ACH₅₀. Four similar houses constructed by this builder had envelope leakage that varied from 1.45 to 2.04 ACH₅₀, with an average of 1.72 ACH₅₀. The aerosol-sealed house leakage was 81% less than the average for this builder's houses that were not aerosol-sealed. This shows that aerosol sealing can produce extremely tight houses for this builder. If the four non-aerosol-sealed houses would have had a leakage of 0.5 ACH₅₀, the builder would have received an additional \$500 to \$1,000 in utility new home efficiency program incentives.

5.3 Illinois Triplex

A residence in Illinois was sealed to demonstrate the effectiveness of the aerosol envelope sealing process for a building type for which the builder historically had difficulty meeting an envelope leakage requirement. The builder was constructing a number of income-eligible, slab-on-grade, two-story triplexes in the suburban Chicago area. There are two units on the first floor (#27 and #28) and one unit on the second floor (#29). There is a common entry at the lower level. The second floor unit has an entry door off the common space on the lower level. The second floor unit has a flat roof, and the portion of #28 that is not below the second floor unit has a flat roof. Spray foam was applied to the rim joists and flat roof to parapet wall intersections. R-21 fiberglass batt insulation was used for wall insulation, R-49 continuous polyisocyanurate insulation used for roof insulation. A house wrap was used as the weather-resistive barrier. The builder's target leakage was the State of Illinois's code required envelope leakage of 5.0 ACH₅₀

with verification by an air leakage test. It was assumed that the leakage requirement would apply to the sum of the exterior and interior leakage or total leakage as measured by a compartmentalization-type leakage test. Achieving a total leakage of 5.0 ACH₅₀ was needed to meet the ENERGY STAR certification requirements. Additionally, a number of Minnesota builders had provided informal feedback that it was more challenging to meet envelope leakage requirements for slab-on-grade residences compared to houses with conditioned basements that are included in the test volume and surface area. The leakage requirement is based on the total leakage of the house divided by the house volume. Poured concrete basements are typically tight. Consequently, the above grade portion of a house can be leakier than the target and produce a total house leakage less than target because the overall leakage will be less than the target when the above grade and basement sections are combined. A slab-on-grade house does not have a tight basement to help offset a leakier above grade section.

Due to scheduling requirements, the three units were aerosol sealed after wall insulation and drywall were in place. The drywall had not yet been taped. The units were sealed individually with the blower door installed in the opening to the hallway so that the unit was pressurized with respect to both the outdoor and adjacent units. That sealing configuration provided aerosol sealing to both the exterior portion of the envelope (e.g., exterior walls and ceilings) and the interior portion (e.g., walls and horizontal surfaces between units) for all three units. If all three units were sealed simultaneously, only the exterior portion of the envelope would have been sealed.

The sealing proceeded smoothly, and all three units achieved an envelope leakage below the code requirement. The sealing profiles for the three units are shown in Figure 48. The rate of sealing started at about 20 CFM₅₀/min for #28; for the other two units the sealing rate started at about 10 to 15 CFM₅₀/min. Although these rates are lower than for the houses that were sealed pre-drywall, the sealing rates are consistent with the two houses that were aerosol sealed post-drywall (demonstration #19 and #23). For the second floor unit, the sealing was conducted for about 75 minutes when the sealing rate dropped below 5 CFM₅₀/min. The starting leakage was 7.68 ACH₅₀ and was reduced by 73% to 2.83 ACH₅₀, which is 43% below the code requirement of 5.0 ACH₅₀ (Figure 49 and Table 13). The leakage of the first floor east unit started at 7.68 ACH₅₀. The sealing rate dropped below 5 CFM₅₀/min after only 15 minutes, but the sealing continued for 90 minutes to assure that the final leakage would be well below 5.0 ACH₅₀ in case future construction caused the unit to become leakier. After aerosol sealing the leakage decreased by 54% to 3.52 ACH₅₀, or 30% below the code requirement. The first floor west unit started with the highest sealing rate, but after about 20 to 30 minutes the rate was similar to that of the other two units. The sealing rate dropped below 5.0 CFM₅₀/min after about 45 minutes, but the sealing continued for a little more than 2 hours to provide a leakage that would comfortably meet the code requirement. The leakage of the first floor west unit started at 8.55 ACH₅₀ and decreased by 52% to 4.07 ACH₅₀, which is 19% below the code requirement. During sealing of the west and east first floor units, there was considerable aerosol haze in the joining unit. This indicated weaknesses in the quality of fire caulking or foaming between units. During sealing the second

floor unit, it was visible from the exterior of the building that aerosol penetrated the parapet wall-to-roof intersection. Throughout the remainder of the aerosol sealing process for the second floor unit, the exterior visual of misting aerosol dissipated, indicating that the leakage points were sealed. The parapet walls were spray foamed. A possible explanation is that the spray foam delaminated from the wall assembly-to-roof intersection, or that a cavity was left void by accident, allowing aerosol to travel vertically out the top of the parapet wall. No further investigation was conducted to verify cause.

Post-aerosol sealing visual inspections showed that the aerosol created seals in many of the same locations observed for the two other post-drywall sealed houses. That included gaps around electric boxes, ceiling exhaust fans, and other penetrations. There were seals between the drywall and the sill plate and at any gaps in the drywall. The concrete-floor-to-polyisocyanurate insulation joint displayed a thick bead, which picture-framed the perimeter of the west and east units along the exterior wall. The team expected that much of the leakage through the drywall gaps would have been sealed by the drywall finishing work. Smoke puffer and infrared investigations did not find any significant air leakage locations. There was some moderate air movement into the heating system ductwork, suggesting that there were duct leaks that provided a path for air to leave the unit through ceiling cavities. Although the leakage reductions of 52% to 73% were somewhat less than achieved for other project houses, the work demonstrated that aerosol envelope sealing could provide a straightforward method for achieving code-compliant envelope leakage for slab-on-grade residential units. Reaching compliant leakage levels had been a challenge for the builder, and they had been concerned that they would need to make significant changes to their air sealing practices.

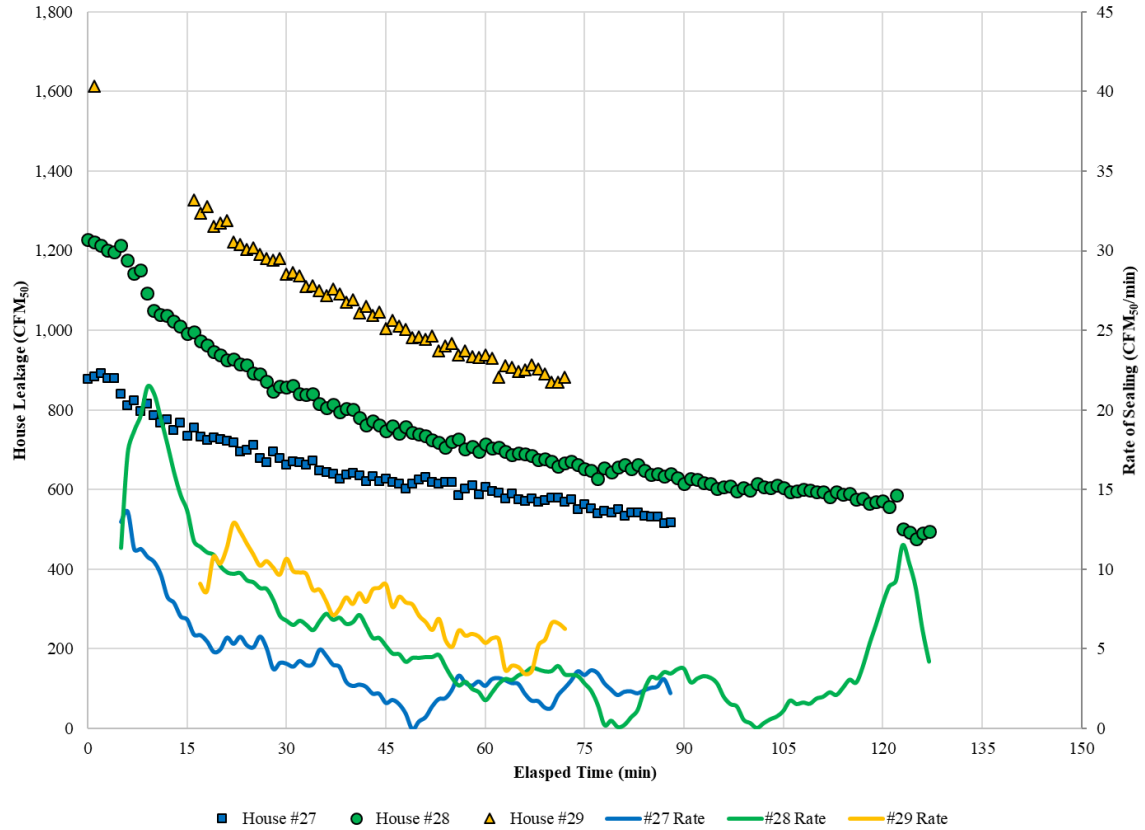

Figure 48. Sealing profile for Illinois Triplex

Table 13. Summary of Sealing Results for Illinois Triplex

House #	Floor Area (ft ²)	Volume (ft ³)	Pre-Seal		Post-Seal			End of Construction			
			CFM ₅₀	ACH ₅₀	CFM ₅₀	ACH ₅₀	% Reduction	CFM ₅₀	ACH ₅₀	Change (CFM ₅₀)	Change (%)
27	778	9,130	1,169	7.68	535	3.52	54%	581	3.82	46	9%
28	778	9,130	1,301	8.55	620	4.07	52%	452	2.97	-168	-27%
29	1,282	11,791	2,088	10.63	557	2.83	73%	493	2.51	-64	-11%

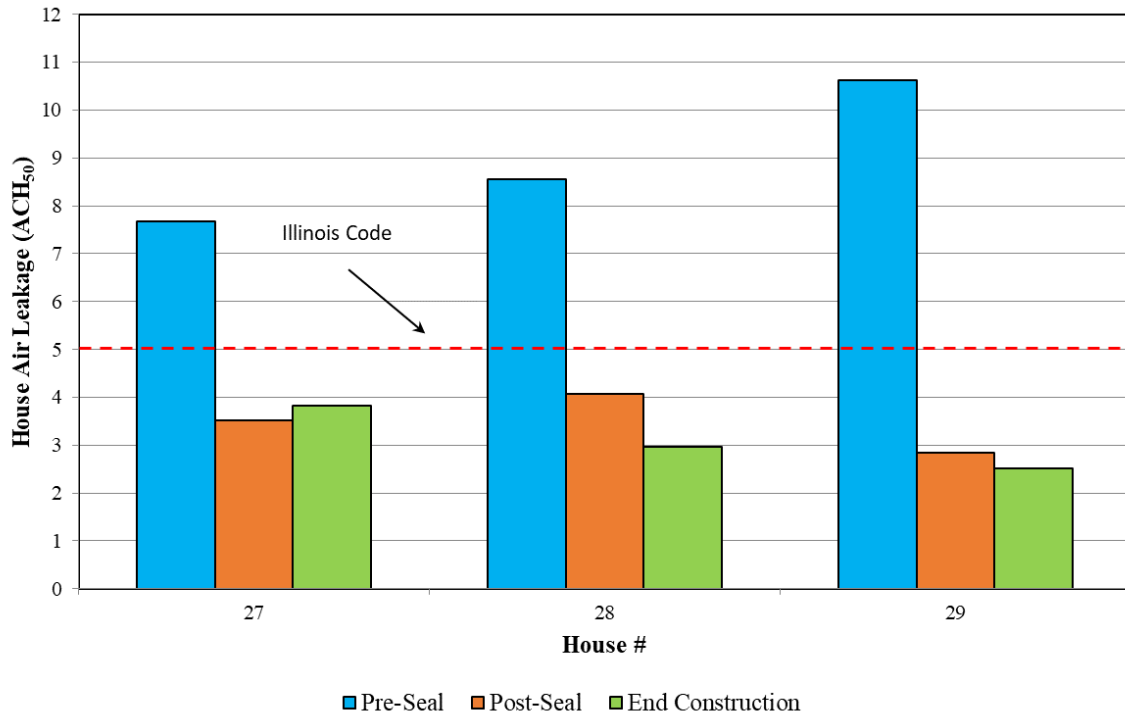

Figure 49. Air leakage results for Illinois triplex

In addition to the compartmentalization tests of unit total leakage, guarded air leakage tests were conducted to measure the envelope leakage to the exterior. The exterior leakage was subtracted from the total to provide an estimate of interior leakage—which includes leakage to adjoining units and the small common area. Table 13 displays the pre- and post-sealing total, exterior, and interior leakages for the three units. On average the exterior leakage accounts for only a third of the total leakage, and the percentage of exterior leakage was consistent. The first floor east unit had the lowest percentage of exterior leakage (29%), and the second floor unit had the highest (35%). This suggests that an intermittently operated exhaust ventilation system would likely draw a significant fraction of air from adjoining units and the common area.

The total, exterior, and interior envelope surface areas were computed and used to generate the surface-area-normalized leakages that are included in Table 13. This shows that the normalized leakage of the interior portion of the envelopes is much greater than that of the exterior. For the first floor west unit, the normalized interior leakage is more than 10 times greater than that of the exterior. This suggests that the builder needs to focus more attention on interior leakage in order to achieve a lower total leakage for the units. After aerosol sealing, the exterior leakages were reduced by 49%, 55%, and 69% for the second floor, first floor east, and first floor west units, respectively, with final leakages of 0.13, 0.08, and 0.05 CFM₅₀/ft². The largest relative change in leakage occurred for the second floor interior leakage, which caused the normalized interior leakage to be equal to that of the exterior leakage (0.13 CFM₅₀/ft²). The first floor west and east unit interior leakages were only reduced by 45% and 54%, respectively, for final normalized leakages that were still quite high (0.96 and 0.38 CFM₅₀/ft², respectively). Because visual and

smoke-puffer-aided inspections did not identify any significant interior leakage locations, this suggests that there could be diffuse leakage at the interior envelope surface that has large leakage pathways between the units. Further inspections at earlier stages of construction could help identify and address those pathways.

Table 14. Detailed Illinois Triplex Leakage

House #	Total	Exterior	Interior	Total	Exterior	Interior	Total	Exterior	Interior
	Surface Area (ft²)			Pre-Leakage (CFM₅₀)			Pre-Norm. Leakage (CFM₅₀/ft²)		
27	2,972	1,976	996	1,169	341	828	0.39	0.17	0.83
28	2,991	2,481	510	1,301	423	879	0.44	0.17	1.72
29	4,309	2,856	1,452	2,088	730	1,358	0.48	0.26	0.94
				Post-Leakage (CFM₅₀)			Post-Norm. Leakage (CFM₅₀/ft²)		
27				535	154	381	0.18	0.08	0.38
28				620	133	487	0.21	0.05	0.96
29				557	374	183	0.13	0.13	0.13
				Leakage Reduction (CFM₅₀)			Leakage Reduction (%)		
27				634	187	447	54%	55%	54%
28				681	290	392	52%	69%	45%
29				1,531	356	1,175	73%	49%	87%
				End Construction Leakage (CFM₅₀)			End Norm. Leakage (CFM₅₀/ft²)		
27				581	326	255	0.20	0.16	0.26
28				452	230	222	0.15	0.09	0.44
29				493	365	128	0.11	0.13	0.09
				Leakage Change (CFM₅₀)			Leakage Change (%)		
27				46	172	-126	9%	112%	-33%
28				-168	97	-265	-27%	73%	-54%
29				-64	-9	-55	-11%	-2%	-30%

5.3.1 End-of-Construction Leakage

End-of-construction leakage was measured to determine whether the aerosol-sealed triplex units became tighter or leakier through the rest of the construction process. It was possible that completion of the interior air barrier could cause the houses to be tighter. Pouring gypsum concrete on the floor of the second floor unit would have likely had the most significant impact on reducing leakage between the units. However, the units could become leakier if there was inadequate sealing of any additional penetrations or seals created by the aerosol sealing were disturbed by the remaining construction. The total (i.e., sum of interior and exterior) leakages are included in Table 13 and represented by green bars in Figure 49. The total leakages ranged from 2.51 to 3.82 ACH₅₀ for units 29 and 27, respectively, and averaged 3.10 ACH₅₀. For all of the units the total leakages were at least 24% below the Illinois code requirement of 5.0 ACH₅₀, and the average leakage was 38% below the requirement.

The change in the total leakages for units #28 and #29 were only 46 CFM₅₀ (9%) and -64 CFM₅₀ (-11%¹⁹), respectively. There was a large reduction of 168 CFM₅₀ (27%) for one of the first floor units (#27). In general, the changes in total leakage were due to a moderate increase in exterior leakage and significant reduction in interior leakage. Table 14 includes the interior and exterior leakages that sum to the total. The upper unit (#29) had a small reduction of exterior leakage (9 CFM₅₀ or 2%) and moderate reduction of interior leakage (55 CFM₅₀ or 30%). The exterior leakage of the two first floor units (#27 and #28) increased by 97 CFM₅₀ (73%) and 172 CFM₅₀ (122%), respectively, while the interior leakage decreased by 265 CFM₅₀ (54%) and 126 CFM₅₀ (33%), respectively. This suggests that the work that occurred after the aerosol sealing tended to increase the exterior leakage somewhat but reduce the interior leakage significantly. Because the house setup was the same for the post-aerosol sealing and end-of-construction tests, it is likely that the 97 and 172 CFM₅₀ increases in exterior leakage were caused by additional leaks caused by the remaining construction work. Conversely, the additional construction work resulted in an average reduction of interior leakage of 149 CFM₅₀ (42%).

The leakage of units of an identical triplex constructed by the same builder and not aerosol sealed were measured to compare the impact of the aerosol sealing to standard construction. The total leakages ranged from 2.71 to 4.83 ACH₅₀ and averaged 3.98 ACH₅₀. The average leakage for the aerosol units was 22% less than that for the standard construction units. The sum of the exterior leakage for the aerosol-sealed units was 5% less than the value for the standard construction units, while the sum of the interior leakage was 37% less. This suggests that that aerosol sealing had a greater impact on reducing leakage between units than on exterior leakage, but this is too small of a sample to draw general conclusions.

¹⁹ The uncertainties of the change in total leakage were less than 10 CFM₅₀ for all three units. The uncertainties of the change in exterior and interior leakages are expected to be greater because the uncertainties of guarded test leakages are impacted not only by measurement errors but also the validity of the assumption that the units can be treated as discrete zones.

5.4 Builder Interviews

Project staff conducted interviews with builders using 12 open-ended questions to initiate an informal discussion. The script, questions, and a summary of the feedback are included in this section.

1. What is the range of leakage that you typically get for your houses and what is the most typical leakage? Do you have a target leakage? What would be the biggest challenges in using aerosol sealing for your houses?

The typical and target leakage rates for each builder are shown in Figure 50. The Minnesota builders all achieved ACH₅₀ values under the climate zone 6 ceiling of 3.0—averaging between 1.0 and 1.5—and set their targets near or below 1.0 ACH₅₀. These builders view aerosol sealing as a good tool to help them lower their achieved values. The developers in California do not set ACH₅₀ targets for themselves, nor do they conduct blower door testing of their homes, citing the lack of requirements in the California Building Energy Efficiency Standards and the relatively low performance credits achieved when meeting a lower leakage target. An ACH₅₀ of 5.0 is regarded as standard in their area, and the developers assumed that by following local building codes they are achieving that standard. The midsize builder in California saw significant variation in the ACH₅₀ values of their homes, ranging from about 2.0 to 5.0, but was uncertain of the cause.

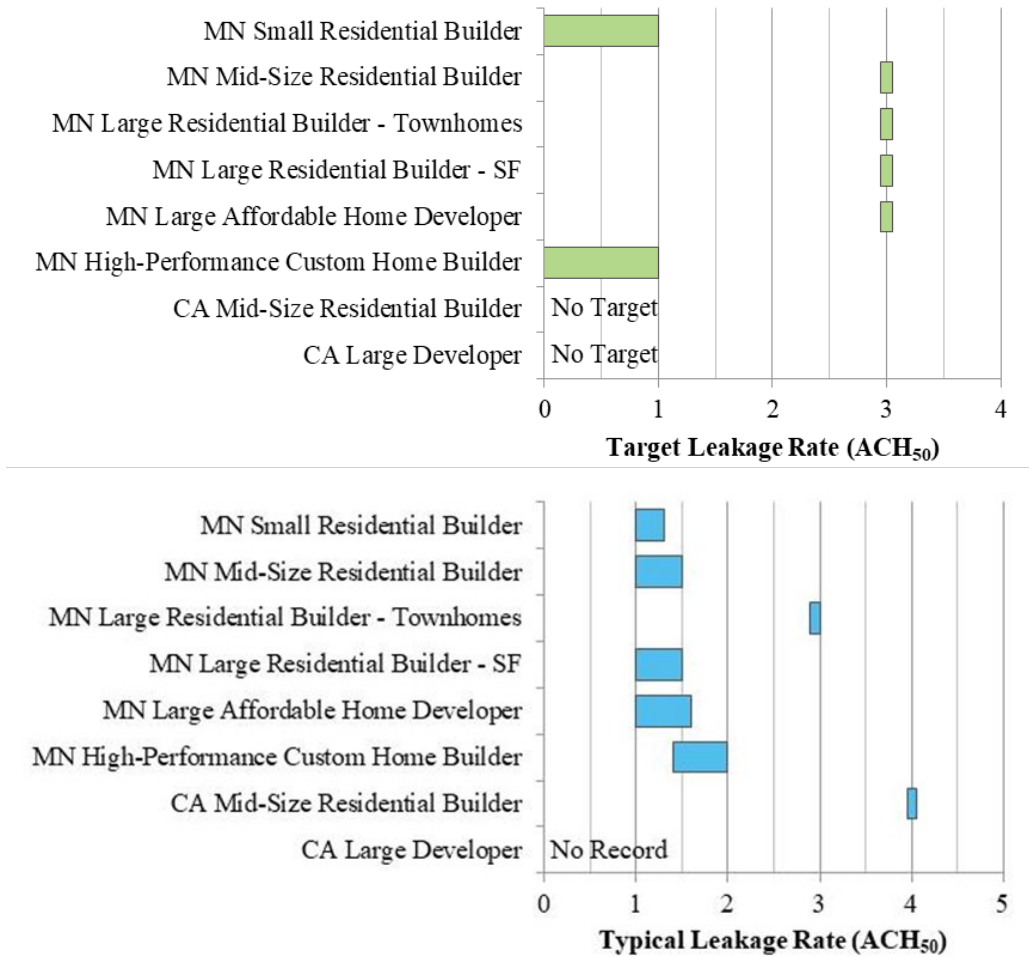

Figure 50. Builder-reported target (top) and typical (bottom) leakage rates

The most frequently stated challenge to using aerosol sealing was the cost and the difficulty justifying it to the builders' customers (Figure 50). Customers are commonly less concerned with air sealing than with more visible and tangible aspects of their home, and are often willing to reduce overall costs by minimizing their investment in high-quality air sealing. If aerosol sealing enables them to eliminate other sealing measures (especially spray foam), this challenge will be greatly reduced.

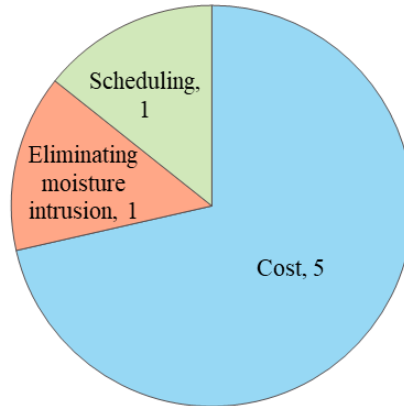

Figure 51. Biggest challenge to using aerosol sealing

The developers in California, where the moderate climate makes air sealing a less pressing concern, expressed expectations that more builders may come to rely on aerosol sealing as regulations become increasingly stringent. This in turn would help the technology achieve greater scale and reduced costs to customers.

The other challenge that the builders shared was difficulty in scheduling the aerosol sealing, the most burdensome aspect being the need to empty the house of other workers. Again, builders expect that this issue would be largely mitigated by sufficient scaling of the product because the availability of local applicators would reduce scheduling complications.

The large residential builder in Minnesota voiced significant doubts as to whether moisture intrusion could be prevented in homes any tighter than their current standards. They already deal with a great deal of warranty issues that involve moisture intrusion, and they are fearful of the costs that would be incurred if such problems worsen due to reduced breathability as well as the challenge of balancing interior and exterior pressures in tightly sealed buildings. A major factor they cited was the challenge of ensuring that customers maintain their ventilation systems, which are especially crucial to maintaining the pressure balance in very airtight homes.

2. What would be the most significant benefits in using aerosol sealing for your houses?

The builders listed nine significant benefits for using aerosol sealing (Table 15). Many of the responses focused on reduced energy use. The most frequent responses were energy efficiency or reduced air leakage (three builders) and energy cost savings (two). Other cost benefits noted were utility incentives/credits (two builders), reduced rooftop solar costs in net zero energy homes (one), and saving subcontractor time (one). Non-energy and cost benefits included eliminating human error (two), improved air quality (one), and improved long-term durability (one).

Table 15. Benefits of Using Aerosol Sealing

Most Significant Benefits in Using AeroBarrier	Energy efficiency/reducing leakage	Eliminating human error	Energy cost savings	Utility incentives/credits	Air quality	Passive House certification	Reduc. rooftop solar \$ in net zero homes	Long-term home durability	Saving subcontractors' time
CA Large Developer	X								
CA Midsize Residential Builder				X			X		
MN High-Performance Custom Home Builder	X					X			
MN Large Affordable Home Developer		X	X					X	X
MN Large Residential Builder	X		X	X	X				
MN Midsize Residential Builder									
MN Small Residential Builder		X							

- At what point of the construction process would it make most sense for you to use aerosol sealing?

Almost all builders surveyed suggested applying AeroBarrier after rough inspection, prior to applying insulation. One builder suggested manually sealing visible gaps as usual prior to application and using aerosol sealing as a backup to seal undetectable leaks. The builders sought to achieve a fully sealed envelope before applying insulation and commented that this is also a convenient time to keep the house clear of other workers for the application.

The only builder without a decisive stance spoke to the tradeoffs of applying aerosol sealing before and after insulation—application prior to insulation requires much more contractor coordination but makes it easier to confidently eliminate other air sealing measures. Aerosol sealing after drywall makes coordination much simpler, but any leaks it reveals within the wall cavity that must be sealed manually would require removal of the drywall.

4. What current air sealing do you think you could eliminate if you were using aerosol sealing?

Almost half of the builders indicated that they would not eliminate any current sealing or were unsure what could be eliminated (Figure 52). The high-performance custom home builder and the small residential builder in Minnesota both stated that they would ideally incorporate aerosol sealing into their existing practices without eliminating other measures. However, the high-performance builder expressed interest in experimenting with future homes to determine whether other measures could be eliminated without compromising tightness—the small residential builder presumed that this would be possible, but said they preferred using aerosol sealing to increase redundancy in the building envelope. The midsize residential builder in Minnesota was likewise hesitant to eliminate alternatives, but would do so if aerosol sealing alone were proven effective. The California developer stated that “if the goal was to make the home as tight as possible, this product would be far superior to the method we used [when that was one of our goals],” citing far greater cost-effectiveness for comparable results. The Minnesota large residential builder was confident that polyethylene sheeting could be eliminated.

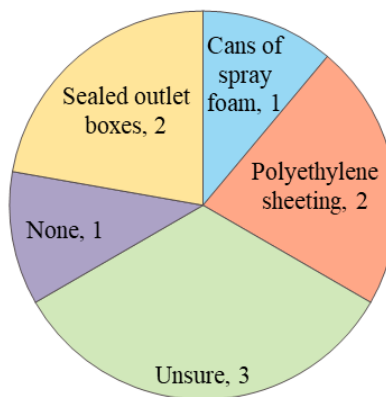

Figure 52. Current sealing that could be eliminated

5. We are interested in the possible cost savings for eliminating some of these current sealing methods. Is it possible for you to make an estimate of the cost savings? If so, could you provide that to us?

The Minnesota builders were not confident that eliminating other sealing methods by using aerosol sealing would provide significant savings. The California builders, however, suggested that it might be possible to calculate such savings and that insulation contractors would be the best source for reasonable estimates.

6. Are there certain types of houses or construction where you think aerosol sealing will be a better application?

Many builders surveyed agreed that aerosol sealing is a good solution for homes with complicated architecture or framing, which can make access to leaks challenging or impossible

(Figure 53). Two builders recommended the application for slab-on-grade homes, and another recommended it for what they considered the “ends of the spectrum” in terms of insulation investment: those with batt insulation at the low end, those with spray foam at the other. Another suggested applying aerosol sealing in their rambler homes, where large attic volumes make effective sealing difficult.

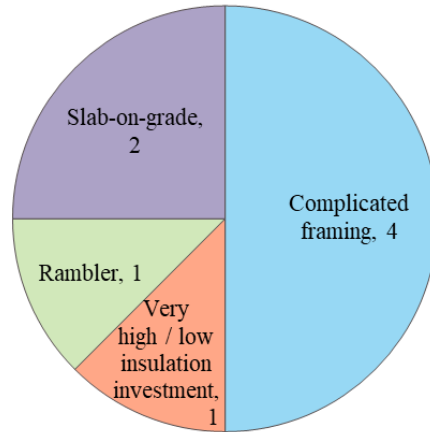

Figure 53. Best type of construction for aerosol sealing

7. Are there other housing types or parts of the country where you think aerosol sealing will have more impact?

All respondents stated that extreme hot or cold climates would likely see the greatest impact from using aerosol sealing, with one Minnesota builder suggesting that their state, specifically, would benefit most from the application.

8. What would it take for you to incorporate aerosol sealing into your construction process?

The main challenge that the builders expressed was the high cost of the application and their difficulty justifying its use to their customers. Most suggested that reducing this barrier would be the surest way to enable its incorporation into their regular operations. Two builders suggested developing a better sales strategy with which to approach their customers; two expressed a need for a nearby applicator to make scheduling more feasible and costs more attainable; and another suggested that finding the best point in the construction process to apply aerosol sealing would be helpful for scheduling purposes and to maximize its effectiveness. The Minnesota high-performance custom home builder said that the discount they received from their supplier had a large impact in enabling their use of the product, and both the large California developer and the midsize Minnesota residential builder suggested that building code changes could have a significant impact on cost-effectiveness. Increased air sealing requirements, they said, would force builders to implement solutions like aerosol sealing, enabling them to incorporate it into their construction process by reducing cost and increasing availability. Increased utility rebates would likewise improve cost-effectiveness, especially if builders could accurately model the tightness and resulting rebates achievable, as suggested by the midsize residential builder in

California. The same builder also suggested that more accurate home energy use modeling technology would improve their ability to evaluate the cost-effectiveness of aerosol sealing by providing a better comparison of its performance relative to other efficiency measures.

The large residential builder in Minnesota expressed more concern over moisture intrusion than anything else, and suggested they would need to change their building practices if they were to increase the tightness of their homes without increasing moisture intrusion.

9. Do you currently use energy efficient homes and/or insulation and air sealing as a marketing tool? Now that you have witnessed the process and effectiveness of aerosol sealing, could you use it as a future marketing tool?

Three of the five Minnesota builders surveyed use the energy efficiency of their homes as a marketing tool, proudly advertising their achievements in a climate that demands significant heating and cooling (Figure 54). The affordable housing developer is likely to increase their incorporation of energy efficiency in marketing materials for donors, who are more likely to be concerned with energy use than their clients for whom affordability generally supersedes other concerns. Similarly, the Minnesota midsize builder suggested that it would be easy to market aerosol sealing to clients particularly concerned about energy efficiency and home tightness.

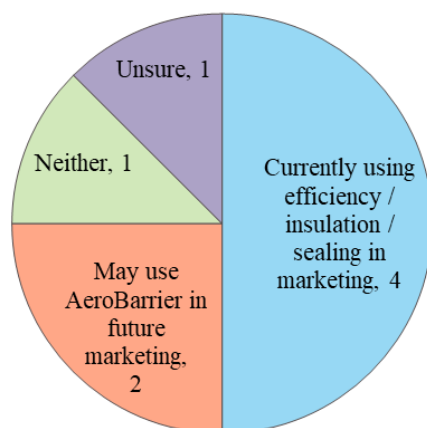

Figure 54. Energy-efficient home marketing

The large California developer does not market the energy efficiency of their homes, nor do they set additional efficiency or leakage targets in addition to state requirements. The midsize California residential builder, however, uses a carefully crafted marketing approach to sell their net zero energy homes. They voiced a need to educate their customers about the various factors that impact a home’s energy use, and the challenge of doing so. Air sealing could be used in their marketing, they said, but it is very difficult to demonstrate to the customer the benefit of paying more for aerosol sealing, as the results can easily go unnoticed.

10. What information or sales material would be beneficial to show home buyers the benefits of aerosol sealing?

Three builders suggested providing a cost-benefit analysis of using aerosol sealing in the home to address buyers’ main concern (cost) with the product (Figure 55). The high-performance custom home builder also recommended showing the health benefits of the interior environment created in a well-sealed home. Materials recommended included brochures for display at open houses and other events and a video depicting the application procedure. Only the large residential builder in Minnesota was uninterested in marketing materials, as their customers do not seem to know enough about air sealing to concern themselves with it.

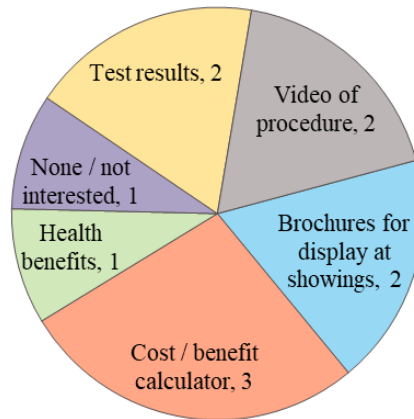

Figure 55. Beneficial information for home buyers

11. Compared to other builders, are you currently using home comfort as a talking point with potential home buyers and/or energy cost savings as an advantage with your homes over other builders?

The Minnesota high-performance custom home builder and the California midsize builder were alone among those surveyed in using home comfort or energy cost savings as advantages of their homes when talking with potential home buyers (Figure 56). The California builder spoke to the difficulty of using energy cost savings as a talking point due to the small amount of savings that their customers gain. The Minnesota small residential builder plans to in the future though they currently do not, and the Minnesota affordable housing developer stated that comfort is of little concern to their customers relative to affordability. The Minnesota midsize builder, while not marketing the comfort of their homes as an advantage over other builders, has implemented various comfort-related practices—such as whole-home spray foam applications and dual-zone climate control—and speaks to that experience when clients raise questions about home comfort.

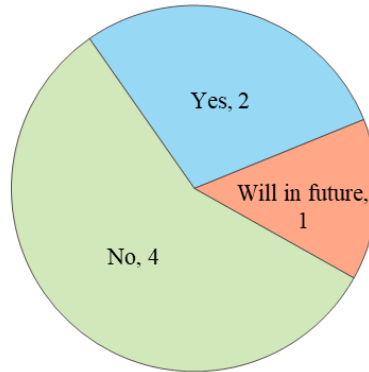

Figure 56. Use home comfort and/or energy efficiency as talking point with potential homeowners

12. Do you typically receive utility energy efficiency incentives for your houses? If so, do you think that consistently getting your houses to 0.5 to 1.0 ACH₅₀ with aerosol sealing would get you a higher incentive and, if so, how much more? If not, would you be more likely to pursue getting incentives if you were using aerosol sealing?

All the builders were aware of, and made use of, utility energy efficiency incentives, but only the large residential builder in Minnesota found them lucrative enough to encourage lowering their ACH₅₀ targets. The large developer in California expressed that the incentives were a bonus but not a deciding factor when building for high performance. The midsize builder in California expressed that the performance credits and incentives do not justify the cost to seal and verify the homes.

5.5 Energy Modeling

Energy modeling was conducted to evaluate the impact envelope sealing has on home energy use. The simulations were conducted in each of the IECC climate zones to determine how climate conditions impact the results. Air sealing typically reduces the thermal loads on a building by reducing the amount of unconditioned air that enters buildings through leaks.

In order to model a building using common energy simulation software, several assumptions must be made about the construction of the building and the performance characteristics of many of the systems within the building. The value of the results obtained from such a simulation is highly dependent on the specific capabilities of the modeling software and the extent to which the software allows dependent and independent variables to be analyzed. The independent variables include the building's physical characteristics and operating parameters of the ventilation systems. The dependent variables include building energy use, total outside airflow (e.g., infiltration and ventilation), and interzonal airflows (e.g., adjoining units and units to/from common spaces). Clearly, the accuracy or validity of the various inputs and assumptions has significant influence on the results.

Building Energy Optimization Tool™ (BEopt) was used to model energy savings when sealing homes to different leakage levels in several climate zones. BEopt is a parametric analysis tool

that allows multiple building configurations to be compared using EnergyPlus® as the simulation engine. The Building America B10 Benchmark (Hendron and Engebrecht 2010) was used for the baseline, and the envelope leakage was varied between 0.6 and 10.0 ACH₅₀. The B10 Benchmark is consistent with the 2009 International Energy Conservation Code (IECC 2009) and uses ASHRAE 62.2-2010 mechanical ventilation rates (ASHRAE 2010) and an envelope leakage of 7.0 ACH₅₀. BEopt calculates the hourly infiltration rate based on both mechanical and natural forces. The mechanical system flows and natural (wind and stack) flows are combined to calculate the overall infiltration. Mechanical systems include bathroom and kitchen exhaust, and laundry dryers, which are scheduled to operate intermittently. Several IECC climate zones were modeled, including 1A, 2A, 2B, 3A, 3B-CA, 3B-Other, 3C, 4A, 4B, 4C, 5A, 5B, 6A, 6B, 7, and 8.

The model selected was a two-story, slab-on-grade, four-bedroom, three-bathroom, 2,400 ft² home with an attached garage. The ceilings were 8 ft, and the B10 Benchmark values were selected for all fields other than the infiltration rate, which was the dependent variable analyzed. A gas furnace with a 78% annual fuel utilization efficiency was selected for heating, and a single package air conditioner with a seasonal energy efficiency ratio of 13 was selected for cooling. The space heating and cooling used a central distribution system located entirely in an unfinished attic with a total leakage of 15% of the total air handler flow. The clothes dryer, bathroom exhaust fans, and kitchen exhaust fan were scheduled to operate for an hour each day. There is a 50-cfm exhaust fan in each bathroom that operates between 7 a.m. and 8 a.m. The 100-cfm kitchen exhaust fan operates between 6 p.m. and 7 p.m. The clothes dryer has an exhaust air flow rate of 100 cfm and is scheduled to operate for an hour each day between 11 a.m. and 12 p.m. The continuous mechanical ventilation system is an exhaust-only system that operates based on ASHRAE 62.2-2010 rates.



Figure 57. Geometry of home used for infiltration modeling

5.5.1 Energy Savings

In order for builders to evaluate the benefit of producing tighter building envelopes, it is necessary to understand the energy savings associated with sealing their homes. There is a lack of data showing measured energy savings for homes that are sealed versus unsealed. In many cases the impact is too small to measure with the appropriate accuracy. Thus, building energy simulations are used to evaluate the relative impact of air sealing for different climate zones in the United States.

A BEopt analysis was performed to evaluate the impact of envelope air leakage on house energy use. Figure 58 shows a chart of the source energy savings for various levels of sealing for 16 U.S. locations across 16 climate zones. The results show that reducing the leakage of a 2,400 ft² single-family home from the B10 Benchmark of 7.0 ACH₅₀ to 2.0 ACH₅₀ would save 1%–18% of the source energy use for a home, depending on the climate zone. Sealing a home from 5.0 ACH₅₀ to 2.0 ACH₅₀ would achieve 1%–11% savings, and sealing a home from 3.0 ACH₅₀ to 0.6 ACH₅₀ would achieve 0%–6% source energy savings. Colder climates benefited the most from air sealing, with climate zones 5A, 6A, 7, and 8 showing the largest savings.

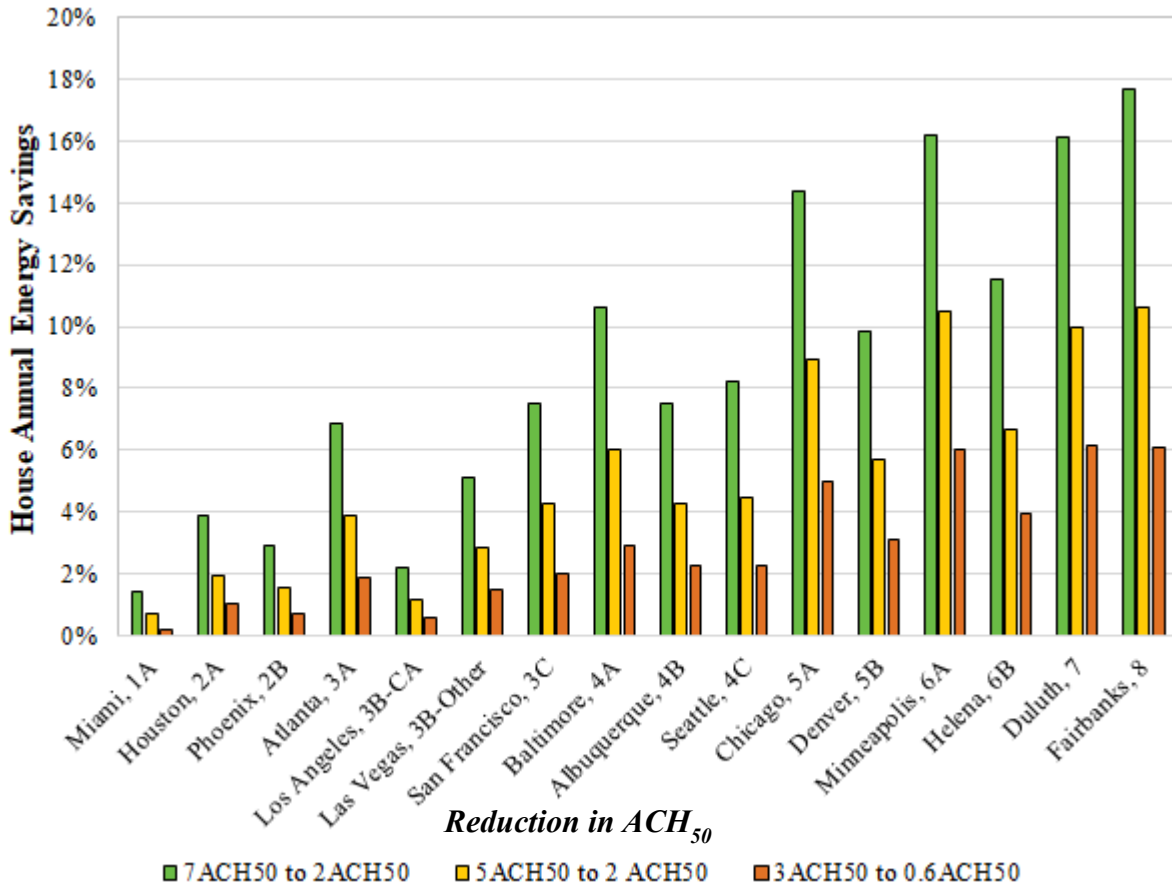

Figure 58. Total energy savings from reducing air leakage in the model home in each U.S. climate zone

Figure 59 and Figure 60 present the cooling and heating source energy savings when reducing envelope leakage of homes in each of the 16 climate zones. The majority of the energy savings from sealing homes was due to reduced heating energy use. All climate zones had a reduction of at least 20% of source heating energy when sealing from 7.0 ACH₅₀ to 2.0 ACH₅₀. Multiple climate zones showed an increase in source energy used for cooling. This is a result of increased infiltration during periods when the air outside is cooler than inside providing “free cooling” to the homes. This occurred even with window some operation considered in the simulation, allowing windows to be opened when temperatures are cooler outside than inside. Many of the climate zones that showed an increase in cooling energy use were in cold climates that do not have significant cooling loads, so the results need to be considered relative to the reduction in heating energy use.

Figure 61 and Figure 62 show the site energy use intensity for electricity and natural gas in each of the 16 climate zones. The total energy use intensity for both electricity and gas were lower with a tighter envelope in all climate zones except one. Climate zone 3B-CA (Los Angeles) showed a slight increase (0.5% or less) in electricity energy use due to the reduced infiltration.

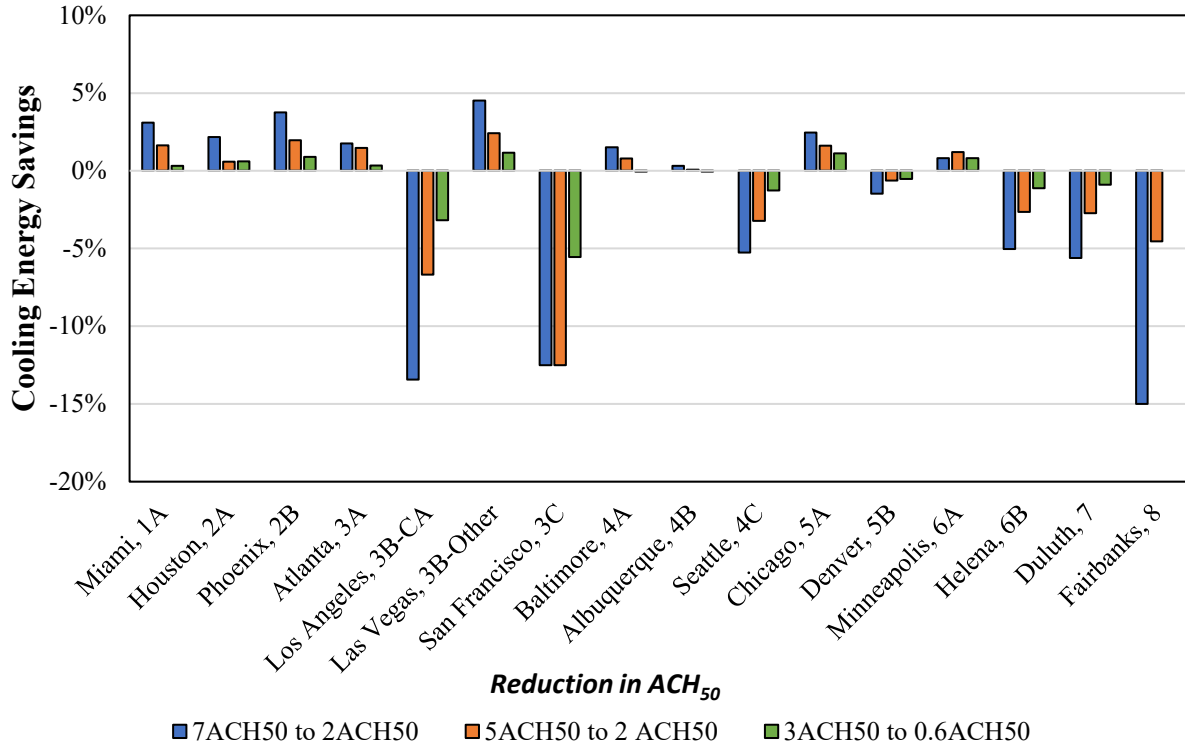

Figure 59. Cooling energy savings from reducing air leakage in the model home in each U.S. climate zone

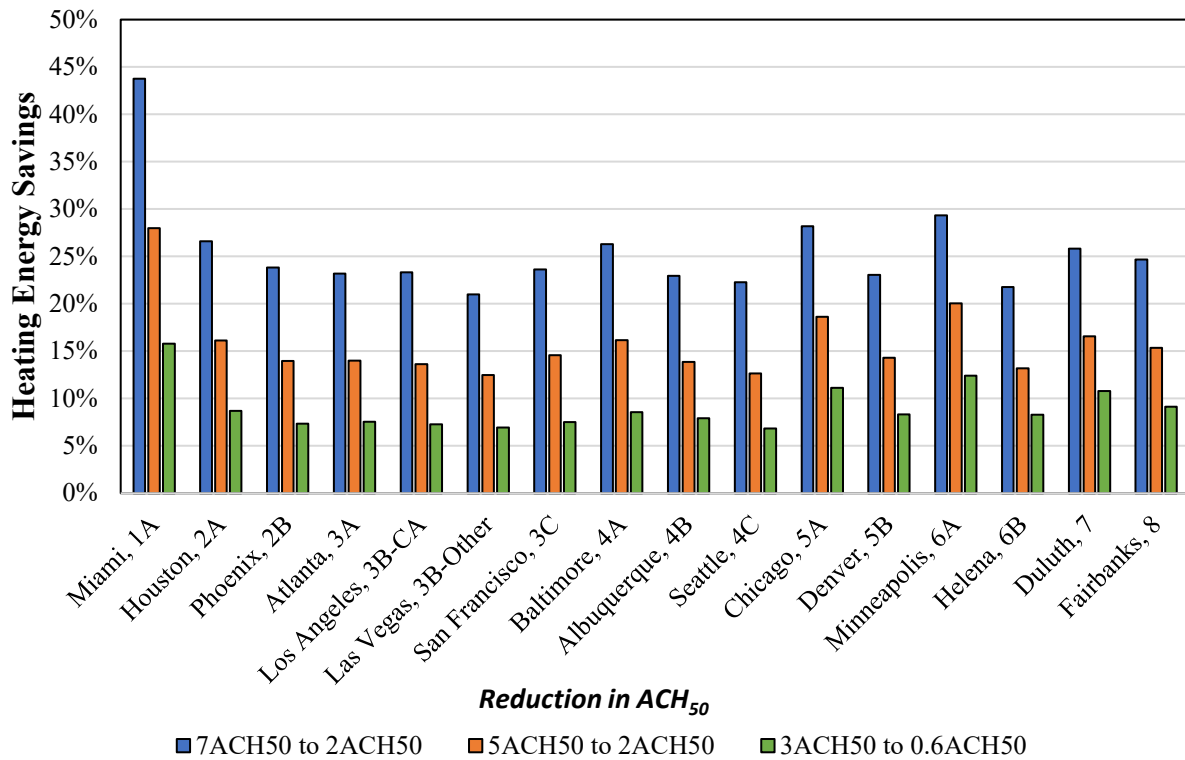

Figure 60. Heating energy savings from reducing air leakage in the model home in each U.S. climate zone

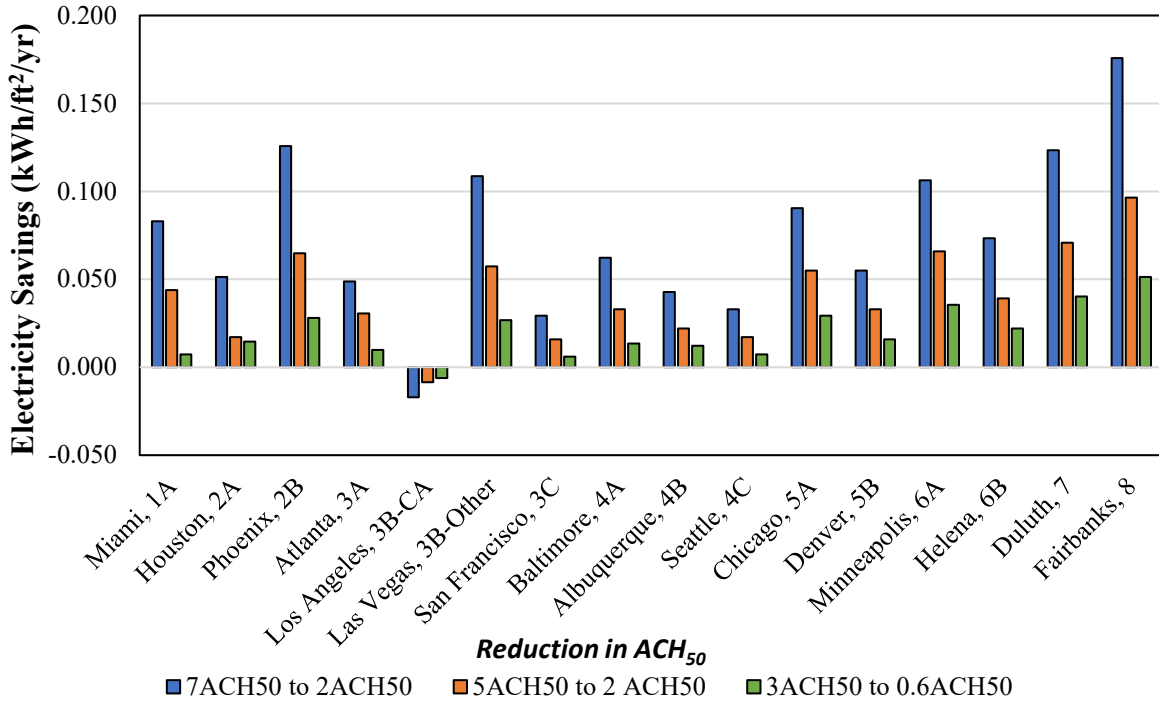

Figure 61. Cooling energy intensity reduction from reducing air leakage in the model home in each U.S. climate zone

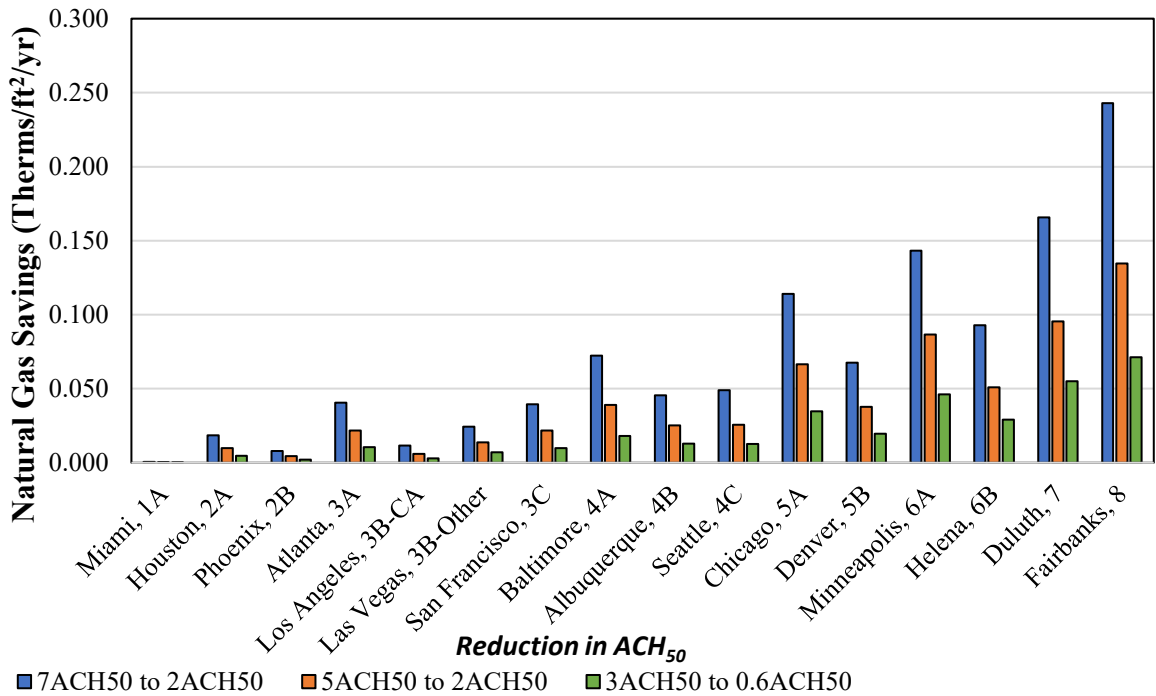

Figure 62. Heating energy intensity reduction from reducing air leakage in the model home in each U.S. climate zone

6 Conclusions and Recommendations

Aerosol envelope sealing was very effective at sealing air leaks in the homes. Many of the demonstrations resulted in a tightness below 1.0 ACH₅₀, which is well below the California prescriptive target of 5.0 ACH₅₀ and Minnesota Energy Code requirement of 3.0 ACH₅₀. The low air leakage was often achieved prior to completion of the homes, and in many cases prior to drywall being installed. This project demonstrated the ability to seal homes at various stages of construction, including before and after drywall is installed, allowing the process to be applied in a multitude of situations.

For the homes in California with unvented attics, the aerosol sealing was effective when applied before or after the spray foam insulation. Houses sealed after the spray foam was applied to the roof deck were quicker to seal and required less preparation than houses sealed before the spray foam was applied. The homes sealed before spray foam was applied demonstrated that aerosol sealing provided better air sealing results than open-cell spray foam insulation, allowing the builder to potentially use less expensive alternatives to insulate homes that are sealed with the aerosol technology. It will depend on the overall cost savings of alternative insulation methods to ultimately decide which option should be pursued in the future. The aerosol-sealed homes with unvented attics and open-cell spray foam ended up 39% tighter than the two control homes, with an average leakage of 1.1 ACH₅₀ compared to 1.8 ACH₅₀ for the controls. The two houses sealed with aerosols that used netted insulation had higher leakage rates than the homes with open-cell foam, averaging 2.6 ACH₅₀ at the end of construction. The aerosol-sealed homes with the netted cellulose insulation were about 50% tighter on average than the three control homes, which had an average leakage of 5.1 ACH₅₀.

The average post-sealing leakage for the five California homes with vented attics was 1.71 ACH₅₀, which is 66% below the California nominal target of 5.0 ACH₅₀ and slightly tighter than the sealed-attic houses without aerosol sealing. There was a significant increase in leakage after the end of aerosol sealing that can be largely attributed to leakage through fire sprinklers and backdraft dampers that were taped over during the aerosol sealing process. End-of-construction tests showed the aerosol-sealed homes were 33% tighter than the control homes. The aerosol-sealed homes ended up at 3.1 ACH₅₀ compared to the baseline homes at 4.6 ACH₅₀.

The seven houses sealed for the first Minnesota builder had an average air leakage of 0.98 ACH₅₀ after sealing and before the polyethylene sheet and drywall was installed—that is 50% tighter than the average leakage of the two control houses at the end of construction. This indicates that the required house tightness can be achieved without the interior poly, with the application of a low-perm paint satisfying the vapor barrier code requirement. Eliminating the poly sheeting and airtight electrical boxes, along with increased utility incentives, will help offset the added cost of the aerosol sealing. Field experience showed that for early construction sealing, greater care is required to adequately secure the ceiling poly sheets, and wall batt insulation should not be present. There may be added cost for the greater care and if installing the poly prior to the wall insulation requires an added trip. Another option is to install sheet rock on the

ceiling prior to the sealing. For the eight houses sealed for the other five builders, the sealing produced an average leakage reduction of 75% for an average post-sealing leakage of 0.68 ACH₅₀. Half of the houses had a leakage less than 0.6 ACH₅₀, and only one house had a leakage greater than 1.0 ACH₅₀.

Post-aerosol sealing air leakage tests were repeated at the end of construction to determine whether the houses became tighter or leakier through the rest of the construction process. The assessment of the change in house leakage was complicated by differences in the house setup and test method. The post-sealing test was conducted as a pressurization test shortly after the aerosol sealing was complete when intentional openings were temporarily sealed, while most of the openings were left open for the end-of-construction depressurization test. All four California vented attic homes had significant increases in leakage from the post-sealing test to the end-of-construction test that ranged from 86 to 640 CFM₅₀ and averaged 397 CFM₅₀. Much of that was due to fire sprinklers (about 100 CFM₅₀), and 200 to 300 CFM₅₀ was through poorly fitting backdraft dampers. Fire sprinkler penetrations are within the envelope of sealed attic houses. The two sealed attic houses that were sealed after spray foam had only small (50 and 80 CFM₅₀) increases in leakage. The two houses that were foamed after aerosol sealing had changes in leakage of -98 and 6 CFM₅₀ from post-foam sealing to end of construction.

In order to evaluate the impact of the different test procedures, at the end of construction, six of the Minnesota builder houses were tested with two different procedures: (1) pressurization with sealed openings (similar to the post-sealing test), and (2) depressurization with unsealed openings. The increase in measured leakage using the unsealed procedure varied from -1 to 176 CFM₅₀ and averaged 81 CFM₅₀. Exhaust fan inlet leakage varied from 5 to 18 CFM₅₀. The leakage of the heat recovery ventilator intakes/exhausts was only 4 and 12 CFM₅₀ for one unit, but much higher (42 and 56 CFM₅₀) for a second unit. Leakage through 25-ft long 6-in. flex combustion air ducts was about 100 CFM₅₀. For all except one of the Minnesota and Illinois residences, there was either a decrease in leakage from the post-sealing to the end-of-construction tests or the increase was less than 205 CFM₅₀. Five of the 16 had a decrease in leakage, with a maximum decrease of 482 CFM₅₀ and average of 233 CFM₅₀. For the other 11 residences, 10 had an increase from 3 to 204 CFM₅₀, and the average increase was 107 CFM₅₀. This suggests that after the aerosol sealing there is little change in the house leakage through the rest of the construction process or that any impact on aerosol seals is offset by other sealing work.

The Minnesota builders who participated in the study viewed aerosol sealing as a good option for improving energy efficiency and achieving their air leakage targets, which they often set below their climate zone standard of 3.0 ACH₅₀. The California builders were less interested in the method given their state's lack of air sealing standards, but agreed that it would be a useful tool in more extreme climates and could reduce rooftop solar costs in their net zero homes. The main hurdle to using aerosol sealing that all the builders expressed was the prohibitive cost. It was not clear to them whether costs could be reduced by eliminating other sealing materials, but many

were interested in experimenting further to determine what could be replaced. Many were also confident that with sufficient incentives and subsequent product scaling they could more easily sell customers on its incorporation into their home. Another significant challenge noted by one builder was preventing moisture intrusion in increasingly airtight homes; they expressed doubts that customers can be counted on to adequately maintain their ventilation systems, which become increasingly critical to home durability as envelope breathability decreases.

The aerosol envelope sealing process produced tighter homes, in addition to demonstrating a potential opportunity for cost savings in the construction process. A review of the standard air sealing performed by builders in the United States shows several areas where air sealing can be reduced or eliminated by applying aerosol sealing. By reducing other sealing work, builders can: (1) minimize material used for sealing a building, because aerosol sealing only applies material where leaks are present; (2) reduce the possibility of redundant sealing (e.g., sealing on both external and internal wall surfaces) while assuring a continuous air barrier is applied; and (3) reduce the number of trades involved in the air sealing process.

References

- ASHRAE. 2010. *Ventilation and Acceptable Indoor Air Quality in Low-Rise Residential Buildings*. ASHRAE Standard 62.2-2010, Atlanta, GA.
- ASTM E 1186-17. 2017. *Standard Practices for Air Leakage Site Detection in Building Envelopes and Air Barrier Systems*. ASTM International, West Conshohocken, PA.
<https://www.astm.org/Standards/E1186.htm>.
- ASTM E 779-10. 2010. *Standard Test Method for Determining Air Leakage Rate by Fan Pressurization Method*. ASTM International, West Conshohocken, PA.
<https://www.astm.org/Standards/E779.htm>.
- Bohac, D.L., B. Schoenbauer, J. Fitzgerald, C. Harrington, and M. Modera. 2016. “Using an Aerosol Sealant to Reduce Multifamily Envelope Leakage.” ACEEE Summer Study Proceedings. Pacific Grove, CA.
https://www.aceee.org/files/proceedings/2016/data/papers/1_1014.pdf.
- Carrie, F.R., and M.P. Modera. 1998. “Particle Deposition in a Two-Dimensional Slot from a Transverse Stream.” *Aerosol Science and Technology*. 28:3, pg. 235-246.
<https://doi.org/10.1080/02786829808965524>.
- Chan, WR, J. Joh, and M. Sherman. 2013. “Analysis of air leakage measurements of US houses.” *Energy and Buildings*.
https://btus.lbl.gov/sites/all/files/chan_analysis_of_air_leakage.pdf.
- DOE. 2014. *Windows and Building Envelope Research and Development: Roadmap for Emerging Technologies*. Prepared by Energetics Incorporated for the U.S. Department of Energy Building Technologies Program.
https://www.energy.gov/sites/prod/files/2014/02/f8/BTO_windows_and_envelope_report_3.pdf.
- DOE. 2015. Energy Codes Field Studies/Residential/Findings.
<https://www.energycodes.gov/compliance/energy-code-field-studies>.
- DOE. 2019. DOE Zero Energy Ready Home National Program Requirements (Rev. 07),
<https://www.energy.gov/sites/prod/files/2019/04/f62/DOE%20ZERH%20Specs%20Rev07.pdf>.
- EPA ENERGY STAR. 2015. “EPA ENERGY STAR Certified Homes, Rater Design Review Checklist, Version 3/3.1 (Rev. 08).”
https://www.energystar.gov/ia/partners/bldrs_lenders_raters/downloads/rev_8/Rater%20Checklists%20v101%202015-06-26_clean_fillable_508.pdf?8255-eac0.

Harrington, C., and D. Springer. 2015. *Field Trial of an Aerosol-Based Enclosure Sealing Technology*. Alliance for Residential Building Innovation for the U.S. Department of Energy Building America Program. DOE/GO-102015-4728.

https://www1.eere.energy.gov/buildings/publications/pdfs/building_america/aerosol-based-enclosure-sealing-technology.pdf.

Harrington, C., and M. Modera. 2012. *Laboratory Testing of Aerosol for Enclosure Air Sealing*. KNDJ-0-40343-00. U.S. Department of Energy Building America Program.

<https://wcec.ucdavis.edu/wp-content/uploads/2013/06/1140-final-modeling-results-report8.pdf>.

Hendron, R. and C. Engebrecht. 2010. *Building America House Simulation Protocols*. U.S. Department of Energy Building America Program. TP-550-49426.

<https://www.nrel.gov/docs/fy11osti/49246.pdf>.

IECC 2009. *2009 International Energy Conservation Code*. Country Club Hills, IL: International Code Council, Inc.

IECC 2012. *2012 International Energy Conservation Code*. Country Club Hills, IL: International Code Council, Inc.

IECC 2015. *2015 International Energy Conservation Code*. Country Club Hills, IL: International Code Council, Inc.

IECC 2018. *2018 International Energy Conservation Code*. Country Club Hills, IL: International Code Council, Inc.

Logue, J.M., P.N., Price, M.H. Sherman, and B.C. Singer. 2012. “A Method to Estimate the Chronic Health Impact of Air Pollutants in U.S. Residences.” *Environmental Health Perspectives*, Vol. 120, Number 2. <https://ehp.niehs.nih.gov/doi/10.1289/ehp.1104035>.

Lstiburek, Joseph. 2015. “BSI-084: Forty Year of Air Barriers*—The Evolution of the Residential Air Barrier.” Building Science Corporation.

<https://www.buildingscience.com/documents/insights/bsi-084-forty-years-of-air-barriers>.

Maxwell, S., D. Berger, and C. Harrington. 2015. *Apartment Compartmentalization With an Aerosol-Based Sealing Process*. Consortium for Advanced Residential Building for the U.S. Department of Energy Building America Program.

<https://www.nrel.gov/docs/fy15osti/63665.pdf>.

Minnesota Department of Labor and Industry. 2017. Minnesota Guide to the State Building Code. http://www.dli.mn.gov/sites/default/files/pdf/guide_to_code.pdf.

Modera, M., and C. Harrington. 2018. *Automated Aerosol-Sealing of Building Envelopes*. Environmental Security Technology Certification Program, Project EW-201511. U.S. Department of Defense. Alexandria, VA. <https://apps.dtic.mil/sti/pdfs/AD1059510.pdf>.

Modera, M., D. Dickerhoff, O. Nilssen, H. Duquette, and J. Geyselaers. 1996. “Residential Field Testing of an Aerosol-Based Technology for Sealing Ductwork.” ACEEE Summer Study Proceedings. Pacific Grove, CA. https://www.aceee.org/files/proceedings/1996/data/papers/SS96_Panel1_Paper17.pdf.

Passive House Institute. 2016. “Passive House requirements.” http://passiv.de/en/02_informations/02_passive-house-requirements/02_passive-house-requirements.htm.

RESNET/ICC 380. 2016. *Procedure for Measuring Air Tightness of Building Enclosure*. <https://codes.iccsafe.org/content/chapter/15275/>.

Straube, J, 2007. “BSD-014: Air Flow Control in Buildings.” Building Science Corporation. <https://www.buildingscience.com/documents/digests/bsd-014-air-flow-control-in-buildings>.

Xcel. 2019. “Energy Efficient New Home Construction.” https://www.xcelenergy.com/programs_and_rebates/residential_programs_and_rebates/home_energy_efficiency/efficient_new_home_construction.

Appendix A. Builder Interview Script and Questions

Introduction: We are wrapping up our DOE Building America project on aerosol envelope sealing for new homes. We want your feedback about the aerosol envelope sealing process. It's important for us to get the perspective of the builders who might be using this service. We are interested in what you see as the advantages and disadvantages about the process and how you would see it being incorporated into your construction process. I have about 10 questions that I'm hoping will provide a useful discussion about aerosol envelope sealing. I expect this will take about 20 to 30 minutes.

Key study results: Before we get started, I wanted to share some of the key findings from our project. We sealed a total of 27 houses for 2 builders in California and 7 builders in Minnesota and Illinois. Overall, the sealing was very successful. There was typically a 70% to 80% reduction in house leakage, and the houses ended up well below code-required tightness levels.

California: For the 6 unvented attic houses in California, the sealing reduced leakage by an average of 80% and got them about 70% below their leakage target of 5.0 ACH₅₀. The aerosol sealing allows the houses to get tight enough without the need for spray foam under the roof deck so that other types of insulation can be used. For the 5 vented attic houses, the sealing reduced leakage by 70% and got them about 42% below target. The unvented attic houses were sealed near the beginning of construction and the vented attic houses toward the end.

Minnesota: For the 7 houses we sealed for the first Minnesota builder we had an average leakage reduction of almost 75%, and the houses ended up a little over 70% tighter than the 3.0 ACH₅₀ code requirement. All of those houses were sealed before wall insulation and drywall. For the houses for the other 6 builders, the average reduction was 75% and the houses ended up being 77% tighter than code. Half the houses met the 0.6 ACH₅₀ Passive House tightness requirement and only 1 house was above 1.0 ACH₅₀. Almost all of the houses were sealed before wall insulation and drywall, but at couple were sealed at the end of construction.

1. What is the typical range of leakage for your houses? Do you have a target leakage? What would be the biggest challenges in using aerosol for your houses? (cost, scheduling)
2. What would be the most significant benefits in using aerosol for your houses? (reliable leakage, reduced leakage, reduced QC, tighter houses, increased utility efficiency incentives, selling point for buyers, reduced call-backs, ability to pass blower door air leakage requirement)
3. At what point of the construction process would it make most sense for you to use aerosol? (Try to be specific. List of typical construction steps. If they don't have a clear idea of when during construction they would want to apply aerosol, ask if they would expect to do the sealing before or after these steps [or if it doesn't matter or they don't know]: (a) can foam sealing of wire/plumbing penetrations, (b) caulk gaps between studs

and base plate/subfloor, (c) rim joist spray foam, (d) wall insulation, (e) drywall, (f) trim work)

4. What current air sealing do you think you could eliminate if you were using aerosol sealing? (airtight electric boxes, poly on exterior walls, open-cell foam, caulking [type of locations], can foam [type of locations])
5. We are interested in the possible cost savings for eliminating some of these current sealing methods. Is it possible for you to make an estimate of the cost savings? If so, could you provide that to us? (consider man hours, material, etc.)
6. Are there certain types of houses or construction where you think aerosol will be a better application? (slab-on-grade, townhouses, complicated framing, etc.)
7. Are there other housing types or parts of the country where you think aerosol will have more impact?
8. What would it take for you to incorporate aerosol sealing into your construction process?
9. Do you currently use energy-efficient homes and/or insulation and air sealing as a marketing tool? Now that you have witnessed the process and effectiveness of aerosol, could you use it as a future marketing tool?
10. What information or sales material would be beneficial to show home buyers the benefits of aerosol? (cost savings calculator, pamphlets, real-world results, installation video)
11. Compared to other builders, are you currently using home comfort as a talking point with potential home buyers and/or energy cost savings as an advantage with your homes over other builders?
12. Do you typically receive utility energy efficiency incentives for your houses? If so, do you think that consistently getting your houses to 0.5 to 1.0 ACH₅₀ with aerosol would get you a higher incentive and, if so, how much more? If not, would you be more likely to pursue getting incentives if you were using aerosol sealing?

Appendix B. Code Requirements for Vapor Retarders and Air Barriers

Vapor Retarder and Air Barriers: What's the Difference?

Moisture, in vapor form, can pass through the building assembly in two distinct ways:

1. **Vapor diffusion.** The rate of movement by diffusion is determined by the vapor gradient and permeability of the materials. A vapor retarder is intended to retard diffusion.
2. **Air movement.** Also known as convective mass transport, this is when the vapor within an air mass is carried through the building assembly by airflow. The rate of flow is determined by the leakage characteristic (i.e., restriction to air movement) and the air pressure gradient.

Vapor retarders are not called “vapor barriers” for a reason. Vapor retarders only need to limit the amount of moisture diffusion through the wall or other building assembly where they are used. However, water vapor diffusion is often an insignificant source of envelope moisture transport (Straube 2007).

Moisture condensation from winter exfiltrating air and summer infiltrating air through air leaks in wall and other envelope cavities is one of the two major sources of moisture in above-grade enclosures (rain is the other). An air barrier is intended to limit air leakage that could also transport vapor via convection into the building assembly. An effective building assembly must be designed to limit air leaks through the assembly and properly control vapor diffusion. This combined impact of air movement (e.g., convection) and diffusion is a critical distinction in the design of durable wall assemblies.

Air barriers can be located at the exterior or interior surface of the envelope cavity—or both. Either location will control the movement of air through cavity insulation systems. However, an exterior air barrier will stop the wind-washing of outdoor air through the cavity. An interior air barrier will control the movement of air into the cavity—if there is a driving force to move indoor air into the cavity and back to the indoors.

The location of the air barrier produced by aerosol sealing will depend on when during construction the sealing is applied. When aerosol sealing is done prior to wall insulation and drywall, the air barrier will be produced at the exterior surface. Generally, the aerosol sealant will seal gaps at the exterior sheathing. These gaps may occur between the sheathing and framing, penetrations through the sheathing and framing, and gaps between framing. When aerosol sealing is done after drywall, the air barrier is created at the interior drywall. There are many products that can serve as a vapor retarder, an air barrier, or both depending on their properties.

Code Requirements for Vapor Retarders

Chapter 7 (Wall Covering), Section R702 (Interior Wall Covering) of the 2015 Minnesota Building Code contains provisions for the use of vapor retarders for moisture control in above-grade walls. The air barrier and vapor retarder requirements for below-grade walls are different from those for above-grade walls. Aerosol sealing is not likely to impact the design and implementation of the below-grade portion of the house and are not addressed here. The following are the relevant sections for above-grade walls:

Code Definitions

Vapor Retarder Class. A measure of the ability of a material or assembly to limit the amount of moisture that passes through that material or assembly. Vapor retarder class shall be defined using the desiccant method with Procedure A of ASTM E 96 as follows:

Class I: Permeance level of 0.1 perm or less

Class II: Permeance level between 0.1 perm and 1.0 perm

Class III: Permeance level between 1.0 perm and 10 perms

Code Sections

R702.7 Vapor retarders. A Class I or II vapor retarder is required on the interior side of frame walls in Climate Zones 6 and 7. Class II vapor retarders are permitted only when specified on the construction documents.

R702.7.1 Class III vapor retarders. Class III vapor retarders shall be permitted where any one of the conditions in Table R702.7.1 is met.

Table 16. Table R702.7.1: Class III Vapor Retarders Permitted For the Following

Climate Zone	Class III Vapor Retarders Permitted For:*
Marine 4	Vented cladding over wood structural panels. Vented cladding over fiberboard. Vented cladding over gypsum. Insulated sheathing with R-value ≥ 2.5 over 2×4 wall. Insulated sheathing with R-value ≥ 3.75 over 2×6 wall.
5	Vented cladding over wood structural panels. Vented cladding over fiberboard. Vented cladding over gypsum. Insulated sheathing with R-value ≥ 5 over 2×4 wall. Insulated sheathing with R-value ≥ 7.5 over 2×6 wall.
6	Vented cladding over fiberboard. Vented cladding over gypsum. Insulated sheathing with R-value ≥ 7.5 over 2×4 wall. Insulated sheathing with R-value ≥ 11.25 over 2×6 wall.
7 and 8	Insulated sheathing with R-value ≥ 10 over 2×4 wall. Insulated sheathing with R-value ≥ 15 over 2×6 wall.

*Spray foam with a minimum density of 2 lb/ft³ applied to the interior cavity side of wood structural panels, fiberboard, insulating sheathing or gypsum is deemed to meet the insulating sheathing requirement where the spray foam R-value meets or exceeds the specified insulating sheathing R-value.

R702.7.2 Material vapor retarder class. The vapor retarder class shall be based on the manufacturer’s certified testing or a tested assembly.

The following shall be deemed to meet the class specified:

Class I: Sheet polyethylene, unperforated aluminum foil.

Class II: Kraft-faced fiberglass batts.

Class III: Latex or enamel paint.

Code Requirements for Air Barriers

Chapter 4 (Residential Energy Efficiency), Section R402 (Building Thermal Envelope) of the 2015 Minnesota Residential Energy Code contains provisions to limit air leakage in the building thermal envelope. Following are the relevant sections:

Code Definitions

AIR BARRIER. Material(s) assembled and joined together to provide a barrier to air leakage through the building envelope. An air barrier may be a single material or a combination of materials.

CONTINUOUS AIR BARRIER. A combination of materials and assemblies that restrict or prevent the passage of air through the building thermal envelope.

Code Sections

R402.4 Air leakage (Mandatory). The building thermal envelope shall be constructed to limit air leakage in accordance with the requirements of Sections R402.4.1 through R402.4.4.

R402.4.1 Building thermal envelope. The building thermal envelope shall comply with Sections R402.4.1.1 and R402.4.1.2. The sealing methods between dissimilar materials shall allow for differential expansion and contraction.

The building thermal envelope must be constructed to limit air leakage.

Table 17. Table R402.4.1.1: Air Barrier and Insulation Installation Criteria

Component	Criteria
Air barrier and thermal barrier	A continuous air barrier shall be installed in the building envelope. Exterior thermal envelope contains a continuous air barrier. Breaks or joints in the air barrier shall be sealed. Air-permeable insulation shall not be used as a sealing material.
Ceiling/attic	The air barrier in any dropped ceiling/soffit shall be aligned with the insulation and any gaps in the air barrier sealed. Access openings, drop down stair or knee wall doors to unconditioned attic spaces shall be sealed.
Walls	Corners and headers shall be insulated, and the junction of the foundation and sill plate shall be sealed. The junction of the top plate and top of exterior walls shall be sealed. Exterior thermal envelope insulation for framed walls shall be installed in substantial contact and continuous alignment with the air barrier. Knee walls shall be sealed.
Windows, skylights, and doors	The space between window/door jambs and framing and skylights and framing shall be sealed.
Rim joists	Rim joists shall be insulated and include the air barrier.
Floors (including above-garage and cantilevered floors)	Insulation shall be installed to maintain permanent contact with underside of subfloor decking. The air barrier shall be installed at any exposed edge of insulation.
Crawl space walls	Where provided in lieu of floor insulation, insulation shall be permanently attached to the crawlspace walls. Exposed earth in unvented crawl spaces shall be covered with a Class I vapor retarder with overlapping joints taped.
Shafts, penetrations	Duct shafts, utility penetrations, and flue shafts opening to exterior or unconditioned space shall be sealed.
Narrow cavities	Batts in narrow cavities shall be cut to fit, or narrow cavities shall be filled by insulation that on installation readily conforms to the available cavity space.
Garage separation	Air sealing shall be provided between the garage and conditioned spaces.
Recessed lighting	Recessed light fixtures installed in the building thermal envelope shall be airtight, IC rated, and sealed to the drywall.
Plumbing and wiring	Batt insulation shall be cut neatly to fit around wiring and plumbing in exterior walls, or insulation that on installation readily conforms to available space shall extend behind piping and wiring.
Shower/tub on exterior wall	Exterior walls adjacent to showers and tubs shall be insulated and the air barrier installed separating them from the showers and tubs.
Electrical/phone box on exterior walls	The air barrier shall be installed behind electrical or communication boxes or air sealed boxes shall be installed.
HVAC register boots	HVAC register boots that penetrate building thermal envelope shall be sealed to the subfloor or drywall.
Fireplace	An air barrier shall be installed on fireplace walls. Fireplaces shall have gasketed doors.

Minnesota Code Analysis:

Vapor retarders and air barriers provide separate and distinct functions

- a. Vapor retarders can be either:
 - i. Class I in all cases
 - ii. Class II when specified on the construction documents, or
 - iii. Class III when one of the conditions in Table R702.7.1 is met
- b. Vapor retarders are required on the interior side of framed walls
- c. Vapor retarders are NOT required to be continuous
- d. Vapor retarders are NOT required to be sealed
- e. Air barriers can be a combination of materials
- f. Air barriers must be continuous
- g. Air barriers must be sealed
- h. Air barriers are NOT required to be on the interior side of framed walls
- i. Air sealing details must be included with the construction documents [1322.0103].

Appendix C. Air Sealing Assessment Tables

On-site visual inspections were used to qualitatively assess the envelope air barrier of recently completed houses. A checklist of common leakage sites was used to guide the inspection process and provide structure to the results. The inspections provided information about the quality of sealing work (excellent, acceptable, poor, no attempt), who performed the sealing, what material was used, and the potential for aerosol sealing to replace current methods. The following tables show information collected for the participating builders.

Table 18. California: Air Unvented Attics With Spray Foam Insulation

Category	Component	Who Does Sealing?	Material Used for Sealing?	Can AeroBarrier Replace?	Quality of Seal Work
Ceiling/Attic	Attic access panels	N/A	Gasketed door	No	Excellent
	Drop down stairs	N/A	N/A	N/A	N/A
	Whole-house fans	N/A	N/A	N/A	N/A
	Recessed lighting fixtures	N/A	Gasketed fixture	Yes	Excellent
	Drop ceiling/soffit	Insulation contractor	Closed-cell spray foam	Yes	Excellent
Walls	Exterior walls	Insulation contractor	Gasket/OSB	N/A	Excellent
	Sill plate	Carpentry contractor	Gasket/OSB	Yes	Acceptable
	Top plate	Insulation contractor	Gasket	Yes	Acceptable
	Drywall to top plate	Insulation contractor	Gasket	Yes	Excellent
	Interior partition wall to exterior wall	Carpentry contractor/ insulation contractor	Solid blocking/ Can foam	Yes	Excellent
	Knee walls	Carpentry contractor	OSB	N/A	Excellent
Windows, Skylights, and Doors	Rough openings	Insulation contractor	Can foam	Yes	Excellent
Rim Joists		Insulation contractor	Open-cell spray foam	Yes	Excellent
Shafts, Penetrations to Unconditioned Spaces	Ducts	Insulation contractor	Can foam/ open-cell spray foam	No	Excellent
	Flues	Insulation contractor	Can foam/ open-cell spray foam	No	Excellent
	Shafts	Insulation contractor	Can foam/ open-cell spray foam	No	Excellent
	Plumbing	Insulation contractor	Can foam/ open-cell spray foam	Yes	Excellent
	Piping	Insulation contractor	Can foam/ open-cell spray foam	Yes	Excellent
	Wiring	Insulation contractor	Can foam/ open-cell spray foam	Yes	Excellent
	Exhaust fans	Insulation contractor	Can foam/ open-cell spray foam	Yes	Excellent
	Other	N/A	N/A	N/A	N/A
Garage Separation Walls	Floor cavities aligned with garage separation walls	Carpentry contractor/ insulation contractor	Blocking/ open-cell spray foam	No	Excellent
Other	Shower/tub on exterior wall	Carpentry contractor/ insulation contractor	OSB/ open-cell spray foam	Yes	Excellent
	Stair stringer on exterior wall	N/A	None	Yes	N/A
	Fireplace on exterior wall	N/A	N/A	N/A	N/A
	Electrical/low-voltage boxes on exterior walls	Insulation contractor	Can foam/ open-cell spray foam	Yes	Excellent
	HVAC register boots that penetrate building thermal envelope	Insulation contractor	Open-cell spray foam	Yes	N/A

Table 19. California: Air Unvented Attics With Netted Insulation

Category	Component	Who Does Sealing?	Material Used for Sealing?	Can AeroBarrier Replace?	Quality of Seal Work
Ceiling/Attic	Attic access panels	Insulation contractor	Gasketed door	No	Excellent
	Drop down stairs	N/A	N/A	N/A	N/A
	Whole-house fans	N/A	N/A	N/A	N/A
	Recessed lighting fixtures	Insulation contractor	Gasketed fixture	Yes	Excellent
	Drop ceiling/soffit	Insulation contractor	Drywall	Yes	Excellent
Walls	Exterior walls	Insulation contractor	Gasket/foam board	N/A	Excellent
	Sill plate	Insulation contractor	Gasket/caulk	Yes	Acceptable
	Top plate	Insulation contractor	Gasket	Yes	Acceptable
	Drywall to top plate	Insulation contractor	Gasket	Yes	Excellent
	Interior partition wall to exterior wall	Insulation contractor	Gasket	Yes	Excellent
	Knee walls	Insulation contractor	Six-sided sealed/fiberboard/Tyvek	Yes	Excellent
Windows, Skylights, and Doors	Rough openings	Insulation contractor	Can foam	Yes	Excellent
Rim Joists		Insulation contractor	Can foam	Yes	Excellent
Shafts, Penetrations to Unconditioned Spaces	Ducts	Insulation contractor	Can foam	No	Excellent
	Flues	Insulation contractor	Can foam	No	Excellent
	Shafts	Insulation contractor	Can foam	No	Excellent
	Plumbing	Insulation contractor	Can foam	No	Excellent
	Piping	Insulation contractor	Can foam	No	Excellent
	Wiring	Insulation contractor	Can foam	No	Excellent
	Exhaust fans	Insulation contractor	Gasket/butyl tape	Yes	Excellent
	Other	N/A	N/A	N/A	N/A
Garage Separation Walls	Floor cavities aligned with garage separation walls	Drywall/insulation contractor	Drywall/gasket	No	Excellent
Other	Shower/tub on exterior wall	Carpentry contractor/insulation contractor	OSB/foam	Yes	Excellent
	Stair stringer on exterior wall	Carpentry contractor/insulation contractor	Gasket	Yes	N/A
	Fireplace on exterior wall	Carpentry contractor/insulation contractor	Six-sided box	No	Acceptable
	Electrical/low-voltage boxes on exterior walls	Insulation contractor	Quick flash	Yes	Excellent
	HVAC register boots that penetrate building thermal envelope	Insulation contractor	Sealed to sheetrock w/ butyl tape	Yes	N/A

Table 20. California: Vented Attics

Category	Component	Who Does Sealing?	Material Used for Sealing?	Can AeroBarrier Replace?	Quality of Seal Work
Ceiling/Attic	Attic access panels		Gasketed door	No	Excellent
	Drop down stairs	N/A	N/A	N/A	N/A
	Whole-house fans	N/A	N/A	N/A	N/A
	Recessed lighting fixtures	N/A	Gasketed fixture	Yes	Excellent
	Drop ceiling/soffit	Insulation contractor	Closed-cell spray foam	Yes	Excellent
Walls	Exterior walls	Insulation contractor	Gasket/OSB	N/A	Excellent
	Sill plate	Carpentry contractor	Gasket/OSB	Yes	Acceptable
	Top plate	Insulation contractor	Gasket	Yes	Acceptable
	Drywall to top plate	Insulation contractor	Gasket	Yes	Excellent
	Interior partition wall to exterior wall	Carpentry contractor/ insulation contractor	Solid blocking/can foam	Yes	Excellent
	Knee walls	Carpentry contractor	OSB	No	Excellent
Windows, Skylights, and Doors	Rough openings	Insulation contractor	Can foam	Yes	Excellent
Rim Joists		Insulation contractor	Can foam	Yes	Excellent
Shafts, Penetrations to Unconditioned Spaces	Ducts	Insulation contractor	Can foam	No	Excellent
	Flues	Insulation contractor	Can foam	No	Excellent
	Shafts	Insulation contractor	Can foam	No	Excellent
	Plumbing	Insulation contractor	Can foam	Yes	Excellent
	Piping	Insulation contractor	Can foam	Yes	Excellent
	Wiring	Insulation contractor	Can foam	Yes	Excellent
	Exhaust fans	Insulation contractor	Can foam	Yes	Excellent
	Other				N/A
Garage Separation Walls	Floor cavities aligned with garage separation walls	Carpentry contractor/ insulation contractor	Blocking/can foam	No	Excellent
Other	Shower/tub on exterior wall	Carpentry contractor/ insulation contractor	OSB/can foam	Yes	Excellent
	Stair stringer on exterior wall	N/A	None	Yes	N/A
	Fireplace on exterior wall	N/A	N/A	N/A	N/A
	Electrical/low-voltage boxes on exterior walls	Insulation contractor	Can foam	Yes	Excellent
	HVAC register boots that penetrate building thermal envelope	Insulation contractor	Can foam	Yes	N/A

Table 21. First Minnesota Builder (#3)

Category	Component	Who Does Sealing?	Material Used for Sealing?	Can AeroBarrier Replace?	Quality of Seal Work
Ceiling/Attic	Attic access panels	Drywall contractor	Ceiling texture coat	No	Poor
	Drop down stairs	N/A	N/A	N/A	N/A
	Whole-house fans	N/A	N/A	N/A	N/A
	Recessed lighting fixtures	Insulation contractor/ electrician	Polyethylene sheet/ gasketed fixture	Yes	Excellent
	Drop ceiling/soffit	N/A	N/A	N/A	N/A
Walls	Exterior walls	Insulation contractor	Polyethylene sheet	N/A	Excellent
	Sill plate	Carpentry contractor	Sill seal/caulk	Yes	Acceptable
	Top plate	Insulation contractor	Polyethylene sheet/ caulk	Yes	Acceptable
	Drywall to top plate	N/A			N/A
	Interior partition wall to exterior wall	Carpentry contractor	Polyethylene sheet/ caulk	Yes	Excellent
	Knee walls	N/A	N/A	N/A	N/A
Windows, Skylights, and Doors	Rough openings	Insulation contractor	Can foam	Yes	Excellent
Rim Joists		Insulation contractor	Closed-cell spray foam	Yes	Excellent
Shafts, Penetrations to Unconditioned Spaces	Ducts	Insulation contractor	Can foam	No	Excellent
	Flues	Insulation contractor	Can foam	No	Excellent
	Shafts	Insulation contractor	Can foam	No	Excellent
	Plumbing	Insulation contractor	Can foam	Yes	Excellent
	Piping	Insulation contractor	Can foam	Yes	Excellent
	Wiring	Insulation contractor	Can foam	Yes	Excellent
	Exhaust fans	Insulation contractor	Can foam	No	Excellent
	Other				
Garage Separation Walls	Floor cavities aligned with garage separation walls	Carpentry contractor/ insulation contractor	OSB/closed-cell spray foam	No	Excellent
Other	Shower/tub on exterior wall	Carpentry contractor	OSB/polyethylene sheet	Yes	Excellent
	Stair stringer on exterior wall	Carpentry contractor	Polyethylene sheet	Yes	Excellent
	Fireplace on exterior wall	Carpentry contractor	OSB/polyethylene sheet	No	Excellent
	Electrical/low-voltage boxes on exterior walls	Insulation contractor/ electrician	Polyethylene sheet/ caulk/casketed boxes	Yes	Excellent
	HVAC register boots that penetrate building thermal envelope	Insulation contractor	Can foam	Yes	Excellent

Table 22. Second Minnesota Builder (#4)

Category	Component	Who Does Sealing?	Material Used for Sealing?	Can AeroBarrier Replace?	Quality of Seal Work
Ceiling/Attic	Attic access panels	Drywall contractor	Ceiling texture coat	No	Poor
	Drop down stairs	N/A	N/A	N/A	N/A
	Whole-house fans	N/A	N/A	N/A	N/A
	Recessed lighting fixtures	Insulation contractor/ electrician	Polyethylene sheet/ gasketed fixture	Yes	Excellent
	Drop ceiling/soffit	N/A		Yes	Excellent
Walls	Exterior walls	Insulation contractor	Polyethylene sheet	N/A	Excellent
	Sill plate	Carpentry contractor	Sill seal/caulk	Yes	Acceptable
	Top plate	Insulation contractor	Polyethylene sheet/ caulk	Yes	Acceptable
	Drywall to top plate	N/A	N/A	N/A	N/A
	Interior partition wall to exterior wall	Carpentry contractor	Polyethylene sheet/ caulk	Yes	Excellent
Knee walls	Insulation contractor	Polyethylene sheet/ caulk	N/A	N/A	
Windows, Skylights, and Doors	Rough openings	Window installation contractor	Can foam	Yes	Excellent
Rim Joists		Insulation contractor	Can foam	Yes	Excellent
Shafts, Penetrations to Unconditioned Spaces	Ducts	Insulation contractor	Can foam	No	Excellent
	Flues	Insulation contractor	Can foam	No	Excellent
	Shafts	Insulation contractor	Can foam	No	Excellent
	Plumbing	Insulation contractor	Can foam	Yes	Excellent
	Piping	Insulation contractor	Can foam	Yes	Excellent
	Wiring	Insulation contractor	Can foam	Yes	Excellent
	Exhaust fans	Insulation contractor	Polyethylene sheet/ caulk	No	Excellent
	Other				
Garage Separation Walls	Floor cavities aligned with garage separation walls	Carpentry contractor/ insulation contractor	OSB/closed-cell spray foam	No	Excellent
Other	Shower/tub on exterior wall	Carpentry contractor	OSB/polyethylene sheet	Yes	Excellent
	Stair stringer on exterior wall	Carpentry contractor	Polyethylene sheet	Yes	Excellent
	Fireplace on exterior wall	Carpentry contractor	OSB/polyethylene sheet	No	Excellent
	Electrical/low-voltage boxes on exterior walls	Insulation contractor/ electrician	Polyethylene sheet/ caulk/casketed boxes/can foam at wire penetrations	Yes	Excellent
	HVAC register boots that penetrate building thermal envelope	N/A	N/A	N/A	N/A

Appendix D. Content for the Building America Solution Center

This appendix includes information from the forthcoming Air Sealing the Envelope with Aerosol Sealant Guide that will be published in the [Building America Solution Center](#).

Guide Title: Air Sealing the Envelope with Aerosol Sealant

Taxonomy Number: TE 5.2.8

Keywords: Air sealing, air barriers, openings, testing

Climate Zone: All climate zones

Construction Type: New construction

One-Liner: Guide describing aerosol method to seal air leakage in new home envelopes.

Authors: Center for Energy and Environment, David Bohac, dbohac@mncee.org

UC Davis/Western Cooling Efficiency Center (WCEC), Curtis Harrington, csharrington@ucdavis.edu

Scope

Using an aerosol sealing technology to seal new homes during the construction process.

- Choose the stage of construction to apply the sealing. The process can be applied at any point after the primary air barrier is in place. For example, the sealing can be conducted early in construction for homes with sealed attics or vented attic homes that use poly sheeting or drywall on the ceiling. The sealing will be done late in construction for vented attic houses that install the drywall on the ceiling at the same time as it is installed on the rest of the house.
- For best performance, large gaps (more than 0.5-in. across) should be sealed prior to installing.
- Temporarily seal all designed openings in the house exterior that are not intended to remain open (e.g., exhaust fan ducts, ventilation system ducts, combustion air ducts, and doors leading to outside).
- Temporarily cover finished floors and other finished horizontal surfaces.
- Evacuate the building before sealing.
- Place aerosol sealant sprayers throughout the house to achieve a uniform sealant “fog.”
- Use a blower in an exterior door to pressurize the house and force the air/sealant fog through leaks in the envelope. The sealant will attach to the edges of the leaks and fill the gaps over the 30- to 120-minute sealing period.

- Seal building to target air leakage. Consider future work on building and possibly seal 10%–20% tighter than target leakage.
 - If goal is to seal as tight as possible, seal until sealing rate drops below about 5 CFM₅₀/min.
- Remove equipment and temporary coverings. Clean any unwanted sealant deposition from surfaces.
- Allow building to air out for 30 minutes before allowing others into the space.

See the Compliance section for related codes and standards, and criteria to meet national programs such as ENERGY STAR and DOE’s Zero Energy Ready Home program.

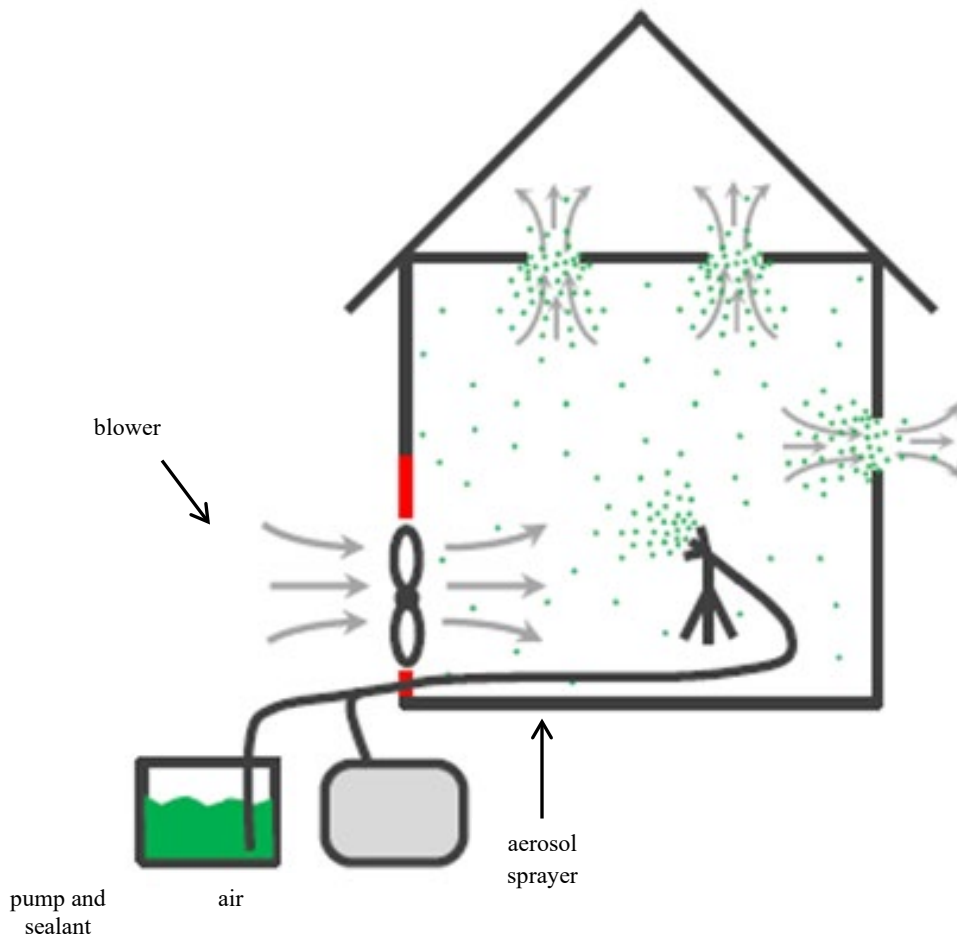

Figure 63. Aerosol sealing process

Description

In many parts of the United States, house envelopes are notoriously leaky, with unintended flows between conditioned and unconditioned spaces that result in additional space heating and cooling equipment loads. Although voluntary codes and standards for envelope tightness have existed for decades, only recently have these codes included mandatory envelope leakage requirements with verification by performance testing. Current state-of-the-art methods for envelope air sealing rely on contractor personnel to identify and manually seal typical leakage locations. The achieved airtightness levels can be highly variable and are based on the time allotted, accessibility of leaks, as well as the vigilance and experience of the contractor who performs the work.

The aerosol envelope sealing technology uses an automated method to satisfy the envelope sealing requirement. The process involves pressurizing the building for an hour or two while applying an aerosol sealant “fog” to the building interior (see Figure 64). As air escapes the building through leaks in the envelope, the sealant particles are carried to the leaks where they impact and stick, sealing the leaks (see Figure 65). A calibrated blower is used to facilitate the sealing process, and provide real-time feedback and a permanent record of the sealing. The technology is thus capable of simultaneously measuring, locating, and sealing leaks in a building automatically.



Figure 64. Aerosol fog from spray head

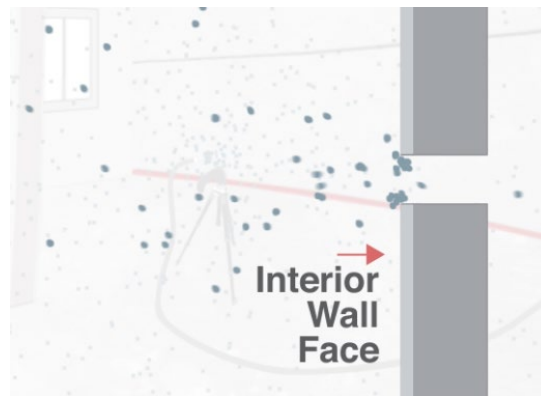

Figure 65. Aerosol sealant build-up on edge of leak



Figure 66. Blower door, sealant pump, and sealant setup in attached garage

All locations not intended to be sealed should be temporarily blocked during the sealing process. In addition, finished horizontal surfaces that cannot have sealant deposition should be covered. In general, for new construction the sealing can be performed before there are finished surfaces in the home that would need covering other than window tracks and weep holes. Figure 67, Figure 68, and Figure 69 display typical temporary seals. The sealant is cleanable from many surfaces.

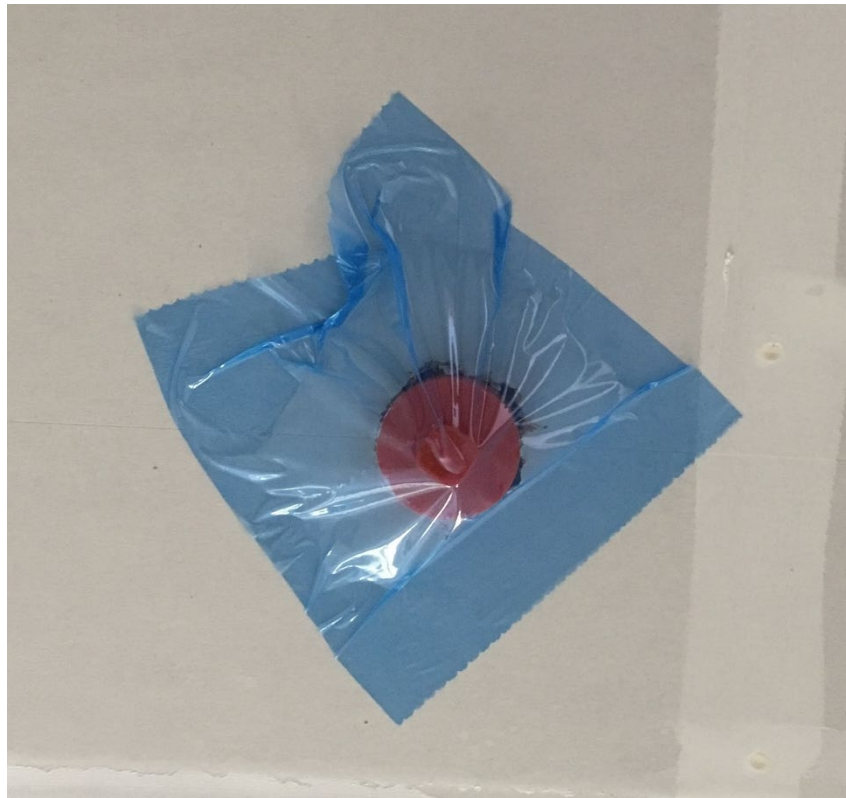

Figure 67. Temporary cover over sprinkler head



Figure 68. Temporary cover over open plumbing pipes



Figure 69. Temporary cover over tub and plumbing fixture

The advantages of the aerosol sealing process are that:

- The sealant fog finds its way to the leaks automatically. It is not necessary to manually locate the leaks, which takes the guesswork out of where to seal.
- Leaks are sealed simultaneously over 1 to 2 hours.
- The aerosol seals are highly effective. When large gaps are pre-sealed prior to aerosol sealing, a house leakage below 0.5 to 1.0 ACH₅₀ can be achieved on a consistent basis.
- The system measures leakage in real time, allowing the installer to ensure the target leakage is met.
- The tedious process of caulking, foaming, and/or taping gaps that can be challenging to quality control is replaced with a more productive, automated method.
- Less material is used because sealant is only deposited on leaks, not the entire structure.

Figure 70 through Figure 75 provide examples of typical seals produced by the aerosol sealing method.



Figure 70. Seal (gray material) formed between gap in foam



Figure 71. Seal around electric box on exterior wall

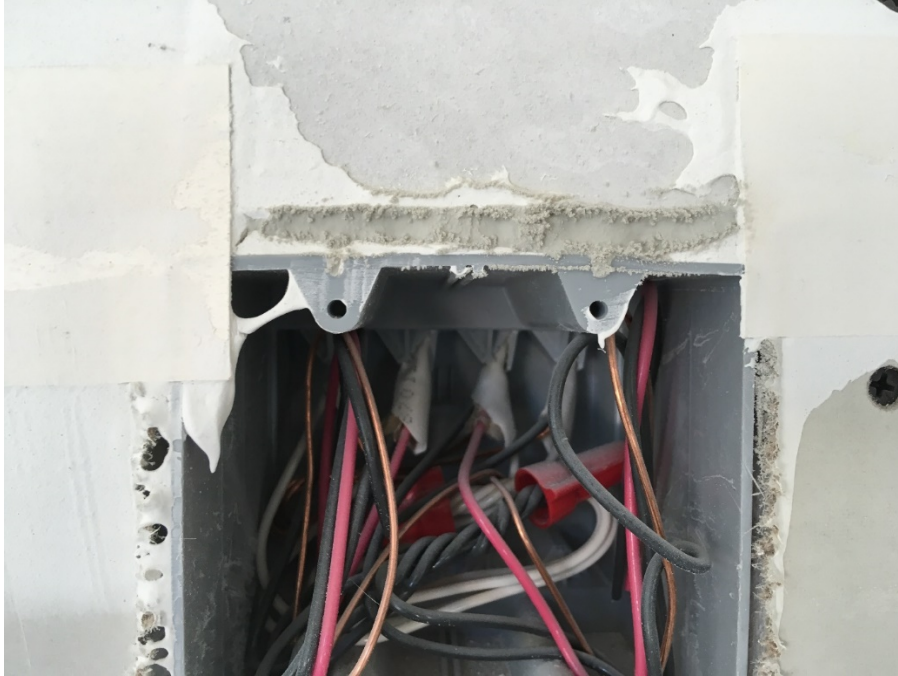

Figure 72. Seal between electrical box and drywall; the seal on the sides of the box is made further back in the crevice and not visible on the surface



Figure 73. Seal between plumbing penetration and drywall



Figure 74. Seal gap between framing



Figure 75. Seal between sheathing and framing

Ensuring Success

Visual Inspection

Visually inspect envelope penetrations and transitions to identify gaps wider than about 0.5 in. that need to be manually sealed prior to the aerosol sealing. It is best to work with the builder to identify common locations for large gaps in the envelope and have them seal the gaps. In general, larger gaps missed during the inspection do not pose significant issues, but rather result in longer sealing times, increased sealant material use, and higher leakage when aerosol sealing is complete.

Protect Finished Horizontal Surfaces

The sealing process can leave a small amount of sealant on horizontal surfaces. Finished horizontal surfaces need to be covered with poly sheets or other protection prior to sealing.

Install at Earliest Opportunity

In general, the earlier in the construction process that the aerosol sealing process can be applied the better (e.g., after first coat of mud on drywall but before texture and paint). Installing earlier in the construction process leads to reduced prep time and clean up. Aerosol sealing can be complete as soon as the home can be pressurized. For conditioned attics this means application can occur at rough-in. For vented attics, the application would occur after the first coat of mud on the drywall, unless drywall or poly sheeting is installed on the ceiling of the top floor.

Temporary Seal Envelope Openings

Temporarily seal designed opening in the envelope that are not intended to be sealed. This includes dryer vents, exhaust fan vents, combustion air ducts, ventilation system ducts, and dry plumbing traps or waste lines. You should also seal window weep holes so that they do not become plugged.

Air Out House After Sealing

Once sealing is complete and a post-seal test has been performed, open as many windows as possible to help disperse the fog of sealant. It is best to start with the windows furthest from the blower door fan location, keeping a minimum positive pressure of 50 Pa until all windows are open. Then increase the fan airflow to maximum speed for at least 30 minutes.

Climate

Applicable to any climate. Follow manufacturer minimum temperature application requirements. For hot-humid climates applying the aerosol sealing early in construction to create the air barrier toward the exterior side of the walls may reduce wind-washing and improve durability.

Training

Right/Wrong Images:



Wrong: Envelope gaps greater than 0.5-in. wide should be sealed prior to aerosol sealing



Right: Only narrow gap remains for aerosol sealing



Wrong: Poly sheet pulled away from framing during sealing due to poor stapling and caulking



Right: Poly sheet properly stapled and caulked for aerosol sealing at early phase of construction; a high level of care is required for the poly to hold up to the high pressurization (100 Pa) that occurs during sealing



Wrong: Batt insulation installed prior to aerosol sealing at early phase of construction



Right: Wall cavities exposed to allow aerosol to seal gaps between sheathing and sill plate

Resources

Presentations

“Aerosol Sealing of Building Envelopes in New Construction”

<https://youtu.be/Uj5ndzkQ6xM>

Authors: Dave Bohac and Curtis Harrington

Organizations: Center for Energy and Environment and UC Davis/WCEC

“Auto-Sealing New Home Leaks with Aerosols”

ACEEE Summer Study 2018

https://www.mncee.org/MNCEE/media/Program-Resource/ACEEE-2018_Aerosol-Sealing-in-New-Construction_080218.pdf

Authors: Dave Bohac and Curtis Harrington

Organizations: Center for Energy and Environment and UC Davis/WCEC

Articles

“Air Sealing with AeroBarrier”

<https://www.homeenergy.org/show/article/nav/buildingenvelope/id/2278>

Authors: Dave Bohac and Curtis Harrington

Organizations: Center for Energy and Environment and UC Davis/WCEC

Videos

“Aerosol Sealing for Multifamily Applications”

<https://www.mncee.org/resources/resource-center/info-visualization/aerosol-sealing-for-multifamily-application/>

Organization: Center for Energy and Environment

Compliance

Code Compliance Brief

Aerosol Sealing Building Enclosures, Single and Multifamily Dwellings - Code Compliance Brief

<https://basc.pnnl.gov/code-compliance/aerosol-sealing-building-enclosures-single-and-multifamily-dwellings-code>.

U.S. Department of Energy Zero Energy Ready Home

The DOE Zero Energy Ready Home National Program Prescriptive Path Requirements

(<https://www.energy.gov/eere/buildings/guidelines-participating-doe-zero-energy-ready-home-program>) specify that the dwelling meets the requirements of Exhibit 2: DOE Zero Energy

Ready Home Target Home Infiltration – Detached Dwellings (ACH₅₀): 3 for climate zones 1–2, 2.5 for climate zones 3–4, 2 for climate zones 5–7, 1.5 for climate zone 8.

Infiltration – Attached Dwellings (ACH₅₀): 3 for all climate zones.

ENERGY STAR Certified Homes

The ENERGY STAR Certified Homes National Program Requirements

https://www.energystar.gov/partner_resources/residential_new/homes_prog_reqs/national_page.

National Program Requirements

The ENERGY STAR Reference Design Home is the set of efficiency features modeled to determine the ENERGY STAR ERI Target for each home pursuing certification. Therefore, while the features below are not mandatory, if they are not used then other measures will be needed to achieve the ENERGY STAR ERI Target. In addition, note that the Mandatory Requirements for All Certified Homes, Exhibit 2, contain additional requirements such as total duct leakage limits, minimum allowed insulation levels, and minimum allowed fenestration performance. Therefore, EPA recommends that partners review the documents in Exhibit 2 prior to selecting measures.

Version 3.0 - Exhibit 1 ENERGY STAR Reference Design Home. Infiltration rates modeled as follows:

- 6.0 ACH₅₀ in climate zones 1 and 2
- 5.0 ACH₅₀ in climate zones 3 and 4
- 4.0 ACH₅₀ in climate zones 5, 6, and 7
- 3.0 ACH₅₀ in climate zone 8.

Version 3.1 - Exhibit 1 ENERGY STAR Reference Design Home. Infiltration rates modeled as follows:

- 4.0 ACH₅₀ in climate zones 1 and 2
- 3.0 ACH₅₀ in climate zones 3, 4, 5, 6, 7, and 8.

Please see the [ENERGY STAR Certified Homes Implementation Timeline](#) for the program version and revision currently applicable in in your state.

The ENERGY STAR Certified New Homes National Program Requirements lists the following criteria related to envelope leakage.

National Rater Field Checklist:

4. Air Sealing (Unless otherwise noted below, “sealed” indicates the use of caulk, foam, or equivalent material)
 - 4.1 Ducts, flues, shafts, plumbing, piping, wiring, exhaust fans, and other penetrations to unconditioned space sealed, with blocking / flashing as needed.
 - 4.2 Recessed lighting fixtures adjacent to unconditioned space ICAT labeled and gasketed. Also, if in insulated ceiling without attic above, exterior surface of fixture insulated to \geq R-10 in climate zones 4–8.
 - 4.3 Above-grade sill plates adjacent to conditioned space sealed to foundation or sub-floor. Gasket also placed beneath above-grade sill plate if resting atop concrete / masonry and adjacent to cond. space.^{1,2}
 - 4.4 Continuous top plate or blocking is at top of walls adjoining unconditioned space, and sealed.
 - 4.5 Drywall sealed to top plate at all unconditioned attic / wall interfaces using caulk, foam, drywall adhesive (but not other construction adhesives), or equivalent material. Either apply sealant directly between drywall and top plate or to the seam between the two from the attic above.
 - 4.6 Rough opening around windows and exterior doors sealed.³

4.7 Walls that separate attached garages from occupiable space sealed and, also, an air barrier installed and sealed at floor cavities aligned with these walls.

4.8 In multifamily buildings, the gap between the common wall (e.g. the drywall shaft wall) and the structural framing between units sealed at all exterior boundaries.

4.9 Doors adjacent to unconditioned space (e.g., attics, garages, basements) or ambient conditions made substantially airtight with weatherstripping or equivalent gasket.

4.10 Attic access panels, drop-down stairs, and whole-house fans equipped with durable $\geq R-10$ cover that is gasketed (i.e., not caulked). Fan covers either installed on house side or mechanically operated.⁴

ENERGY STAR Notes

¹ Existing sill plates (e.g., in a home undergoing a gut rehabilitation) on the interior side of structural masonry or monolithic walls are exempt from this Item. In addition, other existing sill plates resting atop concrete or masonry and adjacent to conditioned space are permitted, in lieu of using a gasket, to be sealed with caulk, foam, or equivalent material at both the interior seam between the sill plate and the subfloor and the seam between the top of the sill plate and the sheathing.

² In climate zones 1 through 3, a continuous stucco cladding system adjacent to sill and bottom plates is permitted to be used in lieu of sealing plates to foundation or sub-floor with caulk, foam, or equivalent material.

³ In climate zones 1 through 3, a continuous stucco cladding system sealed to windows and doors is permitted to be used in lieu of sealing rough openings with caulk or foam.

⁴ Examples of durable covers include, but are not limited to, pre-fabricated covers with integral insulation, rigid foam adhered to cover with adhesive, or batt insulation mechanically fastened to the cover (e.g., using bolts, metal wire, or metal strapping).

Existing Homes

The aerosol sealing method has been applied to existing homes and apartments on a limited basis. A 2019 DOE Building America project, Aerosol Sealing of Existing Residences, is developing protocols for sealing existing residences and documenting air leakage reductions.

More Info

Case Studies

Building America Case Study. Apartment Compartmentalization with an Aerosol-Based Sealing Process. 2015. Consortium for Advanced Residential Buildings. DOE/GO-102015-4621.
https://energy.gov/sites/prod/files/2015/07/f24/ba_case_study_compartmentalization_aerosol.pdf

References and Resources

Bohac, David, Curtis Harrington, and Daniel Reif. 2018. "Auto-Sealing New Home Leaks with Aerosols." ACEEE Summer Study on Energy Efficiency in Buildings.
<https://www.mncee.org/MNCEE/media/PDFs/Auto-Sealing-New-Home-Leaks-with-Aerosols.pdf>

Bohac, David, Curtis Harrington, Ben Schoenbauer, Jose Garcia, Jim Fitzgerald, and Mark Modera. 2016. "Demonstrating the Effectiveness of an Aerosol Sealant to Reduce Multi-Unit

Dwelling Envelope Air Leakage.” Minnesota Department of Commerce.

<https://www.cards.commerce.state.mn.us/CARDS/security/search.do?method=showPoup&documentId=%7bB7F5C928-D411-4B9E-B83F-90E856DCC11F%7d&documentTitle=402271&documentType=6>

Harrington, Curtis, and David Springer. 2015. *Field Trial of an Aerosol-Based Enclosure Sealing Technology*. Alliance for Residential Building Innovation for the U.S. Department of Energy Building America Program. DOE/GO-102015-4728.

https://www1.eere.energy.gov/buildings/publications/pdfs/building_america/aerosol-based-enclosure-sealing-technology.pdf

Maxwell, S., D. Berger, and C. Harrington. 2015. *Apartment Compartmentalization with an Aerosol-Based Sealing Process*. Consortium for Advanced Residential Buildings for the U.S. Department of Energy Building America Program. DOE/GO-102015-4620.

https://www1.eere.energy.gov/buildings/publications/pdfs/building_america/apartment-compartmentalization-aerosol-sealing.pdf

Harrington, Curtis, and Mark Modera. 2012. *Laboratory Testing of Aerosol for Enclosure Air Sealing*. Western Cooling Efficiency Center, UC Davis Building Industry Research Alliance for the U.S. Department of Energy Building America Program. DOE/GO-102012-3515.

<https://www.nrel.gov/docs/fy12osti/54046.pdf>



U.S. DEPARTMENT OF
ENERGY

Office of
**ENERGY EFFICIENCY &
RENEWABLE ENERGY**

For more information, visit: buildingamerica.gov

DOE/GO-102020-5475 · December 2020