

# **2013 DOE Bioenergy Technologies Office (BETO) Project Peer Review**

## **National Advanced Biofuels Consortium**

May 20, 2013

Thomas D. Foust  
NREL

# What is the NABC?

- The National Advanced Biofuels Consortium (NABC) is a collaboration among U.S. Department of Energy national laboratories, universities, and private industry that is developing technologies to produce infrastructure-compatible, biomass-based hydrocarbon fuels.
- The consortium, led by the National Renewable Energy Laboratory and Pacific Northwest National Laboratory, is funded by the U.S. Department of Energy under the American Recovery and Reinvestment Act and by NABC partners.
- 3<sup>rd</sup> of three years



**Pacific Northwest**  
NATIONAL LABORATORY  
Proudly Operated by **Battelle** Since 1965



# NABC Priorities and Goals

*The goal of the NABC is to accelerate development of technologies for sustainable, cost-competitive, drop-in fungible hydrocarbon fuels from lignocellulosic biomass to a pilot-ready state.*

---



- Displacing oil at the refinery gate avoids cost in new infrastructure and increases the rate of broad deployment into the existing fleet.
- This approach provides a cost-effective way to supplement the existing market with drop-in fuels made from biomass, and achieve the DOE goals of U.S. energy security, reduced greenhouse gas emissions, and creating economic opportunities across the nation.
- The NABC is developing technologies from both thermochemical and biochemical platforms to produce the best processes for hydrocarbon fuels.

# Quad Chart Overview

## Timeline

Project start – August 2010

Project end – September 2013

Percent complete – 86%

## Barriers Addressed

Tt-E: Pyrolysis of biomass

Bt-A: Biomass fractionation

BT-D: Pretreatment Chemistry

BT-I: Clean-up/Separation

Bt-J: Fuels organism development

Bt-L: BC/TC process integration

## Budget

100% ARRA Funding

Total project funding:	\$49MM
– DOE share:	\$35MM
– 29% Contractor cost share:	\$14 MM
Spent to date:	\$36.1MM

## Partners

NREL & PNNL co-lead the NABC

4 University partners

3 National Laboratory partners

8 Corporate partners

## With expertise in:

Feedstock

Catalysis

Separations

Bioprocessing

Refining

Technology Development

Process Engineering

Cost Analysis

Kinetic & Mechanistic Modeling

Sustainability Analysis

# Project Overview

---

*In 2008, DOE identified a need to add renewable hydrocarbon fuels to the EERE Biomass portfolio, and a Funding Opportunity Announcement (FOA) was issued in 2009 to invite proposals.*

- **The NABC was created as a consortium of key experts in catalyst and process development of thermochemical and biochemical biofuel conversion routes to address this need.**
- **The NABC key objectives are to:**
  - Stage 1**
    - Perform key experiments to determine relative advantages/disadvantages of six selected process strategies.
  - Stage II**
    - Develop two pilot-ready processes to produce renewable hydrocarbon fuels.
  - Cross-Cut**
    - Examine opportunities for integration with current petroleum refining infrastructure.
    - Perform a fundamentals and modeling effort to improve performance and economics of conversion processes.

# Approach - NABC Management & Structure

## Stage 1 – 1 year

- Rigorous evaluation of advanced biofuel conversion technologies
- Downselect to those that meet the criteria to be pilot ready by end of NABC

## Stage 2 – 2 years

- Develop tier 1 technologies to pilot ready state
- Address major technical challenges of tier 2 technologies
  - Fundamentals
  - Sustainability
  - Refinery Integration

NABC matrix of technology and strategy teams will ensure development of complete integrated processes.

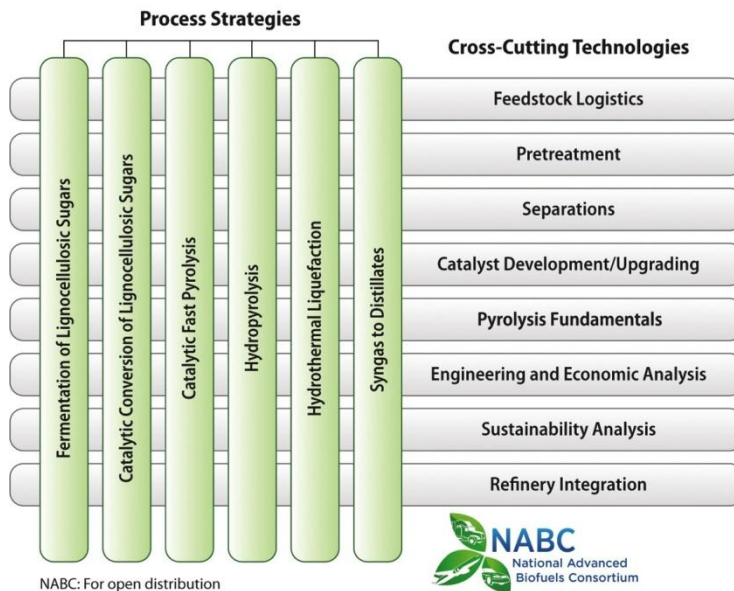

Stage II Process Strategies

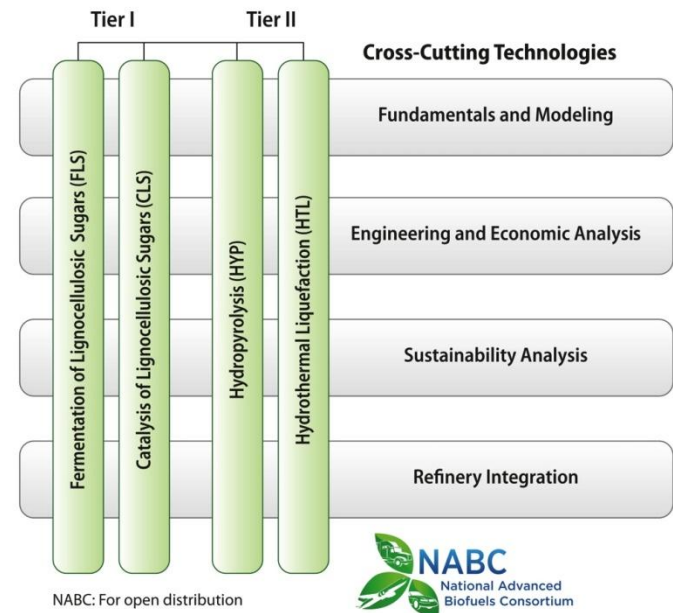

# Approach - Planning & Oversight Schedule

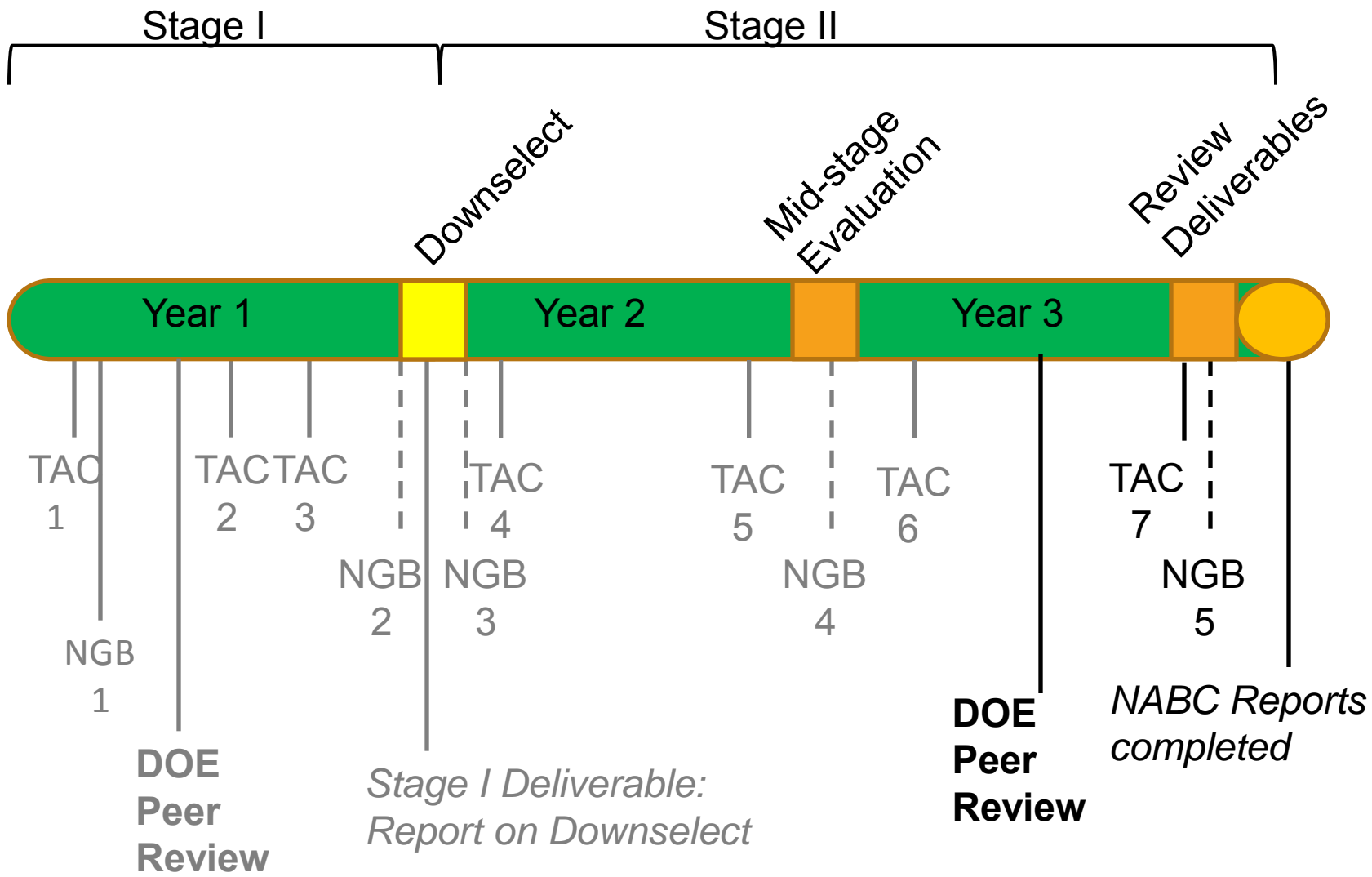

# Stage I Funding: Estimated vs. Spent

Estimated: \$17.11MM

Spent: \$15.16MM

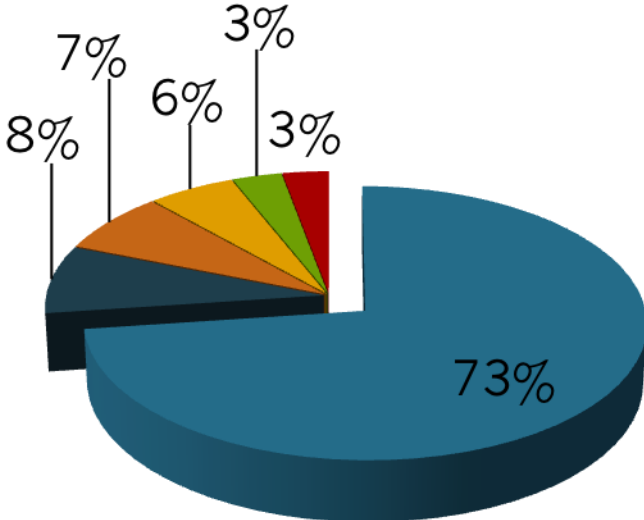

- Process Strategies
- Fundamentals
- Management, contracts, logistics
- TEA and LCA
- Feedstock Logistics
- Refinery Integration

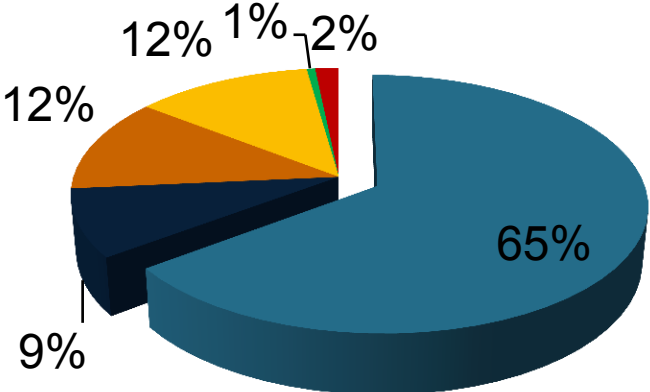



# Down-selection matrix

	(C1)Fuel /Intermediates quality	(C2)Technical readiness	(C3)Sustainability	(C4) Process Efficiency	(C5) Capital and operating costs	(C6) Catalyst and organism robustness	(C7) Fuel Toxicity (Benzene)
CLS							
FLS							
CFP							
HYP							
HTL							
S2D							

Evaluation Results will be ranked as follows:



# Stage I Results

	Criteria	CFP	CLS	FLS	HTL	HYP	S2D	
	Differentiation Did Not Occur							
C1	Fuel/Intermediates Quality	2	2	2	2	2	0	
C7	Fuel Toxicity	2	Fixable	2	2	Fixable	0	
C3	Environmental Sustainability	2	2	2	2	2	0	
C6	Catalyst & Organism Robustness	Stage II Activity						0
	Differentiation Did Occur							
C4	Process Efficiency	1	1	1	2	1	0	
C2	Technical Readiness	1	2	2	1	0	0	
C5	Capital and Operating Costs	2	1	1	1	1	0	
	Numerical scoring of differentiated criteria	4	4	4	4	2	0	

red = 0  
yellow = 1  
green = 2

# NABC Stage II Direction

- **Path forward**
  - **Tier 1** -FLS and CLS on the pilot ready track at the end of stage II per the original goals of DOE and the NABC proposal. This tier will be fully funded and be the priority focus of the NABC. Results verified at higher scales and full sustainability and engineering assessments performed.
  - **Tier 2** –Hydrothermal Liquefaction (HTL) and Hydropyrolysis (HYP) on a track solely focused on addressing the primary technical and economic barriers that were identified in stage I. This tier will not be on the pilot-ready track and hence limited engineering, economic and environmental analysis will be performed. Results at bench scale.
    - Progress has been very good
  - Cross-cuts
    - Fundamentals and Modeling - Integrated focused group making significant impact.
    - Refinery Integration – Impactful research scope defined.
    - Sustainability Analysis of Forest Products Residues – Catchlight Energy
    - Pretreatment, separations, feedstock logistics, catalyst development, TEA and sustainability analysis cross-cuts have been integrated into the conversion strategy areas.

# Stage II Funding: Spent vs. Completion

Spent to Date: \$36.2MM

Estimated at Completion: \$49MM

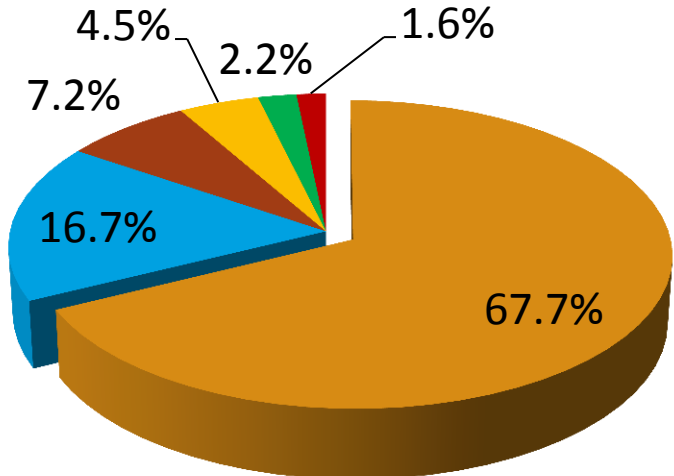

- Process Strategies
- Fundamentals
- Management, contracts, logistics
- TEA and LCA
- Feedstock Logistics
- Refinery Integration

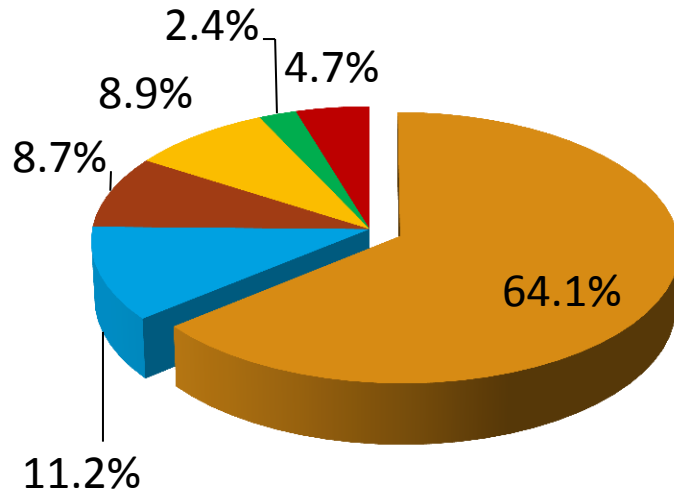

# FLS Strategy

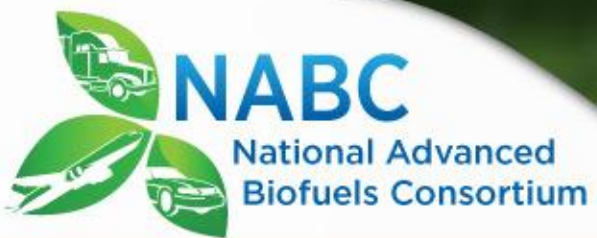

## Biofuels for Advancing America



Developing cost-competitive, sustainable biofuels for today's transportation infrastructure.

Feedstock Supply

Pretreatment & Hydrolysis

Clarification & Concentration

Fermentation of C5 & C6 Sugars

Farnesene Recovery & purification

Product Finishing & Blending

Techno-Economic Analysis & Life Cycle Analysis



# FLS Strategy – R&D Targets

## Carbon Yield to Product:

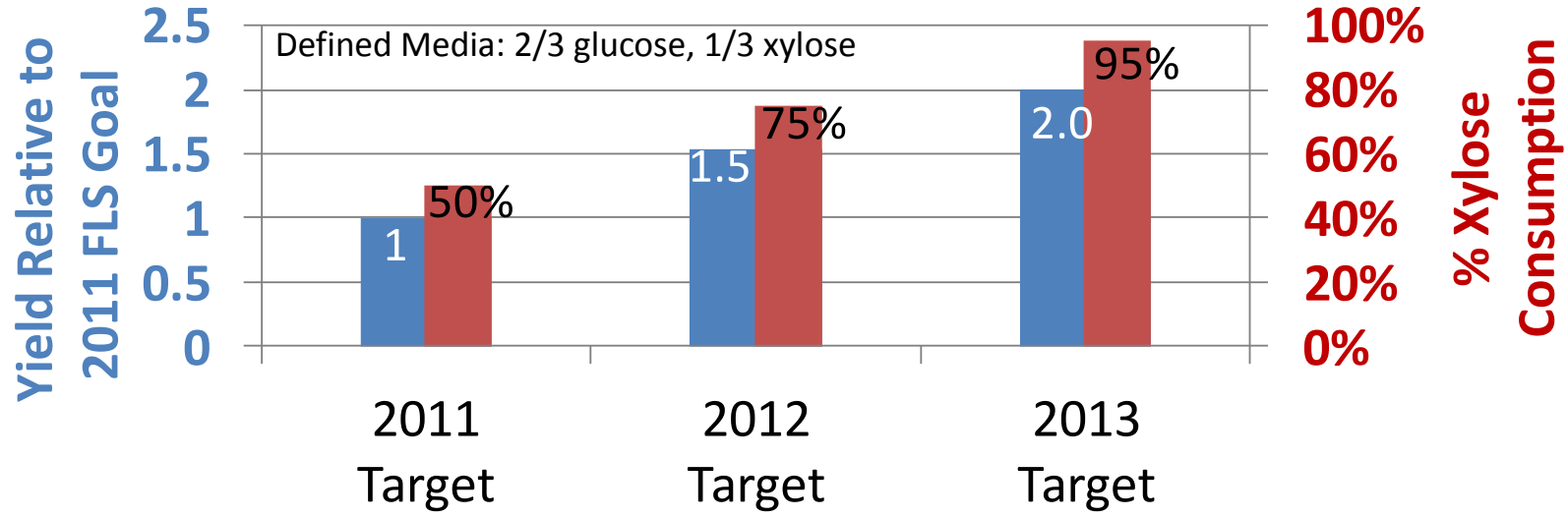

- **2011 and 2012 goals met or exceeded**
  - Yield goals met
  - Achieved >95% xylose consumption in 2012
    - Both cellulosic hydrolysate and defined media fermentations



# FLS Strategy – R&D Targets

---

## Hydrolysate Pretreatment Testing

- Completed in 2012
- No substantial differences between different pretreatments or feedstocks on farnesene production

## Scale up to pilot scale fermentation on cellulosic hydrolysate

- 20L scale (2012):
  - Finalized Liquid/Solid and Liquid/Liquid separation methods
  - Defined feedstock clarification requirements
- 300 L scale (2013)
  - Pilot scale fermentations (300 L) using cellulosic hydrolysate
  - Deliver cellulosic derived diesel (farnesane) to BP for fuels testing

# Carbon Losses for FLS design: SOT, Stage II, and Nth Plant

- Major carbon losses observed during lignin solids removal (non-fermentatable carbon)

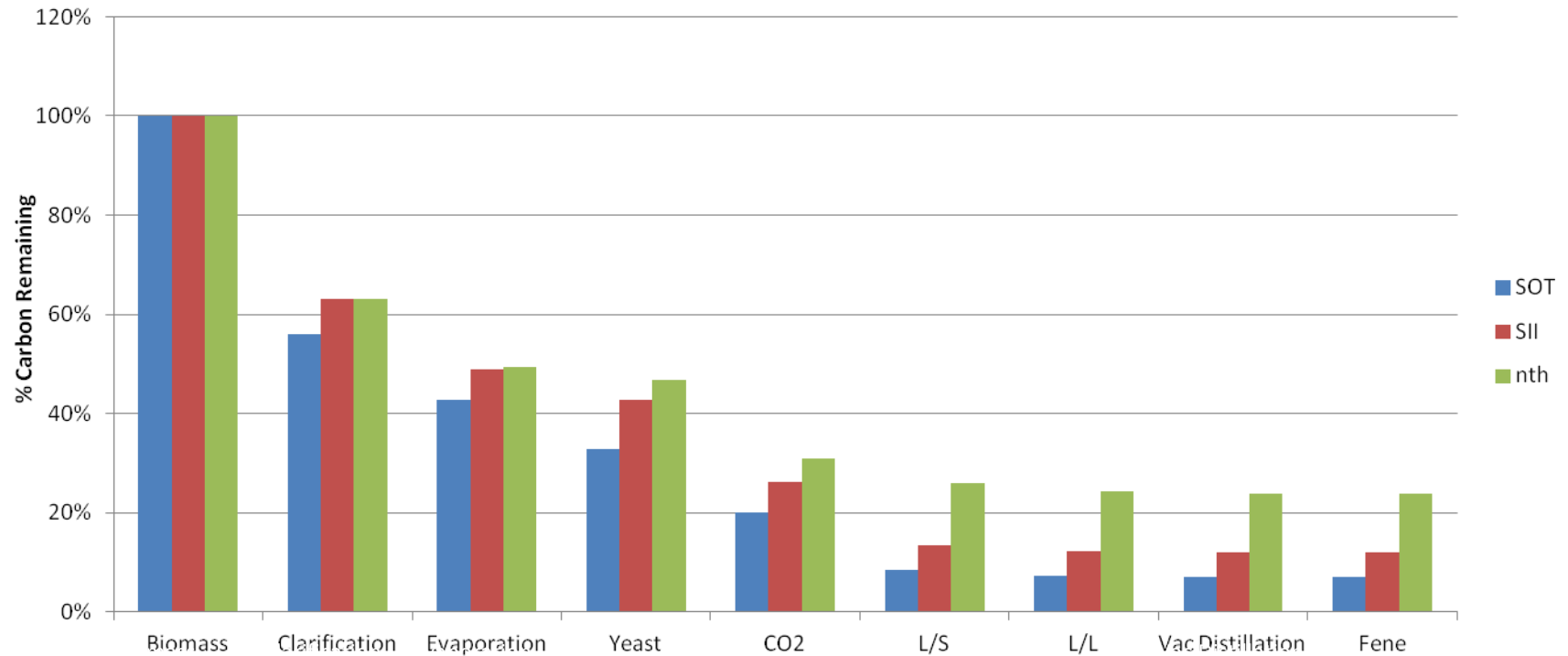

SOT	100%	56%	43%	33%	20%	9%	7%	7%	7%
SII	100%	63%	49%	43%	26%	13%	12%	12%	12%
nth	100%	63%	49%	47%	31%	26%	24%	24%	24%



# Farnesene Yields are Higher in Hydrolysate over Defined Media Due to the Extra Carbon From Acetic Acid

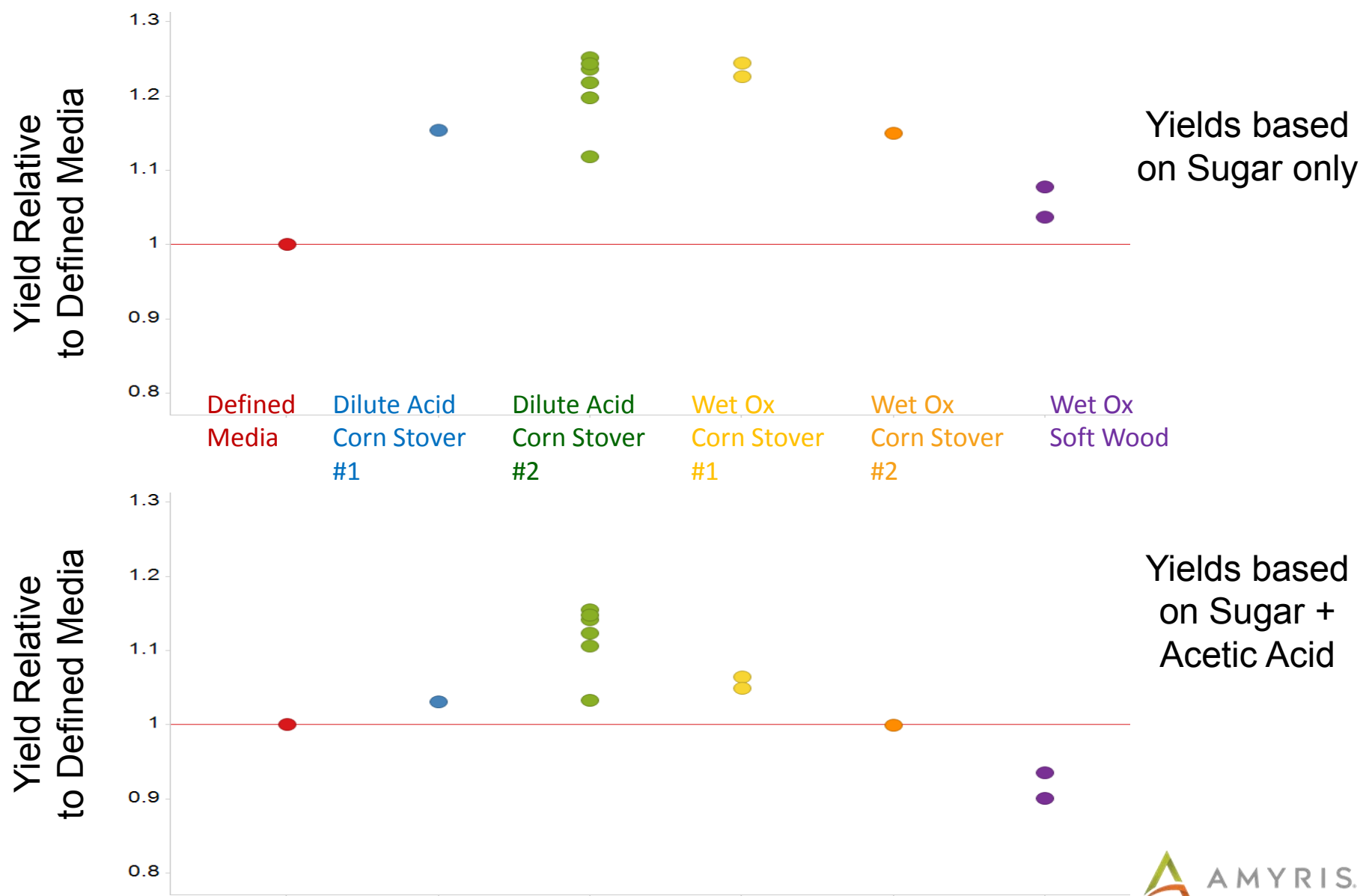

# Dual Strategy to Achieve Final Stage II Strain Engineering Targets

1. Engineer farnesene production into an existing cellulosic ethanol strain

- This is the strategy taken to achieve 2011 - 2012 goals

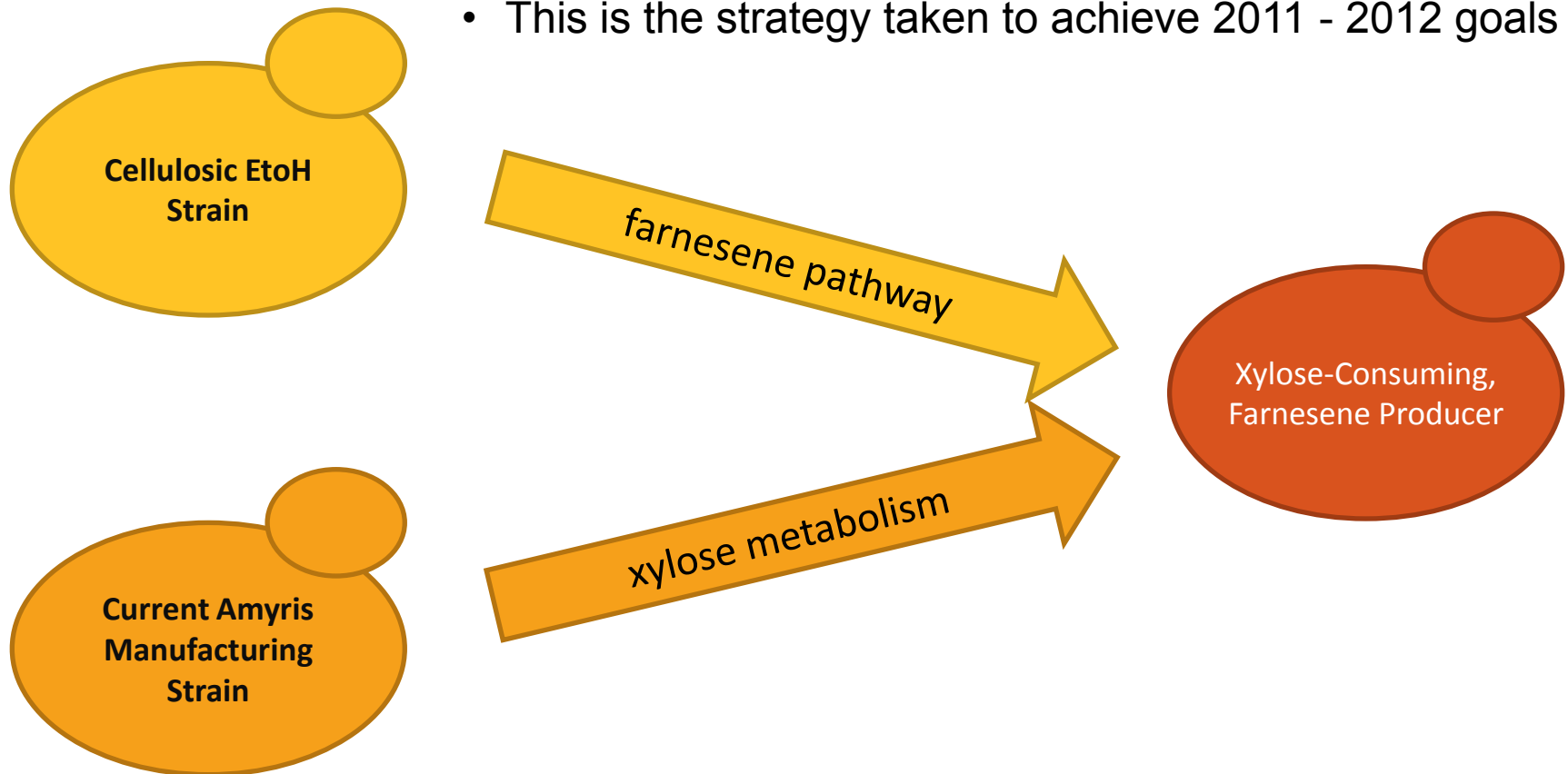

2. Engineer Xylose Metabolism into Amyris' current manufacturing strain

- Use xylose isomerase pathway to enable xylose consumption

# CLS Efforts & Partners

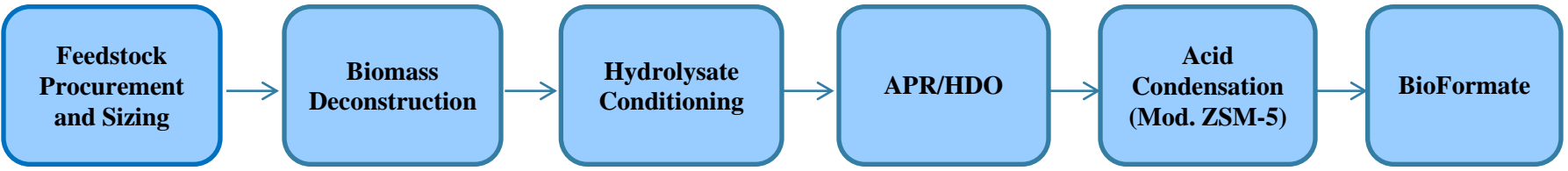

IOWA STATE UNIVERSITY



TEA

LCA

Corrosion Studies



# CLS Key Technical challenges

---

- **De-ashed low cost concentrated sugar stream**
- **Solids removal – Hydrolysates prove challenging for standard filtration methods evaluated to date. (>99%)**
- **Lignin utilization – Recalcitrant nature of remaining lignin makes liquefaction difficult. (maximum C efficiency while still meeting RFS II GHG stipulations)**
- **Catalyst lifetimes – Requires improved contaminant removal at scale and large hydrolysate volumes. (Stability to ~300 hrs)**
- **Catalyst yields – First generation catalyst resulted in higher carbon losses than desired. (Improvements of > 16%)**

# Pretreatment/Deconstruction

- **1s of kg scale**
  - Screen pretreatment for ash removal from biomass
  - Bench scale deconstruction on selected de-ashed feedstocks
- **100s of kg scale**
  - Scale up selected de-ashing technology
  - Generate 2 stage pretreatment and partial/no enzymatic hydrolysis hydrolysates
  - Understand S-L separation differences from full enzymatic hydrolysis process
  - Vacuum evap. concentration (10s of liters)
- **1 ton/day scale**
  - Generate 1 stage pretreatment and full enzymatic hydrolysis hydrolysates (~2000 liters)
  - S-L separation in filtering basket centrifuge and/or Pall crossflow filter
  - Vacuum evap. concentration (100s of liters)



# Solids/Contaminants Removal & Purification

- **Solids separation for hydrolysates**
  - Develop cost effective solids separation techniques (Pall, Virent)
- **Improve efficiency of hydrolysate concentration**
  - Retain volatile carbon components in the hydrolysate feedstock (Virent)
- **Improve efficiency of contaminant removal**
  - Develop economically viable ash removal scheme (Virent)
  - Evaluate alternative contaminant removal techniques such as liquid liquid extraction, precipitation, SMB, etc. (Virent)

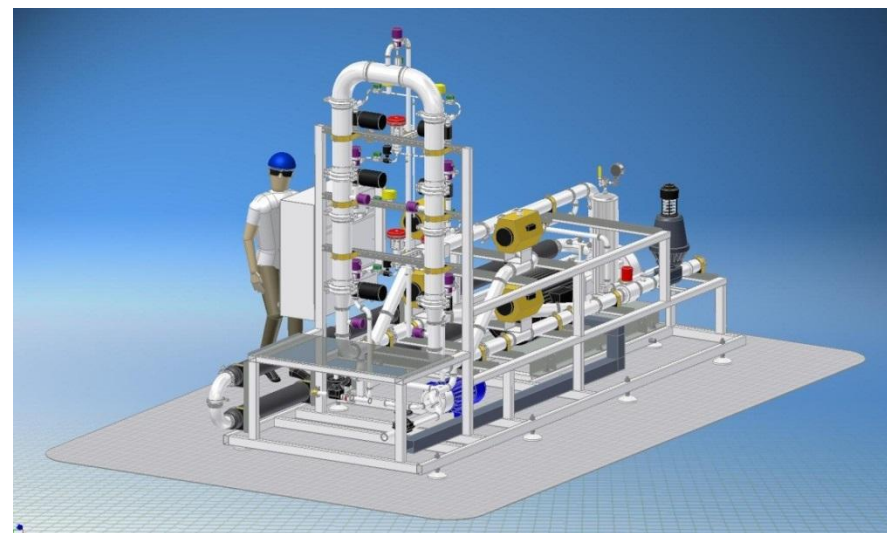
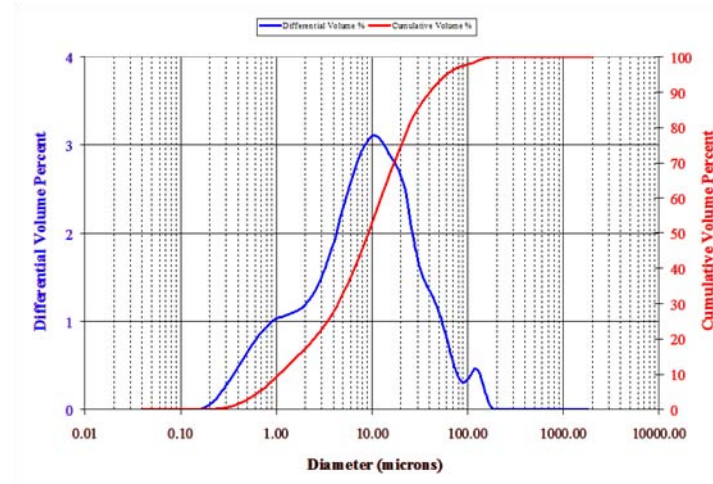

# APR Catalyst Development

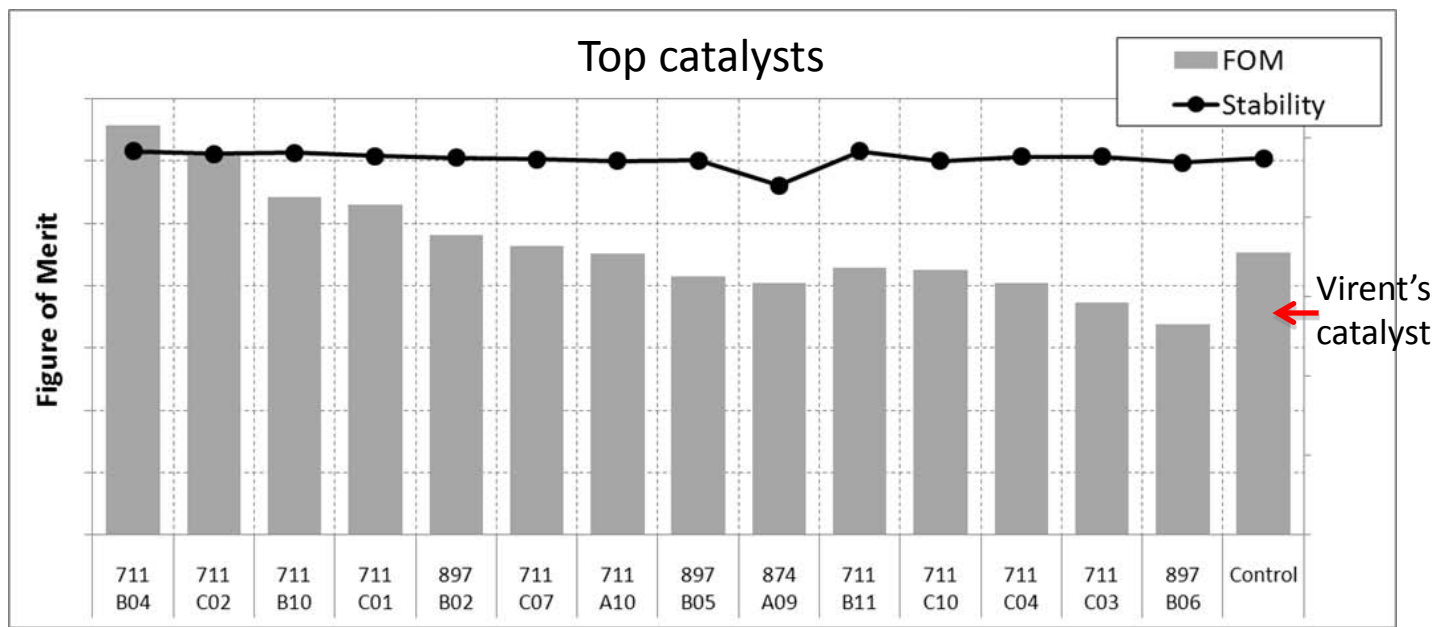

- **High throughput synthesis, testing and analysis of over 130 catalysts complemented by catalyst characterization provided understanding of the effect of support, promoters and metal dispersion.**
- **Improved synthesis resulted in reducing the precious metal loading by 75% while improving the catalyst performance.**

# APR Catalyst Development

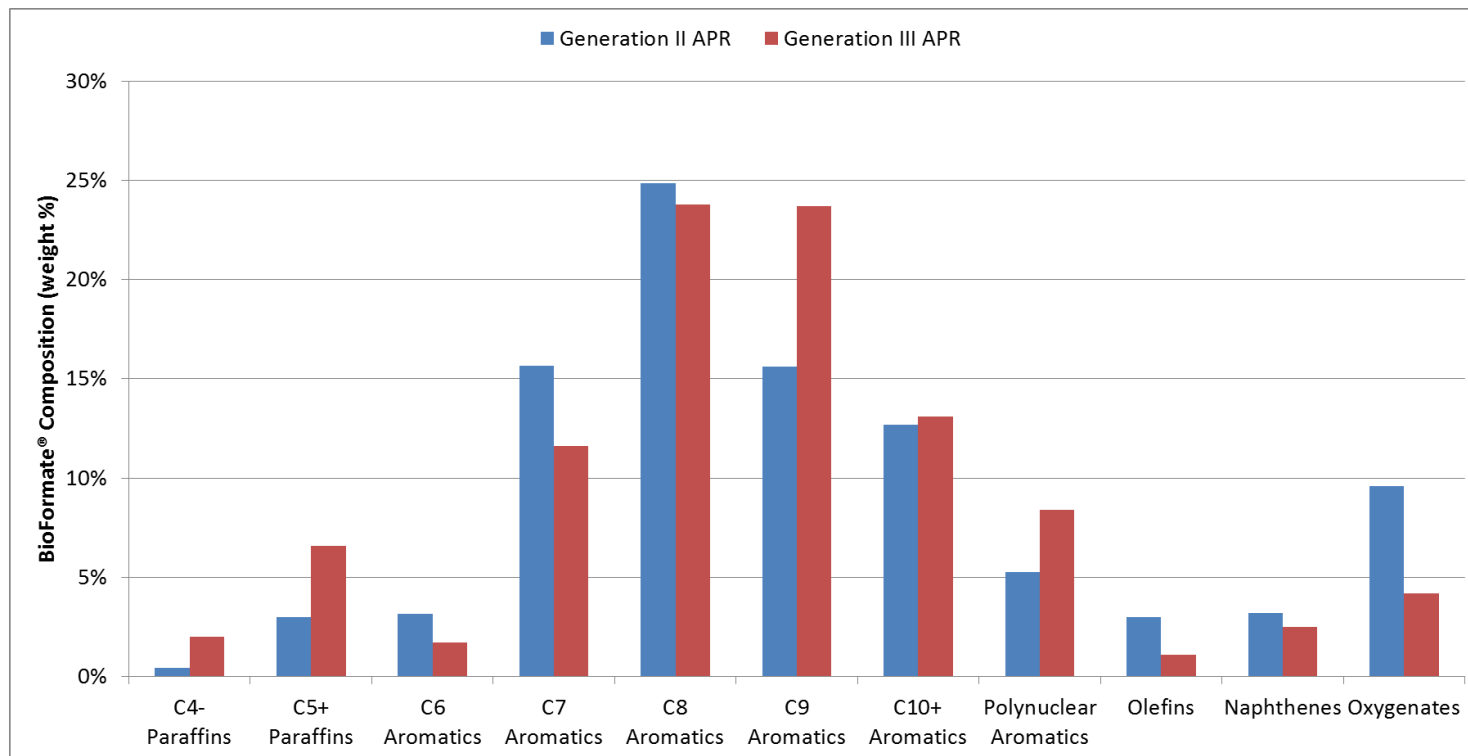

- **Gen III catalyst provides 90% reduction in APR catalyst cost**
- **Higher quality final gasoline product with Gen III catalyst**



# Progress in Year 2 towards targets

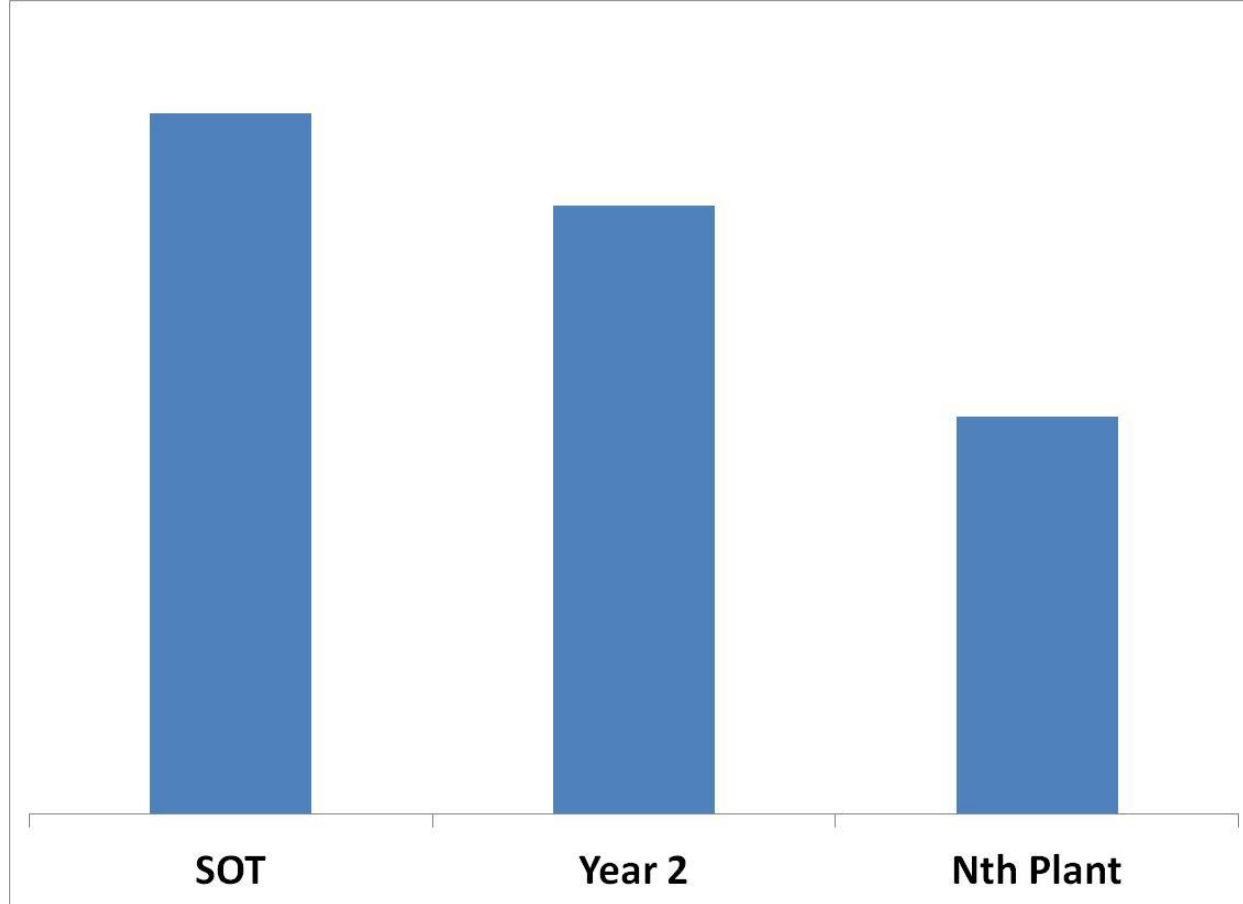

- End of Year 2 Status: ~30% reduction in Nth plant economics case
  - Year 2 improvements based primarily on pretreatment improvements
  - Catalyst cost and process yield improvements to be incorporated in Year 3 work

# Stage II HYP Objectives & Goals

## Team Members

- RTI, lead
- NCSU
- NREL
- Pall Corporation
- BP
- Tesoro
- ORNL

### **Address the major barriers to the technical feasibility of hydropyrolysis as a Tier II activity**

- Optimize product yield and quality
- Determine equilibrium catalyst performance
- Quantify hydrogen demand
- Refine TEA – capital cost estimates and process integration
- Investigate separations processes

### **Understand governing chemical mechanisms for hydropyrolysis**

- Control hydrocarbon distribution - aromatic and non-aromatic
- Deoxygenation pathways
- Hydrogenation chemistry
- Char and coke production

### **Refinery Integration – Target properties for insertion point #2**

- Intermediates and finished blends
  - Oxygen content < 10 wt%
  - TAN < 10
  - Aromatic content
- Acids Content/Corrosion Analysis

# HYP Stage II - R&D Targets and Approach

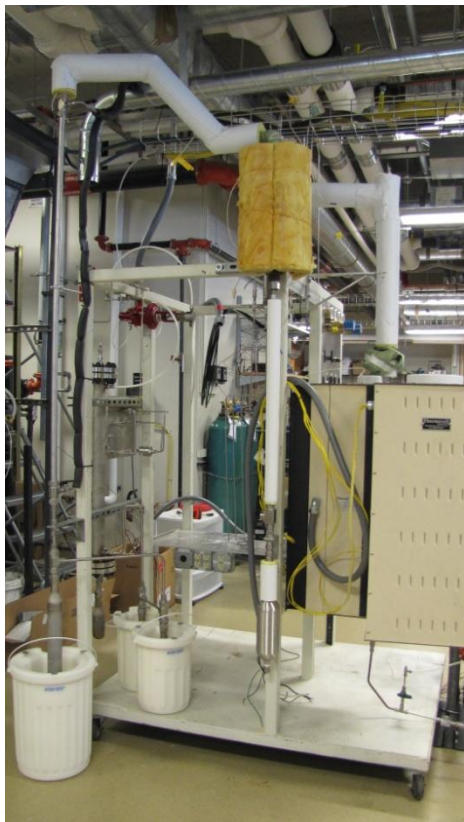

Pathway from Stage 1 SOT to nth Plant Case	
Hydrocarbon Yield	47 to 70 gal/ton
Carbon Efficiency (% C biomass only)	25% to 34%
Energy Recovery in C <sub>4</sub> <sup>+</sup> product	32% to 42.5%
Experimental Bench-scale material balance	83% to 90+%
Catalyst time on stream	27 hrs to 100's hrs
Experimentally determine H <sub>2</sub> demand	Less product dilution
Heat Balance	Endothermic or exothermic

## Parametric studies to optimize process conditions (T, P, P<sub>H2</sub>)

- Maximize liquid hydrocarbon yields and correlate with deoxygenation
- Determine hydrogen demand
- Test different NABC biomass feedstocks – woody biomass and corn stover

## RTI Pressurized Fluidized Bed Reactor system development

- Higher biomass throughput
- Improved liquid product collection efficiency

## Product Upgrading

- Collect enough hydrocarbon product for refinery integration evaluation (at least 1.3-L)

# Improved Mass Closure and HC Yields

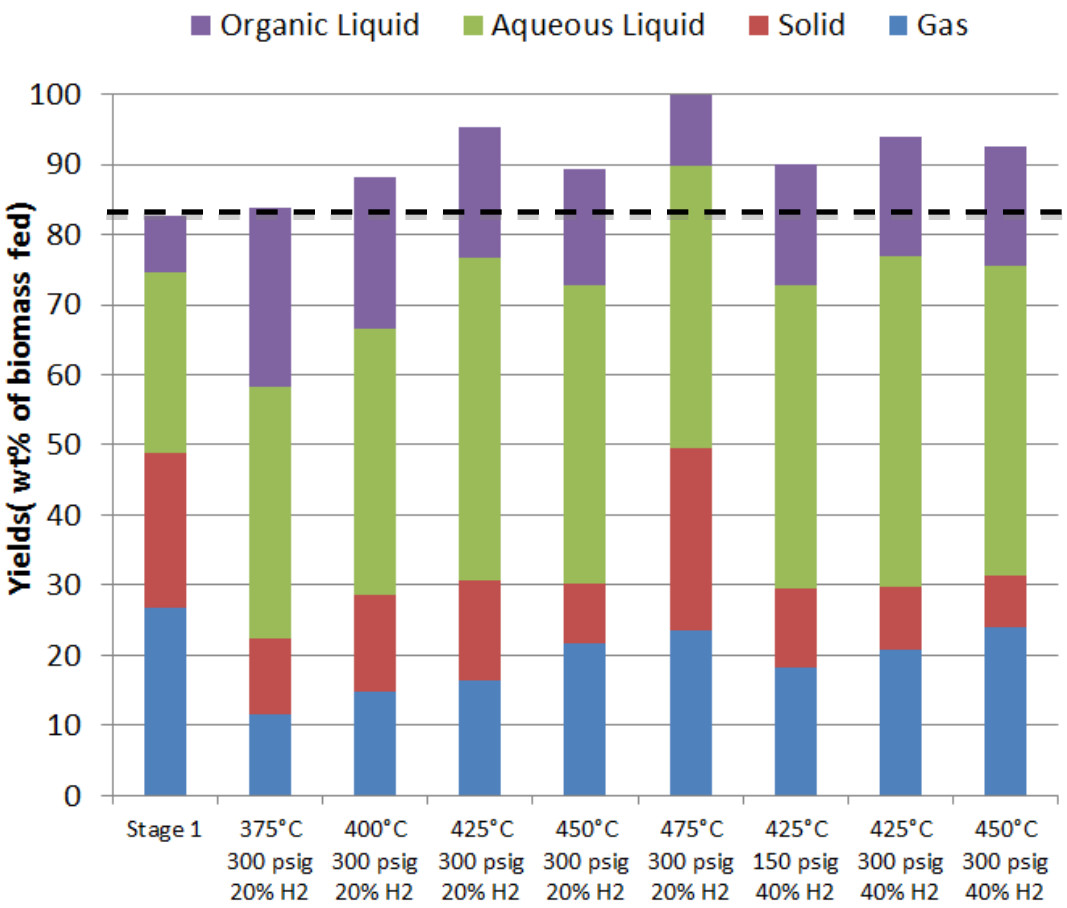

Process Parameter	Stage 2 Progress to date
H <sub>2</sub> Partial Pressure	P = 120 psig
Reactor Yields (wt %daf biomass)	<b>Bio-Crude: 22.4%</b> Water: 47.1% Gas phase: 15.7% Char: 8.9% Unknown: 5.9%
Bio-crude Oxygen Content	<b>2.0 wt%</b>
Carbon lost to aqueous phase	<0.5 wt%
Product Yield (gal/dry short ton)	63.6 gal/ton (C5+) 74.0 gal/ton (C4+)
Carbon Efficiency to Liquid Products	<b>37.7% (C5+)</b> <b>42.0% (C4+)</b>

# Improved Product Suite

GC/MS Area %	Stage 1		Stage 2 Pine, 425°C, 300psig, 40% H2	
	Organic	Aqueous	Organic	Aqueous
Aliphatics	3	0	20.7	1.1
Aldhyde/ketone	0.6	28	1.5	46.4
Acids	0.6	14	0.5	0.2
Aromatics	94	46	68.5	50.3
<i>Benzene derivatives</i>	47	2	28.9	3.7
<i>PAHs</i>	45	5	22.8	0
<i>Phenols</i>	2	39	16.8	46.6
Other	2	12	8.8	2.0

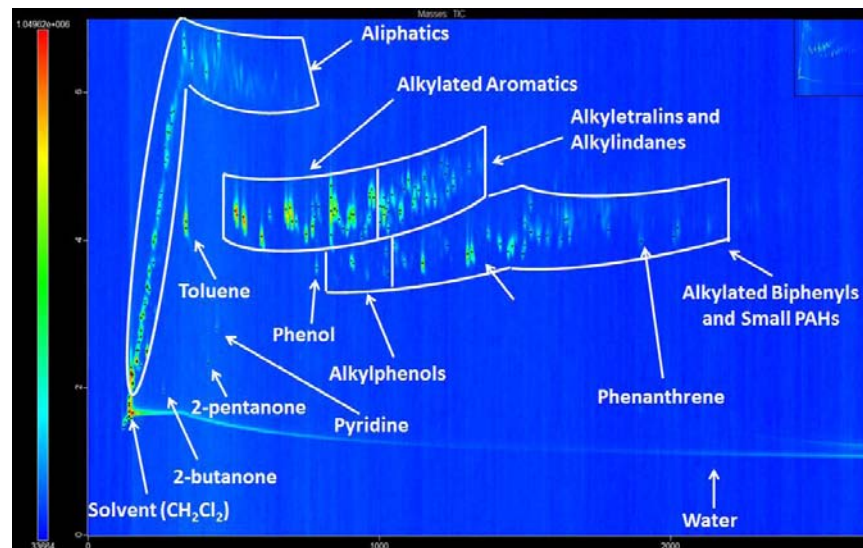
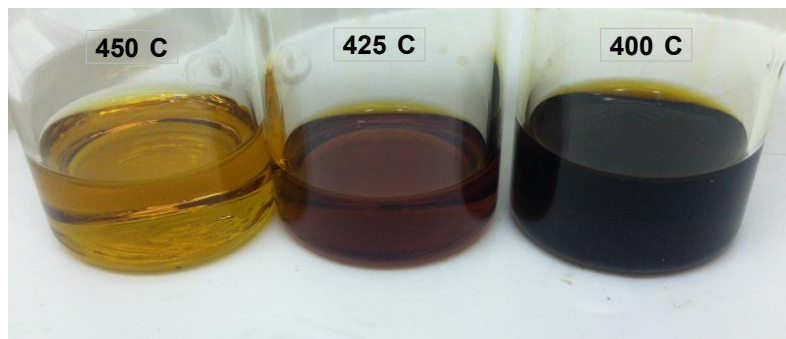

# Path Towards Pilot Readiness

- **Catalyst development**
  - Improved formulations and scale-up
  - Attrition testing
  - Long-term performance at pilot scale, regeneration
  - Deactivation and lifetime
- **Process Development**
  - Heat Integration
  - Light hydrocarbon recovery and reforming
  - Hydrogen demand
  - Refined CAPEX Estimates and reactor design
  - Validate reliable pressurized biomass feeding

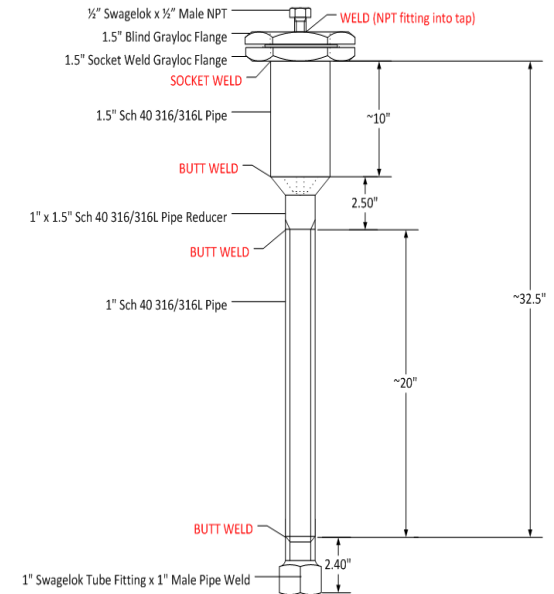

# HTL Stage 2 Goals

## Hydrothermal Liquefaction

- Identify scalable designs and address plugging issues
- Produce liter quantities of bio-oil for performance & upgrading at LHSV >1.5 L/L/h
- Demonstrate 50% carbon efficiency

## Upgrading

- Upgrade HTL bio-oil from stover & wood
- Conduct parametric upgrading study (commercial catalyst, HT severity)
- ~1 L HT products to refinery partners

## Refinery Integration

- Understand effects of HTL and upgrading conditions on refinery insertion points

**Cornstover  
Bio-oil**



**HT Cornstover  
(2<sup>nd</sup> Pass)**



# HTL Experimental Set Up

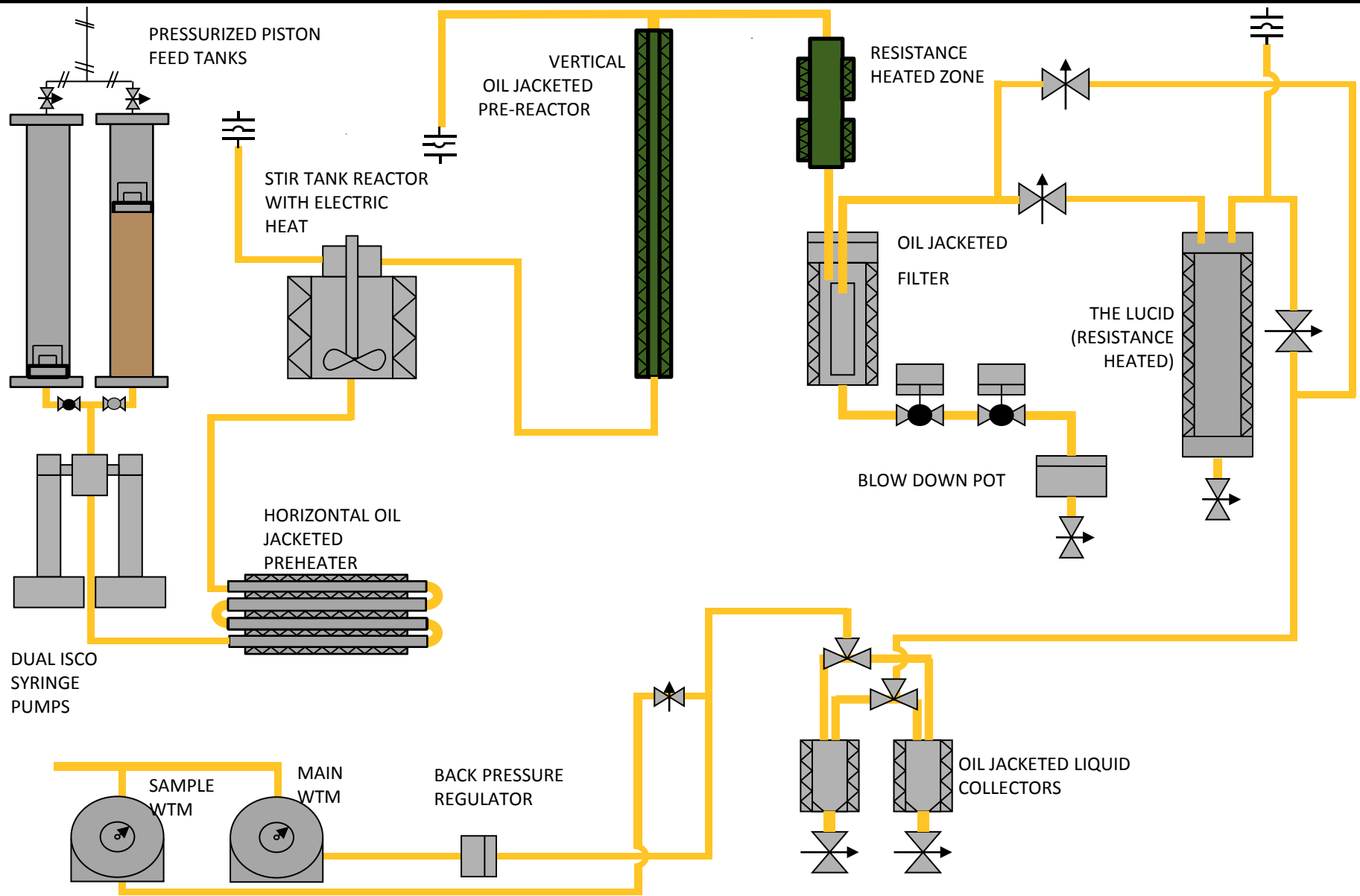



# Carbon Balance Block Flow Diagram

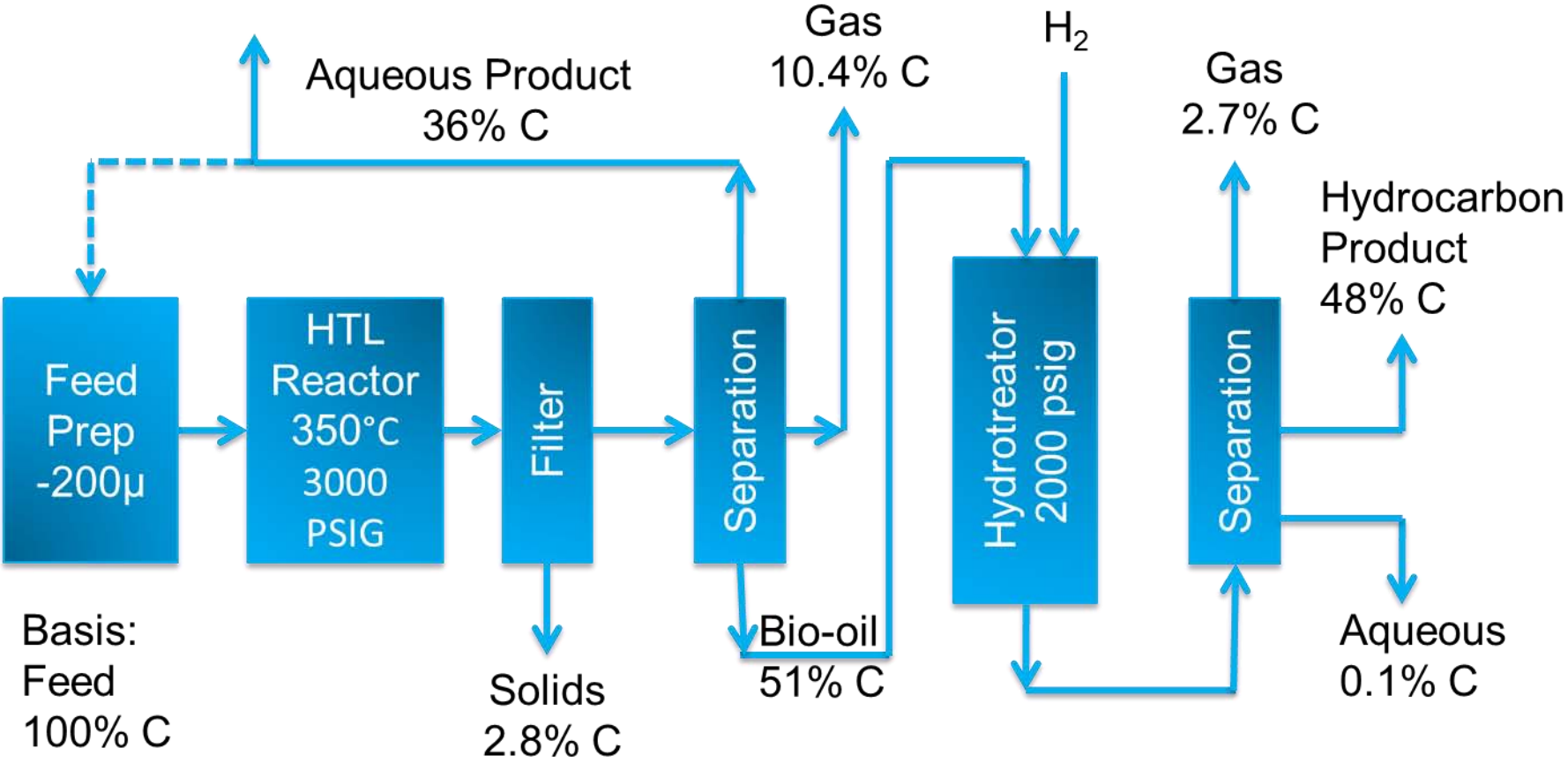

Overall carbon yield to hydrotreated product is 48% SOT Case;  
 Demonstrated to 50%

# HTL Liquefaction Runs for Upgrading

Run Parameter	Unit	CS5/7 stover	CS8 stover	Wd18 pine	Wd21 pine	W23A Pine	W23B Pine	Mean of 4 Stage 1
Run Type	NA	Baseline	Recycle	Baseline	Low severity	Recycle	Rec 2X	CSTR w/pine
HTL Temperature	°C	350	349	350	346	349	344	354
Space Velocity	V/V/h	2.2	2.2	2.2	4.4	2.2	2.2	1.5
Mass Balance	%	98%	94%	98%	99%	100%	100%	98%
Carbon Balance	%	83%	93%	88%	68%	96%	91%	89%
Yield* to Oil (Mass, AF)	% (N)	30%	28%	40%	31%	34.1%	34.4%	34%
Yield* to Oil, (C)	% (N)	45%	44%	64%	44%	50%	50%	52%
Yield* to Aqueous, (C)	% (N)	41%	42%	28%	36%	34%	39%	36%
Yield* to Gas (C)	% (N)	13%	11%	8.2%	6%	12%	7%	10%
Yield* to Solids (C)	% (N)	1.7%	3.1%	NM	14%	3.5%	4.1%	2.0%
Hours on Stream	h	26	31	12	18	24	36	53 (total)
Bio-Oil to Upgrading	ml	600	1150	500	570	1300	2000	3300 (total)

\*yields normalized to carbon

- **Plugging can be avoided by system design & operating parameters**
- **Quality of bio-oil (oxygen, density, viscosity) diminishes at liquid hourly space velocity greater than 2.2 Use of recycle in feed make-up improves HTL operability and bio-oil quality**

# Upgrading

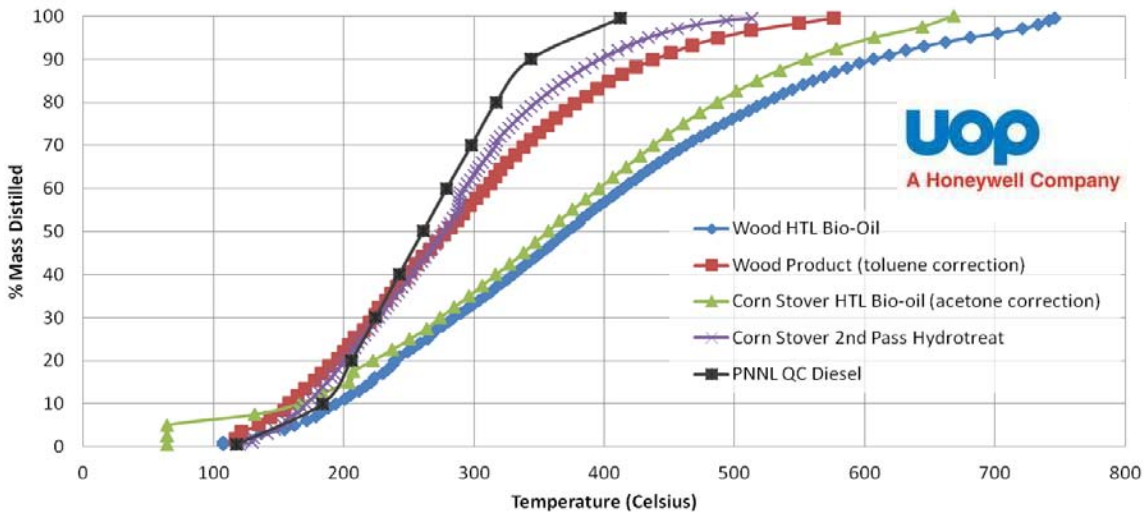
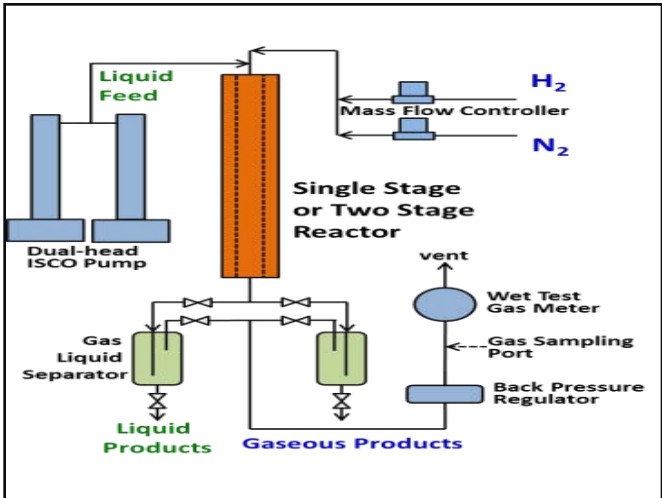

Sample	Oxygen Wt%	Nitrogen Wt%
Bio-oil (PNNL)	20%	0.97 to 1.1
HT – Pass 1 (UOP)	0.48%	0.56
HT – Pass 2 (UOP)	0.05%	0.04
HT-169 (PNNL)	0.06%	< 0.05%

	Naphtha	Distillate	Heavies
Fraction, Wt%	25%	43%	25%
Density, g/mL	0.831	0.887	0.93
Oxygen, Wt%	NA	0.14%	0.36%
Nitrogen, ppm	NA	NA	<0.1%
Sulfur, ppm	NA	1	6
H:C ratio	NA	NA	1.53
Flash, °C	44.4	109	NA

# Fundamentals and Modeling Team

Objective: Provide fundamental, molecular-level insights to the NABC process strategies that will enable efficient routes for engineering processes and catalysts

Utilize self-consistent approaches across process strategies

Conversion /Substrate	Biomass Deconstruction to Bio-oil	Bio-oil Deoxygenation to Fuels	Catalytic Biomass Deconstruction to Intermediates	Catalytic Upgrading to Fuels
Carbohydrates	Iowa State, Northwestern, CSM, NREL, LANL	Iowa State, Northwestern, CSM, NREL, LANL	NREL, Virent, Amyris	Virent, Amyris
Lignin	Iowa State, LANL, Northwestern, CSM, NREL	NREL, Iowa State, CSM,	Northwestern, NREL, Iowa State, LANL	NREL, Northwestern

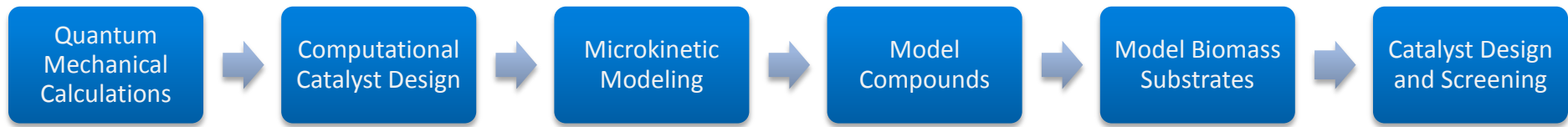

# Biomass Pyrolysis to Bio-oil: Carbohydrates

**Objective:** build predictive model for observed cellulose pyrolysis experimental results

Outcome: first-principles model that accurately describes cellulose pyrolysis as a function of operating conditions

Implication: can now integrate cellulose pyrolysis with bio-oil upgrading approaches

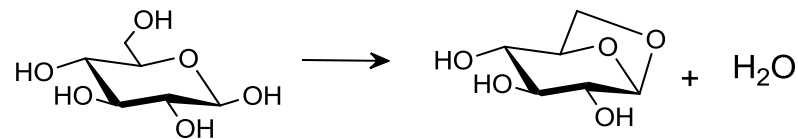
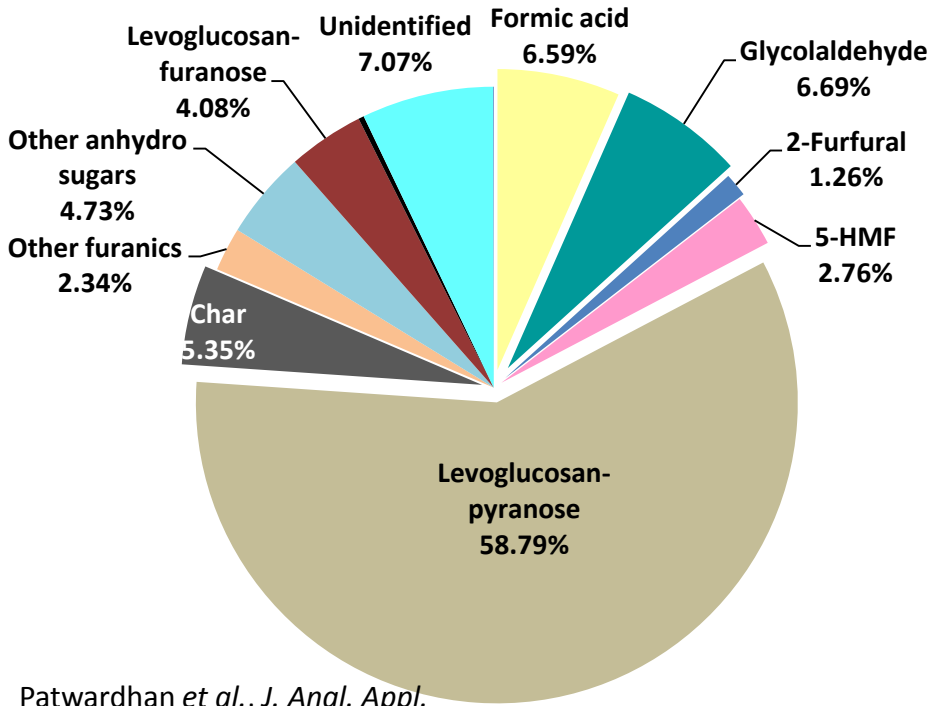

Patwardhan et al., *J. Anal. Appl. Pyrolysis*, **2009**, 86, 323-330

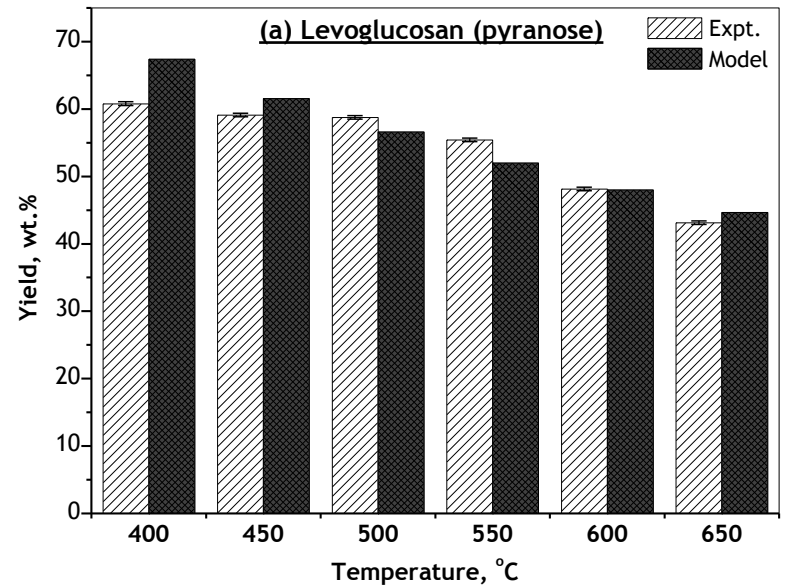
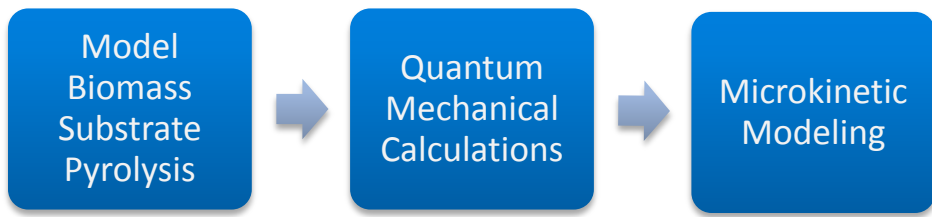

Vinu and Broadbelt, *Energy Env. Sci.* 2013

Mayes and Broadbelt, *J. Phys. Chem. A* 2012

# Biomass Pyrolysis to Bio-oil: Lignin

**Objective:** understand lignin pyrolysis mechanisms

Examined homolytic susceptibility of bonds

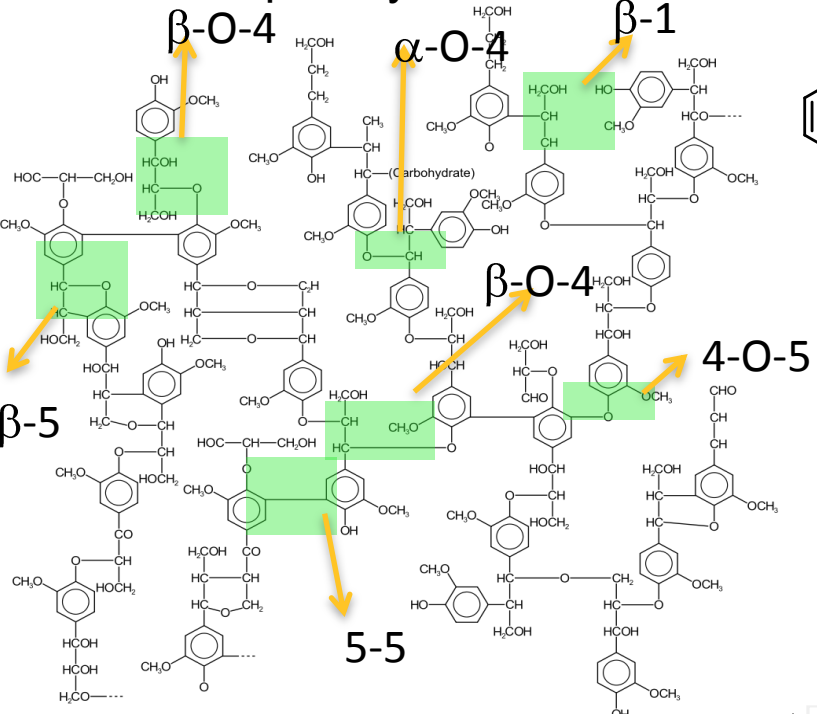

Gnanakaran *et al*, *J. Phys. Chem. Lett.* 2011

Outcome: methods to obtain low MW species from lignin pyrolysis

Implication: Enables integrated design of deconstruction and deoxygenation

Using models to understand pyrolysis mechanisms

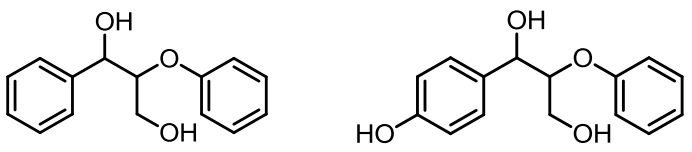

Developed model to generate polymer models for microkinetics

G- $\alpha$ O4-G- $\alpha$ O4-G- $\beta$ O4-G- $\beta$ O4-G- $\beta$ O4-( $\alpha$ O4-G)-S- $\beta$ O4-S- $\beta$ O4-H-  
 $\alpha$ O4-S- $\alpha$ O4 $\beta$ S-G- $\beta$ O4-G-(55-G)- $\beta$ O4-S- $\alpha$ O4 $\beta$ S-G-(4O5-G)- $\beta$ O4-S-  
 $\beta$ O4-S- $\beta$ O4-S- $\beta$ O4-G- $\beta$ O4-G-(4O5-S)- $\beta$ O4-S- $\beta$ O4-( $\alpha$ O4-G)-G-(55-G)-  
G- $\alpha$ O4-S- $\beta$ O4-S- $\beta$ O4-H- $\beta$ O4-G- $\beta$ O4-S- $\beta$ O4-( $\alpha$ O4-G)-G-(55-G)-  
 $\beta$ O4-S- $\alpha$ O4 $\beta$ S-S- $\alpha$ O4 $\beta$ S-G- $\beta$ O4-G- $\beta$ O4-G-(55-S)- $\alpha$ O4-( $\beta$ O4-G)-G-  
 $\beta$ O4-G- $\beta$ O4-S- $\beta$ O4-G-(55-H)- $\beta$ O4-S- $\alpha$ O4 $\beta$ S-H- $\beta$ O4-S- $\beta$ O4-S- $\beta$ O4-  
H- $\beta$ O4-G- $\beta$ O4-G-(4O5-S)- $\alpha$ O4-S

Quantum Mechanical Calculations

Microkinetic Modeling

Model Compounds

Model Biomass Substrates

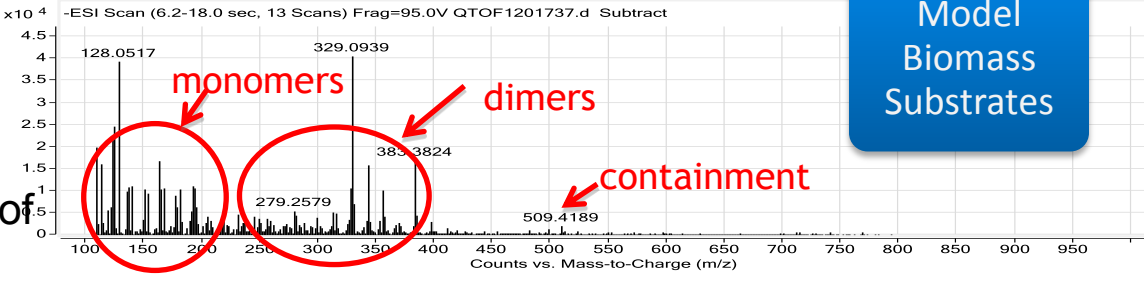

# Bio-oil upgrading: Approach for Carbohydrates and Lignin

**Objective:** understand catalytic transformations of carbohydrate-derived bio-oil

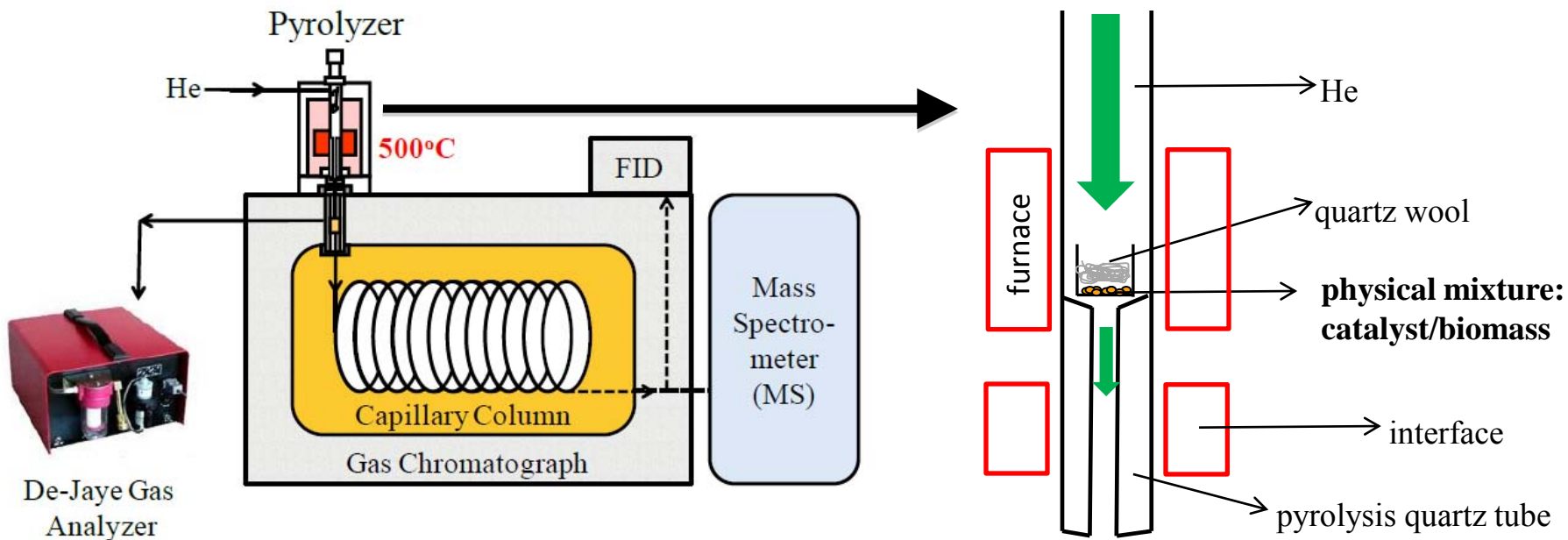

Model Biomass  
Substrate  
Pyrolysis

Catalyst Design  
and Screening

Computational  
Catalyst Design

Approach: Screen catalysts for deoxygenation and using QM calculations to understand catalytic mechanisms

Outcome: Identifying and designing new catalysts for deoxygenation of carbohydrate- and lignin-derived bio-oil products and applying new catalysts now to biomass-derived bio-oil

Implication: New catalytic processes and conditions for bio-oil upgrading to fuels

# Catalytic Deconstruction of Lignin

Objective: understand fate of lignin in acid and base environments

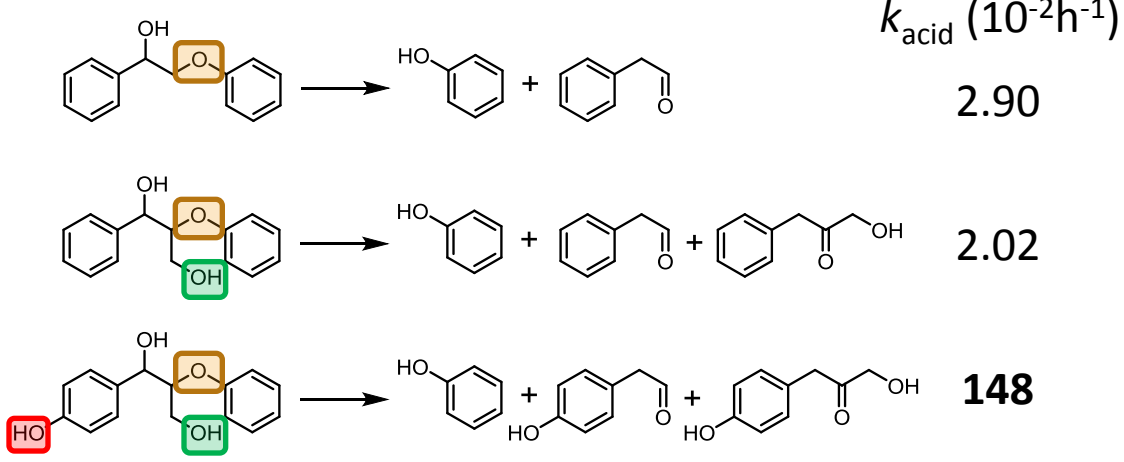

Applying lignin polymer model to model unzipping reactions

G- $\alpha$ O4-G- $\alpha$ O4-G- $\beta$ O4-G- $\beta$ O4-G- $\beta$ O4-( $\alpha$ O4-G)-S- $\beta$ O4-S- $\beta$ O4-H-  
 $\alpha$ O4-S- $\alpha$ O4 $\beta$ S-G- $\beta$ O4-G-(55-G)- $\beta$ O4-S- $\alpha$ O4 $\beta$ S-G-(4O5-G)- $\beta$ O4-S-  
 $\beta$ O4-S- $\beta$ O4-S- $\beta$ O4-G- $\beta$ O4-G-(4O5-S)- $\beta$ O4-S- $\beta$ O4-( $\alpha$ O4-G)-G-(55-G)-  
G- $\alpha$ O4-S- $\beta$ O4-S- $\beta$ O4-H- $\beta$ O4-G- $\beta$ O4-S- $\beta$ O4-( $\alpha$ O4-G)-G-(55-G)-  
 $\beta$ O4-S- $\alpha$ O4 $\beta$ S-S- $\alpha$ O4 $\beta$ S-G- $\beta$ O4-G- $\beta$ O4-G-(55-S)- $\alpha$ O4-( $\beta$ O4-G)-G-  
 $\beta$ O4-G- $\beta$ O4-S- $\beta$ O4-G-(55-H)- $\beta$ O4-S- $\alpha$ O4 $\beta$ S-H- $\beta$ O4-S- $\beta$ O4-S- $\beta$ O4-  
H- $\beta$ O4-G- $\beta$ O4-G-(4O5-S)- $\alpha$ O4-S

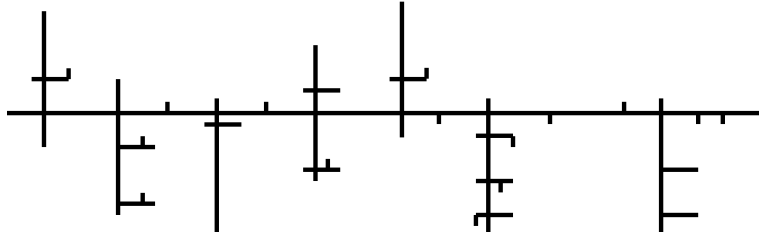

New solid base catalysts for lignin depolymerization

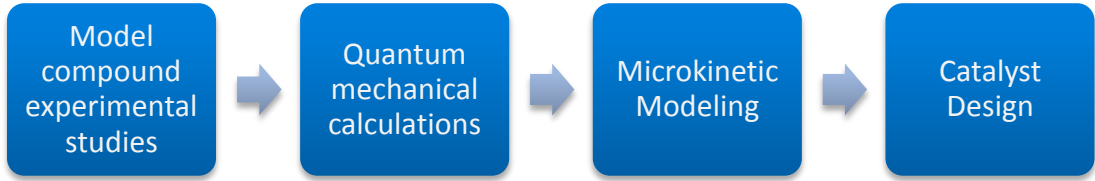
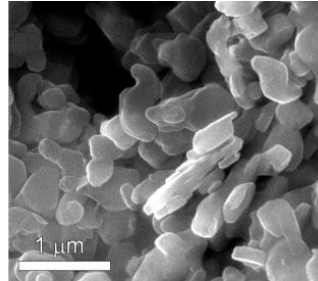
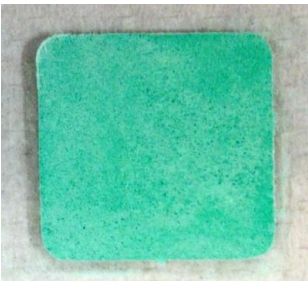

Outcome: Lignin depolymerization in acid is a terminal-unzipping reaction; developed new solid base catalysts for lignin depolymerization

Implication: New methods and understanding for lignin depolymerization



# Catalytic Upgrading of Lignin

Objective: Develop selective upgrading strategies for lignin upgrading to fuels/chemicals

Heterogeneous oxygenated aromatics

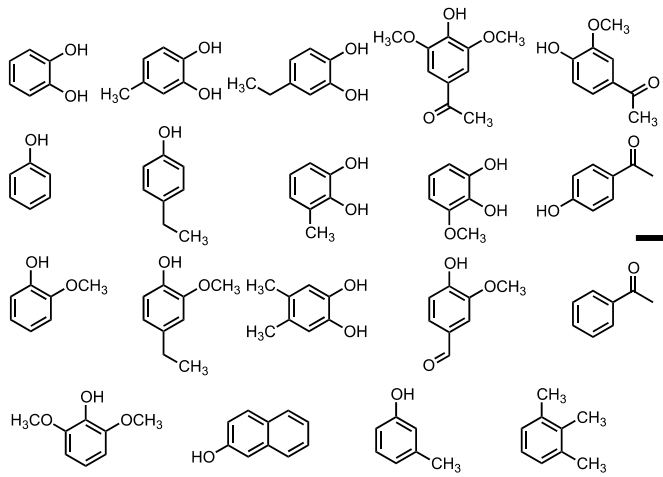

Catalytic Defunctionalization

Catalytic Upgrading Processes

Individual Targets

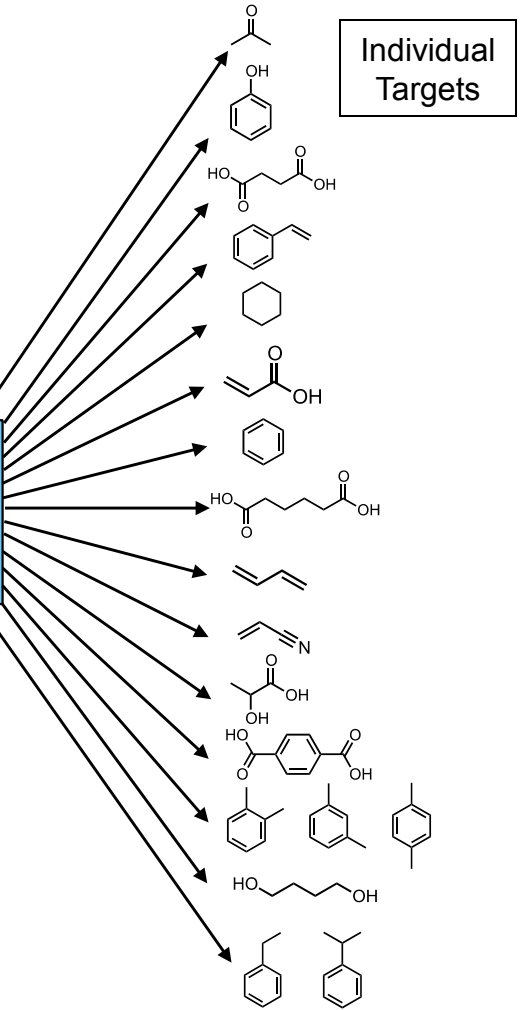

Outcome: Developed a new, selective strategy for catalytic defunctionalization of lignin-derived species

Implication: Will enable new routes to produce both HC fuels and value-added chemicals from lignin

# NABC Refinery Integration

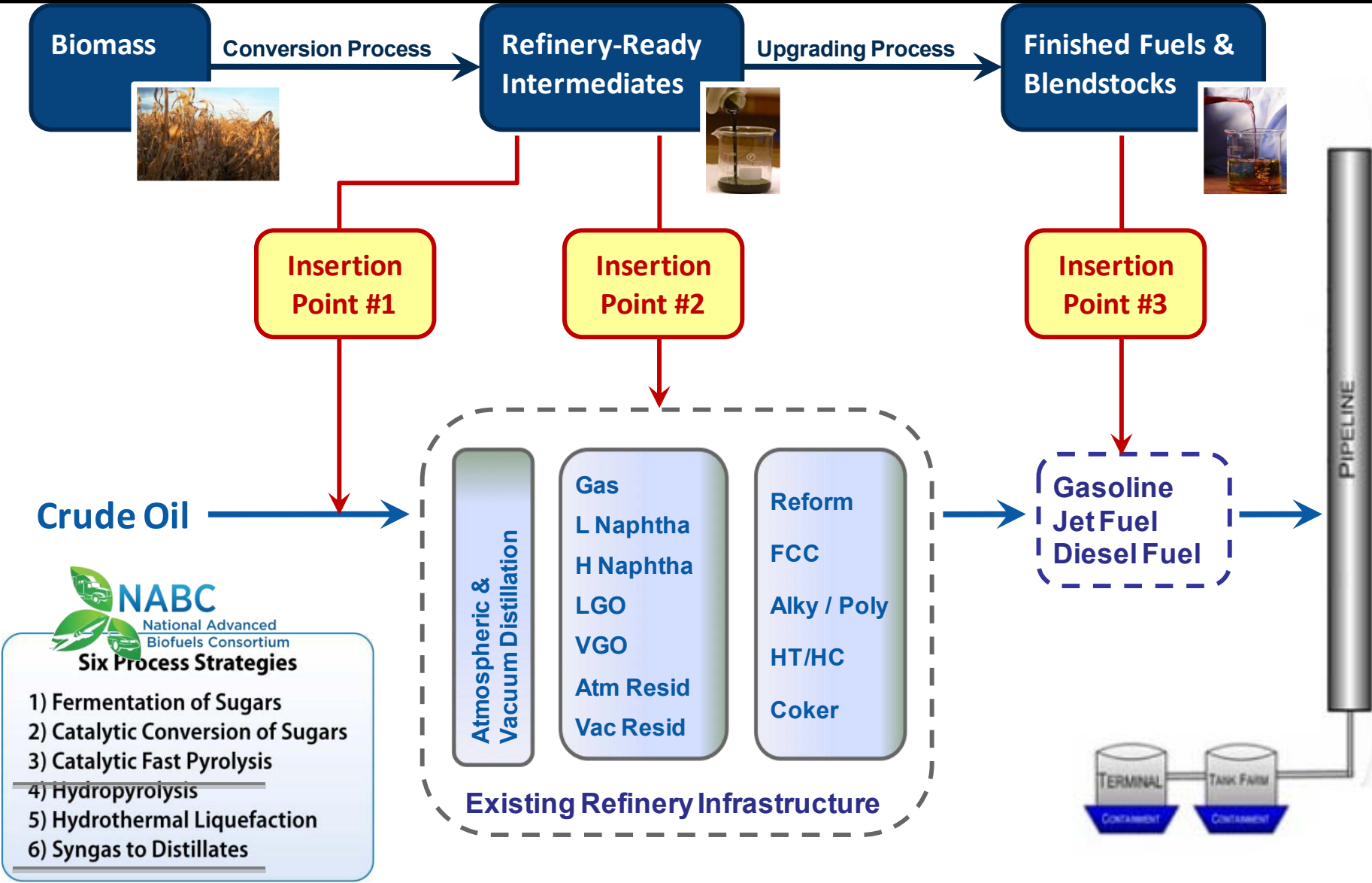

- 1) Fermentation of Sugars
- 2) Catalytic Conversion of Sugars
- 3) Catalytic Fast Pyrolysis
- 4) Hydropyrolysis
- 5) Hydrothermal Liquefaction
- 6) Syngas to Distillates

# Bulk Property Comparison

---

**Purpose:** Utilize NABC analysis results to characterize biomass-derived intermediates relative to typical petroleum refinery intermediates, blend stocks, and finished fuel blends.

## **Benefits:**

- Compare bulk properties of NABC products to those of refinery streams
- Determine theoretical hydrogen consumption (production) values
- Identify refinery integration strategies

**Note:** This analysis is based solely on bulk properties (boiling curves, gravities, overall elemental compositions) presented with the Stage 1 results.

# Intermediate / Product Comparison

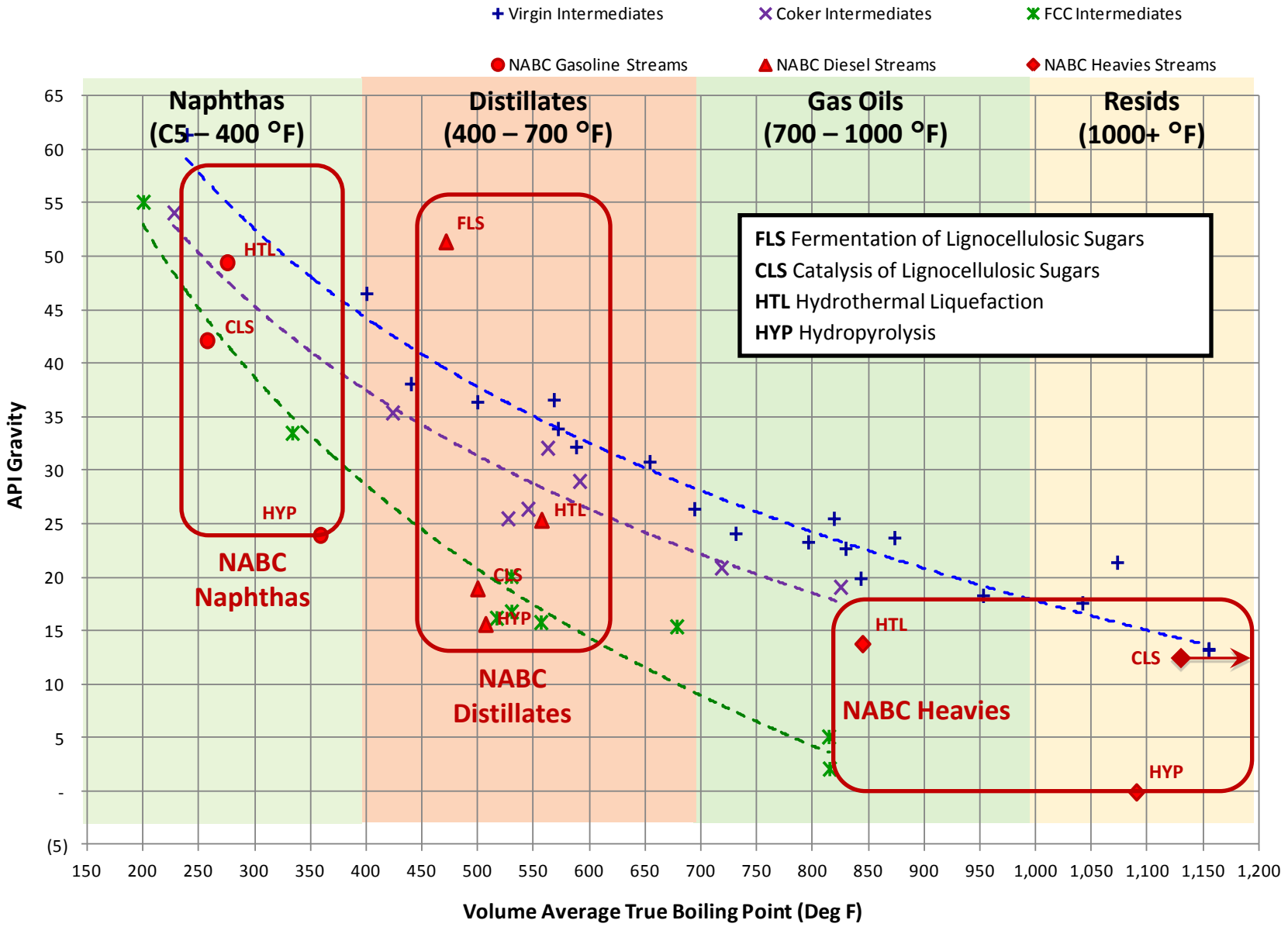

# Refinery Integration – Naphthas

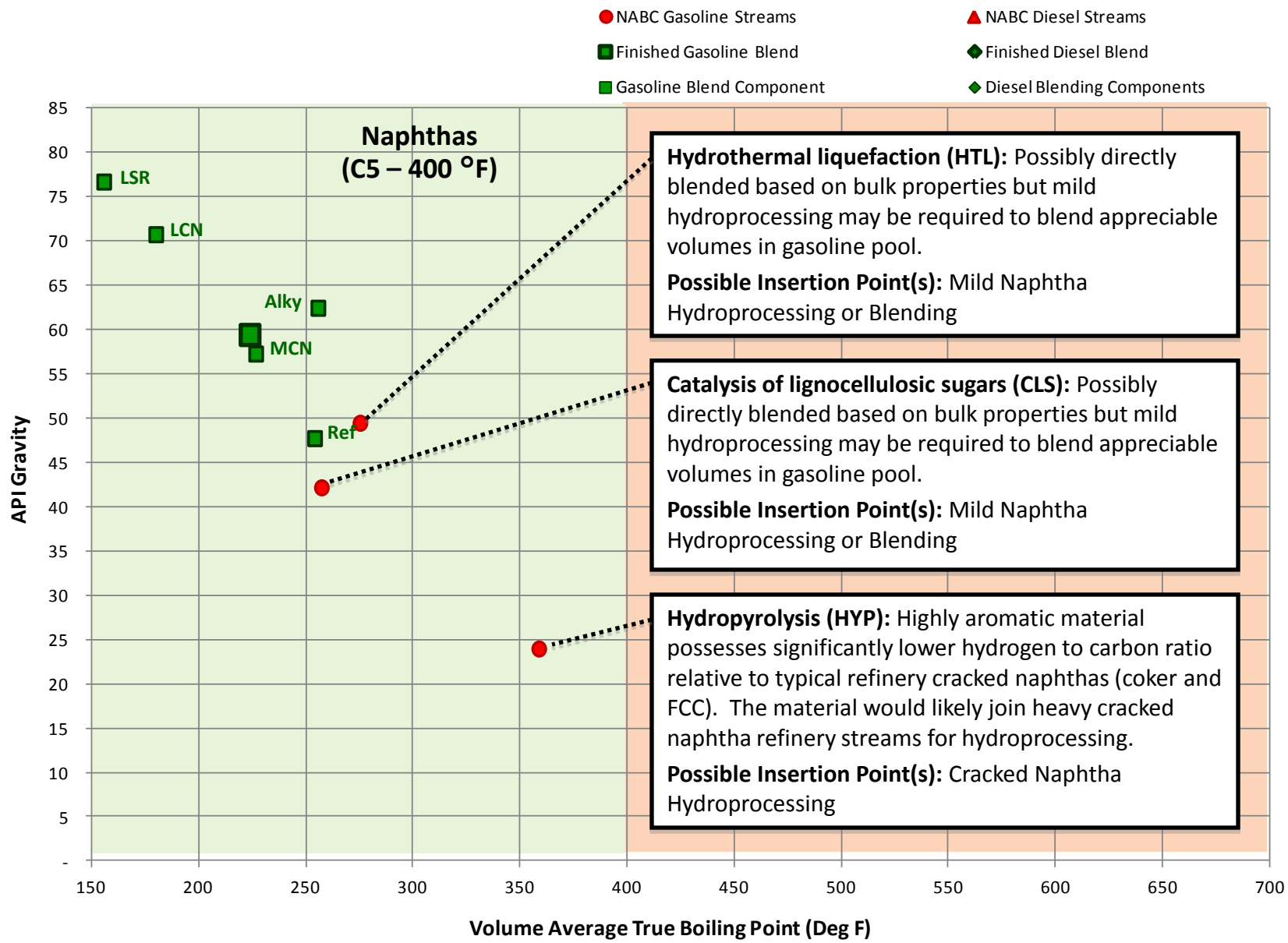

# Refinery Integration – Distillates

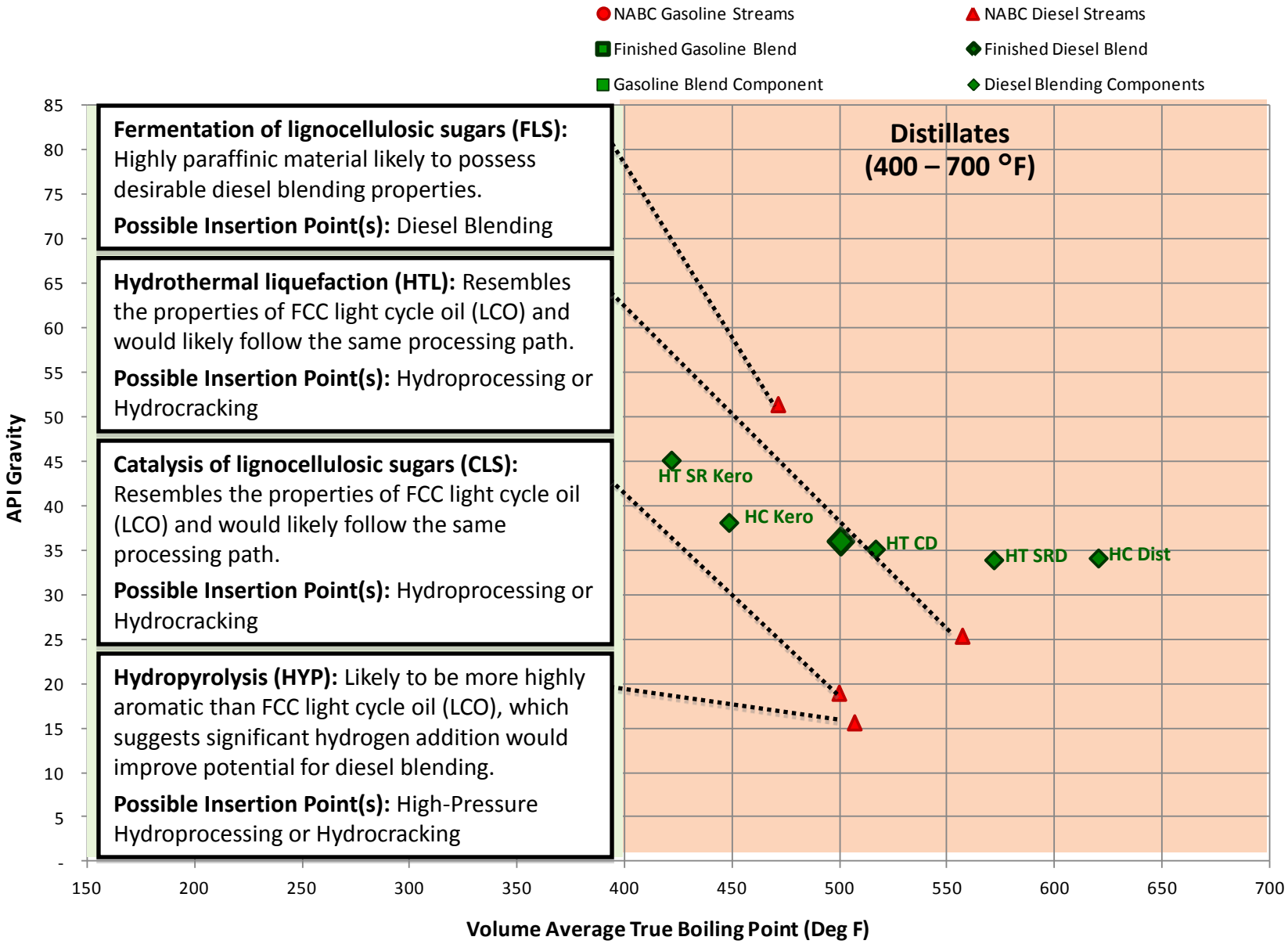

# NABC Blending Model

PIMS (Process Industry Modeling System) by

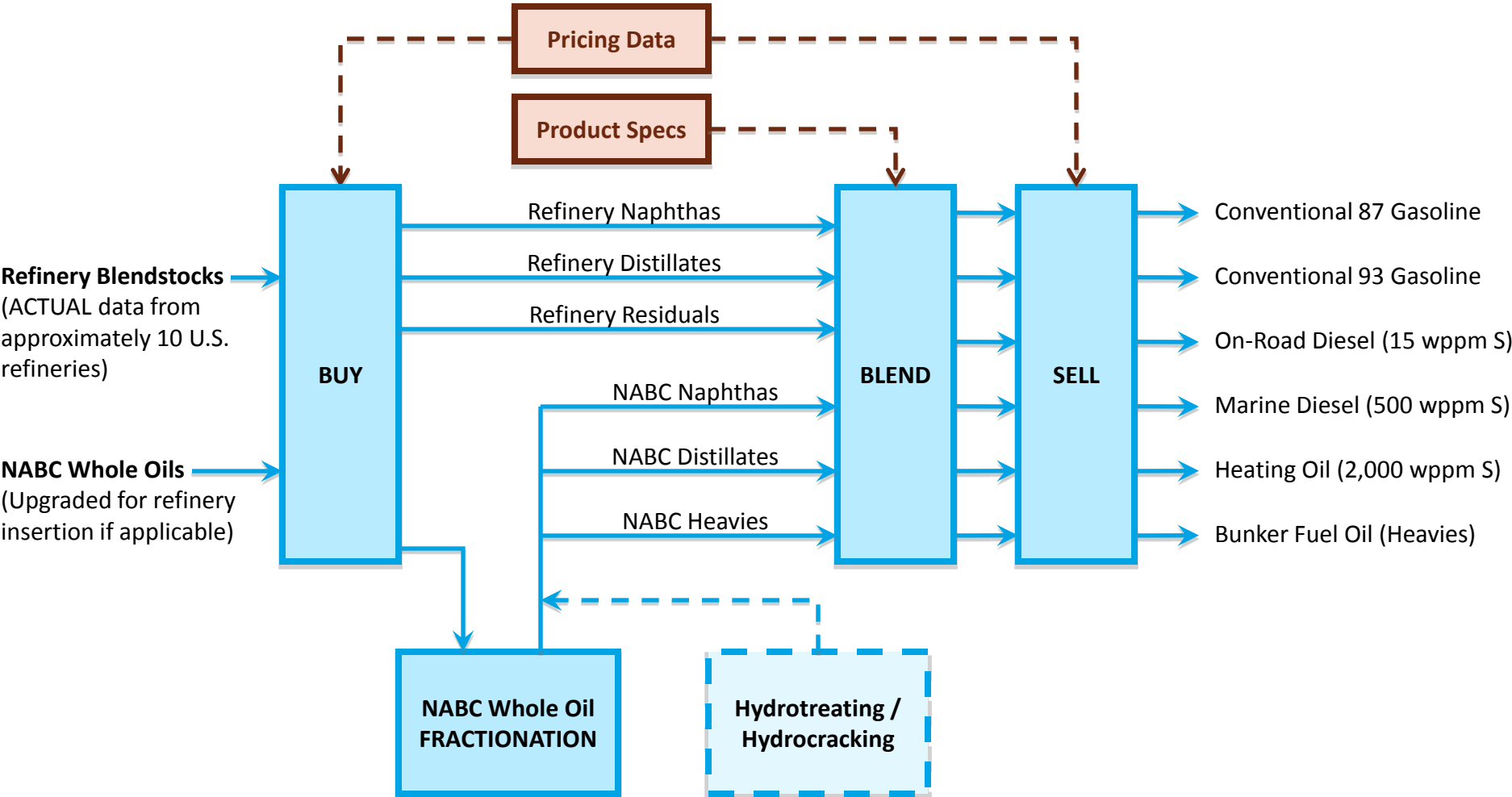

# Sustainability Research Platform - Status

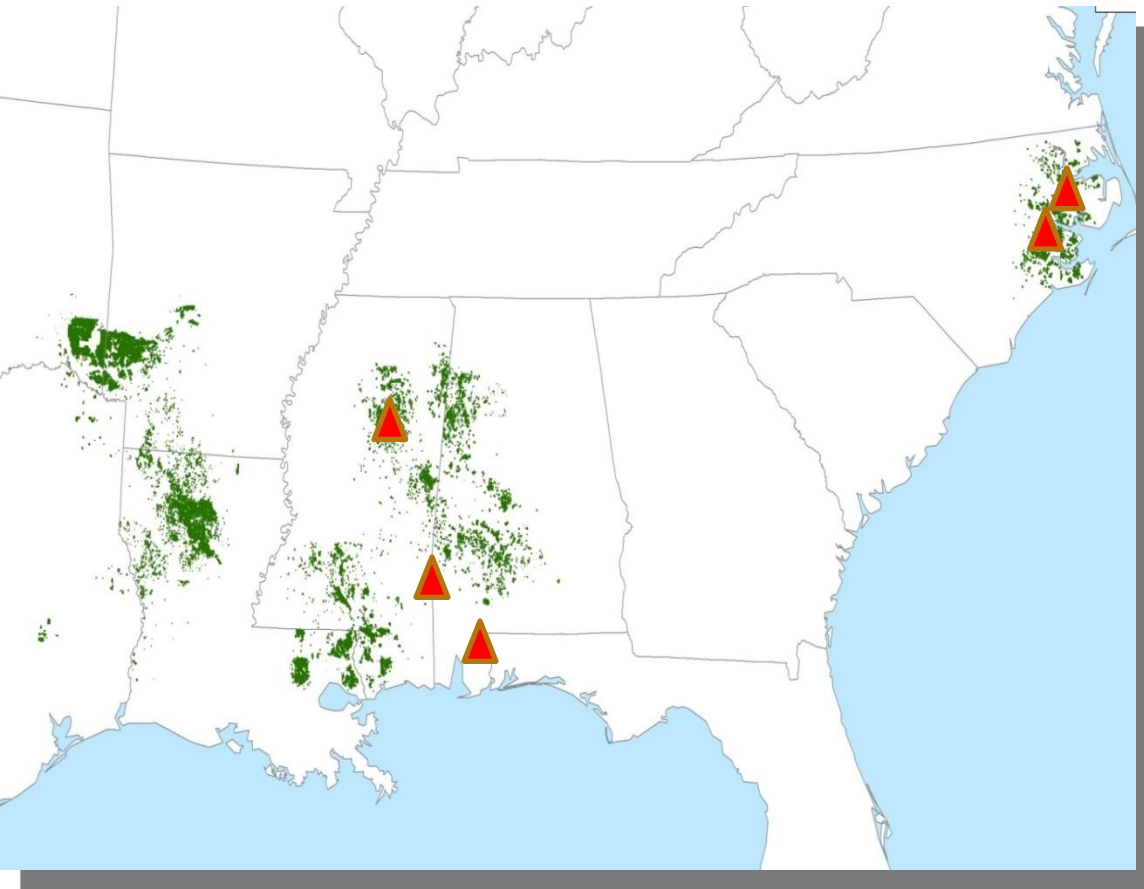

- **18 peer-reviewed publications**
- **65 abstracts and posters**
- **74 presentations at professional meetings**
- **15 “other” technical publications**



# Sustainability Status Projects

	<b>Biodiversity</b>	<b>Carbon</b>	<b>Soils</b>	<b>Water</b>
<b>MS Biodiversity Trials 2009-2015</b>	Small mammals, birds, plants, habitat structure, insects	N/A	Soil samples, pine/switchgrass productivity	N/A
<b>Lenoir 1 2009-2016</b>	Small mammals, reptiles, amphibians, fire ants, habitat structure, microinvertebrates	LCA, carbon storage, carbon cycling, GHG emissions	Soil processes & physical structure, nutrients, pine/switchgrass /miscanthus productivity, soil microbes, root structure	Plot level water quality/quantity, plant physiology
<b>Watershed study (AL, MS, NC) 2009-2016</b>	Vegetation structure	N/A	Soil physical properties	Multiple scales for water quality, water quantity, BMPs
<b>Life Cycle Analysis</b>	N/A	Bio-conversion work; EPA tree pathway	N/A	N/A

# NABC's Relevance to Biomass Program Goals

*“Enable the production of biofuels nationwide and reduce dependence on oil through creation of new domestic bioenergy industry supporting the EISA goal of 36 billion gallons per year of renewable transportation fuels by 2022.”*



**The NABC supports these Program Strategic & Performance Goals (Source: MYPP)**

## Conversion R&D

- Develop technologies to convert feedstocks to cost-competitive commodity liquid transportation fuels.
- Develop multiple conversion technologies due to broad range of feedstocks and their chemical and physical characteristics.
- Combined use of both TC and BC offers greatest opportunity for optimizing biomass conversion.
- **Develop targets for hydrocarbon fuels to support 2017 programmatic cost goals (Biochemical).**
- **By 2017, develop gas and diesel blendstocks at \$1.56/gal of total blendstock (Thermochemical)**

## Biofuels Distribution Infrastructure and End Use (for renewable hydrocarbon biofuels)

- Verify renewable hydrocarbon biofuel compatibility with the petroleum infrastructure and vehicles

## Bioenergy Market Expansion

- Streamline and increase the effectiveness of critical stakeholder partnerships

## Environmental and Economic Sustainability

- By 2022, evaluate and compare the sustainability of biofuel production pathways.

## Commercialization Plans

- IP Management Plan including Commercialization Council
- Technology providers collaborating with licensing and end use entities

# Products of NABC

---

- ▶ **The legacy of NABC will largely be measured by the reports that it publishes**
  - A report open to the public must reflect the \$50 M + effort of the consortium
  - The reports will be completed by 12/31/13, 3 months after R&D completion
  - Two levels of reports
    - NABC Member report – for member value – NABC only
    - NABC public report – NABC contract deliverable

# Summary

---

- **The NABC represents a change of thinking about what fuels we should be making from biomass — gasoline, diesel and jet fuels, and how we can use the infrastructure in place to make and deliver those fuels**
- **Two pilot ready technologies will be delivered at the conclusion of the project.**
- **Demonstrate feasibility of two promising technologies.**
- **Sustainability of Forest Products Residues assessment.**
- **Fundamentals and modeling effort making significant strides.**
- **Refinery integration effort drilling down into co-processing.**
- **65 peer-reviewed journal submissions to date.**
- **Numerous high impact public presentations.**
- **12 IP filings.**
- **Benefits of doing this work in a comprehensive consortium were significant.**

# Acknowledgements

- John Holladay – Chief Technology Officer
- Kelly Ibsen - Operations Manager



# NABC Publications

## Peer-Reviewed Journal Articles

- Homyack, J.; Aardweg, Z.; Gorman, T.; Chalcraft, D. **(2013)**. "Initial Effects of Biofuels Production on Abundance and Diversity of Herpetofauna in Eastern North Carolina." *Wildlife Society Bulletin* (DOI: 10.1002/wsb.248);
- Loman, Z.G.; Riffell, S.K.; Miller, D.A.; Martin, J.A.; Vilella, F.J. **(2013)**. "Site Preparation for Switchgrass Intercropping in Loblolly Pine Plantations Reduces Retained Trees and Snags, but Maintain Woody Debris." *Forestry: An International Journal of Forest Research* (doi:10.1093/forestry/cpt004);
- Karim, A.M.; Howard, C.; Roberts, B.; Kovarik, L.; Zhang, L.; King, D.L.; Wang, Y. **(2012)**. "In Situ X-ray Absorption Fine Structure Studies on the Effect of pH on Pt Electronic Density during Aqueous Phase Reforming of Glycerol." *ACS Catal.* (2 (11)); pp. 2387-2394.
- Wu, T.; Childers, D.J.; Gomez, C.; Ni, Z.; Karim, A.M.; Schweitzer, N.M.; Kropf, A.J.; Wang, H.; Bolin, T.B.; Hu, Y.; Kovarik, L.; Meyer, R.J.; Miller, J.T. **(2012)**. "General Method for Determination of the Surface Composition in Bimetallic Nanoparticle Catalysts from the L Edge X-ray Absorption Near-Edge Spectra." *ACS Catal.* (2 (11)); pp. 2433-2443.
- Nettles, J.E.; Leggett, Z.H. **(2012)**. "Extent and Distribution of Sustainable Intensive Forest Biofuel Practices." *Proceedings of the Sun Grant National Conference* (4.11.);
- Vinu, R.; Broadbelt, L.J. **(2012)**. "Unraveling Reaction Pathways and Specifying Reaction Kinetics for Complex Systems." *Annu. Rev. Chem. Biomol. Eng.* (3); pp. 29-54.
- Alexander, L.; Hoyt, Caroline; Michalczyk, R. W.; Wu, R.; Thorn, D.; Silks, C. H. **(2012)**. "Gram Scale Synthesis and Efficient Purification of 13C Labeled Levoglucosan from 13C Glucose." *Journal of Labeled Compounds and Radiopharmaceuticals* (56); pp. 27-29.
- Leggett, Z.H.; Sucre, E.B. **(2012)**. "Evaluating the Impact of Switchgrass Intercropping in Loblolly Pine Plantations on Long-term Soil Productivity." *Proceedings of the Sun Grant National Conference* (4.9); .
- Iglay, R.B.; Riffell, S.K.; Miller, D.A.; Leopold, B.D. **(2012)**. "Effects of Switchgrass Intercropping and Biomass Harvesting on Plant Communities in Intensively Managed Pine Stands." *Proceedings of the Sun Grant National Conference* (3.6.); .
- Tupy, S.A.; Karim, A.M.; Bagia, C.; Deng, W.; Huang, Y.; Vlachos, D.G.; Chen, J.G. **(2012)**. "Correlating Ethylene Glycol Reforming Activity with in situ EXAFS Detection of Ni Segregation in Supported NiPt Bimetallic Catalysts." *ACS Catal.* (2 (11)); pp. 2290-2296.
- Albaugh, J.M.; Sucre, E.B.; Leggett, Z.; Domec, J.C.; King, J.S. **(2012)**. "Evaluation of intercropped switchgrass establishment under a range of experimental site preparation treatments in a forested setting on the Lower Coastal Plain of North Carolina, U.S.A." *Biomass and Bioenergy* (46); pp. 673-682.
- Rana, D.; Rana, V.; Ahring, B.K. **(2012)**. "Producing high sugar concentrations from loblolly pine using wet explosion pretreatment." *Bioresour Technol.* (121); pp. 61-67.

# NABC Publications

## Peer-Reviewed Journal Articles

- Albaugh, J.M.; Domec, J.; Maier, C.A.; Sucre, E.B.; Leggett, Z.H.; King, J.S.; **(2012)**. "Water Relations and Productivity in an Intercropped Pine-switchgrass Study Examining Biofuel Production in North Carolina, USA." *Proceedings of the Sun Grant National Conference* (3.5.); .
- Blazier, M.A.; Sucre, E.B.; Leggett, Z.; Vance, E.D. **(2012)**. "Loblolly Pine Age and Density Affects Switchgrass Growth and Soil Carbon in an Agroforestry System." *Forest Science* (58 (5)); pp. 485-496.
- Vinu, R.; Broadbelt, L.J. **(2012)**. "A Mechanistic Model of Fast Pyrolysis of Glucose-Based Carbohydrates to Predict Bio oil Composition." *Energy Environ. Sci.* (5); pp. 9808-9826.
- Zhu, Y; Jones, S.B.; Bidy, M.J.; Dagle, R.A.; and Palo, D.R. **(2012)**. "Single Step Syngas to Distillates (S2D) Process Based on Biomass-Derived Syngas A Techno Economic Analysis." *Bioresour Technol.* (117); pp. 341-351.
- Lebarbier, V.M.C; Dagle, R.A.; Kovarik, L.; Lizarazo Adarme, J.A.; King, D.L.; and Palo, D.R. **(2012)**. "Synthesis of Methanol and Dimethyl Ether from Syngas over Pd/ZnO/Al<sub>2</sub>O<sub>3</sub> Catalysts." *Catal. Sci. Technol.* (2); PP. 2116-2127.
- Mei, D.; Karim, A.M.; Wang, Y. **(2012)**. "On the Reaction Mechanism of Acetalkdehyde Decomposition on Mo(110)." *ACS Catal.* (2); pp. 468-478.
- Mayes, H.; Broadbelt, L. **(2012)**. "Unraveling the Reactions that Unravel Cellulose." *J. Phys. Chem.* (116); pp. 7098-7106.
- Marshall, M.; Lucia, K.E.; Homyack, J.; Miller, D.A.; Kalcounis-Rüepell, M. **(2012)**. "Effect of Removal of Woody Biomass after Clearcutting and Intercropping Switchgrass (*Panicum virgatum*) with Loblolly Pine (*Pinus taeda*) on Rodent Diversity and Populations." *International Journal of Forestry Research* (2012); pp. 1-11.
- Nettles, J.; Youssef, M.; Cacho, J.; Grace, J.; Leggett, Z.; Sucre, E. **(2011)**. "The water quality and quantity effects of biofuel operations in pine plantations of the southeastern US." *IAHS Press* (IAHS Publication 348); pp. 115-122.
- Parthasarathi, R.; Romero, R.A.; Redondo, A.; Gnanakaran, S. **(2011)**. "Theoretical Study of the Remarkably Diverse Linkages in Lignin." *J. Phys. Chem. Lett* (2 (20)); pp. 2660-2666.
- Chundawat, S.P.S.\*; Beckham, G.T.\*; Himmel, M.E.; Dale, B.E. **(2011)**. "Deconstruction of Lignocellulosic Biomass to Fuels and Chemicals." *Ann. Rev. Chem. Biomolec. Eng.* (2); pp. 121-145.
- Jarvis, M.W.; Daily, J.W.; Carstensen, H.H.; Dean, A.M.; Sharma, S.; Dayton, D.C.; Robichaud, D.J.; Nimlos, M.R. **(2011)**. "Direct Detection of Products from the Pyrolysis of 2 Phenethyl Phenyl Ether." *J. Phys. Chem. A* (115); pp. 428-438.
- Xu, C.; Shoaibi, A.A.; Wang, C.; Carstensen, H.H.; Dean, A.M. **(2011)**. "Kinetic Modeling of Ethane Pyrolysis at High Conversion." *J. Phys. Chem. A* (115 (38)); pp. 10470-10490.

# NABC Publications

## Peer-Reviewed Journal Articles

- Parthasarathi, R.; Bellesia, G.; Chundawat, S. P. S.; Dale, B. E.; Langan, P.; Gnanakaran, S. (2011). "Insights into Hydrogen Bonding and Stacking Interactions in Cellulose." *J. Phys. Chem. A* (115 (49)); pp. 14191-14202.
- Skaggs, R.W.; Chescheir, G.M.; Diggs, J.; Amatya, D.M. (2011). "Effects of Land Use on the Hydrology of Drained Coastal Plain Watersheds." *Trans of ASABE* (54 (4)); pp. 1357-1365.
- Kim, S.; Chmely, S.C.; Nimlos, M.R.; Bomble, Y.J.; Foust, T.D.; Paton, R.S.; Beckham, G.T. (2011). "Computational Study of Bond Dissociation Enthalpies for a Large Range of Native and Modified Lignins." *J. Phys. Chem. Lett* (2 (22)); pp. 2846-5852.
- Mei, D.; Karim, A.M.; Wang, Y. (2011). "Density functional theory study of acetaldehyde hydrodeoxygenation on MoO<sub>3</sub>." *J. Phys. Chem. C* (115:16); pp. 8155-8164.
- Beauvais, C. (2010). "Coarse woody debris in a loblolly pine plantation managed for biofuel production. Thesis.." *Duke University* (Thesis); .
- Appelboom, T.W.; Chescheir, G.M.; Birgand, F.; Skaggs, R.W.; Gilliam, J.W.; Amatya, D. (2010). "Temperature Coefficient for Modeling Denitrification in Surface Water Sediments Using the Mass Transfer Coefficient." *American Society of Agricultural and Biological Engineers* (53 (2)); pp. 465-474.

## Peer-Reviewed Journal Articles In preparation

- Karim, A.M.; Wang, Y. "Catalytic Fast Pyrolysis: A review." In Preparation
- Mei, D.; Karim, A.M.; Lebarbier, V.; Liu, C.; Wang, Y. "Ketonization of Acetic Acid on CeO<sub>2</sub> Based Mixed Oxides: An Experimental and DFT Study." In Preparation
- Tian, J.; Mayes, H.B.; Broadbelt, L.J.; Gnanakaran, S.. "Sodium-glucose Interactions Investigated by QM and MD." In Preparation
- Mei, D.; Karim, A.M.; Wang, Y. "Acetaldehyde Hydrodeoxygenation on Mo: A Density Functional Theory Study." In Preparation
- Sucre, E.B.; Leggett, Z.H.. "Impacts of managing loblolly pine plantations for biofuels production on soil compaction." In Preparation
- Karim, A.M.; Sun, J.; Li, X.; Shin, Y.; Kovarik, L.; Wang, Y.,. "Hierarchical bi-functional catalyst for the conversion of biomass to liquid fuel." In Review
- Sun, J.; Karim, A.M.; Zhang, H.; Kovarik, L.; Wei, Z.; Wang, Y. "Vapor Phase Deoxygenation of Guaiacol Over Carbon Supported Metal Catalysts." In Review
- Breland, K.L.; Fischer, R.; Thancker, R.; Davis, B.,. "Niche Overlap of White-footed Mice and House Mice in an Intercropped Switchgrass-pine System." In Review
- Briones, K.J.; Homyack, J.A.; Miller, D.A.; Kalcounis-Rueppell, M.. "Effects of Intercropping Switchgrass (*Panicum virgatum*) with Loblolly Pine (*Pinus taeda*) on functional role of *Peromyscus leucopus*." In Review



# NABC Publications (cont'd)

- Albaugh, J.M.; Domec, J.; Maier, C.A.; Sucre, E.B.; Leggett, Z.H.; King, J.S.;. "Switchgrass Gas Exchange and Stand-level Estimates of Water Use and Gross Primary Productivity in an Experimental Intercropped Forestry System on the Lower Coastal Plain of North Carolina, U.S.A.." In Review
- Liu, C.; Karim, A.M.; Lebarbier, V.M.; Mei, D.; Wang, Y.. "Vapor Phase Ketonization of Acetic Acid on Ceria Based Metal Oxides." Accepted
- Foust, T.D.. "Partnerships, Future and Emerging Technologies, in Industrial Crops: Breeding for Bioenergy and Bioproducts." in press
- Zhu, Y.; Bidy, M.J.; Jones, S.B.; Elliott, D.C.; Schmidt, A.J.. "Gasoline and Diesel Production from Woody Biomass via Hydrothermal Liquefaction (HTL) and Upgrading – A Techno-Economic Analysis based on Experimental Tests." Submitted
- Mayes, H.B.; Broadbelt, L.J.; Beckham, G.T.. "Mapping the Kinetic Landscape of Sugar Puckering: Implications for Enzyme Action." In Preparation

## Technical Reports

- Pacific Northwest National Laboratory (November 2012). Review and Assessment of Commercial Vendors/Options for Feeding and Pumping Biomass Slurries for Hydrothermal Liquefaction.
- CatchLight Energy (October 2011). Catchlight Energy's Environmental Sustainability Program - NABC Stage I Report.
- Pacific Northwest National Laboratory (September 2012). Mid Stage 2 Report on the Hydrothermal Liquefaction Strategy for the NABC Leadership Team.

# NABC Publications (cont'd)

## Conference and Meeting Presentations

- Breland, K.L.; Fischer, R.; Thancker, R.; Davis, B.; (March 2013). "Effects of Loblolly Pine (*Pinus Taeda*) and Switchgrass (*Panicum Vigatum*) Intercropping Forestry Techniques on Intermittent Stream Macroinvertebrate Communities." Presented at Alabama Academy of Science; Samford University, Birmingham, AL, March 20-22, 2013.
- Sommariva, S.; Dean, A.M. (March 2013). "Gas Phase Radical Chemistry and its Impact on Lignin Model Compound Reactivity." Presented at 3rd North American Symposium on Chemical Reaction Engineering, Houston, TX, March 17-20, 2013.
- Nichols, L.K.; Strahm, B.D.; Fox, T.R.; Seiler, J.R.; Sucre, E.B.; Leggett, Z.H. (March 2013). "The Impact of Dissolved Organic Carbon on Microbial Biomass and Activity in a Loblolly Pine and Switchgrass Intercropped System." Presented at 17th Biennial Southern Silvicultural Research Conference, Shreveport, LA, March 5-7, 2013.
- Shrestha, P.; Seiler, J.R.; Strahm, B.D.; Fox, T.R.; Sucre, E.B. (March 2013). "Soil CO<sub>2</sub>, CH<sub>4</sub>, N<sub>2</sub>O Fluxes in a Switchgrass and Loblolly Pine Intercropping System." Presented at 17th Biennial Southern Silvicultural Research Conference, Shreveport, LA, March 5-7, 2013.
- Wichmann, G.A.; Wenger, J.W.; Snydsman, M.E.; Bellissimi, E. (January 2013). "Update on FLS Strategy." Presented at NABC Annual Meeting, Phoenix AZ, January 17-18, 2013.
- Brantley, J.D. (January 2013). "Crossflow Filtration of Deconstructed Biomass." Presented at NABC Annual Meeting, Phoenix, AZ, January 17-18, 2013.
- Matteson, A.; Homyack, J.A.; Wigley, T.B.; Miller, D.A.; Kalcounis-Rueppel, M.; (February 2013). "Influence of Intercropping Switchgrass in Intensively Managed Pine Forests on Ultrasound Production by Bats and Rodents." Presented at 23rd Colloquium on the Conservation for Mammals in the Southeastern US, Pikeville, TN, February 14, 2013.
- Mayes, H.B.; Broadbelt, L.J.; Beckham, G.T. (February 2013). "Mapping Sugars Along Catalytic Itineraries: A Case Study in Exploring Multi-dimensional Landscapes." Presented at Computational Science Graduate Fellowship Program Showcase at the SIAM Conference on Computational Science and Engineering, Boston, MA, February 25 - March 1, 2013. *Invited talk*
- King, K.; Homyack, J.A.; Wigley, T.B.; Miller, D.A.; Kalcounis-Rueppel, M. (February 2013). "Effects of Intercropping Switchgrass (*Panicum virgatum*) and Loblolly Pine (*Pinus taeda*) on the Rodent Community and Population Dynamics." Presented at 23rd Colloquium on the Conservation for Mammals in the Southeastern US, Pikeville, TN, February 15, 2013.
- Homyack, J.A.; Lucia, K.; Miller, D.A.; Kalcounis-Rueppel, M.; (February 2013). "Native and Invasive Mouse Interactions in a Pine Plantation Managed for Biofuels Production." Presented at Annual Meeting of the North Carolina Chapter of the Wildlife Society, Columbia, NC, February 26, 2013.

# NABC Publications (cont'd)

- Foust, T.D. (April 2013). "National Advanced Biofuels Consortium Overview." Presented at 35th Symposium on Biotechnology for Fuels and Chemicals, Portland, OR, April 29-May 2, 2013.
- Sommariva, S.; Dean, A.M. (April 2013). "Gas-phase Pyrolysis Kinetics of 2-phenoxy-1-phenylethanol, a Lignin Model Compound." Presented at ACS National Spring Meeting, New Orleans, LA, April 7-11, 2013. *Presentation*
- Mayes, H.B.; Broadbelt, L.J.; Beckham, G.T. (September 2012). "Elucidating Enzymatic Routes to Biomass Deconstruction: Quantifying Method Accuracy for Mapping Glycosidic Hydrolase Catalytic Itineraries." Presented at PASI: Molecular-based Multiscale Modeling and Simulation Workshop, Montevideo, Uruguay, September 2-15, 2012. *Awarded best poster*
- Carpenter, J.R.; Farmer, J.; Song, H.; Dayton, D. (October 2012). "Hydropyrolysis of Loblolly Pine to Produce a Low-oxygen Pyrolysis Oil." Presented at 2012 AIChE Annual Meeting, Pittsburgh, PA, October 28 - November 2, 2012.
- Wenger, J.W.; Wichmann, G.A.; Saija, P.R.; Kim, J. J. (October 2012). "Metabolic Engineering of *S. cerevisiae* to Produce Advanced Biofuels from Cellulosic Feedstocks." Presented at Bay Area Yeast Meeting, Berkeley, CA, October 27, 2012.
- Beckham, G.T. (October 2012). "Computational Modeling of Biomass in Conversion Systems." Presented at Frontiers in Biorefining, St. Simons Island, GA, October 30 - November 2, 2012. *Oral presentation*
- Shanks, B.H. (May 2012). "Biofuels: Challenges and Opportunities." Presented at Council for Chemical Research, Dearborn, MI, May 22, 2012.
- Sturgeon, M.; Kim, S.; Chmely, S.C.; Katahira, R.; Foust, T.D.; Beckham, G.T. (March 2012). "Experimental study of mechanistic acid deconstruction of lignin." Presented at 243rd ACS Spring National Meeting, San Diego, CA, March 25-29, 2012.
- Mayes, H.B.; Broadbelt, L.J. (March 2012). "Unraveling the reactions which unravel cellulose." Presented at 243rd ACS Spring National Meeting, San Diego, CA, March 25-29, 2012.
- Shanks, B.H. (June 2012). "Thermochemical Biofuels: Challenges and Opportunities." Presented at Auburn University Lecture, Auburn, AL, June 14, 2012.
- Wichmann, G.A.; Wenger, J.W.; Saija, P.R.; Kim, J.J., (January 2012). "Update on FLS Strategy." Presented at NABC Annual Meeting, Phoenix AZ, January 16-17, 2012.
- D. Denton (January 2012). "Update on Hydropyrolysis." Presented at NABC Annual Meeting, Phoenix, AZ, January 17-18, 2012.
- Shanks, B.H. (August 2012). "Thermal Deconstruction of Lignocellulosic Biomass." Presented at ACS National Meeting, Philadelphia, PA, August 20, 2012. *Symposium in Honor of Eli Ruckenstein*
- Sturgeon, M.R.; Kim, S.; Chmely, S.C.; Foust, T.D.; Beckham, G.T. (August 2012). "Kinetic study of the acid degradation of lignin model compound intermediates." Presented at 244th ACS Fall National Meeting, Philadelphia, PA, August 19-23, 2012.

# NABC Publications (cont'd)

- Mayes, H.B.; Zhang, J.; Shanks, B.H.; Broadbelt, L.J. (August 2012). "Sodium-Mediated Glucose Pyrolysis: Experimental Results and Mechanistic Dehydration Study." Presented at American Chemical Society Fall 2012 National Meeting & Exposition, Philadelphia, PA, August 19-23, 2012. *Oral presentation*
- Wichmann, G.A.; Wenger, J.W.; Saija, P.R.; Kim, J. J. (August 2012). "Metabolic Engineering of *S. cerevisiae* to Produce Advanced Biofuels from Cellulosic Feedstocks." Presented at 13th International Congress on Yeasts, Madison WI, August 26-30, 2012.
- Sturgeon, M.R.; Kim, S.; Chmely, S.C.; Foust, T.D.; Beckham, G.T. (August 2012). "Mechanistic study of the acid degradation of lignin model compounds." Presented at 244th ACS Fall National Meeting, Philadelphia, PA, August 19-23, 2012. *Oral presentation*.
- Wenger, J.W.; Wichmann, G.A; Snydsman, M.E.; Attfeld, P. V.; Bell, P.J. (April 2012). "Genetic Analysis of Natural, Xylose-Utilizing *S. cerevisiae* for Advanced Biofuel Production." Presented at 34th Symposium on Biotechnology for Fuels and Chemicals, New Orleans, LA, April 30 - May 3, 2012. *Poster Presentation*
- Bai, X.; Johnston, P.; Sadula, S; Dalluge, D.; Brown, R.C. (September 2011). "The role of levoglucosan physiochemistry on cellulose pyrolysis." Presented at tcbiomass2011: The International Conference on Thermochemical Conversion Science, Chicago, IL, September 28-30, 2011.
- Elliott, D.C.; Neuenschwander, G.; Hart, T. (September 2011). "Bio-oil Upgrading by Catalytic Hydroprocessing in a Fixed-bed Reactor." Presented at tcbiomass2011: The International Conference on Thermochemical Conversion Science, Chicago, IL, September 28-30, 2011.
- Nettles, J.; Youssef, M.; Cacho, J. (September 2011). "Evaluating the field-scale water use of cellulosic biofuel crops." Presented at IUFRO (International Union of Forest Research Organizations) Forest Landscapes and Global Change, Braganza, Portugal, September 21-27, 2010.
- Foust, T.D. (September 2011). "Overview of Conversion Technologies for Converting Biomass to Liquid Hydrocarbon Fuels." Presented at ACS Council for Chemical Research, Newark, DE, September 21, 2011.
- Foust, T.D. (September 2011). "Converting Biomass to Liquid Hydrocarbon Fuels." Presented at Catalysis and Alternative Feedstocks Workshop- ACS Council for Chemical Research, Newark, DE, September 21-22, 2011.
- Ibsen, K. (September 2011). "The Future of Transportation Fuels in the US." Presented at Hart Energy Conference: The Future of Transportation Fuels in the U.S., Washington DC, September 21, 2011. *Represented the NABC on a panel for the Hart Energy Conference, September 21, 2011 in Washington DC. The panel discussed the outlook for first-generation and advanced biofuels use in transportation fuels.*
- Nettles, J.; Leggett, Z.; Grace, J. (September 2011). "Water Yield Effects of Biofuel Intercropping in Loblolly Pine Plantations of the Southeastern US." Presented at American Fisheries Society Annual Meeting, Seattle, WA, September 4-8, 2011.

# NABC Publications (cont'd)

- Holladay, J.E. (September 2011). "Bio-oil Upgrading by Catalytic Hydroprocessing in a Fixed-Bed Reactor." Presented at tcbiomass2011: The International Conference on Thermochemical Conversion Science, Chicago, IL, September 28-30, 2011. *Poster with NABC data and acknowledgement*
- Brown, R.C. (September 2011). "Prospects for a Thermolytic Sugars Platform.." Presented at tcbiomass2011: The International Conference on Thermochemical Conversion Science, Chicago, IL, September 28-30, 2011.
- Mayes, H.; Ravikrishnan, V.; Broadbelt, L.J. (September 2011). "Ab Initio Calculations to Determine Cellulose Fast Pyrolysis Reaction Mechanisms." Presented at tcbiomass2011: The International Conference on Thermochemical Conversion Science, Chicago, IL, September 28-30, 2011.
- Holladay, J.E. (September 2011). "Advanced Biofuels." Presented at Washington State University Graduate Seminar Series, Richland, WA, September 9, 2011.
- Ravikrishnan, V.; Broadbelt, L.J. (September 2011). "Mechanistic Modeling of Fast Pyrolysis of Cellulose to Predict Bio-oil Composition." Presented at 2011 AIChE Annual Meeting, Minneapolis, MN, October 16–21, 2011.
- Foust, T.D. (September 2011). "Advanced 'Drop-In' Biofuels." Presented at Rethinking Energy and Climate Strategies for Transportation – Thirteenth Biennial Conference on Transportation and Energy, Pacific Grove, CA, August 29 - September 1, 2011.
- Mayes, H.; Ravikrishnan, V.; Broadbelt, L.J. (September 2011). "Computational Chemistry to Elucidate Cellulose Fast Pyrolysis Reaction Mechanisms." Presented at Fall Creek Falls Conference on Computing and Computational Sciences, Gatlinburg, TN, September 14-16, 2011.
- Brown R.C. (October 2011). "Pyrolytic pathways to advanced biofuels, Sustainable Biorefineries." Presented at AIChE Annual Meeting, Minneapolis, MN, October 16-21, 2011. *Plenary session*
- Sucre, E.B.; Leggett, Z.H. (October 2011). "Effects of pine-switchgrass system on tree productivity, nutrients and carbon cycling." Presented at 2011 Society of American Foresters National Convention, Honolulu, HI, November 2-6, 2011.
- Minick, K.J.; Strahm, B.D.; Fox, T. R.; Sucre, E.B.; Leggett, Z.H.; Zerpa, J.L. (October 2011). "Temporal Patterns of Soil Nutrient Availability In Southern Loblolly Pine Forests Intercropped with Switchgrass." Presented at 2011 Soil Science Society of America Meeting, San Antonio, TX, October 16-19, 2011.
- Fu, J.; Hakim, S.H.; Shanks, B.H. (October 2011). "Aqueous-Phase Reforming of Bio-Oil Model Compounds Over Pt-Re/C." Presented at Annual Meeting, American Institute of Chemical Engineers, Minneapolis, MN, October 16-21, 2011.
- Sucre, E.B.; Leggett, Z.H. (October 2011). "Weyerhaeuser & Catchlight Energy Bioenergy/Biofuel Opportunities for Loblolly Pine Plantation Forestry: A Multi-Faceted Approach." Presented at 2011 Society of American Foresters National Convention, Honolulu, HI, November 2-6, 2011.

# NABC Publications (cont'd)

- Foust, T.D. (October 2011). "Realizing the Potential of Advanced Biofuels." Presented at AIChE Annual Meeting, Minneapolis, MN, October 16-21, 2011. *Sustainable Biorefineries Plenary Session*
- Brown, R.C. (November 2011). "Pyrolysis." Presented at ASME 2011 International Mechanical Engineering Congress & Exposition, Denver, CO, November 11-17, 2011.
- Brown, R.C. (November 2011). "Pyrolysis energy systems." Presented at ASME 2011 International Mechanical Engineering Congress & Exposition, Denver, CO, November 11-17, 2011.
- Marshall, M.M.; Briones, K.M.; Homyack, J.A.; Miller, D.A.; Kalcounis-Rüppell, M.C. (November 2011). "Influence of biomass removal and switchgrass intercropping in a southern pine plantation on rodent diversity, abundance, trophic position and diet." Presented at The Wildlife Society Annual Meeting, Kona, HI, November 5-10, 2011.
- Parthasarathi, R.; Bellesia, G.; Langan, P.; Gnanakaran, S. (May 2011). "Theoretical Insights into the Nature of Intermolecular Interactions in Cellulose." Presented at SIM-33rd symposium on biotechnology for fuels and che
- Brown, R.C. (May 2011). "Generation of Thermochemical Intermediates Suitable for Catalytic Upgrading." Presented at U.S. DOE and USDA Joint Biomass Research and Development Technical Advisory Committee, Arlington, VA, May 19-20, 2011.
- Horstman, M.; Allen, E.; Birgand, F.; Harris, P. (March 2011). "The Evaluation of a Combined Multiplexer Pumping System and Water Quality Probe for Use as a Portable Water Quality Lab." Presented at Annual NC WRRRI conference, Raleigh, NC, March 27-29, 2011., Seattle, WA, May 2-5, 2011.
- Pease, J.; O. 'Neill, K.; Godwin, H.W.; Leggett, Z.; Sucre, E. (March 2011). "Microinvertebrate Assessment in Loblolly Pine Plantations Managed for Biofuels." Presented at Roanoke College's Conference on Student Research and Creativity, Roanoke, VA, March 19, 2011.
- Minick, K.J.; Strahm, B.D.; Fox, T.R.; Sucre, E.B.; Leggett, Z.H.; Zerpa, J.L. (March 2011). "Bioenergy Production In Intensively Managed Loblolly Pine Plantations Alters Soil Chemical and Physical Properties." Presented at 2011 Department of Forest Resources and Environmental Conservation Symposium, Blacksburg, VA, March, 2011. *Poster*
- Ravikrishnan, V.; Broadbelt, L.J. (March 2011). "Development of Detailed Reaction Kinetic Model for Cellulose Fast Pyrolysis." Presented at AIChE Spring Meeting, Chicago, IL, March 13-17, 2011.
- Chescheir, G.M.; Birgand, F.; Youssef, M.A.; Skaggs, R.W.; Nettles, J. (March 2011). "Hydrology and water quality impacts of biofuel feedstock production on forestry lands." Presented at Annual NC WRRRI conference, Raleigh, NC, March 27-29, 2011.
- Etheridge, J.R.; Burchell II, M.R.; Birgand, F. (March 2011). "Continuously monitoring flow, carbon, and nitrogen in a restored North Carolina salt marsh." Presented at Annual NC WRRRI conference, Raleigh, NC, March 27-29, 2011.

# NABC Publications (cont'd)

- Parthasarathi, R.; Bellesia, G.; Langan, P.; Gnanakaran, S. (March 2011). "Theoretical insights into the nature of intermolecular interactions in cellobiose dimer." Presented at 241st ACS National Meeting & Exposition, Anaheim, CA, March 27-31, 2011.
- Holladay, J.E. (June 2011). "Approaches to produce Hydrocarbon Fuels from Biomass." Presented at Engine Research Center Conference, University of Wisconsin-Madison, June 8-9, 2011.
- Albaugh, J.M.; King, J.S.; Sucre, E.B.; Leggett, Z. (June 2011). "Switchgrass establishment success and photosynthetic performance in an intercropped forestry system on the Lower Coastal Plain of North Carolina." Presented at North American Agroforestry Conference, Atlanta, GA, June 4-9, 2011.
- Blazier, M.A.; Clason, T.R.; Vance, E.D.; Sucre, E.; Leggett, Z. (June 2011). "Influence of Establishing Switchgrass-Loblolly Pine Alley Cropping Systems in Louisiana and North Carolina on Soil Sustainability." Presented at North American Agroforestry Conference, Atlanta, GA, June 4-9, 2011. *Poster*
- Briones, K.; Homyack, M.J.A.; Miller, D.A.; Kalcounis-Rüepell, M.C. (March 2011). "Effects if intercropping switchgrass and loblolly pine on the diet and trophic position of *Peromyscus leucopus*." Presented at North Carolina Academy of Sciences, Raleigh, NC, March 2011.
- Sucre, E.; Leggett, Z.; Homyack, J.; Nettles, J.; Miller, D. (June 2011). "Impacts of managing loblolly pine plantations intercropped with switchgrass for biofuel production on long-term site productivity, carbon and nutrient cycling, water quality, and wildlife." Presented at North American Forest Ecology Workshop 8:74, Roanoke, VA, June 19-23, 2011.
- Nettles, J.; Skaggs, W.; Amatya, D.; Chescheir, G. (June 2011). "The effects of silvicultural and biofuel operations on water quality and quantity: Long term experimental watershed studies in poorly drained pine plantations, North Carolina, US." Presented at IUGG 2011, Earth on the Edge, Science for a Sustainable Planet, Melbourne Australia, June 28 - July 7, 2011.
- Nettles, J.; Youssef, M.; Cacho, J.; Grace, J.; Leggett, Z.; Sucre, E. (June 2011). "The water quality and quantity effects of biofuel operations in pine plantations of the southeastern US." Presented at IUGG 2011, Earth on the Edge, Science for a Sustainable Planet, Melbourne Australia, June 28 - July 7, 2011.
- Miller, D.A. (June 2011). "Impacts of managing loblolly pine plantations intercropped with switchgrass for biofuel production on long-term site productivity, carbon and nutrient cycling, water quality and wildlife." Presented at North American Forest Ecology Workshop, Roanoke, VA, June 19-23, 2011.
- Beckham, G.T. (July 2011). "Computational and experimental approaches for lignin utilization." Presented at EBI and JBEI Joint Workshop in Lignin Utilization, Berkeley, CA, July 19, 2011. *Oral presentation*
- Leggett, Z.H. (January 2011). "Sustainable Biomass Management in Forest Plantations." Presented at Annual Agroforestry Symposium, Columbia, MO, January 12, 2011.

# NABC Publications (cont'd)

- Aardweg, Z.; Homyack, J.; Chalcraft, D. (February 2011). "Preliminary effects of biofuels production on amphibian and reptiles in eastern North Carolina." Presented at Southeastern Partners for Amphibian and Reptile Conservation Annual Meeting, Greenville, NC, April 14, 2011.
- Blazier, M.A.; Sucre, E.B.; Leggett, Z.; Vance, E.D.; Wigley, T.B.; Clason, T.; Roberts, S.; Rousseau, R.; Hatten, J.; Gaston, L.; Tyree, M.; Holley, A.G.; Taylor, E.L. (February 2011). "Loblolly Pine and Switchgrass Intercropping Bioenergy Production Systems in the Southeast US: Impacts on Plant-Soil Carbon and Environmental Services." Presented at Biennial Southern Silvicultural Research Conference, Charleston, SC, February 15-17, 2011.
- Briones, K.; Homyack, M.J.A.; Miller, D.A.; Kalcounis-Rüeggell, M.C. (February 2011). "Effects if intercropping switchgrass and loblolly pine on the diet and trophic position of *Peromyscus leucopus*." Presented at 21st Colloquium on the Conservation of Mammals in the Southeastern U.S. 21:21, Louisville, KY, February 2011. *Abstract*
- Amatya, D.M.; Panda, S.; Chescheir, G.; Nettles, J.; Appelboom, T.; Skaggs, W. (December 2011). "Evaluating Evapotranspiration of Pine Forest, Switchgrass, and Pine- Switchgrass Intercroppings using Remote Sensing and Ground-based Methods." Presented at AGU Annual meeting, San Francisco, CA, December 2011.
- Christopher, S.; Schoenholtz, S.; Nettles, J. (December 2011). "Water resources implications of biofuel production at a regional scale." Presented at AGU Annual meeting, San Francisco, CA, December 4-9, 2011.
- Chmely, S.C.; Kim, S.; Bomble, Y.J.; Chang, C.; Moens, L.; Nimlos, M.R.; Beckham, G.T. (August 2011). "Experimental and computational design of lignin depolymerization catalysts." Presented at 242nd ACS National Meeting, Denver, CO, August 28 - September 1, 2011. *Oral presentation*
- Leggett, Z.H.; Sucre, E.B. (August 2011). "Impacts of managing loblolly pine plantations for biofuels production on site productivity and sustainability." Presented at 2011 Ecological Society of America Meeting, Austin, TX, August 7-12, 2011. *Poster*
- Shanks, B.H. (August 2011). "Thermochemical Removal of Oxygen from Biomass for Fuel Production." Presented at 242nd ACS National Meeting, Denver, CO, August 28 - September 1, 2011.
- Amatya, D.; Chescheir, G.; Nettles, J.; Appelboom, T.; Skaggs, W. (August 2011). "Long-term Hydrologic and Water Quality Monitoring on Drained Pine Plantation Sites in North Carolina." Presented at ASABE Annual Meeting, St. Louis, MO, August 6-9, 2011.
- Gnanakaran, S. (August 2011). "Consideration of substrate properties for catalytic conversion of lignocellulosic biomass." Presented at 242nd ACS National Meeting, Denver, CO, August 28 - September 1, 2011.
- Brown, R.C. (August 2011). "Thermal depolymerization to monomers: A new approach to pyrolysis." Presented at Symposium on Thermochemical Conversion of Biomass to Fuels, Stillwater, OK, August 2, 2011.



# NABC Publications (cont'd)

- Nettles, J.; Leggett, Z.; Grace, J. (August 2011). "Field survey of riparian sediment delivery in forest biofuel operations." Presented at ASABE Annual Meeting, Louisville, KY, August 7-10, 2011.
- Amatya, D.M.; Skaggs, R.W.; Nettles, J.E.; Chescheir, G.M. (August 2011). "Long-Term Hydrology of a Drained Pine Plantation: A Reference for Land Use Conversion into Bio-energy based Switchgrass Plantation in Coastal North Carolina." Presented at ASABE Annual Meeting, St Louis, MO, August 2011. *Poster*
- Kim, S.; Chmely, S.C.; Bomble, Y.J.; Chang, C.; Moens, L.; Nimlos, M.R.; Beckham, G.T.; (August 2011). "Computational and experimental design of lignin depolymerization catalysts." Presented at 242nd ACS National Meeting, Denver, CO, August 28 - September 1, 2011. *Poster*
- Leggett, Z.H.; Nettles, J.; Sucre, E.; Miller, D.; Homyack, J. (August 2011). "Evaluating the effects of biomass production in managed pine forests on water quality and quantity, soil productivity, and wildlife." Presented at 2011 Ecological Society of America Meeting, Austin, TX, August 7-12, 2011.
- Shanks, B.H. (August 2011). "Thermochemical Removal of Oxygen from Biomass for Fuel Production." Presented at ACS National Meeting, Denver, CO, August 29, 2011.
- Aardweg, Z.; Homyack, J.; Chalcraft, D. (April 2011). "Effects of biofuel production practices on abundance and diversity of herpetofauna." Presented at East Carolina University Board of Trustees meeting, Greenville, NC, April 2011. *Poster*
- Leggett, Z.H. (April 2011). "Sustainable Biomass Management in Forest Plantations." Presented at NCSU Soil Science Seminar Series, Raleigh, NC, April 20, 2011.
- Foust, T.D. (September 2010). "National Advanced Biofuels Consortium Overview." Presented at ISU conference: Symposium on Thermal and Catalytic Sciences for Biofuels and Biobased Products (TCS 2010), Ames, IA, September 21-22, 2010.
- Miller, D.A.; Riffell, S.; Iglay, R. B. (September 2010). "Response of plant and wildlife communities to biofuel production on intensively managed landscapes." Presented at Annual Meeting of the Mississippi Chapter of The Wildlife Society, Starkville, MS, October 28, 2010.
- Sucre, E.B. (October 2010). "Impacts of Managing Loblolly Pine Plantations with Switchgrass for Biofuels Production." Presented at 2010 Society of American Foresters National Convention, Albuquerque, NM, October 27-31, 2010.
- Orth, R.J.; Holladay, J.E. (November 2010). "Activities Around Advanced Hydrocarbon Fuels from Biomass." Presented at Bioenergy Conversion Symposium, Seattle, WA, November 8, 2010.
- Holladay, J.E. (November 2010). "Opportunities for production of Hydrocarbon Fuels from Biomass." Presented at AIChE National Meeting, Salt Lake City, UT, November 7-12, 2010.

# NABC Publications (cont'd)

- Schoenholtz, S.H.; Christopher, S.F.; Nettles, J (November 2010). "Growing short-rotation woody crops for bioenergy: environmental considerations." Presented at Soil Science Society of America Fall Meeting, Long Beach, CA, November 2010.
- Holladay, J.E. (November 2010). "The National Advanced Biofuels Consortium." Presented at U.S. Department of Energy Webinar, Webinar, November 18, 2010. *NABC Webinar*
- Allen, E.L.; Birgand, F.; Chescheir, G.M. (November 2010). "Evaluation of a continuous water quality probe." Presented at North Carolina State University, Stream restoration in the Southeast: connecting communities with ecosystems, Raleigh, NC, November 15-18, 2010.
- Minick, K.J.; Strahm, B.D.; Fox, T.R.; Sucre, E.B.; Leggett, Z.H.; Zerpa, J.L. (November 2010). "Effect of bioenergy production on soil nutrient availability in intensively managed loblolly pine plantations." Presented at 2010 Soil Science Society of America Meeting, Long Beach, CA, November 4, 2011. *Poster*
- Leggett, Z.H. (November 2010). "Sustainable Biomass Management in Forest Plantations." Presented at 2010 Soil Science Society of America Meeting, Long Beach, CA, November 4, 2010.
- Foust, T.D. (March 2010). "National Advanced Biofuels Consortium." Presented at Biomass 2010 Conference, Arlington, VA, March 30-31, 2010. *The NABC manned a booth also*
- Marshall, M.M.; Kalcounis-Rüeggell, M.C.; Miller, D.A.; Homyack, J.A. (February 2010). "Impacts of managing loblolly pine plantations for biofuels production on rodent abundance, distribution, and demographics." Presented at 20<sup>th</sup> Colloquium on the Conservation of Mammals in the Southeastern U.S. 20:16, East Windsor, NJ, February 2010.
- Skaggs, R.W. (February 2010). "Determining hydrologic and water quality effects of producing switchgrass in pine plantations." Presented at Oak Ridge National Laboratories. A Watershed Perspective on Bioenergy Sustainability, Oak Ridge, TN, February 3-4, 2010.
- Nettles, J. (February 2010). "Evaluating the environmental effects of biofuel growth and harvest in pine plantations." Presented at Oak Ridge National Laboratories. A Watershed Perspective on Bioenergy Sustainability, Oak Ridge, TN, February 3-4, 2010.
- Christopher, S.F.; Schoenholtz, S.H (February 2010). "Water Quality and Quantity Implications of Biofuel Intercropping at a Regional Scale. A Watershed Perspective on Bioenergy Sustainability." Presented at Workshop at Oak Ridge National Laboratory, Oak Ridge, TN, February 3-4, 2010.
- Amatya, D.M (December 2010). "A seminar on Modeling Hydrology, N, and In-stream Transport on Drained Forested Lands in Coastal Carolinas, USA." Presented at Department of Forest Engineering, Agricultural University of Krakow Seminar, Krakow, Poland, December 8, 2010.

# NABC Publications (cont'd)

- Amatya, D.M (December 2010). "A Seminar on Eco-Hydrologic Monitoring on Two Forest Ecosystems in the Atlantic Coastal Plain, USA." Presented at Department of Hydraulic Engineering and Geotechnics, Agricultural University of Krakow Seminar, Krakow, Poland, December 8, 2010.
- Christopher, S.F.; Schoenholtz, S.H.; Nettles, J. (December 2010). "Water Quality and Quantity Implications of Biofuel Intercropping at a Regional Scale." Presented at American Geophysical Union Fall 2010 Meeting, San Francisco, CA, December 13-17, 2010.
- Christopher, S.F.; Schoenholtz, S (December 2010). "Water Quality and Quantity Implications of Biofuel Intercropping at a Regional Scale." Presented at Soil Science Society of America Fall Meeting, Pittsburgh, PA, December 2010. Leggett, Z.H. (August 2010). "Evaluating the environmental effects of managing loblolly pine plantations for biofuel production." Presented at 2010 Ecological Society of America Meeting, Pittsburgh, PA, August 1-6, 2010.



# Questions?



***Biomass for Advancing America***