



## High Temperature Downhole Motor

Project Officer: Lauren W.E. Boyd

Total Project Funding Received: \$2278k

May 12, 2015

This presentation does not contain any proprietary confidential, or otherwise restricted information.

Principal Investigator

David W. Raymond  
with Jeff Greving, Dennis King,  
Elton Wright, Jiann Su, & Steve Knudsen  
Sandia National Laboratories

Track 3 – EGS1

- Objectives
  - Develop technology for a new downhole motor for geothermal drilling
  - Design power section and demonstrate viability with a proof of concept demonstration
  - Enable high temperature downhole rotation solution for directional drilling and eventual rotary steerables contributing to multi-lateral completions
- Barriers - Geothermal drilling hampered by downhole rotation capabilities
  - Temperature limitations: Positive Displacement Motors - 350F (177C) max
  - Performance limitations: Mud Turbines – High speed, low torque
  - Limits options for multi-lateral completions in geothermal well construction
- Impact
  - Technology is needed that improves ROP and capable of drilling to depth
  - Multi-lateral completions will allow improved resource recovery, decreased environmental impact, and enhanced well construction economics
  - Development of a high temperature motor is an EGS enabling technology

## Work Scope

- Task 1 - Project Management
- Task 2 - Requirements Definition
  - Compile / evaluate results from survey of current motor product offerings
  - Compare results to requirements for fixed cutter bits drilling geothermal formations
- Task 3 & 4 – Preliminary & Detailed Engineering Design
  - Design power section concepts for downhole motor applications in HT environments
- Task 5 - Computational Modeling & Analysis
  - Conduct engineering modeling and analysis to validate concepts
  - Evaluate flow conditions through rotor, ports & chambers
  - Develop operational performance predictions for fluid / power section interaction
- Task 6 - Prototype Hardware Development & Testing
  - Develop and test prototype hardware in controlled laboratory test fixtures to demonstrate and validate available performance
- Task 7 - Field Testing
  - Placeholder for subsequent fiscal years

# Accomplishments, Results and Progress

## - Task 2 / Requirements Definition

### Limitations of positive displacement motors

- PDMs introduce rotation via rotor “nutation”
- Temperature limit: 350 F /177 C max
- Introduce lateral vibration to BHA

### Evaluate for geothermal formation suitability

- Use catalog surveys to map performance
- Compare to fixed cutter bit requirements to validate applicability

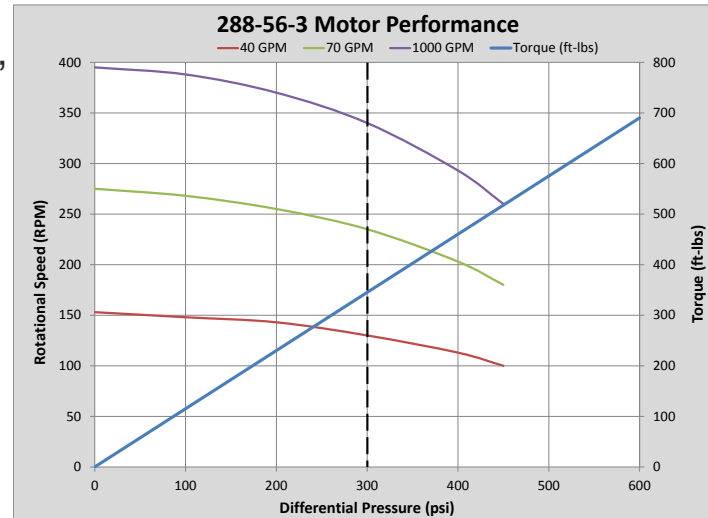

### PDM Motor Data per Toro Downhole Tools Catalog

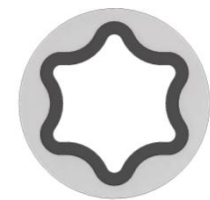
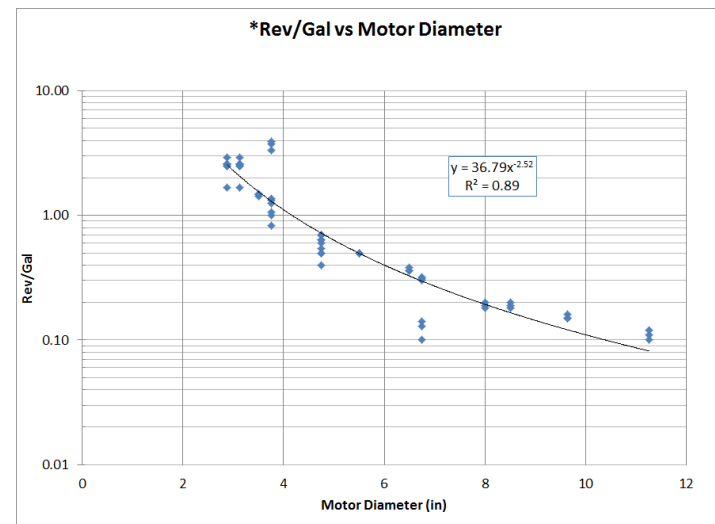
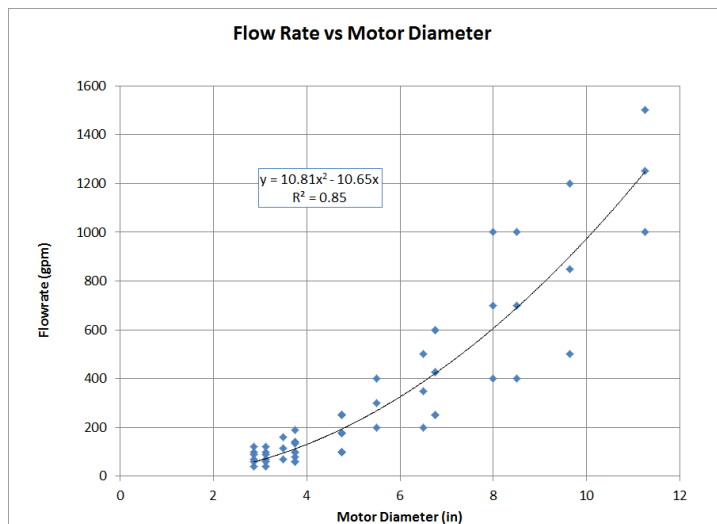

PDM Motor  
Stator

# Accomplishments, Results and Progress- - Task 2 / Requirements Definition

## PDM Motor Survey of Torque & Power

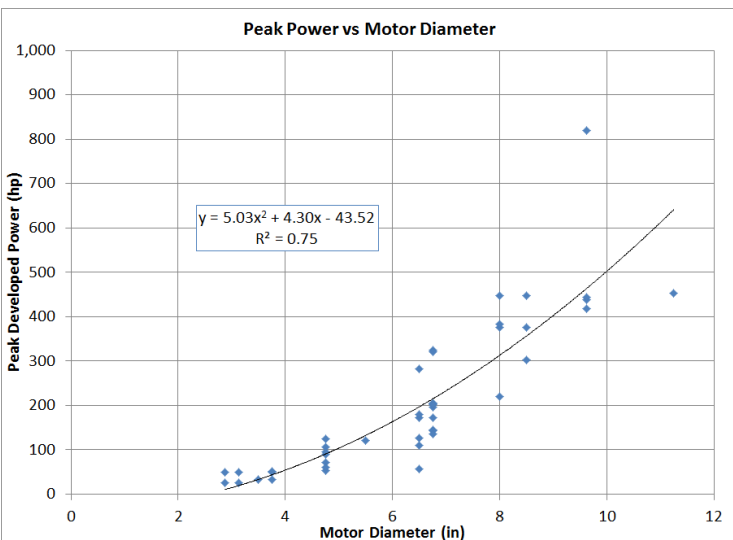
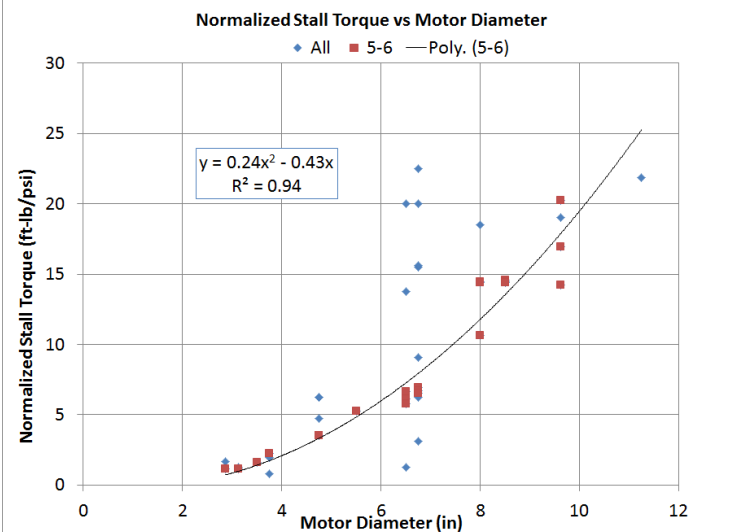

## Rock Bit Interaction Analysis for formation suitability

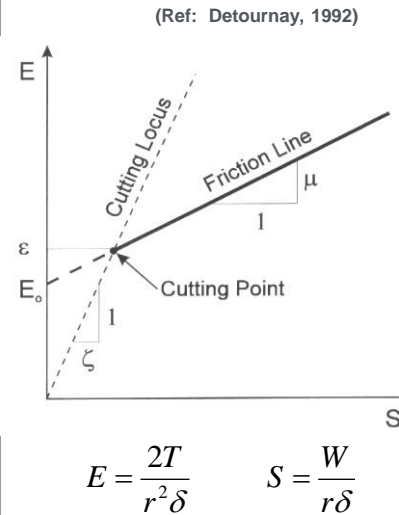

NOV/Sandia Test Bit, Dec 2011

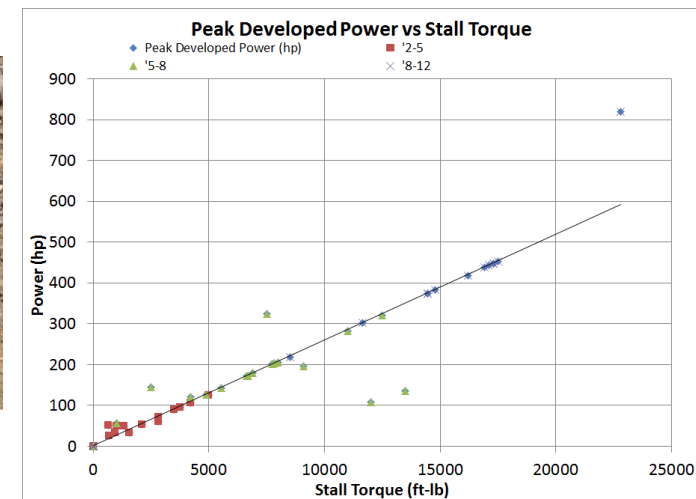
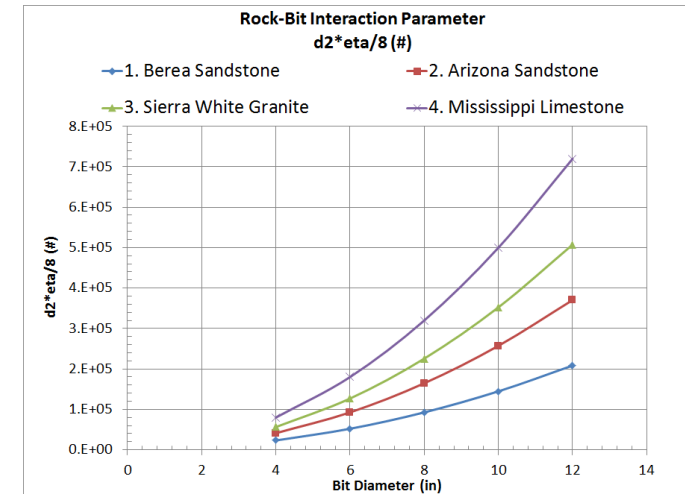

# Accomplishments, Results and Progress

## - Task 3 / Power Section Design

### Approach

- Develop linear piston motor with functionality analogous to swash-plate type axial piston motors & pumps used in hydraulic systems

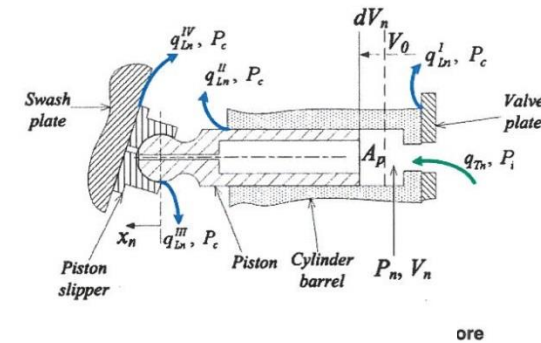
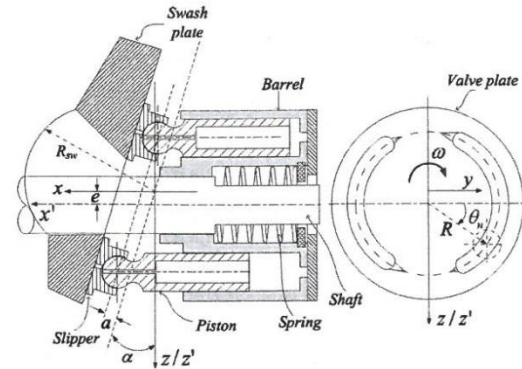

### Progress

- Prototype Concept Developed

Above figures per "The Analysis of Cavitation Problems in the Axial Piston Pump," S. Wang, Eaton Corp., ASME Journal of Fluids Engineering, July 2010.

Flow from surface

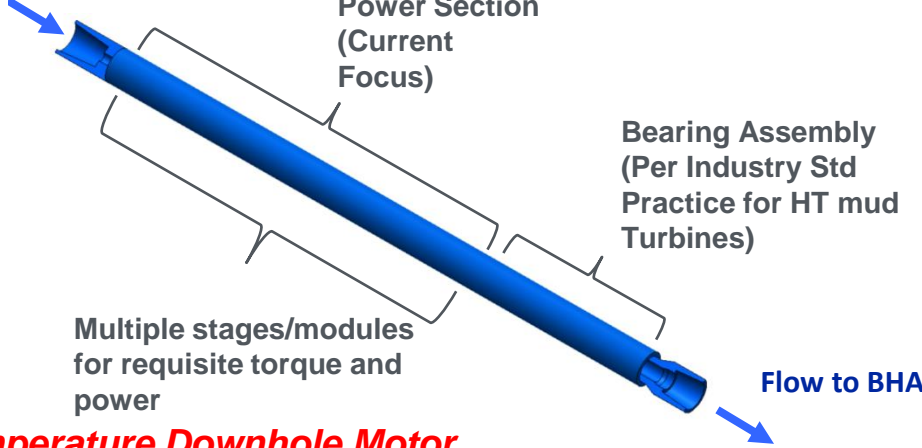

### Sandia High Temperature Downhole Motor



Conventional Hydraulic Axial Piston Motor

U.S. Patent Application No. 14/209,840, filed 3/13/2014; CIP of U.S. App. No. 14/298,377, filed 05/05/2014 and U.S. Provisional Patent Application No. 62/142,837, filed 4/3/2015.

## Progress – Prototype Power Section Developed and Demonstrated

### *Sandia High Temperature Downhole Motor*

U.S. Patent Application No. 14/209,840, filed 3/13/2014; CIP of U.S. App. No. 14/298,377, filed 05/05/2014 and U.S. Provisional Patent Application No. 62/142,837, filed 4/3/2015.

### Power Section Design Description

- Fluid Power Cycle
  - Piston oscillation generated by hydraulic flow through tool
  - Requires alternating pressure on piston lands for reciprocation
- Harmonic drive coupling converts axial piston force / motion to rotor torque / rotation
- Requires multiple pistons
  - Continuous rotation
  - Torque generation
  - Overcome dwell points
- Allows fluid leakage / no seals
- Low friction surfaces at piston interfaces

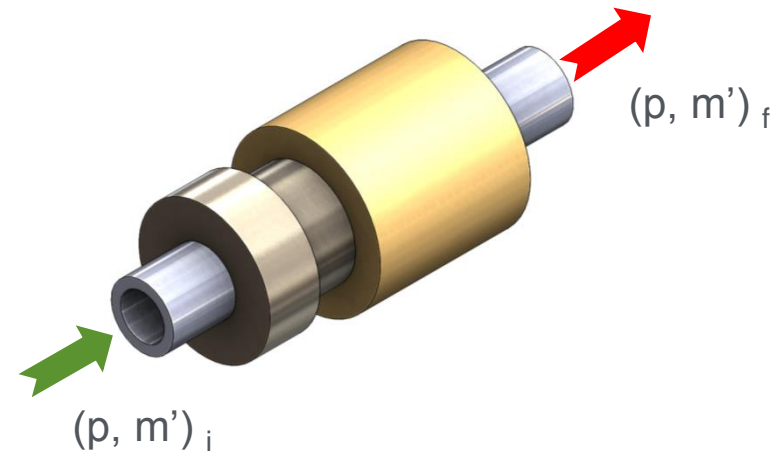

### Assembly

- Removable Rotor Assembly
- Case/Rotor Design Integration
- Pressure/Exhaust Manifold Integration
- Piston Motion / Valve Port Integration

### ***Sandia High Temperature Downhole Motor***

U.S. Patent Application No. 14/209,840, filed 3/13/2014; CIP of U.S. App. No. 14/298,377, filed 05/05/2014 and U.S. Provisional Patent Application No. 62/142,837, filed 4/3/2015.

#### Fluid-End / Power-End Separation:

- Isolated
- Open
- Metered

#### Material Considerations & Selection

- Triplex pump cup-seal pistons with mud pump liners for low temperature proof of concept
- Abrasion Resistant Chromium or Zirconia Liners
- Migrate to HT/Abrasion Resistant materials
  - Tungsten Carbide
  - Silicon Nitride
  - Others



### 3" Piston Motor at 100 RPM & 600 psi Differential Pressure

#### Approach

- Evaluate piston mechanics
- Couple with fluid interaction

#### Results

- Range of conditions evaluated
- Preferred stroke for motor diameter
- Design for performance metrics

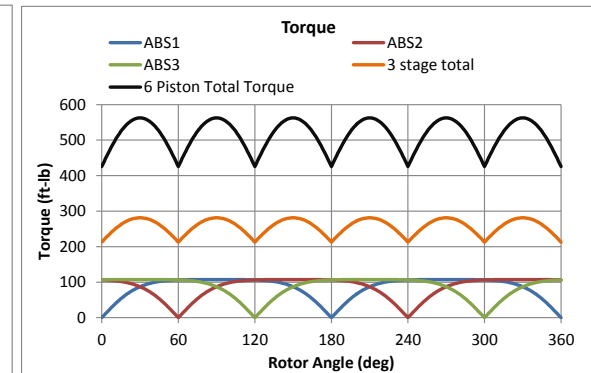
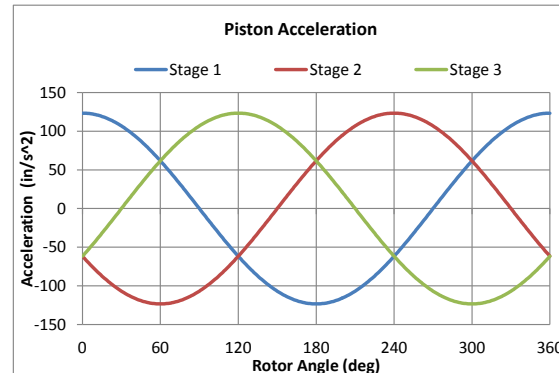
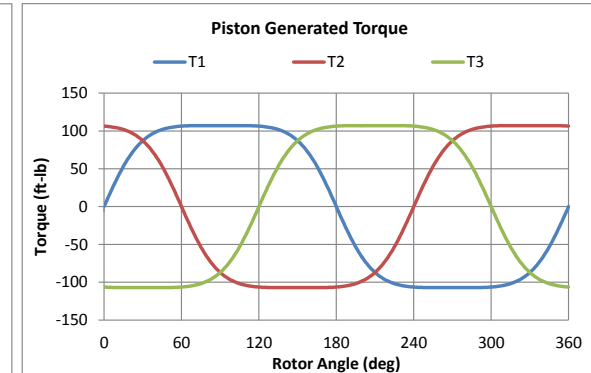
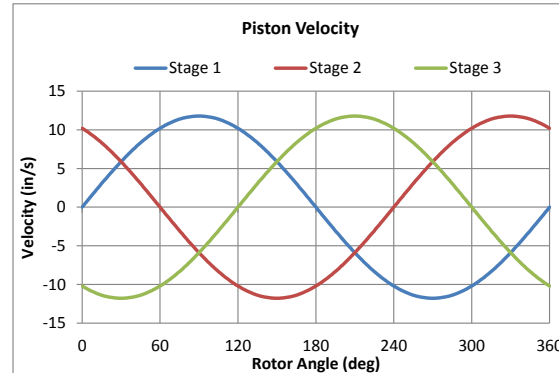
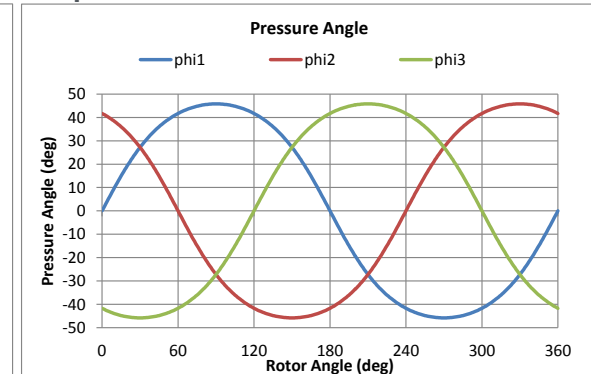
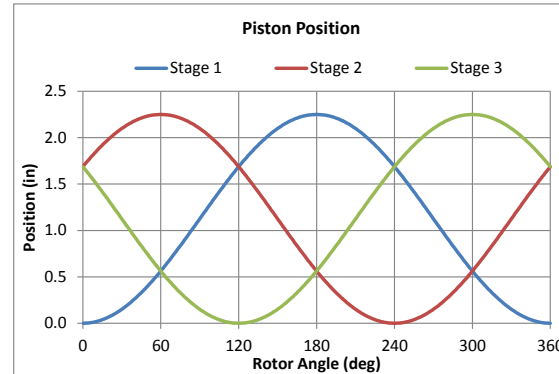

### Progress – Piston Motor concept designs validated against PDM Performance

Nominal Motor Size (in)	PDM			Piston Motor				
	PDM Motor Configuration	Peak Torque Differential Pressure (psi)	PDM Stall Torque (ft-lb)	Piston Motor Configuration	Peak Torque Differential Pressure (psi)	Piston Diameter (in)	Stroke (in)	Piston Motor Stall Torque (ft-lb)
3-1/8	3-1/8", 5:6 lobe, 3 stage	600	692	6 piston	600	2.6	2.3	514
6-1/2	6-1/2", 5:6 lobe, 4 stage	800	4,910	6 piston	800	5.0	4.3	4,507
8	8", 5:6 lobe, 6 stage	1200	12,500	6 piston	1200	6.0	5.0	11,840
11-1/4	11-1/4", 3:4 lobe, 4 stage	800	17,500	6 piston	800	8.0	9.5	21,826

### Dynamics Model

- Used to address coupling between fluid mechanics and reciprocating pistons
- Allows investigation of influence of valve geometry and timing on overall motor performance
- Preliminary results obtained
- Results to be compared to Task 6 Prototype Testing

# Accomplishments, Results and Progress

## - Task 6 / Prototype Demonstrations - Dynamometer

### Approach

- Develop load testing capability to evaluate prototype motors
- Use for single & multi-stage motor testing

### Results

- Dynamometer Test Station developed using Powder Brake Dynamometer
- Sized to provide braking load for proof of concept motor
- Pressure vessel, rotating head, & swivel qualified and operational
- Qualified on commercially-available piston motor

### Parker Motor Test at 100 RPM

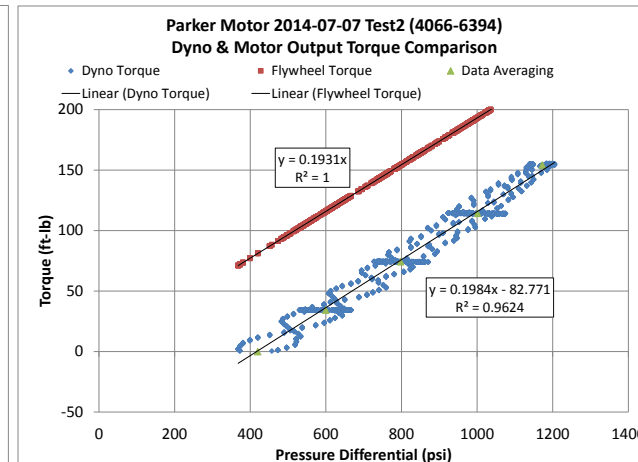
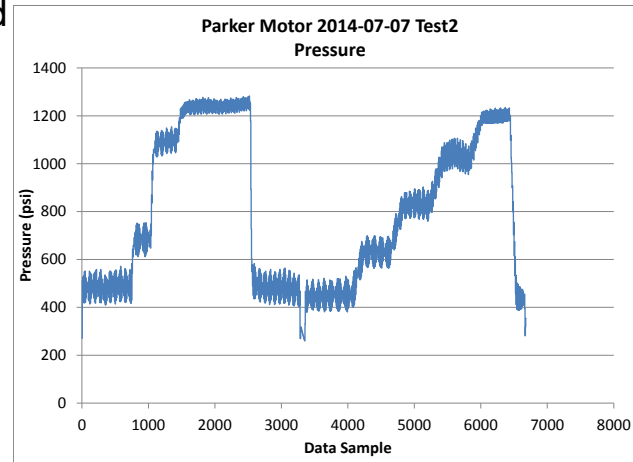
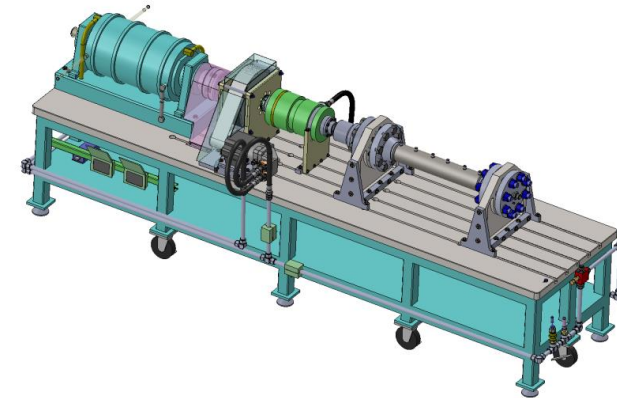
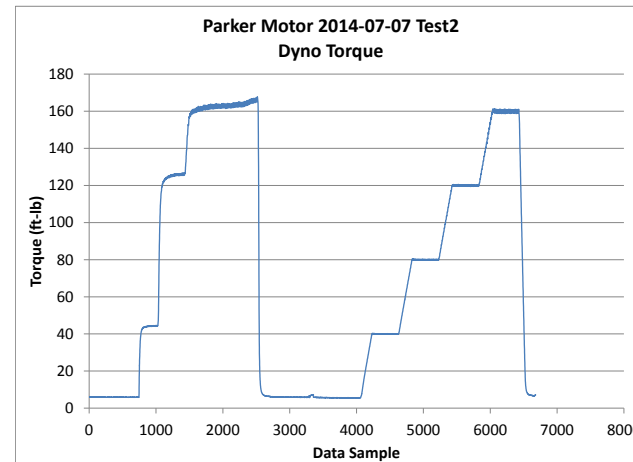

### Approach to Prototype Motor Demonstration

- Geothermal typically completed 8-1/2" D
- Full scale not reasonable for POC
- Develop scaled version compatible with existing infrastructure
  - Validate motor concept on hydraulic power source
  - Offset material selections to later program date
  - Allows focus on power section mechanics & fluid power / component interaction

### Results

- Single and multi-stage functionality demonstrated
- Full power section testing underway
- Testing has highlighted importance of
  - Relative deflections in members
  - Assembly preload
  - Harmonic drive stress concentrations
  - Material compatibilities

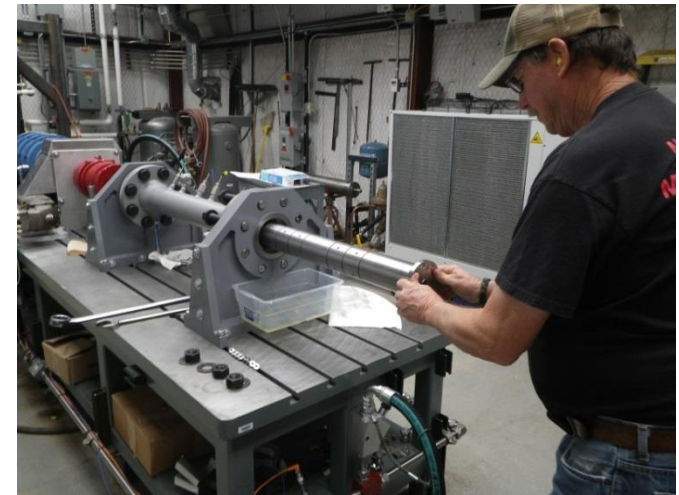

# Accomplishments, Results and Progress

## - Task 6 / Prototype Demonstrations – Flow Loop

### Approach

- Use hydraulic fluid power to prove motor developments
- Validate abrasion resistance of material selections on drilling fluids
- Migrate to HT validations in FY16

### Results

- Dynamometer Test Station in service
- Fluid Power Upgrades Underway
  - Drilling Fluid Flow Loop
    - Designed, fabrication underway
    - Triplex Pump – on order
    - Mud Mixer - received
    - PDM Motor 288-56-3 – Received, use to qualify flow loop
  - Nitrogen System – designed, components ordered
  - Use to qualify components & overall design

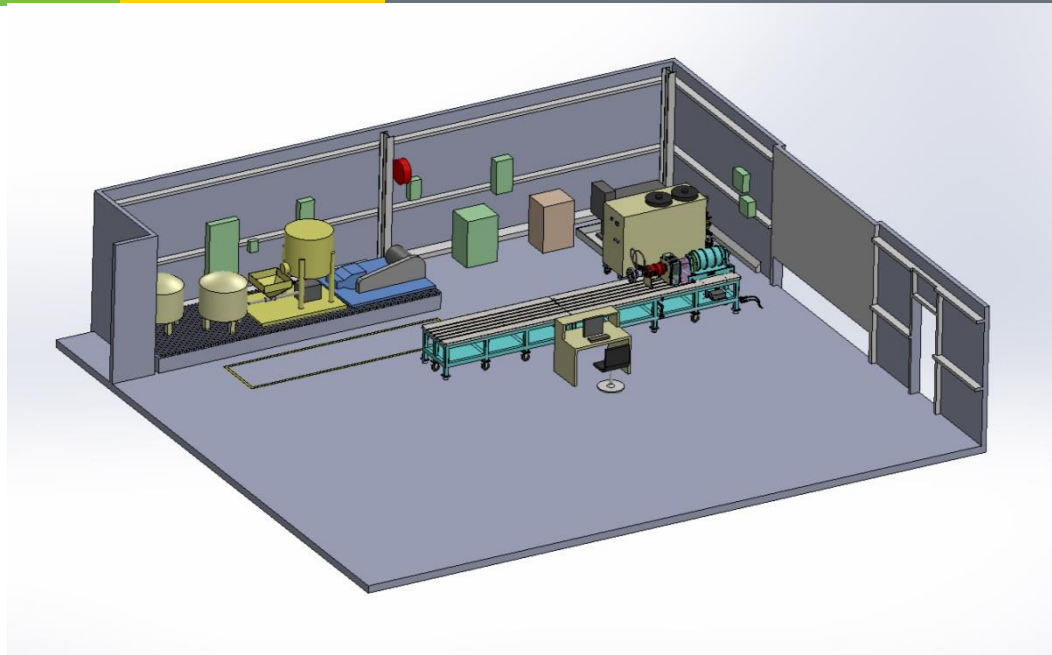

# Accomplishments, Results and Progress

Original Planned Milestone/ Technical Accomplishment	Actual Milestone/Technical Accomplishment	Date Completed
<b>Conceptual, Preliminary and Detailed Power Section Design</b>	Performance requirements identified for 3" diameter Proof of Concept (POC) motor	11/01/12
	Preliminary/prototype design developed for 3" diameter, 3 piston motor incorporating key features in eventual downhole piston motor concept	03/01/13
	Conceptual design approach developed for Fluid-End/Power-End separation	11/20/13
	Performance requirements for geothermal drilling identified by rock bit interaction analysis	09/14/14
	Operational performance requirements for various motor sizes identified by survey of existing downhole motor products	03/31/15
<b>Test Platform Design &amp; Development</b>	Preliminary dynamometer test system in place to accommodate laboratory evaluations	01/31/12
	Compressed air (Nitrogen) test system designed; development underway	03/17/14
	Dynamometer Test Station proven on industry standard piston motor	07/07/14
	Hydraulic fluid power flow loop developed with pressure vessel/motor housing, rotating head and swivel	07/08/14
	Water-based drilling fluid test system designed; development underway	03/26/15
<b>Prototype Development, Demonstration and Validation</b>	Prototype hardware fabricated, assembled, bench-top tested with ongoing testing on the hydraulic test system	07/08/14
	Conceptual design conceived; demonstration pending for Fluid-End/Power-End separation	pending
	Candidate coatings identified; treatments pending	12/01/13
<b>Critical Function Evaluation</b>	Critical function evaluation underway with preliminary testing of prototype on DTS/ hydraulic fluid power fluid	pending
	Critical function evaluation pending on compressed air (nitrogen)	pending
	Critical function evaluation pending on water-based drilling fluid	pending

- Planned milestones and go/no-go decisions for FY15 and beyond:

Milestone or Go/No-Go	Status & Expected Completion Date
<p>- In FY15, motor design features will be evaluated using water-based fluids and compressed air (nitrogen) as the drilling fluid power medium with test capability added to the Dynamometer Test Station to accommodate these fluids.</p>	<p>On-Track 9/30/15</p>
<p>- In FY16, development will commence on a high temperature compatible power section incorporating results of the drilling fluid critical function evaluations with the Dynamometer Test Station upgraded for high temperature evaluation.</p>	<p>On-Track 9/30/16</p>
<p>- In FY17, a prototype motor will be developed via design integration of the concept power section with a bearing pack to produce a fully-functioning downhole motor and tested in a laboratory drilling configuration for BHA readiness.</p>	<p>On-Track 9/30/17</p>
<p>- In FY18, field testing will commence to demonstrate motor performance under the rigors of geothermal drilling.</p>	<p>On-Track 9/30/18</p>

# Summary

## High Temperature Downhole Motor

- Reliable downhole motors do not exist for geothermal drilling
  - PDM temperature limitations / Mud Turbines performance limitations
  - Steering options are limited requiring compromises in drilling plans and well completions
  - Directional drilling can be used to enable multi-lateral completions from a single well pad to improve well productivity and decrease environmental impact
- This project will develop and demonstrate a high temperature downhole rotation concept that can enhance geothermal drilling
  - Prototype Power Section designed, developed, demonstrated & critical function evaluation underway
  - Pathway to abrasion resistant, high temperature operation identified
  - Project on track to produce full-scale downhole motor for geothermal drilling by FY18