

# Pathways to Commercial Success:

Technologies and Products Supported by  
the Fuel Cell Technologies Program

September 2011



# Table of Contents

<b>Summary</b> .....	v
<b>1.0 Introduction</b> .....	1-1
1.1 Organization of the FCT Program .....	1-1
1.2 Contents of this Report .....	1-3
<b>2.0 Approach</b> .....	2-1
2.1 Patent Search and Analysis .....	2-1
2.2 Technology Tracking to Identify and Describe Commercial and Emerging Technologies .....	2-3
<b>3.0 Results</b> .....	3-1
3.1 Patent Search and Analysis .....	3-1
3.2 Commercial and Emerging Technology Identification and Tracking Results .....	3-3
<b>Appendix A</b> <b>Technology Tracking Data Collection Template</b> .....	A-1
<b>Appendix B:</b> <b>Technology Tracking List</b> .....	B-1
<b>Appendix C:</b> <b>Patent Status List</b> .....	C-1
<b>Appendix D:</b> <b>Commercially Available Technology Descriptions</b> .....	D-1
<b>Appendix E:</b> <b>Emerging Technology Descriptions</b> .....	E-1
<b>Appendix F:</b> <b>Directory of Technology Developers</b> .....	F-1





# Summary

The purpose of the project described in this report is to identify and document the commercial and emerging (projected to be commercialized within the next 3 years) hydrogen and fuel cell technologies and products that resulted from Department of Energy support through the Fuel Cell Technologies (FCT) Program in the Office of Energy Efficiency and Renewable Energy (EERE). To do this, Pacific Northwest National Laboratory (PNNL) undertook two efforts simultaneously to accomplish this project. The first effort was a patent search and analysis to identify hydrogen- and fuel-cell-related patents that are associated with FCT-funded projects (or projects conducted by DOE-EERE predecessor programs) and to ascertain the patents' current status, as well as any commercial products that may have used the technology documented in the patent. The second effort was a series of interviews with current and past FCT personnel, a review of relevant program annual reports, and an examination of hydrogen- and fuel-cell-related grants made under the Small Business Innovation Research and Small Business Technology Transfer Programs, and within the FCT portfolio.

The patent analysis identified 313 patents associated with research supported by FCT dating back to 1977. The 313 FCT patents include: 167 fuel cell patents, 108 production/delivery patents, and 38 storage patents. More than 150 of these patents were issued after 2005. Three types of organizations received the patents: national laboratories (138 patents), private companies (152 patents), and universities (23 patents). Private companies received the greatest number of patent awards in the fuel cell and production/delivery areas, accounting for 55% of the fuel cell patents and 48% of the production/delivery patents. The national laboratories had 68% of the awards in the storage area. While the national laboratories and private companies received 50% or more of their patents for fuel cell technologies, more than half of the patents received by universities (57%) were for production/delivery technologies.

The patent award status by use indicated that 14 patents are currently used in commercial products and 57 are part of research now taking place on emerging technologies. In addition, 156 awarded patents are still being utilized via continuing research and/or active attempts to license the patent. Of all the patents reviewed, 73% are still actively being pursued through use in continuing research, emerging technologies, or commercially available products. This was particularly true in the production/delivery area, where 87 of the 108 patents (81%) are still active. The storage and fuel cell areas both have 68% of their patents being actively pursued.

In addition, PNNL identified 30 commercial technologies that have entered the market, of which 29 are still commercially available. From 2000 – 2006, one to three commercial technologies entered the market per year. In 2007 and 2008, five and seven technologies entered the market, respectively. For 2009 through 2011 the rate of technologies entering the market returned to one to three per year. This effort also identified 63 emerging technologies. The number of fuel cell technologies is 60% of the total number of emerging technologies.

This report documents the methodology and results of this study, including the specific patents as well as commercial and emerging technologies that resulted from the FCT Program.



# 1.0 Introduction

This report documents the methodology and results of an effort to identify and characterize commercial and emerging<sup>1</sup> technologies and products that resulted from the support of the Fuel Cell Technologies (FCT) Program<sup>2</sup> within the U.S. Department of Energy's (DOE's) Office of Energy Efficiency and Renewable Energy (EERE). Commercialization of technologies that are cultivated in a government research and development (R&D) program is viewed as one measure of success. PNNL has been conducting similar technology tracking activity for the EERE Industrial Technologies Program (and its predecessors) for over two decades.

The results presented in this report represent the findings from the PNNL effort. The information presented on commercial and emerging technologies fulfills the primary objective – to assess the commercialization status of EERE-developed hydrogen and fuel cell technologies. The effort is expected to continue, with an updated report produced annually.

This chapter presents a brief overview of the FCT Program's research that is leading to commercial technologies and products. The chapter concludes with a summary of the contents of this report.

## 1.1 Organization of the FCT Program

The FCT Program (Program) is focused on key technical challenges associated with fuel cells and hydrogen production, delivery, and storage, as well as institutional barriers, such as hydrogen safety, codes and standards, technology validation, market transformation, and public awareness. The Program is currently conducting applied research, technology development, and learning demonstrations, as well as safety research, systems analysis, and public outreach and education activities. Because the research involved in solving critical technological barriers is often high risk, and can benefit from leveraging resources and skills, the Program encourages public-private partnerships, which include the supply chain industry, automotive and power equipment manufacturers, energy and chemical companies, electric and natural gas utilities, building designers, standards development organizations, other federal agencies, state government agencies, universities, national laboratories, and other national and international stakeholder organizations.

The Program is currently conducting R&D, demonstration, analysis, and other efforts to support development of hydrogen energy systems for stationary power (including back-up emergency power and residential electric power generation), transportation (including materials handling equipment, fuel cell vehicles and hydrogen refueling infrastructure), and portable power applications (including consumer electronics such as cellular phones, hand-held computers, radios, and laptop computers). The FCT subprograms that are relevant to technology development represented in this report include the following:

- Hydrogen Production
- Hydrogen Delivery
- Hydrogen Storage
- Fuel Cells
- Manufacturing R&D.

The first four subprograms are the primary focus of this report because they are focused on technology R&D that would result in patents and other intellectual property that could be incorporated into commercial technologies and products. Manufacturing R&D is a relatively new subprogram that is likely to lead to commercial technologies in the future.

---

<sup>1</sup> “Commercial” technologies, as defined in this report, are those available for purchase and that have been sold to at least one party. “Emerging” technologies, as defined in this report, are technologies that are projected to be commercialized within the next 3 years, based on the opinion of the technology developer.

<sup>2</sup> Formerly the Hydrogen, Fuel Cells & Infrastructure Technologies Program, 2002-2009

The current goals of these four subprograms are briefly summarized below.

**Hydrogen Production.** The goal of the Hydrogen Production subprogram is to develop low-cost, highly efficient hydrogen production technologies from diverse domestic sources, including natural gas and renewable sources. The subprogram objectives include lowering the cost of distributed production (at the pump) of hydrogen from natural gas, biomass, and electrolysis; developing high-temperature thermo-chemical cycles driven by concentrated solar energy; and developing advanced renewable photo-electrochemical and biological hydrogen generation technologies. Hydrogen separation is a key technology that cross-cuts hydrogen production options, and various separation membranes are being developed as part of distributed and central hydrogen production systems. In addition, work in the subprogram includes developing better catalysts needed in production systems and coordinating with the Office of Science on basic research, such as hydrogen production from algae and other biological systems. The subprogram also coordinates with the Office of Fossil Energy (FE) on coal gasification (with sequestration) and separation processes, and with the Office of Nuclear Energy (NE) on hydrogen production from thermochemical processes.

**Hydrogen Delivery.** The goal of the Hydrogen Delivery subprogram is to develop hydrogen delivery technologies that enable the introduction and long-term viability of hydrogen as an energy carrier for transportation and stationary power. Some of the current objectives include reducing the cost of compression, storage, and dispensing at refueling stations and stationary power facilities; reducing the cost of hydrogen transport from central and semi-central production facilities to the gate of refueling stations and other end users; and reducing the cost of hydrogen delivery from the point of production to the point of use in vehicles or stationary power units. Some of the technical challenges that must be addressed include resolving hydrogen embrittlement concerns and developing new and improved materials for pipeline delivery of hydrogen, developing novel liquid and solid carrier technologies, improving compression and bulk storage technologies, and improving hydrogen liquefaction approaches.

**Hydrogen Storage.** The goal of the Hydrogen Storage subprogram is to develop and demonstrate viable hydrogen storage technologies for transportation and stationary applications, with the primary objectives focused on developing and verifying on-board hydrogen storage systems for transportation applications. Various research activities are being pursued, such as those related to lightweight composite tanks with high-pressure ratings and conformability and high-capacity metal hydrides, including boron-based materials, adsorbent-based and nanostructured materials, chemical carriers, and other promising materials with potential for hydrogen storage. Coordination with the Office of Science is also significant, particularly in developing a fundamental understanding of hydrogen-material interactions.

**Fuel Cells.** The goal of the Fuel Cells subprogram is to develop and demonstrate fuel cell power system technologies for transportation, stationary, and portable power applications. The subprogram emphasizes polymer electrolyte membrane (PEM) fuel cells as replacements for internal combustion engines in light-duty vehicles as well as fuel cells for stationary power, portable power, and auxiliary power applications. Research focus areas include work on membranes, electrocatalysts and electrode design, membrane electrode assemblies, gas diffusion layers, bipolar plates, seals, and other aspects of fuel cell design including water management and balance-of-plant components. More recently, the subprogram has included small-scale solid oxide fuel cell (SOFC) R&D to complement the Department Office of Fossil Energy's Solid State Energy Conversion Alliance (SECA) Program<sup>3</sup> on megawatt-scale SOFC power systems. The portfolio has been broadened to include other work as well, such as alkaline fuel cells. Work on fundamental catalysis is coordinated with the Office of Science.

More information on program goals, objectives, research thrusts, and activities can be found in the [FCT Multi-Year Program Plan](http://www1.eere.energy.gov/hydrogenandfuelcells/mypp/) (<http://www1.eere.energy.gov/hydrogenandfuelcells/mypp/>).

The objectives of, and R&D activities funded by, the FCT Program and its predecessor programs have changed over the years as the Program has become more focused on the goals described above and as advancements have been made in R&D. Because this report looks retrospectively at commercial successes over the history of hydrogen and fuel cell

---

<sup>3</sup> FE's SECA Program is supporting the development of large-scale SOFCs that can be mass produced in modular form at \$400/kW. The objective of the SECA Program is to put reliable fuel cells into a more compact, modular, and affordable design to allow wide-spread penetration into high-volume stationary, transportation, and military markets.

research within EERE, the patents and commercial/emerging technologies and products described in the remainder of this report may be broader than one would expect from examining the current Program.

## **1.2 Contents of this Report**

The remaining chapters explain in more detail the methodology used and provide the results of the effort in tables and charts. The appendices provide detail related to the data-gathering techniques and descriptions of each of the commercial and emerging technologies and products that were identified in the study, as well as the list of patents resulting from the R&D efforts undertaken by the FCT Program and its predecessors. Note that in this report, the delivery technologies have been grouped with production technologies because of the overlap between the two categories.



## 2.0 Approach

Two efforts were undertaken simultaneously by PNNL in August 2007 to start the FCT technology tracking project. The first effort was a patent search and analysis to identify hydrogen- and fuel-cell-related patents that are associated with FCT-funded projects (or projects conducted by DOE-EERE predecessor programs) and to ascertain the patents' current status, as well as any commercial products that may have used the technology documented in the patent. The second effort was a series of interviews and document reviews to identify and characterize commercial and emerging technologies that have benefited in a direct way as a result of direct funding from the FCT Program (or funding from EERE predecessor programs) or from grants under programs such as the Small Business Innovation Research and Small Business Technology Transfer. These initial efforts resulted in the August 2009 EERE report entitled: *Pathways to Commercial Success: Technologies and Products Supported by the Hydrogen, Fuel Cells & Infrastructure Technologies Program*. PNNL subsequently updated this report in FY 2010 and FY 2011. The approach taken for these efforts is summarized in Sections 2.1 and 2.2 below.

### 2.1 Patent Search and Analysis

PNNL conducted several patent searches using the United States Patent Office (USPTO) database. The searches included key words related to the hydrogen program<sup>1</sup> and focused exclusively on patents for which DOE had a “Government Interest.”<sup>2</sup> The resulting list contained 118 fuel cell patents (mostly related to PEMs) and 239 hydrogen production, storage and delivery patents dating back to 1977. The PNNL team then conducted an initial screening analysis to winnow the patent list to those likely to be associated with EERE research. (Other parts of DOE, including FE, NE, and Office of Science, also conduct research on hydrogen and fuel cells, but those patents were not included in this study.)

To conduct this screening process, the PNNL team considered the following factors in deciding whether a patent should be included on the list of possible EERE-sponsored hydrogen and fuel cell patents:

- Most research on phosphoric acid fuel cells (PAFCs), molten carbonate fuel cells (MCFCs), and solid oxide fuel cells (SOFCs) was funded by DOE's FE in the past, so patents for these types of fuel cells were not included in the EERE list (with the exceptions noted in the next bullet). However, almost all PEM fuel cell research was funded by EERE. Therefore, PNNL typically included PEM fuel cell patents in the list of possible EERE-sponsored patents (with the exceptions noted below).
- EERE started research on PAFCs *for buses* in 1987, and its PEM research program began in 1990. In addition, beginning in 1996, EERE's charter (based on the FCT Program Multi-Year Program Plan) includes direct methanol fuel cell (DMFC) work for portable power. Therefore, some patents related to PAFCs and patents for PEMs and DMFCs that were filed after those dates were assumed to be associated with EERE's hydrogen and fuel cell research. However, the PNNL team assumed it takes at least 2 to 3 years to conduct the research and have a patent awarded and took that time lag into account when developing the list of possible EERE-sponsored patents. For example, any patents awarded before 1990 for PAFCs and before 1992 for PEMs were assumed to be related to research outside EERE.

In addition, PNNL obtained the list of patents that were cited in the Hydrogen Program's Annual Progress Reports for 2002 – 2007<sup>3</sup> and included them in the patent list after checking against the two bulleted factors above (in almost all

---

<sup>1</sup> One search used the following search terms: “hydrogen” AND “storage” OR “transport” OR “delivery” OR “dispensing” AND “government/energy.” The other search used the following search terms: “fuel cell” AND “pem” OR “membrane” AND “government/energy.”

<sup>2</sup> Note that the patent database has a separate field that designates whether there is a “Government Interest” in the patent. If DOE has an interest, that field says, for example, “The United States Government has rights in this invention pursuant to Contract No. [...] between the United States Department of Energy and [...] a national laboratory or other party.” It is possible that not all of the parties with EERE-related patents correctly indicated that their patents had a “Government Interest.”

<sup>3</sup> These reports can be found at [http://www.hydrogen.energy.gov/annual\\_progress.html](http://www.hydrogen.energy.gov/annual_progress.html).

cases, the patent search had already found these patents). The list was sent to FCT staff to review, and some patents were removed or recategorized (e.g., from fuel cells to production). The resulting list contained patents for 77 fuel-cell-related and 103 hydrogen-related technologies or inventions (180 total).

The next step was to obtain more information about the government’s role in developing the patent and to determine the current status. The PNNL team contacted patent holders by phone or email. For large organizations (e.g., national laboratories, universities, and multinational corporations), PNNL team members were often referred to a central office within the organization, such as a technology transfer, commercialization, or legal affairs office.

The PNNL team members asked the patent holders or central offices whether FCT or EERE (or its predecessors) funded the research resulting in the patent. Patents not related to FCT or EERE funding were removed from the list. If a patent had received such funding, the PNNL team attempted to ascertain the current status of the patent and placed it in one of the following categories: no longer being pursued for commercialization nor used in research, still being used in research, used in a commercial product, or licensed to another company. If the patent is still being used in research, PNNL asked if it was part of an emerging technology for which PNNL was gathering data. If the technology was licensed to another company, PNNL asked for the name of the company and tried to ascertain whether a commercial product had resulted from the patent. As PNNL gathered technology data, other patents associated with FCT/EERE funding were sometimes identified and added to the list. Figure 2.1 depicts the initial patent analysis process for the hydrogen and fuel cell technologies.

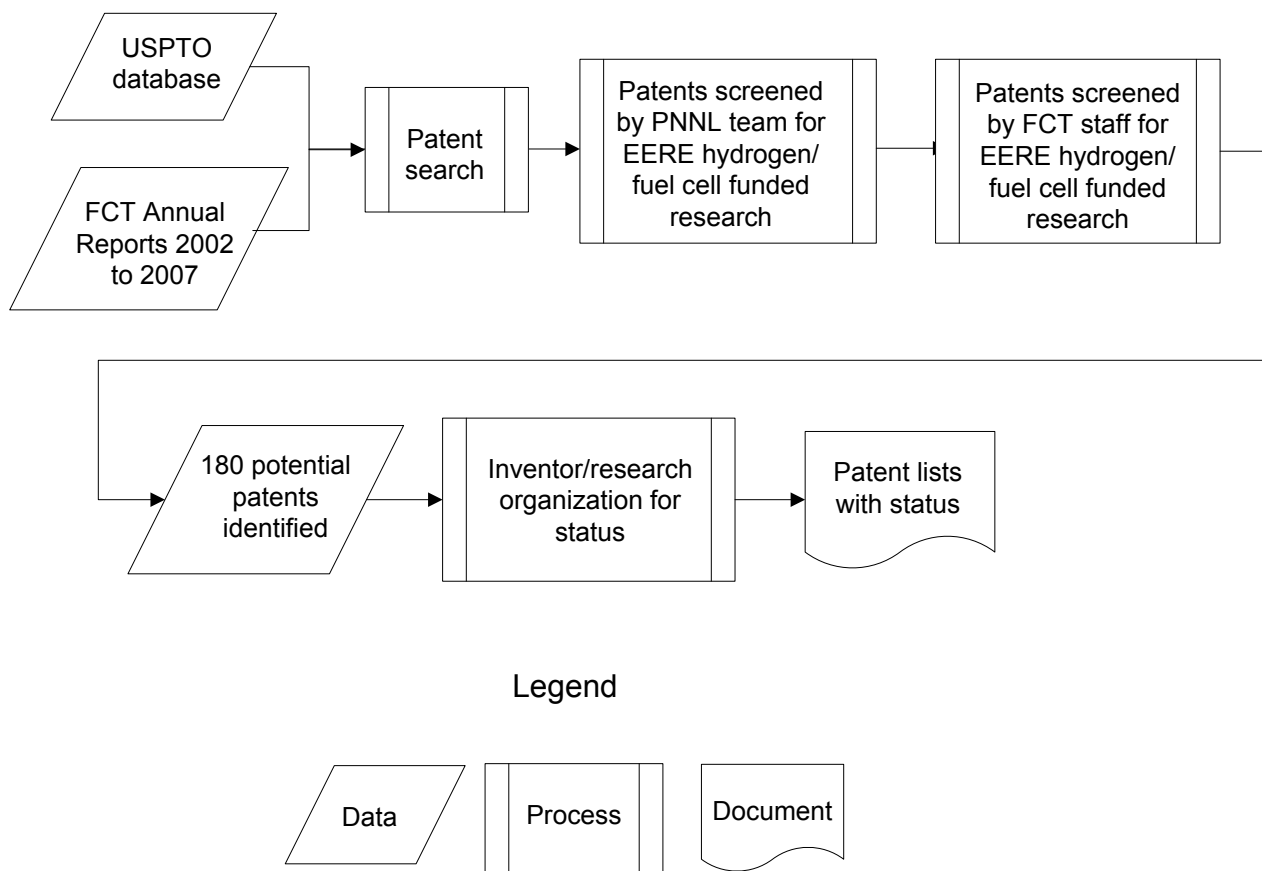

**Figure 2.1. Initial Patent Analysis Process for Hydrogen and Fuel Cell Technologies**

In FY 2010, PNNL began updating the August 2009 *Pathways to Commercial Success* report. As part of the updating process, the PNNL team conducted a search through FY 2008 and 2009 Hydrogen Program Annual Progress Reports to identify any new patents issued during those years. In addition, principal investigators for FCT-funded emerging technologies and commercial products were asked if they had been awarded any new patents as a result of their research and development work. In June 2010, EERE launched a Technology Commercialization Portal on their website (<http://techportal.eere.energy.gov/>), which features a portfolio of EERE-funded technologies available for licensing, including



patents. Using the EERE Portal, the PNNL team conducted a search for patents which employed similar screening strategies to those used in the original USPTO database searches. The resulting list contained a total of approximately 120 patents related to fuel cells, hydrogen production/delivery, and hydrogen storage. The PNNL team contacted patent holders via phone and e-mail to determine whether or not the underlying research associated with a patent was FCT-funded. If a patent had received such funding, its current status was obtained. The FY 2010 efforts resulted in identification of 54 patents funded by FCT (or its predecessor organizations), which were added to those identified in the initial search. In FY 2011, PNNL conducted another patent search using the same methodology as in FY 2010. The FY 2011 effort resulted in identification of 115 patents funded by FCT (or its predecessor organizations).

The combined results of all the patent searches are discussed in Chapter 3. Some of the intellectual property in the patents on the list was used in technologies or products that were commercialized or that are soon to be commercialized. The section below describes the effort, conducted in parallel with the patent analysis, to identify and describe commercialized and emerging technologies. Chapter 3 provides information on these technologies and the patents related to them.

## **2.2 Technology Tracking to Identify and Describe Commercial and Emerging Technologies**

The technology tracking approach used to gather information on commercial and emerging hydrogen technologies is based on one that PNNL has been using for 20 years to gather information on technologies funded by the EERE Industrial Technologies Program (ITP). In 2007, the PNNL team identified FCT-funded projects that may have led to commercial or emerging technologies. To accomplish this, a series of one-on-one meetings was held with FCT personnel and former FCT personnel in which the lists of all FCT-funded projects, obtained from the Hydrogen Program Annual Progress Reports for 2002 – 2007, were reviewed. Also, PNNL reviewed earlier annual reports from FCT predecessor programs. From these meetings, the PNNL team obtained a preliminary list of projects that the FCT personnel indicated may have led to commercial or emerging technologies. The government personnel also provided information about points of contact (POC) or principal investigators (PIs) at each relevant research organization and, where available, hard copies of reports or presentations pertinent to the technologies. The resulting list of projects from these meetings was separated into three categories according to the following research areas: fuel cells, hydrogen production/delivery, and hydrogen storage.

The PNNL team contacted the POCs or PIs for the technologies to determine whether they were commercially available, emerging, still in the research stage but more than 3 years from commercialization, or no longer being pursued. For technologies identified as commercial or emerging, a template, shown in Appendix A, was sent to the POCs/PIs to gather data on the technology.

The Hydrogen Program Annual Progress Report also includes descriptions of hydrogen and fuel cell projects from the annually funded Small Business Innovation Research (SBIR) and Small Business Technology Transfer (STTR) grants. The SBIR grants are funded in two phases: Phase 1 grants focus on the feasibility of an idea and are funded at a low level (typically up to \$100K), and Phase 2 grants focus on principal R&D and are funded at a higher level (typically up to \$500K). To receive a SBIR Phase 2 grant, a small business would have to have successfully completed a Phase 1 grant and have been selected to continue their research. The STTR grants are similar to SBIR grants as far as having small business participation, but a nonprofit research institution, such as a university or national laboratory, must also be involved. The PNNL team focused on the SBIR Phase 2 and STTR grant projects and contacted the PIs for all of these grants to determine the status of the technologies being developed. Any identified as commercial or emerging were added to the technology tracking list.

Data gathered about the technologies were then entered into a FCT Program Technology Tracking Database, a Lotus Notes database. The database is divided into commercial and emerging technology sections and into three types of research within each section: fuel cells, production/delivery, and storage. In addition, hard copy files are kept that include the template (database) information and other supporting data such as annual progress reports, presentations, and information from the organization's website. The database was created and populated by PNNL and is stored at PNNL, and FCT personnel have access to it. Periodically, PNNL transmits an updated version of the database to DOE to replace the older version on the DOE system.

For each of the commercial and emerging hydrogen technologies in the database, the PNNL team prepared and edited a summary description and sent it to the industry/research organization POC for review and subsequent approval before sending it to FCT Program personnel to review. The results of the technology tracking effort are discussed in Chapter 3. Figure 2.2 depicts the initial technology tracking process.

As part of the FY 2010 update to the report, the PNNL team re-contacted all of the POCs or PIs for emerging and commercial technologies listed in the August 2009 report to ascertain their current status. Based on the results of this new investigation, the database entries and summary descriptions for all of the technologies were updated. In addition, the PNNL team reviewed FY 2008 and 2009 Hydrogen Program Annual Reports and SBIR/STTR project summaries to generate a list of technologies with the potential to be either emerging or commercial. The POCs or PIs for all of these potential technologies were contacted in order to determine their current status. If a technology was determined to be commercially available or emerging, information gathered about the technology was entered into the database and a summary description was added to the report. The FY 2010 update resulted in the addition of data for 6 commercially available and 15 emerging technologies to the database and report.

In FY 2011, PNNL performed another update to the report, using the 2010 Hydrogen Program Annual Reports and SBIR/STTR project summaries as sources for technologies to investigate. Projects that received funding as part of the American Recovery and Reinvestment Act (ARRA) were also investigated. The FY 2011 update resulted in the addition of 2 commercially available and 11 emerging technologies to the database and report. The complete listing of commercially available and emerging technologies identified to date is shown in Appendix B.

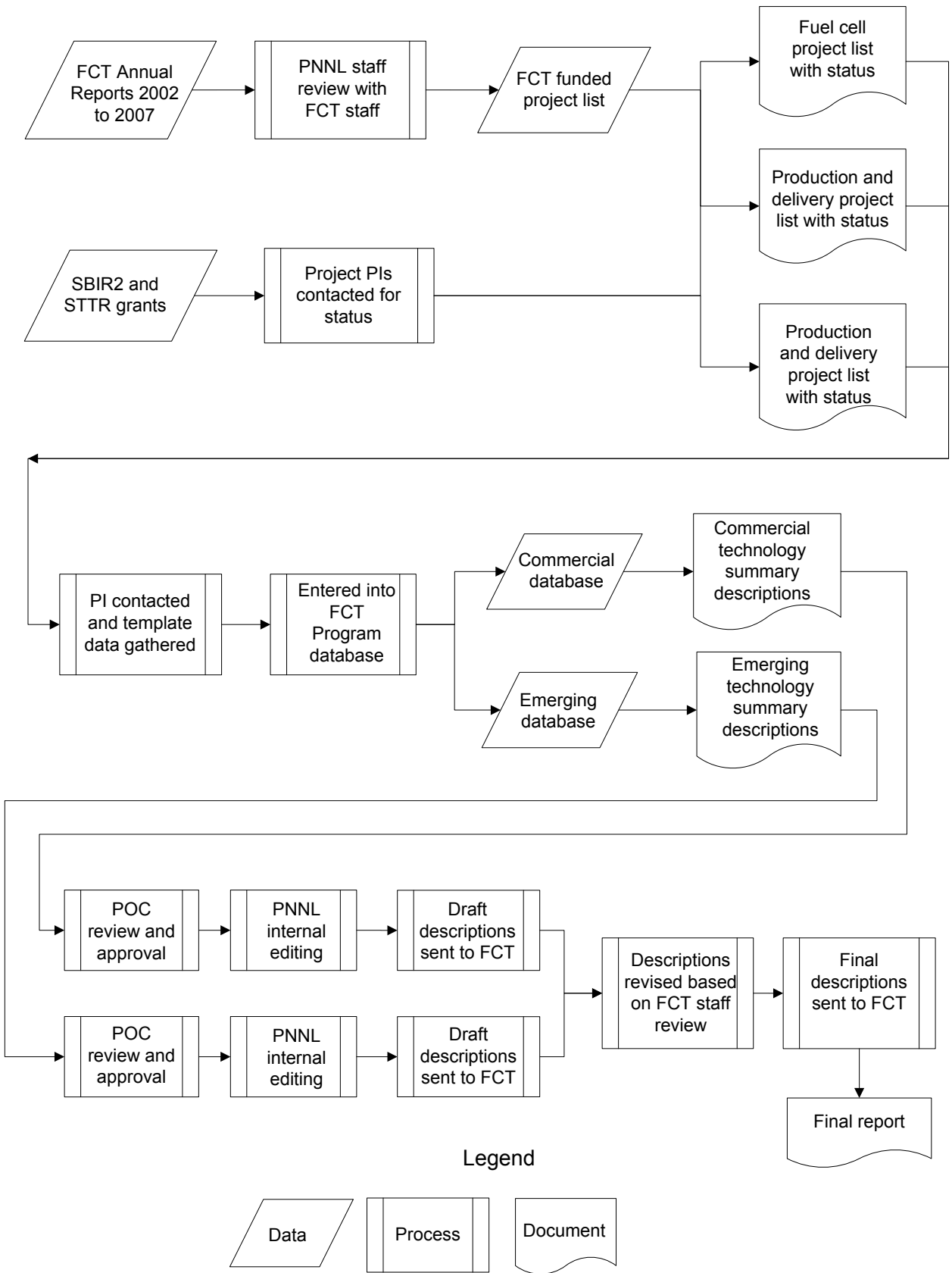

**Figure 2.2. Initial Technology Tracking Process for Hydrogen Technologies**



# 3.0 Results

The results of the efforts undertaken in the FCT Program technology tracking project are summarized in this chapter. Section 3.1 describes the patent search and analysis and Section 3.2 describes the results of the commercial and emerging technology identification and tracking effort.

## 3.1 Patent Search and Analysis

The results of the patent search are shown in tables in Appendix C; the 167 fuel cell patents are listed in Appendix C-1, the 108 production/delivery patents are listed in Appendix C-2, and the 38 storage patents are listed in Appendix C-3. The patents are listed in chronological order from the most recent to the oldest patent for each group. The tables list the patent number, award date, organization receiving the patent, patent title, patent description, and patent status.

Figure 3.1 shows the cumulative number of patents awarded over time, starting with pre-2000 patent awards through 2011. (At the time of this report, data for 2011 are only partially available.) As the figure shows, the number of patents awarded per year increased significantly in 2009 and 2010. To date, 2010 had the largest number of patents awarded in an individual year, with 26 fuel cell patents, 14 production/delivery patents, and 9 storage patents.

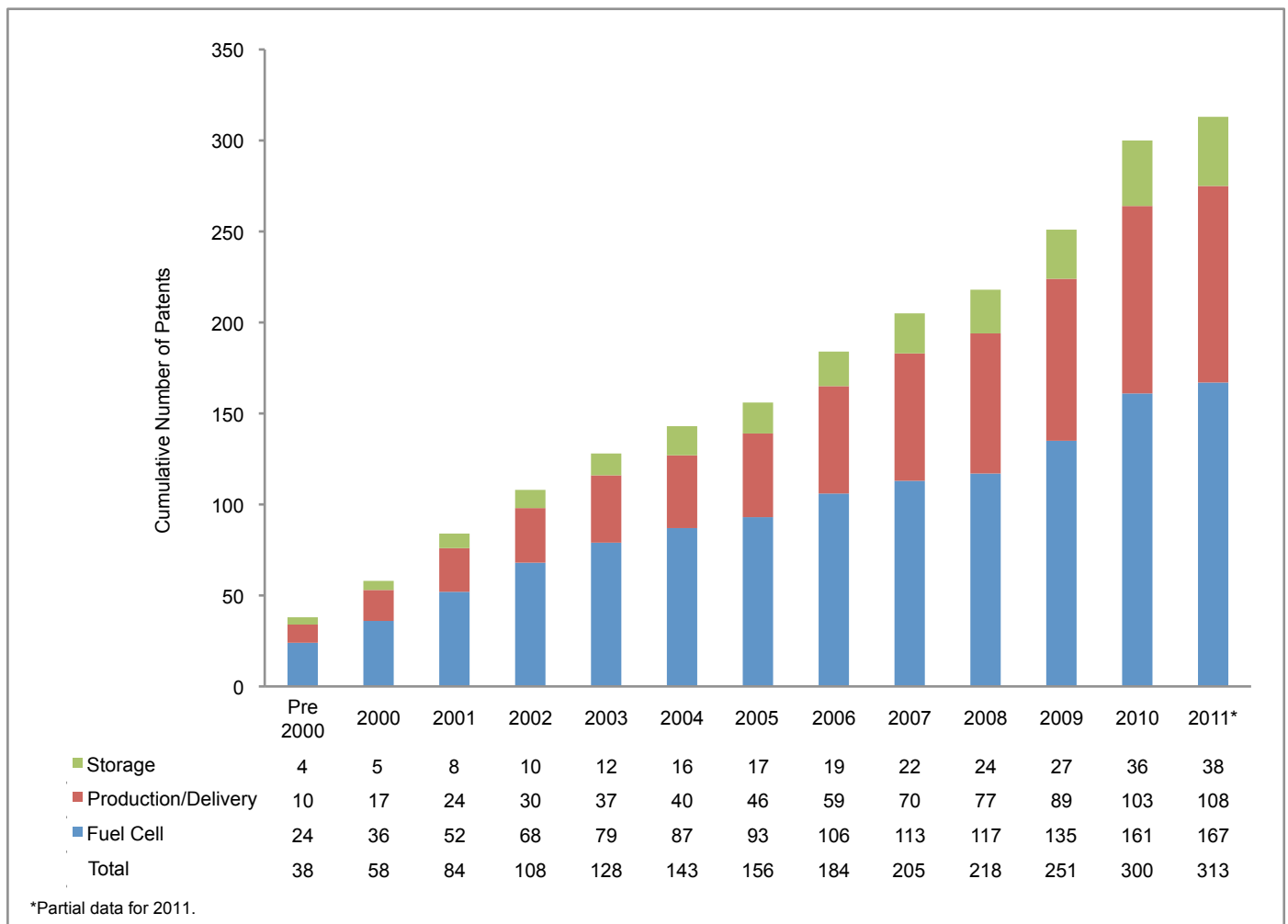

**Figure 3.1. Cumulative Number of Patents Awarded Over Time**

Another way to view the patent awards, shown in Figure 3.2, is by the type of organization that received the patent or the inventor’s employer. Three types of organizations were identified: national laboratories (138 patents), private companies (152 patents), and universities (23 patents). National laboratories and private companies account for 96% of all patents awarded for fuel cell technologies, with private companies receiving 55% of the awards. Production/delivery patents

represent the most evenly distributed category across the three types of organizations. Private companies had more patent awards in this area (48%) than national laboratories (40%), while universities had their strongest categorical representation with 12% of the production/delivery patents. National laboratories account for 68% of the storage patents, followed by private companies with 21% and universities with 11%. The national laboratories and private companies received 50% or more of their patents for fuel cell technologies, while more than half of the patents received by universities (57%) were for production/delivery technologies.

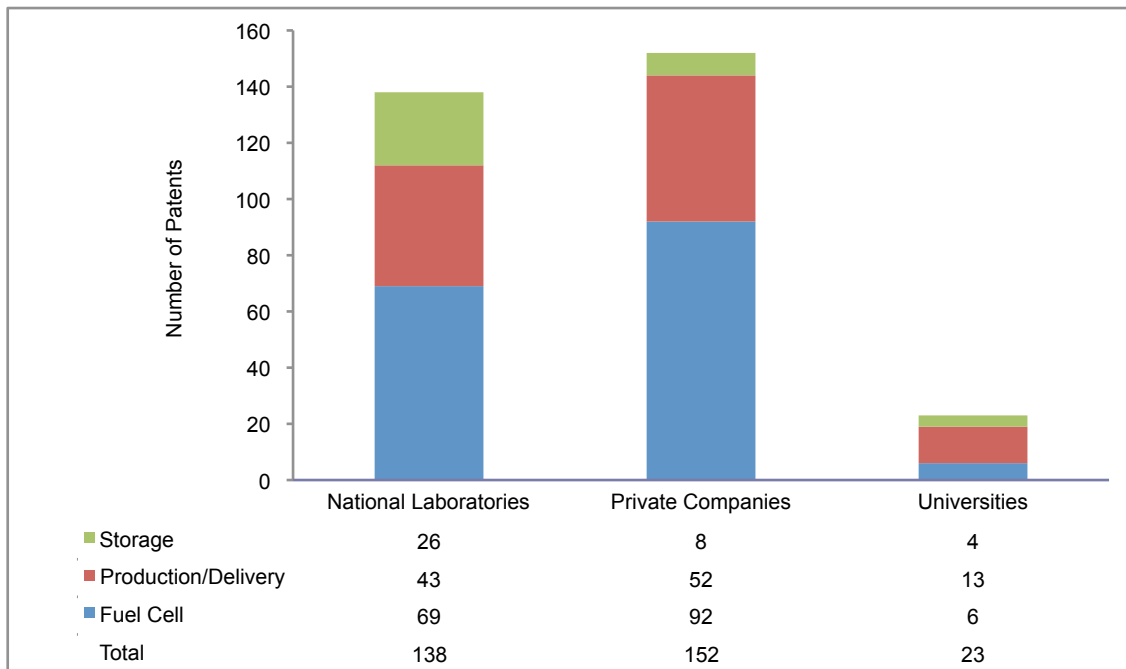
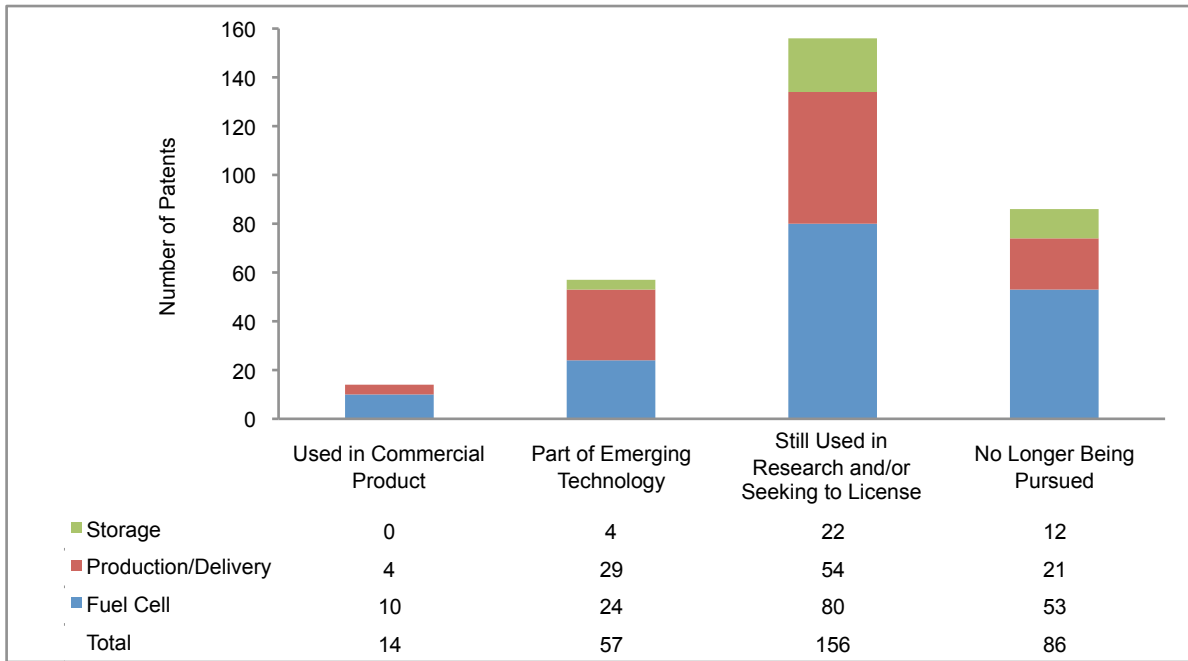

**Figure 3.2. Types of Organization Receiving Patent Awards**

Figure 3.3 shows the patent award status by use. As the figure shows, 14 patents are used in commercially available products, including:

- Bipolar plate/diffuser for a proton exchange membrane fuel cell (Patent number 6,171,720, Oak Ridge National Laboratory, 2001)
- Composite bipolar plate for electrochemical cells (Patent number 6,248,467, Los Alamos National Laboratory, 2001)
- Corrosion test cell for bipolar plates (Patent number 6,454,922, Los Alamos National Laboratory, 2002)
- Control method for high-pressure hydrogen vehicle fueling station dispensers (Patent number 7,059,364, Gas Technology Institute, 2006)
- Fuel cell and fuel cell coolant compositions (Patent number 7,138,199, Dynalene, Inc., 2006)
- Gas diffusion electrodes, membrane-electrode assemblies and method for the production thereof (Patent numbers 7,419,546 (2008), 7,601,216 (2009), and 7,785,454 (2010), BASF Corporation)
- Fuel cell electrolyte membrane with acidic polymer (Patent number 7,517,604, 3M Company, 2009)
- Fuel cell membrane electrode assembly (Patent number 7,572,534, 3M Company, 2009)
- System and method for detecting gas (Patent number 7,678,251, Proton Energy Systems, Inc., 2010)
- Gas venting system (Patent number 7,744,733, Proton Energy Systems, Inc., 2010)
- Fuel cell electrolyte membrane with basic polymer (Patent number 7,838,138, 3M Company, 2010)
- Cold weather hydrogen generation system and method of operation (Patent number 7,850,838, Proton Energy Systems, Inc., 2010).

Fifty-seven patents are part of research now taking place on emerging technologies identified on the technology tracking list in Appendix B. In addition, 156 awarded patents are still being utilized via continuing research and/or active attempts to license the patent. Of all the patents reviewed, 73% are still actively being pursued through use in continuing research, emerging technologies, or commercially available products. This was particularly true in the production/delivery area, where 87 of the 108 patents (81%) are still active. The storage and fuel cell areas both have 68% of their patents being actively pursued.



**Figure 3.3. Status of Awarded Patents**

### 3.2 Commercial and Emerging Technology Identification and Tracking Results

The FCT Program Technology Tracking Database contains 29 commercially available technologies, all of which are described in Appendix D. These descriptions were reviewed and approved by the industry POC for each technology. Figure 3.4 shows the cumulative number of commercial technologies entering the market. Of the 30 technologies that have entered the market one of them is no longer commercially available. The years 2000 through 2006 showed a steady addition of technologies entering the market of one to three per year. In 2007 and 2008, five and seven technologies entered the market, respectively. For 2009 through 2011, the rate of technologies entering the market returned to one to three per year.

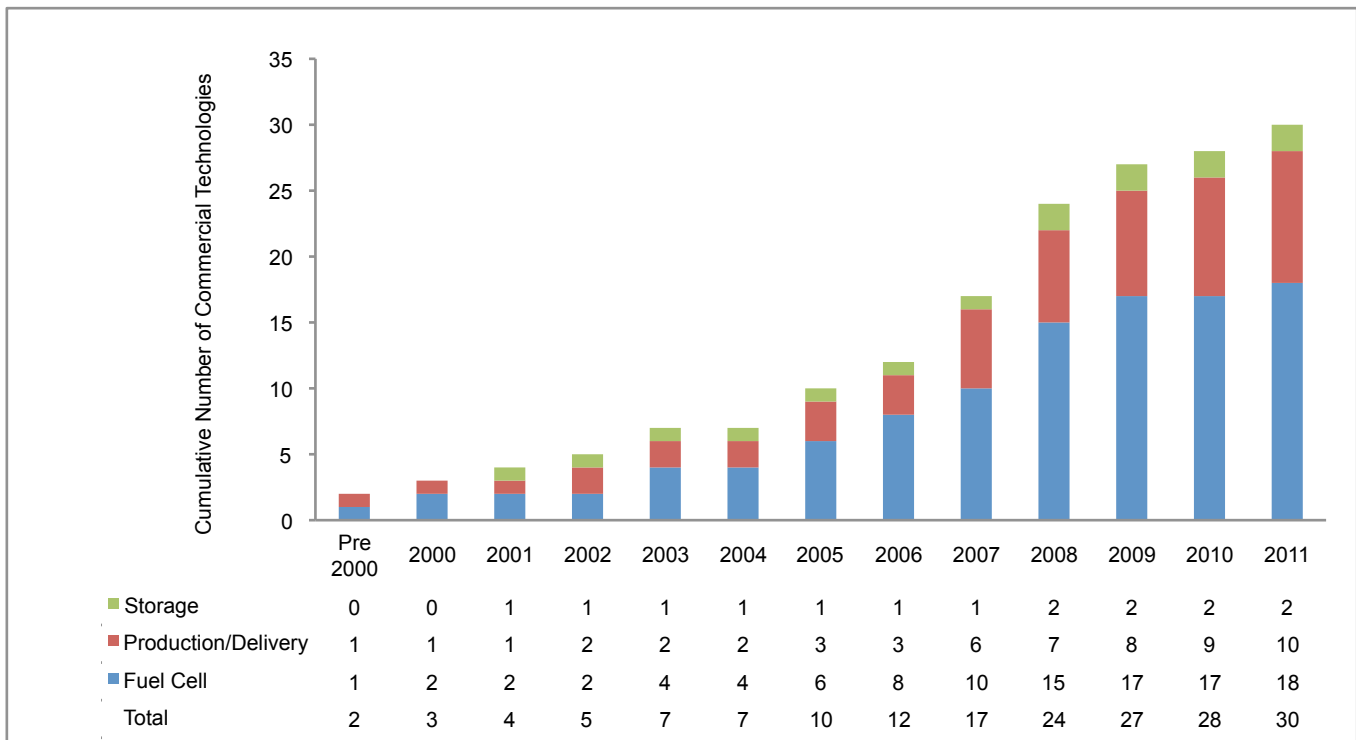

**Figure 3.4. Cumulative Number of Commercial Technologies Entering the Market**

Table 3.1 briefly describes each of the 17 commercially available fuel cell technologies and their benefits. The full descriptions of these technologies are provided in Appendix D-1. These technologies range from an analysis tool to manufacturing processes for fuel cells and their components, to entire fuel cell systems that can be used in vehicles or stationary applications.

Table 3.2 briefly describes each of the 10 commercially available production/delivery technologies and their benefits. The full descriptions of these technologies are provided in Appendix D-2. These technologies include improved catalysts, hydrogen generation systems for fueling vehicles, and technologies for providing high purity hydrogen.

Table 3.3 briefly describes the 2 commercially available storage technologies and their benefits. The full descriptions of these technologies are provided in Appendix D-3. One of the technologies is a composite tank and the other is an improved screening method for hydrogen tanks/cylinders.

The FCT Program’s Multi-Year Research, Development and Demonstration Plan, which was last updated in October 2007 (and is currently in the process of being revised), was examined to see how the commercially available technologies align with the FCT Program’s objectives and goals. The plan lists challenges and approaches for the research areas funded by FCT. The fuel cell area listed 19 challenges. The 17 commercially available technologies in Table 3.1 are aligned with 11 of these challenges, as shown in Table 3.4. Similarly, the 10 commercially available production/delivery technologies in Table 3.2 were found to align with 3 of the 13 challenges in that area, as shown in Table 3.5. The 2 commercially available storage technologies in Table 3.3 were found to align with 1 of the 7 storage approaches, as shown in Table 3.6.

The technology tracking database contains 63 emerging technologies for which descriptions are provided in Appendix E. These were reviewed and approved by the industry POC for each technology. Figure 3.5 shows the distribution of the emerging technologies in the three FCT research areas. As shown, the number of fuel cell emerging technologies is more than half of the total with emerging storage technologies making up a very small percentage.

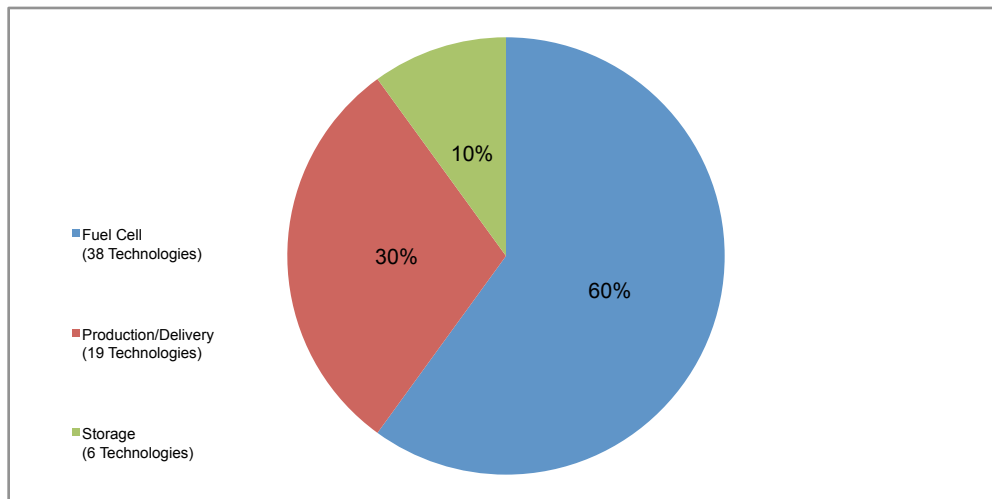

**Figure 3.5. Distribution of Emerging FCT Technologies**

Table 3.7 briefly describes each of the 38 emerging fuel cell technologies and their benefits. The full descriptions of these technologies are provided in Appendix E-1. These technologies are quite diverse and include improved fuel cell components, such as membranes, plates, assemblies, cathodes and sensors, as well as entire systems for various uses.

Table 3.8 briefly describes each of the 19 emerging production/delivery technologies and their benefits. The full descriptions of these technologies are provided in Appendix E-2. These technologies include improved membranes, reformers, and compressors, as well as novel methods and fuels to produce hydrogen.

Table 3.9 briefly describes each of the 6 emerging storage technologies and their benefits. The full descriptions of these technologies are provided in Appendix E-3. These technologies include improved tanks or cylinders, as well as new approaches for storing hydrogen.



The 38 emerging fuel cell technologies in Table 3.7 are aligned with 15 of the 19 fuel cell challenges in the FCT Program Plan, as Table 3.10 shows. Also, 3 challenges in the manufacturing research area of the plan for PEM fuel cells are aligned with 3 emerging fuel cell technologies. Similarly, the 19 emerging production/delivery technologies in Table 3.8 are aligned with 8 of the 13 production and delivery challenges in the plan, as shown in Table 3.11. The 6 emerging storage technologies in Table 3.9 are aligned with 3 of the 7 approaches in the storage area, as shown in Table 3.12.

An alphabetized directory of the organizations that developed the commercial and emerging technologies described in Appendices D and E is provided in Appendix F.

**Table 3.1. Commercial Products Summary – Fuel Cells**

Technology	Organization	Description	Benefits	Commercial Status
<a href="#">Advanced Cathode Catalysts and Supports for PEM Fuel Cells</a>	3M Company	The advanced MEA uses a carbon-free nanostructured thin-film catalyst and an ion exchange membrane to achieve longer lifetimes using fewer precious metals.	The technology reduces costs because of lower precious metal loading and manufacturing costs, improved durability, and smaller fuel cell size. It can operate at higher temperatures and lower humidity.	Commercialized in 2007 and selling to select fuel cell developers.
<a href="#">Breakthrough Lifetime Improvements for PEM Fuel Cells</a>	DuPont Fuel Cells	The Nafion® polymer technology, which can be used for both PEM fuel cells and water electrolyzers, reduces the reactive centers within the polymer to combat chemical degradation, leading to increased stability and longer life.	The technology reduces costs because of greater membrane durability and lifetime.	Commercialized in 2005.
<a href="#">Complex Coolant for Polymer Electrolyte Membrane (PEM) Fuel Cells</a>	Dynalene, Inc.	The advanced, complex coolant fluid consists of a base mixture and additives of non-ionic corrosion inhibitors and ion-suppressing nanoparticles, which maintain low electrical conductivity.	The technology eliminates de-ionizing filters, thereby reducing the overall cost and maintenance of the fuel cell while increasing the amount of time the cell can run continuously.	Commercialized in 2009 with approximately 650 gallons of coolant sold.
<a href="#">Conductive Compound for Molding Fuel Cell Bipolar Plates</a>	Bulk Molding Compounds, Inc.	The compound is a graphitized thermoset vinyl-ester, which is molded and used in producing bipolar plate (BPP) assemblies. (This technology was based on a technology licensed from Los Alamos National Laboratory.)	The compound allows thinner and less-expensive BPP assemblies to be produced; eliminates the need for expensive corrosion-resistant coatings; provides greater part flatness, creep resistance, and dimensional stability; and facilitates large-volume commercial production.	Commercialized in 2000.
<a href="#">Corrosion Test Cell for PEM Bipolar Plate Materials</a>	Fuel Cell Technologies, Inc.	To screen materials that could be used in producing corrosion-resistant bipolar plates (BPPs), the test cell simulates, as closely as possible, the conditions at the anode and cathode of a PEM fuel cell. (This technology was based on a technology licensed from Los Alamos National Laboratory.)	The test cell reduces the costs of traditional fuel cell corrosion tests, shortens the fuel cell development time, and allows for an intermediate level of BPP material screening between potentiostatic measurements and long-term fuel cell tests.	Commercialized in 2008, with two units sold.
<a href="#">Cost-Effective, High-Efficiency, Advanced Reforming Module (CHARM)</a>	Nuvera Fuel Cells, Inc.	The steam reforming module for producing hydrogen is designed to be cyclable (daily start/stop for 5 years) and runs at low pressure.	The system produces a low-cost supply of hydrogen (compared with bottles) and can minimize thermal cycling induced stress and exposure, thus increasing the lifetime of the module.	Commercialized in 2009 and being used to supply hydrogen for material-handling equipment.
<a href="#">GCtool: Fuel Cell Systems Analysis Software Model</a>	Argonne National Laboratory	The GCtool allows designers to model, analyze, and manipulate different configurations of fuel cell propulsion systems without building a functional prototype in order to address issues such as thermal and water management, design-point and part-load operations, and fuel economies.	The model saves users time and money while exploring various fuel cell system configurations. It provides developers with a library of models for subcomponents and allows them to incorporate their own models.	Sold 67 licenses since 1999.

**Table 3.1. Commercial Products Summary – Fuel Cells (Cont'd)**

Technology	Organization	Description	Benefits	Commercial Status
<a href="#">GenDrive™ Fuel Cell Power System</a> (ARRA Project)	Plug Power Inc.	A fuel-cell-based power source for electric forklift fleets that increases fleet productivity and improves forklift performance compared with conventional lead-acid batteries.	The system can be refueled with hydrogen in less than 3 minutes (compared with 10 minutes or more for a battery change), allowing operators to spend more time moving product out on the floor. Constant voltage is provided throughout the entire shift, eliminating the performance degradation experienced with batteries.	More than 400 units are currently in use at ARRA project sites.
<a href="#">Improved Catalyst Coated Membrane (CCM) Manufacturing</a>	IRD Fuel Cells LLC	The spray deposition technology uses special electrocatalyst inks and a simple manufacturing process that allows for high-volume production with a lower platinum content compared with other techniques.	The system reduces manufacturing and raw material costs. It can be used with existing spray deposition systems and allows quick changeover to different materials.	Manufacturing line for improved MEAs sold to IRD Fuel Cells, LLC in 2009, and the associated electrocatalyst inks and catalyst powders were made commercially available in 2008.
<a href="#">Improved Fuel Cell Cathode Catalysts Using Combinatorial Methods</a> (SBIR Project)	NuVant Systems Inc.	The MEA testing equipment is composed of two devices, an array potentiostat (Arraystat™) and a parallel array flow-field fuel cell, which allow rapid, accurate testing under realistic operating conditions.	The equipment allows for the preparation and testing of various MEAs in a single test stand with high throughput under realistic catalyst loadings and reactant flow rates. This eliminates random error introduced by multiple test stands and reduces the costs associated with testing MEAs.	The Arraystat was commercialized in 2006 and the parallel array fuel cell in 2007. To date seven Arraystats and seven parallel array fuel cell test units have been sold.
<a href="#">Integrated Manufacturing for Advanced Membrane Electrode Assemblies</a>	BASF Fuel Cell, Inc.	The advanced MEA fabrication process uses a new gas diffusion electrode to develop assemblies that run longer with stable voltages.	The process decreases the amount of precious metal used and reduces fabrication costs. The resulting assemblies exhibit improved stability and allow operation at extreme temperatures.	Currently marketing the Celtec® -P MEA for high temperature PEM fuel cells.
<a href="#">Manufacture of Durable Seals for PEM Fuel Cells</a>	Freudenberg-NOK General Partnership	The seals, used in fuel cell assemblies, use a custom elastomer and carrier material that provide an advanced interfacial design that exhibits superior chemical and mechanical properties compared with conventional silicones.	The seals increase durability, which reduces fuel cell operation and maintenance costs, and eliminates catalyst poisoning concerns in the fuel cell. The system can be mass-produced and leads to shorter fuel cell assembly time.	Commercialized in 2009 with more than 21,500 seals sold to date.
<a href="#">Membranes and Membrane Electrode Assemblies for Dry, Hot Operating Conditions</a>	3M Company	The advanced MEAs use a low equivalent weight, perfluorinated sulfonic acid-based membrane with improved chemical and mechanical stability, and proton conductivity.	The new MEA has improved durability and performance with increased lifetimes while operating under hot (up to 120°C), dry conditions.	Commercialized in 2006 with sales to a wide variety of fuel cell customers for stationary and automotive applications.
<a href="#">Novel Manufacturing Process for PEM Fuel Cell Stacks</a>	Protonex Technology Corporation	The one-step molding process creates the structure necessary to seal the stack and five layer MEAs. Two portable power system product lines for military customers are now using it.	The process lowers costs because fewer components with lower tolerances are used. It reduces part count and manufacturing time and improves stack fabrication reliability.	Delivered over 30 M250-CX and M300-CX systems through 2010.

**Table 3.1. Commercial Products Summary – Fuel Cells (Cont’d)**

Technology	Organization	Description	Benefits	Commercial Status
<a href="#">Portable Reformed Methanol Fuel Cells</a>	UltraCell Corporation	The XX25 fuel cell, using methanol as a fuel source, is a self-contained, 25-watt output power system that can be used by individual soldiers for portable power. Fuel cartridges can be hot swapped for continuous operation, and the fuel cell can be hybridized with external batteries for high power peaks or with a 5-gallon fuel tank for long run time.	The fuel cell features a rugged, lightweight (1.24 kg), reliable power system that uses a contained fuel with no toxic byproducts during use. It contains no moving parts that can fail.	Commercialized in 2007, with more than 400 units sold.
<a href="#">PureMotion® 120 Fuel Cell Power Plant</a>	UTC Power	The powerplant can be used as a power source for hydrogen-powered vehicles or as a stationery, 120-kW power source.	The power system reduces costs through mass manufacturing, produces only water as a byproduct, and uses hydrogen produced from various sources, including renewables.	First unit deployed in 2005 with two older units still in use on buses and 16 next generation buses delivered in 2010.
<a href="#">Scale-Up of Carbon-Carbon Composite Bipolar Plates</a>	Porvair Advanced Materials, Inc.	A carbon-carbon composite bipolar plate (BPP) formation technology was licensed and transferred from laboratory to full-scale production to produce low-cost BPPs using high-volume manufacturing with no machining. (This technology was based on a technology licensed from Oak Ridge National Laboratory.)	The resulting BPPs minimize contact resistance between cells, resist corrosion, are lightweight (1.2 grams per cc), and cost <\$4 per kW. The process allows for molding a wide variety of product designs.	Manufactured more than 50,000 BPPs since 2003.

**Table 3.2. Commercial Products Summary – Production/Delivery**

Technology	Organization	Description	Benefits	Commercial Status
<a href="#">FuelGen® Hydrogen Fueling Systems</a>	Proton Energy Systems, Inc.	The fueling station uses electrolysis to produce 99.999% pure hydrogen from water using electricity, which can come from wind or solar energy. The system can generate over 13 kg per day at pressures up to 400 psi.	The system produces high purity hydrogen without requiring additional cleanup, can be installed and operating within a day, requires only four hours of maintenance per year, and can use renewable energy sources.	Commercialized in 2007, with six units sold and five currently operating.
<a href="#">H2 ProGen: A Total Supply Solution for Hydrogen Vehicles</a>	GreenField Compression	The integrated, on-site hydrogen generation, purification, compression, storage, and dispensing system deploys quickly and produces 20 to 200 kg of hydrogen per day by reforming natural gas, propane, E-85, biodiesel, or other liquids. Alternatively, it can use electrolysis for hydrogen production. The dispenser can be purchased individually or as part of the system.	The system can produce hydrogen from various sources, achieves full-cycle energy savings compared with trucked-in hydrogen, and is delivered as a pre-assembled system, thereby minimizing costs and setup time.	Commercialized in 2007, with one fuel station in use at the University of Texas in Austin.
<a href="#">High-Efficiency, High-Pressure Electrolysis via Photovoltaic Arrays</a>	Avalence, LLC	The system links a photovoltaic power supply to an ultra-high-pressure electrolysis unit that can generate 1 to 30 kg of fuel-grade hydrogen per day at pressures consistent with point-of-use storage and delivery (5,000 to 10,000 psi).	The system delivers pressurized hydrogen without additional compression and can potentially reduce hydrogen production and operating costs.	Commercialized in 2007, with 8 units sold and operating in the field and several more in production.
<a href="#">Hydrogen Distributed Production System</a>	Air Liquide Process and Construction	The HGM-2000 uses a built-in pressure swing adsorption system that produces 565 kg of hydrogen per day at 200 to 300 psig at a fuel efficiency of up to 78% (based on the higher heating value).	The system cuts high-purity hydrogen costs by up to 50% compared with trucked-in hydrogen, is highly efficient, and uses a modular design that eliminates the need for large-scale hydrogen infrastructure. It allows remote monitoring without the need for staffing.	Became commercially available in 2008.
<a href="#">Hydrogen Generation from Electrolysis</a>	Proton Energy Systems, Inc.	The HOGEN® electrolysis-based hydrogen generator incorporates a PEM and produces 99.999% pure hydrogen at 90 to 275 grams per hour at pressures up to 400 psi without requiring additional compression.	The system is very compact, can be installed in less than a day, is very reliable, and produces high-purity hydrogen.	Commercialized the HOGEN S series in 1999, selling 177 units in the U.S. and 213 internationally through 2010. Commercialized the HOGEN H series in 2004, selling 78 units in the U.S. and 76 internationally through 2010.
<a href="#">Hydrogen Safety Sensor for Advanced Energy Applications</a>	NexTech Materials, Ltd.	A chemi-resistive three-phase ceramic sensor exhibits a highly sensitive (500 ppm to 1%), selective (no interference from CO, CH4, or VOC), and rapid response to the presence of hydrogen in ambient air, even with varying humidities and background combustible gases.	Because of its low materials and fabrication cost, minimal power consumption, and wide detection range, the sensor lends itself to wide-scale implementation in any application requiring the safe use or handling of hydrogen gas. It is durable and reliable, with fast response and recovery times.	Commercialized in 2010 and sold 100 to 200 units to date.

**Table 3.2. Commercial Products Summary – Production/Delivery (Cont’d)**

Technology	Organization	Description	Benefits	Commercial Status
<a href="#">ME100 Methanol Reforming Hydrogen Generator</a> (SBIR Project)	REB Research & Consulting	The generator is constructed with palladium-coated membranes within the reactor zone and can produce 99.99995% pure hydrogen independent of back-pressure changes or variable loads at a variable rate of up to 10 kg per day at pressures up to 40 psig.	The generator produces very high purity independent of back pressure changes caused by varying fuel cell demand. It produces hydrogen at costs far lower than bottled gas from a readily available feedstock (methanol). The system is compact, reliable, and ideal for remote and mobile applications.	More than 15 ME100 hydrogen generator systems sold since 2002.
<a href="#">Membrane Structures for Hydrogen Separation</a> (SBIR Project)	Genesis Fueltech, Inc.	The low-cost membrane to separate hydrogen from other gases in the reforming process is used in a purifier module that can be scaled to larger sizes to increase capacity.	The low-cost purifier has improved mechanical support and sealing, as well as improved alloys for higher hydrogen flux.	Commercialized in 2009.
<a href="#">Nanoscale Water Gas Shift Catalysts</a>	NexTech Materials, Ltd.	The water gas shift catalysts are based on ceria-supported precious metals that can be tailored to specific reactions/ conditions (i.e., steam reforming and/or the partial oxidation of various hydrocarbons) and can be used for small reactors and/or reactors with multiple startup-shutdown cycles.	The catalysts are available in multiple forms and allow applications to perform efficiently over a wide range of temperatures.	Commercialized in 2005 with >\$300,000 in sales to date.
<a href="#">PEM Electrolyzer Incorporating an Advanced Low-Cost Membrane</a>	Giner Electrochemical Systems, LLC	An electrolysis system that produces 0.5 kg-H <sub>2</sub> /hr at 350 psig and uses an advanced dimensionally stable membrane with improved durability under high-pressure conditions.	The electrolyzer stack capital cost has been reduced to <\$500/kW by using low-cost materials, lower catalyst loading, and a reduced part count per cell. The system can make use of renewable electricity sources such as wind and solar.	Commercialized in 2011. GES has delivered 2 stacks and has taken orders for several more.

**Table 3.3. Commercial Products Summary – Storage**

Technology	Organization	Description	Benefits	Commercial Status
<a href="#">Hydrogen Composite Tanks</a>	Quantum Technologies, Inc.	For storage applications at 5,000 and 10,000 psig, the hydrogen tank uses a seamless, one-piece, ultra-high-molecular-weight polymer liner wrapped in layers of a carbon fiber/epoxy laminate and a proprietary external protective layer for impact resistance.	The 10,000-psig tank offers a high-capacity, lightweight, safe hydrogen storage system that exceeds regulatory safety requirements and may increase a hydrogen-powered vehicle’s driving range by >55% compared with equivalent-sized 5,000-psig tanks.	Since 2001, sold more than 2,000 storage tank systems, primarily to major automobile manufacturers.
<a href="#">Non-Destructive Ultrasonic Scanning Technology</a>	Digital Wave Corporation	The nondestructive testing method uses sound waves and stacks of polyvinylidene film piezoelectric transducers that can rapidly detect a wide range of flaws in various materials, including metals, polymers, ceramics, and composites.	The testing method rapidly and accurately detects flaws before they cause catastrophic failure and tests a wide range of cylinder geometries and material types.	Commercialized in 2008 with 30 testing units in use.

**Table 3.4. Fuel Cell Challenges and Related Commercial Technologies**

Challenges*	Technology Title	Organization
Develop membranes that meet all targets	<a href="#">Breakthrough Lifetime Improvements for PEM Fuel Cells</a>	DuPont Fuel Cells
	<a href="#">Improved Catalyst Coated Membrane (CCM) Manufacturing</a>	IRD Fuel Cells LLC
Develop MEAs that meet all targets	<a href="#">Advanced Cathode Catalysts and Supports for PEM Fuel Cells</a>	3M Company
	<a href="#">Improved Fuel Cell Cathode Catalysts Using Combinatorial Methods</a>	NuVant Systems Inc.
	<a href="#">Integrated Manufacturing for Advanced Membrane Electrode Assemblies</a>	BASF Fuel Cell, Inc.
	<a href="#">Membranes and Membrane Electrode Assemblies for Dry, Hot Operating Conditions</a>	3M Company
Develop low-cost, durable bipolar plates that meet all targets	<a href="#">Conductive Compound for Molding Fuel Cell Bipolar Plates</a>	Bulk Molding Compounds, Inc.
	<a href="#">Scale-Up of Carbon-Carbon Composite Bipolar Plates</a>	Porvair Advanced Materials, Inc.
Develop efficient, cost-effective thermal/water management systems	<a href="#">Complex Coolant for Polymer Electrolyte Membrane (PEM) Fuel Cells</a>	Dynalene, Inc.
Develop reliable, durable, low-cost seals	<a href="#">Manufacture of Durable Seals for PEM Fuel Cells</a>	Freudenberg-NOK General Partnership
Develop cost-effective, efficient, reliable and durable fuel cells for stationary applications that meet all targets	<a href="#">Cost-Effective, High-Efficiency, Advanced Reforming Module (CHARM)</a>	Nuvera Fuel Cells, Inc.
	<a href="#">PureMotion® 120 Fuel Cell Power Plant</a>	UTC Power
Develop cost-effective, reliable, durable fuel cells for portable power applications (e.g., cell phones, computers, etc.) that meet all targets	<a href="#">Portable Reformed Methanol Fuel Cells</a>	UltraCell Corporation
Conduct system and tradeoff analysis	<a href="#">GCtool: Fuel Cell Systems Analysis Software Model</a>	Argonne National Laboratory
Develop system to allow PEM fuel cells to operate in off-road applications	<a href="#">GenDrive™ Fuel Cell Power System</a>	Plug Power Inc.
Test and evaluate fuel cell components and systems	<a href="#">Corrosion Test Cell for PEM Bipolar Plate Materials</a>	Fuel Cell Technologies, Inc.
Develop innovative fuel cell designs that provide improved performance, durability and cost	<a href="#">Novel Manufacturing Process for PEM Fuel Cell Stacks</a>	Protonex Technology Corporation

\* Note: These challenges are described in the FCT Program Multi-Year Plan at [http://www1.eere.energy.gov/hydrogenandfuelcells/mypp/pdfs/fuel\\_cells.pdf](http://www1.eere.energy.gov/hydrogenandfuelcells/mypp/pdfs/fuel_cells.pdf).



**Table 3.5. Production/Delivery Challenges and Related Commercial Technologies**

<b>Challenges*</b>	<b>Technology Title</b>	<b>Organization</b>
Cost reduction of distributed hydrogen production from natural gas and bio-derived liquids	<a href="#">H2 ProGen: A Total Supply Solution for Hydrogen Vehicles</a>	GreenField Compression
	<a href="#">Hydrogen Distributed Production System</a>	Air Liquide Process and Construction
	<a href="#">ME100 Methanol Reforming Hydrogen Generator</a>	REB Research & Consulting
	<a href="#">Nanoscale Water Gas Shift Catalysts</a>	NexTech Materials, Ltd.
Hydrogen production from water via electrolysis	<a href="#">FuelGen® Hydrogen Fueling Systems</a>	Proton Energy Systems, Inc.
	<a href="#">High-Efficiency, High-Pressure Electrolysis via Photovoltaic Arrays</a>	Avalence, LLC
	<a href="#">Hydrogen Generation from Electrolysis</a>	Proton Energy Systems, Inc.
	<a href="#">PEM Electrolyzer Incorporating an Advanced Low-Cost Membrane</a>	Giner Electrochemical Systems, LLC
Separation and purification systems	<a href="#">Hydrogen Safety Sensor for Advanced Energy Applications</a>	NexTech Materials, Ltd.
	<a href="#">Membrane Structures for Hydrogen Separation</a>	Genesis Fueltech, Inc.

\* Note: These challenges are described in the FCT Program Multi-Year Plan at [http://www1.eere.energy.gov/hydrogenandfuelcells/mypp/pdfs/fuel\\_cells.pdf](http://www1.eere.energy.gov/hydrogenandfuelcells/mypp/pdfs/fuel_cells.pdf).

**Table 3.6. Storage Approaches and Related Commercial Technologies**

<b>Approaches*</b>	<b>Technology Title</b>	<b>Organization</b>
Compressed, cryo-compressed and conformal hydrogen tanks	<a href="#">Hydrogen Composite Tanks</a>	Quantum Technologies, Inc.
	<a href="#">Non-Destructive Ultrasonic Scanning Technology</a>	Digital Wave Corporation

\* Note: The storage approaches are described in the FCT Program Multi-Year Plan at <http://www1.eere.energy.gov/hydrogenandfuelcells/mypp/pdfs/storage.pdf>.



**Table 3.7. Emerging Products Summary – Fuel Cells**

Technology	Organization	Description	Benefits
<a href="#">Alternative and Durable High-Performance Cathode Supports for PEM Fuel Cells</a>	Pacific Northwest National Laboratory	An advanced support structure for cathodes used in PEM fuel cells. The technology takes advantage of the stable interface between platinum, a conductive metal oxide, and a honeycombed carbon support.	The support structures increase cathode performance and durability, and are synthesized using a method that can be easily scaled up for high-volume manufacturing.
<a href="#">CIRRUS: Cell Ice Regulation and Removal Upon Start-up</a>	Nuvera Fuel Cells, Inc.	The Orion™ fuel cell exploits higher current density operation to increase the power density of the stack and reduce its thermal mass, enhancing freeze starting ability.	The new fuel cell has improved performance in sub-freezing conditions including increased fuel cell stack power density, improved water purging prior to cold shutdown, and avoidance of significant degradation of stack materials after 200 freeze startup/shutdown cycles.
<a href="#">Dimensionally-Stable High-Performance Membrane (SBIR Project)</a>	Giner Electrochemical Systems, LLC	The robust PEM material uses a high-performance plastic support structure, which allows lower-equivalent-weight ionomers to be used without forfeiting mechanical durability.	Because of its mechanical properties, the new membrane prevents stress-induced failure and improves performance at low humidity and high temperature.
<a href="#">Direct Methanol Fuel Cell (DMFC) Anode Catalysts</a>	National Renewable Energy Laboratory	An improved anode catalyst for direct methanol fuel cells. The catalyst is manufactured using ion implantation and magnetron sputtering of platinum-ruthenium (PtRu) on high-surface-area carbon support materials.	The new PtRu catalyst materials have shown up to 30% improvement in methanol oxidation reaction activity and increase the durability of membrane electrode assemblies.
<a href="#">Direct Methanol Fuel Cell for Handheld Electronics Applications</a>	MTI Micro Fuel Cells, Inc.	The Mobion® direct methanol fuel cell (DMFC) uses passive means for water and air management to simplify the conventional DMFC process, resulting in a smaller and simpler fuel cell for handheld applications. Received American Recovery and Reinvestment Act (ARRA) funding to facilitate commercialization.	The device uses methanol fuel instead of hydrogen, avoiding hydrogen-handling issues. Using micro fuel cells for handheld electronics may extend device operating times between charges and enhance device versatility.
<a href="#">Direct-Write Inkjet Printing for Fabricating Hydrogen Sensors (SBIR Project)</a>	InnoSense, LLC	The hydrogen sensor was developed using high-output, inkjet printing manufacturing techniques and detects hydrogen at concentrations from 1% to 75%.	The high-volume fabrication process produces safe, all-optical sensors and eliminates the individual calibration of sensors by making many identical sensors in one batch.
<a href="#">Durable Catalysts for Fuel Cell Protection During Transient Conditions</a>	3M Company	The new catalyst materials alleviate the damaging effects of transient conditions (e.g., startup, shutdown, and fuel starvation) on fuel cells. The materials are being developed by modifying the catalyst's behavior so that oxidation of water instead of carbon corrosion is the preferred reaction during transient conditions.	Fuel cell durability is improved by controlling catalyst reaction behavior during transient conditions. Low platinum-group-metal loading reduces material costs.
<a href="#">Engineered Nanostructured MEA Technology for Low-Temperature Fuel Cells</a>	Nanosys, Inc.	A nanowire-supported platinum cobalt (PtCo) catalyst for PEM fuel cells increases catalyst mass activity relative to commercially available platinum carbon (Pt/C) catalysts while using reduced amount of precious metal catalyst.	The new catalyst support structure ensures a high catalyst utilization, enables a higher power density using low catalyst loading, and ensures a superior durability compared with conventional carbon-supported catalysts.

**Table 3.7. Emerging Products Summary – Fuel Cells (Cont'd)**

Technology	Organization	Description	Benefits
<a href="#">Extended, Continuous Pt Nanostructures in Thick, Dispersed Electrodes</a>	National Renewable Energy Laboratory	The nanostructured platinum (Pt) catalysts have extended surface areas and show improved specific activity and durability compared with traditional Pt catalysts supported on carbon (Pt/C). The catalysts are synthesized from metal nanowire templates using the spontaneous galvanic displacement process.	The new catalysts achieve increased performance (specific activity) and durability compared with traditional Pt/C catalysts and reduce material costs by using less Pt.
<a href="#">FARADAYIC ElectroEtching of Stainless Steel Bipolar Plates</a>	Faraday Technology, Inc.	The new manufacturing process, FARADAYIC ElectroEtching, is based on electrochemical through-mask etching and is producing stainless steel bipolar plates with advanced flow channel designs that cannot be manufactured cost-effectively using more conventional machining techniques.	The new manufacturing process reduces the overall manufacturing cost of bipolar plates through use of a high-volume batch process with low capital equipment and tooling costs.
<a href="#">Fuel Cell Membrane Measurement System for Manufacturing</a> (SBIR Project)	Scribner Associates, Inc.	The Rapid Membrane Measurement System uses a proprietary electrode design for robust long-term operation, custom measurement and control hardware and software, and state-of-the-art electrochemical measurement methods.	The system rapidly (a few minutes per test) and accurately measures the through-thickness ionic resistance of fuel cell membranes under controlled temperatures and humidity and may allow for more consistent results, higher productivity, and lower manufacturing costs because of waste reduction.
<a href="#">Fuel-Cell-Based Mobile Lighting</a>	Sandia National Laboratories	The fuel cell mobile lighting system uses a 5-kW, hydrogen-fueled PEM fuel cell stack to power high-efficiency plasma lighting. The system is an energy-efficient, environmentally-friendly alternative to the diesel-fueled generators currently used to power most portable lighting equipment.	The system produces zero emissions at the point of use, reduces noise compared with diesel generators, and can be used in indoor or outdoor applications. The use of a fuel cell power source and plasma lighting maximizes the unit's overall energy efficiency.
<a href="#">GenSys® Blue: High-Temperature CHP Fuel Cell System</a> (ARRA Project)	Plug Power Inc.	The GenSys® Blue is a high-temperature PEM fuel cell system that provides up to 5 kW of electricity and 28,000 Btu/hr of usable heat for residential and light commercial applications. The system achieves electrical and CHP efficiencies of 30% and 85%, respectively.	The high-efficiency system reduces residential utility bills and CO <sub>2</sub> emissions. The unit can be easily integrated with existing heating systems because it produces waste heat of a sufficient temperature to meet thermal comfort demands.
<a href="#">High-Efficiency Polymer Electrolyte Membrane Fuel Cell Combined Heat and Power System</a>	Intelligent Energy Inc.	The CHP system is composed of two main parts: a fuel processor, that uses hydrocarbon feedstock in a steam-methane reforming reaction and water-gas shift reaction to produce hydrogen, and a PEM fuel cell that uses the hydrogen for electricity production. Heat is recovered from the fuel cell and the fuel processor and can be used for a variety of applications.	The system achieves 35% electrical efficiency with greater than 70% combined efficiency possible, depending on the application. The modular and scalable design allows for easy installation and the unit can be configured to provide emergency backup power in the event of a grid failure.
<a href="#">High-Performance, Low-Pt Cathodes Containing New Catalysts and Layer Structure</a>	Cabot Superior MicroPowders	Applying an approach to formulate and test low-Pt cathodes has led to six Pt-alloy compositions that demonstrate up to a two-fold improvement in performance compared with pure Pt electrocatalysts.	Reducing Pt in cathodes reduces costs (Pt is very expensive), and in some cases, improves performance and durability. The new formulation and testing approach allow rapid synthesis and testing of electrocatalysts, thus reducing research costs.

**Table 3.7. Emerging Products Summary – Fuel Cells (Cont’d)**

<b>Technology</b>	<b>Organization</b>	<b>Description</b>	<b>Benefits</b>
<a href="#">High-Temperature Membrane with Humidification-Independent Cluster Structure</a>	FuelCell Energy, Inc.	The composite fuel cell membrane has enhanced ionic conductivity and mechanical properties, allowing the fuel cell to retain water and maintain proton conductivity and mechanical integrity at low humidities and elevated temperatures.	The membrane improves fuel cell durability, reduces system costs, and improves performance over extreme and fluctuating humidity and temperature conditions.
<a href="#">Improved Low-Cost, Durable Fuel Cell Membranes</a>	Arkema Inc.	The fuel cell membrane technology uses semi-interpenetrated networks of Kynar® polyvinylidene fluoride and proprietary polyelectrolytes to decouple proton conductivity from all other requirements.	The membrane offers good mechanical properties, excellent resistance to hydrogen and oxygen, similar ex-situ conductivity to that of Nafion®, excellent durability in cycling tests, and a low cost potential.
<a href="#">Low-Cost 3-10 kW Tubular SOFC Power System</a>	Acumentrics Corporation	The system is a natural gas based SOFC which is being developed for use as a micro CHP unit to provide electricity and hot water in residential applications. The system has demonstrated an electrical efficiency of 35%-40% and a CHP energy efficiency of 85%.	The system handles readily available fuels such as natural gas and propane, without requiring an external reformer to produce hydrogen. On-site simultaneous generation of heat and power will increase efficiency and lower energy costs to consumers.
<a href="#">Low-Cost Hydrogen Sensor for Transportation Safety</a>	Makel Engineering, Inc.	The micro electromechanical systems hydrogen sensor system incorporates a highly sensitive Schottky diode made of a palladium alloy on a silicon substrate for measurements in the low concentration range (50 ppm to a few percent). It can provide low-cost hydrogen leak monitoring in fuel cell vehicles, stationary fuel cells, or other areas where hydrogen leaks might occur.	The sensor is low-cost and compact, has low power consumption, can be mass-produced, and operates in suboptimal environmental conditions.
<a href="#">Low-Cost Manufacturing of Sheet Molding Compound Bipolar Plates for PEM Fuel Cells</a> (SBIR Project)	Nanotek Instruments, Inc.	A new system is being developed to produce low-cost/high-performance bipolar plates for fuel cells using sheet molding compound manufacturing techniques. Use of the new roll-to-roll system for producing multiple layer bipolar plates will allow large-scale manufacturing.	The new system optimizes the composition and forming process, improving the performance of the bipolar plates while reducing the manufacturing cost.
<a href="#">Low Platinum Loading Fuel Cell Electro catalysts</a>	Brookhaven National Laboratory	The patented anode electro catalysts have low platinum (Pt) loading that resists CO poisoning.	The electro catalysts are cost effective to fabricate because of the extensive use of noble metals (rather than Pt) and are more durable, thereby promising an improved fuel cell lifetime.
<a href="#">Manufacturing of Low-Cost, Durable Membrane Electrode Assemblies</a>	W.L. Gore and Associates, Inc.	A high-volume manufacturing process for producing low-cost, durable, high-power-density, three-layer MEAs that require minimal conditioning. The process is scalable to industry MEA volume targets of 500,000 systems per year.	MEAs produced using the new manufacturing process have withstood 9,000 hours of durability testing in an 80°C automotive duty cycle, exceeding DOE’s 2015 target by 5,000 hours. The MEAs also have improved power density and conditioning times of less than 4 hours. The use of high-volume manufacturing reduces fuel cell costs.

**Table 3.7. Emerging Products Summary – Fuel Cells (Cont'd)**

<b>Technology</b>	<b>Organization</b>	<b>Description</b>	<b>Benefits</b>
<a href="#">Materials and Modules for Low-Cost, High-Performance Fuel Cell Humidifiers</a>	W.L. Gore and Associates, Inc.	A system that uses the product water from a hydrogen fuel cell's reaction to humidify the incoming reactant gases on the cell's anode and cathode sides. The system contains an inexpensive and durable composite membrane consisting of an ionomer layer sandwiched between micro porous polymer layers. The membrane is capable of high water transport rates and prevents gas crossover from occurring.	The system improves the performance and longevity of fuel cell electrolyte membranes by controlling reactant gas humidity, which is essential for maintaining proper membrane hydration.
<a href="#">Multi-Fuel Solid Oxide Fuel Cell (SOFC) System</a>	Technology Management, Inc.	The 1-kW modular, multi-fuel SOFC system is designed to produce electricity and heat for multiple mobile and on-site stationary applications.	The SOFC system is inherently flexible and sulfur tolerant and can operate on multiple renewable and conventional fuels, including biodiesel, vegetable oils, ethanol, diesel, kerosene, natural gas, and propane.
<a href="#">Nitrided Metallic Bipolar Plates for PEM Fuel Cells</a>	Oak Ridge National Laboratory	The technique deposits a thin Cr-nitride coating on stainless steel bipolar plates to form an electrically conductive, defect-free, corrosion-resistant surface layer, even on complex surface geometries.	This technique allows for low-cost, high-volume production techniques that will reduce the net cost of fuel cells and improve their longevity and durability.
<a href="#">Platinum and Fluoropolymer Recovery from PEM Fuel Cells</a>	Ion Power, Inc.	The process dissolves the used PEMs into a slurry, which is then processed to separate the Pt and Nafion® for re-use.	The process eliminates hydrofluoric acid emissions typical of other recycling methods in use today. It reduces PEM fuel cell replacement costs by recovering valuable materials from used cells.
<a href="#">Platinum-Group-Metal Recycling Technology</a>	BASF Catalysts LLC	The technology recovers >98% of the platinum from various MEAs, independent of MEA aging history, membrane construction, or electrocatalyst composition.	The technique eliminates the need for hydrofluoric acid remediation, and batching multiple fuel cell types eliminates manual separation labor in the recycling process.
<a href="#">Platinum Monolayer Electrocatalysts on Stable Low-Cost Supports</a>	Brookhaven National Laboratory	The high-surface-area electrocatalysts have a platinum (Pt) monolayer that is deposited on top of transition metal nanostructures. These catalysts, which are used in the fuel cell's oxygen reduction reaction, have a much higher activity per mass of Pt than pure Pt nanoparticles.	The new catalysts achieve high activity for the oxygen reduction reaction, resist Pt dissolution under cycling conditions, and reduce costs by reducing Pt loading.
<a href="#">Polymer Electrolyte Membrane (PEM) Fuel Cell Power Plant Development and Verification</a>	UTC Power	A low-cost, high-durability stationary fuel cell uses a 5-kW system platform that is rack-mounted, weighs 100 kg, is self-contained (not including fuel), and consumes about 0.5 kg of hydrogen per 1.5 hours.	The system provides seamless, clean power during blackouts and is compact, reliable, and low maintenance.
<a href="#">Portable Solid Oxide Fuel Cell Generator (ARRA Project)</a>	Jadoo Power Systems, Inc.	A portable generator that uses a solid oxide fuel cell as the power element and propane as the fuel. The system provides 1 kW of power for up to 8 continuous hours and operates at ≥30% efficiency for at least 2,000 hours of runtime.	The system reduces the emissions and localized noise issues associated with the use of internal combustion engine portable generators.

**Table 3.7. Emerging Products Summary – Fuel Cells (Cont’d)**

Technology	Organization	Description	Benefits
<a href="#">PowerEdge™ Fuel Cell System</a> (ARRA Project)	Nuvera Fuel Cells, Inc.	A fuel-cell-based power source for electric forklift fleets that increases fleet productivity and improves forklift performance compared with conventional lead-acid batteries.	The system can be refueled with hydrogen in less than 2 minutes (compared with 10 minutes or more for a battery change), allowing operators to spend more time moving product out on the floor. Constant voltage is provided throughout the entire shift, eliminating the performance degradation experienced with batteries.
<a href="#">Reduction in Fabrication Costs of Gas Diffusion Layers</a>	Ballard Material Products, Inc.	The new gas diffusion layer (GDL) manufacturing process produces continuous rolls of GDL material and reduces GDL fabrication costs by 60%. Cost-saving measures used in the process include replacing batch processes with continuous ones, implementing on-line control systems, and reducing the number of process steps.	The new process reduces GDL costs through high-volume manufacturing and improves GDL quality and uniformity by using real-time process monitoring.
<a href="#">Resin-Impregnated, Expanded-Graphite GRAFCELL® Bipolar Plates</a>	GrafTech International Ltd.	The bipolar plate uses expanded graphite in conjunction with an advanced high-temperature resin system that is designed for high-volume production.	The system results in improved gas impermeability, low contact resistance, high thermal/electrical conductivity, and improved mechanical strength. The plates continuously operate at temperatures up to 120°C.
<a href="#">Sensors for Automotive Fuel Cell Systems</a>	NexTech Materials, Ltd.	The H <sub>2</sub> S sensor operates by a reversible change in resistance caused by adsorption and desorption of H <sub>2</sub> S in a film of H <sub>2</sub> S-sensitive material. It can detect H <sub>2</sub> S from 25 ppb to 10 ppm, with response times of less than one minute.	The sensor will detect H <sub>2</sub> S in the hydrogen stream, alerting operators so they can protect the cell stack from damage. This will increase membrane life, allow fuel cells to remain online longer, and extend the life of guard beds used to remove sulfur from hydrocarbon fuels before they are processed into hydrogen.
<a href="#">Silicon-Based Solid Oxide Fuel Cell for Portable Consumer Electronics</a>	Lilliputian Systems, Inc.	A miniature SOFC for the consumer portable power market is fabricated on a silicon chip and is fueled by butane from an on-board cartridge. The device delivers 2.5 watts of power with a run time of more than 30 hours per cartridge and plugs into various portable electronics via a USB cable connection.	The technology can be used as an alternative to conventional wall outlet and battery-based devices for charging portable consumer electronics. It provides convenient, on-the-go power and has been approved by the Federal Aviation Administration for passenger use on airplanes.
<a href="#">Solid Acid Fuel Cell Stack for Auxiliary Power Unit Applications</a>	SAFCCell, Inc.	The solid acid fuel cell stack generates electricity using hydrogen from a variety of commercial fuel reformat sources, including diesel fuels commonly used in the trucking industry. The technology offers near silent operation, quick start-up time, and the ability to handle start-stop cycling.	The technology can operate reliably on a variety of gas and liquid fuel reformat and reduces emissions by providing a more fuel-efficient alternative to auxiliary power generated from combustion engines. The stacks can be manufactured by low-cost, high-volume methods because of the solid nature of the electrolyte and the use of metal and polymer components.

**Table 3.7. Emerging Products Summary – Fuel Cells (Cont'd)**

Technology	Organization	Description	Benefits
<a href="#">Solid Oxide Fuel Cell Auxiliary Power Unit</a>	Delphi Corporation	The SOFC power unit will provide up to 3 kW of auxiliary electrical power for a variety of mobile applications operating with a wide range of commercially available fuels such as natural gas, diesel, and propane. Received ARRA funding to test the power unit.	The power unit operates at a higher efficiency than internal combustion engines because of the electrochemical conversion of fuel and reduces the noise and pollutants associated with these engines.
<a href="#">Thermal and Water Management Systems for PEM Fuel Cells</a>	Honeywell Aerospace	A radiator and humidifier are being developed and tested that can maintain an 80-kW PEM fuel cell inlet air stream at or above 60% relative humidity (at 80°C) and efficiently reject heat generated by the fuel cell stack to the ambient air.	The new systems use advanced fin configurations to minimize the size and weight of the radiator and eliminate the need for an external water source by transferring moisture from a fuel cell's outlet air to its inlet air.



**Table 3.8. Emerging Products Summary – Production/Delivery**

Technology	Organization	Description	Benefits
<a href="#">Active Magnetic Regenerative Liquefier</a>	Prometheus Energy Group Inc.	A new, high-efficiency hydrogen liquefier that uses active magnetic regenerative liquefaction (AMRL) to produce ~25 kg of liquid hydrogen per day with a thermodynamic cycle efficiency (figure of merit) of ~0.5.	The technology improves the efficiency and reduces the cost of hydrogen liquefaction.
<a href="#">Centrifugal Hydrogen Pipeline Gas Compressor</a>	Concepts NREC	A centrifugal compressor system for pipeline transport of hydrogen gas achieves higher compression efficiency than conventional reciprocating compression equipment and delivers hydrogen at a rate of 240,000 kg/day at a discharge pressure of 1285 psig.	The compressor system can be used to support existing hydrogen pipeline infrastructure in the industrial sector and for future pipeline transport of high-pressure hydrogen gas from production sites to vehicle fueling stations at reduced capital costs.
<a href="#">Ceramic Membrane Reactor Systems for Converting Natural Gas to Hydrogen and Synthesis Gas (ITM Syngas)</a>	Air Products and Chemicals, Inc.	The ion transport membrane (ITM) system uses ceramic membranes to generate syngas and hydrogen in a more compact, lower-cost, and higher-efficiency process than competing technologies. ITM syngas membranes combine air separation and methane partial oxidation into a single unit operation.	The system has very high flux and selectivity that help reduce both capital and operating costs. The ITM syngas process is also readily configured for carbon capture from the high-pressure syngas product.
<a href="#">High Performance Palladium-Based Membrane</a>	Pall Corporation	The palladium-based membrane works as a selective barrier to let only H <sub>2</sub> pass through by using sophisticated high-temperature analysis and inorganic membrane development/manufacturing techniques.	The membrane can be economically integrated into the overall H <sub>2</sub> production process and is easily scalable to industrial applications.
<a href="#">High-Pressure Hydrogen Storage Tank for Gaseous Truck Delivery</a>	Lincoln Composites, Inc.	The large composite tank for storing and transporting compressed hydrogen gas over road, rail, or water has an internal volume of 8,500 liters and contains 150 kg of hydrogen at 3,600 psi. Four of these tanks are mounted in a frame for transport and a system for loading, unloading, and pressure relief has been designed and implemented.	The tank and frame system reduces costs by improving volumetric hydrogen storage capacity compared with conventional tube trailers while meeting strength, environmental, and durability targets.
<a href="#">HRS-100™ Hydrogen Recycling System (SBIR Project)</a>	H2Pump, LLC	An electrochemical hydrogen recovery system that separates hydrogen from a mixed gas stream (e.g., furnace exhaust), purifies it, and pumps it back into the feed stream of an industrial process. The system can recycle up to 100 kg-H <sub>2</sub> /day (1,600scfh) and recovers up to 90% of the hydrogen present in the exhaust stream.	The system reduces hydrogen feedstock costs for industrial processes by recovering previously wasted hydrogen at a lower cost than would be required for a new supply.
<a href="#">Hydrogen Gas Sensing System</a>	Intelligent Optical Systems, Inc.	The quick-response sensor system accurately detects hydrogen leaks in a broad range of operating environments including fuel cell vehicle garages, production facilities, and refueling stations. The sensor detects hydrogen at concentrations from 100 ppm to 10% hydrogen-in-air with a response time of less than 5 seconds.	The system operates over a wide range of conditions, including temperatures of 10-55°C and 0-90% relative humidity. The system identifies the points at which hydrogen is leaking thus alerting users before safety is compromised.
<a href="#">Hydrogen Generation from Biomass-Derived Carbohydrates via Aqueous-Phase Reforming</a>	Virent Energy Systems, Inc.	The BioForming™ process, using a proprietary catalyst that operates in the aqueous phase and has high hydrogen selectivity at low temperature, reforms water-soluble oxygenated-hydrocarbons in a single step and produces a hydrogen-rich gas that is easily purified.	The process allows hydrogen production from a range of carbon-neutral biomass sources and produces hydrogen at low temperatures without forming carbon monoxide.

**Table 3.8. Emerging Products Summary – Production/Delivery (Cont'd)**

Technology	Organization	Description	Benefits
<a href="#">Hydrogen Production via a Commercially Ready Inorganic Membrane Reactor</a>	Media and Process Technology, Inc.	A chemically stable carbon molecular sieve separates hydrogen from caustic streams that contain CO, CO <sub>2</sub> , H <sub>2</sub> S, and heavy hydrocarbons at stream temperatures above 250°C and pressures up to 1,500 psi.	The membrane offers a low-cost, mechanically durable option for hydrogen separation under harsh conditions and functions as a membrane reactor for water gas shift reactions.
<a href="#">Integrated Ceramic Membrane System for Hydrogen Production</a>	Praxair, Inc.	The hydrogen transport membrane features uniform small pores on the surface that enable a thin membrane layer to span the pores while larger pores in the bulk of the substrate provide strength to the membrane and do not restrict hydrogen flow.	The membranes help increase hydrogen yield, purity, and system energy efficiency and reduce capital costs. They are especially applicable to small, on-site hydrogen generators, such those located at fueling stations.
<a href="#">Integrated Short Contact Time Hydrogen Generator</a>	GE Global Research Center	The technology integrates short contact time catalytic partial oxidation, steam reforming, and water gas shift catalysis into a single process (staged catalytic partial oxidation) in a compact reactor that can produce 60 kg of hydrogen per day.	The technology has relatively low operation temperatures that allow lower-cost stainless steel to be used, is relatively compact, is amenable to mass production, and provides efficiency gains and lower capital costs by staging and integrating three catalysts.
<a href="#">Maximizing Light Utilization Efficiency and Hydrogen Production in Microalgal Cultures</a>	UC Berkeley	The technique involves genetically engineering the length of the chlorophyll “antenna” of a strain of algae to prevent over-absorption at the surface, allowing sunlight to penetrate deeper into the culture, thereby decreasing the heat dissipation and increasing the light utilization efficiency of hydrogen production from 3% to 15%.	The technology generates carbon-neutral hydrogen from algae and sunlight without requiring fossil fuels.
<a href="#">Nanotube Array Photocatalysts (SBIR Project)</a>	Synkera Technologies, Inc.	The photoelectrochemical hydrogen production system uses high-density arrays of nanotubes with unique coaxial architecture to enhance light harvesting through a large absorption cross-section and a high surface area to promote catalytic chemistry.	The photocatalysts increases efficiency through broadband light absorption and a vertically graded bandgap. The system is scalable to large size and high volumes and lowers costs compared with traditional technologies.
<a href="#">Novel Catalytic Fuel Reforming</a>	InnovaTek, Inc.	The hydrogen generator reforms multiple fuel types (natural gas, gasoline, and diesel) to produce pure hydrogen by integrating microreactor and microchannel heat exchanger technology with advanced sulfur-tolerant catalysts and membranes.	The generator system can produce 30 to 150 grams of hydrogen per hour that can be used to fuel a 1- to 5-kW polymer electrolyte membrane fuel cell or other auxiliary power unit.
<a href="#">Novel Stackable Structural Reactor (SSR®) for Low-Cost Hydrogen Production</a>	Catacel Corp.	During hydrogen production via steam reforming, a drop-in replacement for the loose ceramic media eliminates the periodic replacement required in conventional ceramic packed beds.	The drop-in replacements lower costs, increase performance, and minimize maintenance costs and inconveniences.
<a href="#">Oil Free Hydrogen Compressor (SBIR Project)</a>	Mohawk Innovative Technology, Inc.	The oil-free, high-speed centrifugal compressor uses advanced compliant surface foil gas bearings and seals, engineered coatings in conjunction with advanced high-speed drives, and centrifugal compressors.	The technology reduces capital, maintenance, and operating costs of compressors; improves compressor reliability and efficiency; and eliminates the potential for hydrogen contamination for sensitive hydrogen-consuming devices such as fuel cells.
<a href="#">Photoelectrochemical Hydrogen Production</a>	University of Hawaii	Five material classes have been studied, with a focus on understanding and improving photoelectrochemical (PEC) behavior and identifying relevant aspects of structural, optoelectronic, and electrochemical properties of PEC target films.	Advanced PEC hydrogen production systems allow pollution-free, sustainable, and renewable hydrogen synthesis.



**Table 3.8. Emerging Products Summary – Production/Delivery (Cont’d)**

<b>Technology</b>	<b>Organization</b>	<b>Description</b>	<b>Benefits</b>
<a href="#">Renewable Electrolysis Integrated System Development and Testing</a>	National Renewable Energy Laboratory	The approach reduces the impact of the inherent variability of renewable energy production by storing excess energy in the form of hydrogen. Varying renewable sources are being matched to the DC requirements of multiple alkaline and PEM electrolyzer stacks.	Coupling hydrogen production to renewable energy production allows for greater renewable energy infrastructure penetration and pollution-free production of energy.
<a href="#">Reversible Liquid Carriers</a>	Air Products and Chemicals, Inc.	This technology deploys a fully reversible liquid carrier that can be readily hydrogenated, transported to a distribution center, and then catalytically dehydrogenated to provide hydrogen gas to an end use such as fuel cells.	The technology increases catalyst efficiency and allows thermodynamically favorable liquid carriers to be deployed.

**Table 3.9. Emerging Products Summary – Storage**

<b>Technology</b>	<b>Organization</b>	<b>Description</b>	<b>Benefits</b>
<a href="#"><u>High-Strength, Low-Cost Microballoons for Hydrogen Storage</u></a>	Powdermet, Inc.	The microballoons are fabricated from light-weight carbon and have high-strength, defect-free coatings capable of a theoretical hydrogen storage capacity of >12 wt%, a burst strength >15,000 psig, and exceptional crush strength. The microballoons act as a scaffold for an impermeable barrier made of high-strength material.	The microballoons produce harmless waste products after hydrogen is released, may prove to be easily transportable, and flow like water to conform to any shape container.
<a href="#"><u>Hydrogen Storage in Cryo-Compressed Vessels</u></a>	Lawrence Livermore National Laboratory	The cryo-compressed hydrogen storage tank maintains high energy density without evaporative losses, requires fewer carbon fiber construction materials, and can store either compressed or liquid hydrogen.	The storage tank has a 500-mile range, can be dormant for extended periods without losing fuel from the tank, and has demonstrated an improved thermal endurance compared with low-pressure vessels.
<a href="#"><u>Manufacturing Technologies for Low-Cost Hydrogen Storage Vessels</u></a>	Quantum Fuel System Technologies Worldwide, Inc.	A new process for manufacturing composite pressure vessels used for storing compressed hydrogen. The process combines two techniques for the placement of carbon fibers (filament winding and advanced fiber placement) to reduce the cost and weight of the vessel.	The process reduces the weight and cost of composite hydrogen storage vessels without compromising the structural integrity of the vessels.
<a href="#"><u>Rapid Manufacturing of Vehicle-Scale, Carbon-Composite, High-Pressure Hydrogen Storage Cylinders</u></a>	Profile Composites Inc.	The fabrication technique can create high-pressure storage tanks in less than 20 minutes to allow a production rate approaching vehicle production.	The automated system will dramatically reduce production time, lower costs, improve fabrication reliability and volumes, and provide safer failure modes compared with filament winding tanks.
<a href="#"><u>Safe and Effective Storage and Transmission of Hydrogen</u></a>	Safe Hydrogen, LLC	The chemical hydride technology uses the existing fossil fuel infrastructure to deliver and store a pumpable and nonexplosive magnesium hydride mineral oil slurry as a future hydrogen fuel.	The slurry delivers hydrogen without requiring significant energy, displays superior storage density compared with cryogenically cooled liquid hydrogen, and can be reused by recycling the byproducts.
<a href="#"><u>Sodium Silicide (NaSi) Hydrogen Generation System</u></a>	SiGNa Chemistry, Inc.	The portable power system uses a stable, room-temperature reaction between sodium silicide and water to generate hydrogen at pressures from 2 to 30 psi. When coupled to a fuel cell generator the system provides 300 watts of continuous power and up to 500 watts of peak power.	The system uses two cartridges filled with NaSi powder and an integrated water reservoir that are hot-swappable, enabling extended runtimes without an interruption of power. Power output is consistent over the entire runtime, without the degradation associated with batteries.

**Table 3.10. Fuel Cell Challenges and Related Emerging Technologies**

Challenges*	Technology Title	Organization
Develop membranes that meet all targets	<a href="#">Dimensionally-Stable High-Performance Membrane</a>	Giner Electrochemical Systems, LLC
	<a href="#">High-Temperature Membrane with Humidification-Independent Cluster Structure</a>	FuelCell Energy, Inc.
	<a href="#">Improved Low-Cost, Durable Fuel Cell Membranes</a>	Arkema Inc.
Develop electrodes that meet all targets	<a href="#">Alternative and Durable High-Performance Cathode Supports for PEM Fuel Cells</a>	Pacific Northwest National Laboratory
	<a href="#">Direct Methanol Fuel Cell (DMFC) Anode Catalysts</a>	National Renewable Energy Laboratory
	<a href="#">Durable Catalysts for Fuel Cell Protection During Transient Conditions</a>	3M Company
	<a href="#">Extended, Continuous Pt Nanostructures in Thick, Dispersed Electrodes</a>	National Renewable Energy Laboratory
	<a href="#">High-Performance, Low-Pt Cathodes Containing New Catalysts and Layer Structure</a>	Cabot Superior MicroPowders
	<a href="#">Low Platinum Loading Fuel Cell Electrocatalysts</a>	Brookhaven National Laboratory
	<a href="#">Platinum Monolayer Electrocatalysts on Stable Low-Cost Supports</a>	Brookhaven National Laboratory
Develop MEAs that meet all targets	<a href="#">Engineered Nanostructured MEA Technology for Low-Temperature Fuel Cells</a>	Nanosys, Inc.
	<a href="#">Manufacturing of Low-Cost, Durable Membrane Electrode Assemblies</a>	W.L. Gore and Associates, Inc.
	<a href="#">Platinum and Fluoropolymer Recovery from PEM Fuel Cells</a>	Ion Power, Inc.
	<a href="#">Platinum-Group-Metal Recycling Technology</a>	BASF Catalysts LLC
Develop low-cost, durable GDLs that improve fuel cell performance	<a href="#">Reduction in Fabrication Costs of Gas Diffusion Layers</a>	Ballard Material Products, Inc.
Develop low-cost, durable bipolar plates that meet all targets	<a href="#">FARADAYIC ElectroEtching of Stainless Steel Bipolar Plates</a>	Faraday Technology, Inc.
	<a href="#">Nitrided Metallic Bipolar Plates for PEM Fuel Cells</a>	Oak Ridge National Laboratory
	<a href="#">Resin-Impregnated, Expanded-Graphite GRAFCELL® Bipolar Plates</a>	GrafTech International Ltd.
Develop efficient, cost-effective thermal/water management systems	<a href="#">CIRRUS: Cell Ice Regulation and Removal Upon Start-up</a>	Nuvera Fuel Cells, Inc.
	<a href="#">Materials and Modules for Low-Cost, High-Performance Fuel Cell Humidifiers</a>	W.L. Gore and Associates, Inc.
	<a href="#">Thermal and Water Management Systems for PEM Fuel Cells</a>	Honeywell Aerospace
Develop effective, reliable physical and chemical sensors that meet all targets	<a href="#">Low-Cost Hydrogen Sensor for Transportation Safety</a>	Makel Engineering, Inc.
	<a href="#">Sensors for Automotive Fuel Cell Systems</a>	NexTech Materials, Ltd.

**Table 3.10. Fuel Cell Challenges and Related Emerging Technologies (Cont'd)**

<b>Challenges*</b>	<b>Technology Title</b>	<b>Organization</b>
Develop cost-effective, efficient, reliable and durable fuel cells for stationary applications that meet all targets	<a href="#">Low-Cost 3-10 kW Tubular SOFC Power System</a>	Acumentrics Corporation
	<a href="#">Multi-Fuel Solid Oxide Fuel Cell (SOFC) System</a>	Technology Management, Inc.
	<a href="#">Polymer Electrolyte Membrane (PEM) Fuel Cell Power Plant Development and Verification</a>	UTC Power
Develop cost-effective, reliable, durable fuel cells for portable power applications (e.g., cell phones, computers, etc.) that meet all targets	<a href="#">Direct Methanol Fuel Cell for Handheld Electronics Applications</a>	MTI Micro Fuel Cells, Inc.
	<a href="#">Fuel-Cell-Based Mobile Lighting</a>	Sandia National Laboratories
	<a href="#">Portable Solid Oxide Fuel Cell Generator</a>	Jadoo Power Systems, Inc.
	<a href="#">Silicon-Based Solid Oxide Fuel Cell for Portable Consumer Electronics</a>	Lilliputian Systems, Inc.
Develop auxiliary power unit (APU) system for heavy truck applications to reduce idling of the main engine that meet all targets	<a href="#">Solid Acid Fuel Cell Stack for Auxiliary Power Unit Applications</a>	SAFCCell, Inc.
	<a href="#">Solid Oxide Fuel Cell Auxiliary Power Unit</a>	Delphi Corporation
Develop system to allow PEM Fuel Cells to operate in off-road applications	<a href="#">PowerEdge™ Fuel Cell System</a>	Nuvera Fuel Cells, Inc.
Stationary fuel cell demonstrations	<a href="#">GenSys® Blue: High-Temperature CHP Fuel Cell System</a>	Plug Power Inc.
	<a href="#">High-Efficiency Polymer Electrolyte Membrane Fuel Cell Combined Heat and Power System</a>	Intelligent Energy Inc.
Develop manufacturing processes for high-volume production of high-quality, uniform bipolar plates (Manufacturing PEM Fuel Cells Challenge)	<a href="#">Low-Cost Manufacturing of Sheet Molding Compound Bipolar Plates for PEM Fuel Cells</a>	Nanotek Instruments, Inc.
Reduce cost of PEM materials through improved manufacturing operations (Manufacturing PEM Fuel Cells Challenge)	<a href="#">Fuel Cell Membrane Measurement System for Manufacturing</a>	Scribner Associates, Inc.
Develop sensors to monitor performance of fuel cell and fuel cell leakage (Manufacturing PEM Fuel Cells Challenge)	<a href="#">Direct-Write Inkjet Printing for Fabricating Hydrogen Sensors</a>	InnoSense, LLC

\* Note: The challenges are described in the FCT Program Multi-Year Plan for fuel cells at [http://www1.eere.energy.gov/hydrogenandfuelcells/mypp/pdfs/fuel\\_cells.pdf](http://www1.eere.energy.gov/hydrogenandfuelcells/mypp/pdfs/fuel_cells.pdf) and manufacturing at <http://www1.eere.energy.gov/hydrogenandfuelcells/mypp/pdfs/manufacturing.pdf>.

**Table 3.11. Production and Delivery Challenges and Related Emerging Technologies**

Challenges*	Technology Title	Organization
Cost reduction of distributed hydrogen production from natural gas and bio-derived liquids	<a href="#">Ceramic Membrane Reactor Systems for Converting Natural Gas to Hydrogen and Synthesis Gas (ITM Syngas)</a>	Air Products and Chemicals, Inc.
	<a href="#">Hydrogen Generation from Biomass-Derived Carbohydrates via Aqueous-Phase Reforming</a>	Virent Energy Systems, Inc.
	<a href="#">Integrated Short Contact Time Hydrogen Generator</a>	GE Global Research Center
	<a href="#">Novel Catalytic Fuel Reforming</a>	InnovaTek, Inc.
	<a href="#">Novel Stackable Structural Reactor (SSR®) for Low-Cost Hydrogen Production</a>	Catacel Corp.
Hydrogen production from water via electrolysis	<a href="#">Renewable Electrolysis Integrated System Development and Testing</a>	National Renewable Energy Laboratory
Photoelectrochemical hydrogen production from water (direct water splitting)	<a href="#">Nanotube Array Photocatalysts</a>	Synkera Technologies, Inc.
	<a href="#">Photoelectrochemical Hydrogen Production</a>	University of Hawaii
Biological production of hydrogen	<a href="#">Maximizing Light Utilization Efficiency and Hydrogen Production in Microalgal Cultures</a>	UC Berkeley
Separation and purification systems	<a href="#">High Performance Palladium-Based Membrane</a>	Pall Corporation
	<a href="#">HRS-100™ Hydrogen Recycling System</a>	H2Pump, LLC
	<a href="#">Hydrogen Gas Sensing System</a>	Intelligent Optical Systems, Inc.
	<a href="#">Hydrogen Production via a Commercially Ready Inorganic Membrane Reactor</a>	Media and Process Technology, Inc.
	<a href="#">Integrated Ceramic Membrane System for Hydrogen Production</a>	Praxair, Inc.
Develop carriers that can enable low cost hydrogen delivery	<a href="#">High-Pressure Hydrogen Storage Tank for Gaseous Truck Delivery</a>	Lincoln Composites, Inc.
	<a href="#">Reversible Liquid Carriers</a>	Air Products and Chemicals, Inc.
Increase the reliability, reduce the cost, and improve the energy efficiency of gaseous hydrogen compression	<a href="#">Centrifugal Hydrogen Pipeline Gas Compressor</a>	Concepts NREC
	<a href="#">Oil Free Hydrogen Compressor</a>	Mohawk Innovative Technology, Inc.
Reduce the cost and improve the energy efficiency of hydrogen liquefaction	<a href="#">Active Magnetic Regenerative Liquefier</a>	Prometheus Energy Group Inc.

\* Note: The challenges are described in the FCT Program Multi-Year Plan for production at <http://www1.eere.energy.gov/hydrogenandfuelcells/mypp/pdfs/production.pdf> and delivery at <http://www1.eere.energy.gov/hydrogenandfuelcells/mypp/pdfs/delivery.pdf>.

**Table 3.12. Storage Approaches and Related Emerging Technologies**

Challenges*	Technology Title	Organization
Compressed, cryo-compressed and conformal hydrogen tanks	<a href="#">Hydrogen Storage in Cryo-Compressed Vessels</a>	Lawrence Livermore National Laboratory
	<a href="#">Manufacturing Technologies for Low-Cost Hydrogen Storage Vessels</a>	Quantum Fuel System Technologies Worldwide, Inc.
	<a href="#">Rapid Manufacturing of Vehicle-Scale, Carbon-Composite, High-Pressure Hydrogen Storage Cylinders</a>	Profile Composites Inc.
Chemical hydrogen storage	<a href="#">Safe and Effective Storage and Transmission of Hydrogen</a>	Safe Hydrogen, LLC
	<a href="#">Sodium Silicide (NaSi) Hydrogen Generation System</a>	SiGNa Chemistry, Inc.
Additional new materials and concepts	<a href="#">High-Strength, Low-Cost Microballoons for Hydrogen Storage</a>	Powdermet, Inc.

\* Note: The approaches are described in the FCT Program Multi-Year Plan for storage at <http://www1.eere.energy.gov/hydrogenandfuelcells/mypp/pdfs/storage.pdf>

# Appendix A: Technology Tracking Data Collection Template

Technology Tracking Data Collection Template.....A-2

## Technology Tracking Data Collection Template

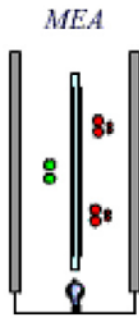
	<b>Primary Industry:</b> Fuel Cells
<p><b>Overview (Technology History):</b></p> <ul style="list-style-type: none"> <li>• Who is selling it.</li> <li>• What year it became commercially available</li> <li>• Number of units sold.</li> </ul> <p><b>Applications:</b> About 70 words. Where will it be used and what will be the impact of its use.</p> <p><b>Capabilities:</b> About 20 words describing what it does.</p> <ul style="list-style-type: none"> <li>• Produces...</li> <li>• Achieves...</li> <li>• Allows...</li> </ul>	<p><b>Graphic:</b></p> <div style="text-align: center;">  <p style="color: green; font-weight: bold;">Oxygen and Hydrogen</p> </div> <p>Graphic or photo showing process performed</p>
<p><b>Description:</b> Two or three paragraphs, about 80 words each. Tell the story of how it fills a need and describe it. First paragraph gives situation before this technology. Second paragraph gives situation after this technology and describes how it works.</p>	<p><b>Benefits:</b> Two or three headings, with about 8 to 16 words under each heading. Examples are:</p> <ul style="list-style-type: none"> <li>Production Cost Savings</li> <li>Reduced Fuel Costs</li> <li>Emissions Reductions</li> <li>Safety</li> <li>Productivity</li> </ul>

### Tracking Information:

**Year Developed:**

**Year**

**Year First** (PNNL internal)

**Commercialized:**

**Year Stopped** (PNNL internal)

**Tracked:**

**Tracking:**

### Associated Parties:

**DOE Manager(s)**

**Technology  
Partner(s)**

This is the DOE program manager contact:

..This is your contact information and the contact information of partners if any.



## Technology Tracking Data Collection Template

Name ..Name of Principal Investigator  
Address .. Company or Lab Name  
Phone ..Address  
Etc. Phone: .  
Fax:  
E-Mail:  
Website:

*Note: Please be sure to include the contact information of the person who someone could contact to obtain this product?*

### Status Information:

Year:	Status:	Comments:
2008	Commercial <i>Note: the definition of commercial is currently available for sale and at least one unit has been sold.</i>	This is a short (< 50 words) summary of development progress in the prior calendar year, your current status, future commercialization plans.

### Description:

#### Also Known As:

This is an alternative name for the technology if one exists.

#### Technical Description:

This is the technical description of the process/technology (short, about 80 words)

### References:

#### Source List:

This could be a website with further information or reference information

### Remarks:

#### History:

This is a short summary of when testing began and changes that may have occurred over time. 70 words.

# Technology Tracking Data Collection Template

**General Comments:**

Optional

**Markets and Economics:**

**Comments:**

Projected savings if any

**Selling Price:**

*Note: Please distinguish between units sold per year in the US versus foreign countries.*

# Appendix B: Technology Tracking List

**Technology Tracking List**.....B-2

## Fuel Cell Technologies

Technology Title	Company
<a href="#">Advanced Cathode Catalysts and Supports for PEM Fuel Cells</a>	3M Company
<a href="#">Alternative and Durable High Performance Cathode Supports for PEM Fuel Cells</a>	PNNL
<a href="#">Breakthrough Lifetime Improvements for PEM Fuel Cells</a>	DuPont Fuel Cells
<a href="#">CIRRUS: Cell Ice Regulation and Removal Upon Start-up</a>	Nuvera Fuel Cells, Inc.
<a href="#">Complex Coolant for Polymer Electrolyte Membrane (PEM) Fuel Cells</a>	Dynalene, Inc.
<a href="#">Conductive Compound for Molding Fuel Cell Bipolar Plates</a>	Bulk Molding Compounds, Inc.
<a href="#">Corrosion Test Cell for PEM Bipolar Plate Materials</a>	Fuel Cell Technologies, Inc.
<a href="#">Cost-Effective, High-Efficiency, Advanced Reforming Module (CHARM)</a>	Nuvera Fuel Cells, Inc.
<a href="#">Dimensionally-Stable High-Performance Membrane</a>	Giner Electrochemical Systems, LLC
<a href="#">Direct Methanol Fuel Cell (DMFC) Anode Catalysts</a>	NREL
<a href="#">Direct Methanol Fuel Cell for Handheld Electronics Applications</a>	MTI Micro Fuel Cells, Inc.
<a href="#">Direct-Write Inkjet Printing for Fabricating Hydrogen Sensors</a>	InnoSense, LLC
<a href="#">Durable Catalysts for Fuel Cell Protection During Transient Conditions</a>	3M Company
<a href="#">Engineered Nanostructured MEA Technology for Low-Temperature Fuel Cells</a>	Nanosys, Inc.
<a href="#">Extended, Continuous Pt Nanostructures in Thick, Dispersed Electrodes</a>	NREL
<a href="#">FARADAYIC ElectroEtching of Stainless Steel Bipolar Plates</a>	Faraday Technology, Inc.
<a href="#">Fuel Cell Membrane Measurement System for Manufacturing</a>	Scribner Associates, Inc.
<a href="#">Fuel-Cell-Based Mobile Lighting</a>	SNL
<a href="#">GCtool: Fuel Cell Systems Analysis Software Model</a>	ANL
<a href="#">GenDrive™ Fuel Cell Power System</a>	Plug Power Inc.
<a href="#">GenSys® Blue: High-Temperature CHP Fuel Cell System</a>	Plug Power Inc.
<a href="#">High-Efficiency PEM Fuel Cell Combined Heat and Power System</a>	Intelligent Energy Inc.
<a href="#">High-Performance, Low-Pt Cathodes Containing New Catalysts and Layer Structure</a>	Cabot Superior MicroPowders
<a href="#">High-Temperature Membrane with Humidification-Independent Cluster Structure</a>	FuelCell Energy, Inc.
<a href="#">Improved Catalyst Coated Membrane (CCM) Manufacturing</a>	IRD Fuel Cells LLC
<a href="#">Improved Fuel Cell Cathode Catalysts Using Combinatorial Methods</a>	NuVant Systems Inc.
<a href="#">Improved Low-Cost, Durable Fuel Cell Membranes</a>	Arkema Inc.
<a href="#">Integrated Manufacturing for Advanced Membrane Electrode Assemblies</a>	BASF Fuel Cell, Inc.
<a href="#">Low-Cost 3-10 kW Tubular SOFC Power System</a>	Acumentrics Corporation
<a href="#">Low-Cost Hydrogen Sensor for Transportation Safety</a>	Makel Engineering, Inc.
<a href="#">Low-Cost Manufacturing of Sheet Molding Compound Bipolar Plates for PEM Fuel Cells</a>	Nanotek Instruments, Inc.
<a href="#">Low Platinum Loading Fuel Cell Electrocatalysts</a>	BNL
<a href="#">Manufacture of Durable Seals for PEM Fuel Cells</a>	Freudenberg-NOK General Partnership
<a href="#">Manufacturing of Low-Cost, Durable Membrane Electrode Assemblies</a>	W.L. Gore and Associates, Inc.
<a href="#">Materials and Modules for Low-Cost, High-Performance Fuel Cell Humidifiers</a>	W.L. Gore and Associates, Inc.
<a href="#">Membranes and MEAs for Dry, Hot Operating Conditions</a>	3M Company
<a href="#">Multi-Fuel Solid Oxide Fuel Cell (SOFC) System</a>	Technology Management, Inc.
<a href="#">Nitrided Metallic Bipolar Plates for PEM Fuel Cells</a>	ORNL
<a href="#">Novel Manufacturing Process for PEM Fuel Cell Stacks</a>	Protonex Technology Corporation
<a href="#">Platinum and Fluoropolymer Recovery from PEM Fuel Cells</a>	Ion Power, Inc.
<a href="#">Platinum-Group-Metal Recycling Technology</a>	BASF Catalysts LLC
<a href="#">Platinum Monolayer Electrocaalysts on Stable Low-Cost Supports</a>	BNL
<a href="#">Polymer Electrolyte Membrane (PEM) Fuel Cell Power Plant Development and Verification</a>	UTC Power

Technologies highlighted in red are commercial and blue are emerging.

## Fuel Cell Technologies (Cont'd)

<a href="#"><u>Portable Reformed Methanol Fuel Cells</u></a>	UltraCell Corporation
<a href="#"><u>Portable Solid Oxide Fuel Cell Generator</u></a>	Jadoo Power Systems, Inc.
<a href="#"><u>PowerEdge™ Fuel Cell System</u></a>	Nuvera Fuel Cells, Inc.
<a href="#"><u>PureMotion® 120 Fuel Cell Power Plant</u></a>	UTC Power
<a href="#"><u>Reduction in Fabrication Costs of Gas Diffusion Layers</u></a>	Ballard Material Products, Inc.
<a href="#"><u>Resin-Impregnated, Expanded-Graphite GRAFCELL® Bipolar Plates</u></a>	GrafTech International Ltd
<a href="#"><u>Scale-Up of Carbon-Carbon Composite Bipolar Plates</u></a>	Porvair Advanced Materials, Inc.
<a href="#"><u>Sensors for Automotive Fuel Cell Systems</u></a>	NexTech Materials, Ltd.
<a href="#"><u>Silicon-Based Solid Oxide Fuel Cell for Portable Consumer Electronics</u></a>	Lilliputian Systems, Inc.
<a href="#"><u>Solid Acid Fuel Cell Stack for Auxiliary Power Unit Applications</u></a>	SAFCeLL, Inc.
<a href="#"><u>Solid Oxide Fuel Cell Auxiliary Power Unit</u></a>	Delphi Corporation
<a href="#"><u>Thermal and Water Management Systems for PEM Fuel Cells</u></a>	Honeywell Aerospace

Technologies highlighted in red are commercial and blue are emerging.

## Production/Delivery Technologies

Technology Title	Company
<a href="#">Active Magnetic Regenerative Liquefier</a>	Prometheus Energy Group Inc.
<a href="#">Centrifugal Hydrogen Pipeline Gas Compressor</a>	Concepts NREC
<a href="#">Ceramic Membrane Reactor Systems for Converting Natural Gas to Hydrogen and Synthesis Gas (ITM Syngas)</a>	Air Products and Chemicals, Inc.
<a href="#">FuelGen® Hydrogen Fueling Systems</a>	Proton Energy Systems, Inc.
<a href="#">H2 ProGen: A Total Supply Solution for Hydrogen Vehicles</a>	GreenField Compression
<a href="#">High-Efficiency, High-Pressure Electrolysis via Photovoltaic Arrays</a>	Avalence, LLC
<a href="#">High Performance Palladium-Based Membrane</a>	Pall Corporation
<a href="#">High-Pressure Hydrogen Storage Tank for Gaseous Truck Delivery</a>	Lincoln Composites, Inc.
<a href="#">HRS-100™ Hydrogen Recycling System</a>	H2Pump, LLC
<a href="#">Hydrogen Distributed Production System</a>	Air Liquide Process and Construction
<a href="#">Hydrogen Gas Sensing System</a>	Intelligent Optical Systems, Inc.
<a href="#">Hydrogen Generation from Biomass-Derived Carbohydrates via Aqueous-Phase Reforming</a>	Virent Energy Systems, Inc.
<a href="#">Hydrogen Generation from Electrolysis</a>	Proton Energy Systems, Inc.
<a href="#">Hydrogen Production via a Commercially Ready Inorganic Membrane Reactor</a>	Media and Process Technology, Inc.
<a href="#">Hydrogen Safety Sensor for Advanced Energy Applications</a>	NexTech Materials, Ltd.
<a href="#">Integrated Ceramic Membrane System for Hydrogen Production</a>	Praxair, Inc.
<a href="#">Integrated Short Contact Time Hydrogen Generator</a>	GE Global Research Center
<a href="#">Maximizing Light Utilization Efficiency and Hydrogen Production in Microalgal Cultures</a>	U. of California-Berkeley
<a href="#">ME100 Methanol Reforming Hydrogen Generator</a>	REB Research & Consulting
<a href="#">Membrane Structures for Hydrogen Separation</a>	Genesis Fueltech, Inc.
<a href="#">Nanoscale Water Gas Shift Catalysts</a>	NexTech Materials, Ltd.
<a href="#">Nanotube Array Photocatalysts</a>	Synkera Technologies, Inc.
<a href="#">Novel Catalytic Fuel Reforming</a>	InnovaTek, Inc.
<a href="#">Novel Stackable Structural Reactor (SSR®) for Low-Cost Hydrogen Production</a>	Catacel Corporation
<a href="#">Oil Free Hydrogen Compressor</a>	Mohawk Innovative Technology, Inc.
<a href="#">PEM Electrolyzer Incorporating an Advanced Low-Cost Membrane</a>	Giner Electrochemical Systems, LLC
<a href="#">Photoelectrochemical Hydrogen Production</a>	U. of Hawaii
<a href="#">Renewable Electrolysis Integrated System Development and Testing</a>	NREL
<a href="#">Reversible Liquid Carriers</a>	Air Products and Chemicals, Inc.

Technologies highlighted in red are commercial and blue are emerging.

## Storage Technologies

Technology Title	Company
<a href="#"><u>High-Strength, Low-Cost Microballoons for Hydrogen Storage</u></a>	Powdermet, Inc.
<a href="#"><u>Hydrogen Composite Tanks</u></a>	Quantum Technologies, Inc.
<a href="#"><u>Hydrogen Storage in Cryo-Compressed Vessels</u></a>	LLNL
<a href="#"><u>Manufacturing Technologies for Low-Cost Hydrogen Storage Vessels</u></a>	Quantum Fuel System Technologies Worldwide, Inc.
<a href="#"><u>Non-Destructive Ultrasonic Scanning Technology</u></a>	Digital Wave Corporation
<a href="#"><u>Rapid Manufacturing of Vehicle-Scale, Carbon-Composite, High-Pressure Hydrogen Storage Cylinders</u></a>	Profile Composites Inc.
<a href="#"><u>Safe and Effective Storage and Transmission of Hydrogen</u></a>	Safe Hydrogen, LLC
<a href="#"><u>Sodium Silicide (NaSi) Hydrogen Generation System</u></a>	SiGNa Chemistry, Inc.

Technologies highlighted in red are commercial and blue are emerging.





# Appendix C: Patent Status Lists

**C.1 Fuel Cell Patents Status** ..... C-3

**C.2 Production/Delivery Patents Status** ..... C-23

**C.3 Storage Patents Status** ..... C-37





## Fuel Cell Patents Status

Patent Number	Award Date	Organization	Title	Description	Status
7,943,266	05/17/11	General Electric Company	SOFC seal and cell thermal management	A solid oxide fuel cell module in which the cell and its peripheral gas-flow-directing components (e.g., manifold and seals) are cooled to reduce stress-inducing thermal gradients and prevent cell cracking.	Being used in continuing research at the company.
7,902,299	03/08/11	LBNL	Single ion conductor cross-linked polymeric networks	The invention relates to the synthesis, characterization, and electrochemical response of a new type of single-ion comb-branch polymer electrolyte that can be used as a proton exchange membrane in fuel cells.	Being used in research at LBNL and seeking to license.
7,901,940	03/08/11	BASF Corporation	Method for measuring recovery of catalytic elements from fuel cells	A method for measuring the concentration of a catalytic element in a fuel cell powder. The method includes depositing a powder mixture consisting of the fuel cell powder and an internal standard material on a porous substrate, ablating a sample of the powder mixture using a laser, and vaporizing the sample using an inductively coupled plasma.	No longer being used.
7,887,927	02/15/11	Nanotek Instruments, Inc.	Highly conductive, multi-layer composite precursor composition to fuel cell flow field plate or bipolar plate	A roll-to-roll method of producing a flexible graphite-based, highly electrically conductive sheet molding compound (SMC) and SMC-based flow field or bipolar plates for use in a proton exchange membrane fuel cell.	Part of an <a href="#">emerging fuel cell technology</a> project.
7,868,086	01/11/11	E. I. du Pont de Nemours and Company	Arylene fluorinated sulfonimide polymers and membranes	Aromatic sulfonimide polymers that are useful in making proton exchange membranes for fuel cells.	Being used in continuing research at the company.
7,867,669	01/11/11	Giner Electrochemical Systems, LLC	Solid polymer electrolyte composite membrane comprising laser micromachined porous support	A solid polymer electrolyte composite membrane and methods of manufacturing the same.	Part of an <a href="#">emerging fuel cell technology</a> project.
7,855,021	12/21/10	BNL	Electrocatalysts having platinum monolayers on palladium, palladium alloy, and gold alloy core-shell nanoparticles, and uses thereof	The invention relates to platinum-coated particles useful as fuel cell electrocatalysts. The particles are composed of a noble metal or metal alloy core at least partially encapsulated by an atomically thin surface layer of platinum atoms. The invention particularly relates to such particles having a palladium, palladium alloy, gold alloy, or rhenium alloy core encapsulated by an atomic monolayer of platinum.	Part of an <a href="#">emerging fuel cell technology</a> project.
7,851,399	12/14/10	LANL	Method of making chalcogen catalysts for polymer electrolyte fuel cells	A method of making a catalyst material for use in fuel cell cathodes. The catalyst material includes a support comprising at least one transition metal and at least one chalcogen disposed on a surface of the transition metal.	Being used in continuing research at LANL.

### Fuel Cell Patents Status

Patent Number	Award Date	Organization	Title	Description	Status
7,838,138	11/23/10	3M Company	Fuel cell electrolyte membrane with basic polymer	A fuel cell electrolyte membrane that includes an acid and a basic polymer. The acid is a low-volatility acid that is fluorinated and is either oligomeric or non-polymeric. The basic polymer is protonated by the acid and is stable to hydrolysis. As a result, the electrolyte membrane may be used at high operating temperatures while preserving proton conductivity.	Part of a <a href="#">commercial fuel cell technology</a> project.
7,829,194	11/09/10	ORNL	Iron-based alloy and nitridation treatment for PEM fuel cell bipolar plates	A corrosion resistant electrically conductive component that can be used as a bipolar plate in a PEM fuel cell. The plates are composed of an alloy substrate (Fe base metal with 10-30 wt. % Cr and 0.5-7 wt. % V) and a continuous surface layer of chromium nitride and vanadium nitride.	Part of an <a href="#">emerging fuel cell technology</a> project.
7,824,651	11/02/10	Nanotek Instruments, Inc.	Method of producing exfoliated graphite, flexible graphite, and nano-scaled graphene platelets	A method of exfoliating a layered material (e.g., graphite and graphite oxide) to produce nano-scaled platelets having a thickness smaller than 100 nm and typically smaller than 10 nm. The invention can be used in the manufacturing of fuel cell bipolar plates.	Part of an <a href="#">emerging fuel cell technology</a> project.
7,816,482	10/19/10	SNL	Epoxy-crosslinked sulfonated poly (phenylene) copolymer proton exchange membranes	The invention relates to epoxy-crosslinked sulfonated poly(phenylene) copolymer compositions used as proton exchange membranes (PEMs) in fuel cells. The membranes have improved durability and can operate at high temperatures than conventional PEMs.	Being used in continuing research at SNL.
7,815,986	10/19/10	Arkema Inc.	Blend of ionic (co)polymer resins and matrix (co)polymers	A novel polymeric resin blend useful for forming durable and chemical-resistant films for fuel cell membranes.	Part of an <a href="#">emerging fuel cell technology</a> project.
7,807,063	10/05/10	Giner Electrochemical Systems, LLC	Solid polymer electrolyte composite membrane comprising plasma etched porous support	A solid polymer electrolyte composite membrane and methods of manufacturing the same.	Part of an <a href="#">emerging fuel cell technology</a> project.
7,803,891	09/28/10	Arkema Inc.	Blend of ionic (co)polymer resins and matrix (co)polymers	A novel polymeric resin blend useful for forming durable and chemical-resistant films for fuel cell membranes.	Part of an <a href="#">emerging fuel cell technology</a> project.
7,803,493	09/28/10	General Electric Company	Fuel cell system with separating structure bonded to electrolyte	The invention relates to a fuel cell assembly that is sealed in an efficient way to keep the fuel and oxidant paths separated at high operating temperatures.	Being used in continuing research at the company.

## Fuel Cell Patents Status

Patent Number	Award Date	Organization	Title	Description	Status
7,803,477	09/28/10	ORNL	Metallization of bacterial cellulose for electrical and electronic device manufacture	A method for the deposition of metals in bacterial cellulose and for the employment of the metallized bacterial cellulose in the construction of fuel cells and other electronic devices.	Being used in continuing research at ORNL.
7,785,454	08/31/10	BASF Corporation	Gas diffusion electrodes, membrane-electrode assemblies and method for the production thereof	The invention relates to the production of an improved gas diffusion electrode for fuel cells. The electrode consists of an electrically conductive web, a non-catalyzed gas diffusion layer, and a noble metal coating.	Part of a <a href="#">commercial fuel cell technology</a> project.
7,781,529	08/24/10	Arkema Inc.	Blend of ionic (co)polymer resins and matrix (co)polymers	A novel polymeric resin blend useful for forming durable and chemical-resistant films for fuel cell membranes.	Part of an <a href="#">emerging fuel cell technology</a> project.
7,781,364	08/24/10	LANL	Chalcogen catalysts for polymer electrolyte fuel cell	A cathode catalyst comprising a metal support that includes at least one transition metal and at least one chalcogen, both in elemental form. The catalyst is intended for use in polymer electrolyte membrane fuel cells and direct methanol fuel cells.	Being used in continuing research at LANL.
7,767,610	08/03/10	SNL	Metal nanoparticles as a conductive catalyst	A metal nanocluster composite material for use as a conductive catalyst in fuel cell electrodes. The material has noble metal nanoclusters on a carbon substrate formed within a porous zeolitic material.	Being used in continuing research at SNL.
7,763,217	07/27/10	PNNL	Rapid start fuel reforming systems and techniques	An on-board fuel processor includes a microchannel steam reforming reactor and a water vaporizer heated in series with a combustion gas. A rapid cold start can be achieved in under 30 seconds with a manageable amount of electric power consumption, making the device advantageous for use in automotive fuel cell applications.	Research complete; seeking to license.
7,758,783	07/20/10	Nanotek Instruments, Inc.	Continuous production of exfoliated graphite composite compositions and flow field plates	A process for continuously producing a composite composition that can be used to make fuel cell bipolar plates or flow field plates. The flow field plates have an exceptionally high electrical conductivity in the plate thickness direction.	Part of an <a href="#">emerging fuel cell technology</a> project.
7,737,190	06/15/10	E.I. du Pont de Nemours and Company	Process to prepare stable trifluorostyrene containing compounds grafted to base polymers using a solvent/water mixture	A process for preparing a fluorinated ion exchange polymer that involves grafting at least one monomer derived from trifluorostyrene onto at least one base polymer in an organic solvent/water mixture. These ion exchange polymers are useful in preparing catalyst coated membranes and membrane electrode assemblies used in fuel cells.	Being used in continuing research at the company.

### Fuel Cell Patents Status

Patent Number	Award Date	Organization	Title	Description	Status
7,732,084	06/08/10	General Electric Company	Solid oxide fuel cell with internal reforming, catalyzed interconnect for use therewith, and methods	A catalyzed interconnect for placement between an anode and a current collector in a fuel cell. This interconnect improves the efficiency of internal reforming of hydrocarbon fuels in solid oxide fuel cells.	Being used in continuing research at the company.
7,709,135	05/04/10	BASF Corporation	Efficient process for precious metal recovery from cell membrane electrode assemblies	A method is provided for recovering a catalytic element from a fuel cell membrane electrode assembly. The method includes grinding the membrane electrode assembly into a powder, extracting the catalytic element by forming a slurry comprising the powder and an acid leachate adapted to dissolve the catalytic element into a soluble salt, and separating the slurry into a depleted powder and a supernatant containing the catalytic element salt.	Part of an <a href="#">emerging fuel cell technology</a> project.
7,704,919	04/27/10	BNL	Electrocatalysts having gold monolayers on platinum nanoparticle cores, and uses thereof	Gold-coated particles useful as fuel cell electrocatalysts. The particles are composed of a platinum or platinum alloy core at least partially encapsulated by an outer shell of gold or gold alloy.	Being used in continuing research at BNL and seeking to license.
7,704,918	04/27/10	BNL	Synthesis of metal-metal oxide catalysts and electrocatalysts using a metal cation adsorption/reduction and adatom replacement by more noble ones	Platinum-metal oxide composite particles and their use as electrocatalysts in oxygen-reducing cathodes and fuel cells. The invention also relates to methods of making the metal-metal oxide composites.	Being used in continuing research at BNL and seeking to license.
7,699,916	04/20/10	ANL	Corrosion-resistant, electrically-conductive plate for use in a fuel cell stack	A corrosion resistant, electrically-conductive, durable plate at least partially coated with an anchor coating and a corrosion resistant coating. Preferably, the plate is used as a bipolar plate in a proton exchange membrane (PEMFC) fuel cell stack.	Being used in continuing research efforts at ANL.
7,691,780	04/06/10	BNL	Platinum- and platinum alloy-coated palladium and palladium alloy particles and uses thereof	The invention relates to particle and nanoparticle composites useful as oxygen-reduction electrocatalysts. The particle composites are composed of a palladium or palladium-alloy particle or nanoparticle substrate coated with an atomic submonolayer, monolayer, bilayer, or trilayer of zerovalent platinum atoms.	Part of an <a href="#">emerging fuel cell technology</a> project.
7,691,770	04/06/10	General Electric Company	Electrode structure and methods of making same	The invention relates to a new electrode structure that improves the performance of solid oxide fuel cells.	Being used in continuing research at the company.

## Fuel Cell Patents Status

Patent Number	Award Date	Organization	Title	Description	Status
7,652,479	01/26/10	Scribner Associates, Inc.	Electrolyte measurement device and measurement procedure	A novel electrode design and measurement system that allows rapid assessment of the through-thickness resistance of bare, non-catalyzed thin electrolytes such as those used in PEM fuel cells.	Part of an <a href="#">emerging fuel cell technology</a> project.
7,635,534	12/22/09	BASF Corporation	Simplified process for leaching precious metals from fuel cell membrane electrode assemblies	An improved process for recovering precious metal catalysts from recycled fuel cell membrane electrode assemblies.	Part of an <a href="#">emerging fuel cell technology</a> project.
7,633,267	12/15/09	Farasis Energy, Inc.	Apparatus for combinatorial screening of electrochemical materials	A high throughput combinatorial screening method and apparatus for the evaluation of electrochemical materials using a single voltage source.	No longer being used.
7,632,601	12/15/09	BNL	Palladium-cobalt particles as oxygen-reduction electrocatalysts	An electrocatalyst is provided for oxygen-reducing cathodes and fuel cells containing palladium-cobalt particles.	Part of an <a href="#">emerging fuel cell technology</a> project.
7,632,595	12/15/09	General Electric Company	Compliant fuel cell system	A fuel cell assembly comprising at least one metallic component, at least one ceramic component, and a structure disposed between the metallic component and the ceramic component. The assembly is designed to withstand strain during thermal cycles.	Being used in continuing research at the company.
7,629,426	12/08/09	Arkema Inc.	Blend of ionic (co)polymer resins and matrix (co)polymers	A novel polymeric resin blend useful for forming durable and chemical-resistant films for fuel cell membranes.	Part of an <a href="#">emerging fuel cell technology</a> project.
7,629,285	12/08/09	University of South Carolina	Carbon-based composite electrocatalysts for low temperature fuel cells	A process for synthesis of a low-cost, easily manufactured carbon-based composite catalyst for use in proton exchange membrane (PEM) fuel cells is provided.	Research complete; seeking to license.
7,618,915	11/17/09	University of South Carolina	Composite catalysts supported on modified carbon substrates and methods of making the same	A method of producing a low-cost, easily manufactured carbon-based composite catalyst for use in proton exchange membrane (PEM) fuel cells is disclosed.	Research complete; seeking to license.
7,601,216	10/13/09	BASF Corporation	Gas diffusion electrodes, membrane-electrode assemblies and method for the production thereof	The invention relates to the production of an improved gas diffusion electrode for fuel cells. The electrode consists of an electrically conductive web, a non-catalyzed gas diffusion layer, and a noble metal coating.	Part of a <a href="#">commercial fuel cell technology</a> project.



### Fuel Cell Patents Status

Patent Number	Award Date	Organization	Title	Description	Status
7,589,047	09/15/09	LANL	Composite materials and method of making	A method of depositing noble metals on a metal hexaboride support. The method permits the deposition of metallic films of controlled thickness and particle size at room temperature without using separate reducing agents. Composite materials comprising noble metal films deposited on such metal hexaborides may be used as catalysts and electrodes in fuel cells.	Being used in continuing research at LANL.
7,588,857	09/15/09	LANL	Chalcogen catalysts for polymer electrolyte fuel cell	A methanol-tolerant cathode catalyst and a membrane electrode assembly for fuel cells that includes such a cathode catalyst. The cathode catalyst includes a support having at least one transition metal in elemental form and a chalcogen disposed on the support. Methods of making the cathode catalyst and membrane electrode assembly are also described.	Research complete; seeking to license.
7,588,849	09/15/09	Delphi Technologies, Inc.	Solid-oxide fuel cell system having tempering of fuel cell stacks by exhaust gas	A fuel cell system which enhances stack performance via heat exchange with exhaust gas and use of a tempering jacket space surrounding the stack.	Part of an <a href="#">emerging fuel cell technology</a> project.
7,575,824	08/18/09	LANL	Method of improving fuel cell performance by removing at least one metal oxide contaminant from a fuel cell electrode	A method of removing contaminants from a fuel cell electrode. The method includes providing a getter electrode and a fuel cell catalyst electrode having at least one contaminant to a bath and applying a voltage sufficient to drive the contaminant from the fuel cell catalyst electrode to the getter electrode.	Being used in continuing research at LANL and seeking to license.
7,572,534	08/11/09	3M Company	Fuel cell membrane electrode assembly	A highly durable fuel cell membrane electrode assembly and methods of manufacturing are provided.	Part of a <a href="#">commercial fuel cell technology</a> project.
7,563,532	07/21/09	E.I. du Pont de Nemours and Company	Trifluorostyrene containing compounds, and their use in polymer electrolyte membranes	A method for preparing a fluorinated ion exchange polymer by grafting a monomer onto a base polymer. These ion exchange polymers are useful in preparing catalyst coated membranes and membrane electrode assemblies for fuel cells.	Being used in continuing research at the company.
7,550,223	06/23/09	LANL	Method of making metal-polymer composite catalysts	A metal-polymer-carbon composite catalyst for use as a cathode electrocatalyst in fuel cells. The catalyst includes a heteroatomic polymer, a transition metal linked to the heteroatomic polymer by one of nitrogen, sulfur, and phosphorus, and a recast ionomer dispersed throughout the heteroatomic polymer-carbon composite.	Being used in continuing research at LANL.
7,517,604	04/14/09	3M Company	Fuel cell electrolyte membrane with acidic polymer	A fuel cell electrolyte membrane that can be used at high operating temperatures while preserving proton conductivity.	Part of a <a href="#">commercial fuel cell technology</a> project.

## Fuel Cell Patents Status

Patent Number	Award Date	Organization	Title	Description	Status
7,507,495	03/24/09	BNL	Hydrogen absorption induced metal deposition on palladium and palladium-alloy particles	Methods for producing metal-coated palladium or palladium-alloy particles, and for producing catalysts using the particles.	Being used in continuing research at BNL and seeking to license.
7,473,714	01/06/09	Virginia Polytechnic Institute	Materials for use as proton conducting membranes for fuel cells	A family of polymers having pendent sulfonate moieties connected to polymeric main chain phenyl groups. These polymers can be used in proton exchange membranes for fuel cells.	Licensed to Battelle Memorial Institute.
7,449,111	11/11/08	Arkema Inc.	Resins containing ionic or ionizable groups with small domain sizes and improved conductivity	A polymer that contains at least one acrylic resin or vinyl resin having at least one ionic or ionizable group. The polymer has improved conductivity when formed into a film and can be used in fuel cell membranes.	Part of an <a href="#">emerging fuel cell technology</a> project.
7,419,546	09/02/08	BASF Corporation	Gas diffusion electrodes, membrane-electrode assemblies and method for the production thereof	The invention relates to the production of an improved gas diffusion electrode for fuel cells. The electrode consists of an electrically conductive web, a non-catalyzed gas diffusion layer, and a noble metal coating.	Part of a <a href="#">commercial fuel cell technology</a> project.
7,396,880	07/08/08	Arkema Inc.	Blend of ionic (co)polymer resins and matrix (co)polymers	A novel polymeric resin blend useful for forming durable and chemical-resistant films for fuel cell membranes.	Part of an <a href="#">emerging fuel cell technology</a> project.
7,323,159	01/29/08	ANL	Method for fast start of a fuel processor	An improved fuel processor for fuel cells is provided whereby the startup time of the processor is less than 60 seconds and can be as low as 30 seconds, if not less.	Not licensed and not being used in research at ANL.
7,270,906	09/18/07	Delphi Technologies, Inc.	Solid-oxide fuel cell module for a fuel cell stack	A novel fuel cell module having four sheet metal parts stamped from flat stock. The parts do not require any forming operations such as folding or dishing, and each part may have a different thickness to suit its function.	Part of an <a href="#">emerging fuel cell technology</a> project.
7,264,778	09/04/07	SNL	Carbon monoxide sensor and method of use	Carbon monoxide sensors suitable for use in hydrogen feed streams and methods of use. The sensors are palladium metal/insulator/semiconductor sensors. The methods and sensors are particularly suitable for use in proton exchange membrane fuel cells.	Not licensed and not being used in research at SNL.
7,255,798	08/14/07	Ion Power, Inc.	Recycling of used perfluorosulfonic acid membranes	A method for recovering and recycling catalyst-coated fuel cell membranes includes dissolving the used membranes in water and solvent, heating the dissolved membranes under pressure, and separating the components.	Part of an <a href="#">emerging fuel cell technology</a> project.

### Fuel Cell Patents Status

Patent Number	Award Date	Organization	Title	Description	Status
7,247,403	07/24/07	ORNL	Surface modified stainless steels for PEM fuel cell bipolar plates	A nitridation treated stainless steel article (such as a bipolar plate for a proton exchange membrane fuel cell) having lower interfacial contact electrical resistance and better corrosion resistance than an untreated stainless steel article.	Part of an <a href="#">emerging fuel cell technology</a> project.
7,214,442	05/08/07	LANL	High specific power, direct methanol fuel cell stack	A fuel cell stack including at least one direct methanol fuel cell. A cathode manifold is used to convey ambient air to each fuel cell, and an anode manifold is used to convey liquid methanol fuel to each fuel cell.	Being used in continuing research at LANL.
7,211,346	05/01/07	ORNL	Corrosion-resistant metallic bipolar plate	An electrically conductive component such as a bipolar plate for a PEM fuel cell. The component has a substantially external, continuous layer of chromium nitride.	Part of an <a href="#">emerging fuel cell technology</a> project.
7,195,835	03/27/07	ANL	Proton conducting membrane for fuel cells	An ion conducting membrane comprising dendrimeric polymers covalently linked into a network structure.	No licensee and no further development of this technology at ANL.
7,138,199	11/21/06	Dynalene, Inc.	Fuel cell and fuel cell coolant compositions	Directed to coolant compositions, particularly coolant compositions useful in fuel cells, and to fuel cells containing such coolant compositions.	Part of a <a href="#">commercial fuel cell technology</a> project.
7,135,537	11/14/06	E.I. du Pont de Nemours and Company	Sulfonimide-containing poly(arylene ether)s and poly(arylene ether sulfone)s, methods for producing the same, and their uses	Directed to sulfonimide-containing polymers, for use in conductive membranes and fuel cells.	Not in a commercial product or licensed but being used in internally funded research.
7,101,643	09/05/06	LBNL	Polymeric electrolytes based on hydrosilylation reactions	New polymer electrolytes that are prepared by in situ cross-linking of allyl functional polymers based on a hydrosilylation reaction using a multifunctional silane cross-linker and an organoplatinum catalyst. The electrolyte membranes are insoluble in organic solvents and have high mechanical strength.	Being used in research at LBNL and seeking to license.
7,101,635	09/05/06	LANL	Methanol-tolerant cathode catalyst composite for direct methanol fuel cells	A direct methanol fuel cell having a methanol fuel supply, oxidant supply, and its membrane electrode assembly.	Not licensed and not being used at LANL for research.

## Fuel Cell Patents Status

Patent Number	Award Date	Organization	Title	Description	Status
7,101,527	09/05/06	Iowa State University	Mixed anion materials and compounds for novel proton conducting membranes	The present invention provides new amorphous or partially crystalline mixed anion chalcogenide compounds for use in proton exchange membranes which are able to operate over a wide variety of temperature ranges, including in the intermediate temperature range of about 100 ° C. to 300° C., and new uses for crystalline mixed anion chalcogenide compounds in such proton exchange membranes.	Being used in research at Iowa State University and seeking to license.
7,052,793	05/30/06	Foster-Miller, Inc.	Composite solid polymer electrolyte membranes	The invention relates to composite solid polymer electrolyte membranes (SPEMs), which include a porous polymer substrate interpenetrated with an ion-conducting material. These SPEMs are useful in electrochemical applications, including fuel cells and electro dialysis.	Being used in continuing research at the company.
7,022,810	04/04/06	SNL	Proton exchange membrane materials for the advancement of direct methanol fuel-cell technology	A new class of hybrid organic-inorganic materials, and methods of synthesis, which can be used as a proton exchange membrane in a direct methanol fuel cell.	Not licensed and not being used in research at SNL.
7,018,604	03/28/06	Iowa State University	Compounds for novel proton conducting membranes and methods of making same	A new set of compounds for use in polymer electrolyte membranes which are able to operate in a wide variety of temperature ranges, including in the intermediate temperature range of about 100°C to 700°C.	Being used in research at Iowa State University and seeking to license.
7,014,931	03/21/06	LANL	Methanol-tolerant cathode catalyst composite for direct methanol fuel cells	A direct methanol fuel cell having a methanol fuel supply, oxidant supply, and its membrane electrode assembly.	Not licensed and not being used at LANL for research.
6,995,114	02/07/06	Symyx Technologies, Inc.	Platinum-ruthenium-palladium fuel cell electrocatalyst	A catalyst for use in electrochemical reactor devices, the catalyst containing platinum, ruthenium, and palladium.	Not licensed and no research being done with this patent.
6,994,829	02/07/06	PNNL	Fluid processing device and method	A fluid processing unit having first and second interleaved flow paths in a cross flow configuration. The device can be used for vaporization of water, gasoline, and other fluids, and is useful for automotive fuel cell applications requiring rapid startup.	Research complete; seeking to license.
6,986,963	01/17/06	ORNL	Metallization of bacterial cellulose for electrical and electronic device manufacture	Metallized bacterial cellulose used in constructing fuel cells and other electronic devices.	No commercialization and no further development being pursued using this patent.
6,986,961	01/17/06	LANL	Fuel cell stack with passive air supply	A fuel cell stack comprised of a plurality of polymer electrolyte fuel cells.	Not licensed and not being used at LANL for research.

### Fuel Cell Patents Status

Patent Number	Award Date	Organization	Title	Description	Status
6,977,122	12/20/05	ANL	Proton conducting membrane for fuel cells	An ion conducting membrane comprising dendrimeric polymers covalently linked into a network structure.	No licensee and no further development of this technology at ANL.
6,962,760	11/08/05	LANL	Methods of conditioning direct methanol fuel cells	Methods for conditioning the membrane electrode assembly of a direct methanol fuel cell.	Not licensed and not being used at LANL for research.
6,956,083	10/18/05	LBNL	Single ion conductor cross-linked polymeric networks	The invention relates to the synthesis, characterization, and electrochemical response of a new type of single-ion comb-branch polymer electrolyte that can be used as a proton exchange membrane in fuel cells.	Being used in research at LBNL and seeking to license.
6,921,605	07/26/05	Symyx Technologies, Inc.	Platinum-ruthenium-nickel fuel cell electrocatalyst	A catalyst suitable for use in a fuel cell, especially as an anode catalyst, that contains platinum, ruthenium, and nickel.	Not licensed and no research being done with this patent.
6,864,004	03/08/05	LANL	Direct methanol fuel cell stack	A stack of direct methanol fuel cells exhibiting a circular footprint.	Not licensed and not being used at LANL for research.
6,847,188	01/25/05	General Motors Corporation	Fuel cell stack monitoring and system control	A control method for monitoring a fuel cell stack in a fuel cell system in which the actual voltage and actual current from the fuel cell stack are monitored.	Being used in continuing research at the company.
6,818,341	11/16/04	LANL	Fuel cell anode configuration for CO tolerance	A polymer electrolyte fuel cell (PEFC) is designed to operate on a reformat fuel stream containing oxygen and diluted hydrogen fuel with CO impurities.	Being used in research at LANL but no licensees.
6,808,838	10/26/04	LANL	Direct methanol fuel cell and system	A fuel cell having an anode and a cathode and a polymer electrolyte membrane located between anode and cathode gas diffusion backings uses a methanol vapor fuel supply.	Not licensed and not being used at LANL for research.
6,790,548	09/14/04	General Motors Corporation	Staged venting of fuel cell system during rapid shutdown	A venting methodology and system for rapid shutdown of a fuel cell apparatus used in a vehicle propulsion system.	Being used in continuing research at the company.
6,723,678	04/20/04	Symyx Technologies, Inc.	Platinum-ruthenium-nickel alloy for use as a fuel cell catalyst	An improved noble metal alloy composition for a fuel cell catalyst, the alloy containing platinum, ruthenium, and nickel. The alloy shows methanol oxidation activity.	Not licensed and no research being done with this patent.
6,696,382	02/24/04	LANL	Catalyst inks and method of application for direct methanol fuel cells	Inks are formulated for forming anode and cathode catalyst layers and applied to anode and cathode sides of a membrane for a direct methanol fuel cell.	Not licensed and not being used at LANL for research.
6,692,851	02/17/04	General Motors Corporation	Fuel cell stack monitoring and system control	A control method for monitoring the voltage and current from a fuel cell stack.	Being used in continuing research at the company.

## Fuel Cell Patents Status

Patent Number	Award Date	Organization	Title	Description	Status
6,686,084	02/03/04	Hybrid Power Generation Systems, LLC	Gas block mechanism for water removal in fuel cells	An apparatus and method for removing water from the cathode side of a fuel cell.	No longer being used.
6,682,837	01/27/04	Symyx Technologies, Inc.	Method for producing electricity using a platinum-ruthenium-palladium catalyst in a fuel cell	A method for producing electricity using a fuel cell that utilizes a ternary alloy composition as a fuel cell catalyst, the ternary alloy composition containing platinum, ruthenium, and palladium.	Not licensed and no research being done with this patent.
6,670,301	12/30/03	BNL	Carbon monoxide tolerant electrocatalyst with low platinum loading and a process for its preparation	An electrocatalyst is provided for use in a fuel cell that has low platinum loading and a high tolerance to carbon monoxide poisoning.	Part of an <a href="#">emerging fuel cell technology</a> project.
6,653,005	11/25/03	U. Central Florida	Portable hydrogen generator-fuel cell apparatus	A compact hydrogen generator is coupled to or integrated with a fuel cell for portable power applications.	Being used in research at University of Central Florida but no licensees.
6,635,369	10/21/03	LANL	Method for improving fuel cell performance	A method is provided for operating a fuel cell at high voltage for sustained periods of time.	Being used in research at LANL but no licensees.
6,617,065	09/09/03	Teledyne Energy Systems, Inc.	Method and apparatus for maintaining neutral water balance in a fuel cell system	A method for maintaining a neutral water balance in a fuel cell system, wherein water from the exhaust of a fuel cell stack is recycled for use in the system's humidifiers and other components. The water balance is maintained by adjusting the fuel cell stack operating temperature based on the water level in the system's water reservoir.	No longer being used.
6,607,854	08/19/03	Honeywell International Inc.	Three-wheel air turbocompressor for PEM fuel cell systems	A fuel cell system that utilizes a pair of parallel turbines engaged to a compressor for increased system efficiency.	No longer being used.
6,602,624	08/05/03	General Motors Corporation	Control apparatus and method for efficiently heating a fuel processor in a fuel cell system	An apparatus and method for efficiently controlling the amount of heat generated by a fuel processor in a fuel cell system. A temperature error between actual and desired fuel processor temperatures is determined; this error is converted to a combustor fuel injector command signal or a heat dump valve position command signal depending upon the type of error.	Being used in continuing research at the company.
6,596,422	07/22/03	LANL	Air breathing direct methanol fuel cell	A method for activating a membrane electrode assembly for a direct methanol fuel cell is disclosed. The method comprises operating the fuel cell with humidified hydrogen as the fuel followed by running the fuel cell with methanol as the fuel.	Not licensed and not being used at LANL for research.

### Fuel Cell Patents Status

Patent Number	Award Date	Organization	Title	Description	Status
6,576,359	06/10/03	General Motors Corporation	Controlled air injection for a fuel cell system	A method and apparatus for injecting oxygen into a fuel cell reformat stream to reduce the level of carbon monoxide while preserving the level of hydrogen in a fuel cell system.	Being used in continuing research at the company.
6,551,736	04/22/03	Teledyne Energy Systems, Inc.	Fuel cell collector plates with improved mass transfer channels	Fuel cell collector plates with new channel constructions for improving the transportation of gases to the cell's gas diffusion layers.	Research complete; seeking to license.
6,528,198	03/04/03	Plug Power, Inc.	Fuel cell membrane hydration and fluid metering	A hydration system includes fuel cell fluid flow plate(s) and injection port(s).	No longer being used.
6,517,965	02/11/03	Symyx Technologies, Inc.	Platinum-ruthenium-nickel alloy for use as a fuel cell catalyst	An improved noble metal alloy composition for a fuel cell catalyst, the alloy containing platinum, ruthenium, and nickel. The alloy shows methanol oxidation activity.	Not licensed and no research being done with this patent.
6,498,121	12/24/02	Symyx Technologies, Inc.	Platinum-ruthenium-palladium alloys for use as a fuel cell catalyst	A noble metal alloy composition for a fuel cell catalyst, a ternary alloy composition containing platinum, ruthenium and palladium. The alloy shows increased activity compared with well-known catalysts.	Not licensed and no research being done with this patent.
6,497,970	12/24/02	General Motors Corporation	Controlled air injection for a fuel cell system	A method and apparatus for injecting oxygen into a fuel cell reformat stream to reduce the level of carbon monoxide while preserving the level of hydrogen in a fuel cell system.	Being used in continuing research at the company.
6,492,052	12/10/02	LANL	Air breathing direct methanol fuel cell	An air breathing direct methanol fuel cell is provided with a membrane electrode assembly, a conductive anode assembly that is permeable to air and directly open to atmospheric air, and a conductive cathode assembly that is permeable to methanol and directly contacting a liquid methanol source.	Not licensed and not being used at LANL for research.
6,490,812	12/10/02	PNNL	Active microchannel fluid processing unit and method of making	An active microchannel fluid processing unit.	Exclusive license to Velocys, Inc.
6,458,479	10/01/02	LANL	Air breathing direct methanol fuel cell	An air breathing direct methanol fuel cell is provided with a membrane electrode assembly, a conductive anode assembly that is permeable to air and directly open to atmospheric air, and a conductive cathode assembly that is permeable to methanol and directly contacting a liquid methanol source.	Not licensed and not being used at LANL for research.



## Fuel Cell Patents Status

Patent Number	Award Date	Organization	Title	Description	Status
6,455,180	09/24/02	General Motors Corporation	Flexible method for monitoring fuel cell voltage	A method for monitoring the voltage of different groups of cells (a.k.a., "clusters") within a fuel cell stack, wherein the number of cells in a cluster can be varied. The method improves fuel cell stack diagnostic monitoring by enabling identification of individual cells within the stack that are contributing to a voltage drop across the entire stack.	Being used in continuing research at the company.
6,454,922	09/24/02	LANL	Corrosion test cell for bipolar plates	A corrosion test cell for evaluating corrosion resistance in fuel cell bipolar plates.	Exclusive license to Fuel Cell Technologies, Inc. - <a href="#">Commercial</a>
6,451,471	09/17/02	Teledyne Energy Systems, Inc.	Conductivity fuel cell collector plate and method of fabrication	An improved method of manufacturing PEM fuel cell collector plates that increases the electrical conductivity and mechanical strength of the plates.	Research complete; seeking to license.
6,451,465	09/17/02	General Motors Corporation	Method for operating a combustor in a fuel cell system	A method of operating a combustor to heat a fuel processor in a fuel cell system, in which the fuel processor includes a reactor which generates a hydrogen containing stream.	No longer being pursued, abandoned.
6,436,561	08/20/02	General Motors Corporation	Methanol tailgas combustor control method	A method for controlling the power, temperature, and fuel source of a combustor used to supply heat to a fuel reformer used for generating hydrogen from liquid fuels (e.g., methanol) in on-board automotive applications.	Being used in continuing research at the company.
6,416,893	07/09/02	General Motors Corporation	Method and apparatus for controlling combustor temperature during transient load changes	A method and apparatus for controlling the temperature of a combustor in an automotive fuel cell system. The method includes a fast acting air bypass valve connected in parallel with an air inlet to the combustor.	Being used in continuing research at the company.
6,413,662	07/02/02	General Motors Corporation	Fuel cell system shutdown with anode pressure control	A venting methodology and pressure sensing and vent valving arrangement for monitoring anode bypass valve operating during the normal shutdown of a fuel cell apparatus of the type used in vehicle propulsion systems.	Being used in continuing research at the company.
6,413,661	07/02/02	General Motors Corporation	Method for operating a combustor in a fuel cell system	A method of operating a combustor to heat a fuel processor to a desired temperature in a fuel cell system, wherein the fuel processor generates hydrogen from a hydrocarbon for reaction within a fuel cell to generate electricity.	No longer being pursued, abandoned.
6,395,414	05/28/02	General Motors Corporation	Staged venting of fuel cell system during rapid shutdown	A venting methodology and system for rapid shutdown of a fuel cell apparatus of the type used in a vehicle propulsion system.	Being used in continuing research at the company.



### Fuel Cell Patents Status

Patent Number	Award Date	Organization	Title	Description	Status
6,376,112	04/23/02	General Motors Corporation	Controlled shutdown of a fuel cell	A method is provided for the shutdown of a fuel cell system to relieve system overpressure while maintaining air compressor operation, and corresponding vent valving and control arrangement. The method and venting arrangement can be employed in a fuel cell system used for vehicle propulsion.	Being used in continuing research at the company.
6,372,376	04/16/02	General Motors Corporation	Corrosion resistant PEM fuel cell	A PEM fuel cell having electrical contact elements comprising a corrosion-susceptible substrate metal coated with an electrically conductive, corrosion-resistant polymer.	Being used in continuing research at the company.
6,306,531	10/23/01	General Motors Corporation	Combustor air flow control method for fuel cell apparatus	A method for controlling the heat output of a combustor used to provide heat to a fuel reformer in a fuel cell apparatus.	Being used in continuing research at the company.
6,296,964	10/02/01	LANL	Enhanced methanol utilization in direct methanol fuel cell	The fuel utilization of a direct methanol fuel cell is enhanced for improved cell efficiency.	Not licensed and not being used at LANL for research.
6,277,513	08/21/01	General Motors Corporation	Layered electrode for electrochemical cells	A fuel cell electrode structure consisting of a current collector sheet and first and second layers of electrode material. The electrode design improves catalyst utilization and water management.	Being used in continuing research at the company.
6,268,074	07/31/01	General Motors Corporation	Water injected fuel cell system compressor	A fuel cell system that uses a dry compressor for pressurizing air supplied to the cathode side of the fuel cell. An injector sprays a controlled amount of water onto the compressor's rotor(s) to improve the energy efficiency of the compressor.	Being used in continuing research at the company.
6,265,222	07/24/01	Advanced Technology Materials, Inc.	Micro-machined thin film hydrogen gas sensor and method of making and using the sensor	A hydrogen sensor including a thin film sensor element formed, e.g., by metalorganic chemical vapor deposition or physical vapor deposition, on a microhotplate structure.	Patent sold to Honeywell but no further R&D being done with the patent at this time.
6,265,092	07/24/01	General Motors Corporation	Method of controlling injection of oxygen into hydrogen-rich fuel cell feed stream	A method of operating a H <sub>2</sub> - O <sub>2</sub> fuel cell fueled by hydrogen-rich fuel stream containing CO. The CO content is reduced to acceptable levels by injecting oxygen into the fuel gas stream.	Being used in continuing research at the company.

## Fuel Cell Patents Status

Patent Number	Award Date	Organization	Title	Description	Status
6,255,012	07/03/01	LANL	Pleated metal bipolar assembly	"Bipolar plates for electrochemical cells are formed from conductive foils that are supported by a polymer support plate. The polymer support plate can be readily configured with flow fields during a manufacturing process, such as injection molding, without the need for machining. Likewise, the conductive foils can be stamped or corrugated to matching configurations without any need for machining. The resulting structure is inexpensive to form and is compact and lightweight.	Being used in continuing research at LANL.
6,248,469	06/19/01	Foster-Miller, Inc.	Composite solid polymer electrolyte membranes	The invention relates to composite solid polymer electrolyte membranes (SPEMs), which include a porous polymer substrate interpenetrated with an ion-conducting material. These SPEMs are useful in electrochemical applications, including fuel cells and electro dialysis.	Being used in continuing research at the company.
6,248,467	06/19/01	LANL	Composite bipolar plate for electrochemical cells	A bipolar separator plate for fuel cells consists of a molded mixture of a vinyl ester resin and graphite powder.	Exclusive license to BMCI - <a href="#">Commercial</a>
6,232,005	05/15/01	General Motors Corporation	Fuel cell system combustor	A fuel cell system including a fuel reformer heated by a catalytic combustor fired by anode and cathode effluents.	No longer being pursued, abandoned.
6,207,310	03/27/01	LANL	Fuel cell with metal screen flow-field	A polymer electrolyte membrane fuel cell is provided with electrodes supplied with a reactant on each side of a catalyzed membrane assembly.	Not licensed and not being used at LANL for research.
6,200,536	03/13/01	PNNL	Active microchannel heat exchanger	An active microchannel heat exchanger with an active heat source and with microchannel architecture. The invention is particularly useful as a liquid fuel vaporizer and/or a steam generator for fuel cell power systems.	Exclusive license to Velocys, Inc.
6,192,596	02/27/01	PNNL	Active microchannel fluid processing unit and method of making	An active microchannel fluid processing unit.	Exclusive license to Velocys, Inc., and in pilot testing now.
6,183,894	02/06/01	BNL	Electrocatalyst for alcohol oxidation in fuel cells	Binary and ternary electrocatalysts are provided for oxidizing alcohol in a fuel cell.	Not licensed or commercialized. Research is on-going.
6,180,275	01/30/01	Energy Partners, LC	Fuel cell collector plate and method of fabrication	An improved molding composition is provided for compression molding or injection molding a current collector plate for a polymer electrolyte membrane fuel cell.	No longer being used in research.

### Fuel Cell Patents Status

Patent Number	Award Date	Organization	Title	Description	Status
6,171,720	01/09/01	ORNL	Bipolar plate/diffuser for a proton exchange membrane fuel cell	A combination bipolar plate/diffuser fuel cell component that includes an electrically conducting solid material having a porous region and a hermetic region.	Being used in <a href="#">commercially available bipolar plates</a> sold by Porvair Advanced Materials, Inc.
6,159,626	12/12/00	General Motors Corporation	Fuel cell system logic for differentiating between rapid and normal shutdown commands	A method of controlling the operation of a fuel cell system wherein each shutdown command for the system is subjected to decision logic which determines whether the command should be a normal shutdown command or rapid shutdown command.	Being used in continuing research at the company.
6,159,533	12/12/00	Southwest Research Institute	Method of depositing a catalyst on a fuel cell electrode	Fuel cell electrodes comprising a minimal load of catalyst having maximum catalytic activity and a method of forming such fuel cell electrodes.	No licensee and no research being done with this technology.
6,129,973	10/10/00	PNNL	Microchannel laminated mass exchanger and method of making	A microchannel mass exchanger having a first plurality of inner thin sheets and a second plurality of outer thin sheets is described. The device enables solute molecules in a solvent to pass from the solvent to a mass transfer medium in an efficient manner.	Exclusive license to Velocys, Inc.
6,126,723	10/03/00	PNNL	Microcomponent assembly for efficient contacting of fluid	Method and apparatus for a microcomponent assembly that achieves state-of-the-art chemical separation via absorption and/or adsorption mechanisms. The device can be utilized as a fuel processing system in fuel-cell-powered automobiles for removal of catalyst poisons (e.g., H <sub>2</sub> S and CO) from the fuel stream.	Exclusive license to Velocys, Inc.
6,117,577	09/12/00	LANL	Ambient pressure fuel cell system	An ambient pressure fuel cell system is provided with a fuel cell stack formed from a plurality of fuel cells having membrane/electrode assemblies.	Non-exclusive license to IdaTech - Not being used.
6,103,409	08/15/00	General Motors Corporation	Fuel cell flooding detection and correction	A method and apparatus for monitoring PEM fuel cells to detect and correct flooding.	Being used in continuing research at the company.
6,099,984	08/08/00	General Motors Corporation	Mirrored serpentine flow channels for fuel cell	A PEM fuel cell having serpentine flow field channels, wherein the input/inlet legs of each channel border the input/inlet legs of the next adjacent channels in the same flow field.	Being used in continuing research at the company.
6,077,620	06/20/00	General Motors Corporation	Fuel cell system with combustor-heated reformer	A fuel cell system including a fuel reformer heated by a catalytic combustor fired by anode effluent and/or fuel from a liquid fuel supply providing fuel for the fuel cell.	No longer being pursued, abandoned.
6,074,692	06/13/00	General Motors Corporation	Method of making MEA for PEM/SPE fuel cell	A method of making a membrane-electrode-assembly (MEA) for a PEM/SPE fuel cell by applying a slurry of electrode-forming material directly onto a membrane-electrolyte film.	Being used in continuing research at the company.

## Fuel Cell Patents Status

Patent Number	Award Date	Organization	Title	Description	Status
6,066,408	05/23/00	Plug Power, LLC	Fuel cell cooler-humidifier plate	A cooler-humidifier plate for use in a proton exchange membrane fuel cell stack assembly. The cooler-humidifier plate combines functions of cooling and humidification within the fuel cell stack assembly, thereby providing a more compact structure, simpler manifolding, and reduced reject heat from the fuel cell.	No longer being used.
6,063,516	05/16/00	General Motors Corporation	Method of monitoring CO concentrations in hydrogen feed to a PEM fuel cell	The CO concentration in the H <sub>2</sub> feed stream to a PEM fuel cell stack is monitored by measuring current and/or voltage behavior patterns from a PEM-probe communicating with the reformat feed stream.	Being used in continuing research at the company.
6,017,648	01/25/00	Plug Power, LLC	Insertable fluid flow passage bridgepiece and method	A fluid flow passage bridgepiece for insertion into an open-face fluid flow channel of a fluid flow plate.	No longer being used.
6,007,933	12/28/99	Plug Power, LLC	Fuel cell assembly unit for promoting fluid service and electrical conductivity	Fluid service and/or electrical conductivity for a fuel cell assembly.	Still being used in research.
6,001,499	12/14/99	General Motors Corporation	Fuel cell CO sensor	The CO concentration in the H <sub>2</sub> feed stream to a PEM fuel cell stack is monitored by measuring current and/or voltage behavior patterns from a PEM-probe communicating with the reformat feed stream.	Being used in continuing research at the company.
5,998,054	12/07/99	Plug Power, LLC	Fuel cell membrane hydration and fluid metering	A hydration system including fuel cell fluid flow plate(s) and injection port(s). Each plate has flow channel(s) with respective inlet(s) for receiving portion(s) of a reactant fluid for a fuel cell. Each injection port injects a portion of liquid water directly into its respective flow channel to mix its portion of liquid water with a portion of the stream.	No longer being used.
5,952,119	09/14/99	LANL	Fuel cell membrane humidification	A method for supplying liquid water to the polymer electrolyte membrane of a fuel cell using distribution channels over the gas diffusion backing. This simple membrane humidification system uniformly distributes water to the membrane surface thus improving the performance of the fuel cell.	Non-exclusive license to IdaTech - Not being used.
5,945,229	08/31/99	General Motors Corporation	Pattern recognition monitoring of PEM fuel cell	The CO-concentration in the H <sub>2</sub> feed stream to a PEM fuel cell stack is monitored by measuring current and voltage behavior patterns from an auxiliary cell attached to the end of the stack.	Being used in continuing research at the company.

### Fuel Cell Patents Status

Patent Number	Award Date	Organization	Title	Description	Status
5,932,185	08/03/99	LLNL	Method for making thin carbon foam electrodes	A method for fabricating thin, flat carbon electrodes by infiltrating highly porous carbon papers, membranes, felts, metal fibers/powders, or fabrics with an appropriate carbon foam precursor material.	No licenses and no research being done with this patent.
5,916,710	06/29/99	LBNL	Sodium cobalt bronze batteries and a method for making same	A solid state secondary battery utilizing a low cost, environmentally sound, sodium cobalt bronze electrode.	No longer being used.
5,798,187	08/25/98	LANL	Fuel cell with metal screen flow-field	A polymer electrolyte membrane fuel cell is provided with electrodes supplied with a reactant on each side of a catalyzed membrane assembly.	Not licensed and not being used at LANL for research.
5,783,152	07/21/98	SRL	Thin-film fiber optic hydrogen and temperature sensor system	A sensor probe device for monitoring of hydrogen gas concentrations and temperatures.	No longer being used in research; returned to DOE.
5,776,624	07/07/98	General Motors Corporation	Brazed bipolar plates for PEM fuel cells	A liquid-cooled, bipolar plate separating adjacent cells of a PEM fuel cell comprising corrosion-resistant metal sheets brazed together so as to provide a passage between the sheets through which a dielectric coolant flows.	Being used in continuing research at the company.
5,763,113	06/09/98	General Motors Corporation	PEM fuel cell monitoring system	A method and apparatus for monitoring the performance of PEM fuel cells. Outputs from a cell/stack voltage monitor and a cathode exhaust gas hydrogen sensor are corrected for stack operating conditions, and then compared to predetermined levels of acceptability.	Being used in continuing research at the company.
5,743,646	04/28/98	General Motors Corporation	Temperature sensor with improved thermal barrier and gas seal between the probe and housing	An improved temperature sensor that can be used to measure gas temperature in automotive exhaust systems or in fuel cell subsystems used to generate electric power.	Being used in continuing research at the company.
5,707,755	01/13/98	General Motors Corporation	PEM/SPE fuel cell	A PEM/SPE fuel cell including a membrane-electrode assembly (MEA) having a plurality of oriented filament embedded the face thereof for supporting the MEA and conducting current therefrom to contiguous electrode plates.	Being used in continuing research at the company.
5,654,109	08/05/97	General Motors Corporation	Composite fuel cell membranes	A bilayer or trilayer composite ion exchange membrane suitable for use in a fuel cell. The composite membrane has a high equivalent weight thick layer in order to provide sufficient strength and low equivalent weight surface layers for improved electrical performance.	Being used in continuing research at the company.
5,641,586	06/24/97	LANL	Fuel cell with interdigitated porous flow-field	A polymer electrolyte membrane fuel cell is formed with an improved system for distributing gaseous reactants to the membrane surface.	Not licensed and not being used at LANL for research.

## Fuel Cell Patents Status

Patent Number	Award Date	Organization	Title	Description	Status
5,636,437	06/10/97	LLNL	Fabricating solid carbon porous electrodes from powders	Fabrication of conductive solid porous carbon electrodes for use in batteries, double layer capacitors, fuel cells, capacitive deionization, and waste treatment.	No licenses and no research being done with this patent.
5,624,769	04/29/97	General Motors Corporation	Corrosion resistant PEM fuel cell	A PEM fuel cell having electrical contact elements (e.g., bipolar plates) that consist of a titanium-nitride-coated, lightweight metal core, with a passivating, protective metal layer between the core and the titanium nitride.	Being used in continuing research at the company.
5,601,938	02/11/97	LLNL	Carbon aerogel electrodes for direct energy conversion	A direct energy conversion device, such as a fuel cell, using carbon aerogel electrodes, wherein the carbon aerogel is loaded with a noble catalyst, such as platinum or rhodium and soaked with phosphoric acid.	No licenses and no research being done with this patent.
5,558,961	09/24/96	LBNL	Secondary cell with orthorhombic alkali metal/manganese oxide phase active cathode material	An alkali metal manganese oxide secondary cell that can provide a high rate of discharge, good cycling capabilities, good stability of the cathode material, high specific energy (energy per unit of weight) and high energy density (energy per unit volume).	No longer being used.
5,443,601	08/22/95	LBNL	Method for intercalating alkali metal ions into carbon electrodes	A low cost, relatively flexible, carbon electrode for use in a secondary battery. Methods for producing the electrode are also provided, including intercalating alkali metal salts such as sodium and lithium into carbon.	No longer being used.
5,316,871	05/31/94	General Motors Corporation	Method of making membrane-electrode assemblies for electrochemical cells and assemblies made thereby	A method of making a combination, unitary, membrane and electrode assembly having a solid polymer electrolyte membrane, and first and second electrodes at least partially embedded in opposed surfaces of the membrane.	Being used in continuing research at the company.
5,248,566	09/28/93	ANL	Fuel cell system for transportation applications	A propulsion system for a vehicle having pairs of front and rear wheels and a fuel tank.	Not licensed but being used in research at ANL.
4,657,829	04/14/87	United Technologies Corporation	Fuel cell power supply with oxidant and fuel gas switching	Relating to a fuel cell vehicular power plant, fuel for the fuel stack is supplied by a hydrocarbon (methanol) catalytic cracking reactor and CO shift reactor.	Patent has expired and not used by UTC in commercial products.
4,650,727	03/17/87	LANL	Fuel processor for fuel cell power system	A catalytic organic fuel processing apparatus, which can be used in a fuel cell power system, contains within a housing a catalyst chamber, a variable speed fan, and a combustion chamber.	Not licensed and not being used for research at LANL.





## Production/Delivery Patents Status

Patent Number	Award Date	Organization	Title	Description	Status
7,926,793	04/19/11	PNNL	Mixing in wicking structures and the use of enhanced mixing within wicks in microchannel devices	Advanced wicking structures and methods utilizing these structures are described. Particularly improved results in fluid contacting processes can be achieved by enhanced mixing within a wicking layer within a microchannel.	Being used in continuing research at PNNL and seeking to license.
7,910,373	03/22/11	NREL	H <sub>2</sub> O doped WO <sub>3</sub> , ultra-fast, high-sensitivity hydrogen sensors	An improved sensor for optically detecting hydrogen gas at low concentrations. The sensor consists of a substrate, a water-doped WO <sub>3</sub> layer coated on the substrate, and a palladium layer coated on the water-doped WO <sub>3</sub> layer.	Research complete; seeking to license.
7,906,079	03/15/11	Catacel Corporation	Stackable structural reactor	A reactor including a monolith having a plurality of fins in an annular arrangement for receiving fluid flow through the reactor. The monolith is disposed within a generally cylindrical outer tube, and around a corrugated inner tube. The reactor includes a device for urging the monolith radially outward, so as to maintain contact between the monolith and the outer tube.	Part of an <a href="#">emerging hydrogen production technology</a> project.
7,879,750	02/01/11	General Electric Company	Anodes for alkaline electrolysis	A method of making an anode for alkaline electrolysis cells used for the production of hydrogen.	Research complete; seeking to license.
7,872,054	01/18/11	Virent Energy Systems, Inc.	Method for producing bio-fuel that integrates heat from carbon-carbon bond-forming reactions to drive biomass gasification reactions	A low-temperature catalytic process for converting biomass (preferably glycerol recovered from the fabrication of bio-diesel) to synthesis gas (i.e., H <sub>2</sub> /CO gas mixture) in an endothermic gasification reaction.	Being used in continuing research at the company; non-exclusive license to Equilon Enterprises, LLC.
7,850,838	12/14/10	Proton Energy Systems, Inc.	Cold weather hydrogen generation system and method of operation	An enclosed system that produces hydrogen gas from the electrolysis of water. Operation in cold climates is enabled by one or more heat generation devices that prevent the system's components from freezing.	Part of a <a href="#">commercial hydrogen production technology</a> product.
7,771,519	08/10/10	Air Products & Chemicals, Inc.	Liners for ion transport membrane systems	An ion transport membrane system consisting of a pressure vessel, a series of planar ion transport membrane modules in the interior of the pressure vessel, a gas manifold that is in flow communication with each membrane module, and a liner within the inlet/outlet conduits to the pressure vessel and on the interior surface of the gas manifold.	Part of an <a href="#">emerging hydrogen production technology</a> project.
7,767,867	08/03/10	Virent Energy Systems, Inc.	Methods and systems for generating polyols	Methods for generating propylene glycol, ethylene glycol and other polyols, diols, ketones, aldehydes, carboxylic acids and alcohols using hydrogen produced from biomass.	Part of an <a href="#">emerging hydrogen production technology</a> project.



### Production/Delivery Patents Status

Patent Number	Award Date	Organization	Title	Description	Status
7,744,733	06/29/10	Proton Energy Systems, Inc.	Gas venting system	A system for venting a moist gas stream resulting from operation of electrochemical cells within an enclosure, and for preventing the water vapor in the moist gas stream from freezing within the enclosure.	Part of a <a href="#">commercial hydrogen production technology</a> product.
7,736,609	06/15/10	Ergenics Corporation	Hydrogen purification system	The invention provides a system to purify hydrogen involving the use of a hydride compressor and catalytic converters combined with a process controller.	Being used in continuing research efforts at Ergenics Corporation.
7,732,174	06/08/10	NREL	Multi-stage microbial system for continuous hydrogen production	The invention relates to a continuous H <sub>2</sub> production system in which photosynthetic O <sub>2</sub> evolution and H <sub>2</sub> photoproduction are separated physically in two separate bioreactors.	Being used in continuing research efforts at NREL and seeking to license.
7,703,472	04/27/10	Air Products & Chemicals, Inc.	Module isolation devices	Gas flow isolation devices for Ion Transport Membrane (ITM) modules designed for producing purified oxygen from an oxygen-containing gas (e.g., air) or for producing synthesis gas. The devices isolate the flow of gas from one module into one or more other modules that are joined together through one or more common headers.	Part of an <a href="#">emerging hydrogen production technology</a> project.
7,695,580	04/13/10	Air Products & Chemicals, Inc.	Method of forming a ceramic to ceramic joint	A method of forming a joint at an interface between two sintered bodies comprising metallic oxides of specific crystal structure. The method can be used to form gas-tight joints between ceramic components in an oxygen separation device.	Part of an <a href="#">emerging hydrogen production technology</a> project.
7,691,775	04/06/10	University of Michigan	Reducible oxide based catalysts	The invention relates to an improved catalyst for the water gas shift reaction, which is used in the production of hydrogen. The catalyst includes a reducible oxide support and at least one noble metal fixed on the reducible oxide support.	Research complete; seeking to license.
7,678,251	03/16/10	Proton Energy Systems, Inc.	System and method for detecting gas	A method for detecting the presence of a specific gas in a mixture of gases resulting from operation of an electrochemical cell.	Part of a <a href="#">commercial hydrogen production technology</a> product.
7,666,534	02/23/10	ANL	Electro-catalytic oxidation device for removing carbon from a fuel reformat	An electro-catalytic oxidation device (ECOD) for the removal of contaminants, preferably carbonaceous materials, from an influent comprising an ECOD anode, an ECOD cathode, and an ECOD electrolyte.	Being used in continuing research efforts at ANL.

## Production/Delivery Patents Status

Patent Number	Award Date	Organization	Title	Description	Status
7,658,788	02/09/10	Air Products & Chemicals, Inc.	Ion transport membrane module and vessel system with directed internal gas flow	An ion transport membrane reactor system which can be used to oxidize a reactant gas feed stream containing hydrocarbons, such as methane, and thereby produce a product gas stream containing hydrogen and carbon oxides.	Part of an <a href="#">emerging hydrogen production technology</a> project.
7,651,669	01/26/10	PNNL	Microsystem process networks	Various aspects and applications of microsystem process networks which can be improved by employing ortho-cascading mass, heat, or other unit process operations are described. One such application is the production of hydrogen via steam reformation of hydrocarbons.	No longer being pursued at PNNL; owned by the U.S. Department of Energy.
7,642,405	01/05/10	ORNL	Switchable photosystem-II designer algae for photobiological hydrogen production	A switchable photosystem-II (PSII) designer algae for photobiological hydrogen production. The designer transgenic algae includes at least two transgenes for enhanced photobiological H <sub>2</sub> production wherein a first transgene serves as a genetic switch that can control PSII oxygen evolution and a second transgene encodes for creation of free proton channels in the algal photosynthetic membrane.	No longer being used.
7,604,771	10/20/09	ANL	Thermal method for fabricating a hydrogen separation membrane on a porous substrate	A thermal method of making a hydrogen permeable composition for use in hydrogen separation membranes.	Being used in continuing research efforts at ANL.
7,588,626	09/15/09	Boston University	Composite mixed oxide ionic and electronic conductors for hydrogen separation	A mixed ionic and electrically conducting membrane that includes a two-phase solid state ceramic composite, wherein the first phase is an oxygen ion conductor and the second phase is an n-type electrically conductive oxide. The membrane can be used to separate hydrogen from a mixture of gases and purify it for use in fuel cells.	Research complete; seeking to license.
7,581,765	09/01/09	Air Products & Chemicals, Inc.	Seal assembly for materials with different coefficients of thermal expansion	An improved seal assembly for couplings and joints between materials with different coefficients of thermal expansion (e.g., metals and ceramics) used in high-temperature gas processing devices.	Part of an <a href="#">emerging hydrogen production technology</a> project.

**Production/Delivery Patents Status**

<b>Patent Number</b>	<b>Award Date</b>	<b>Organization</b>	<b>Title</b>	<b>Description</b>	<b>Status</b>
7,563,292	07/21/09	ANL	Fuel processor and method for generating hydrogen for fuel cells	A method of producing a H <sub>2</sub> rich gas stream includes supplying an O <sub>2</sub> rich gas, steam, and fuel to an inner reforming zone of a fuel processor that includes a partial oxidation catalyst and a steam reforming catalyst or a combined partial oxidation and steam reforming catalyst.	Being used in continuing research efforts at ANL.
7,559,978	07/14/09	General Electric Company	Gas-liquid separator and method of operation	A system for gas-liquid separation in electrolysis equipment used for hydrogen production.	Research complete; seeking to license.
7,556,675	07/07/09	Air Products & Chemicals, Inc.	Feed gas contaminant control in ion transport membrane systems	Methods for constructing ion transport membrane (ITM) reactor systems so that the system's metal components do not react with high-temperature mixtures of steam, methane, and/or synthesis gas, thereby preventing the production of ITM-poisoning contaminant vapors.	Part of an <a href="#">emerging hydrogen production technology</a> project.
7,540,475	06/02/09	PNNL	Mixing in wicking structures and the use of enhanced mixing within wicks in microchannel devices	Advanced wicking structures and methods utilizing these structures are described. Particularly improved results in fluid contacting processes can be achieved by enhanced mixing within a wicking layer within a microchannel.	Being used in continuing research at PNNL and seeking to license.
7,520,917	04/21/09	PNNL	Devices with extended area structures for mass transfer processing of fluids	The invention relates to microchannel devices used for performing fluid processing and heat exchange.	Being used in continuing research at PNNL.
7,513,932	04/07/09	Air Products & Chemicals, Inc.	Planar ceramic membrane assembly and oxidation reactor system	A planar ceramic membrane assembly comprising a dense layer of mixed-conducting multi-component metal oxide material, wherein the dense layer has a first side and a second side, a porous layer of mixed-conducting multi-component metal oxide material in contact with the first side of the dense layer, and a ceramic channeled support layer in contact with the second side of the dense layer.	Part of an <a href="#">emerging hydrogen production technology</a> project.
7,507,690	03/24/09	ANL	Autothermal reforming catalyst having perovskite structure	A novel fuel reforming catalyst with a perovskite structure that can be used to produce hydrogen for use in fuel cells.	Being used in continuing research efforts at ANL.
7,501,101	03/10/09	PNNL	Microchannel apparatus comprising plural microchannels and methods of conducting unit operations	A microchannel apparatus comprising a header and plural flow microchannels is described in which orifices connect the header and the flow microchannels. Methods of conducting unit operations in the apparatus are also described.	Exclusive license to Velocys, Inc.

## Production/Delivery Patents Status

Patent Number	Award Date	Organization	Title	Description	Status
7,485,161	02/03/09	Air Products & Chemicals, Inc.	Dehydrogenation of liquid fuel in microchannel catalytic reactor	An improved process for the storage and delivery of hydrogen by the reversible hydrogenation/dehydrogenation of an organic compound in a microchannel reactor.	Part of an <a href="#">emerging hydrogen production technology</a> project.
7,468,092	12/23/08	Air Products & Chemicals, Inc.	Operation of mixed conducting metal oxide membrane systems under transient conditions	A method of operating an oxygen-permeable mixed conducting membrane having an oxidant feed side, an oxidant feed surface, a permeate side, and a permeate surface. The method consists of controlling the differential strain between the permeate surface and the oxidant feed surface by varying the oxygen partial pressure on either or both sides of the membrane.	Part of an <a href="#">emerging hydrogen production technology</a> project.
7,429,372	09/30/08	Air Products & Chemicals, Inc.	Hydrogen storage by reversible hydrogenation of pi-conjugated substrates	A novel process for the storage and release of hydrogen by means of a substantially reversible catalytic hydrogenation of extended pi-conjugated substrates.	Part of an <a href="#">emerging hydrogen production technology</a> project.
7,425,231	09/16/08	Air Products & Chemicals, Inc.	Feed gas contaminant removal in ion transport membrane systems	A method for purification of a gas stream containing contaminants such as volatile metal oxy-hydroxides, volatile metal oxides, and volatile silicon hydroxide. The method consists of contacting the feed gas stream with a reactive solid material in a guard bed to form a solid reaction product, after which the purified gas stream is withdrawn from the guard bed.	Part of an <a href="#">emerging hydrogen production technology</a> project.
7,419,635	09/02/08	NREL	Pd/V <sub>2</sub> O <sub>5</sub> device for colorimetric H <sub>2</sub> detection	A sensor structure for chemochromic optical detection of hydrogen gas over a wide response range.	Research complete; seeking to license.
7,351,395	04/01/08	Air Products & Chemicals, Inc.	Hydrogen storage by reversible hydrogenation of pi-conjugated substrates	A novel process for the storage and release of hydrogen by means of a substantially reversible catalytic hydrogenation of extended pi-conjugated substrates.	Part of an <a href="#">emerging hydrogen production technology</a> project.
7,344,576	03/18/08	PNNL	Conditions for fluid separations in microchannels, capillary-driven fluid separations, and laminated devices capable of separating fluids	Methods of separating fluids using capillary forces and/or improved conditions. The improved methods may include control of the ratio of gas and liquid Reynolds numbers relative to the Suratman number. Also disclosed are wick-containing, laminated devices that are capable of separating fluids.	Exclusive license to Velocys, Inc.
7,335,247	02/26/08	Air Products & Chemicals, Inc.	Ion transport membrane module and vessel system	An ion transport membrane reactor system which can be used to oxidize a reactant gas feed stream containing hydrocarbons, such as methane, and thereby produce a product gas stream containing hydrogen and carbon oxides.	Part of an <a href="#">emerging hydrogen production technology</a> project.

**Production/Delivery Patents Status**

<b>Patent Number</b>	<b>Award Date</b>	<b>Organization</b>	<b>Title</b>	<b>Description</b>	<b>Status</b>
7,311,755	12/25/07	Air Products & Chemicals, Inc.	Control of differential strain during heating and cooling of mixed conducting metal oxide membranes	A method of operating an oxygen-permeable mixed conducting membrane having an oxidant feed side and a permeate side. The method consists of controlling the differential strain between the oxidant feed side and the permeate side by varying the oxygen partial pressure on either or both sides of the membrane.	Part of an <a href="#">emerging hydrogen production technology</a> project.
7,297,324	11/20/07	PNNL	Microchannel reactors with temperature control	Microchannel devices and methods of use are disclosed wherein a reaction microchamber is in thermal contact with a heat exchange channel. A catalyst can be provided in the microchamber in sheet form such that reactants flow by the catalyst sheet.	Exclusive license to Velocys, Inc.
7,279,027	10/09/07	Air Products & Chemicals, Inc.	Planar ceramic membrane assembly and oxidation reactor system	Planar ceramic membrane assembly comprising a dense layer of mixed-conducting multi-component metal oxide material, wherein the dense layer has a first side and a second side, a porous layer of mixed-conducting multi-component metal oxide material in contact with the first side of the dense layer, and a ceramic channeled support layer in contact with the second side of the dense layer.	Part of an <a href="#">emerging hydrogen production technology</a> project.
7,276,306	10/02/07	LLNL	System for the co-production of electricity and hydrogen	System for the co-generation of hydrogen gas and electricity, wherein the proportion of hydrogen to electricity can be adjusted from 0% to 100%.	No license issued and no research being done with this patent.
7,272,941	09/25/07	PNNL	Methods for fluid separations, and devices capable of separating fluids	A wick-containing apparatus and methods of separating fluids using wicks.	Being used in continuing research at PNNL.
7,270,905	09/18/07	PNNL	Microsystem process networks	Various aspects and applications of microsystem process networks which can be improved by employing ortho-cascading mass, heat, or other unit process operations are described. One such application is the production of hydrogen via steam reformation of hydrocarbons.	Research complete; seeking to license.
7,233,034	06/19/07	NREL	Hydrogen permeable protective coating for a catalytic surface	A protective coating for a surface comprising a layer permeable to hydrogen, said coating being deposited on a catalyst layer wherein the catalytic activity of the catalyst layer is preserved.	Exclusive license to Nuclear Filter Technology. Still working with NREL via CRADA on further development.
7,229,785	06/12/07	NREL	Fluorescence technique for on-line monitoring of state of hydrogen-producing microorganisms	An in situ method for external on-line monitoring of the physiological state of an algal culture inside a closed photobioreactor system to ascertain the culture's production of hydrogen.	Not licensed but still being used in research at NREL.

## Production/Delivery Patents Status

Patent Number	Award Date	Organization	Title	Description	Status
7,179,323	02/20/07	Air Products & Chemicals, Inc.	Ion transport membrane module and vessel system	An ion transport membrane reactor system which can be used to oxidize a reactant gas feed stream containing hydrocarbons, such as methane, and thereby produce a product gas stream containing hydrogen and carbon oxides.	Part of an <a href="#">emerging hydrogen production technology</a> project.
7,176,005	02/13/07	University of California - Berkeley	Modulation of sulfate permease for photosynthetic hydrogen production	Sustained hydrogen production is obtained by the culturing of a genetically-modified algae, where the ability of the chloroplasts to intake sulfate is reduced or eliminated compared with wild-type algae.	Part of an <a href="#">emerging hydrogen production technology</a> project.
7,157,167	01/02/07	U. Central Florida Research Foundation	Thermocatalytic process for CO <sub>2</sub> -free production of hydrogen and carbon from hydrocarbons	A novel process and apparatus for sustainable CO <sub>2</sub> -free production of hydrogen and carbon by thermocatalytic decomposition (dissociation, pyrolysis, cracking) of hydrocarbon fuels over carbon-based catalysts in the absence of air and/or water.	Exclusive license to Contained Energy, Inc. Continued development with the goal of a commercial product in 3-5 years.
7,125,540	10/24/06	PNNL	Microsystem process networks	Various aspects and applications of microsystem process networks which can be improved by employing ortho-cascading mass, heat, or other unit process operations are described. One such application is the production of hydrogen via steam reformation of hydrocarbons.	Exclusive license to Velocys, Inc.
7,122,873	10/17/06	U. of Hawaii	Hybrid solid state/ electrochemical photoelectrode for hydrogen production	A semiconductor device for producing a gas from a material comprising the gas using light as the sole power source.	Part of an <a href="#">emerging hydrogen production technology</a> project.
7,101,530	09/05/06	Air Products & Chemicals, Inc.	Hydrogen storage by reversible hydrogenation of pi-conjugated substrates	A novel process for the storage and release of hydrogen by means of a substantially reversible catalytic hydrogenation of extended pi-conjugated substrates.	Part of an <a href="#">emerging hydrogen production technology</a> project.
7,094,301	08/22/06	Air Products & Chemicals, Inc.	Method of forming a joint	A method of forming a joint at an interface between two sintered bodies comprising multicomponent metallic oxides of specific crystal structure. Typical sintered bodies are an ion transport membrane (an electrolyte), ceramic tubes, and additional supporting equipment such as seals and conduits.	Part of an <a href="#">emerging hydrogen production technology</a> project.
7,067,453	06/27/06	InnovaTek, Inc.	Hydrocarbon fuel reforming catalyst and use thereof	The subject invention is a catalyst consisting of an oxide or mixed oxide support and bimetallic catalytically active compounds.	Part of an <a href="#">emerging hydrogen production technology</a> project.
7,066,973	06/27/06	Nuvera Fuel Cells	Integrated reformer and shift reactor	A hydrocarbon fuel reformer for producing diatomic hydrogen gas.	Being used in the New Millenium Project.



**Production/Delivery Patents Status**

Patent Number	Award Date	Organization	Title	Description	Status
7,059,364	06/13/06	Gas Technology Institute	Control method for high-pressure hydrogen vehicle fueling station dispensers	A method for quick filling a vehicle hydrogen storage vessel with hydrogen, the key component of which is an algorithm used to control the fill process, which interacts with the hydrogen dispensing apparatus to determine the vehicle hydrogen storage vessel capacity.	Being used in <a href="#">commercial product</a> , H2 ProGen, by GreenField Compression.
7,051,540	05/30/06	PNNL	Methods for fluid separations, and devices capable of separating fluids	A wick-containing apparatus and methods of separating fluids using wicks.	Being used in continuing research at PNNL and seeking to license.
7,033,570	04/25/06	NREL/U. of Colorado	Solar-thermal fluid-wall reaction processing	A method for carrying out high temperature thermal dissociation reactions requiring rapid-heating and short residence times using solar energy.	Licensed to Sundrop Fuels, Inc. and still being used in research at the company.
7,011,898	03/14/06	Air Products & Chemicals, Inc.	Method of joining ITM materials using a partially or fully-transient liquid phase	A method of forming a joint at an interface between two sintered bodies comprising multicomponent metallic oxides of specific crystal structure. Typical sintered bodies are an ion transport membrane (an electrolyte), ceramic tubes, and additional supporting equipment such as seals and conduits.	Part of an <a href="#">emerging hydrogen production technology</a> project.
7,011,694	03/14/06	University of Kentucky	CO <sub>2</sub> -selective membranes containing amino groups	A CO <sub>2</sub> selective membrane constructed in the hollow-fiber configuration using air as the sweep gas for use in water gas shift reactors to aid in the production of high purity H <sub>2</sub> .	Still being used in on-going research efforts.
6,989,252	01/24/06	NREL	Hydrogen production using hydrogenase-containing oxygenic photosynthetic organisms	A reversible physiological process provides for the temporal separation of oxygen evolution and hydrogen production in a microorganism.	Part of an <a href="#">emerging hydrogen production technology</a> project.
6,985,082	01/10/06	NexTech Materials, Ltd.	Carbon monoxide sensor and method of use	A sensor and method of use for detection of low levels of carbon monoxide in gas mixtures.	Not being pursued at this time. Put on the shelf.
6,967,063	11/22/05	ANL	Autothermal hydrodesulfurizing reforming method and catalyst	A method for reforming a sulfur-containing carbonaceous fuel in which the sulfur-containing carbonaceous fuel is mixed with H <sub>2</sub> O and an oxidant, forming a fuel/H <sub>2</sub> O/oxidant mixture.	Licensed to a small company that wishes to remain anonymous and being used in research.
6,887,728	05/03/05	U. of Hawaii	Hybrid solid state/ electrochemical photoelectrode for hydrogen production	A semiconductor device for production of a gas from a material comprising the gas using light as the sole power source.	Part of an <a href="#">emerging hydrogen production technology</a> project.

## Production/Delivery Patents Status

Patent Number	Award Date	Organization	Title	Description	Status
6,878,362	04/12/05	General Electric Company	Fuel processor apparatus and method based on autothermal cyclic reforming	In a fuel processor based on autothermal cyclic reforming process, a method of generating hydrogen gas includes receiving a mixture of fuel and steam in the reformer reactor operating in a reforming step to produce hydrogen-rich reformat gas.	Research not continuing in this area and nothing being done with patent.
6,875,247	04/05/05	PNNL	Conditions for fluid separations in microchannels, capillary-driven fluid separations, and laminated devices capable of separating fluids	Methods of separating fluids using capillary forces and/or improved conditions. The improved methods may include control of the ratio of gas and liquid Reynolds numbers relative to the Suratman number. Also disclosed are wick-containing, laminated devices that are capable of separating fluids.	Exclusive license to Velocys, Inc. The patent is not planned for development for hydrogen production but for distillation purposes.
6,872,378	03/29/05	NREL	Solar thermal aerosol flow reaction process	An environmentally beneficial process using concentrated sunlight to heat radiation absorbing particles to carry out highly endothermic gas phase chemical reactions ultimately resulting in the production of hydrogen or hydrogen synthesis gases.	Licensed to Sundrop Fuels, Inc. and still being used in research at the company.
6,869,462	03/22/05	PNNL	Methods of contacting substances and microsystem contactors	The invention provides an apparatus and methods for efficiently capturing and separating fluids from gas/liquid streams. One possible application of the invention is for recycling water used in fuel cells.	Being used in continuing research at PNNL and seeking to license.
6,723,566	04/20/04	NREL	Pd/Ni-WO <sub>3</sub> anodic double layer gasochromic device	An anodic double layer gasochromic sensor structure for optical detection of hydrogen in improved response time and with improved optical absorption real time constants.	Exclusive license to Nuclear Filter Technology. Still working with NREL via CRADA on further development.
6,716,275	04/06/04	SNL	Gas impermeable glaze for sealing a porous ceramic surface	A process for fabricating a gas impermeable seal on a porous ceramic surface using a thin, glass-based, pinhole free glaze.	Not licensed to anyone but still being used in research.
6,713,040	03/30/04	ANL	Method for generating hydrogen for fuel cells	A method of producing a H <sub>2</sub> rich gas stream includes supplying an O <sub>2</sub> rich gas, steam, and fuel to an inner reforming zone of a fuel processor that includes a partial oxidation catalyst and a steam reforming catalyst or a combined partial oxidation and stream reforming catalyst.	Being used in continuing research efforts at ANL.
6,670,058	12/20/03	U. Central Florida	Thermocatalytic process for CO <sub>2</sub> -free production of hydrogen and carbon from hydrocarbons	A novel process for sustainable CO <sub>2</sub> -free production of hydrogen and carbon by thermocatalytic decomposition (or dissociation, pyrolysis, cracking) of hydrocarbon fuels over carbon-based catalysts in the absence of air and/or water.	Exclusive license to Contained Energy, Inc. Continued development with the goal of a commercial product in 3-5 years.



### Production/Delivery Patents Status

Patent Number	Award Date	Organization	Title	Description	Status
6,666,909	12/23/03	PNNL	Microsystem capillary separations	Laminated, multiphase separators and contactors having wicking structures and gas flow channels. Some preferred embodiments are combined with microchannel heat exchange. Integrated systems containing these components are also part of the invention.	Exclusive license to Velocys, Inc. Being developed for distillation uses.
6,641,625	11/04/03	Nuvera Fuel Cells, Inc.	Integrated hydrocarbon reforming system and controls	A hydrocarbon reformer system including a first reactor configured to generate hydrogen-rich reformat.	Being used by Nuvera in research in a demo prototype for truck apus. Five years from commercialization.
6,623,720	09/23/03	University of Michigan	Transition metal carbides, nitrides and borides, and their oxygen containing analogs useful as water gas shift catalysts	Mono- and bimetallic transition metal carbides, nitrides and borides, and their oxygen containing analogs (e.g. oxycarbides) for use as water gas shift catalysts.	No license yet but looking for a commercial partner for future research.
6,572,829	06/03/03	U. Central Florida	Closed cycle photocatalytic process for decomposition of hydrogen sulfide to its constituent elements	System for separating hydrogen and sulfur from hydrogen sulfide (H <sub>2</sub> S) gas produced from oil and gas waste streams.	Not licensed and no research being done at University of Central Florida.
6,551,561	04/22/03	U. Central Florida	Apparatus for decoupled thermo-photocatalytic pollution control	A new method for design and scale-up of photocatalytic and thermocatalytic processes.	Not licensed and no research being done at University of Central Florida.
6,531,035	03/11/03	U. Central Florida	Apparatus and method for low flux photocatalytic pollution control	A new method for design and scale-up of photocatalytic and thermocatalytic processes.	Not licensed and no research being done at University of Central Florida.
6,492,290	12/10/02	Air Products & Chemicals, Inc.	Mixed conducting membranes for syngas production	A new class of multicomponent metallic oxides that are particularly suited in fabricating components used in processes for producing syngas.	Part of an <a href="#">emerging hydrogen production technology</a> project.
6,478,077	11/12/02	SNL	Self supporting heat transfer element	An improved internal heat exchange element arranged so as to traverse the inside diameter of a container vessel such that it makes good mechanical contact with the interior wall of that vessel.	Not licensed and no research being done at SNL.
6,468,480	10/22/02	Nuvera Fuel Cells, Inc.	Apparatus for converting hydrocarbon fuel into hydrogen gas and carbon dioxide	Hydrocarbon fuel reformer suitable for producing synthesis hydrogen gas from reactions with hydrocarbons fuels, oxygen, and steam.	Being used by Nuvera in research in a demo prototype for truck apus. Five years from commercialization.

## Production/Delivery Patents Status

Patent Number	Award Date	Organization	Title	Description	Status
6,448,068	09/10/02	NREL	System for rapid biohydrogen phenotypic screening of microorganisms using a chemochromic sensor	A system for identifying a hydrogen gas producing organism.	Currently in licensing negotiations.
6,395,252	05/28/02	ORNL	Method for the continuous production of hydrogen	A method for the continuous production of hydrogen.	Not licensed and no research being done at ORNL.
6,391,484	05/21/02	General Motors Corporation	Fuel processor temperature monitoring and control	A method and system for maintaining temperature control in a fuel processor (reformer) used to produce hydrogen for a fuel cell.	Being used in continuing research at the company.
6,303,098	10/16/01	ANL	Steam reforming catalyst	A method of forming a hydrogen rich gas from a source of hydrocarbon fuel.	No longer being used in research.
6,302,402	10/16/01	Air Products & Chemicals, Inc.	Compliant high temperature seals for dissimilar materials	A high temperature, gas-tight seal is formed by utilizing one or more compliant metallic toroidal ring sealing elements, where the applied pressure serves to activate the seal, thus improving the quality of the seal. The compliant nature of the sealing element compensates for differences in thermal expansion between the materials to be sealed, and is particularly useful in sealing a metallic member and a ceramic tube at elevated temperatures.	Part of an <a href="#">emerging hydrogen production technology</a> project.
6,277,589	08/21/01	NREL	Method and apparatus for rapid biohydrogen phenotypic screening of microorganisms using a chemochromic sensor	An assay system for identifying a hydrogen-gas-producing organism, including a sensor film having a first layer comprising a transition metal oxide or oxysalt and a second layer comprising hydrogen-dissociative catalyst metal.	Currently in licensing negotiations.
6,254,839	07/03/01	Arthur D. Little, Inc.	Apparatus for converting hydrocarbon fuel into hydrogen gas and carbon dioxide	A hydrocarbon fuel reformer suitable for producing synthesis hydrogen gas from reactions with hydrocarbons fuels, oxygen, and steam.	Being used by Nuvera in research in a demo prototype for truck apus. Five years from commercialization.
6,244,367	06/12/01	ANL	Methanol partial oxidation reformer	A partial oxidation reformer comprising a longitudinally extending chamber having a methanol, water, and an air inlet and an outlet.	No longer being used in research.
6,238,815	05/29/01	GM Corp.	Thermally integrated staged methanol reformer and method	A thermally integrated two-stage methanol reformer including a heat exchanger and first and second reactors colocated in a common housing in which a gaseous heat transfer medium circulates to carry heat from the heat exchanger into the reactors.	No longer being pursued, abandoned.

### Production/Delivery Patents Status

Patent Number	Award Date	Organization	Title	Description	Status
6,207,122	03/27/01	Arthur D. Little, Inc.	Method for converting hydrocarbon fuel into hydrogen gas and carbon dioxide	A hydrocarbon fuel reforming method suitable for producing synthesis hydrogen gas from reactions with hydrocarbons fuels, oxygen, and steam.	Being used by Nuvera in research in a demo prototype for truck apus. Five years from commercialization.
6,162,558	12/19/00	General Motors Corporation	Method and apparatus for selective removal of carbon monoxide	A method and apparatus for reducing the carbon monoxide content of a hydrogen-rich gas.	Being used in continuing research at the company.
6,132,689	10/17/00	General Motors Corporation	Multi-stage, isothermal CO preferential oxidation reactor	A multi-stage, isothermal, carbon monoxide preferential oxidation (PrOx) reactor comprising a plurality of serially arranged, catalyzed heat exchangers, each separated from the next by a mixing chamber for homogenizing the gases exiting one heat exchanger and entering the next.	Being used in continuing research at the company.
6,126,908	10/03/00	Arthur D. Little, Inc.	Method and apparatus for converting hydrocarbon fuel into hydrogen gas and carbon dioxide	An apparatus and a method for converting hydrocarbon fuel or an alcohol into hydrogen gas and carbon dioxide.	Being used by Nuvera in research in a demo prototype for truck apus. Five years from commercialization.
6,123,913	09/26/00	Arthur D. Little, Inc.	Method for converting hydrocarbon fuel into hydrogen gas and carbon dioxide	A method for synthesizing hydrogen gas from hydrocarbon fuel. A first mixture of steam and a first fuel are directed into a first tube to subject the first mixture to a first steam reforming reaction in the presence of a first catalyst.	Being used by Nuvera in research in a demo prototype for truck apus. Five years from commercialization.
6,114,400	09/05/00	Air Products & Chemicals, Inc.	Synthesis gas production by mixed conducting membranes with integrated conversion into liquid products	Natural gas or other methane-containing feed gas is converted to a C <sub>5</sub> -C <sub>19</sub> hydrocarbon liquid in an integrated system comprising an oxygenative synthesis gas generator, a non-oxygenative synthesis gas generator, and a hydrocarbon synthesis process such as the Fischer-Tropsch process. The oxygenative synthesis gas generator is a mixed conducting membrane reactor system.	Part of an <a href="#">emerging hydrogen production technology</a> project.
6,083,425	07/04/00	Arthur D. Little, Inc.	Method for converting hydrocarbon fuel into hydrogen gas and carbon dioxide	A method for converting hydrocarbon fuel into hydrogen gas and carbon dioxide within a reformer.	Being used by Nuvera in research in a demo prototype for truck apus. Five years from commercialization.
6,051,125	04/18/00	LLNL	Natural gas-assisted steam electrolyzer	An efficient method of producing hydrogen by high temperature steam electrolysis that will lower the electricity consumption to an estimated 65 percent lower than has been achievable with previous steam electrolyzer systems.	One commercial license was issued but is terminated.

## Production/Delivery Patents Status

Patent Number	Award Date	Organization	Title	Description	Status
5,942,346	08/24/99	ANL	Methanol partial oxidation reformer	A partial oxidation reformer comprising a longitudinally extending chamber having a methanol, water, and an air inlet and an outlet.	No longer being used in research.
5,939,025	08/17/99	ANL	Methanol partial oxidation reformer	A partial oxidation reformer comprising a longitudinally extending chamber having a methanol, water and an air inlet and an outlet.	No longer being used in research.
5,895,518	04/20/99	SNL	Synthesis of alloys with controlled phase structure	A method for preparing controlled phase alloys useful for engineering and hydrogen storage applications.	Not licensed and no research being done at SNL.
5,886,614	03/23/99	General Motors Corporation	Thin film hydrogen sensor	A thin film hydrogen sensor consisting of a flat ceramic substrate, a thin film temperature-responsive resistor, and a thin film hydrogen-responsive metal resistor.	Being used in continuing research at the company.
5,821,111	10/13/98	Bioengineering Resources, Inc.	Bioconversion of waste biomass to useful products	A process for converting waste biomass to useful products by gasifying the biomass to produce synthesis gas and converting the synthesis gas substrate to one or more useful products.	No longer being pursued for hydrogen production
5,637,415	06/10/97	General Motors Corporation	Controlled CO preferential oxidation	A method for controlling the supply of air to a preferential oxidation reactor in which the CO content of a hydrogen-rich gas stream is reduced.	Being used in continuing research at the company.
5,271,916	12/21/93	General Motors Corporation	Device for staged carbon monoxide oxidation	A method and apparatus for selectively oxidizing carbon monoxide in a hydrogen-rich feed stream.	Being used in continuing research at the company.
4,473,622	09/25/84	United Technologies Corporation	Rapid starting methanol reactor system	A methanol-to-hydrogen cracking reactor for use with a fuel cell vehicular power plant.	Patent has expired and is not being used at UTC.
4,358,429	11/09/82	ANL	Oxygen stabilized zirconium vanadium intermetallic compound	A new oxygen stabilized intermetallic compound that can repeatedly sorbing hydrogen from a mixture of gases.	No licensee and no further development of this technology at ANL.
4,142,300	03/06/79	ANL	Lanthanum nickel aluminum alloy	A ternary intermetallic compound capable of reversible sorption of hydrogen having the chemical formula $LaNi_{5-x}Al_x$ , where x is in the range of about 0.01 to 1.5 and the method of storing hydrogen using the intermetallic compound.	No licensee and no further development of this technology at ANL.



## Storage Patents Status

Patent Number	Award Date	Organization	Title	Description	Status
7,927,507	04/19/11	HRL Laboratories, LLC	Hydrogen storage compositions	Materials for reversible hydrogen storage that employ an alloy exhibiting reversible formation/deformation of $\text{BH}_4^-$ anions. The materials are prepared by combining a metal hydride with a ternary alloy consisting of magnesium, boron and another metal.	Being used in continuing research at the company.
7,897,129	03/01/11	PNNL	Process for synthesis of ammonia borane for bulk hydrogen storage	The invention describes new methods for synthesizing ammonia borane, which shows promise as a chemical hydrogen storage material for fuel-cell-powered applications.	Being used in continuing research at PNNL and seeking to license.
7,846,410	12/07/10	LANL	Regeneration of polyborazylene	The invention provides methods for regenerating ammonia borane, a hydrogen storage material, from polyborazylene.	Being used in continuing research at LANL.
7,837,852	11/23/10	LANL	Energy efficient synthesis of boranes	An energy-efficient method for synthesizing boranes that are used for storing hydrogen. The boranes are prepared at close to ambient temperature without the need for thermal quenching and rapid separation, and without the energy cost of generating active metal hydrides.	Being used in continuing research at LANL.
7,790,133	09/07/10	UOP, LLC	Multi-component hydrogen storage material	A reversible hydrogen storage material that shows improved performance at low temperatures compared with binary systems such as $\text{MgH}_2\text{-LiNH}_2$ .	Research complete; seeking to license.
7,790,013	09/07/10	Safe Hydrogen, LLC	Storing and transporting energy	A method for safely storing and transporting energy in the form of hydrogen. Hydrogen is released from water by a process such as electrolysis. The released hydrogen is then stored and transported in a metal hydride slurry, which can be mixed with water to release the hydrogen at an end-use location.	Part of an <a href="#">emerging hydrogen storage technology</a> project.
7,781,109	08/24/10	SNL	Hydrogen storage and integrated fuel cell assembly	A system in which housings for hydrogen storage materials are located in close proximity to a fuel cell stack. Heat generated from operation of the fuel cell stack is used to help drive the endothermic dehydrogenation reactions for releasing hydrogen from the storage materials.	Being used in continuing research at SNL.
7,754,641	07/13/10	General Electric Company	Hydrogen storage material and related processes	A hydrogen storage material consisting of a complex hydride and a borohydride catalyst. The catalyst improves the hydrogenation/dehydrogenation kinetics of the complex hydride.	No longer being used.

### Storage Patents Status

Patent Number	Award Date	Organization	Title	Description	Status
7,736,531	06/15/10	LANL	Composition and method for storing and releasing hydrogen	A chemical hydrogen storage system that couples an endothermic reaction (which releases hydrogen) to an exothermic reaction to achieve overall thermodynamic neutrality.	Being used in continuing research at LANL.
7,713,506	05/11/10	LANL	Metal aminoboranes	Metal aminoboranes of the formula $M(NH_2BH_3)_n$ have been synthesized. The aminoboranes can be dehydrogenated to form hydrogen and a reaction product. The reaction product can react with hydrogen to form a hydrogen storage material.	Being used in continuing research at LANL.
7,645,902	01/12/10	LANL	Acid-catalyzed dehydrogenation of amine-boranes	A method of dehydrogenating an amine-borane using an acid-catalyzed reaction. The method may be used to generate hydrogen for portable power sources such as fuel cells.	Being used in continuing research at LANL.
7,608,233	10/27/09	SNL	Direct synthesis of calcium borohydride	A method for directly preparing an alkaline earth metal borohydride, i.e. $Ca(BH_4)_2$ , from the alkaline earth metal hydride and the alkaline earth metal boride. The calcium borohydride product can be used to reversibly store and release hydrogen.	Being used in continuing research at SNL.
7,544,837	06/09/09	LANL	Base metal dehydrogenation of amine-boranes	A method of dehydrogenating an amine-borane using a base metal catalyst. The method may be used to generate hydrogen for portable power sources such as fuel cells.	Being used in continuing research at LANL.
7,521,037	04/21/09	BNL	Regeneration of aluminum hydride	The invention provides methods and materials for the formation of hydrogen storage alanes, $AlH_x$ , where x is greater than 0 and less than or equal to 6 at reduced $H_2$ pressures and temperatures.	Being used in continuing research at BNL and seeking to license.
7,402,234	07/22/08	INL	Polymeric hydrogen diffusion barrier, high-pressure storage tank so equipped, method of fabricating a storage tank and method of preventing hydrogen diffusion	An electrochemically active hydrogen diffusion barrier which comprises an anode layer, a cathode layer, and an intermediate electrolyte layer, which is conductive to protons and substantially impermeable to hydrogen.	No licenses issued and no internal research being done with this patent.

## Storage Patents Status

Patent Number	Award Date	Organization	Title	Description	Status
7,384,574	06/10/08	SRL	Hydrogen storage material and process using graphite additive with metal-doped complex hydrides	A hydrogen storage material having improved hydrogen absorption and desorption kinetics is provided by adding graphite to a complex hydride such as a metal-doped alanate. The incorporation of graphite into the complex hydride significantly enhances the rate of hydrogen absorption and desorption and lowers the desorption temperature needed to release stored hydrogen.	Research complete; seeking to license.
7,306,780	12/11/07	SNL	Method of generating hydrogen gas from sodium borohydride	Contacts water with micro-disperse particles of sodium borohydride in the presence of a metal catalyst, thus generating hydrogen gas.	Licensed to Nanodetex but license was terminated.
7,191,602	03/20/07	LLNL	Storage of H <sub>2</sub> by absorption and/or mixture within a fluid medium	Provides a container comprising a fixed volume remaining constant to within about 5% due to changes in pressure and temperature with a fluid mixture comprised of a high density of hydrogen molecules. Container will increase the density of the fluid mixture so the mixture can be withdrawn from the container and used as fuel.	Part of an <a href="#">emerging hydrogen storage technology</a> project.
7,160,530	01/09/07	NREL	Metal-doped single-walled carbon nanotubes and production thereof	A method for the production of single-walled carbon nanotubes that can be used for reversibly storing hydrogen at ambient conditions with low energy input requirements.	Being used in research at NREL but no licensees.
7,094,387	08/22/06	SRL	Complex hydrides for hydrogen storage	Melt a mixture of sodium aluminum hydride mixed with titanium under a combination of heat and pressure to provide a fused hydrogen storage material.	Being used in research at SRL but no licensees.
7,052,671	05/30/06	Safe Hydrogen, LLC	Storage, generation, and use of hydrogen	Operation of a hydrogen generator with a composition of a carrier liquid, a dispersant, and chemical hydride. A regenerator recovers elemental metal from byproducts of the hydrogen generation process.	Part of an <a href="#">emerging hydrogen storage technology</a> project.
6,918,382	07/19/05	Energy Conversion Devices, Inc.	Hydrogen powered scooter	A scooter powered by a hydrogen fueled internal combustion engine utilizes an on-board metal-hydride hydrogen storage unit and the storage unit may be heated with an exhaust stream from the engine to help liberate the embedded hydrogen.	No licenses issued and no internal research being done with this patent.
6,793,909	09/21/04	SNL	Direct synthesis of catalyzed hydride compounds	Method of producing complex hydride compounds comprising mechanically milling powders of a simple alkali metal hydride material with a metal and a titanium catalyst compound followed by high pressure hydrogenation.	Being used in research at SNL but no licensees.



### Storage Patents Status

Patent Number	Award Date	Organization	Title	Description	Status
6,787,007	09/07/04	INL	Polymeric hydrogen diffusion barrier, high-pressure storage tank so equipped, method of fabricating a storage tank and method of preventing hydrogen diffusion	Electrochemically active hydrogen diffusion barrier made of an anode layer and a cathode layer, each including a polymer material conductive to protons and substantially impermeable to hydrogen. There will also be a voltage source operably coupled to the anode layer and the cathode layer and a catalytic material proximate an interface between at least one of the anode layer and the electrolyte layer and the cathode layer and the electrolyte layer.	Not licensed and no research being done at INL with this patent.
6,746,496	06/08/04	SNL	Compact solid source of hydrogen gas	A compact solid source of hydrogen gas, where the gas is generated by contacting water with micro-disperse particles of sodium borohydride in the presence of a catalyst, such as cobalt or ruthenium.	Licensed to Nanodetex but license was terminated.
6,708,502	03/23/04	LLNL	Lightweight cryogenic-compatible pressure vessels for vehicular fuel storage	A lightweight, cryogenic-compatible pressure vessel for flexibly storing cryogenic liquid fuels or compressed gas fuels at cryogenic or ambient temperatures.	Part of an <a href="#">emerging hydrogen storage technology</a> project.
6,616,891	09/09/03	Energy Conversion Devices, Inc.	High capacity transition metal based hydrogen storage materials for the reversible storage of hydrogen	A reversible transition metal-based (including titanium, vanadium, chromium, and manganese) hydrogen storage material is capable of storing up to 4 wt.% hydrogen and reversible delivering up to 2.8 wt.% hydrogen at temperatures up to 150°C.	Being used in research at Energy Conversion Devices.
6,593,017	09/09/03	Energy Conversion Devices, Inc.	High capacity calcium lithium based hydrogen storage material and method of making the same	Nonreversible metal hydrides can be used to store and release hydrogen. A nano-crystalline, calcium lithium based hydride is capable of storing up to 5% hydrogen by weight and can be easily ground to a fine powder to facilitate hydrogen transportation and storage.	No licenses issued and no internal research being done with this patent.
6,471,935	10/29/02	U. of Hawaii	Hydrogen storage materials and method of making by dry homogenation	A method of making such reversible hydrogen storage materials by dry doping is also provided and comprises the steps of dry homogenizing metal hydrides by mechanical mixing, such as be crushing or ball milling a powder, of a metal aluminum hydride with a transition metal catalyst.	Part of a research project for hydrogen storage technology.
6,418,962	07/16/02	John Hopkins University	Low cost compressed gas fuel storage system	A compressed gas vehicle fuel storage system comprised of a plurality of compressed gas pressure cells supported by shock-absorbing bumpers positioned within a low cost, shape-conforming container.	No longer being used.

## Storage Patents Status

Patent Number	Award Date	Organization	Title	Description	Status
6,321,775	11/27/01	Johns Hopkins University	Compressed gas manifold	A compressed gas storage cell interconnecting manifold including a thermally activated pressure relief device, a manual safety shut-off valve, and a port for connecting the compressed gas storage cells to a motor vehicle power source and to a refueling adapter.	No longer being used.
6,262,328	07/17/01	SRL	Container and method for absorbing and reducing hydrogen concentration	A method for absorbing hydrogen from an enclosed environment.	Being used in research at SRL but no licensees.
6,257,360	07/10/01	Johns Hopkins University	Compressed gas fuel storage system	A compressed gas vehicle fuel storage system comprised of a plurality of compressed gas pressure cells supported by shock-absorbing foam positioned within a shape-conforming container.	No longer being used.
6,017,600	01/25/00	LLNL	Method for forming a bladder for fluid storage vessels	Lightweight, low permeability liner for graphite epoxy composite compressed gas storage vessels. The liner is composed of polymers that may or may not be coated with a thin layer of a low permeability material, such as silver, gold, or aluminum, deposited on a thin polymeric layer or substrate, which is formed into a closed bladder using torispherical or near torispherical end caps.	No licenses issued and no internal research being done with this patent.
5,965,482	10/12/99	SRL	Composition for absorbing hydrogen from gas mixtures	A hydrogen storage composition that defines a physical sol-gel matrix having an average pore size of less than 3.5 angstroms, which effectively excludes gaseous metal hydride poisons while permitting hydrogen gas to enter.	Being used in research at SRL but no licensees.
5,798,156	08/25/98	LLNL	Lightweight bladder lined pressure vessels	A lightweight, low permeability liner for graphite epoxy composite compressed gas storage vessels. The liner may be used in most types of gas storage system and is particularly applicable for hydrogen, gas mixtures, and oxygen used for vehicles, fuel cells or regenerative fuel cell applications, high altitude solar powered aircraft, hybrid energy storage/propulsion systems, lunar/Mars space applications, and other applications requiring high cycle life.	No licenses issued and no internal research being done with this patent.

**Storage Patents Status**

<b>Patent Number</b>	<b>Award Date</b>	<b>Organization</b>	<b>Title</b>	<b>Description</b>	<b>Status</b>
5,411,928	05/02/95	SRL	Composition for absorbing hydrogen	The composition comprises a porous glass matrix, made by a sol-gel process, having a hydrogen-absorbing material dispersed throughout the matrix. The glass matrix has pores large enough to allow gases having hydrogen to pass through the matrix, yet small enough to hold the particles dispersed within the matrix so that the hydrogen-absorbing particles are not released during repeated hydrogen absorption/desorption cycles.	Being used in research at SRL but no licensees.
5,296,438	03/22/94	SRL	Dimensionally stable metallic hydride composition	The invention relates to a metallic hydride composition that can undergo repeated hydrogen absorption/desorption cycles without disintegrating, and a process for making such a composition.	Research complete; seeking to license.



# Appendix D:

## Commercially Available Technology Descriptions

<b>D.1 Fuel Cell Technologies</b>	D-3
◆ <a href="#">Advanced Cathode Catalysts and Supports for PEM Fuel Cells</a>	D-4
◆ <a href="#">Breakthrough Lifetime Improvements for PEM Fuel Cells</a>	D-6
◆ <a href="#">Complex Coolant for Polymer Electrolyte Membrane (PEM) Fuel Cells</a>	D-8
◆ <a href="#">Conductive Compound for Molding Fuel Cell Bipolar Plates</a>	D-10
◆ <a href="#">Corrosion Test Cell for PEM Bipolar Plate Materials</a>	D-12
◆ <a href="#">Cost-Effective, High-Efficiency, Advanced Reforming Module (CHARM)</a>	D-14
◆ <a href="#">GCtool: Fuel Cell Systems Analysis Software Model</a>	D-16
◆ <a href="#">GenDrive™ Fuel Cell Power System</a>	D-18
◆ <a href="#">Improved Catalyst Coated Membrane (CCM) Manufacturing</a>	D-20
◆ <a href="#">Improved Fuel Cell Cathode Catalysts Using Combinatorial Methods</a>	D-22
◆ <a href="#">Integrated Manufacturing for Advanced Membrane Electrode Assemblies</a>	D-24
◆ <a href="#">Manufacture of Durable Seals for PEM Fuel Cells</a>	D-26
◆ <a href="#">Membranes and Membrane Electrode Assemblies for Dry, Hot Operating Conditions</a>	D-28
◆ <a href="#">Novel Manufacturing Process for PEM Fuel Cell Stacks</a>	D-30
◆ <a href="#">Portable Reformed Methanol Fuel Cells</a>	D-32
◆ <a href="#">PureMotion® Model 120 Fuel Cell Power Plant</a>	D-34
◆ <a href="#">Scale-Up of Carbon-Carbon Composite Bipolar Plates</a>	D-36
<b>D.2 Production/Delivery Technologies</b>	D-39
◆ <a href="#">FuelGen® Hydrogen Fueling Systems</a>	D-40
◆ <a href="#">H2 ProGen: A Total Supply Solution for Hydrogen Vehicles</a>	D-42
◆ <a href="#">High-Efficiency, High-Pressure Electrolysis via Photovoltaic Arrays</a>	D-44
◆ <a href="#">Hydrogen Distributed Production System</a>	D-46
◆ <a href="#">Hydrogen Generation from Electrolysis</a>	D-48
◆ <a href="#">Hydrogen Safety Sensor for Advanced Energy Applications</a>	D-50
◆ <a href="#">ME100 Methanol Reforming Hydrogen Generator</a>	D-52
◆ <a href="#">Membrane Structures for Hydrogen Separation</a>	D-54
◆ <a href="#">Nanoscale Water Gas Shift Catalysts</a>	D-56
◆ <a href="#">PEM Electrolyzer Incorporating an Advanced Low-Cost Membrane</a>	D-58
<b>D.3 Storage Technologies</b>	D-61
◆ <a href="#">Hydrogen Composite Tanks</a>	D-62
◆ <a href="#">Non-Destructive Ultrasonic Scanning Technology</a>	D-64



<b>D.1 Fuel Cell Technologies</b> .....	D-3
◆ <a href="#">Advanced Cathode Catalysts and Supports for PEM Fuel Cells</a> .....	D-4
◆ <a href="#">Breakthrough Lifetime Improvements for PEM Fuel Cells</a> .....	D-6
◆ <a href="#">Complex Coolant for Polymer Electrolyte Membrane (PEM) Fuel Cells</a> .....	D-8
◆ <a href="#">Conductive Compound for Molding Fuel Cell Bipolar Plates</a> .....	D-10
◆ <a href="#">Corrosion Test Cell for PEM Bipolar Plate Materials</a> .....	D-12
◆ <a href="#">Cost-Effective, High-Efficiency, Advanced Reforming Module (CHARM)</a> .....	D-14
◆ <a href="#">GCTool: Fuel Cell Systems Analysis Software Model</a> .....	D-16
◆ <a href="#">GenDrive™ Fuel Cell Power System</a> .....	D-18
◆ <a href="#">Improved Catalyst Coated Membrane (CCM) Manufacturing</a> .....	D-20
◆ <a href="#">Improved Fuel Cell Cathode Catalysts Using Combinatorial Methods</a> .....	D-22
◆ <a href="#">Integrated Manufacturing for Advanced Membrane Electrode Assemblies</a> .....	D-24
◆ <a href="#">Manufacture of Durable Seals for PEM Fuel Cells</a> .....	D-26
◆ <a href="#">Membranes and Membrane Electrode Assemblies for Dry, Hot Operating Conditions</a> .....	D-28
◆ <a href="#">Novel Manufacturing Process for PEM Fuel Cell Stacks</a> .....	D-30
◆ <a href="#">Portable Reformed Methanol Fuel Cells</a> .....	D-32
◆ <a href="#">PureMotion® Model 120 Fuel Cell Power Plant</a> .....	D-34
◆ <a href="#">Scale-Up of Carbon-Carbon Composite Bipolar Plates</a> .....	D-36

# Advanced Cathode Catalysts and Supports for PEM Fuel Cells

Commercial Technology

## Innovative Catalyst Electrodes and Membranes Result in Increased Durability and Superior Performance

3M Company, with grant assistance from the U.S. Department of Energy's Fuel Cell Technologies (FCT) Program, has developed a new membrane electrode assembly (MEA) that demonstrates enhanced performance and significantly improved durability for fuel cell applications. The MEAs use the carbon-free 3M nanostructured thin film (NSTF) catalyst electrodes and 3M ion exchange membrane to achieve longer lifetimes with less precious metal than current state-of-the-art constructions. 3M uses high-volume-capable pilot line equipment to manufacture the catalyst coated membranes as roll-goods for improved quality and lower costs.

For polymer electrolyte membrane fuel cells to be commercially viable for automotive and distributed stationary applications, several issues must be addressed, including performance, durability, and cost. 3M addressed these issues by developing MEAs that meet demanding system operating conditions of higher temperature and low humidification, use less precious metal than current state-of-the-art constructions, have improved stability and durability, and are made by processes amenable to high-volume manufacturing.

The 3M NSTF catalyst support and deposition system eliminates the durability issues associated with carbon corrosion and platinum (Pt) dissolution of conventional dispersed Pt supported on carbon blacks. The NSTF ternary alloy catalysts exhibit a ten-fold gain in catalyst specific activity. Combined with the new 3M low equivalent weight membranes, the new MEAs demonstrate over a ten-fold gain in lifetime under numerous accelerated and load-cycling tests. Improved performance and stability of the MEAs results in higher current and power density with reduced catalyst loading. 3M is currently selling these advanced MEAs to select fuel cell developers.

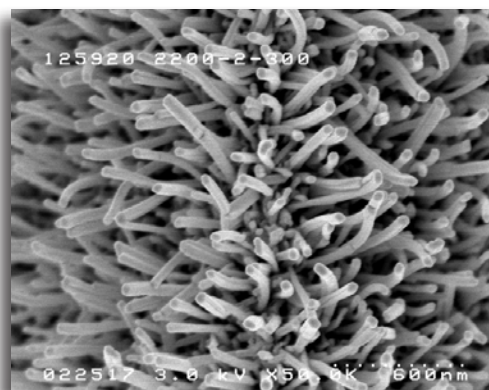
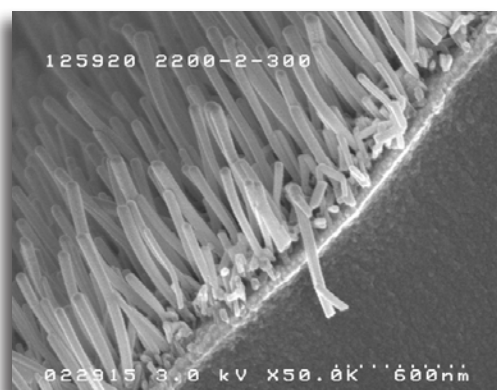

*Scanning Electron Micrographs of the New NSTF Catalysts*



## Technology History

- ◆ Developed by 3M Company over a 10-year period.
- ◆ Became commercially available in 2007.

## Applications

Can be used in demanding hydrogen-fueled fuel cell systems where dynamic, hot, highly oxidative or off-nominal operating conditions require high resistance to catalyst corrosion and membrane degradation.

## Capabilities

- ◆ Uses established high-volume compatible roll-good processes for fabricating components.
- ◆ Demonstrates over a ten-fold gain in lifetime under many accelerated and load-cycling tests.
- ◆ Results in higher current and power density with reduced catalyst loading.

## Benefits

### Cost Savings

Uses less precious metal, lower-cost manufacturing, and smaller fuel cell stack size due to improved performance at the lower catalyst loading levels.

### Durability

Increases the operating life of fuel cells and offers more tolerance of off-nominal operating conditions and events.

### Performance

Higher current density performance at lower catalyst loadings due to much reduced electrode thickness.

**Contact Information:**

**Mark K. Debe**

*Email:* [mkdebel@mmm.com](mailto:mkdebel@mmm.com)

*Phone:* (651) 736-9563

**3M Company**

3M Center, Building 0201-01-N-19

St. Paul, MN 55144-1000

**Website:** <http://www.3m.com>

# Breakthrough Lifetime Improvements for PEM Fuel Cells

Commercial Technology

## New Membranes and Resins Increase Lifetime of Fuel Cell Assemblies, Reducing Replacement Costs

Durability of polymer electrolyte membranes (PEMs) has been a major technical barrier for stationary and transportation applications of PEM fuel cells. The PEM used in fuel cells is made from polymers. Long-term operation of fuel cells causes chemical degradation of this polymer membrane material due to the formation of peroxides that attack the membrane's structure. This chemical degradation weakens the polymer in the membrane and reduces its ability to handle mechanical stress. Typically, mechanical stress is induced because of the cyclic operation of fuel cells, and this stress, coupled with the chemically-induced structural degradation, causes early failure of the membrane.

To solve this problem, DuPont Fuel Cells, with funding from the U.S. Department of Energy's Fuel Cell Technologies (FCT) Program, studied the degradation behavior of perfluorinated polymers. Their research resulted in the development of technologies to reduce the reactive centers within the polymer. The reactive centers are reduced by using proprietary, advanced stabilization technology. This stabilization technology combats the chemical degradation problem and increases the lifetime of fuel cell polymer membrane electrode assemblies, thereby reducing early failure replacement costs.

The stabilization technology approach resulted in a chemically stable Nafion® polymer technology that is eight times more stable than before. The modified materials have survived 4,900 hours in a demanding fuel cell accelerated test, which included load and relative humidity cycles. These new materials can be used for both PEM fuel cells and water electrolyzers. The commercially available DuPont Nafion resin, dispersions, membranes, and membrane electrode assemblies all incorporate this improved, chemically stabilized polymer.



*DuPont Nafion Resins, Dispersions, Membranes, and Membrane Electrode Assemblies*

## Technology History

- ◆ Initially researched by DuPont Fuel Cells in 2003.
- ◆ Marketed the first chemically stable Nafion products (resins, dispersions, membranes, and membrane electrode assemblies) by DuPont Fuel Cells in 2005.
- ◆ Currently marketing the mechanically reinforced Nafion XL membrane.

## Applications

Can be used in both fuel cells and water electrolyzers using PEMs.

## Capabilities

- ◆ Demonstrates 50% reduction in swell compared with an earlier DuPont Nafion NRE211 membrane.
- ◆ Achieves significantly improved lifetime in fuel cell applications.

## Benefits

### Cost Savings

Reduces replacement costs because of increased membrane durability.

### Durability

Significantly improves membrane lifetime in accelerated lifetime testing for simulating an automotive drive-cycle.

**Contact Information:****Andy Kannurpatti***Email:* [anandkumar.kannurpatti@usa.dupont.com](mailto:anandkumar.kannurpatti@usa.dupont.com)*Phone:* (302) 999-6119**DuPont Fuel Cells**

Chestnut Run Plaza 701

Wilmington, DE 19880-0701

**Website:** <http://www.dupont.com>

# Complex Coolant for Polymer Electrolyte Membrane (PEM) Fuel Cells

Commercial Technology

## Advanced Coolant Reduces Weight, Size, and Operating Costs of Fuel Cells

Fuel cell developers currently using water and water/glycol blends depend on the de-ionizing filter in the coolant loop to maintain acceptably low levels of electrical conductivity. However, the filter needs to be frequently replaced, increasing downtime and operating costs of the fuel cell system. An additional concern is the eventual transition to aluminum heat exchangers. Although aluminum is lighter weight, has a lower purchase cost, and exhibits better heat transfer capabilities, the de-ionizing filters used today will not be able to manage the excess of aluminum ions in the coolant if the fluid itself is not designed to substantially buffer the ion build-up.

Dynalene, Inc., with support from private industry and FCT, has developed an advanced complex coolant fluid (CCF), Dynalene FC, that addresses these issues. Consisting of a base compound (glycol and water mixture), the CCF incorporates a non-ionic corrosion inhibitor with ion-suppressing nanoparticles, enabling the coolant to maintain low electrical conductivity while protecting fuel cell metallurgy and reactor channels. Modeling and simulation have been completed for fluid performance for short-term and long-term durations and have culminated with field testing in several fuel cell systems that have operated continuously for more than seven months.

Compared with non-inhibited coolant mixtures and de-ionized water, the Dynalene FC mixture demonstrates at least a 10-fold improvement in the rate of change of electrical conductivity. More than 5,000 hours of operation in real working PEM fuel cells show that the conductivity of the cooling solution exceeds the design target established by PEM fuel cell manufacturers by remaining at less than 10  $\mu\text{S}/\text{cm}$ . Through optimization, Dynalene intends to further reduce the rate of change of electrical conductivity by at least one order of magnitude, enabling fuel cell stacks to operate 2 to 3 years without replacing the coolant.

In comparison with de-ionized water and glycol systems, the Dynalene FC demonstrates much better compatibility with common materials used in the fuel cell cooling loop. In a recent study by the Dynalene group, brass, aluminum, copper, and stainless steel showed virtually no corrosion in the Dynalene FC fluid, whereas they showed severe corrosion in de-ionized water, propylene glycol/water, and ethylene glycol/water after 700 hours at 80°C.

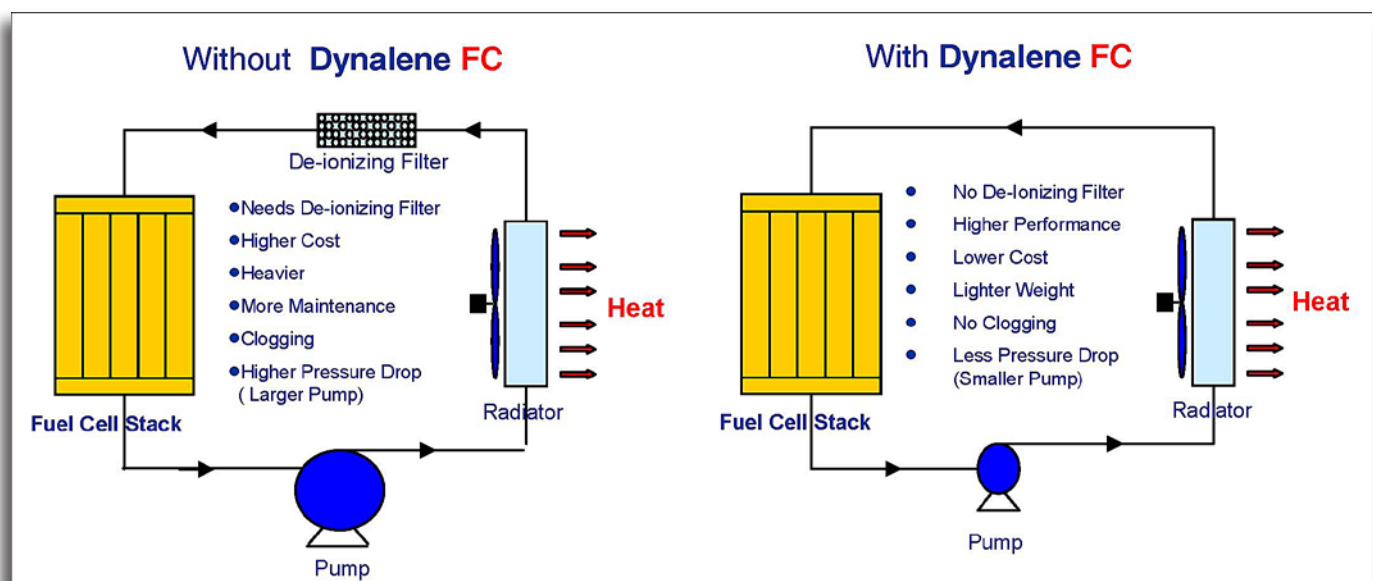

Comparison of Basic De-Ionized Water/Glycol System with Dynalene FC System

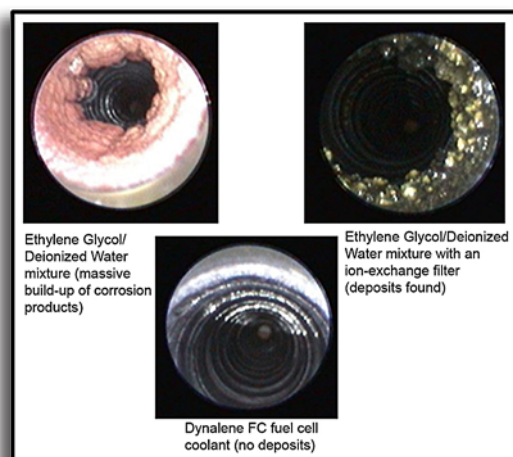

*Fuel Cell Coolant Channels With and Without Dynalene FC*

## Technology History

- ◆ Developed by Dynalene, Inc., with FCT and private industry support; working on production issues centered on manufacturing the nanoparticle used in the coolant.
- ◆ U.S., European, and Canadian patents granted to Dynalene for this coolant; continuing long-term field tests in fuel cells to corroborate lab results.

## Applications

Can be used in fuel cells that have stainless steel, aluminum, copper, and brass heat exchangers and piping that require very low electrical conductivity over extended run times.

## Capabilities

- ◆ Maintains acceptably low corrosion rates on stainless steel and aluminum heat exchangers as well as yellow metals such as copper and brass.
- ◆ Demonstrates much lower rate of increase in electrical conductivity during continuous operation and a lower viscosity, which increases pumping efficiency.
- ◆ Works to stabilize particles, which can lead to flocculation and deposition on flow channels.

## Benefits

### Cost Savings

Eliminates the need for de-ionizing filters in fuel cells, reducing the overall cost of ownership and maintenance.

### Productivity

Enables fuel cells to stay on-line without frequent changing of the de-ionizing filter.

**Contact Information:**  
**Dr. Satish Mohapatra**  
 Email: [satishm@dynalene.com](mailto:satishm@dynalene.com)  
 Phone: (610) 262-9686 x102  
**Dynalene, Inc.**  
 5250 West Coplay Rd.  
 Whitehall, PA 18052  
 Website: <http://www.dynalene.com>

# Conductive Compound for Molding Fuel Cell Bipolar Plates

Commercial Technology

## New Compound Produces Thinner Fuel Cell Stacks and Enhanced Conductivity to Substantially Reduce Costs

Polymer electrolyte membrane (PEM) bipolar plates traditionally have been made from conductive thermoplastics or coated stainless steel. Flow and cooling channels are initially machined to make prototype PEM plates. Both technologies are high in cost compared with graphite-filled conductive thermoset molding compounds.

Graphite-filled conductive thermoset molding compounds can also be machined from molded slabs to produce initial prototype plate parts. Once flow and cooling channel designs are finalized, tools are built for the direct compression molding of finished plates. Anode and cathode plate designs are then bonded together along the cooling channel side of each plate to form a bipolar plate assembly, which can then be used to build a PEM fuel cell stack.

Bulk Molding Compounds, Inc. (BMCI), developed and commercialized a graphitized thermoset vinyl-ester compound for molding bipolar plates with assistance from technology licensed from Los Alamos National Laboratory (LANL). This LANL patented technology was developed using funding from the U.S. Department of Energy's Fuel Cell Technologies (FCT) Program. Initial formulations developed in 1998 and 1999 yielded some commercialization by BMCI in 2000.

BMC 955, the latest addition to BMCI's fuel cell related product line, provides good durability in the corrosive, high temperature environment of high temperature PEM applications. Based upon a phenolic resin system, it looks and processes much like BMCI's low temperature line of fuel cell products.

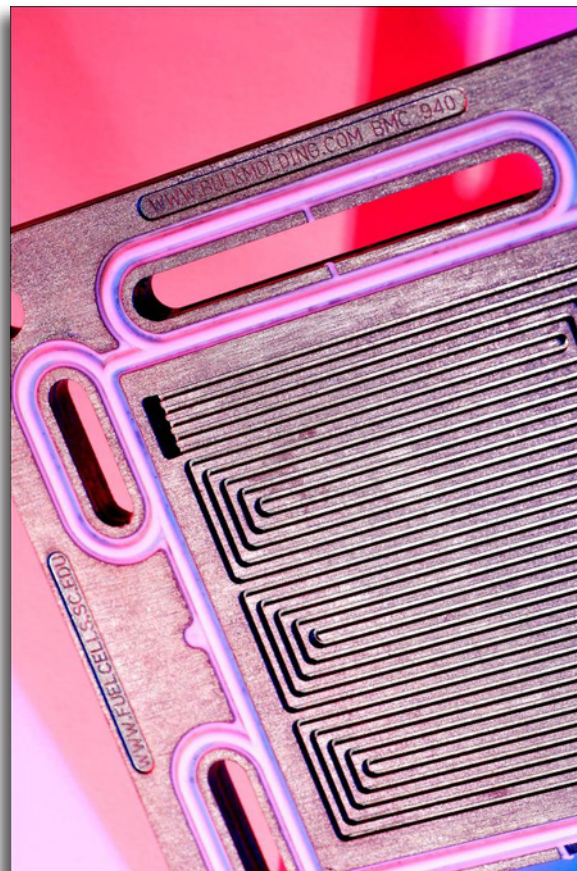

*Bulk Molding Compounds, Inc. (BMCI), has developed and commercialized a graphitized thermoset vinyl-ester compound for molding bipolar plates.*



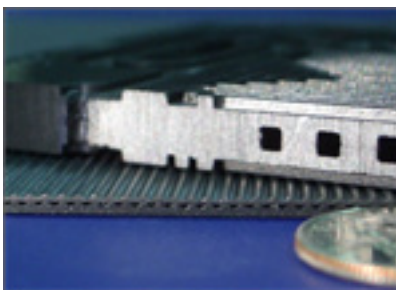

*Evolution of Plate Thickness in Bonded Bipolar Assemblies*

## Technology History

- ◆ Developed and being marketed by BMCI using patented LANL technology. Adopted by several producers for stationary and transportation applications.
- ◆ Became commercially available in 2000.

## Applications

Can be used where bipolar plate assemblies are needed for PEM cells in stationary, automotive, and portable power. A phenolic resin version with similar appearance and moldability is now available for high temperature PEM applications.

## Capabilities

- ◆ Provides enhanced through- and in-plane conductivity with good chemical and corrosion resistance to survive the fuel cell environment.
- ◆ Uses a conductive vinyl-ester adhesive to minimize contact resistance and enhance conductivity in making bipolar plate assemblies.

## Benefits

### Cost Savings

Allows the thickness of bipolar plate assemblies to be reduced from 7 mm to less than 2 mm, which reduces material costs and provides chemical resistance in a PEM fuel cell environment, avoiding the need for expensive corrosion resistant coatings.

### Product Quality

Offers exceptional part flatness, creep resistance, and overall dimensional stability by using proven thermoset technology.

### Productivity

Allows for large-volume commercial production because flow and cooling channels are directly molded into the part. Reduces process cycle times while maintaining critical properties.

#### Contact Information:

**Cedric Ball**

Email: [cball@bulkmolding.com](mailto:cball@bulkmolding.com)

Phone: (614) 477-2139

**Bulk Molding Compounds, Inc.**

P.O. Box 3354

Dublin, OH 43016

Website: <http://www.bulkmolding.com>

# Corrosion Test Cell for PEM Bipolar Plate Materials

Commercial Technology

## New Test Cell Simulates Conditions in PEM Fuel Cells Allowing for Efficient and Less Costly Materials Testing

Fuel cells are composed of multiple bipolar plates (BPPs). Fuel cell developers are currently working with different materials to determine the best combination of durability, efficiency, and performance under unfavorable operating conditions. One of the factors determining durability is the reaction of the BPPs to the fuel cell environment. The operation of a fuel cell can result in an environment that corrodes the BPPs. Therefore, one of the major challenges in developing these BPPs is corrosion protection at a reasonable price.

To aid in screening different fuel cell materials, a corrosion test cell was developed by Los Alamos National Laboratory (LANL) in 1999 with funding from the U.S. Department of Energy's Fuel Cell Technologies (FCT) Program. The purpose of the test cell was to represent as closely as possible the conditions at the anode and cathode of an operating polymer electrolyte membrane (PEM) fuel cell. An exclusive license to this technology was granted to Fuel Cell Technologies, Inc., and a commercial product was developed and sold in 2008.

To represent the anode and cathode environments in the test, an acidic aqueous solution is chosen to represent the electrolyte. The central portion of the cell consists of platinum screens, electrodes, and carbon flow fields in contact with the BPP. Electrical current is passed through the conductors, and the resistance of the anode and cathode interfaces is measured. Bubbles of hydrogen (anode) and air (cathode) across the interface provide circulation between the BPP region and electrolyte reservoirs. Platinum catalyzed electrodes establish rest potentials between the BPP and electrolyte.

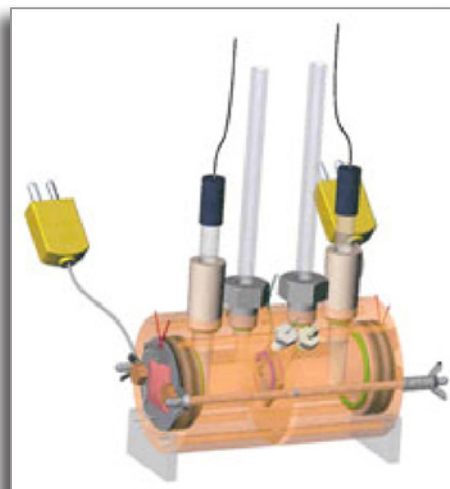

*The Corrosion Test Cell Unit*



## Technology History

- ◆ Developed at LANL and licensed to Fuel Cell Technologies, Inc.
- ◆ Commercialized and being marketed in 2008 by Fuel Cell Technologies with two units sold to date.

## Applications

Can be used to to represent as closely as possible the conditions at the anode and cathode of an operating PEM fuel cell to test the BPP material.

## Capabilities

- ◆ Provides a long-term measurement of electrical resistance of the anode and cathode BPP interfaces.
- ◆ Allows soluble BPP dissolution products to be monitored in the electrolytes.

## Benefits

### Cost Savings

Reduces costs by using corrosion cells and accessory equipment rather than the traditional fuel cell test stands.

### Efficiency

Allows materials to be screened without fabrication of BPPs and multiple cells to screen multiple materials at the same time, reducing development time.

### Versatility

Provides an intermediate level of screening for BPP materials between potentiostatic measurements and long-term fuel cell tests.

**Contact Information:****Chuck Derouin***Email:* [chuck@fuelcelltechnologies.com](mailto:chuck@fuelcelltechnologies.com)*Phone:* (505) 821-4762**Fuel Cell Technologies, Inc.**

5620 Venice Ave., Suite F

Albuquerque, NM 87113

**Website:** <http://www.fuelcelltechnologies.com/fuelcell>

# Cost-Effective, High-Efficiency, Advanced Reforming Module (CHARM)

Commercial Technology

## New Modular Hydrogen Generation Method Enables On-Site Production at Reduced Cost

Creating a hydrogen infrastructure is a prerequisite to widespread fuel cell commercialization, especially for the automotive market. While hydrogen offers an opportunity to replace petroleum-based fuels, it occurs naturally only in chemical compounds such as water or hydrocarbons, which must be chemically converted to produce hydrogen gas. While an ultimate goal is to produce hydrogen through renewable energy sources, steam methane reforming (SMR) of natural gas is currently the most economical solution to initiate the transition to a hydrogen economy.

Centralized hydrogen generation using large industrial SMR plants is already in place to serve customers. However, transportation of hydrogen is only economical for very short distances due to the weight and size of the cylinders needed to contain hydrogen gas or liquid. Consequently, distributed natural gas reforming, which trades off the economies of scale of large plants for simplified delivery logistics, is an attractive alternative that could address immediate problems with the lack of hydrogen infrastructure.

Nuvera Fuel Cells, Inc., conducted a development program to advance fuel processing technology for distributed hydrogen generation by addressing the technical barriers of durability, cost, and manufacturability. This work was performed under a collaborative effort with the U.S. Department of Energy's Fuel Cell Technologies (FCT) Program and was called CHARM™ (Cost-effective High-efficiency Advanced Reforming Module). The CHARM program's pre-eminent focus was to develop a system with the lowest life-cycle cost and was the enabler for Nuvera's PowerTap™ Hydrogen Generator. When combined with Nuvera's Hydrogen Station, PowerTap provides the most cost-effective fueling solution for fuel-cell-powered material-handling equipment.

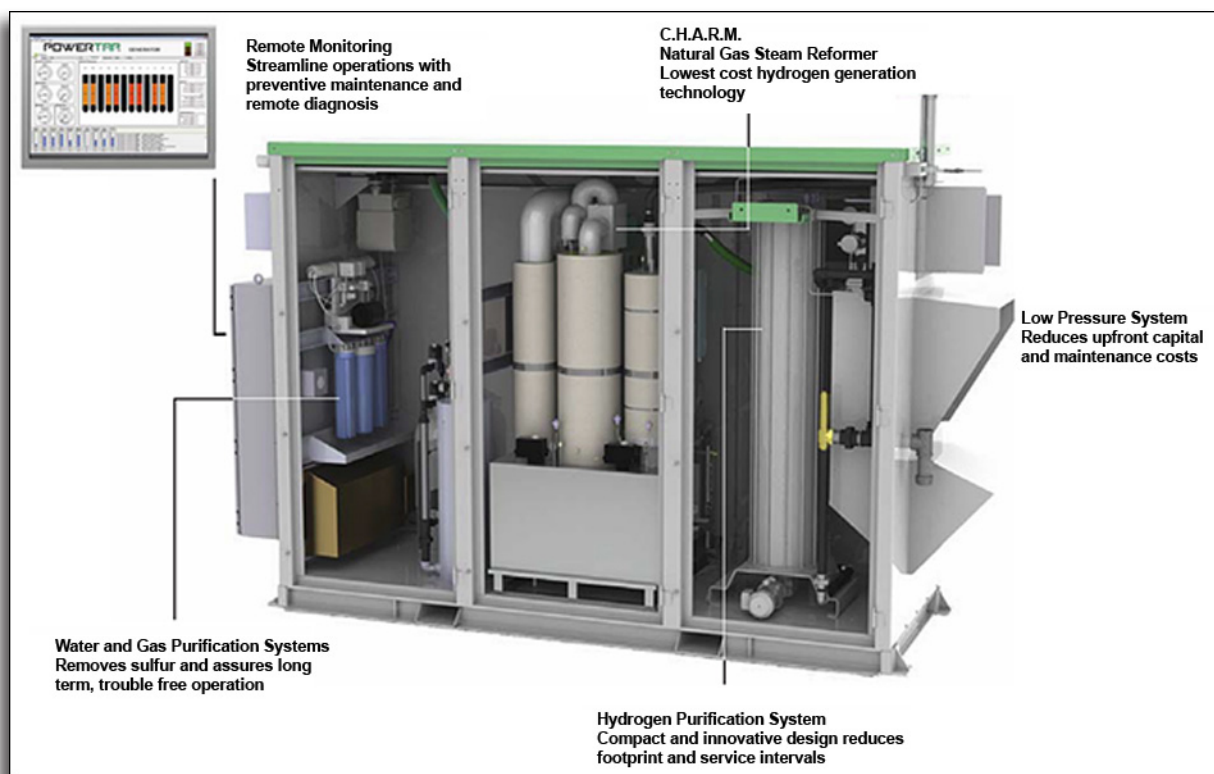

*Cut-Away View of Nuvera's CHARM-Based PowerTap Hydrogen Generator*



*PowerTap Hydrogen Generation and Refueling System*

## Technology History

- ◆ Developed by Nuvera Fuel Cells, Inc.
- ◆ Commercialized in 2009 as part of Nuvera's PowerTap technology, an integrated hydrogen generation and refueling system.

## Applications

Can be used for cost-effective, on-site hydrogen generation and delivery to enable adoption of fuel-cell-powered material-handling equipment (e.g., forklift fleets) and automobiles.

## Capabilities

- ◆ Generates pure (99.995%+) hydrogen at rates of up to 56 kg per day.
- ◆ When coupled with fuel cell forklift trucks, reduces greenhouse gas emissions compared with grid-charged batteries or internal combustion engines.

## Benefits

### Cost Savings

Offers convenient, on-site, hydrogen generation from affordable natural gas and eliminates the costly transportation charges associated with delivering hydrogen via bottles or tube trailers.

### Durability

Mitigates the detrimental effects of thermal cycling and supports long product life through its system design.

### Versatility

Offers scalable hydrogen production rates and purification levels to suit the needs of applications from fuel cell vehicles to merchant hydrogen.

#### Contact Information:

**Darryl Pollica**

Email: [dpollica@nuvera.com](mailto:dpollica@nuvera.com)

Phone: (617) 245-7637

**Nuvera Fuel Cells, Inc.**

129 Concord Road, Building 1

Billerica, MA 01821

Website: <http://www.nuvera.com>

# GCtool: Fuel Cell Systems Analysis Software Model

Commercial Technology

## New Modeling Tool Allows System Designers a Flexible and Speedy Simulation of Fuel Cell Systems and Subsystems

While developers are addressing improvements in components and subsystems in automotive fuel cell propulsion systems, such as fuel cells, stacks, fuel processors, and balance-of-plant components, Argonne National Laboratory, with support from the U.S. Department of Energy's Fuel Cell Technologies (FCT) Program, has developed a modeling and analysis tool that allows system designers to manipulate and validate different configurations without having to build a functional prototype.

The Generational Computational toolkit (GCtool) software package offers speed, flexibility, and user-friendliness, allowing end-users to address issues of thermal and water management, design-point and part-load operation, in addition to component, system, and vehicle level efficiencies and fuel economies. Such analyses are essential for effective system integration while avoiding the expense and delays of building different fuel cell or power-plant configurations for evaluation.

The GCtool can also be used to analyze a variety of automotive hydrogen storage options, some of which have an off-board regeneration component. GCtool can help determine the hydrogen storage system's gravimetric and volumetric capacities, hydrogen charge and discharge rates, and both on-board and off-board process energy efficiencies. Such analyses have been used to assess the performance of compressed gas, cryo-compressed gas, sorbent, complex metal hydride, and organic liquid carrier-based hydrogen storage systems designed to meet both near-term and future automotive hydrogen storage targets.

The GCtool's strength lies in the flexibility of the program. Using a common C or C-linkable language, the GCtool enables developers to use existing libraries or modules to incorporate custom models of any desired level of sophistication (fidelity) created by end-users. Capable of performing both steady-state and dynamic analyses, the program allows for unlimited parameter sweeps and also performs constrained optimization where specific constraint definition is not a prerequisite for system operation.

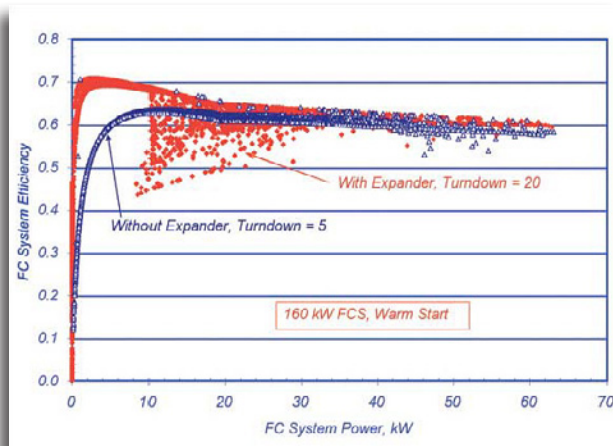

*Effect of Expander on Dynamic System Efficiency over an Urban Drive Cycle*

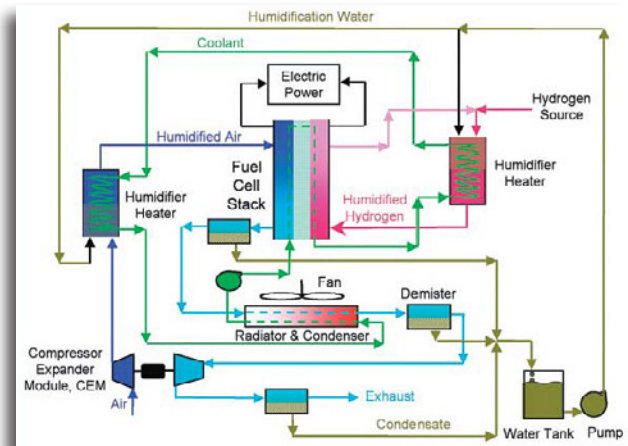

*Schematic Diagram of a Hydrogen-Fueled Polymer Electrolyte Fuel Cell System for Automotive Applications*

## Technology History

- ◆ Developed and commercialized by Argonne National Laboratory.
- ◆ Sold 67 licenses since 1999.

## Applications

Can be used by end-users to develop component or system configurations and simulations that can be used to evaluate developmental components and systems against efficiency targets for fuel cell deployment.

## Capabilities

- ◆ Enables modeling and analysis of various fuel cell subsystems and portfolios, including polymer electrolyte, molten carbonate, phosphoric acid, and solid oxide fuel cells designs.
- ◆ Allows for simulations that can represent any duty cycles, such as the various automotive driving schedules, for the applications of interest.
- ◆ Allows users to change the baseline information and corresponding library details for alternative configurations.
- ◆ Can be used to model pressurized fluidized-bed combustion and integrated gasification/combined-cycle power plants and other coal combustion systems.

## Benefits

### Cost Savings

Enables users to test and validate models without incurring the time and costs of building a prototype.

### Efficiency

Allows modeling and simulation of systems with rapid turnaround time for analysis and troubleshooting.

### Flexibility

Offers a library of models for subcomponents and property tables common to many systems and allows users to add their own component models, if needed.

**Contact Information:**  
**Rajesh Ahluwalia**  
*Email:* [walia@anl.gov](mailto:walia@anl.gov)  
*Phone:* (630) 252-5979  
**Argonne National Laboratory**  
9700 South Cass Avenue  
Argonne, IL 60439  
**Website:** <http://www.anl.gov>



## New Technology Increases Productivity and Reduces Environmental Impact of Material-Handling Forklift Fleets

Electric forklift fleets that move and stack materials in high-throughput distribution centers have historically been powered with lead-acid batteries. These batteries have a number of productivity-limiting characteristics, such as long changing times (typically at least 10 minutes per change) and declining power output towards the end of a shift (about 14% of lift truck speed is lost over the last half of the battery charge). Two batteries are needed for each piece of equipment (one being used while the other is being charged), an arrangement that requires a dedicated room for charging and storing depleted batteries.

To address these issues, Plug Power Inc. developed an improved power source for electric forklift fleets. The GenDrive system consists of a hydrogen fuel cell stack, lithium-ion batteries for situations requiring high power draw (e.g., rapid acceleration), a compressed hydrogen storage tank, and other balance-of-plant components. The GenDrive comes in a range of models to meet the power requirements of Class-1, -2, and -3 forklifts and has been designed to fit into existing forklift battery compartments for easy fleet conversion. The system provides constant voltage throughout the duration of a shift, thereby eliminating the equipment performance degradation experienced with lead-acid batteries. Refueling with hydrogen takes three minutes or less and can be done by the forklift operators via an easy-to-use dispenser that is similar to a gas pump for automobiles. The quick refueling maximizes the amount of productive time that operators spend moving product out on the floor. In addition to productivity enhancement, the GenDrive also reduces the amount of CO<sub>2</sub> emissions attributable to forklift fleet operation compared with batteries recharged by grid-generated electricity.

With assistance from the U.S. Department of Energy's Fuel Cell Technologies Program (as part of the American Recovery and Reinvestment Act), forklift fleets powered by the GenDrive are operating at several large distribution centers across the country. Companies participating in these fleet deployments include Sysco Corporation, FedEx Freight, Wegmans Food Markets, Inc., Whole Foods Market, Inc., Kimberly-Clark Corporation, and The Coca-Cola Consolidated. These demonstrations of the GenDrive technology in real-world operational settings are helping Plug Power evaluate and optimize the unit's performance, and are building confidence in the use of fuel cell technologies for material-handling and other applications.



*Class-1, -2, and -3 Forklifts (shown from left to right) Powered by Plug Power's GenDrive Fuel Cells*



*Plug Power's Class-1, -2, and -3 GenDrive Units (shown from left to right)*

## Technology History

- ◆ Developed and commercialized by Plug Power Inc.
- ◆ Currently being used at several large material-handling centers across the United States.

## Applications

Can be used as an alternative to lead-acid batteries for powering electric forklift fleets at high-throughput warehouses, distribution centers, and manufacturing facilities.

## Capabilities

- ◆ Provides 2.6-10.5 kW of continuous power (depending on model).
- ◆ Maintains constant voltage throughout the entire shift, without the performance degradation of batteries.

## Benefits

### Ease of Adoption

Available in multiple models that fit into the existing battery compartments of all major OEM material-handling equipment.

### Emissions Reductions

Reduces CO<sub>2</sub> emissions attributable to forklift fleet operation compared with batteries recharged by grid-generated electricity.

### Productivity

Provides rapid refueling times (60-180 seconds, depending on model), allowing operators to spend more time moving product out on the floor.

#### Contact Information:

**Don Rohr**

Email: [Don\\_Rohr@plugpower.com](mailto:Don_Rohr@plugpower.com)

Phone: (518) 738-0343

**Plug Power Inc.**

968 Albany Shaker Road  
Latham, New York 12110

Website: <http://www.plugpower.com>

# Improved Catalyst Coated Membrane (CCM) Manufacturing

Commercial Technology

## New Spray Deposition Technique Results in Lower Manufacturing Costs at Higher Volumes

The conventional technologies for manufacturing catalyst coated membranes/membrane electrode assemblies (CCMs/MEAs) include screening printing, roller coating, decal transferring, and gravure coating. Each technology requires significant investment for the fuel cell CCM/MEA production application. The relatively complex manufacturing processes associated with these technologies do not allow the flexibility to meet different direct methanol fuel cell (DMFC) equipment manufacturer's application requirements. In addition to the lack of flexibility, these technologies also suffer from low yields, further increasing the cost of the finished product.

To overcome these limitations, Cabot Corporation developed a revolutionary spray deposition manufacturing technology along with specialized inks and catalyst powders. Cabot received development funding from the U.S. Department of Energy's Fuel Cell Technologies (FCT) Program through the National Center for Manufacturing Sciences. This new manufacturing platform can be used for CCM/MEA production with existing printer or spray deposition systems. It uses special electrocatalyst inks with a limited amount of capital investment per volume demand and has a much simpler manufacturing process. It also improves CCM performance and possesses a high degree of flexibility to meet various DMFC customers' requirements.

This new manufacturing technology will help expedite the commercialization of DMFCs and impact fuel cell manufacturing costs and processes. It allows high-volume production of CCMs/MEAs with lower platinum content and higher fuel cell performance. This technology can be easily applied to other areas by printing catalysts on substrates for other industries, such as membrane reactors, gas separation membranes coated with selective catalysts, other types of fuel cells (e.g., solid oxide fuel cells), electrolyzers, ultracapacitors, batteries, and other coated membrane applications.

In March 2009, Cabot sold the manufacturing line to IRD Fuel Cells, LLC, a U.S.-based affiliate of the Danish company IRD Fuel Cell Technology A/S. Cabot and IRD have entered into joint development and supply agreements to manufacture improved MEAs incorporating Cabot's advanced electrocatalysts. IRD will operate the manufacturing line, which will remain at its current location in Albuquerque, New Mexico. Cabot will focus its efforts on making further improvements to its fuel cell electrocatalyst products.

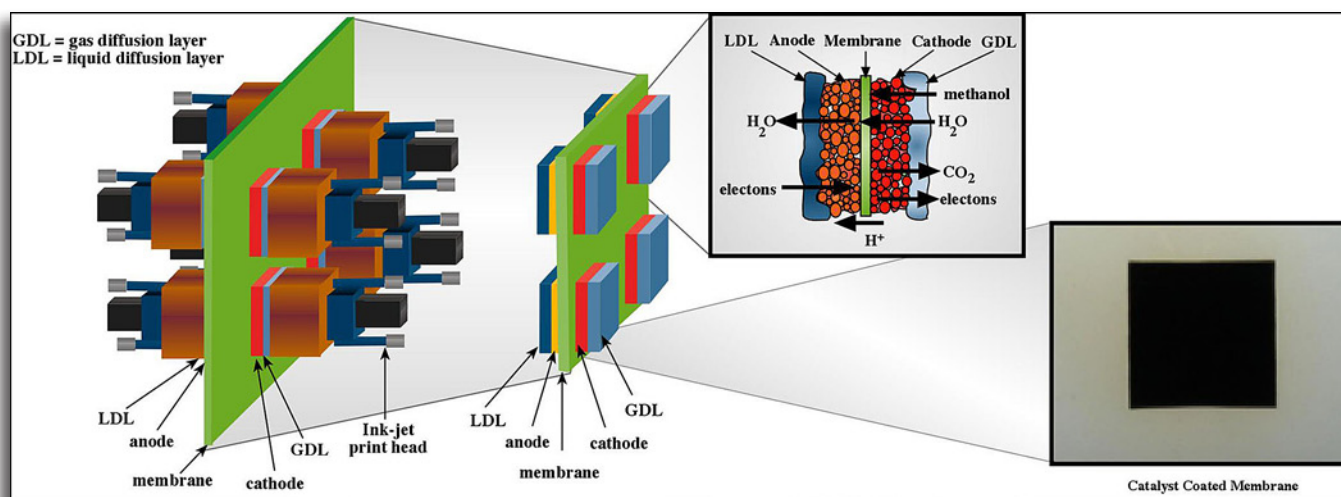

*Catalyst Coated Membrane Manufacturing Process*



## Technology History

- ◆ Developed by Cabot Corporation.
- ◆ IRD Fuel Cells, LLC now operating MEA manufacturing process. IRD are further developing the process and MEA materials.

## Applications

Can be used to manufacture CCMs/MEAs for DMFCs or other industries, e.g. membrane reactors, gas separation membranes coated with selective catalysts, other types of fuel cells (e.g., solid oxide fuel cells), electrolyzers, ultracapacitors, batteries, and other coated membrane applications.

## Capabilities

- ◆ Provides low-cost, high-volume manufacturing of CCMs/MEAs for fuel cells.
- ◆ Reduces the amount of precious metals needed in fuel cells.

## Benefits

### Cost Savings

Reduces the cost of manufacturing CCMs/MEAs and the amount of expensive precious metals used in a fuel cell.

### Productivity

Allows higher production and higher yields.

### Versatility

Can be used with existing spray deposition systems and allows quick changeover to different materials.

**Contact Information:****Madeleine Odgaard***Email:* [mod@ird.dk](mailto:mod@ird.dk)*Phone:* (505) 301-8268**IRD Fuel Cells LLC**

8500 Washington St. NE #1

Albuquerque NM 87113

**Website:** <http://www.ird.dk>

# Improved Fuel Cell Cathode Catalysts Using Combinatorial Methods

Commercial Technology

## New Test Equipment Allows Rapid Testing of Fuel Cell Components

Platinum is currently used as a catalyst in fuel cell membrane electrode assemblies (MEAs). Unfortunately, platinum is an expensive precious metal and increases the overall cost of a fuel cell. Reducing the amount of platinum or substituting alternative materials requires time-consuming *ex situ* methods of analysis that do not consider the effects of the realistic catalyst environment and flowing reactant fuel and oxidant streams. A device is needed that can enable high-throughput evaluation of fuel cell electrode catalysts that are incorporated into a real MEA in an operating fuel cell.

In response to this need, NuVant Systems Inc., with a U.S. Department of Energy (DOE) Small Business Innovation Research (SBIR) grant, developed the Arraystat 25-channel potentiostat and Array Fuel Cell. This system allowed the user to simultaneously probe 25 electrodes on a fuel cell MEA. NuVant then improved the Arraystat technology. The current analysis system has added the Array Flow Manifold, which provides reactants at controlled temperature, humidity and flow rate to the Array Fuel Cell. The Arraystat can switch out (i.e., open circuit) any number of electrodes while others are tested either in parallel or sequentially. The Array Fuel Cell system is designed to generate uniform temperature and flow conditions across the entire active area of the MEA. The working/array side of the MEA consists of 25 independent disk electrodes. A single counter electrode serves as the common reference electrode when charged with hydrogen flow. The Array Fuel Cell is available in both parallel and serpentine configurations for gas or liquid reactant streams, respectively. This technology enables electrode components to be evaluated under reactor conditions.

The system also comes with user friendly Arrayware software, which can control the Arraystat, up to 12 temperature controllers, and up to 6 mass flow controllers. The software allows users to easily write and execute complex sequences of variables to be analyzed with minimal supervision. In addition to the system components and software, NuVant now offers installation and short training courses to facilitate customer in-house preparation of fuel cell electrodes.



*NuVant's Automated 25-Channel Array Potentiostat (Arraystat)*

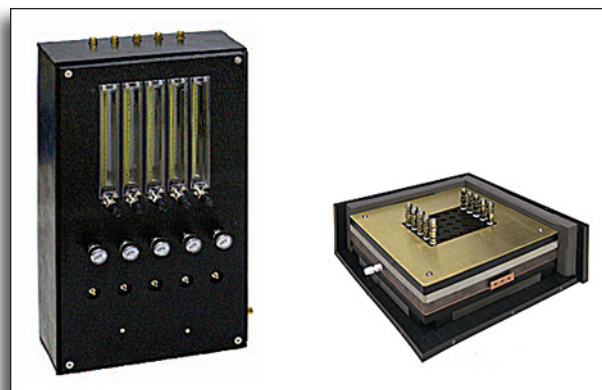

*NuVant's Array Flow Manifold (left) and Array Fuel Cell*

## Technology History

- ◆ Developed by NuVant Systems Inc., with research starting in 2004.
- ◆ Sold first commercial Arraystat in 2006 and first commercial Array Fuel Cell in 2007.

## Applications

Can be used to test fuel cell and battery components, electroplating processes, biomedical devices, and electrochemical sensors. The equipment is also applicable to electrosynthesis and corrosion studies, flow field development, and computational modeling validation.

## Capabilities

- ◆ Measures and records data simultaneously from 25 electrodes on a fuel cell MEA.
- ◆ Provides reactants at controlled temperature, humidity, and flow rate via the Array Flow Manifold for consistent conditions across the entire MEA active area.
- ◆ Enables electrode components to be evaluated under reactor conditions in the Array Fuel Cell.

## Benefits Accuracy

Eliminates random error introduced by multiple test stands by using a single common counter electrode.

## Cost Savings

Reduces costs associated with MEA testing because of the high throughput achieved with a single test station.

## Versatility

Allows the user to apply complex sequences of test parameters to any number of the array electrodes in parallel or sequentially.

**Contact Information:**  
**Eugene S. Smotkin**  
 Email: [esmotkin@nuvant.com](mailto:esmotkin@nuvant.com)  
 Phone: (219) 644-3231  
**NuVant Systems Inc.**  
 9800 Connecticut Drive  
 Crown Point, IN 46307  
 Website: <http://www.nuvant.com>

# Integrated Manufacturing for Advanced Membrane Electrode Assemblies

Commercial Technology

## New Fabrication Process Reduces Costs and Improves Performance of Fuel Cells

BASF Fuel Cell, Inc., with funding from the U.S. Department of Energy's Fuel Cell Technologies (FCT) Program, developed an advanced membrane electrode assembly (MEA) fabrication process using improved electrode structures and catalysts and a durable membrane. The assembly used a new design for the gas diffusion electrode (GDE) which incorporated the "fine gradient" ELAT™ electrode (trademark derived from Electrode, Los Alamos Type), resulting in assemblies that could run longer with more stable voltages. By modifying the fine gradient structure, performance was improved when operating at lower relative humidity. The fine gradient approach also decreased precious metal loading, resulting in reduced material costs. This work generated successfully commercialized spin-off products for gas diffusion electrodes, electrocatalysts, and MEAs for direct methanol fuel cells.

Building upon these prior innovations, BASF has recently developed and commercialized Celtec®-P MEAs for high temperature PEM fuel cells. The new MEAs allow for fuel cell operation in the range of 120-180°C and have the ability to run without any humidification. These capabilities eliminate the need for complex hydration equipment associated with conventional low temperature fuel cell systems, which translates into increased cost savings. The Celtec®-P MEAs have a high tolerance to carbon monoxide in the hydrogen fuel stream, which makes the fuel reforming step far simpler and less costly. BASF has also been able to reduce the amount of platinum used as catalyst in the electrode without sacrificing performance, resulting in significantly reduced manufacturing costs.

BASF manufactures the novel MEAs at its integrated fuel cell facility in Somerset, New Jersey. The facility houses an assembly line which progresses from starting raw materials to the finished product. A key strength of BASF's MEA technology is the ability to specifically customize the units to fit customers' size requirements. The Celtec®-P MEAs are currently the heart of numerous fuel cell applications using reformed hydrogen as a fuel, most notably micro combined heat and power systems of 1-5kW.



*BASF Coating Machine for MEAs*

## Technology History

- ◆ Developed by BASF in partnership with DuPont Fuel Cells, Nuvera Fuel Cells, Spire Biomedical Corp, Northeastern University, and Case Western Reserve University.
- ◆ Previously manufactured products include: electrocatalysts, gas diffusion electrodes, and MEAs for direct methanol fuel cells.
- ◆ Currently producing Celtec®-P MEAs for high temperature PEM fuel cells.

## Applications

Can be used in high temperature PEM fuel cells used for backup power systems, auxiliary power units, and residential combined heat and power systems.

## Capabilities

- ◆ Allows fuel cells to operate at temperatures of 120-180°C without the need for humidification.
- ◆ Achieves long term stability for more than 20,000 hrs with only a small voltage drop.
- ◆ Eliminates the need for complex membrane hydration equipment such as: air humidifiers, water pumps, tanks, valves, and cleaning systems.

## Benefits

### Cost Savings

Reduces amount of precious metal catalyst used in MEAs without a loss in performance.

### Durability

Increases MEA anode tolerance to carbon monoxide poisoning, thereby allowing operation at 1-2% CO.

### Versatility

Offers customizable fabrication to fit customers' MEA size requirements.

**Contact Information:****Emory S. De Castro***Email:* [emory.decastro@basf.com](mailto:emory.decastro@basf.com)*Phone:* (732) 545-5100 x4114**BASF Fuel Cell, Inc.**

39 Veronica Ave.

Summerset, NJ 08873

**Website:** <http://www.basf.com>



# Manufacture of Durable Seals for PEM Fuel Cells

Commercial Technology

## New Manufacturing Method and Material Reduces Fuel Cell Assembly Cost

Considerable effort is underway to build a hydrogen infrastructure for automotive and stationary power. Mature polymer electrolyte membrane (PEM) fuel cell technology is a requisite for harnessing this infrastructure. To provide sufficient power and voltage, individual PEM fuel cells are stacked in series to yield a cell stack assembly (CSA). At the basic level, each cell contains an anode, cathode, membrane separator, and interfacial seals. The lifetime of the CSA is limited by the repeat elements. By carefully controlling the operating conditions, stack lifetimes equal to that of the interfacial seals and membranes can be achieved. Efforts are currently underway to improve membrane lifetimes. While very little was previously done in the area of seal durability, with funding from FCT through the National Center for Manufacturing Sciences, Freudenberg-NOK General Partnership (FNGP) has developed and now commercialized durable seals for PEM fuel cells.

Seals for PEM fuel cells pose an enormous challenge compared with traditional industry sealing designs and manufacturing methods. Traditional sealing materials such as silicone are known to break down in the fuel cell environment. The resulting compounds can migrate to adjacent fuel cell components, causing water, reactant, and ionic transport contamination issues. Careful elastomer material selection for the new seal has eliminated the contamination risks, dramatically improving durability and reliability.

FNGP uses a custom elastomer material that exhibits vastly superior chemical and mechanical properties compared with conventional silicones. In addition to eliminating concerns of silicone catalyst contamination, the elastomer, developed for fuel cell applications, has improved compression set resistance and a low level of ionic contaminants. A low-cost, long-life alternate carrier material is also being used. Based on the new elastomer and carrier material, FNGP can now provide an advanced interfacial seal design by molding the elastomer onto the carrier material. A high-volume manufacturing process was also incorporated to make this design feasible. Combining disciplined material selection, lean manufacturing methods, and six sigma principles, FNGP has now commercialized this new seal.

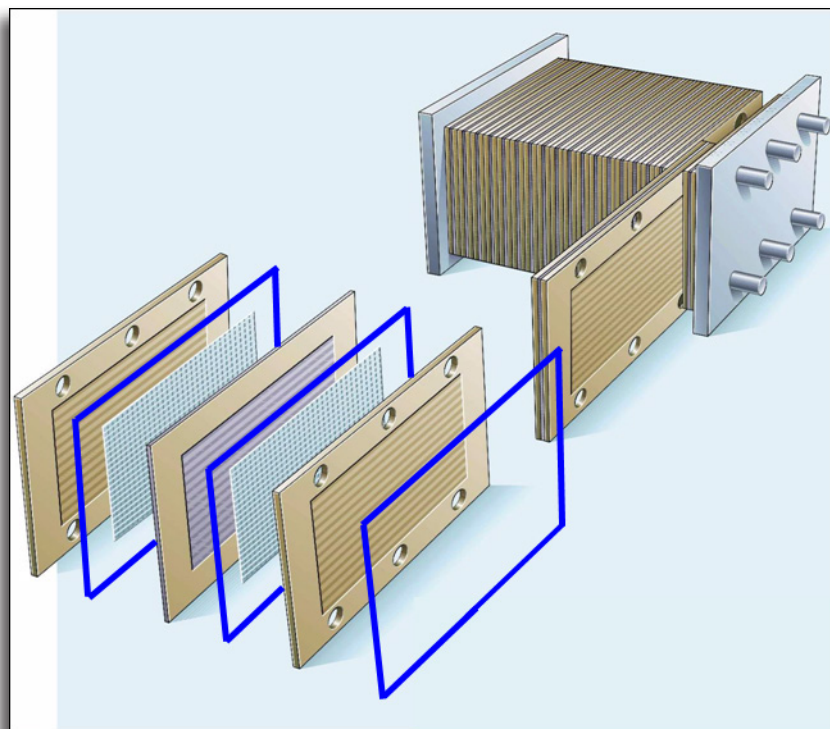

*Exploded View of a Typical PEM Fuel Cell Stack Assembly Showing FNGP's Durable Seals in Blue*

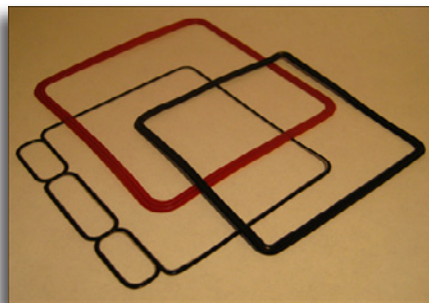

*FNGP's Durable Seal for PEM Fuel Cells*

## Technology History

- ◆ Developed by FNGP in partnership with UTC Power.
- ◆ Began research in 2006, with commercialization in 2009.

## Applications

Can be used in PEM fuel cell stacks to improve power plant efficiency and durability for bus/transportation applications and stationary power sources.

## Capabilities

- ◆ Allows the seals to survive the electrochemical environment while eliminating catalyst poisoning concerns in the fuel cell.
- ◆ Covers a large region (50 cm x 35 cm) and accommodates large flange variations ( $\pm 0.4$  mm) with very low contact pressures (less than 3 N/mm).

## Benefits

### Cost Savings

Results in warranty cost savings through improved durability.

### Durability

Displays superior chemical and mechanical property stability compared with conventional silicones and low levels of ionic contaminants.

### Efficiency

Reduces both assembly times and costs because seals can be mass produced.

#### Contact Information:

**Mark Belchuk**

Email: [MXB@FNGP.com](mailto:MXB@FNGP.com)

Phone: (734) 354-5309

**Freudenberg-NOK General Partnership**

47690 East Anchor Court

Plymouth, MI 48170-2455

Website: <http://www.freudenberg-nok.com>

# Membranes and Membrane Electrode Assemblies for Dry, Hot Operating Conditions

Commercial Technology

## PEM Fuel Cell Electrolyte Membranes Offer Improved Durability and Performance

Polymer electrolyte membrane fuel cells (PEMFCs) represent a promising energy technology for transportation, stationary, and back-up power applications. While many breakthroughs have been made over the last few years in developing PEMFCs, technical and economic barriers for their commercialization still exist. Key areas where improvements are still needed are in expanding the temperature range and lowering the humidification requirements of the stack, particularly for automotive fuel cell applications. Requirements of system size, efficiency, performance, start-up, and cooling mean that automotive fuel cells must be able to run robustly and exhibit adequate durability under a wide variety of operating temperatures, including temperatures up to 120°C and with little or no external gas humidification. The temperature and humidification range under which a fuel cell system can operate is limited by the operating range of the membrane electrode assembly (MEA); and while the membrane is not the only factor that influences the MEA operating range, it is very often the most critical. Therefore, new membranes are the key to meeting automotive fuel cell requirements.

3M Company, funded in part by FCT, has developed a new low equivalent weight (EW), perfluorinated sulfonic acid-based (PFSA) membrane with improved chemical and mechanical stability, and proton conductivity. This new membrane allows 3M to provide MEAs with significantly improved durability and performance. The new polymer structure and membrane processing methods provide improved mechanical properties, that, with improved polymer chemistry and stabilizing additives, increases lifetime by 10 to 100 times. MEAs with these membranes have run over 18,000 hours in accelerated testing protocols and over 10,000 hours in stacks. The lower EW ionomer provides higher conductivity at low humidification, which allows higher operating voltages.

Under the FCT Program, membranes are being developed with new side-chain chemistries, new stabilizing and conductivity enhancing additives, and new membrane fabrication processes that provide further improvements in conductivity and durability under hot (up to 120°C) dry conditions.

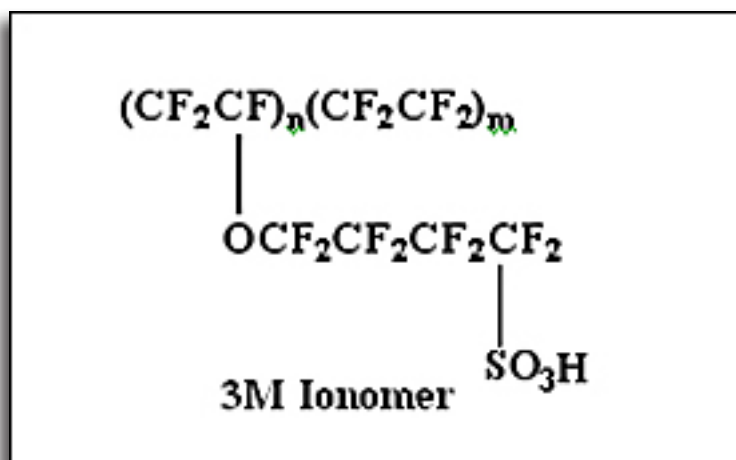

*The 3M Ionomer With Lower Equivalent Weight Side Chain than Standard PFSA Ionomers*



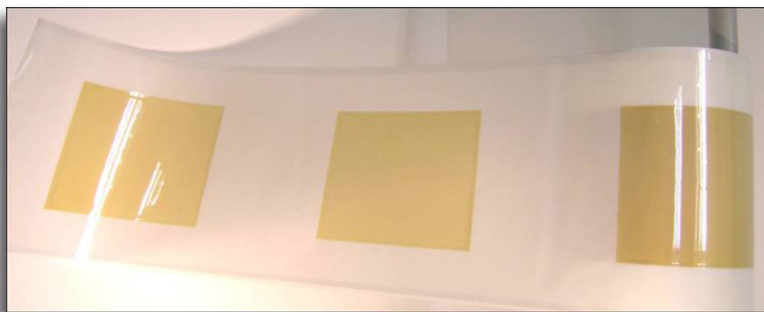

*Membrane Windows in a Roll Good Film Subgasket*

## Technology History

- ◆ Commercialized in 2006.
- ◆ Introduced an improved 20 micron membrane in 2009.

## Applications

Can be used in PEM fuel cells for transportation, stationary, and back-up power applications.

## Capabilities

- ◆ Demonstrates up to 100 times increase in MEA lifetime.
- ◆ Significantly increases performance under dry operating conditions.

## Benefits

### Cost Savings

Provides lower cell resistance/improved performance and allows the use of fewer cells to meet power specifications, which means less humidification or cooling equipment required. The increased MEA durability provides lower replacement costs.

### Efficiency

Provides higher cell voltage in fuel cell systems running at higher temperatures and/or lower humidification, allowing more efficient use of hydrogen.

### Performance

Improves system performance.

#### Contact Information:

**Steve Hamrock**

Email: [sjhamrock@mmm.com](mailto:sjhamrock@mmm.com)

Phone: (651) 733-4254

**3M Company**

3M Center, 201-1W-28

St. Paul, MN 55144

Website: <http://www.3m.com>

# Novel Manufacturing Process for PEM Fuel Cell Stacks

## One-Step Molding Process Reduces Manufacturing Costs and Improves Fuel Cell Stack and System Durability

The foremost hurdle facing fuel cell developers today is high manufacturing costs. Today's state-of-the-art stack fabrication technology has low manufacturing yields and poor stack reliability, resulting primarily from manual assembly methods and multiple sealing interfaces. Additionally, complicated product designs and gasket-reliant assembly increase production costs and reduce fuel cell durability. While economy-of-scale will address the cost issues for many ancillary components of integrated fuel cell systems, stack manufacture and reliability remain major concerns.

Protonex Technology Corporation has addressed these concerns with a novel manufacturing method that eliminates the labor-intensive stacking/alignment and multiple component design of conventional stack fabrications. This new process was refined with funding from the U.S. Department of Energy's Fuel Cell Technologies (FCT) Program through the National Center for Manufacturing Sciences. Protonex uses a one-step molding process that creates the manifold structure and seals the stack and five-layer membrane electrode assemblies (MEAs). The process is compatible with 5-layer MEAs generated in continuous roll coating operations.

Three portable power system products have used this new manufacturing process. The M250-B product is for commercial users and the M250-CX and M300-CX products are for military customers. Currently, 250-watt and 300-watt systems are being supplied to the U.S. military, and the U.S. Army has funded further improvements in the system.

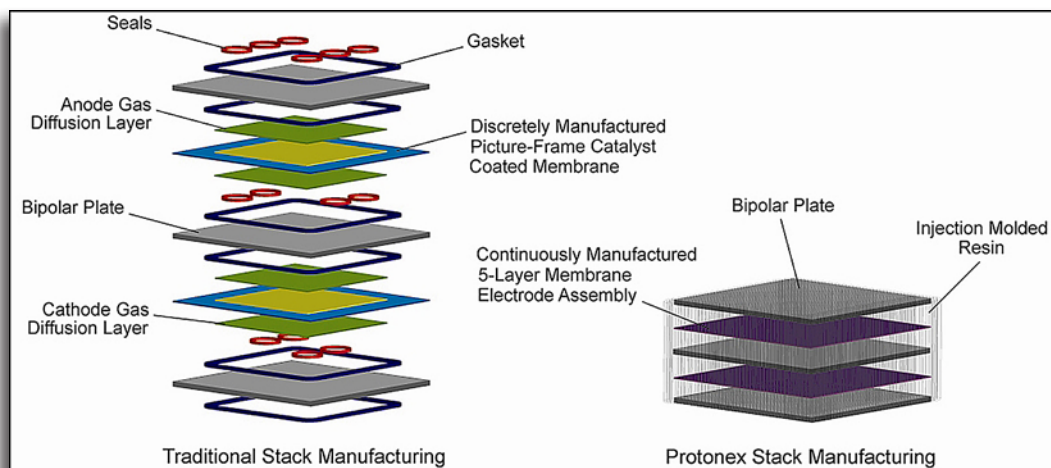

*Protonex Injection-Molded Stack Versus Traditional Stack Assembly*



*Protonex Technology Fuel Cell Stacks*

## Technology History

- ◆ Developed and commercialized by Protonex Technology Corporation to manufacture portable power systems for military and commercial use.
- ◆ Delivered over 30 M250-CX and M300-CX systems through 2010.

## Applications

Can be used to manufacture polymer electrolyte membrane (PEM) direct methanol and alkaline-based fuel cells for consumer electronics, portable soldier power devices, residential utilities, and automotive engines.

## Capabilities

- ◆ Demonstrates that high-performance PEM stacks can be produced with a high degree of manufacturability.
- ◆ Reduces part count and complexity and manufacturing cycle time.

## Benefits

### Cost Savings

Lowers costs by using lower tolerance and fewer components.

### Efficiency

Offers significant part count reduction and improved (lower) manufacturing time.

### Reliability

Uses adhesive-based seals to improve stack reliability and robustness over traditional compression-based seals.

### Versatility

Is easily automated, uses membrane electrode assemblies more efficiently, and reduces the need for tension members.

#### Contact Information:

**Paul Osenar**

Email: [paul.osenar@protonex.com](mailto:paul.osenar@protonex.com)

Phone: (508) 490-9960

**Protonex Technology Corporation**

153 Northboro Road

Southborough, MA 01772

Website: <http://www.protonex.com>

# Portable Reformed Methanol Fuel Cells

Commercial Technology

## Lightweight, Rugged Fuel Cell Unit Provides Innovative Mobile Power for Soldiers in the Field

The XX25™ portable reformed methanol fuel cell is a self-contained, 25-W output power system that uses a fuel cell in conjunction with a methanol fuel source to generate power. The XX25 was developed by UltraCell Corporation with funding from the U.S. Department of Energy's Fuel Cell Technologies (FCT) Program, through the Edison Materials Technology Center. The fuel source can be external or enclosed as an integral part of the unit as a replaceable cartridge. The XX25 contains a power button, an output connector, an LCD display (backlit and contrast adjustable), and a fuel cartridge that contains the methanol fuel.

The XX25 is ruggedized and has successfully passed extreme environmental testing that meets military standards. The testing subjected the XX25 to temperature extremes, vibration, dust, corrosive environments, and other extreme conditions. The lightweight system operates silently and may be operated continuously by hot swapping fuel cartridges. A larger external fuel source may be used for extended run times and a five-gallon fuel tank will supply 12,500 watt-hours of energy.

For applications requiring larger amounts of mobile power, UltraCell has recently developed the XX55™ fuel cell. The XX55 delivers 50 watts of continuous power and up to 85 watts of peak power. Both models are ideal for a wide variety of mobile and stationary electronics applications, including: radio and satellite communication gear, remote or mobile surveillance systems, laptop computers, and battery charging. For extended missions, UltraCell now offers a full line of fuel tank options to meet a variety of capacity and runtime needs. This enables critical sensors or video surveillance systems to run for weeks or months at a time with a power supply and fuel source package that is easily transportable by a single person. The fuel cell systems offer significant weight-savings over traditional batteries; one XX25 fuel cell coupled to a five-gallon fuel tank provides the same amount of energy as sixty BA-5590 batteries, with a 70% weight savings.



*XX25 (Sand) and XX55 (Black) Fuel Cells with Portable Pack Unit*



*Extended Runtime Fuel Options (250cc Cartridge to 5 Gallon Tank)*

## Technology History

- ◆ Developed and being marketed by UltraCell Corporation.
- ◆ Won “Best Soldier System Innovation & Technology” at the Soldier Technology USA 2008 Conference.
- ◆ Commercialized in 2007 and more than 400 units sold.

## Applications

Can be used by individual soldiers for portable power for laptops, communication devices, off-grid battery charging, etc.

## Capabilities

- ◆ Supplies up to 25 or 50 watts of continuous power with hot swapping of methanol fuel cartridges.
- ◆ Can be hybridized with external batteries for high power peaks and with up to 5 gallon fuel tanks for long run time.

## Benefits

### Durable

Has passed military standard testing (MIL-STD-810F Environmental Testing) for extreme conditions and contains no moving parts that can fail.

### Environmental

Provides fuel that is totally contained in the cartridge with no toxic byproducts during use.

### Portable and Versatile

Weighs less than two kilograms and is about the size of a hardback book; can be used with different size fuel cartridges or an external fuel source; and offers various voltages (12 to 30 volts).

#### Contact Information:

**Joe Macleish**

Email: [JMacleish@ultracellpower.com](mailto:JMacleish@ultracellpower.com)

Phone: (925) 455-9400 x139

**UltraCell Corporation**

399 Lindbergh Avenue

Livermore, CA 94551

Website: <http://www.ultracellpower.com>



# PureMotion® Model 120 Fuel Cell Power Plant

Commercial Technology

## Hydrogen Fuel Cell Power Plant for Zero-Emission Transit Buses

The PureMotion Model 120 Fuel Cell Power Plant (FCPP) was developed by UTC Power using funding from the U.S. Department of Energy's Fuel Cell Technologies (FCT) Program. The PureMotion 120 is based on proton exchange membrane (PEM) technology, and maximizes fuel efficiency via ambient pressure operation. In addition, the PureMotion 120 is designed to provide a quieter, more comfortable ride for passengers. The power plant's modular design maximizes uptime and simplifies routine maintenance. Testing performed by the National Renewable Energy Laboratory has shown fuel cell buses powered by the PureMotion 120 to exhibit up to twice the fuel efficiency compared with traditional diesel-fueled buses.

The PureMotion 120 has been powering a fleet of 6 transit buses (2 fielded currently) that have successfully demonstrated revenue service operation since 2005. This fleet has accumulated over 49,000 hours of operation and 490,000 miles in transit revenue service as of May 2011. Fuel cell stacks in the fleet leader bus have accumulated over 7,000 hours of operation at rated power without a single cell replacement. The demonstration programs with these buses have been successful in proving the viability of the technology, and have highlighted the many advantages of a fuel cell transit bus, such as: zero emissions, high fuel efficiency, increased reliability, and quiet operation. This success has led to the expansion of the bus fleet. Sixteen new fuel cell buses powered by the second generation of UTC Power's PureMotion 120 entered transit revenue service in late 2010. Twelve of the new buses have begun service in California by AC Transit and other transit agency partners, and four are being used by CT TRANSIT in Connecticut. These new buses are lighter, have improved batteries and are more fuel efficient than the previous generation.

In late 2010, UTC Power was awarded a \$14.4M cost share project under the National Fuel Cell Bus Program to develop a third generation fuel cell power plant. This multi-year project is focused on providing a less costly, smaller and more durable product for the commercial marketplace.



*Next Generation CT TRANSIT Fuel Cell Bus powered by the PureMotion Model 120 FCPP*



*The PureMotion Model 120 FCPP*

## Technology History

- ◆ Developed and commercialized by UTC Power for the transit bus market.
- ◆ Deployed first unit in 2005 with a total of six units delivered by 2007. Sixteen additional units with improved performance were delivered in 2010.

## Applications

Can be used to power hydrogen-fueled vehicles or as a modular stationary 120-kW power source (with appropriate power management and interface controls).

## Capabilities

- ◆ Generates up to 120 kW of power.
- ◆ Achieves up to 2X increase in fuel efficiency compared with conventional diesel-fueled buses.

## Benefits

### Durability

Demonstrated on-road operation in excess of 7,000 hours at rated power without a single fuel cell replacement.

### Environment

Eliminates the greenhouse gas emissions and excessive noise associated with operation of traditional diesel-fueled buses.

#### Contact Information:

**Eileen Bartley**

Email: [Eileen.Bartley@utcpower.com](mailto:Eileen.Bartley@utcpower.com)

Phone: (860) 727-2290

**UTC Power**

195 Governor's Highway

South Windsor, CT 06074-2419

Website: <http://www.utcpower.com>

# Scale-Up of Carbon-Carbon Composite Bipolar Plates

Commercial Technology

## New Molded, Porous Carbon-Carbon Composite Bipolar Plates Offer Fuel Cell Performance and Cost Advantages

In the past, it was not uncommon for fuel cell companies to pay up to \$400 per cell in bipolar plate costs. Even today, some bipolar plates are constructed of graphite, which requires expensive machining to fabricate. When a cost of \$400 per cell is extended to automotive applications where 300 or more cells are required, the cost becomes prohibitive. In addition to the expensive machining, weight and electrical contact resistance are also less than desirable in conventional graphite bipolar plates.

In April 2001, Porvair Advanced Materials, Inc., licensed from Oak Ridge National Laboratory a carbon-carbon composite bipolar plate formation technology that addressed these problems. Using funding from the U.S. Department of Energy's Fuel Cell Technologies (FCT) Program, Porvair investigated transferring this technology from the laboratory to full-scale, low-cost mass production. This investigation also looked at refining the material and its composition to improve fuel cell properties and performance.

The result of this investigation was a new, commercial, fully molded, high-performance porous bipolar plate product that is easily scaled to high volumes. Cost analyses showed that the Porvair plate could meet automotive volume pricing of less than \$4 per kilowatt. Performance of the plates was found to be excellent, meeting or exceeding the performance of competitive products, including state-of-the-art, expensive machined graphite products. Since 2003, Porvair has manufactured more than 50,000 bipolar plates using this technology.

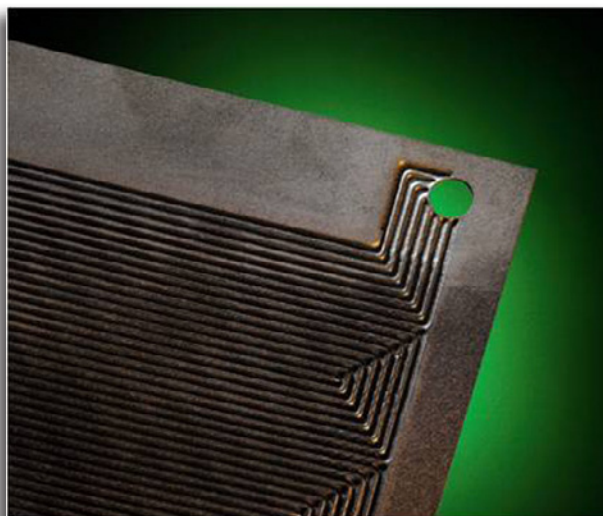

*Fully Molded Porvair Bipolar Plate*



## Technology History

- ◆ Developed and commercialized in 2003 by Porvair Advanced Materials, Inc.
- ◆ Manufactured more than 50,000 bipolar plates since 2003.

## Applications

Can be used in polymer electrolyte membrane fuel cells instead of expensive machined plates.

## Capabilities

- ◆ Allows for molding of a wide array of product designs because of process flexibility.
- ◆ Minimizes contact resistance between cells.
- ◆ Resists the corrosive environment in the fuel cell.
- ◆ Reduces the weight of the fuel cell stack compared with graphite plates.

## Benefits

### Cost Savings

Provides high-volume manufacturing with no machining, reducing the cost of the plates.

### Performance

Resists the corrosive environment in the fuel cell.

### Weight Reduction

Provides an extremely lightweight product with a density of about 1.2 grams per cc.

**Contact Information:****David P. Haack***Email:* [dhaack@Pamus.com](mailto:dhaack@Pamus.com)*Phone:* (828) 697-2411 x3369**Porvair Advanced Materials, Inc.**

700 Sheperd St.

Hendersonville, NC 28792

**Website:** <http://www.porvair.com>



<b>D.2 Production/Delivery Technologies</b> .....	D-39
◆ <a href="#">FuelGen® Hydrogen Fueling Systems</a> .....	D-40
◆ <a href="#">H2 ProGen: A Total Supply Solution for Hydrogen Vehicles</a> .....	D-42
◆ <a href="#">High-Efficiency, High-Pressure Electrolysis via Photovoltaic Arrays</a> .....	D-44
◆ <a href="#">Hydrogen Distributed Production System</a> .....	D-46
◆ <a href="#">Hydrogen Generation from Electrolysis</a> .....	D-48
◆ <a href="#">Hydrogen Safety Sensor for Advanced Energy Applications</a> .....	D-50
◆ <a href="#">ME100 Methanol Reforming Hydrogen Generator</a> .....	D-52
◆ <a href="#">Membrane Structures for Hydrogen Separation</a> .....	D-54
◆ <a href="#">Nanoscale Water Gas Shift Catalysts</a> .....	D-56
◆ <a href="#">PEM Electrolyzer Incorporating an Advanced Low-Cost Membrane</a> .....	D-58

## Hydrogen Electrolysis System Provides High Purity Hydrogen for Fueling Vehicles in a Variety of Climates

The potential worldwide markets for hydrogen-fueled vehicles are broad, encompassing everything from passenger cars, scooters, and buses to trucks, forklifts, and military vehicles. Leading global manufacturers in each of these markets are developing products that require hydrogen. Proton Energy Systems, Inc., as part of a demonstration project managed by EVermont and funded by the U.S. Department of Energy's Fuel Cell Technologies (FCT) Program, developed FuelGen, a hydrogen fueling system. The demonstration fueling station in Burlington, Vermont, completed in 2006, uses wind-generated electricity as well as grid-supplied electricity to produce 8 to 12 kilograms of hydrogen fuel per day. This station demonstrates the ability of the FuelGen system to deliver 99.999% pure hydrogen fuel in a harsh, cold environment.

In the FuelGen polymer electrolyte membrane (PEM) electrolysis unit, water is electrolyzed and broken down into its molecular components of H<sub>2</sub> and O<sub>2</sub>. The H<sub>2</sub> is captured and stored as a compressed gas and used as a motor fuel. The FuelGen system is a fully integrated, packaged electrolysis system that includes support and safety systems for regulating electrolyzing operations. The system offers automated tank-topping operation and an on-board water purification system. The system also offers an integrated vent stack with automatic drain trap, hydrogen product line isolation solenoid valve, integrated dew point monitoring system, an outdoor rated enclosure with shrouds, and an option for remote monitoring.

A fueling station involving photovoltaic solar panels opened in Las Vegas, Nevada, in April 2007 to demonstrate the viability of fuel cell technology in a hot, dry climate. Additional FuelGen systems are currently in operation in White Plains, New York, Hempstead, New York, Charleston, West Virginia, and Rolla, Missouri.



*Proton Energy Systems' FuelGen 65 Hydrogen Fueling Station*



*FuelGen Station in Las Vegas, NV*

## Technology History

- ◆ Developed by Proton Energy Systems, Inc., in partnership with EVermont.
- ◆ Commercially available from Proton Energy Systems, Inc., since 2007.
- ◆ Sold six units since 2007, with five units currently in operation.

## Applications

Can be used to generate compressed hydrogen gas by splitting water (electrolysis) and takes advantage of renewable power sources such as wind and solar. The hydrogen is intended to displace traditional fuels such as gasoline as a motor fuel and replace it with hydrogen as a fuel.

## Capabilities

- ◆ Generates over 13 kg/day of hydrogen at up to 400 psi.
- ◆ Produces 99.999% purity hydrogen.
- ◆ Uses a power conservation mode during standby.

## Benefits Purity

Consistently produces 99.999% pure hydrogen without the need for additional cleanup of the hydrogen and via the same PEM technology used in the original equipment manufacturer automotive fuel cells.

## Simplicity

Installs and operates in a day with as little as 4 hours of maintenance per year.

## Sustainability

Creates transportation energy in a localized, decentralized, and sustainable manner and allows wind or solar energy to be used to produce the hydrogen.

### Contact Information:

**Mark Schiller**

Email: [mschiller@protononsite.com](mailto:mschiller@protononsite.com)

Phone: (203) 678-2185

**Proton Energy Systems, Inc.**

10 Technology Drive

Wallingford, CT 06111

Website: <http://www.protononsite.com>

# H2 ProGen: A Total Supply Solution for Hydrogen Vehicles

Commercial Technology

## Integrated, On-Site Hydrogen Generation/Dispensing Station Allows Hydrogen Fueling at Reduced Cost

The H2 ProGen System is an integrated, on-site hydrogen generation and dispensing system that provides a “turn-key” hydrogen infrastructure solution. Gas Technology Institute (GTI), working with GreenField Compression (a brand within the Atlas Copco Group), developed the system to include hydrogen generation, purification, compression, storage, and dispensing. The system was developed with funding from the U.S. Department of Energy’s Fuel Cell Technologies (FCT) Program.

The first installation of the integrated system is at the University of Texas, Center for Electro Mechanics in Austin, Texas. The H2 ProGen hydrogen fueling station is skid-mounted, fabricated, and tested in the manufacturing plant, then delivered as a completed system to the site. It can be readily deployed with quick connection to water, gas, and electric utilities to easily provide on-site hydrogen production, storage, and dispensing. Natural gas is anticipated to be the most common feedstock for on-site hydrogen generation, but the GTI-developed reformer system can also use ethanol (E-85), biodiesel, and other renewable fuels to produce hydrogen. GTI and GreenField have also designed the system to use an electrolyzer for hydrogen generation.

GreenField’s G1E or G2E is a separate hydrogen dispenser that can be purchased individually or as part of the packaged system. The dispenser has integrated cascade storage sequencing valves, a precision mass flow meter, and a patented algorithm for achieving full fill performance without requiring a vehicle communications link. The dispenser relies on the GTI-developed and patented HydroFill™ technology. The dispenser is designed to service high-pressure, compressed-hydrogen vehicles. The core dispenser is based on a derivative of a Gilbarco gasoline dispenser and benefits from an ability to interface with commercial point-of-sale management systems.



*H2 ProGen Hydrogen Dispensing Station*



*H2 ProGen Unit in Transit*

## Technology History

- ◆ Developed by GTI and marketed by GreenField Compression (a brand within the Atlas Copco Group).
- ◆ Became commercially available in 2007 with one fuel station in use at the University of Texas in Austin.

## Applications

Can be used as a hydrogen supply station for all hydrogen-fueled vehicles that require high-pressure compressed hydrogen such as cars, trucks, buses, and industrial lift vehicles.

## Capabilities

- ◆ Produces hydrogen by reformation of hydrocarbon fuels such as natural gas, propane, ethanol, biodiesel, or Fischer-Tropsch liquids.
- ◆ Compresses and stores hydrogen in an on-board storage assembly.
- ◆ Produces and delivers 20 to 200 kg of hydrogen per day.

## Benefits

### Cost Savings

Integrates the key hydrogen station components at the factory into the H2 ProGen system, greatly reducing site engineering and construction costs.

### Emissions Reductions

Reduces emissions compared with trucked-in liquid or gaseous hydrogen and grid-supplied electrolyzer-based systems.

### Energy Savings

Achieves full-cycle energy savings compared with trucked-in liquid or gaseous hydrogen and electrolyzer-based systems.

#### Contact Information:

**Scott Zepp**

Email: [scott.zepp@us.atlascopco.com](mailto:scott.zepp@us.atlascopco.com)

Phone: (972) 889-2400

**GreenField Compression**

909 North Bowser Road

Richardson, TX 75081

Website: <http://www.greenfield-group.com>



# High-Efficiency, High-Pressure Electrolysis via Photovoltaic Arrays

Commercial Technology

## Flexible, Innovative Hydrogen Production System Uses Renewable Power to Reduce Emissions and Costs

Producing hydrogen from renewable energy sources, such as solar and wind in distributed generation applications, provides an environmentally preferable option for the sustainable delivery of fuel-grade hydrogen. However, to gain commercial acceptance, the hydrogen generation systems must be reliable and cost-effective to deploy. Eliminating the complex and high maintenance mechanical compressor used to supply high-pressure hydrogen to the point-of-use is recognized as a significant goal in improving the reliability and cost position of hydrogen generating systems.

Avalence, LLC, with support from the U.S. Department of Energy's Fuel Cell Technologies (FCT) Program, developed an innovative hydrogen generating system that links a photovoltaic power supply to an ultra-high-pressure electrolysis unit that can generate fuel-grade hydrogen at pressures consistent with point-of-use storage and delivery (5,000 to 10,000 psig). With the electrolysis cell producing fuel at delivery pressure, the need for additional mechanical compression is eliminated.

With several commercially installed and operational units, current work is building on previous research, development, and design efforts for units running at various pressures. With engineering and design flexibility, additional units are being built to custom specifications required by customers. Continuing product development is centered on detailed component analysis and parametric testing to determine production efficiencies with varying light conditions and electrolyzer cell configurations so that findings may be incorporated into future operating hydrogen production systems.



*The Avalence Electrolysis Unit with Photovoltaic Array*

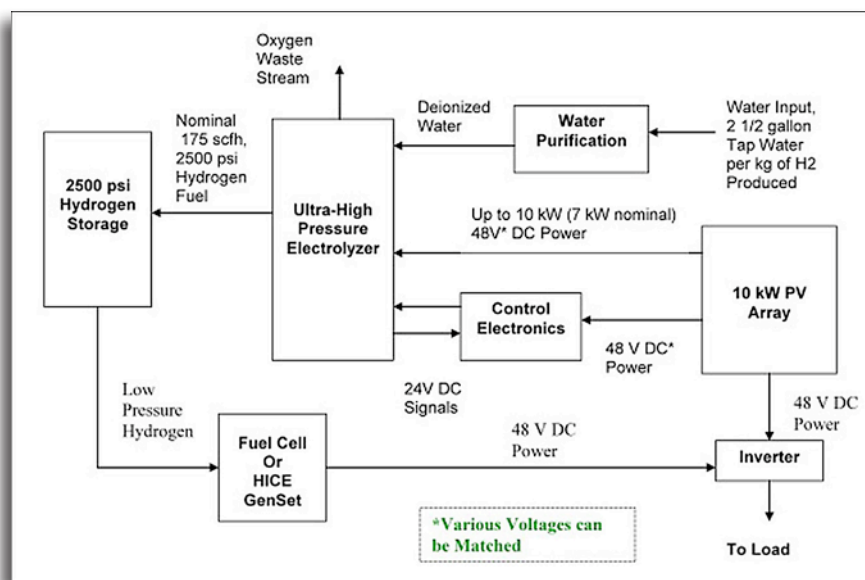

*Avalence Solar Energy Electrolysis Schematic*

## Technology History

- ◆ Developed and being marketed by Avalence, LLC; commercialized in 2007, with 8 units sold and operating in the field and more in production.

## Applications

Can be used to generate and deliver high-pressure hydrogen (over 5,000 psig) and can be coupled to a renewable energy generating source such as photovoltaic arrays.

## Capabilities

- ◆ Generates and delivers high-pressure hydrogen without additional compression.
- ◆ Can deliver 1 to 30 kg/day of hydrogen, with models up to 300 kg/day in development.

## Benefits

### Cost Savings

Cuts the point-of-use cost of hydrogen production up to 50% and operating expenses by 20%.

### Environmental

Provides flexible integration with renewable energy sources, which increases the use of "green" power, and provides an emission-free platform for hydrogen generation.

**Contact Information:**  
**Martin Shimko**  
 Email: [mas@avalence.com](mailto:mas@avalence.com)  
 Phone: (203) 701-0052  
**Avalence, LLC**  
 1240 Oronoque Road  
 Milford, CT 06460  
 Website: <http://www.avalence.com>

# Hydrogen Distributed Production System

## New Hydrogen Generation Module Reduces Production and Fuel Costs at Increased Capacities

One of the primary barriers to introducing hydrogen-fueled vehicles is the high cost of delivering hydrogen from production sites to vehicle refueling stations. Pipeline transportation requires an expensive, large-scale infrastructure. Liquid or compressed hydrogen delivered to a site via truck also comes with high transportation costs. H<sub>2</sub>Gen Innovations, Inc., with support from the U.S. Department of Energy's Fuel Cell Technologies (FCT) Program, developed compact steam methane reformers to address many of the acknowledged technical barriers that exist in the hydrogen production marketplace. On-site production of hydrogen eliminates transportation costs and enables end-users to directly control their hydrogen supply.

H<sub>2</sub>Gen built and installed over 40 commercial hydrogen generation module (HGM) steam methane reformers with capacities from 113 kg/day (2,000 scfh HGM-2000 model) to 565 kg/day (10,000 scfh HGM-10000 model). The units, which have a built-in pressure swing adsorption (PSA) system, will enable hydrogen-powered vehicles to be introduced when and where they are needed. The HGM eliminates the need to develop a national-scale hydrogen delivery infrastructure before sufficient fuel cell vehicles are on the road. One HGM-2000 can supply up to 160 fuel cell vehicles or three to four fuel cell buses. In addition to providing a feasible method for producing hydrogen for fuel cell vehicles, the HGM is also a cost-effective solution for the high-purity hydrogen needs of the industrial gas, chemical processing, pharmaceutical, and electronics industries.

At the end of 2009, H<sub>2</sub>Gen sold its technology to Air Liquide, one of the world's leading industrial gas companies. Air Liquide provides bulk gases and related services to a diverse base of customers, including those in the chemical, food, pharmaceutical, metals, and automotive industries. Air Liquide will continue to offer on-site hydrogen solutions based on H<sub>2</sub>Gen's technology.

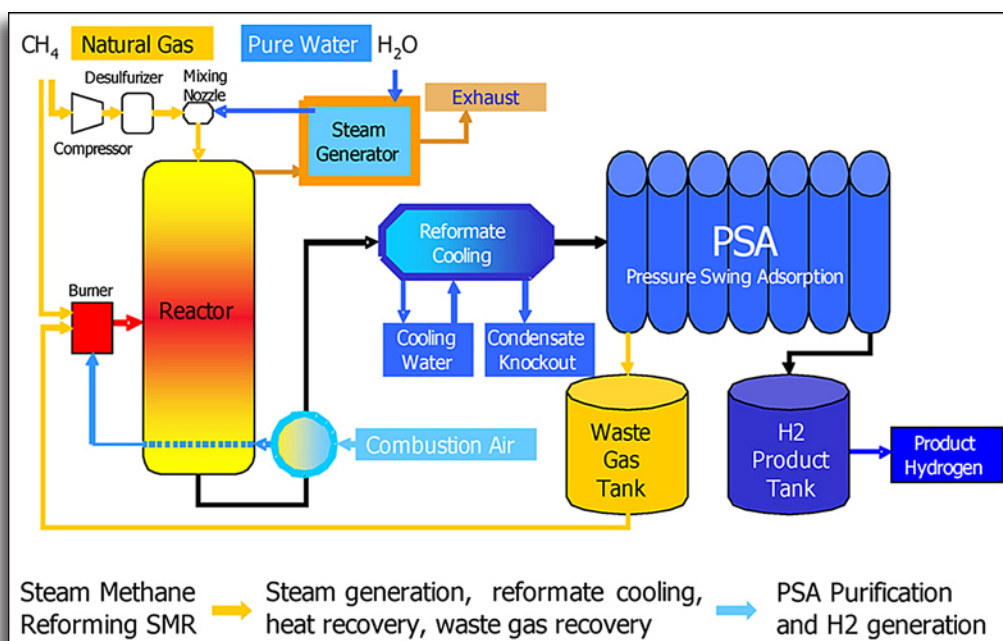

Components of the HGM-10000



*HGM-10000 Unit*

## Technology History

- ◆ Developed and launched in 2008 by H<sub>2</sub>Gen Innovations, Inc., in partnership with Süd Chemie, Inc.
- ◆ Acquired by Air Liquide in December 2009.

## Applications

Can be used where high purity hydrogen is required, including industrial gas, chemical processing, pharmaceuticals, electronics, hydrogen energy, and automotive systems.

## Capabilities

- ◆ Achieves fuel efficiency of up to 73% high heating value and provides up to 99.999% pure hydrogen.
- ◆ Produces a 200 or 300 psig hydrogen product and allows remote monitoring without the need for staffing.

## Benefits

### Increased Capacity

Has five times the capacity of the previous HGM-2000 model.

### Modular Design

Allows hydrogen-powered vehicles to be introduced when and where they are needed and eliminates the need for large-scale hydrogen infrastructure for vehicle fueling.

### Production Cost Savings

Cuts the cost of producing high purity hydrogen by up to 50% compared with trucking in either liquid or compressed hydrogen.

#### Contact Information:

**Udo Dengel**

Email: [udo.dengel@airliquide.com](mailto:udo.dengel@airliquide.com)

Phone: (703) 647-5040

**Air Liquide Process and Construction**

500 Montgomery Ave. Suite 400

Alexandria, VA 22314

Website: <http://www.us.airliquide.com>

# Hydrogen Generation from Electrolysis

Commercial Technology

## New PEM-Based Electrolysis System Reduces the Cost and Increases the Efficiency of Hydrogen Generation

While the technology of using electricity to produce high purity hydrogen and oxygen from water has been available for many years, bringing to the market a product that uses the technology has been challenging. Proton Energy Systems, Inc., with funding from the U.S. Department of Energy's Fuel Cell Technologies (FCT) Program, took advantage of the polymer electrolyte membrane (PEM) used in many fuel cell applications to reduce the cost and increase efficiency to make the hydrogen generation process practical.

As a result of this research, Proton Energy Systems developed the HOGEN<sup>®</sup> S series of hydrogen generators that was commercialized in 1999. The HOGEN S meets hydrogen requirements of 20 to 40 SCF/hr or 24 to 48 grams/hr. After further funding from the FCT Program, Proton Energy Systems developed and commercialized the HOGEN H series in 2004. The HOGEN H series has an output capacity of 76 to 229 SCF/hr or 90 to 275 grams/hr.

Through 2010 over 1300 HOGEN systems have been commercialized worldwide. The HOGEN systems are installed in applications ranging from power plant turbine generator cooling, to heat treating, to meteorological applications. These systems have uptime availability of better than 99.9%.



*The Proton Energy Systems' Hogen S Series*



## Technology History

- ◆ Developed and marketed by Proton Energy Systems, Inc.
- ◆ Commercialized the HOGEN S series in 1999 and the HOGEN H series in 2004.
- ◆ Through 2010, sold 177 HOGEN S series units in the United States and 213 internationally and 78 HOGEN H series units in the United States and 76 internationally.

## Applications

Can be used to generate hydrogen that can be used for vehicle fueling, including forklifts, as well as electrical generator cooling and materials processing.

## Capabilities

- ◆ Takes potable water and electricity and produces high-purity hydrogen and oxygen with no other byproducts.
- ◆ Produces no pollutant output if the electricity is attained from renewable sources.
- ◆ Produces hydrogen at up to 400 psi without mechanical compression at a purity of 99.999%.

## Benefits

### Ease of Integration

Provides very compact and easy-to-integrate systems with fueling balance of plant and systems start-up in one day.

### Efficiency

Produces high purity hydrogen for fuel cells that exceeds fuel specifications.

### Environmental

Eliminates gas scrubbers, gas conditioners, and the potential for chemical contamination downstream because PEM electrolysis has no liquid electrolyte.

**Contact Information:****Mark Schiller***Email:* [mschiller@protononsite.com](mailto:mschiller@protononsite.com)*Phone:* (203) 678-2185**Proton Energy Systems, Inc.**

10 Technology Drive

Wallingford, CT 06492

**Website:** <http://www.protononsite.com>

# Hydrogen Safety Sensor for Advanced Energy Applications

Commercial Technology

## Robust, Fast-Responding Ceramic-Based Sensor Reliably Detects Hydrogen over Widely Varying Ambient Conditions

With the anticipated growth of the hydrogen sensor market for advanced energy applications, several hydrogen sensor technologies have emerged. However, no single technology meets the key requirements of the advanced energy community. Most commercial sensors suffer from cross-sensitivity to gases such as carbon monoxide and methane, have slow recovery times, drift over time, or are cost prohibitive. A hydrogen sensor is needed that can operate in a wide variety of other gases without false readings, is stable, and can be mass-produced to reduce costs. Such a sensor would have wide-scale implementation in any application requiring the safe use or handling of hydrogen gas.

To meet these requirements, NexTech Materials, Ltd., with funding from the U.S. Department of Energy's Fuel Cell Technologies (FCT) Program (through the Edison Materials Technology Center) and the Ohio Third Frontier Program, has developed a new hydrogen sensor, the SenseH<sub>2</sub><sup>TM</sup>. Designed for hydrogen monitoring, the sensor is a turn-key solution for many applications. It includes a patent pending chemi-resistive ceramic sensor element, electronic controls, and an electronic signal output that is calibrated to measure hydrogen content in air, by providing a voltage output corresponding to 0 to 100% of the lower flammability limit. It offers a unique combination of features: high selectivity to hydrogen over other combustible gases and volatile organic compounds, rapid response and recovery, insensitivity to humidity, and linear and repeatable output corresponding to a broad range of hydrogen concentrations. Many commercially available hydrogen sensors suffer from a strong dependence of gas flow rate on sensor output. Sensors designed for static environments overestimate hydrogen concentration in flow environments, yielding costly false-positive responses. Those designed for gas flow streams dangerously underestimate hydrogen concentration in lower flow rate or static conditions. Modifying the sensor and packaging controls, NexTech has dramatically reduced the flow sensitivity of the SenseH<sub>2</sub> to provide an accurate and stable measurement of hydrogen over a wide range of flow conditions.

The SenseH<sub>2</sub>, which made its debut at the Fuel Cell Expo in Japan in March 2010, is being commercialized by NTM Sensors, a newly created division of NexTech Materials. NTM Sensors intends to introduce several new products aimed at reduction of greenhouse gas and polluting emissions.



*NexTech's SenseH<sub>2</sub> Hydrogen Sensor*

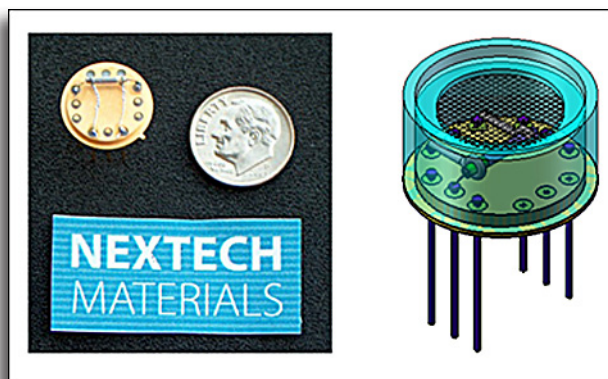

*Ceramic Sensor Element used in the SenseH<sub>2</sub>*

## Technology History

- ◆ Developed by NexTech Materials, Ltd., beginning in May 2005.
- ◆ Commercialized in March 2010 and being marketed by NexTech Materials as the SenseH<sub>2</sub>.

## Applications

Can be used to detect hydrogen for the safe handling and implementation of hydrogen among fuel cell developers and electrolysis system developers and at distribution points in the emerging hydrogen infrastructure. The sensor also has applicability in many existing markets, including battery monitoring, semiconductor manufacturing, and laboratory safety monitoring.

## Capabilities

- ◆ Detects the presence of hydrogen in air at concentrations from 0.2-4% H<sub>2</sub> in air, even under widely varying temperature and humidity conditions.
- ◆ Selectively measures hydrogen in the presence of carbon monoxide, methane, and volatile organic compounds.
- ◆ Responds and recovers rapidly, enabling measurement of transient leaks without false positives or signal saturation.

## Benefits

### Cost Savings

Offers low materials and fabrication cost at high production volumes.

### Performance

Provides durability and reliability with fast response and recovery times.

### Versatility

Accurately measures hydrogen over a wide concentration range, even in widely varying application conditions.

#### Contact Information:

**Dr. Lora Thrun**

Email: [l.thrun@nexttechmaterials.com](mailto:l.thrun@nexttechmaterials.com)

Phone: (614) 842-6606 x129

**NexTech Materials, Ltd.**

404 Enterprise Dr.

Lewis Center, OH 43035

Website: <http://www.ntmsensors.com>



# ME100 Methanol Reforming Hydrogen Generator

Commercial Technology

## Hydrogen Generator System Provides High Purity Hydrogen Quietly and Reliably for Remote and Mobile Uses

Fuel cells are an attractive way to provide quiet, efficient electricity to remote and mobile users. REB Research & Consulting's ME100 hydrogen generator answers the need for efficient and effective delivery of high-purity hydrogen to the fuel cell. On-site hydrogen generation from methanol is far more cost effective than delivered hydrogen and more practical than hydrogen produced any other way. Further, the hydrogen purity remains high, even during startup and after a variable load.

REB developed the membranes used in hydrogen generation reactors with support from the U.S. Department of Energy's Fuel Cell Technologies (FCT) Program and a grant from the Small Business Innovation Research (SBIR) Program. REB designed and developed a unique form of membrane reactor steam reformer that allows easy heat transfer so that quantities of high purity hydrogen could be generated in a small volume process by reforming methanol and water. Ordinary shift catalysts are used to convert methanol to hydrogen, and while the hydrogen is formed, it is extracted and purified through palladium-coated metal membranes within the reaction zone. By removing hydrogen, the conversion reaction is driven to completion far faster and in a much smaller volume, increasing the effective catalyst activity and thermodynamic equilibrium as a result of increasing the reactant concentration and residence time.

Because the membranes are 100% selective to hydrogen, the REB hydrogen generator can ensure very high hydrogen purity independent of back-pressure changes caused by varying fuel cell demand. Both hydrogen delivery pressure and flow can self-adjust to accommodate fuel cell load almost instantaneously.



*The ME100 Generator System*

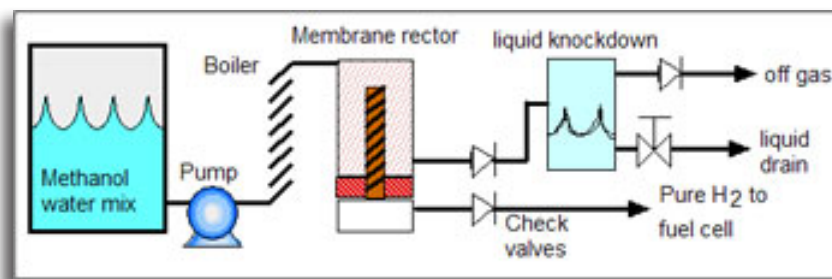

*Schematic of ME100 Reactor and Flows*

## Technology History

- ◆ Developed and marketed by REB Research & Consulting to provide improved delivery of high-purity hydrogen.
- ◆ Sold more than 350 hydrogen membrane reactors since 2002.
- ◆ Sold more than 15 ME100 hydrogen generator systems since 2002.

## Applications

Can be used to make ultrapure hydrogen from methanol reforming and where high purity hydrogen is required.

## Capabilities

- ◆ Produces very high purity hydrogen (99.99995% pure) at a cost far lower than bottled gas.
- ◆ Delivers continuous hydrogen output at a variable rate of up to 10 kg per day and at pressures up to 40 psig.

## Benefits Efficiency

Uses readily available methanol feedstock for hydrogen generation at a power density consistent with bottled hydrogen.

## Flexibility

Demonstrates fuel cell load following characteristics while maintaining high hydrogen purity.

## Versatility/Safety

Provides quiet, reliable hydrogen generation that can be developed in remote and mobile applications where size and weight are a premium. Is safer and lighter than hydrogen bottles, eliminating the need for hydrogen inventory.

### Contact Information:

**Robert Buxbaum**

Email: [buxbaum@rebresearch.com](mailto:buxbaum@rebresearch.com)

Phone: (248) 545-0155

**REB Research & Consulting**

3259 Hilton Rd.

Ferndale, MI 48220

Website: <http://www.rebresearch.com>

# Membrane Structures for Hydrogen Separation

Commercial Technology

## New, Low-Cost Membranes Supply Ultra-Pure Hydrogen for Fuel Cells

Achieving a hydrogen economy requires new devices and technology. One of the devices needed is a hydrogen purifier to separate hydrogen from other gases. Purifiers have three basic requirements: mechanical support of a thin membrane, effective sealing, and pore-free membranes. Existing designs can often provide two out of the three requirements, but achieving all three is very difficult, particularly at low cost. Because existing purifiers are expensive and mechanically fragile, incorporating them into devices, such as reformers to produce hydrogen, increases the overall cost and decreases the reliability of the complete system.

A low-cost membrane to separate hydrogen is needed. The membrane is the portion of the purification system that separates mixed gases from the desired purified hydrogen gas. These gases are under pressure, so the membrane needs to be both mechanically robust and free of pores. Its architecture needs to allow for effective sealing and membrane support to create a low-cost purifier module.

Genesis Fueltech, Inc., with the help of DOE SBIR grants, is developing a thin, pore-free membrane to be used in a purifier module. The planar architecture will allow for scaling to larger sizes to increase the capacity while maintaining the low-cost design features. Genesis Fueltech has refined the design for improved mechanical support, sealing, and other processing steps and includes improved alloys for higher hydrogen flux.



*Genesis Fueltech's Model 20L Reformers*

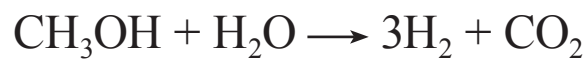

*Methanol Reforming Reaction*

## Technology History

- ◆ Developed by Genesis Fueltech, Inc., starting in 2005.
- ◆ Conducting ongoing testing.
- ◆ Commercialized the product in 2009.

## Applications

Can be used to nondestructively test high-pressure hydrogen cylinders for vehicles powered by fuel cells.

## Capabilities

- ◆ Maintains higher hydrogen output than existing conventional units.
- ◆ Handles mechanical stress without failure.
- ◆ Achieves high manufacturing rates.

## Benefits

### Cost Savings

Allows purifiers using these membranes to be an order of magnitude less expensive than conventional units.

### Productivity

Can scale existing designs for industrial applications.

#### Contact Information:

**David DeVries**

Email: [david@genesisfueltech.com](mailto:david@genesisfueltech.com)

Phone: (509) 534-5787

**Genesis Fueltech, Inc.**

528 S. Cannon

Spokane, WA 99201

Website: <http://www.genesisfueltech.com>

# Nanoscale Water Gas Shift Catalysts

Commercial Technology

## New Catalysts Operate at High Temperatures and Activity Levels, Improving Fuel Processor Performance

NexTech Materials, Ltd., established synthesis processes for preparing highly active water gas shift (WGS) catalysts based on ceria-supported precious metals using funding provided in part by the U.S. Department of Energy's Fuel Cell Technologies (FCT) Program. The primary advantages of the WGS catalysts are their high activity, nonpyrophoric nature, and capability to operate over a wide temperature range. NexTech has extended the synthesis processes to a family of ceria-based catalysts that are useful for several important fuel-processing reactions.

Improved catalysts are required for a number of fuel cell and distributed hydrogen production applications. High activity ceria-based catalysts are being used for applications where small reactor size and/or multiple startup/shutdown cycles are important requirements. The ceria-based catalysts are prepared from nanoscale ceria-based mixed oxides using synthesis methods that provide exceptionally high dispersion of catalytic metals. By varying the catalyst synthesis conditions and the specific catalytic metals, the activity of these ceria-based catalysts are tailored for specific reactions and operating temperatures, depending on customer requirements. Two grades of WGS catalyst formulations are available, one for higher-temperature WGS reactions (350°C to 450°C) and one for lower-temperature WGS reactions (250°C to 350°C). NexTech began selling these catalysts commercially in 2005 and continues development work to improve functionality, increase durability, and reduce cost.

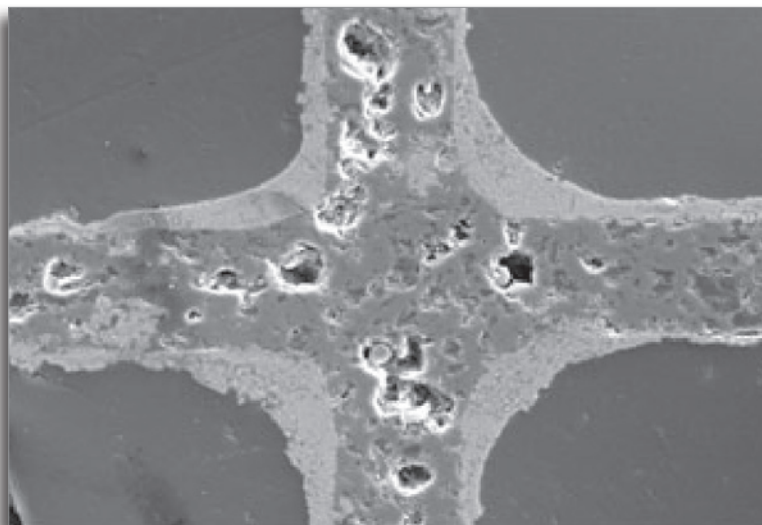

*Micrograph of a Washcoated Pt/Ceria Catalyst Layer on a Cordierite Monolith*

## Technology History

- ◆ Developed and commercialized by NexTech Materials, Ltd.
- ◆ Became commercial in 2005 with more than \$300,000 in sales to date.

## Applications

Can be used in fuel processing systems for polymer electrolyte membrane fuel cells, reforming reactors for solid oxide fuel cells, and hydrogen production systems.

## Capabilities

- ◆ Has high activity that allows WGS reactions.
- ◆ Can be used for steam reforming of methane, diesel, and ethanol.
- ◆ Enables the catalytic partial oxidation of methane and other hydrocarbons.

## Benefits

### Efficiency

Can perform at high activity over wide temperature ranges.

### Versatility

Can be tailored for specific reactions and operating temperatures, depending on customer requirements, and are available in multiple forms (e.g., pellets and monoliths).

**Contact Information:****Scott L. Swartz***Email:* [s.swartz@nextechmaterials.com](mailto:s.swartz@nextechmaterials.com)*Phone:* (614) 842-6606 x 103**NexTech Materials, Ltd.**

404 Enterprise Dr.

Lewis Center, OH 43035

**Website:** <http://www.nextechmaterials.com>



# PEM Electrolyzer Incorporating an Advanced Low-Cost Membrane

Commercial Technology

## New Technology Enables Low-Cost Distributed Hydrogen Production

Hydrogen production by electrolysis (splitting water with an electric current) is an attractive technology because of its ability to be used in on-site applications, eliminating the need to transport hydrogen to end-use sites via pipelines or tube trailers. Electrolysis systems can be used in many industrial sector applications where hydrogen is needed, such as steel annealing, chemical production, and microchip manufacturing. Electric utilities can also use electrolysis to generate hydrogen for generator cooling and as an energy storage mechanism for intermittent renewable energy (e.g., wind) generation that occurs during periods of low demand. Electrolysis has also been identified as a key technology for enabling the adoption of fuel cell vehicles. However, the high capital cost of current electrolyzers remains a significant barrier to widespread adoption of this technology.

With assistance from the U.S. Department of Energy's Fuel Cell Technologies Program, Giner Electrochemical Systems (GES), LLC, has developed proton exchange membrane (PEM)-based electrolyzer technologies that improve electrolyzer efficiency and reduce capital costs. GES developed an advanced dimensionally stable membrane (DSM™) with a support structure that minimizes changes in the membrane's dimensions (swelling/contraction) under high-pressure operation or changes in water content. This stability increases the membrane's durability and operational lifetime. A carbon-coated titanium cell separator (impermeable sheet that separates the hydrogen and oxygen compartments in the electrolyzer stack) was also developed that provides desirable performance (electrically conductive and resistant to hydrogen embrittlement) at a fraction of the cost of niobium/zirconium cell separators. Additional cost-reducing features of the stack include an increased cell active area, a decrease in part count per cell (from 41 to 11), a 75% reduction in catalyst loading, and the use of molded thermoplastic cell frames. These innovations have combined to reduce the capital cost of the electrolyzer stack from >\$2,500/kW in 2001 to <\$500/kW in 2010, with projections of <\$400/kW by 2012.

GES and its partner, Parker Hannifin Corporation, are currently working to assemble a full electrolyzer system that will produce 0.5 kg-H<sub>2</sub>/hr at an operating pressure of 350 psig. The system has been reviewed for safety considerations and includes a pressurized dome that encloses the electrolyzer stack for safety

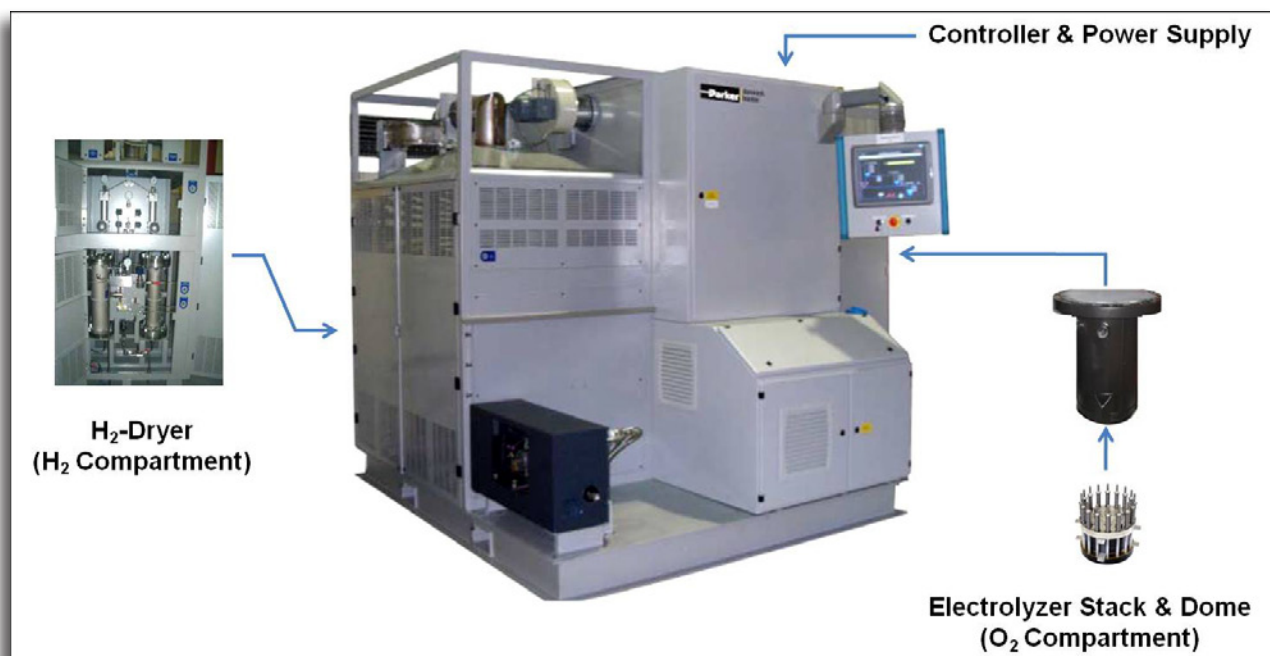

GES's PEM Electrolyzer System





*GES's Low-Cost Electrolyzer Stack*

## Technology History

- ◆ Developed and commercialized in 2011 by GES, in partnership with Parker Hannifin Corporation and the Virginia Polytechnic Institute and State University.
- ◆ Currently selling electrolyzer stacks and working to finish development of the full electrolyzer system.

## Applications

Can be used as an on-site source of hydrogen at industrial facilities, as an enabling technology for fuel cell vehicles, and as an energy storage device for renewable power generation that occurs during low demand times (e.g., wind).

## Capabilities

- ◆ Produces 0.5 kg-H<sub>2</sub>/hr at an operating pressure of 350 psig.
- ◆ Uses a 27-cell electrolyzer stack with an active area of 290 cm<sup>2</sup> per cell.

## Benefits

### Cost Savings

Reduces electrolyzer stack capital cost by using low-cost materials, lower catalyst loading, and a reduced part count per cell.

### Durability

Uses components with long operating lifetimes (estimated at 55,000 hours for the DSM and >60,000 hours for the carbon/titanium cell separators).

#### Contact Information:

**Monjid Hamdan**

Email: [mhamdan@ginerinc.com](mailto:mhamdan@ginerinc.com)

Phone: (781) 529-0526

**Giner Electrochemical Systems, LLC**

89 Rumford Avenue

Newton, MA 02466

Website: <http://www.ginerinc.com>



<b>D.3 Storage Technologies</b> .....	D-61
◆ <u>Hydrogen Composite Tanks</u> .....	D-62
◆ <u>Non-Destructive Ultrasonic Scanning Technology</u> .....	D-64

# Hydrogen Composite Tanks

Commercial Technology

## Lightweight, All-Composite Tank Improves the Range of Hydrogen-Powered Fuel Cell Vehicles

Previous approaches to hydrogen storage have included compression (3,600 psi), liquefaction, chemical storage, metal hydride storage, and adsorption. While each storage method has positive attributes, no single approach has effectively addressed the multiple requirements for transportation use. These requirements include energy density, size, weight, cost, durability and strict safety related items.

Quantum Fuel Systems Technologies Worldwide, Inc., in cooperation with the U.S. Department of Energy's Fuel Cell Technologies (FCT) Program, designed, manufactured, and validated hydrogen fuel tanks and hydrogen fuel delivery systems running at 5,000 and 10,000 psig. The TriShield™ cylinder is comprised of a seamless, one-piece, permeation-resistant, cross-linked, ultra-high molecular weight polymer liner that is overwrapped with multiple layers of carbon fiber/epoxy laminate and a proprietary external protective layer for impact resistance.

While the initial tanks have been a commercial success, Quantum continues to optimize the design with the aim of decreasing tank cost while maintaining structural performance. Current commercially available products use premium-grade materials to support challenging structural requirements for burst pressure. These materials require special design features and complex manufacturing techniques, which increase both the time of fabrication and the overall expense of the system. In order to meet the goals set for tank optimization, the following tasks are being performed: (1) liner material and design development, (2) metal fitting material and design development, and (3) carbon fiber optimization through manufacturing process evaluations and composite fiber translation improvements.



*Quantum's Hydrogen Storage System*

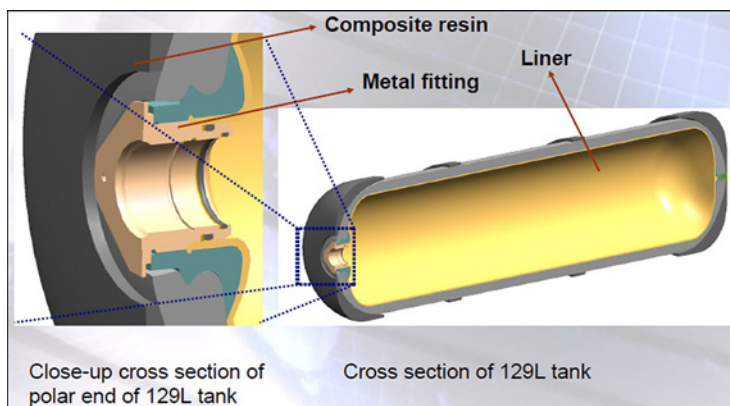

*Quantum Technologies' Optimized 129L Tank*

## Technology History

- ◆ Developed by Quantum Fuel Systems Technologies Worldwide, Inc., and commercially offered in 2001.
- ◆ Sold more than 2,000 storage tank systems, primarily to major automobile manufacturers.
- ◆ Optimizing tank design to achieve safety and structural performance targets while reducing cost, weight, and size.

## Applications

Can be used for compressed hydrogen fuel storage applications at 5,000 and 10,000 psig (700 bar).

## Capabilities

- ◆ Increases a vehicle's driving range by more than 55% compared with equivalent-sized storage tanks at 5,000 psig.
- ◆ Increases the safety and reliability of hydrogen storage and fuel delivery systems, exceeding current regulatory qualification requirements.

## Benefits Capacity

Offers high capacity, lightweight and fully validated high-pressure hydrogen storage systems that have been field proven under real world conditions.

## Cost Effectiveness

Optimized tank designs reduce system expense by using cost-competitive materials with high structural integrity.

## Product Quality

Designed and manufactured to strict automotive and high-pressure safety standards, reduces the potential for hydrogen embrittlement in the presence of high-pressure hydrogen, as is the case with metal-lined alternative technologies.

### Contact Information:

**Elton Rohrer**

Email: [erohrer@qtw.com](mailto:erohrer@qtw.com)

Phone: (949) 399-4586

**Quantum Technologies, Inc.**

17872 Cartwright Road

Irvine, CA 92614

Website: <http://www.qtw.com>

# Non-Destructive Ultrasonic Scanning Technology

Commercial Technology

## Innovative System Allows Rapid and Accurate Testing of High-Pressure Hydrogen Cylinders

One of the main components of an automobile powered by fuel cells is the hydrogen storage system. A large amount of hydrogen storage is needed to generate the power and range for an automobile. Currently, large amounts of hydrogen are stored by using high-pressure cylinders operating at 12,000 psi or more. This large amount of flammable hydrogen stored at this high pressure could become dangerous if the cylinder had flaws that could allow a catastrophic release. Therefore, it is critical that hydrogen cylinders meet stringent Department of Transportation safety targets before they are used in automobiles.

Meeting these targets requires new materials and production methods. One of the most promising methods uses composite pressure vessels. These vessels could include plastic-lined composite over-wrapped pressure vessels and composite over-wrapped steel-lined pressure vessels as well as other materials such as ceramics. However, these vessels are hard to inspect with traditional ultrasound and x-rays because of the materials used in their construction. A technology is needed to inspect these new types of vessels non-destructively. Ideally, the technology should identify the location of flaws and detect a wide variety of damage types in a wide variety of materials, including metals, polymers, ceramics, and composites.

Digital Wave Corporation, with funding from the U.S. Department of Energy's Fuel Cell Technologies (FCT) Program through the National Center of Manufacturing Sciences, has developed a revolutionary non-destructive testing method that is effective on these different types of materials. By using stacked polyvinylidene film (PVDF) piezoelectric transducers in modal acoustic emission phased arrays and proprietary data analysis software, Digital Wave's ultrasonic scanning technology is adaptable to a wide range of cylinder geometries and material types while providing rapid analysis and accurate flaw location. The PVDF piezoelectric film used in the technology is inexpensive, mechanically rugged, low profile, and easily attached to the test item.



*Pressure Tank with Digital Wave's Stress Transducers Attached*

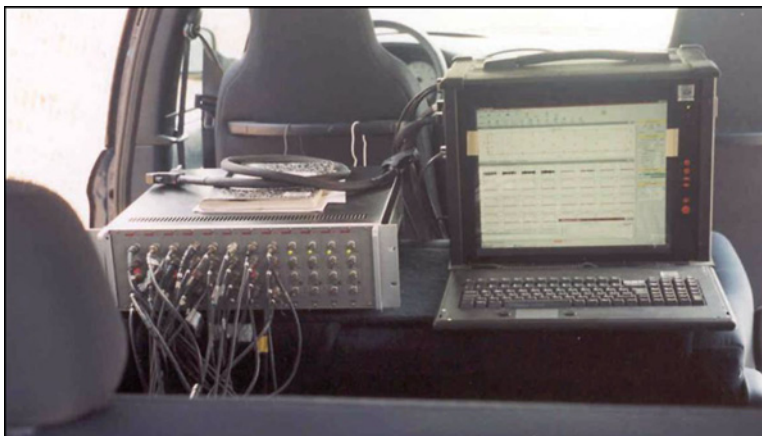

*Digital Wave's Mobile Scanning System*

## Technology History

- ◆ Began research in April 2006 and commercialized in 2008.
- ◆ Available as a stand-alone cylinder testing device or a mobile cylinder testing service provided by Digital Wave Corporation.
- ◆ Approximately 30 units in use domestically and internationally.

## Applications

Can be used to non-destructively test high-pressure hydrogen cylinders for vehicles powered by fuel cells.

## Capabilities

- ◆ Identifies location of flaws using non-destructive sound waves.
- ◆ Provides increased safety by identifying flaws prior to failure.

## Benefits

### Cost Savings

Detects flaws before they cause catastrophic failure.

### Performance

Provides rapid analysis and accurate flaw location.

### Versatility

Tests a wide range of cylinder geometries and material types.

#### Contact Information:

**Steve Ziola**

Email: [Stevezi@digitalwavecorp.com](mailto:Stevezi@digitalwavecorp.com)

Phone: (303) 790-7559

**Digital Wave Corporation**

6555 S. Kenton Street, Suite 304

Centennial, CO 80111

Website: <http://www.digitalwavecorp.com>





# Appendix E: Emerging Technology Descriptions

<b>E.1 Fuel Cell Technologies</b>	E-3
◆ <a href="#">Alternative and Durable High-Performance Cathode Supports for PEM Fuel Cells</a>	E-4
◆ <a href="#">CIRRUS: Cell Ice Regulation and Removal Upon Start-up</a>	E-5
◆ <a href="#">Dimensionally-Stable High-Performance Membrane</a>	E-6
◆ <a href="#">Direct Methanol Fuel Cell (DMFC) Anode Catalysts</a>	E-7
◆ <a href="#">Direct Methanol Fuel Cell for Handheld Electronics Applications</a>	E-8
◆ <a href="#">Direct-Write Inkjet Printing for Fabricating Hydrogen Sensors</a>	E-9
◆ <a href="#">Durable Catalysts for Fuel Cell Protection During Transient Conditions</a>	E-10
◆ <a href="#">Engineered Nanostructured MEA Technology for Low-Temperature Fuel Cells</a>	E-11
◆ <a href="#">Extended Continuous Pt Nanostructures in Thick, Dispersed Electrodes</a>	E-12
◆ <a href="#">FARADAYIC ElectroEtching of Stainless Steel Bipolar Plates</a>	E-13
◆ <a href="#">Fuel Cell Membrane Measurement System for Manufacturing</a>	E-14
◆ <a href="#">Fuel-Cell-Based Mobile Lighting</a>	E-15
◆ <a href="#">GenSys® Blue: High-Temperature CHP Fuel Cell System</a>	E-16
◆ <a href="#">High-Efficiency Polymer Electrolyte Membrane Fuel Cell Combined Heat and Power System</a>	E-17
◆ <a href="#">High-Performance, Low-Pt Cathodes Containing New Catalysts and Layer Structure</a>	E-18
◆ <a href="#">High-Temperature Membrane with Humidification-Independent Cluster Structure</a>	E-19
◆ <a href="#">Improved Low-Cost, Durable Fuel Cell Membranes</a>	E-20
◆ <a href="#">Low-Cost 3-10 kW Tubular SOFC Power System</a>	E-21
◆ <a href="#">Low-Cost Hydrogen Sensor for Transportation Safety</a>	E-22
◆ <a href="#">Low-Cost Manufacturing of Sheet Molding Compound Bipolar Plates for PEM Fuel Cells</a>	E-23
◆ <a href="#">Low Platinum Loading Fuel Cell Electrocatalysts</a>	E-24
◆ <a href="#">Manufacturing of Low-Cost, Durable Membrane Electrode Assemblies</a>	E-25
◆ <a href="#">Materials and Modules for Low-Cost, High-Performance Fuel Cell Humidifiers</a>	E-26
◆ <a href="#">Multi-Fuel Solid Oxide Fuel Cell (SOFC) System</a>	E-27
◆ <a href="#">Nitrided Metallic Bipolar Plates for PEM Fuel Cells</a>	E-28
◆ <a href="#">Platinum and Fluoropolymer Recovery From PEM Fuel Cells</a>	E-29
◆ <a href="#">Platinum-Group-Metal Recycling Technology</a>	E-30
◆ <a href="#">Platinum Monolayer Electrocatalysts on Stable Low-Cost Supports</a>	E-31
◆ <a href="#">Polymer Electrolyte Membrane (PEM) Fuel Cell Power Plant Development and Verification</a>	E-32
◆ <a href="#">Portable Solid Oxide Fuel Cell Generator</a>	E-33
◆ <a href="#">PowerEdge™ Fuel Cell System</a>	E-34
◆ <a href="#">Reduction in Fabrication Costs of Gas Diffusion Layers</a>	E-35
◆ <a href="#">Resin-Impregnated, Expanded-Graphite GRAFCELL® Bipolar Plates</a>	E-36
◆ <a href="#">Sensors for Automotive Fuel Cell Systems</a>	E-37
◆ <a href="#">Silicon-Based Solid Oxide Fuel Cell for Portable Consumer Electronics</a>	E-38
◆ <a href="#">Solid Acid Fuel Cell Stack for Auxiliary Power Unit Applications</a>	E-39
◆ <a href="#">Solid Oxide Fuel Cell Auxiliary Power Unit</a>	E-40
◆ <a href="#">Thermal and Water Management Systems for PEM Fuel Cells</a>	E-41

<b>E.2 Production/Delivery Technologies</b> .....	E-43
◆ <a href="#">Active Magnetic Regenerative Liquefier</a> .....	E-44
◆ <a href="#">Centrifugal Hydrogen Pipeline Gas Compressor</a> .....	E-45
◆ <a href="#">Ceramic Membrane Reactor Systems for Converting Natural Gas to Hydrogen and Synthesis Gas (ITM Syngas)</a> .....	E-46
◆ <a href="#">High Performance Palladium-Based Membrane</a> .....	E-47
◆ <a href="#">High-Pressure Hydrogen Storage Tank for Gaseous Truck Delivery</a> .....	E-48
◆ <a href="#">HRS-100™ Hydrogen Recycling System</a> .....	E-49
◆ <a href="#">Hydrogen Gas Sensing System</a> .....	E-50
◆ <a href="#">Hydrogen Generation from Biomass-Derived Carbohydrates via Aqueous-Phase Reforming</a> .....	E-51
◆ <a href="#">Hydrogen Production via a Commercially Ready Inorganic Membrane Reactor</a> .....	E-52
◆ <a href="#">Integrated Ceramic Membrane System for Hydrogen Production</a> .....	E-53
◆ <a href="#">Integrated Short Contact Time Hydrogen Generator</a> .....	E-54
◆ <a href="#">Maximizing Light Utilization Efficiency and Hydrogen Production in Microalgal Cultures</a> .....	E-55
◆ <a href="#">Nanotube Array Photocatalysts</a> .....	E-56
◆ <a href="#">Novel Catalytic Fuel Reforming</a> .....	E-57
◆ <a href="#">Novel Stackable Structural Reactor (SSR®) for Low-Cost Hydrogen Production</a> .....	E-58
◆ <a href="#">Oil Free Hydrogen Compressor</a> .....	E-59
◆ <a href="#">Photoelectrochemical Hydrogen Production</a> .....	E-60
◆ <a href="#">Renewable Electrolysis Integrated System Development and Testing</a> .....	E-61
◆ <a href="#">Reversible Liquid Carriers</a> .....	E-62

<b>E.3 Storage Technologies</b> .....	E-63
◆ <a href="#">High-Strength, Low-Cost Microballoons for Hydrogen Storage</a> .....	E-64
◆ <a href="#">Hydrogen Storage in Cryo-Compressed Vessels</a> .....	E-65
◆ <a href="#">Manufacturing Technologies for Low-Cost Hydrogen Storage Vessels</a> .....	E-66
◆ <a href="#">Rapid Manufacturing of Vehicle-Scale, Carbon-Composite, High-Pressure Hydrogen Storage Cylinders</a> .....	E-67
◆ <a href="#">Safe and Effective Storage and Transmission of Hydrogen</a> .....	E-68
◆ <a href="#">Sodium Silicide (NaSi) Hydrogen Generation System</a> .....	E-69

<b>E.1 Fuel Cell Technologies</b> .....	E-3
◆ <a href="#">Alternative and Durable High-Performance Cathode Supports for PEM Fuel Cells</a> .....	E-4
◆ <a href="#">CIRRUS: Cell Ice Regulation and Removal Upon Start-up</a> .....	E-5
◆ <a href="#">Dimensionally-Stable High-Performance Membrane</a> .....	E-6
◆ <a href="#">Direct Methanol Fuel Cell (DMFC) Anode Catalysts</a> .....	E-7
◆ <a href="#">Direct Methanol Fuel Cell for Handheld Electronics Applications</a> .....	E-8
◆ <a href="#">Direct-Write Inkjet Printing for Fabricating Hydrogen Sensors</a> .....	E-9
◆ <a href="#">Durable Catalysts for Fuel Cell Protection During Transient Conditions</a> .....	E-10
◆ <a href="#">Engineered Nanostructured MEA Technology for Low-Temperature Fuel Cells</a> .....	E-11
◆ <a href="#">Extended Continuous Pt Nanostructures in Thick, Dispersed Electrodes</a> .....	E-12
◆ <a href="#">FARADAYIC ElectroEtching of Stainless Steel Bipolar Plates</a> .....	E-13
◆ <a href="#">Fuel Cell Membrane Measurement System for Manufacturing</a> .....	E-14
◆ <a href="#">Fuel-Cell-Based Mobile Lighting</a> .....	E-15
◆ <a href="#">GenSys® Blue: High-Temperature CHP Fuel Cell System</a> .....	E-16
◆ <a href="#">High-Efficiency Polymer Electrolyte Membrane Fuel Cell Combined Heat and Power System</a> .....	E-17
◆ <a href="#">High-Performance, Low-Pt Cathodes Containing New Catalysts and Layer Structure</a> .....	E-18
◆ <a href="#">High-Temperature Membrane with Humidification-Independent Cluster Structure</a> .....	E-19
◆ <a href="#">Improved Low-Cost, Durable Fuel Cell Membranes</a> .....	E-20
◆ <a href="#">Low-Cost 3-10 kW Tubular SOFC Power System</a> .....	E-21
◆ <a href="#">Low-Cost Hydrogen Sensor for Transportation Safety</a> .....	E-22
◆ <a href="#">Low-Cost Manufacturing of Sheet Molding Compound Bipolar Plates for PEM Fuel Cells</a> .....	E-23
◆ <a href="#">Low Platinum Loading Fuel Cell Electrocatalysts</a> .....	E-24
◆ <a href="#">Manufacturing of Low-Cost, Durable Membrane Electrode Assemblies</a> .....	E-25
◆ <a href="#">Materials and Modules for Low-Cost, High-Performance Fuel Cell Humidifiers</a> .....	E-26
◆ <a href="#">Multi-Fuel Solid Oxide Fuel Cell (SOFC) System</a> .....	E-27
◆ <a href="#">Nitrided Metallic Bipolar Plates for PEM Fuel Cells</a> .....	E-28
◆ <a href="#">Platinum and Fluoropolymer Recovery From PEM Fuel Cells</a> .....	E-29
◆ <a href="#">Platinum-Group-Metal Recycling Technology</a> .....	E-30
◆ <a href="#">Platinum Monolayer Electrocatalysts on Stable Low-Cost Supports</a> .....	E-31
◆ <a href="#">Polymer Electrolyte Membrane (PEM) Fuel Cell Power Plant Development and Verification</a> .....	E-32
◆ <a href="#">Portable Solid Oxide Fuel Cell Generator</a> .....	E-33
◆ <a href="#">PowerEdge™ Fuel Cell System</a> .....	E-34
◆ <a href="#">Reduction in Fabrication Costs of Gas Diffusion Layers</a> .....	E-35
◆ <a href="#">Resin-Impregnated, Expanded-Graphite GRAFCELL® Bipolar Plates</a> .....	E-36
◆ <a href="#">Sensors for Automotive Fuel Cell Systems</a> .....	E-37
◆ <a href="#">Silicon-Based Solid Oxide Fuel Cell for Portable Consumer Electronics</a> .....	E-38
◆ <a href="#">Solid Acid Fuel Cell Stack for Auxiliary Power Unit Applications</a> .....	E-39
◆ <a href="#">Solid Oxide Fuel Cell Auxiliary Power Unit</a> .....	E-40
◆ <a href="#">Thermal and Water Management Systems for PEM Fuel Cells</a> .....	E-41

# Alternative and Durable High-Performance Cathode Supports for PEM Fuel Cells

Emerging Technology

## Conductive Metal Oxide Coating Process Produces Stable and Durable PEM Cathodes

In order for fuel cell power system technologies to become viable for transportation applications, fuel cells with increased efficiency, durability, and low material and manufacturing costs must be developed. Currently, cathodes used in proton exchange membrane (PEM) fuel cells do not have adequate durability under start/stop conditions because of their susceptibility to corrode under these transient conditions. This issue is one of the major barriers to widespread use of PEM fuel cells in transportation applications.

With assistance from the U.S. Department of Energy's Fuel Cell Technologies Program, Pacific Northwest National Laboratory (PNNL), Oak Ridge National Laboratory (ORNL), and other collaborators are developing a technology to increase the durability of cathodes for PEM fuel cells. This technology takes advantage of the stable interface between platinum (Pt), a conductive metal oxide (CMO), and a carbon support. The stable interface provides conductive carbon for electron percolation and strong Pt-CMO bonding, which prevents catalyst migration and agglomeration. Producing these cathodes with CMO-modified carbon hybrid supports involves a solvothermal reaction of carbon with metal oxide precursors, followed by Pt nanoparticle loading using a chemical reduction method. This method results in a 40% higher electrochemical surface area (ESA) than the baseline Vulcan XC-72 carbon-supported cathode and three to four times better stability. Additionally, CMO prepared by the hard template method yields a unique mesoporous crystalline structure with 95% of baseline ESA. Ongoing efforts to further optimize hybrid and CMO supports have the potential to increase durability by an order of magnitude over baseline Vulcan XC-72 carbon.

The CMOs can be applied to various carbon substrates to take advantage of the latter's superior power capabilities while significantly enhancing durability. Noncarbon supports have also been developed, and initial testing results show improving performance trends while retaining high durability. A research and development effort continues to improve the performance of both classes of materials and to retain durability.

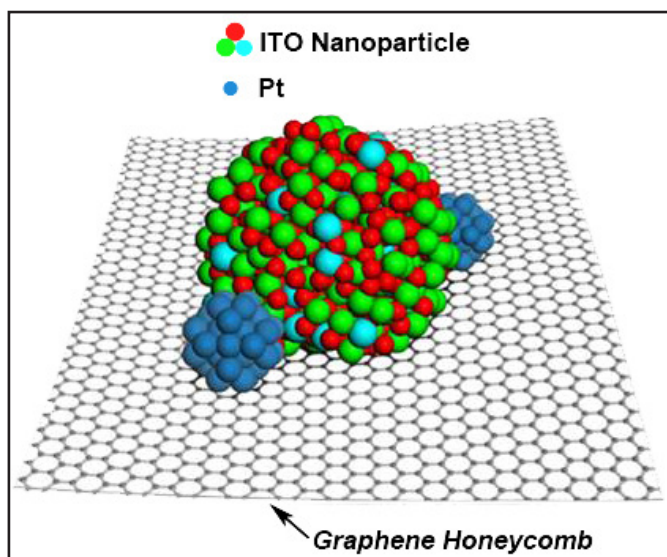

PNNL's Cathode Support Showing Triple Junction Formation

## Technology History

- ◆ Developed by PNNL, ORNL, the University of Delaware, Princeton University, and the Automotive Fuel Cell Cooperation Corporation.
- ◆ Continuing work to improve metal oxide conductivity and carbon surface coverage uniformity to increase cathode performance and durability.

## Applications

Can be used for automotive or stationary fuel cell applications.

## Capabilities

- ◆ Produces durable low carbon and noncarbon cathode catalyst supports for PEM fuel cells.
- ◆ Improves durability by three to four times compared with the Vulcan XC-72 baseline.
- ◆ Enables commercialization of transportation fuel cells.

## Benefits

### Cost Savings

Reduces material costs by using readily available, stable, and easily synthesized metal oxides.

### Durability

Improves product lifetime by preventing catalyst support corrosion and Pt agglomeration.

### Performance

Provides higher activity because of the Pt-CMO synergy.

### Scalability

Uses a wet chemistry synthesis method that is scalable to high-volume production manufacturing.

#### Contact Information:

**Dr. Yong Wang**

Email: [yong.wang@pnnl.gov](mailto:yong.wang@pnnl.gov)

Phone: (509) 371-6273

**Pacific Northwest National Laboratory**

902 Battelle Blvd., P.O. Box 999

Richland, WA 99352

Website: <http://www.pnnl.gov>

# CIRRUS: Cell Ice Regulation and Removal Upon Start-up

Emerging Technology

## New Technology Enhances Fuel Cell Operability under Subfreezing Conditions

For fuel cells to be commercially viable as powerplants in automotive applications, they must be able to survive and start reliably in cold climates (as low as  $-40^{\circ}\text{C}$ ). Polymer electrolyte membrane (PEM) fuel cells are water-based systems and therefore present a significant technical challenge. Water transport studies are imperative for achieving DOE targets for fuel cell startup time from subfreezing conditions. Operating strategies must be devised that enable the fuel cell to generate power and heat up sufficiently before ice extinguishes the galvanic reactions. At shutdown, a sufficient amount of water must be evacuated using minimal auxiliary power.

To address these technical challenges, Nuvera Fuel Cells, Inc., with FCT funding, developed novel fuel cell stack designs, coolant systems, and operational procedures that improve fuel cell performance under subfreezing conditions. Nuvera's original stack design, the Andromeda™ fuel cell, achieved DOE's targets for a quick start (30 seconds or less) from  $-20^{\circ}\text{C}$  and less than 5 MJ of energy consumption for the complete start-up and shutdown cycle. However, the thermal mass of the Andromeda prevented that stack architecture from achieving the  $-40^{\circ}\text{C}$  target. To meet the extreme low temperature start goal, Nuvera developed a new stack technology, the Orion™. The Orion exploits higher current density operation ( $1.3 \text{ A/cm}^2$ ) to increase the power density of the stack (300 W per cell) and reduce its thermal mass, enhancing freeze starting ability.

Testing with the Orion included developing an integrated coolant loop using ethylene glycol in order to more closely simulate freeze start conditions in an automotive system. The new stack design has demonstrated a successful startup to 50% of rated power in 28 seconds at  $-20^{\circ}\text{C}$  and uses less than 3 MJ of energy for a complete start-up and shutdown cycle. The advantage offered by Orion's low thermal mass has been proved through repeated successful startups from  $-40^{\circ}\text{C}$ .

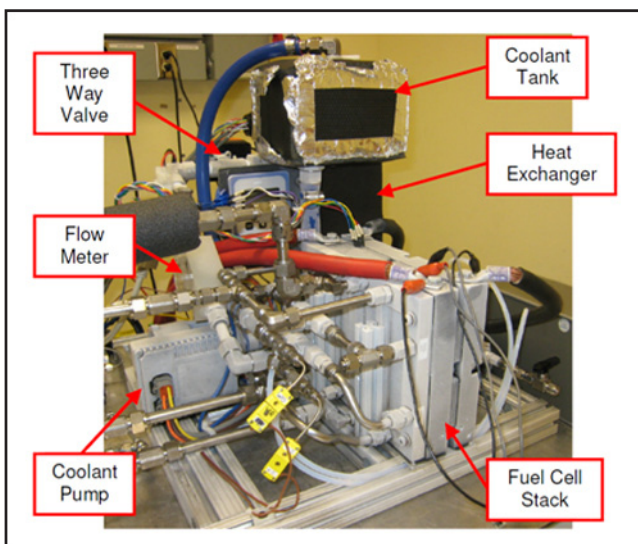

Nuvera's Test Station for Fuel Cell Freeze Start Testing

## Technology History

- ◆ Developed by Nuvera Fuel Cells, Inc., in partnership with W.L. Gore & Associates, Inc., SGL Technologies, and the University of Delaware.
- ◆ Development work successfully completed and the current focus is on commercialization of the technology.

## Applications

Can be used to improve fuel cell performance in applications involving sub-freezing conditions, such as automobiles, forklifts, backup power systems, and auxiliary power units.

## Capabilities

- ◆ Achieves 50% of rated power in 28 seconds from a startup temperature of  $-20^{\circ}\text{C}$  (DOE quick start target is 30 seconds).
- ◆ Uses only 2.94 MJ of energy for a complete startup and shutdown cycle (41% below DOE target of 5 MJ).
- ◆ Starts unassisted from  $-40^{\circ}\text{C}$ .

## Benefits

### Cost Savings

Reduces system costs by increasing fuel cell stack power density and improving water purging procedure prior to cold shutdown.

### Durability

Avoids significant degradation of fuel cell stack materials after 200 freeze startup/shutdown cycles.

### Contact Information:

**Amedeo Conti**

Email: [aconti@nuvera.com](mailto:aconti@nuvera.com)

Phone: (617) 245-7605

**Nuvera Fuel Cells, Inc.**

129 Concord Road, Bldg. 1

Billerica, MA 01821

Website: <http://www.nuvera.com/>



# Dimensionally-Stable High-Performance Membrane

Emerging Technology

## New Fuel Cell Membrane Exhibits Improved Mechanical Properties

Devices that use fuel cell technology, such as vehicles, portable devices, and remote installations, require frequent startup and shutdown cycles, which are stressful on the polymer electrolyte membrane (PEM) structure. The water/ice expansion associated with the freeze/thaw cycle, low humidity, and high temperatures involved in the technology increases the stress and can result in dimensional instability in the PEM structure. These stresses may dry out the membrane, cause early failure because of cracks and structural fatigue, and can lead to loss of the fuel cell itself.

A membrane material and structure are needed that can be exposed to freeze/thaw cycles and operating conditions that include wide temperature ranges and varying relative humidity conditions and cycles. The membrane also needs to be highly conductive while maintaining superior mechanical properties and dimensional stability. Ideally, this PEM membrane should be able to be manufactured by a low cost, continuous process.

With the help of DOE SBIR grants, Giner Electrochemical Systems, LLC, is developing an easily manufactured membrane that improves performance and longevity in suboptimal operating conditions. Improved mechanical properties of their dimensionally stable membrane are achieved by using a high-strength support structure fabricated from high-performance engineering plastics. The pattern design of the support structure is completely customizable so that the weak areas, such as edges, can be specifically reinforced to further enhance durability. Employing the high-strength support structure allows lower-equivalent-weight ionomers, which are too mechanically weak to be implemented in the fuel cells, to be used without sacrificing mechanical durability. Thus, higher performance, especially at lower relative humidity levels, can be achieved. Based on microfabrication technology, support structures can be fabricated with a low-cost, continuous process. The membrane's property can be completely controlled by design and engineering of the patterns.

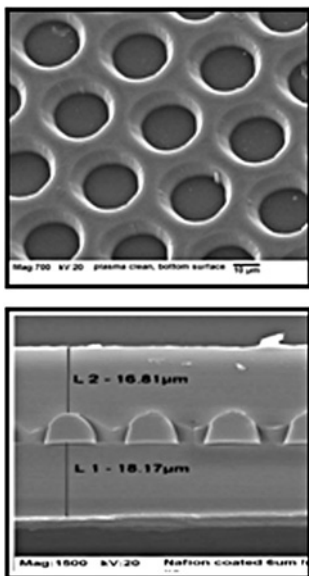

Micrographs of Giner's Dimensionally Stable Membrane

## Technology History

- ◆ Developed by Giner Electrochemical Systems, LLC.
- ◆ Continuing work on the Phase III SBIR grant with a focus on improving membrane fabrication processes and scalability to larger stacks.

## Applications

Can be used in fuel cells for vehicles, portable devices, and remote installations.

## Capabilities

- ◆ Improves membrane durability/lifetime during relative humidity cycling.
- ◆ Enhances fuel cell performance at low humidity and high temperature.
- ◆ Facilitates the operation of fully automated fabrication of membrane electrode assemblies.

## Benefits

### Durability

Prevents stress-induced failure because of the membrane's high-strength design.

### Performance

Improves performance at low humidity and high temperature.

### Contact Information:

**Cortney Middlesteadt**

Email: [cm@ginerinc.com](mailto:cm@ginerinc.com)

Phone: (781) 529-0529

**Giner Electrochemical Systems, LLC**

89 Rumford Avenue

Newton, MA 02466-1311

Website: <http://www.ginerinc.com>



# Direct Methanol Fuel Cell (DMFC) Anode Catalysts

Emerging Technology

## PtRu Catalyst-Carbon Support Improves Anode Performance and Fuel Cell Durability

Direct methanol fuel cells (DMFCs) are of great interest because of their high energy density and use of easily transportable liquid fuel. DMFCs are well-suited for portable commercial and military applications where weight and volume of the power source are most important. To date, material cost, insufficient catalytic activity, and durability have been barriers to commercially deploying DMFCs. In DMFCs, the methanol oxidation reaction (MOR) on the anode limits the fuel cell's performance and durability.

With assistance from the U.S. Department of Energy's Fuel Cell Technologies Program, the National Renewable Energy Laboratory (NREL) and the Colorado School of Mines (CSM) have developed a DMFC technology with improved anode MOR catalytic activity and durability for platinum-ruthenium (PtRu) on carbon. The work is focused on developing next-generation anode catalyst materials, based on a novel technology, to accelerate commercialization and market adoption of DMFCs for consumer electronics applications. The catalyst-support interactions were optimized by ion-implanting (doping) the carbon support with a specific dosage of nitrogen and nitrogen functionalities (e.g., pyrrolic, pyridinic, and graphitic). While other dopant types were also found to have an effect on MOR activity and durability, nitrogen demonstrated the best improvement to date.

The new catalyst-carbon matrix is manufactured using a synergistic ion implantation and magnetron sputtering of metallic catalyst (PtRu) on high surface area carbon powders using a rotator reactor. The resultant PtRu catalyst materials have shown up to 30% improvement in MOR activity and increase the durability of membrane electrode assemblies by 50% compared with commercially available catalyst materials of similar composition and metal loading. NREL and CSM continue to optimize catalyst use by investigating the metal-substrate interactions to better understand the effect of ion implantation and dry processing on catalyst activity and degradation mechanisms.

## Technology History

- ◆ Developed by NREL and CSM.
- ◆ Continuing work on correlating sputter-implantation parameters with catalyst structure and MOR performance and durability.

## Applications

Can be used in constructing fuel cells for portable power applications.

## Capabilities

- ◆ Improves catalyst performance and durability.
- ◆ Produces catalyst compositions on high surface area carbon materials using PtRu nanoparticles from a single composition PtRu alloy.

## Benefits

### Cost Savings

Reduces the material cost of the catalyst by an optimized deposition process, enhanced catalyst activity and improved durability.

### Manufacturability

Provides a dry scalable process for ion implantation and sputter deposition to high-surface-area carbon materials.

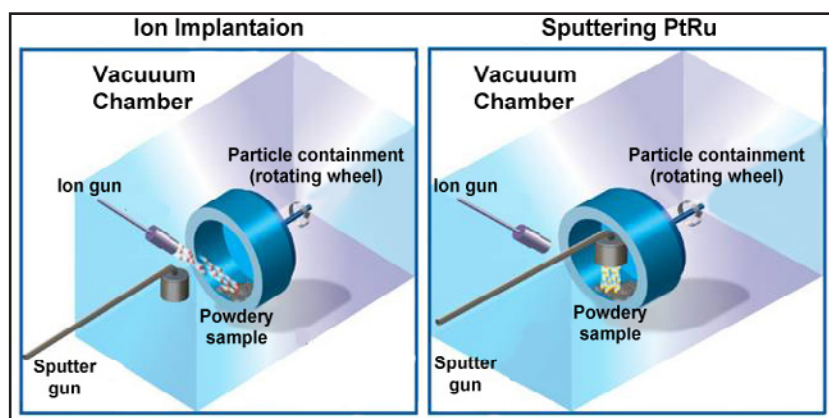

NREL's Pt-Ru Catalyst Ion Implantation and Sputter Deposition Process

### Contact Information:

**Dr. Huyen N. Dinh**

Email: [Huyen.Dinh@nrel.gov](mailto:Huyen.Dinh@nrel.gov)

Phone: (303) 275-3605

**National Renewable Energy Laboratory**

1617 Cole Blvd.

Golden, CO 80401-3393

Website: <http://www.nrel.gov>

# Direct Methanol Fuel Cell for Handheld Electronics Applications

## New Power Source Eliminates Need to Plug into Electrical Wall Outlet

Consumers are increasingly relying on handheld devices, whether for their business use or personal needs. As more and more features are added to portable devices, the amount of power being consumed also increases. Batteries are not keeping up with increased power demands and consumers are forced to choose between turning off some features to conserve battery power or searching for a wall outlet to recharge. The problem is that outlets may not always be available in remote areas. In addition, connecting to an outlet negates the portable nature of these devices and restricts their operation to an area limited by the length of the power cord. A system is needed that generates its own power so that portable devices can be used anywhere.

To address this need for a portable power source without the drawbacks associated with batteries, MTI Micro Fuel Cells, Inc., with FCT funding, has developed a technology called Mobion®. The Mobion technology is a direct methanol fuel cell chip that generates power from methanol while eliminating the conventional fuel cells need for active water recirculation pumps or the inclusion of water as a fuel dilutant. Fuel cells are different from batteries in that they consume reactant, which can be replenished, while batteries store electrical energy chemically in a closed system. While the electrodes within a battery react and change as a battery is charged or discharged, a fuel cell's electrodes are catalytic and relatively stable, resulting in long life.

Because of this improved technology, micro fuel cells have a significant advantage as handheld portable energy sources. As a standalone product, it can be carried just like the devices it was meant to power and used as needed to keep the device batteries charged. As the technology continues to improve, the micro fuel cell will also get embedded in devices and double or triple the time between charges. The consumer will get more use out of their device and be less inconvenienced by the need to find an outlet. MTI Micro has demonstrated prototypes for applications including a universal power source with removable/replaceable cartridges, a handheld GPS unit, a camera grip for a digital SLR camera, and a smart phone.

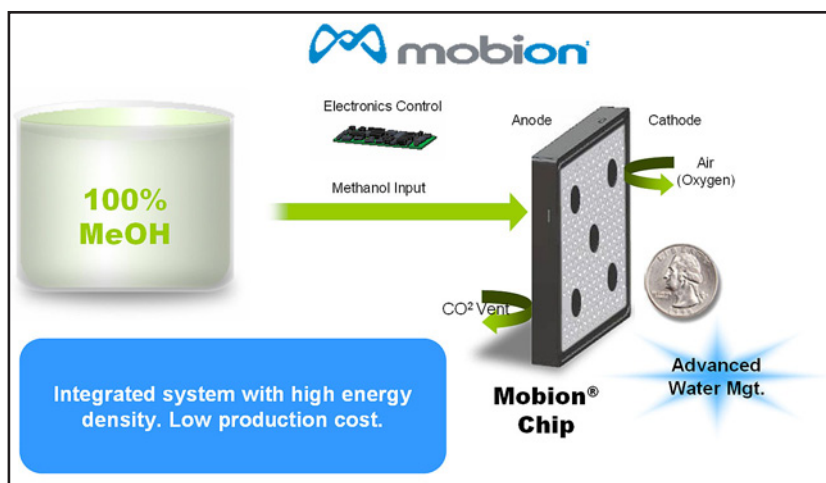

MTI Micro Fuel Cells' Mobion Technology

## Technology History

- ◆ Developed by MTI Micro Fuel Cells, Inc., in partnership with the Methanol Foundation.
- ◆ Continued improvements to the unit are being made based on the result of field tests. Codes and standards work and approval are proceeding with a number of government agencies.

## Applications

Can be used as a complement for current handheld electronic devices to keep their batteries charged. Exploring marketing strategy.

## Capabilities

- ◆ Eliminates the need for a wall outlet to keep devices charged for true mobile power.
- ◆ Operates in any orientation.
- ◆ Operates over a wide temperature range (0°C to 40°C) and at any humidity level.

## Benefits

### Manufacturability

Can be fabricated using high-volume, cost-effective manufacturing processes due to reduced parts count and smaller system design.

### Performance

Achieves a power density of over 62 mW/cm<sup>2</sup> with a fuel energy of over 1800 Whr/kg.

### Versatility

Allows fuel cartridge to be changed out while the device is operating, with no loss in power.

### Contact Information:

**Jim Frawley**

Email: [JimF@mechtech.com](mailto:JimF@mechtech.com)

Phone: (518) 533-2235

**MTI Micro Fuel Cells, Inc.**

431 New Karner Road

Albany, NY 12205

Website: <http://www.mtimicrofuelcells.com>

# Direct-Write Inkjet Printing for Fabricating Hydrogen Sensors

Emerging Technology

## New Technology Uses Inkjet Methods to Mass-Produce Hydrogen Sensors, Reducing Assembly Costs

Safety is an important concern in the production, delivery, and storage of hydrogen for transportation, distributed stationary power, and portable power applications. Because hydrogen can neither be seen nor smelled, a reliable hydrogen sensor is needed in all aspects of the hydrogen economy. The sensor also should be intrinsically safe to prevent the hydrogen from igniting. A method is needed to fabricate these sensors in high volume, which will require existing technologies to be modified.

With the help of DOE SBIR grants, InnoSense, LLC, is developing innovative manufacturing processes, based on direct-write inkjet technology, for the high-volume fabrication of both the components and the complete sensor system. A less expensive high-volume fabrication process is being developed that will eliminate the individual calibration of each sensor by making many identical sensors in one batch. InnoSense has established the fabrication protocols so multiple sensors can be developed in a single batch and perform reversibly and reproducibly. InnoSense sensors are all-optical and therefore intrinsically safe, producing no arc or spark. After fine-tuning for high-volume manufacturing, sensors will be manufactured that meet customer specifications for cost, reliability, response time, operational life, and desired sensitivity.

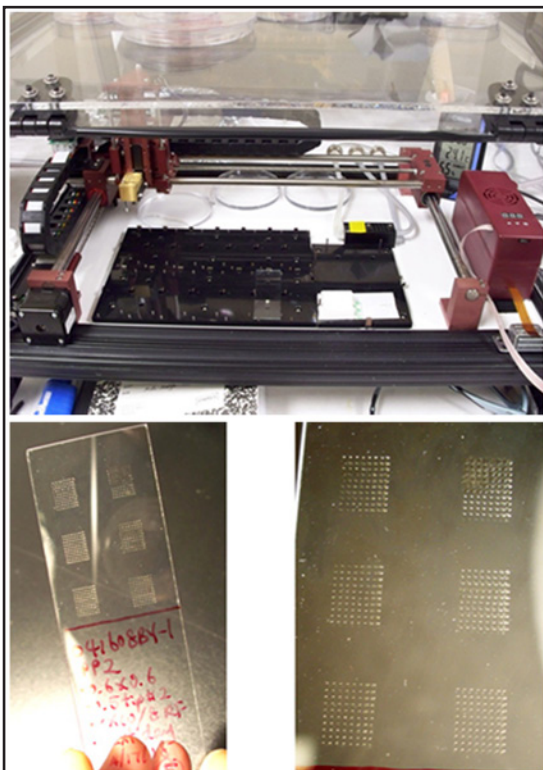

*InnoSense's Sensor Fabrication Process Using Pin-Printing Techniques*

## Technology History

- ◆ Developed by InnoSense, LLC, starting in 2006.
- ◆ Continuing work centered on fine-tuning the technologies for high-volume fabrication.

## Applications

Can be used to produce inexpensive hydrogen sensors for hydrogen storage facilities and other applications using hydrogen.

## Capabilities

- ◆ Achieves high-volume fabrication speeds.
- ◆ Produces hydrogen sensors with improved consistency batch to batch.
- ◆ Uses inexpensive pin-printing technology to fabricate hydrogen sensors.

## Benefits

### Cost Savings

Reduces manual assembly costs by using pin-printing technology.

### Performance

Allows sensors to be mass-produced by using a high-volume fabrication process.

### Contact Information:

**Dr. Kisholoy Goswami**

Email: [Kisholoy.goswami@innosense.us](mailto:Kisholoy.goswami@innosense.us)

Phone: (310) 530-2011 Ext. 105

**InnoSense, LLC**

2531 West 237th Street, Suite 127

Torrance, CA 90505-5245

Website: <http://www.innosense.us>



# Durable Catalysts for Fuel Cell Protection During Transient Conditions

Emerging Technology

## Self-Protecting Catalyst Controls Internal Fuel Cell Reactions During Transient Conditions

To meet the U.S. Department of Energy's (DOE's) 2015 targets for fuel cell catalyst performance, proton exchange membrane fuel cell systems must be able to withstand damage that occurs during the transient periods of startup, shutdown, and fuel starvation. Catalyst failure and other thermodynamically unstable membrane component failure occur because of increasing potential difference (measured in volts) between the electrodes. Reducing the potential difference between the electrodes during these transient periods would decrease damage and degradation and increase catalyst stability.

3M Company, with funding from DOE's Fuel Cell Technologies Program, is developing catalyst materials to alleviate the damaging effects of transient conditions within the fuel cells. The materials are being developed by modifying the catalyst's behavior such that oxidation of water instead of carbon corrosion is the preferred reaction. For preferential oxidation to occur, the cathode potential is maintained near 1.23 volts, which is needed for water oxidation. Maintaining this cathode potential requires multiple regions of anodic activity and the presence of an oxygen evolution reaction catalyst. By balancing the reduction and oxidation reactions within the fuel cell, overpotential for a given current demand is reduced and lessens carbon and platinum dissolution.

3M has developed nanostructured catalyst materials that address the specific reaction control requirements at each electrode and is currently improving the durability of the catalysts via additional material coatings.

## Technology History

- ◆ Developed by 3M Company and industry partners.
- ◆ Continuing work on additional material coatings for improving catalyst durability.

## Applications

Can be used to improve fuel cell performance and durability during transient conditions.

## Capabilities

- ◆ Controls oxidation and reduction reactions at fuel cell electrodes to prevent self-destruction.
- ◆ Achieves DOE technical targets for performance, platinum group metal loading, and durability.

## Benefits

### Cost Savings

Decreases cost by reducing the amount of high-cost material required.

### Durability

Improves durability by controlling catalyst reaction behavior during transient conditions.

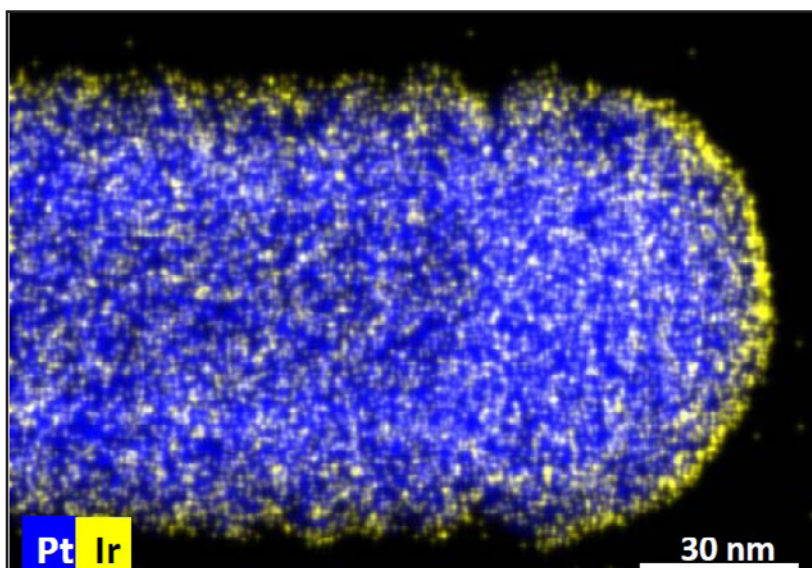

Energy Dispersive Spectroscopic Map of 3M's Self-Protecting Catalyst

### Contact Information:

**Dr. Radoslav T. Atanasoski**

Email: [ratanasoski@mmm.com](mailto:ratanasoski@mmm.com)

Phone: (651) 733-9441

**3M Company**

3M Center Bldg. 201-2N-05201

St. Paul, MN 55144-1000

Website: <http://www.mmm.com>

# Engineered Nanostructured MEA Technology for Low-Temperature Fuel Cells

Emerging Technology

## Novel Catalyst Support Technology Improves Performance and Reduces Costs of PEM Fuel Cells

Proton exchange membrane (PEM) fuel cells are used to convert the chemical energy of hydrogen into electricity. Hydrogen PEM fuel cells are attractive as a source of power for transportation applications because of their high energy efficiency and power density and may potentially replace the internal combustion engine in automobiles. Carbon black supported platinum (Pt/C) has been used as a fuel cell catalyst because of its high surface area and electrical conductivity. However, carbon black corrodes over time, leading to deterioration in fuel cell efficiency. In addition, Pt/C catalysts suffer from poor catalyst utilization (~ 20-30%) due to small micropores, which prevent effective contact between catalyst particles and the proton-conducting ionomer material. New materials and novel electrode structures are needed to improve the performance, durability, and cost of fuel cells.

Nanosys, Inc., with FCT funding, has developed a novel catalyst support technology for use in hydrogen fuel cell vehicles. The technology is based on engineered nanostructures that improve performance characteristics compared with conventional carbon supports. The nanowires consist of a silicon carbide (SiC) core with a conformal shell of thin and highly crystalline conductive nanographite. The nanographite, which extends from the nanowire surface, increases the total nanowire surface area to 125 m<sup>2</sup>/g and protects the nanowire core against corrosive attack. The network formed by the nanowires is robust and highly conductive and allows the fuel to access the catalyst particles deposited on the nanowire surface via an improved pore size distribution. At the same time, the highly interconnected network of electric conductors and electrolyte inherent to this structure provides efficient electron and proton transport in the catalyst layers of the membrane electrode assembly. The structure ensures a high catalyst utilization, enables a high power density using low catalyst loading, and ensures a superior durability compared with conventional carbon-supported catalysts.

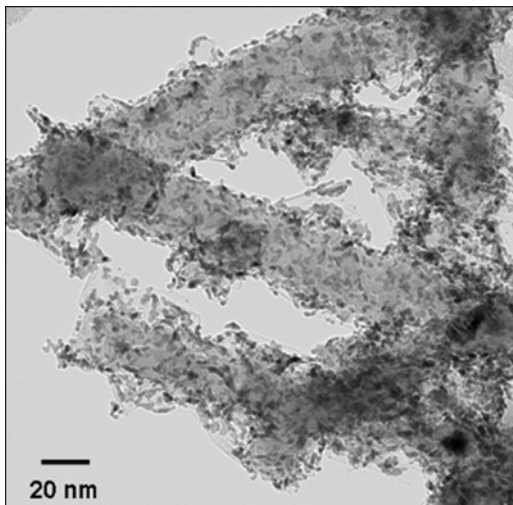

*Platinum Catalyst Deposited on Nanosys' Silicon Carbide Nanowires*

## Technology History

- ◆ Developed by Nanosys, Inc.
- ◆ Continuing efforts to optimize a nanowire-supported platinum cobalt (PtCo) catalyst to increase mass activity.

## Applications

Can be used to increase performance and durability and reduce costs of PEM fuel cells.

## Capabilities

- ◆ Increases nanowire surface area to 125 m<sup>2</sup> per gram.
- ◆ Achieves a performance of 0.25 g/kW at 0.65 V, exceeding the 2010 DOE goal of 0.3 g/kW.
- ◆ Increases catalyst mass activity relative to commercially available Pt/C catalysts.

## Benefits

### Cost Savings

Reduces costs by enabling high power density operation using reduced amounts of precious metal catalyst.

### Durability

Resists corrosive attack by acids or alkalis by using a nanographite shell covalently bonded to the silicon carbide (SiC) nanowire core.

### Contact Information:

**Dr. Yimin Zhu**

Email: [yzhu@nanosysinc.com](mailto:yzhu@nanosysinc.com)

Phone: (650) 331-2232

**Nanosys, Inc.**

2625 Hanover Street

Palo Alto, CA 94304

Website: <http://www.nanosysinc.com>

# Extended Continuous Pt Nanostructures in Thick, Dispersed Electrodes

Emerging Technology

## Nanostructured Pt Electrocatalysts with Increased Activity and Durability

Platinum (Pt) catalysis remains one of the primary cost and durability limitations for the commercial deployment of polymer electrolyte fuel cells. Increasing fuel cell performance and durability would reduce the amount of Pt required and overcome these barriers. The U.S. Department of Energy (DOE) has established a 2015 catalyst performance target for specific activity of 720 micro amps/cm<sup>2</sup> (at 900 mV<sub>IR-free</sub>).

The National Renewable Energy Laboratory (NREL), with funding from DOE's Fuel Cell Technologies Program, has been investigating Pt nanostructured catalysts with extended surfaces in order to address the low specific activities and low durability of traditional Pt catalysts supported on carbon. Using extended structure nanoparticle templates (typically nanowires) of metals (silver, copper, and selenium have been used), Pt extended thin film electrocatalyst structures have been synthesized using spontaneous galvanic displacement (SGD). In the SGD process, Pt ions in solution "steal" electrons from the less noble metal template materials, often resulting in Pt nanotubes being formed from the nanowire templates. The specific activities of several select materials have been examined and all had specific activities above the DOE 2015 target.

These materials have maintained their specific activity advantages when placed into fuel cells. They have also shown enhanced durability to electrochemical cycling with and without the presence of carbon. Current efforts are focused on further increasing the electrochemically available Pt surface area in order to meet DOE mass activity targets. Traditional Pt/C catalysts have ~100 m<sup>2</sup>/g<sub>Pt</sub>; typical extended surface structures have been limited to ~10 m<sup>2</sup>/g<sub>Pt</sub>. This project has attained electro-chemical activation >40 m<sup>2</sup>/g<sub>Pt</sub>. The observed mass activity of this material, 330 milli amps/g<sub>Pt</sub> (at 900 mV<sub>IR-free</sub>), approaches the DOE 2015 target of 440 milli amps/g<sub>Pt</sub> (at 900 mV<sub>IR-free</sub>).

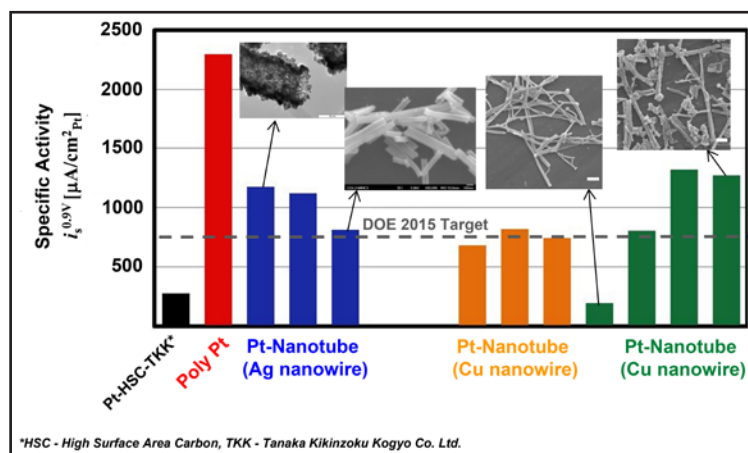

NREL's Pt Electrode Nanostructured Technology

## Technology History

- ◆ Developed by NREL with academic and industrial partners.
- ◆ Continuing work to increase the Pt surface area and deploy in fuel cell electrodes.

## Applications

Can be used in polymer electrolyte fuel cells.

## Capabilities

- ◆ Uses galvanic displacement to produce continuous Pt nanostructures.
- ◆ Achieves increased specific activity and durability compared with traditional Pt/C systems.
- ◆ Achieves increased performance and durability with decreased cost.

## Benefits

### Cost Savings

Uses less Pt material to reduce material cost and the balance of plant cost to process the materials; e.g., the need for compressor and expander equipment is lessened.

### Durability

Improves durability against cycling and carbon corrosion.

### Performance

Increases fuel cell performance through high specific activity of the material.

### Scalability

Uses a wet chemical production process, which is scalable, to produce material quantities required for mass production.

### Contact Information:

**Dr. Bryan Pivovar**

Email: [Bryan.Pivovar@nrel.gov](mailto:Bryan.Pivovar@nrel.gov)

Phone: (303) 275-3809

**National Renewable Energy Laboratory**

1617 Cole Blvd.

Golden, CO 80401

Website: <http://www.nrel.gov>

# FARADAYIC ElectroEtching of Stainless Steel Bipolar Plates

Emerging Technology

## New Manufacturing Process Enables Low-Cost, High-Volume Production of Metal Bipolar Plates

The transition of polymer electrolyte membrane (PEM) fuel cells to the commercial market requires low-cost components, materials and manufacturing processes. Because bipolar plate manufacturing currently contributes to a significant percentage of the total fuel cell manufacturing cost, an inexpensive bipolar plate manufacturing process must be realized for fuel cells to achieve prominence in the commercial energy sector. Using metal as a bipolar plate material is attractive because of its high electrical conductivity. Since candidate materials such as titanium, tantalum, and gold are too expensive, stainless steel alloys are being considered for bipolar plates. Stainless steel bipolar plates offer several additional advantages such as relatively low cost, high strength, ease of manufacture, and significant improvements in the power/volume because they can be shaped into thin sheets.

Using funding from FCT, Faraday Technology, Inc., is developing a low-cost, high-volume metal bipolar plate manufacturing process. The new manufacturing process, the FARADAYIC ElectroEtching Process, is based on electrochemical through-mask etching. The process involves patterning a photoresist mask on the surface of the bipolar plate to protect specific areas during the electroetching process. A pulsed electric field is applied between the bipolar plate substrate and a counter electrode submerged in a benign solution to remove the metal not protected by the photoresist mask. The process results in the formation of the gas flow-field channels on the surface of the bipolar plate.

The gas flow-field design strongly influences the fluid dynamics of the reactant gas from the inlet to the outlet and consequently plays a major role in determining the uniformity/nonuniformity of the current and temperature distributions within the fuel cell. Uniform current and temperature distributions are critical to maintaining optimal performance of the fuel cell stack as well as minimizing polarization losses and optimizing water management. The FARADAYIC ElectroEtching Process will enable the manufacturing of advanced flow channel designs that cannot be manufactured cost effectively using more conventional machining techniques. Faraday is currently working to validate the bipolar plate manufacturing process through single cell fuel cell tests.

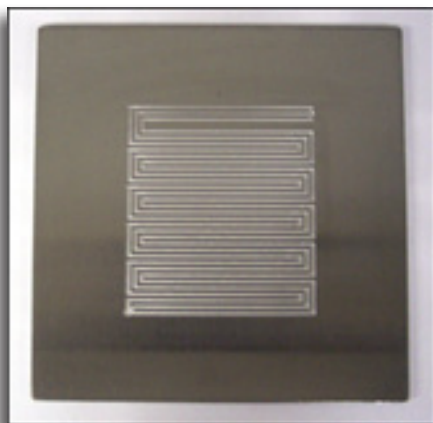

*Sample 430 Stainless Steel Bipolar Plate with Gas Flow Fields Formed Using The FARADAYIC ElectroEtching Process*

## Technology History

- ◆ Developed by Faraday Technology, Inc., a subsidiary of Physical Sciences Inc., in collaboration with the University of South Carolina's IUCRC Fuel Cell Center.
- ◆ Etching bipolar plates with gas flow fields for single cell fuel cell testing under automotive and stationary conditions.

## Applications

Can be used in PEM fuel cell stacks intended for both stationary and automotive applications.

## Capabilities

- ◆ Maintains plate flatness and plate parallelism since flow fields are formed via a noncontact process.
- ◆ Enables inexpensive manufacturing of both simple and complicated flow-field designs.

## Benefits

### Cost Savings

Reduces the overall manufacturing cost of the bipolar plate by using a high-volume batch process with low capital equipment and tooling costs.

### Versatility

Forms complex shaped flow fields in a variety of metals and alloys.

### Contact Information:

**Heather McCrabb**

Email:

[heathermccrabb@faradaytechnology.com](mailto:heathermccrabb@faradaytechnology.com)

Phone: (937) 836-7749

**Faraday Technology, Inc.**

315 Huls Drive

Clayton, OH 45315

Website: <http://www.faradaytechnology.com>



# Fuel Cell Membrane Measurement System for Manufacturing

Emerging Technology

## New High-Throughput System Rapidly Measures Fuel Cell Membrane Resistance

Successful commercialization of fuel cells in the high-volume transportation market requires that cost be reduced and the consistency of polymer electrolyte membranes be improved. Fabricating a membrane electrode assembly (MEA) and testing it in a completed fuel cell are costly and time consuming. Current technology does not support testing the “bare” membrane prior to assembly in an MEA. Ionomer material is produced in a wide sheet and is subject to both longitudinal and lateral variations. Therefore, guaranteeing consistency and repeatability in the finished product is difficult and can increase waste and costs. A tool is needed to measure the ionic resistance of the “bare” membrane prior to assembly in the finished product. This tool needs to be combined with the necessary software and methodology to enhance the product quality assurance/quality control (QA/QC). Tools and methods for accurate measurement of the through-thickness ionic resistance of fuel cell membranes, a key property, are required to support high-volume production QA/QC programs.

Scribner Associates, Inc., with funding from DOE SBIR grants, is developing a high-throughput membrane measurement system to support fuel cell membrane manufacturing operations. Scribner Associates has been issued a U.S. patent (No. 7,652,479) for a novel electrode design and measurement apparatus that is compatible with bare membrane and MEA samples. The ability to test bare membranes significantly reduces the analysis time and increases the throughput of the measurement system. Possible future markets might include a membrane test device designed for the research and development community. Researchers developing new membrane materials need to characterize their materials before they go through the time-consuming and costly effort of fabricating and testing an MEA in a fuel cell.



*Scribner Associates' Rapid Membrane Measurement System Prototype*

## Technology History

- ◆ Developed by Scribner Associates, Inc.
- ◆ Currently offering potential customers a trial prototype unit to solicit feedback on unit performance.

## Applications

Can be used to rapidly measure the through-thickness ionic resistance of bare, as-manufactured fuel cell membranes under controlled environmental conditions.

## Capabilities

- ◆ Achieves consistent and accurate measurement results.
- ◆ Uses bare, as-manufactured membrane or MEA samples.
- ◆ Performs analyses significantly faster than previous methods.

## Benefits

### Cost Effectiveness

Achieves consistent results, thus lowering manufacturing costs through less waste.

### Performance

Improves fuel cell membrane manufacturing efficiency by using high throughput testing.

#### Contact Information:

**Dr. Kevin R. Cooper**

Email: [kevin@scribner.com](mailto:kevin@scribner.com)

Phone: (910) 695 8884 ext. 32

**Scribner Associates, Inc.**

150 East Connecticut Ave.

Southern Pines, NC 28387

Website: <http://www.scribner.com>

# Fuel-Cell-Based Mobile Lighting

## Mobile Lighting System Offers Zero Emissions for Remote Off-Grid Applications

The vast majority of mobile, light-to-medium construction equipment is based on diesel fuel combustion. Examples include diesel-fueled mobile lighting towers, portable power generators, mobile water pumps, and concrete-masonry equipment. Such equipment is commonly used for road maintenance, general construction, and other industrial applications. The current equipment technology suffers from well-known problems, including release of toxic air contaminants and particles into the air (threatening human health), and emission of CO<sub>2</sub> and other greenhouse gases (contributing to global climate change). These diesel systems are also comparatively inefficient in their use of energy and distractingly loud, which is a safety issue for those using them.

Sandia National Laboratories is leading a consortium of industry partners, with funding from the U.S. Department of Energy's Fuel Cell Technologies Program, to develop clean, energy-efficient new technology based on fuel cell power for mobile lighting systems. The fuel cell mobile light system employs a 5-kW hydrogen fueled proton exchange membrane (PEM) fuel cell that powers high-efficiency plasma lighting. The fuel cell is a zero-emissions power generation source, releasing only slightly humidified warm air, and is much more energy efficient (47%) than a diesel engine (25 to 30%). The combination of fuel cell efficiency with high-efficiency plasma lighting allows a nearly four-fold improvement in overall energy efficiency.

The project has focused on designing, building, and deploying five fuel cell mobile lighting systems to replace existing diesel-powered lighting towers commonly seen along highways in road maintenance work. After the fuel cell mobile lights are field tested, they will be commercialized by Multiquip Inc. as the H2LT mobile lighting system, the first product in a new fuel-cell-based product line from Multiquip called EarthSmart™.



Sandia's Fuel Cell Based Mobile Lighting System by Multiquip Inc.

## Technology History

- ◆ Developed by Sandia National Laboratories, Altery Systems, Boeing, California Fuel Cell Partnership, California Department of Transportation (Caltrans), Golden State Energy Corp., Lumenworks Inc., Luxim Corp., Multiquip, Ovonc Hydrogen Systems, Saunders Electric Inc., San Francisco International Airport and Stray Light Optical Technologies.
- ◆ Current focus on product field testing and commercializing five prototypes at Caltrans, NASA Kennedy Space Center, Boeing, San Francisco International Airport and Paramount Pictures.

## Applications

Can be used for numerous off-grid lighting applications, e.g. road construction, aviation ground support, entertainment lighting and other temporary lighting applications.

## Capabilities

- ◆ Produces high quality mobile lighting using eight 23 kilo-lumen plasma lamps.
- ◆ Provides 2.5kW of auxiliary AC power.
- ◆ Achieves zero emissions at point of use.

## Benefits

### Efficiency

Provides four-fold system efficiency by using a PEM fuel cell and plasma lighting.

### Flexibility

Can be used indoors or outdoors.

### Safety

Provides greener and safer work environment by reducing noise and eliminating emissions.

#### Contact Information:

**Lennie Klebanoff Ph.D.**

Email: [lekleba@sandia.gov](mailto:lekleba@sandia.gov)

Phone: (925) 294-3471

**Sandia National Laboratories**

PO Box 969

Livermore, CA 94551

Website: <http://www.sandia.gov>

# GenSys® Blue: High-Temperature CHP Fuel Cell System

Emerging Technology

## Micro-CHP System Reduces Residential Energy Costs and CO<sub>2</sub> Emissions

The electrolyte membranes used in most proton exchange membrane (PEM) fuel cells rely on liquid water humidification to transport protons from the cell's anode to its cathode. To prevent the membrane from drying out, PEM fuel cells are typically operated well below the boiling point of water (e.g., between 55°C-75°C). Waste heat captured from these low-temperature fuel cells is insufficient to meet residential space heating or water heating needs.

To make fuel cells more practical for small-scale combined heat and power (CHP) applications, Plug Power Inc. developed a high-temperature PEM system that provides efficient electricity generation and high-quality waste heat. The GenSys Blue uses polybenzimidazole membrane technology that enables fuel cell operation at 160°C-180°C. Heat generated from this system is of sufficient temperature to meet thermal comfort demands, allowing the GenSys Blue to be simply connected to existing hydronic or forced-air heating systems. The unit is fueled by natural gas and has an autothermal reformer for generating the hydrogen used by the fuel cell. A natural gas burner is integrated into the system to enable a rapid response to increased home heating needs.

With assistance from the U.S. Department of Energy's Fuel Cell Technologies Program (as part of the American Recovery and Reinvestment Act), Plug Power is conducting tests in both laboratory and real-world settings to demonstrate the durability and economic value of the GenSys Blue and to verify its readiness for the commercial marketplace. A fleet of six units has been undergoing long-term testing in Plug Power labs to generate reliability statistics and identify potential engineering improvements to the design. Additional units will be installed and field-tested at residential and light-commercial sites provided by project partners Sempra Energy and the University of California, Irvine.



Plug Power's GenSys Blue Fuel Cell System

## Technology History

- ◆ Developed by Plug Power Inc. in partnership with Sempra Energy and the University of California, Irvine.
- ◆ Currently conducting reliability testing on six units at Plug Power labs.
- ◆ Planning to install and test additional units at end-user locations in California.

## Applications

Can be used to provide electricity, space heating, and hot water for residential and light commercial buildings.

## Capabilities

- ◆ Provides up to 5 kW of electricity and 28,000 Btu/hr of usable heat.
- ◆ Achieves electrical and CHP efficiencies of 30% and 85%, respectively (lower heating value).
- ◆ Uses an integrated natural gas burner when a rapid response to home heating needs is required.

## Benefits

### Compatibility

Integrates easily with existing hydronic and forced-air heating systems.

### Cost Savings

Reduces residential utility bills by 20%-40%.

### Emissions Reductions

Reduces residential CO<sub>2</sub> emissions by 25%-35%.

#### Contact Information:

**Don Rohr**

Email: [Don\\_Rohr@plugpower.com](mailto:Don_Rohr@plugpower.com)

Phone: (518) 738-0343

**Plug Power Inc.**

968 Albany Shaker Road  
Latham, New York 12110

Website: <http://www.plugpower.com>

# High-Efficiency Polymer Electrolyte Membrane Fuel Cell Combined Heat and Power System

Emerging Technology

## New Fuel-Cell-Based CHP System Achieves Superior Efficiency over Conventional Reciprocating Engine Technologies

As diminishing fossil fuel reserves and greenhouse gas emissions have become of ever greater concern, governments and industry have begun exploring potential solutions by developing alternative technologies. Distributed, high-efficiency cogeneration systems have several advantages over centralized electrical power production, including the elimination of transmission losses, reduced CO<sub>2</sub> footprint, and significant cost savings for consumers and utilities.

To maximize the benefits available from distributed cogeneration, Intelligent Energy Inc., with funding from FCT, has developed a high-efficiency polymer electrolyte membrane (PEM) fuel cell combined heat and power (CHP) system. The system works by first converting a hydrocarbon feedstock into pure hydrogen. This clean fuel is then supplied to a fuel cell, where hydrogen and oxygen react to create an electric current. Heat is also released and can be used for space heating, hot water, or various industrial applications. The efficiency of the fuel cell electrochemical process is not constrained by the limitations of a heat engine. A fuel cell can be 20-40% more efficient than micro-turbines and diesel generators, which are commonly found in medium-scale distributed generation applications.

At Intelligent Energy (IE), a beta phase field demonstrator is now under development. The new CHP system will be installed at Chalvey, UK as part of the International Partnership for the Hydrogen Economy (IPHE) in 2011. Plans for gamma unit field trials and full scale production have been developed.

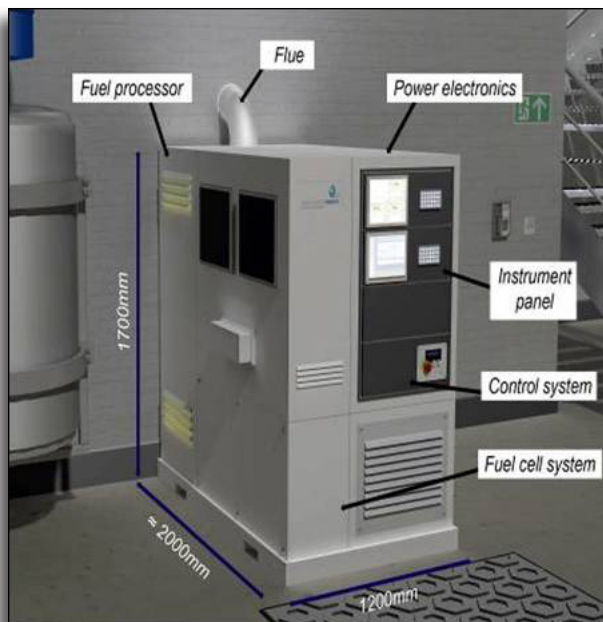

Intelligent Energy's Series 7 10-kWe CHP System

## Technology History

- ◆ Developed by Intelligent Energy Inc. in collaboration with Scottish and Southern Energy Ltd.
- ◆ Alpha phase CHP system undergoing laboratory testing, Beta phase unit under construction and a field demonstration in Chalvey, UK is scheduled for mid-2011.

## Applications

Can be used to provide electrical and space heating requirements for light-industrial installations or multi-residential dwellings.

## Capabilities

- ◆ Achieves 35% electrical efficiency, with greater than 70% combined efficiency possible (dependent on application).
- ◆ Offers a quick startup time (less than 60 min) and a turndown ratio of 4:1.
- ◆ Enables virtually silent operation.

## Benefits

### Durability

Reduces the frequency of maintenance periods by using local and remote system health monitoring.

### Emissions Reductions

Reduces CO<sub>2</sub> emissions by five tons per year relative to similarly sized conventional gas engine systems.

### Versatility

Allows for easy installation because of its modular and scalable design; can be configured to provide emergency backup power if a grid failure occurs.

### Contact Information:

**Dr. Durai Swamy**

Email:

[durai.swamy@intelligent-energy.com](mailto:durai.swamy@intelligent-energy.com)

Phone: (562) 304-7688

**Intelligent Energy Inc.**

2955 Redondo Ave.

Long Beach, CA 90806

Website: <http://www.intelligent-energy.com>



# High-Performance, Low-Pt Cathodes Containing New Catalysts and Layer Structure

Emerging Technology

## New System Optimizes Discovery and Testing of Fuel Cell Electrocatalysts

The development and high-volume manufacture of durable, low-cost oxygen reduction electrocatalysts with high activity and utilization are critical remaining challenges for the successful introduction of fuel cells into mass markets. Meeting the challenges has two issues: the high cost of platinum (Pt) used in the current generation membrane electrode assemblies (MEAs) and lack of sufficient durability under load-cycling conditions.

To address these problems, Cabot Superior MicroPowders (CSMP) and partners, with funding from FCT, has developed a complete system for combinatorial discovery of high-performance fuel cell electrocatalysts consisting of rapid powder synthesis, primary electrochemical testing screen, automated electrode printing, and rapid testing in MEA configurations. This system allows different catalyst mixtures to be formulated and then tested to determine their performance. This is achieved by applying the catalyst mixtures to MEAs and then testing them in different configurations.

As a result of this effort, six Pt-alloy compositions were identified that demonstrate up to a two-fold improvement in Pt mass activity compared with that of pure Pt electrocatalysts. Through Pt-alloy catalysts composition, production optimization, and layer structure development, the best CSMP Pt-alloy electrocatalyst demonstrates performance in MEA configurations equivalent to 0.6 g Pt/kW at 0.8 V, meeting the DOE target. Single-cell MEA operation at lower voltages (0.7 V and 0.6 V) lead to performance of 0.3-0.4 mg Pt/kW, exceeding the DOE targets set at the beginning of the project. Selected Pt-alloy compositions also demonstrate significantly improved durability when tested under load cycling protocols. The improved performance of MEAs incorporating Pt-alloy compositions was also validated by testing in short stacks.

## Technology History

- ◆ Developed by Cabot Superior MicroPowders in partnership with DuPont Fuel Cells, CFD Research Corporation, and Hydrogenics Corporation.
- ◆ Undertaking durability testing and production of new low-Pt layered catalysts.

## Applications

Can be used to develop and test new MEAs to improve performance in automotive fuel cells.

## Capabilities

- ◆ Provides rapid electrochemical testing.
- ◆ Provides a combinatorial electrocatalyst synthesis platform based on spray conversion.
- ◆ Allows platinum to be reduced while maintaining performance.

## Benefits

### Cost Savings

Allows rapid synthesis and testing of electrocatalysts and reduces research costs.

### Performance

Demonstrates up to two-fold improvement in Pt mass activity compared with that of pure Pt electrocatalysts from the production of six Pt-alloy compositions.

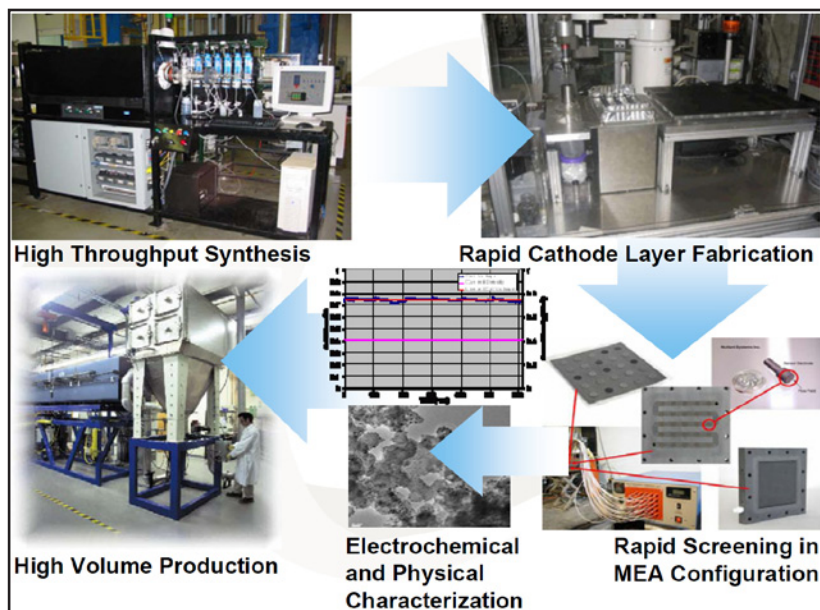

Cabot's High Throughput Catalyst Discovery Platform

### Contact Information:

**Paolina Atanassova**

Email:

[paolina\\_atanassova@cabot-corp.com](mailto:paolina_atanassova@cabot-corp.com)

Phone: (505) 563-4379

**Cabot Superior MicroPowders**

5401 Venice NE

Albuquerque, NM 87113

Website: <http://www.cabot-corp.com>

# High-Temperature Membrane with Humidification-Independent Cluster Structure

Emerging Technology

## Novel Fuel Cell Membrane Can Operate at Varying Humidity Levels Over a Wide Temperature Range

A major challenge for fuel cell membranes operating at high temperatures (up to 120°C) and low relative humidity is loss of proton conductivity due to loss of water. Another problem is that fuel cells must operate over a wide temperature range (-20°C to 120°C), which results in conditions ranging from dry to condensing atmospheres within the fuel cell. This poses a challenge not only to the conductivity but also to the mechanical integrity of the membrane. Membranes that can operate at lower relative humidity at elevated temperatures up to 120°C will reduce the fuel cell system complexity and cost.

To address these requirements, FuelCell Energy, Inc., with FCT funding, is developing a composite membrane in which both the ionic conductivity and mechanical properties are enhanced to meet DOE's goals for transportation fuel cells. The main focus is to increase the proton conductivity at 120°C and 25% to 50% relative humidity without decreasing the mechanical properties. A multicomponent composite membrane concept is being developed to address conductivity and mechanical issues. This multicomponent approach provides basic building blocks and functionalized additives to solve these technical problems.

FuelCell Energy's composite membrane (mC<sup>2</sup>) consists of four components: a co-polymer, a support polymer, a water retention additive, and a protonic conductivity enhancer. The co-polymer provides the basic building block for the membrane. It is an advanced perfluoro sulfonic acid with significantly higher conductivity than state-of-the-art polymers. The support polymer is designed to give a stable cluster structure and enhance mechanical properties. The functionalized additives are designed to retain water at low relative humidity conditions and enhance the composite membrane's proton conductivity by providing an alternate proton conduction path. This path is designed to efficiently transport protons at high temperature as well as subfreezing conditions. Moreover, the additives further reinforce the mechanical properties of the composite membrane. Conductivity and durability testing of the mC<sup>2</sup> is continuing.

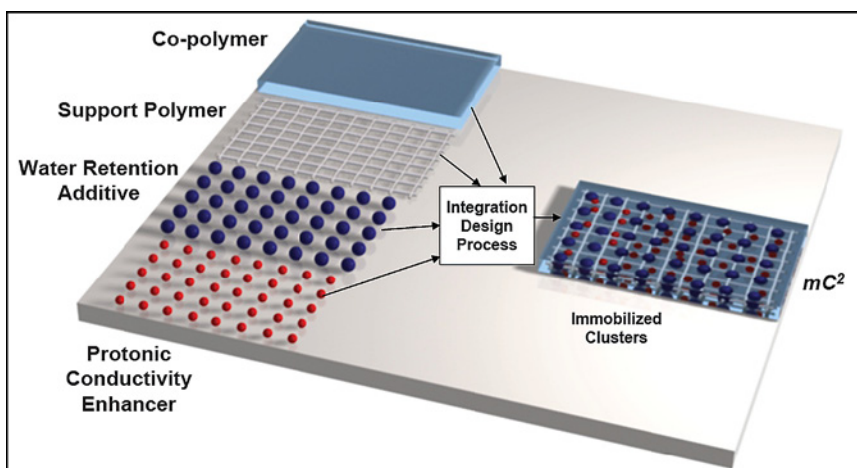

FuelCell Energy's Composite Membrane Concept

## Technology History

- ◆ Developed by FuelCell Energy, Inc., in partnership with BekkTech LLC and the University of Central Florida.
- ◆ Optimizing design and materials and lowering cost after successfully improving energy consumption and scaling up the high pressure capability.

## Applications

Can be used to improve the performance of polymer electrolyte membrane fuel cells over a wide temperature and humidity range.

## Capabilities

- ◆ Allows use of fuel cell membranes at higher temperatures.
- ◆ Operates independent of inlet humidity.
- ◆ Can be used in fluctuating humidity environments.

## Benefits

### Cost Savings

Lowers overall system cost by reducing fuel cell system complexity.

### Durability

Increases mechanical strength.

### Contact Information:

**Dr. Ludwig Lipp**

Email: [llipp@fce.com](mailto:llipp@fce.com)

Phone: (203) 205-2492

**FuelCell Energy, Inc.**

3 Great Pasture Road

Danbury, CT 06813

Website: <http://www.fuelcellenergy.com>

# Improved Low-Cost, Durable Fuel Cell Membranes

Emerging Technology

## New Blended Membrane has Improved Electrochemical Stability and Mechanical Toughness

Low-cost, durable polymer electrolyte membranes are critical components that require improvement to realize the viability of fuel cells for automotive and stationary applications. In a typical commercially-available membrane – a perfluorinated sulfonic acid (PFSA) membrane – all mechanical, chemical, electrochemical, and transport properties are “packaged” into a single macromolecule. PFSA membranes require complex synthesis for production, leading to high cost, and have insufficient durability under fuel cell operating conditions. One way to advance the state-of-the-art of fuel cell membranes is to decouple the membrane’s proton conductivity properties from the other requirements. This approach allows the use of various, separate materials to fulfill mechanical and transport properties.

Arkema Inc., conceived a new approach based on the blending of polymer materials, Kynar® poly(vinylidene fluoride) (PVDF) for enhanced mechanical toughness and sulfonated polyelectrolytes for proton transport. In this approach, proton conductivity is decoupled from other requirements. Kynar PVDF provides an ideal matrix for the membrane as it offers exceptional chemical resistance in highly oxidative and acidic environments, outstanding electrochemical stability, and mechanical toughness. Arkema, with FCT funding, demonstrated beginning-of-life performance equal to or better than PFSA materials, and greatly improved durability in accelerated tests (open-circuit voltage hold, relative humidity cycling, and voltage cycling). Also, these novel materials potentially offer a lower-cost membrane than the PFSA membrane (at equal production volume) because their preparation process is simpler. Arkema and its partners are now focusing on improving membrane performance at low relative humidity and temperatures above 80°C to meet and exceed DOE’s 2015 performance and durability targets.

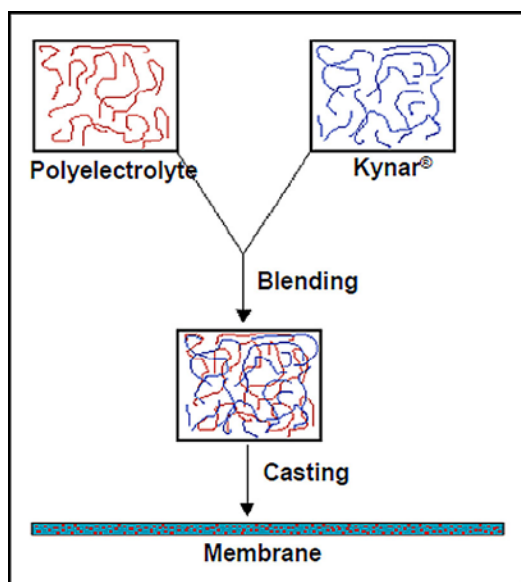

Arkema's Membrane Production Process

## Technology History

- ◆ Developed by Arkema Inc., in partnership with Johnson Matthey Fuel Cells, Inc., Oak Ridge National Laboratory, Virginia Polytechnic Institute and State University, and the University of Hawaii.
- ◆ Continuing new membrane production, screening, and testing as well as improving membrane performance at low relative humidities and higher temperatures.

## Applications

Can be used in membrane electrode assemblies in fuel cells suitable for both automotive and stationary applications.

## Capabilities

- ◆ Increases the durability of membrane electrode assemblies in fuel cells.
- ◆ Can be mass-produced because of simpler preparation process.

## Benefits

### Cost Savings

Results in lower cost membranes at high production volumes.

### Durability

Features exceptional electrochemical stability and high durability.

### Contact Information:

**David Mountz**

Email: [david.mountz@arkema.com](mailto:david.mountz@arkema.com)

Phone: (610) 878-6418

**Arkema Inc.**

900 First Avenue

King of Prussia, PA 19406-0936

Website: <http://www.arkema.com>



# Low-Cost 3-10 kW Tubular SOFC Power System

Emerging Technology

## Improved Fuel Cell System Increases Efficiency and Reduces Costs of Micro CHP Applications

Achieving the U.S. Department of Energy's combined heat and power (CHP) goals of over 40% net electrical efficiency and over 80% total energy efficiency will reduce both our nation's dependence on foreign energy and the emission of greenhouse gases. Solid oxide fuel cells (SOFCs), which can use readily available domestic fuels such as natural gas and generate high-grade waste heat, are ideal candidates for this challenge. To date, the poor reliability and high cost of SOFC systems have prevented these goals from becoming a reality.

To address these limitations and bring SOFC technology to the CHP market, Acumentrics Corporation, with FCT funding, is developing an optimized SOFC power system. Unlike conventional planar fuel cell stacks, the Acumentrics design employs discreet tubes bundled in parallel. Several key aspects of the system are being investigated, including improving fuel cell power and stability, reducing the cost of cell manufacturing through increased yield and reduced material consumption, and increasing overall system efficiency by developing simplified controls and balance-of-plant components. Acumentrics has reduced the number of tubes required to generate 1.25 kW of electricity from 126 to 20, significantly reducing weight/volume and saving costs. In addition, an advanced recuperator has been developed to recover waste heat from the fuel cell exhaust stream. The Acumentrics system has demonstrated electrical efficiencies of 35-40% and a CHP efficiency of 85%.

Acumentrics continues to develop and demonstrate the design in order to introduce it into the U.S. residential micro CHP market. On-site simultaneous generation of heat and power will increase efficiency and lower energy costs to consumers. Looking at remote power and military applications of the units.

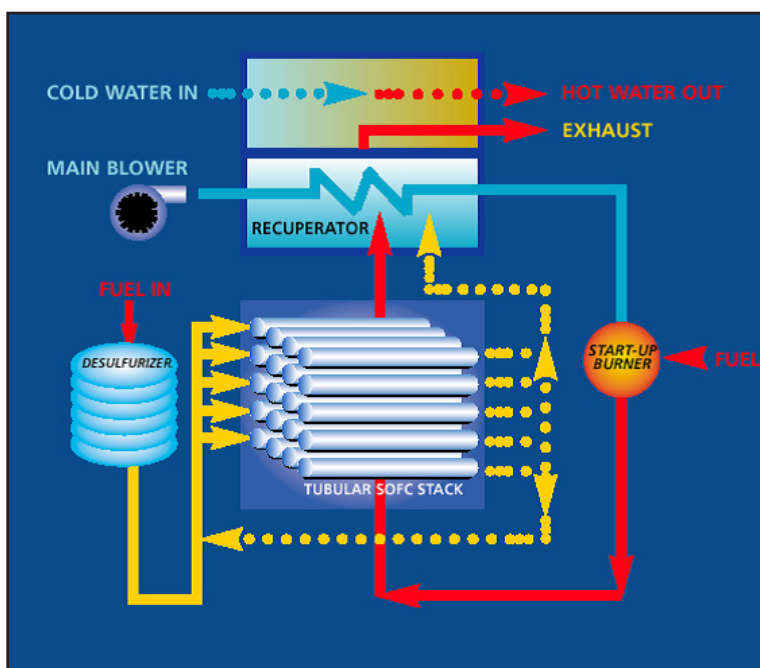

Flow Diagram of Acumentrics' Tubular SOFC Power System

## Technology History

- ◆ Developed by Acumentrics Corporation in partnership with Argonne National Laboratory, Ariston Thermo Group, and the Office of Naval Research.
- ◆ Continuing work on increasing power output, improving durability and reducing product cost using automated manufacturing.

## Applications

Can be used to provide electricity and hot water in residential applications. Also looking at remote power and military uses.

## Capabilities

- ◆ Achieves 85% CHP energy efficiency (1-kWe wall-hung system).
- ◆ Operates for more than 5,000 hours with a degradation rate of less than 1% per 1000 hours.
- ◆ Adjusts from 10% to 90% of rated power in less than three minutes.

## Benefits

### Cost Savings

Reduces costs by using an isopressing process for tube manufacturing, which enables high-volume throughput and reduced material waste.

### Durability

Handles readily available fuels such as natural gas and propane, without requiring an external reformer to produce hydrogen.

### Contact Information:

**Norman Bessette**

Email: [nbessette@acumentrics.com](mailto:nbessette@acumentrics.com)

Phone: (781) 461-8251 ext. 407

**Acumentrics Corporation**

20 Southwest Park

Westwood, MA 02090

Website: <http://acumentrics.com>

# Low-Cost Hydrogen Sensor for Transportation Safety

Emerging Technology

## Compact, Versatile Sensor Increases Hydrogen Safety at Low Cost

The use of hydrogen fuel in transportation applications requires the development of compact, reliable, low-cost instrumentation for safe operation and process control. Additionally, a sensor system for the vehicle and power generation markets must provide monitoring capability at all times, such as when the vehicle is parked and requires ultralow power operation. An integrated sensor system needs to be developed for prototype production and eventual transfer/licensing to a Tier 1 automotive supplier for volume production. A low-cost, compact, and high-performance hydrogen detection system is also positioned well for the fuel cell/power generation, nuclear safety, and transformer monitoring markets.

Makel Engineering, Inc., has developed, with funding from FCT through the Edison Materials Technology Center, a micro electromechanical systems (MEMS) hydrogen sensor system for hydrogen-powered transportation applications. This MEMS-based sensor technology provides the means for low-cost, compact, low-power consumption, miniaturized systems, suitable for mass production. The system was designed around Makel's current state-of-the-art hydrogen sensor that incorporates a highly sensitive Schottky diode made of a palladium (Pd) alloy on a silicon substrate for measurements in the low concentration range (50 ppm to a few percent). Additionally, sensor elements with a resistive structure incorporating Pd-based nanoclusters or nanowires are under development for ultra-fast time response and wide concentration range measurements.

This sensor will allow low-cost monitoring of hydrogen leaks in fuel cell automobiles, stationary power supplies, and other areas where hydrogen leakage poses a safety concern. This project won a 2006 R&D 100 award. Automotive testing of the sensor is now underway, and work is starting on using hydrogen-sensitive nanomaterials to provide lower sensor cost, simplified manufacturing, and improved detection capabilities.

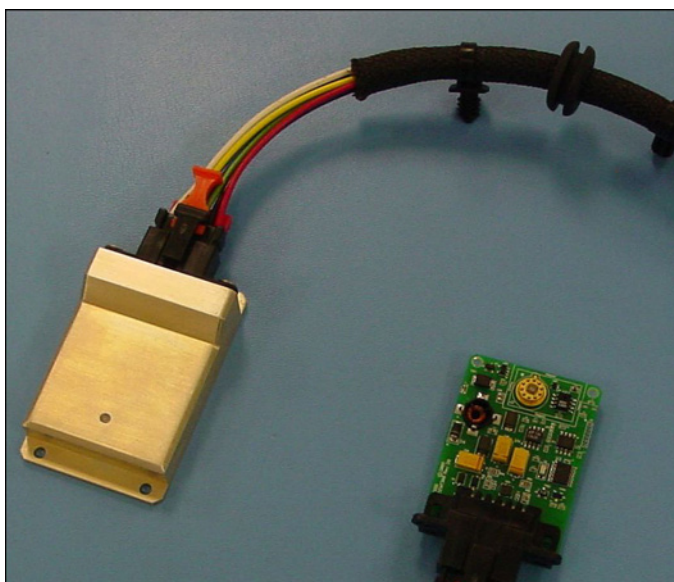

*Makel's Low-Cost Hydrogen Sensor for Transportation Safety*

## Technology History

- ◆ Developed by Makel Engineering, Inc., in collaboration with Argonne National Laboratory and Case Western Reserve University. Actively seeking commercial partnerships.
- ◆ Continuing sensor testing with automotive companies and work on nanomaterial enhancements to the sensor.

## Applications

Can be used anywhere hydrogen gas leakage is a concern, such as fuel cell powered automobiles and stationary power systems.

## Capabilities

- ◆ Allows miniaturized detection systems to be created because of the sensor's small size.
- ◆ Can be used for continuous monitoring applications.

## Benefits

### Cost Savings

Reduces sensor cost due to mass-production manufacturing.

### Safety

Detects hydrogen from 50 ppm up to 100% in oxygen and inert backgrounds.

#### Contact Information:

**Dr. Benjamin Ward**

Email: [bward@mackelengineering.com](mailto:bward@mackelengineering.com)

Phone: (408) 543-1500

**Makel Engineering, Inc.**

15505 Neo Parkway

Cleveland, OH 44128

Website: <http://www.mackelengineering.com>

# Low-Cost Manufacturing of Sheet Molding Compound Bipolar Plates for PEM Fuel Cells

Emerging Technology

## New Technology Allows Large-Scale Manufacturing of Fuel Cell Plates

The bipolar plate is known to significantly impact the performance, durability, weight, and cost of a fuel cell system, the four technical barriers identified by the U.S. Department of Energy (DOE). The bipolar plate is one of the most costly and bulkiest component in a polymer electrolyte membrane (PEM) fuel cell, (33% cost, 80% weight, and 95% volume) and therefore dictates the gravimetric and volumetric power density of a fuel cell stack.

To overcome these technical barriers Nanotek Instruments Inc., with the help of DOE Small Business Innovation Research grants and in collaboration with the National Composite Center, is developing an innovative class of low-cost sheet molding compound (SMC) bipolar plates and related mass-production processes. The composition of the SMC consists of a thin nanocomposite core layer sandwiched between two sheets of flexible graphite (FG). The nanocomposite consists of thermo set resin and conductive nanofiller (graphitic nanofibers) and nano-scaled graphene plates. The nanocomposite lowers material costs and improves electrical, mechanical, and gas permeation resistance properties. These nanocomposite materials can be as thin as 0.125 mm and, when assembled, provide compact, lightweight, and ultra-thin bipolar plates.

The developed FG-SMC bipolar plates meet or exceed DOE targets for conductivity, cost per kilowatt, weight, gas permeation rate, corrosion, strength, and flexibility. Nanotek has successfully demonstrated a roll-to-roll SMC fabrication process, which continuously produces a nanocomposite core laminated on both sides with flexible graphite sheet and partially cured resin. This sheet can then be die-cut, molded into the desired shape, and fully cured. The process can similarly fabricate fluid flow channels using in-line embossing and curing on the outer surfaces of the SMC laminate to produce bipolar plates. The process is well suited to mass production of low-cost bipolar plates. The current focus is on finalizing commercialization strategies, including market validation and expansion, business plan development, and sourcing of materials, components, and subsystems.

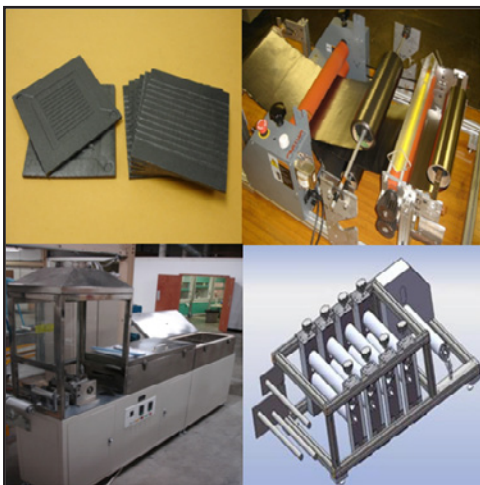

*Nanotek's Roll-to-Roll System for Producing Multiple-Layer Bipolar Plates*

## Technology History

- ◆ Developed by Nanotek Instruments, Inc. and industry collaborators.
- ◆ Continuing work on establishing product specifications, constructing a pilot-scale unit, marketing, and conducting other business activities.

## Applications

Can be used to develop low-cost/high-performance bipolar plates for fuel cells using sheet molding compound manufacturing techniques.

## Capabilities

- ◆ Produces low-cost fuel cell bipolar plates.
- ◆ Achieves high performance with low cost.
- ◆ Allows large-scale manufacturing of sheets of bipolar plate material.

## Benefits

### Efficiency

Optimizes the composition and forming process, improving the performance of SMC bipolar plates.

### Productivity

Reduces manufacturing costs through large-scale sheet manufacturing and significantly reduces fuel cell weight, dimensions, and contact resistance.

### Contact Information:

**Bor Z. Jang**

Email: [Bor.Jang@Wright.edu](mailto:Bor.Jang@Wright.edu)

Phone: (937) 331-9881

**Nanotek Instruments, Inc.**

1240 McCook Ave.

Dayton, Ohio 45404

Website: <http://www.nanotekinstruments.com>

# Low Platinum Loading Fuel Cell Electrocatalysts

Emerging Technology

## New Catalyst Resists Carbon Monoxide Poisoning With Less Platinum

In hydrogen fuel cells the performance of the catalysts is extremely sensitive to small amounts of carbon monoxide (CO) contamination. The CO contamination causes poisoning of the catalyst, rendering it unable to convert the hydrogen gas into electricity and therefore shortening the life of conventional fuel cells. In addition, conventional fuel cell catalysts can contain platinum, which is extremely expensive. A catalyst that resists CO contamination and uses less platinum is needed.

Brookhaven National Laboratory (BNL), with funding from FCT, has developed patented anode electrocatalysts having low platinum loading that resist CO poisoning. The anode includes an electrocatalyst that has an electrically conductive support material, ruthenium nanoparticles, and a Group VIII noble metal. The ruthenium nanoparticles are deposited on a support material, heated in a hydrogen atmosphere, cooled, and then coated with the Group VIII noble metal compound. The weight ratio of platinum to ruthenium is from 0.02:1 to about 0.15:1. The conductive support material is made of finely divided carbon material, such as carbon black, graphitized carbon, graphite, or activated carbon. The ruthenium nanoparticles are about 1 nm to about 50 nm, preferably about 2 nm to 20 nm.

For oxygen reduction, BNL is also developing a novel class of cathode electrocatalysts consisting of platinum monolayers deposited on the surfaces of noble metal/non-noble metal core-shell nanoparticles. These new electrocatalysts have been demonstrated to have high activities and a very low platinum mass in the monolayer. The platinum mass activities are about an order of magnitude higher than those of commercial electrocatalysts. The platinum monolayers were electrodeposited on metal or alloy nanoparticles using galvanic displacement of a copper monolayer. Future work is focused on fuel cell tests of several types of platinum monolayer electrocatalysts, stability studies, and further reduction in platinum content using core-shell nanoparticle and oxide supports.

## Technology History

- ◆ Developed by BNL in collaboration with Los Alamos National Laboratory, Battelle Memorial Institute, 3M Company, Plug Power Inc., and General Motors Company.
- ◆ Is seeking industrial partners to license and further develop these technologies.

## Applications

Can be used in fuel cells to enhance their performance by eliminating CO poisoning at a lower platinum cost.

## Capabilities

- ◆ Survives in a CO environment without degradation.
- ◆ Allows the use of less platinum while maintaining performance.

## Benefits

### Cost Savings

Reduces costs due to lower content of noble metal.

### Durability

Resists CO poisoning for increased lifespan.

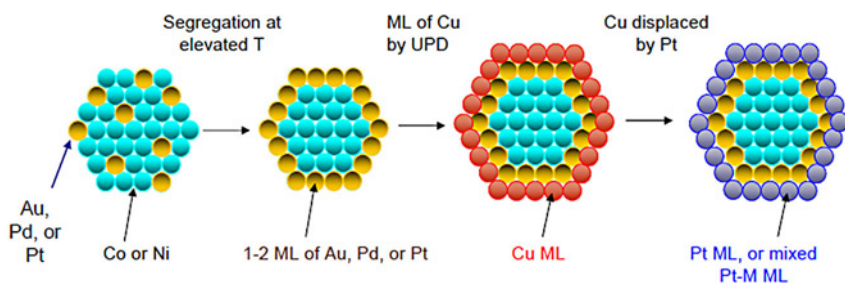

*Synthesis Route for BNL's New Class of Cathode Electrocatalysts*

### Contact Information:

**Dr. Kimberley Elcess**

Email: [elcess@bnl.gov](mailto:elcess@bnl.gov)

Phone: (631) 344-4151

**Brookhaven National Laboratory**

Building 185

Upton, NY 11973-5000

Website: <http://www.bnl.gov>



# Manufacturing of Low-Cost, Durable Membrane Electrode Assemblies

Emerging Technology

## Process Produces Low Cost Pre-Conditioned Membrane Electrode Assemblies

Currently, most of the U.S. Department of Energy's (DOE's) fuel cell technical targets for 2015 are achievable; however, three challenges remain: reducing costs, producing components that are compatible with high-speed automotive assembly, and achieving operational durability. Cost reduction is being investigated through materials research, material use, and fuel cell stack construction. Another significant factor in lowering costs is a high-volume manufacturing process. Such a process must be designed for improved safety as well as optimal reduction of the amount of materials and chemicals used. In addition, the number of intermediate process steps and time required for in-stack membrane electrode assemblies (MEAs) conditioning must be minimized.

W. L. Gore & Associates, Inc. (Gore), and industry partners, with funding assistance from the U.S. Department of Energy's Fuel Cell Technologies Program, are developing a high-volume manufacturing process to produce low-cost, durable, high-power density three-layer MEAs that require minimal conditioning. The process is scalable to industry MEA volume targets of 500-K systems per annum and is consistent with achieving DOE's 2015 transportation fuel stack cost target of \$15/kWe, assuming raw material costs forecast by DTI Energy, Inc., and TIAX LLC. MEA durability is being addressed by optimizing mechanical durability and power density of three- and five-layer designs, which use Gore's advanced expanded polytetrafluoroethylene (ePTFE) membrane reinforcement and perfluorosulfonic acid ionomers. The designs are being further optimized by computer modeling the MEA's mechanical stress as well as thermal and water management.

Durability testing results of MEAs made with Gore's thin, reinforced membranes have reached 9,000 hours of operation in an 80°C automotive duty cycle, exceeding the DOE's 2015 target by 5,000 hours. In the near term, Gore will be addressing membrane conditioning and begin scaling up three-layer MEA fabrication in a roll-to-roll manufacturing process.

## Technology History

- ◆ Developed by Gore and other industry collaborators.
- ◆ Preparing to investigate MEA conditioning and scaling-up manufacturing process.

## Applications

Can be used in fuel cell applications for transportation, backup power, and portable power.

## Capabilities

- ◆ Achieves DOE 2015 targets for high-volume manufacturing and durability.
- ◆ Improves MEA power density compared with MEA produced with current standard processing methods.
- ◆ Offers scalable high-volume manufacturing process.
- ◆ Achieves MEA conditioning times of less than four hours.

## Benefits

### Cost Savings

Achieves MEA manufacturing consistent with achieving DOE's cost target of \$15/kWe.

### Environment

Reduces waste material and solvent during processing.

### Manufacturability

Produces a product that is compatible with automotive assembly line manufacturing.

### Contact Information:

F. Colin Busby

Email: [CBusby@WLGore.com](mailto:CBusby@WLGore.com)

Phone: (410) 392-3200

W.L. Gore and Associates, Inc.

201 Airport Rd.

Elkton, MD 21921

Website: <http://www.gore.com>

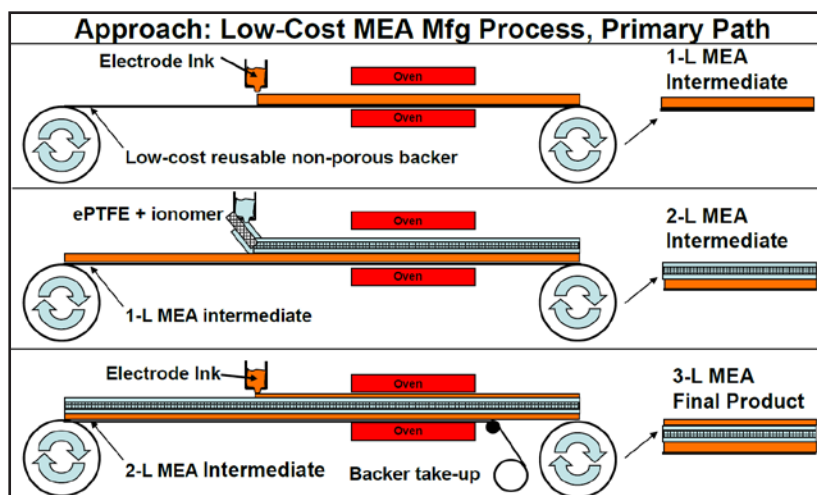

Gore's 3-Layer MEA High-Volume Manufacturing Process

# Materials and Modules for Low-Cost, High-Performance Fuel Cell Humidifiers

Emerging Technology

## Durable Membrane Increases Fuel Cell Performance and Efficiency

Fuel cells have shown great progress and promise as a viable alternative technology for automotive applications. Many major automotive manufacturers are conducting research and development of fuel cell vehicles. Moisture in the system plays an important role in overall fuel cell efficiency. Because electric charge transport is highly dependent on the humidity of the gases entering and exiting the fuel cell, many system providers are investigating systems that use the product water of the fuel cell reaction to humidify the incoming fuel cell reactants, especially on the cathode side. Typically, the hydrogen stream is recycled to ensure maximization of the fuel utilization.

W. L. Gore & Associates, Inc. and industry partners, with funding from the U.S. Department of Energy's Fuel Cell Technologies Program, are developing an inexpensive and durable composite membrane capable of very high water transport. The membrane can provide the high transport rate required by overcoming the cost and physical limitations of thin perfluorosulfonic acid membranes. The membrane structure consists of an ionomer layer sandwiched between micro porous polymer expanded polytetrafluoroethylene layers. The ionomer layer provides active water transport but is impermeable to prevent gas crossover, which can reduce fuel cell efficiency. The micro porous layers protect the thin ionomer layer from mechanical damage and enhance durability during operation. These layers can provide support for additional layers necessary for ease of handling and assembly, e.g., gas diffusion layers.

Several companies within the fuel cell community have provided preliminary feedback on membrane performance and durability and are testing this new material for implementation in their humidifier modules. Argonne National Laboratory (ANL) is collaborating with Gore to examine the effect of this new material on ANL's automotive fuel cell system computer model. These results and other feedback from the industry should lead to higher performance, lower-cost (\$/kW) automotive systems.

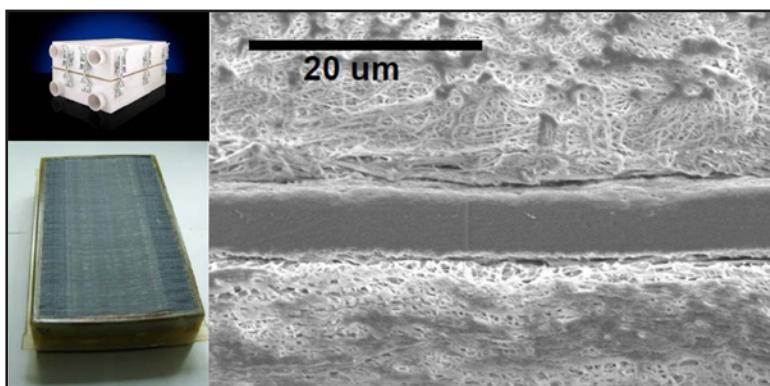

W.L. Gore's Membrane and High Transport Rate Modules

## Technology History

- ◆ Developed by W.L. Gore & Associates, Inc. and industry partners.
- ◆ Continuing work on collaborating with automotive original equipment manufacturers in fuel cell applications.

## Applications

Can be used to improve fuel cell efficiency and durability at reduced cost for transportation or stationary applications.

## Capabilities

- ◆ Increases fuel cell efficiency and performance by increasing water transport within the cell.
- ◆ Improves durability by using a unique combination of ionomer and micro porous layers in the membrane structure.

## Benefits

### Cost Savings

Reduces system costs by using less expensive materials and decreasing overall system size.

### Flexibility

Can be used for non-fuel-cell applications that require optimized systems with high water transport rates.

### Contact Information:

**Dr. Mahesh Murthy**

Email: [mmurthy@wlgore.com](mailto:mmurthy@wlgore.com)

Phone: (410) 506-7638

**W.L. Gore and Associates, Inc.**

201 Airport Rd.

Elkton, MD 21922-1488

Website: <http://www.gore.com>

# Multi-Fuel Solid Oxide Fuel Cell (SOFC) System

Emerging Technology

## New Fuel Cell System Produces Heat and Electricity from Renewable Biofuels

Although fuel cell technology has been under serious development for over three decades, progress has been hampered by the need to have highly purified gaseous fuels (primarily hydrogen) to produce electricity. Reforming hydrocarbon fuels, particularly high molecular weight liquids, has been difficult. Yet operation on common, available fuels are required to enter mass-markets, and higher efficiencies are required to reduce the cost of overall electric generation efficiency and greenhouse gas emissions. Solid oxide fuel cells (SOFCs) are high-temperature ceramic devices that produce power electrochemically by transporting oxygen ions through a ceramic electrolyte from the air side to the fuel side, inducing an electric current in an external circuit. The products of the electrochemical conversion are heat and water. The residual high-temperature heat exhaust, when used for cogeneration with other processes, can enhance overall system efficiency.

Technology Management, Inc. (TMI), with funding from FCT through the Edison Materials Technology Center, has developed and demonstrated an integrated high efficiency reformer/SOFC system that can operate on multiple renewable and conventional fuels, including biodiesel, vegetable oils, ethanol, diesel, kerosene, natural gas, and propane. The 1-kW modular, multi-fuel SOFC system is designed to produce electricity and heat for multiple mobile and on-site stationary applications in rural and remote parts of the world, particularly where infrastructure may be marginal or not available. Simplicity is a key feature of the patented TMI SOFC cell and stack design. The simple design allows the use of high-volume, low-cost fabrication techniques, ease of cell and stack assembly, and straightforward thermal integration of the catalytic steam reforming with the fuel cell stack. The system is expected to achieve electrical efficiencies of >40% with overall energy efficiencies >80%.

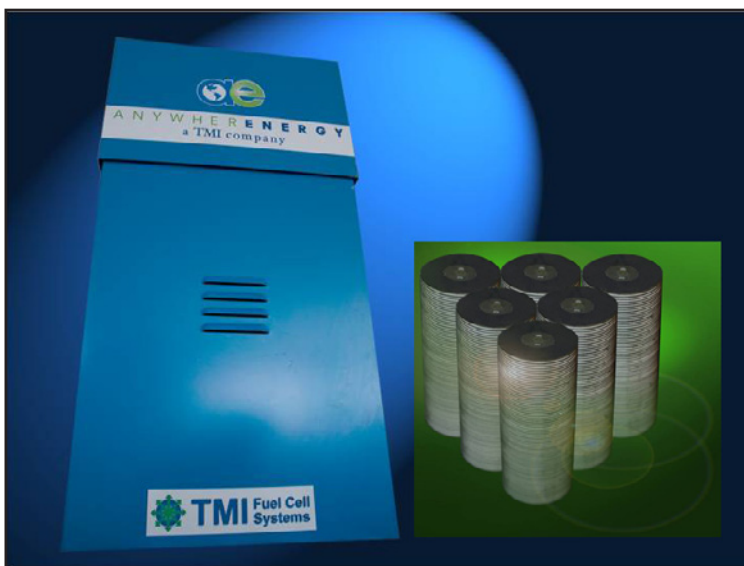

TMI's Multi-Fuel SOFC Technology

## Technology History

- ◆ Originally developed SOFC by Standard Oil of Ohio and BP and technology platform by TMI.
- ◆ Now engineering full-scale system for manufacturing and field testing at end-user sites in preparation for original equipment manufacturer licensing.

## Applications

- ◆ Can be used for both stationary residential-scale and mobile applications such as on-board auxiliary power units for anti-idling of long-haul truck engines.
- ◆ Can be used in remote locations on indigenous fuels such digester biogas and vegetable oils.

## Capabilities

- ◆ Provides continuous 24/7 power.
- ◆ Operates interchangeably between fossil and renewable biofuels without shutdown.

## Benefits

### Cost Savings

Offers a simple cell and system design for low-cost, automated manufacturing. Is two to three times more efficient than a comparable-sized diesel-driven generator.

### Versatility

Is scalable for more power by using multiple modules in parallel that also provide redundancy. Is field upgradeable and compatible with multiple fuels, including high sulfur fuels and renewable biofuels.

### Contact Information:

**Benson P. Lee**

Email: [tmi@stratos.net](mailto:tmi@stratos.net)

Phone: (216) 541-1000

**Technology Management, Inc.**

9718 Lake Shore Blvd.

Cleveland, Ohio 44108

Website: <http://www.anywhereenergy.com>



# Nitrided Metallic Bipolar Plates for PEM Fuel Cells

Emerging Technology

## Process Makes Corrosion-Resistant Stainless Steel Bipolar Plates for Fuel Cells

Bipolar plates are a key component for polymer electrolyte membrane (PEM) fuel cells. They electrically connect individual fuel cells into a stack to achieve a useful voltage and separate and distribute hydrogen and air flow streams. Stainless steels are of great interest for bipolar plates because they can be readily made into thin foils amenable to low-cost/high-volume manufacturing methods such as stamping. However, in the highly corrosive fuel cell service environment, most stainless steels exhibit borderline corrosion resistance, which can result in metal contamination of the fuel cell membrane and a loss of performance. They also exhibit high values of interfacial contact resistance (ICR) because oxide surface layers can form, further contributing to performance degradation. To address these problems, Oak Ridge National Laboratory (ORNL), with funding from FCT, is developing low-cost stainless steel bipolar plate alloys designed to be thermally (gas) nitrided to form an electrically conductive and corrosion-resistant Cr-nitride surface layer.

The Cr-nitride coating is naturally formed by heating the manufactured part to elevated temperature ( $>800^{\circ}\text{C}$ ) in a nitrogen-containing gas. The stainless steel alloy is specifically designed so that the Cr in the alloy moves to the surface of the part where it forms a thin (micron range) Cr-nitride surface layer. Low ICR and excellent corrosion resistance have been demonstrated for thermally nitrided Ni-Cr base alloys in PEM fuel cell environments. A key advantage of the ORNL thermal nitridation approach is the potential to form continuous, defect-free surface nitride layers on complex-shaped components at relatively low cost. Nitridation is also an industrially established process, primarily used for surface hardening. Currently, scale-up evaluation and demonstration are in progress in partnership with a stainless steel manufacturer, ATI Allegheny Ludlum Corp., in collaboration with Arizona State University, the National Renewable Energy Laboratory (NREL), and Los Alamos National Laboratory (LANL).



*ORNL's Nitrided Metallic Bipolar Plates  
(Produced in collaboration with DANA Corporation, Tennessee  
Technological University, and the University of South Carolina)*

## Technology History

- ◆ Developed by ORNL, in collaboration with Arizona State University, ATI Allegheny Ludlum Corp., LANL, and NREL.
- ◆ Continuing work on characterizing the corrosion and electrical properties of nitrided foils and single-cell testing of stamped and nitrided alloys compared with untreated stainless steel and graphite plates.

## Applications

Can be used for PEM fuel cell bipolar plates but may be applicable to any electrochemical device component requiring high electrical conductivity and corrosion resistance (e.g., batteries, sensors, and supercapacitors).

## Capabilities

- ◆ Allows formation of continuous, defect-free surface nitride layers on complex-shaped components.
- ◆ Lowers ICR in fuel cells.
- ◆ Reduces corrosion in fuel cells.

## Benefits

### Cost Savings

Extends the life of fuel cell bipolar plates by reducing corrosion.

### Productivity

Increases the efficiency of fuel cells by reducing ICR.

#### Contact Information:

**Dr. Michael P. Brady**

Email: [bradymp@ornl.gov](mailto:bradymp@ornl.gov)

Phone: (865) 574-5153

**Oak Ridge National Laboratory**

P.O. Box 2008-03-25

Oak Ridge, TN 37831-6115

Website: <http://www.ornl.gov>

# Platinum and Fluoropolymer Recovery from PEM Fuel Cells

## Patented Process Recovers High Value Materials from Used Fuel Cells

Polymer electrolyte membrane (PEM) fuel cells are currently targeted for widespread back-up power and transportation applications. Current fuel cells contain valuable platinum (Pt), which can be recovered for reuse. The Pt is in the form of a Pt-carbon-ionomer mixture coated onto a Nafion<sup>®</sup> membrane to form a catalyst coated membrane (CCM) or membrane electrode assembly (MEA). Because the loading of Pt is about 2 g/kW, large systems contain enough material to make recycling economically feasible. The commercialization of fuel cell systems will increase demand for Pt group metals (PGMs). Without recycling PGMs, the long-term availability of Pt becomes a serious limitation. Therefore, Pt recycling is critical to the long-term economic sustainability of PEM fuel cells. Unfortunately, conventional Pt recovery processing is ill-suited for fuel cell components because the acid solvent method has a low recovery rate; the Pt particles are covered by the ionomer; and the Nafion<sup>®</sup> fluorine-containing polymer decomposes at high temperature, resulting in toxic and corrosive hydrogen fluoride gas being released. Thus, an advanced process is needed that enables the extraction and reuse of both the Pt and the ionomer in current fuel cell components.

Ion Power, Inc., has developed and patented, with FCT funding, a process that allows for the remanufacture of new MEAs made from used CCMs extracted from failed fuel cell stacks. The first step in this process is to remove the CCMs from the disassembled stacks and then dissolve the CCMs in an autoclave reactor to form a slurry of dissolved Nafion and the carbon-supported, Pt-catalyst particles. The second step is to separate these two valuable ingredients and allow the Nafion-containing solution to be reprocessed into a new fuel cell membrane. Ideally, the recovered Pt catalyst will be re-deposited on the remanufactured membrane so that a completely remanufactured CCM is the final product. To do this, recovered catalyst and Nafion are characterized to examine the changes of properties and structures during the component's life. The proper manufacturing process will be developed based on the properties and structures of recovered materials to realize a completely remanufactured CCM.

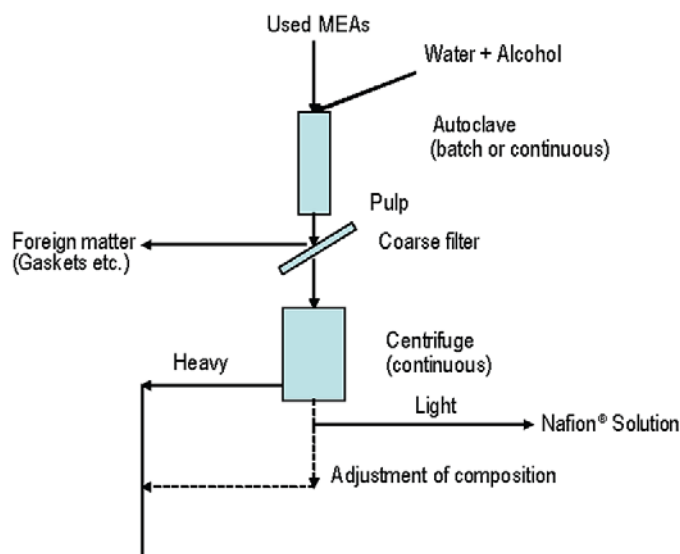

*Ion Power's Recycling Process for MEAs*

## Technology History

- ◆ Developed by Ion Power, Inc., in conjunction with DuPont Fuel Cells and Delaware State University.
- ◆ Looking for a commercial company as a partner to help commercialize the process.

## Applications

Can be used for fuel cells that have reached the end of their useful life to recover the valuable raw materials that remain in the fuel cell membrane.

## Capabilities

- ◆ Allows for recycling of valuable platinum from used fuel cells.
- ◆ Prevents the formation of dangerous hydrofluoric acid fumes during recycling.
- ◆ Allows for remanufacturing of CCMs for fuel cells from the recovered fluoropolymer material.

## Benefits

### Cost Savings

Reduces the replacement cost of fuel cells by recovering valuable materials from used cells.

### Environmental

Eliminates the emission of hydrofluoric acid to the environment.

#### Contact Information:

**Dr. Stephen Grot**

Email: [s.grot@ion-power.com](mailto:s.grot@ion-power.com)

Phone: (302) 832-9550

**Ion Power, Inc.**

720 Governor Lea Road  
New Castle, DE 19720

Website: <http://www.ion-power.com>

# Platinum-Group-Metal Recycling Technology

Emerging Technology

## New Method Recovers Platinum from Various Membrane Types

Fuel cell manufacturers are using different platinum-containing materials for membrane electrode assemblies (MEAs) in polymer electrolyte membrane (PEM) fuel cells. In addition, designs use either catalyst-coated membranes (CCMs) or gas diffusion electrodes (GDEs). These fuel cell components contain platinum (Pt) metal in their design; as the fuel cell ages, some of the Pt metal migrates throughout the membranes but is not consumed in the process. Because Pt is a valuable precious metal, recycling used fuel cells is worthwhile to recover the precious metal. However, the various types of fuel cell designs and materials make recovery difficult with a single process. Conventional recovery methods involve incineration, which creates undesirable by-products such as hydrogen fluoride gas from the MEA layers. The gas itself is poisonous and unsafe in the environment and combines with water vapor to form an extremely corrosive acid that dissolves glass and corrodes machinery used in the recycling process.

BASF Catalysts LLC, with FCT funding, is addressing these problems by developing a uniform process to recover and recycle precious metals (primarily Pt) used in constructing PEM fuel cell MEAs. This process is superior to the conventional Pt reclamation practice of MEA combustion, which liberates hydrogen fluoride gas from the perfluoropolymers used in the MEA. Instead, BASF has developed a process that leaches the precious metal from the MEA, eliminating the need for combustion. The process is applicable to CCM and GDE MEAs, as well as next-generation base-metal alloyed electrocatalysts. The process can be used for used MEAs and production scrap. In addition to the work done with Nafion®-based MEAs, the process has also been validated with MEAs that have polybenzimidazole membranes.

## Technology History

- ◆ Developed by BASF Catalysts LLC, in partnership with Ceralink, Inc.
- ◆ Technology is ready for commercialization after a market for precious metal recovery from fuel cells develops.

## Applications

Can be used to provide a recycling option for used fuel cells that eliminates the formation of hydrogen fluoride fumes.

## Capabilities

- ◆ Allows for single process batching of multiple fuel cell types.
- ◆ Achieves high process yields independent of MEA aging history, membrane construction, or electrocatalyst composition.

## Benefits

### Cost Savings

Achieves economy of scale by facilitating batching of recycled fuel cell lots.

### Efficiency

Recovers >98% of the platinum in MEAs.

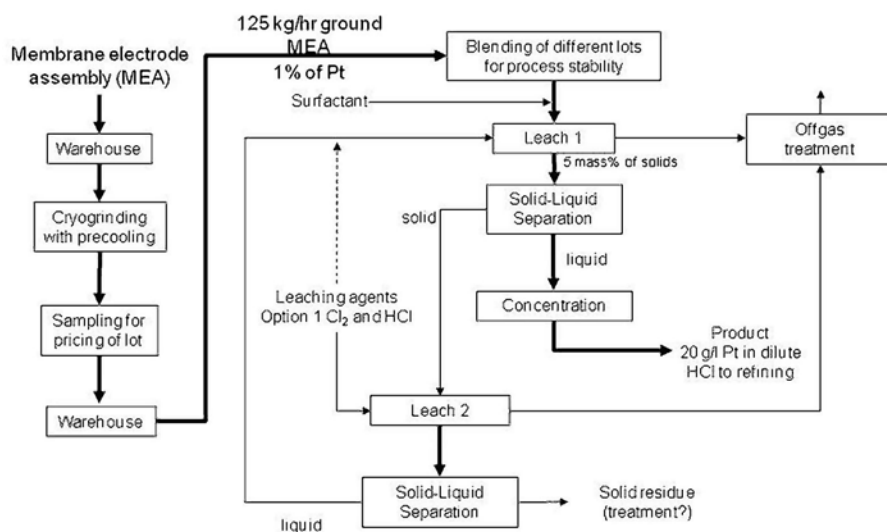

BASF's Platinum Recycling Process

### Contact Information:

**Bob Farrauto**

Email: [bob.farrauto@basf.com](mailto:bob.farrauto@basf.com)

Phone: (732) 205-5306

**BASF Catalysts LLC**

25 Middlesex Turnpike

Iselin, NJ 08830

Website: <http://www.basf.com>

# Platinum Monolayer Electrocatalysts on Stable Low-Cost Supports

Emerging Technology

## Low-Platinum Electrocatalyst Resists Noble Metal Dissolution

Over the last decade, advances have been made in fuel cell electrocatalysis, improved electrocatalysts, and the understanding of the kinetics of the oxygen reduction reaction. However, some technological barriers still hamper widespread adoption of fuel cells in transportation. One barrier where R&D has reached a limit is in decreasing the platinum (Pt) particle size in order to increase the surface area and activity. The adverse effect of small particles oxidation prevents further improvements from being achieved using that approach. While Pt is the best electrocatalyst, substantial loadings are still required, resulting in unacceptably high costs.

To address the Pt activity and loading technical barriers, Brookhaven National Laboratory (BNL), with funding from the U.S. Department of Energy's Fuel Cell Technologies Program, is developing a high-surface-area electrocatalyst using Pt monolayers on suitable metal or alloy nanoparticles. When the oxygen reduction reaction is catalyzed, these catalysts have several times higher activity per mass of Pt than pure Pt nanoparticles. To further improve these catalysts, the atomically thin layers of Pt can be deposited as contiguous metal adlayers on transition metal nanostructures, such as nanorods, nanowires, and nanobars. The electrocatalysts are produced by forming a continuous, atomically thin adlayer of non-noble metal atoms (e.g., copper) on the nanostructured core and then by immersing the coated nanostructures in a solution containing noble metal ions. The high noble-metal mass activity reduces the need to incorporate expensive materials such as Pt, resulting in lower overall costs for the inventive electrocatalysts.

Fifty-gram batches have been produced, and further scale-up work has begun. The electrocatalysts have been tested to investigate the reaction behavior using a rotating disk method. Performance and durability testing also has been performed in prototype fuel cells. Work is ongoing to adapt membrane electrode assemblies to more effectively incorporate the novel electrocatalysts.

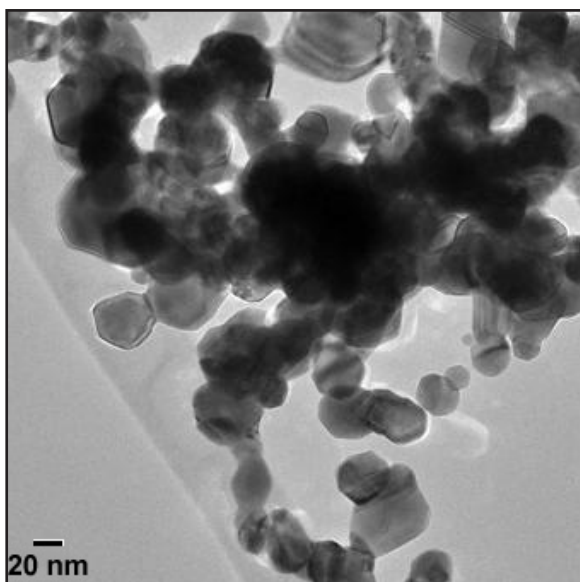

BNL's Pt-Coated Palladium Nanostructures

## Technology History

- ◆ Developed by BNL.
- ◆ Continuing testing of prototype electrocatalysts in membrane electrode assemblies and fuel cells.

## Applications

Can be used for oxygen reduction such as in fuel cells and as a heterogeneous catalyst.

## Capabilities

- ◆ Achieves high activity for the oxygen reduction reaction in fuel cells.
- ◆ Resists Pt dissolution under cycling conditions.
- ◆ Reduces Pt loading.

## Benefits

### Cost Savings

Reduces costs by reducing Pt loading while maintaining excellent activity for oxygen reduction.

### Durability

Improves product lifetime by using sacrificial transition metal cores.

### Contact Information:

**Dr. Kimberley Elcess**

Email: [elcess@bnl.gov](mailto:elcess@bnl.gov)

Phone: (631) 344-4151

**Brookhaven National Laboratory**

Bldg. 490C – P.O. Box 5000

Upton, NY 11973-5000

Website: <http://www.bnl.gov>



# Polymer Electrolyte Membrane (PEM) Fuel Cell Power Plant Development and Verification

Emerging Technology

## New PEM Fuel Cell for Stationary Power Plant Applications

Commercialization of fuel cells for stationary power applications requires high availability and multiple grid connections. High availability requires that the mean time between forced outages (MTBFO) should be at least 5,000 hours. Multiple grid connections require control systems to ensure compatibility with any U.S. grid. Power requirements range from 5 kW to 150 kW or more for stationary applications, exceeding the capacity of most current technologies.

The problem is large-scale fuel cells (e.g., 150 kW) are difficult to build. The PEM for a 150-kW fuel cell would be very difficult to fabricate because of its large size and requirement for even gas flow and support. Large membranes are prone to early failure if the surface has any defects, which reduces the MTBFO. Higher power control circuits increase the complexity of ensuring compatibility with any U.S. grid.

To address these challenges, UTC Power, with FCT funding, is focusing on demonstrating technology for low-cost, high-durability stationary fuel cells using a 5-kW system platform to verify fundamental technologies in a complete system environment. The 5-kW platform is an efficient method to evaluate and build on lessons learned during early 150-kW power plant demonstration activities. Because durability is a requirement of stationary power supplies, the project is working towards a goal of a 40,000-hour fuel cell stack life. This goal is being accomplished by developing accelerated testing strategies to characterize the mechanical and chemical stability of seal materials. In addition, an accelerated chemical-mechanical test was developed to screen membranes for durability. The end result will be an affordable, durable PEM-fuel-cell based power plant for stationary applications.

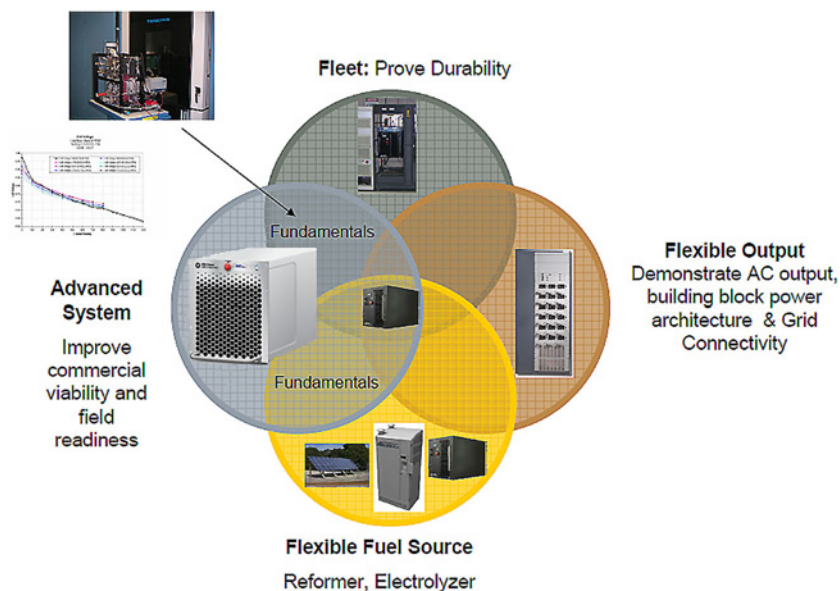

UTC Power's Approach for the 5-kW Fuel Cell Development

## Technology History

- ◆ Developed by UTC Power in partnership with the Houston Advanced Research Center, U.S. Hybrid Corporation, TDI Power, and Avalence, LLC.
- ◆ Continuing work on system refinement, certification, and endurance testing and seeking field demonstration partners with potential commercial customers.

## Applications

Can be used to provide clean, efficient power for stationary applications.

## Capabilities

- ◆ Provides 5 kW to 20 kW of electrical power with path to large-scale power output (150 kW).
- ◆ Provides an alternative to conventional internal combustion power sources.
- ◆ Eliminates noise and pollution associated with conventional supplies.

## Benefits

### Cost Savings

Reduces development costs to close technology gaps by using a 5-kW platform for the powerplant. System cost is significantly reduced with advanced cell stack and balance-of-plant technology.

### Productivity

Exceeds program requirements for membrane internal resistance, open circuit voltage, falloff time, and conductivity.

### Contact Information:

**Sathya Motupally**

Email: [Sathya.Motupally@UTCPower.com](mailto:Sathya.Motupally@UTCPower.com)

Phone: (860) 727-7238

**UTC Power**

195 Governor's Hwy

South Windsor, CT 06074

Website: <http://www.utcpower.com>

# Portable Solid Oxide Fuel Cell Generator

Emerging Technology

## New System Increases Efficiency and Reduces Emissions of Portable Generators

Hundreds of gasoline-fueled portable electric generators are currently deployed at NASCAR events to provide power for media production trailers, audio/video equipment, hospitality tents, and a variety of uses by fans camping on-site in RVs. These internal combustion engine generators, which are located close to the fans, produce undesirably high levels of emissions and noise. An alternative type of portable generator is needed that can provide reliable power without the unwanted side effects of emissions and noise.

With assistance from the U.S. Department of Energy's Fuel Cell Technologies Program (as part of the American Recovery and Reinvestment Act), Jadoo Power Systems, Inc., is developing a new type of portable generator that uses a solid oxide fuel cell (SOFC) as the power element and propane as the fuel. The generator will provide 1 kW of power for up to 8 continuous hours and will operate at  $\geq 30\%$  efficiency for a minimum lifetime of 2,000 hours. SOFC technology developed for truck auxiliary power units by Jadoo's project partner, Delphi Automotive, LLP, is being packaged for use in the portable generators with an alternating current inverter. Delphi is also developing a desulfurizer and a reformer for the propane fuel. The desulfurizer, which is used to prevent sulfur poisoning of the SOFC's electrode catalysts, will reduce the level of sulfur in the propane to  $\leq 10$  parts per billion (ppb) for 8 continuous hours. Jadoo is developing an electromechanical propane fuel interface based on prior knowledge from designing an interface between proton exchange membrane fuel cells and metal hydride canisters that release hydrogen fuel. The interface will provide a user friendly capability for dispensing propane and measuring the amount of propane left in the tank.

Two of the new generator units will be tested at scheduled events by the police and fire departments of Folsom, California, to determine the feasibility of using the systems in emergency and/or off-grid situations. The units will also be deployed at multiple NASCAR events for further evaluation and testing.

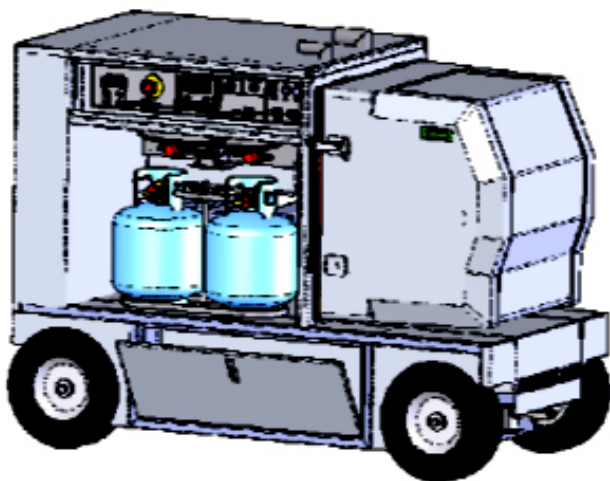

*Mechanical Design of Jadoo Power's Portable SOFC Generator*

## Technology History

- ◆ Developed by Jadoo Power Systems, Inc., in partnership with Delphi Automotive, LLP.
- ◆ Planning to deploy generators for testing at NASCAR events and with the police and fire departments of Folsom, California.

## Applications

Can be used to power portable video and lighting equipment at large sporting events or emergency equipment used by first responders (e.g., police and firefighters) in off-grid situations.

## Capabilities

- ◆ Produces 1 kW of power for up to 8 continuous hours.
- ◆ Operates at  $\geq 30\%$  efficiency for at least 2,000 cumulative hours of runtime.
- ◆ Uses a propane desulfurizer that can reduce the level of sulfur in propane to  $\leq 10$  ppb.

## Benefits

### Emissions Reduction

Reduces emissions (lb-CO<sub>2</sub>/kWh) compared with conventional gasoline-fueled, internal combustion engine portable generators.

### Noise Reduction

Reduces localized noise problems associated with using internal combustion engine generators close to staff and fans at large sporting events.

#### Contact Information:

**Ken Vaughn**

Email: [kvaughn@jadoopower.com](mailto:kvaughn@jadoopower.com)

Phone: (916) 673-3417

**Jadoo Power Systems, Inc.**

181 Blue Ravine Rd.

Folsom, CA 95630

Website: <http://www.jadoopower.com>



## New Technology Increases Productivity of Material Handling Forklift Fleets

Forklift fleets that move material in large warehouses, distribution centers, and manufacturing facilities are typically powered by lead acid batteries. These batteries have a number of characteristics that limit productivity. Battery changing and charging in multi-shift operations require forklifts to be off the floor for up to an hour or more each day, and often requires multiple batteries per truck, costly space-consuming infrastructure, and dedicated personnel. Batteries also experience a drop in voltage as they are used, which can result in diminished equipment performance and increased truck wear.

With assistance from the U.S. Department of Energy's Fuel Cell Technologies Program and the American Recovery and Reinvestment Act, Nuvera Fuel Cells, Inc., is deploying an improved power source called PowerEdge for forklift fleets. PowerEdge consists of a hydrogen fuel cell, lithium-titanate batteries, a compressed hydrogen storage tank, and other balance-of-plant components, all packaged so as to be interchangeable with standard lead acid batteries. Forklift operators can refuel the system, which stays in the truck, in less than two minutes at a hydrogen dispenser that is similar to using a normal gasoline pump. This quick refueling time increases productivity by allowing operators to spend more time moving product on the floor. The hydrogen can be produced on-site using Nuvera's PowerTap™ steam methane reforming technology, or delivered by an industrial gas supplier and compressed, stored, and dispensed using PowerTap refueling equipment.

Conversion of forklift fleets from lead-acid batteries to fuel cells also provides environmental benefits. According to a study performed by Argonne National Laboratory, fuel cells using on-site hydrogen reduce forklift carbon dioxide emissions by 33% compared with national averages for grid-generated electricity used for battery charging.



Class 2 Forklift Powered by Nuvera's PowerEdge Fuel Cell System

## Technology History

- ◆ Developed by Nuvera Fuel Cells, Inc.
- ◆ Currently operating a 14-unit fleet at an H-E-B Grocery warehouse in San Antonio, Texas and a 35-unit fleet at the Defense Distribution Depot in New Cumberland, Pennsylvania.
- ◆ Currently on fourth generation of product development.

## Applications

Can be used as a drop-in replacement for lead acid batteries used to power electric forklifts.

## Capabilities

- ◆ Provides 10 kW of continuous power and up to 40 kW of peak power.
- ◆ Provides constant voltage output with no performance degradation.
- ◆ Uses a rebuildable fuel cell stack for low lifecycle cost.

## Benefits

### Emissions Reductions

Reduces carbon dioxide emissions attributable to forklift operation by an average of 33% compared with batteries charged with grid-generated electricity.

### Productivity

Offers constant voltage over an entire shift. Fast refueling allows operators to spend more time moving product on the floor.

### Versatility

Available in three different models to meet the needs of Class 1 (counterbalance), Class 2 (reach), and Class 3 (pallet jack) lift trucks.

#### Contact Information:

**Gus Block**

Email: [GBlock@nuvera.com](mailto:GBlock@nuvera.com)

Phone: (617) 245-7553

**Nuvera Fuel Cells, Inc.**

129 Concord Road, Building 1  
Billerica, MA 01821

Website: <http://www.nuvera.com/>

# Reduction in Fabrication Costs of Gas Diffusion Layers

Emerging Technology

## Improved Manufacturing Process Enables High-Volume GDL Production at Low Cost

The gas diffusion layer (GDL) is a critical component for state-of-the-art membrane electrode assemblies. To adequately function, current state-of-the-art GDLs require a carbon base layer, a hydrophobic treatment layer and some type of microporous layer. Because of these requirements, the fabrication costs of GDLs are ~\$36/kW or nearly ten times the U.S. Department of Energy's (DOE's) 2015 DOE target of \$4/kW.

Ballard Material Products, Inc., with funding from DOE's Fuel Cell Technologies Program, has developed a GDL manufacturing process that reduces the fabrication costs. Costs are significantly less by reducing the number of process steps, implementing on-line process control tools, improving manufacturing efficiencies and determining the relationship between process parameters and key GDL properties. Ballard designed and implemented a continuous mixing process, replacing slow batch mixing processes. The company also developed a Many-At-A-Time (MAAT) coating process to reduce the number of passes through the coating line. Process control tools such as non-contact thermocouples and basis weight sensors were integrated into the process for improved process controls. As a result, GDL fabrication costs were reduced by nearly 60% to \$16/kW at current production volumes.

Throughout this program, significant progress has been made to reach the 2015 DOE cost target of \$4/kW. The end result of this program will be the design of a Greenfield facility that can meet this cost target at specified target volumes.



*Ballard's Continuous GDL Roll Manufacturing*

## Technology History

- ◆ Developed by Ballard Material Products, Inc., a subsidiary of Ballard Power Systems Inc.
- ◆ Producing 850 mm wide, 800 m long continuous rolls of GDL material.

## Applications

Can be used in a variety of fuel cell applications, e.g., materials handling, back-up power, and transportation.

## Capabilities

- ◆ Improves GDL uniformity and production quality.
- ◆ Increases GDL production capacity for near-term fuel cell markets.
- ◆ Allows next generation GDLs to be designed with properties tailored for specific fuel cell applications.
- ◆ Significantly reduces the fabrication costs and provides a path to reach the 2015 DOE cost target of \$4/kW.

## Benefits

### Cost Reduction

Reduces costs using volume manufacturing.

### Flexibility

Achieves process flexibility for specific customer product needs.

### Manufacturability

Increases capacity by four to nine times.

### Product Quality

Achieves high quality and uniformity using real time process monitoring.

#### Contact Information:

**Jason Morgan**

Email: [Jason.Morgan@Ballard.com](mailto:Jason.Morgan@Ballard.com)

Phone: (978) 452-8961 x5213

**Ballard Material Products, Inc.**

2 Industrial Ave.

Lowell, MA 01851

Website: <http://www.ballard.com>

# Resin-Impregnated, Expanded-Graphite GRAFCELL Bipolar Plates

Emerging Technology

## New Lower-Cost Plates Operate at Higher Temperatures for Improved Performance

One of the main components by weight and volume of a polymer electrolyte membrane (PEM) fuel cell is the bipolar flow-field plate. A large number of these plates are required to produce a stack with the power and performance needed for automotive applications. Existing bipolar plate technology requires improved corrosion resistance, higher power density, improved gas impermeability, higher electrical and thermal conductivity, and lower production costs to meet stringent automotive and materials-handling performance targets.

Meeting these targets requires new materials and production methods. GrafTech International Ltd., with funding from FCT, is developing a new generation of GRAFCELL® bipolar flow-field plate technology that meets all of these needs. This technology uses expanded graphite in conjunction with an advanced high-temperature resin system to form PEM bipolar plates that are designed for high-volume production. High-volume production, combined with increased performance and durability, results in lower-cost PEM fuel cells, which meet the demanding requirements of automotive and materials-handling applications.

To meet these demanding requirements, the resin-impregnated flexible graphite composite has graphite as its continuous phase, allowing the material to retain the low contact resistance, high thermal conductivity, and high electrical conductivity of bulk graphite. High-temperature resins provide mechanical strength and structural stability and allow continuous operation of the composite bipolar plates at temperatures up to 120°C.

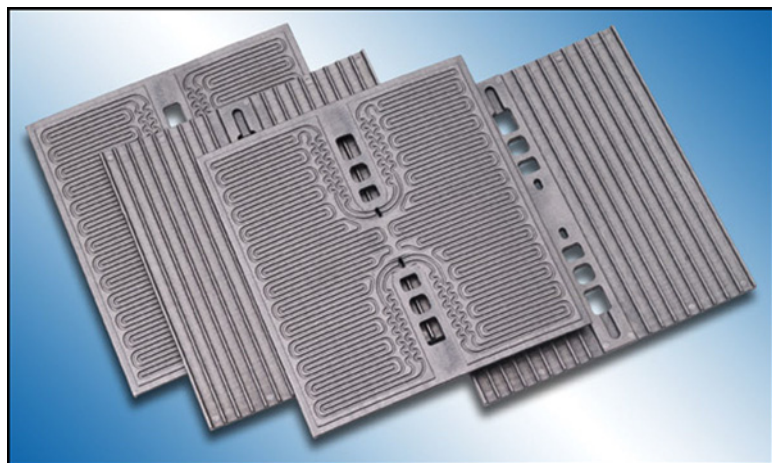

Typical Resin-Impregnated, Flexible-Graphite GRAFCELL Composite Flow-Field Plates (Used with Permission of Ballard Power Systems)

## Technology History

- ◆ Developed by GrafTech International Ltd., in collaboration with Ballard Power Systems, Inc., Huntsman Advanced Materials, and Case Western Reserve University.
- ◆ Project completed, final report written, and now awaiting commercial opportunities to proceed.

## Applications

Can be used in high-temperature PEM fuel cells for transportation, materials handling, and stationary power.

## Capabilities

- ◆ Provides continuous PEM fuel cell operation at 120°C.
- ◆ Achieves high process yields independent of aging history, membrane construction, or electrocatalyst composition of the membrane electrode assembly.

## Benefits

### Cost Savings

Can be fabricated using high-volume, cost-effective manufacturing processes.

### Performance

Operates at temperatures up to 120°C.

### Contact Information:

**Jeff Gough**

Email: [Jeff.Gough@graftech.com](mailto:Jeff.Gough@graftech.com)

Phone: (216) 676-2665

**GrafTech International Ltd.**

12900 Snow Road

Parma, OH 44130

Website: <http://www.graftech.com>



# Sensors for Automotive Fuel Cell Systems

Emerging Technology

## Advanced H<sub>2</sub>S Sensor Protects Fuel Cell Stack from Damage

Fuel cells use hydrogen to generate electrical power. One of the ways to generate hydrogen is by using a hydrocarbon fuel in a steam reformer. However, hydrocarbon fuel can contain sulfur, which forms hydrogen sulfide (H<sub>2</sub>S) gas after it passes through the steam reformers. This H<sub>2</sub>S gas is difficult to detect in the hydrogen-rich stream, and even extremely low levels can damage the fuel cell stack, reducing the stack's life. To avoid these problems, an H<sub>2</sub>S detector is needed, which can be located in a fuel cell power plant to provide continuous data signals to protect the stack from damage.

In an FCT-funded project, completed in 2005, NexTech Materials, Ltd., developed gas sensors required for automotive fuel cell systems. As a subcontractor to UTC Fuel Cells, NexTech pursued the development of sensors for three different gases, including carbon monoxide, ammonia, and H<sub>2</sub>S. The key requirement for these sensors was that the gases of interest needed to be detected in hydrogen-rich gas streams typical of reformed hydrocarbons. A key outcome of this project was the development a H<sub>2</sub>S sensor that can detect extremely low levels of H<sub>2</sub>S in a hydrogen-rich gas.

NexTech's H<sub>2</sub>S sensor operates by a reversible change in resistance caused by adsorption and desorption of H<sub>2</sub>S in a film of an H<sub>2</sub>S sensitive material. The patent-pending H<sub>2</sub>S sensing material has two oxide components: one that is stable in reducing environments and a second that reversibly forms a sulfide in the presence of H<sub>2</sub>S. The sensing material is deposited as a thick film on a substrate. The sensors can detect H<sub>2</sub>S from 25 ppb to 10 ppm, with response times of less than 30 seconds. Application requirements for H<sub>2</sub>S sensors in fuel cell systems vary greatly with respect to the type of fuel cell, the level of H<sub>2</sub>S detection required, the ambient gas composition and temperature.

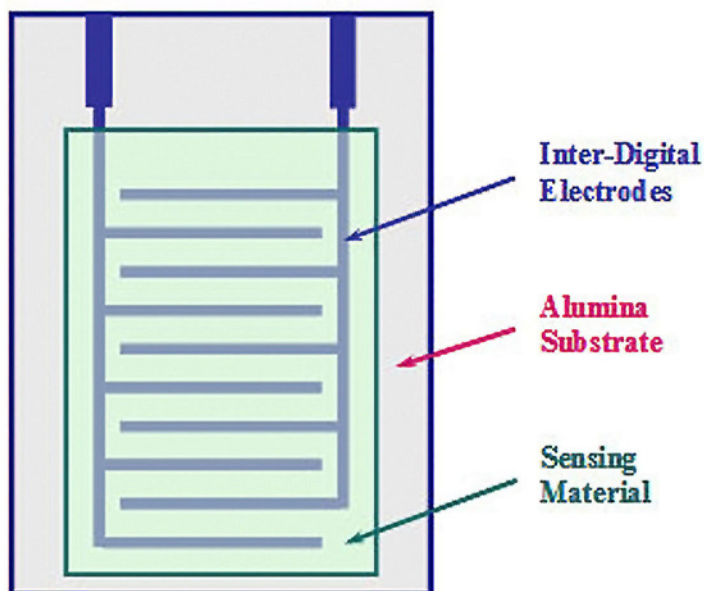

NexTech's H<sub>2</sub>S Sensor

## Technology History

- ◆ Developed by NexTech Materials, Ltd., starting in 2002 as part of DOE's Partnership for a New Generation of Vehicles Program.
- ◆ Filed patent application on the sensor and continues to customize the sensor for specific applications.

## Applications

Can be used for fuel cell power plants using hydrogen generated from hydrocarbon fuels through reforming.

## Capabilities

- ◆ Maintains pure hydrogen streams for fuel cells by continuously monitoring for extremely low levels (25 ppb) of damaging H<sub>2</sub>S gas.
- ◆ Provides a response time of less than one minute.
- ◆ Allows for early detection of hydrogen gas purity problems.

## Benefits

### Cost Savings

Reduces the replacement cost of fuel cells by increasing the life of membranes.

### Product Quality

Enables fuel cells to stay on-line without frequent changing of fuel cell components due to damage from H<sub>2</sub>S.

### Productivity

Extends the life of guard beds, which are used to remove sulfur from hydrocarbon fuels, before being processed into hydrogen to feed a fuel cell.

### Contact Information:

Lora B. Thrun, Ph.D.

Email: [l.thrun@nextechmaterials.com](mailto:l.thrun@nextechmaterials.com)

Phone: (614) 842-6606

NexTech Materials, Ltd.

404 Enterprise Drive

Lewis Center, OH 43035-9423

Website: <http://www.nextechmaterials.com>

# Silicon-Based Solid Oxide Fuel Cell for Portable Consumer Electronics

Emerging Technology

## Novel Technology Enables Efficient Charging of Portable Electronic Devices

Every year, the consumer electronics industry releases new portable devices with an ever-increasing number of features and capabilities. Smart phones, digital cameras, and portable notebooks are running faster and offering larger, brighter display screens. These features consume large amounts of power, and short battery lifetimes often force consumers to plug their devices into a wall outlet for recharging. This poses a problem for on-the-go situations such as airline travel, where wall outlets are not available.

With assistance from the DOE's FCT Program, Lilliputian Systems, Inc. (LSI), is developing a novel miniature fuel cell for the consumer portable power market. LSI's solid oxide fuel cell (SOFC) is fabricated on a silicon chip and is fueled by butane from an on-board cartridge. Within the fuel cell, the butane is converted into hydrogen and carbon monoxide, which react with oxygen ions to give off water, carbon dioxide, heat, and free electrons. The electrons flow through an external circuit and are used to charge a device's battery. To provide high efficiency, the fuel cell is vacuum packaged to minimize heat loss. Micro solid oxide fuel cells are approved by the Federal Aviation Administration to be carried and used by passengers aboard airline flights.

LSI's initial product will plug into various portable electronics via a USB cable connection, but the company also intends to develop more powerful versions that can be incorporated directly into higher-power devices such as laptops. LSI will supply key components to original equipment manufacturers, who will manufacture the complete systems.



*LSI's Silicon Power Cell™ Charging a Mobile Phone*

## Technology History

- ◆ Developed by LSI in partnership with Alfred University and the Missouri University of Science and Technology.
- ◆ Continuing work centered on improving fuel cell power and durability and developing equipment for high-volume manufacturing. Current focus is bringing technology to consumer electronic market via manufacturing agreement with Intel.

## Applications

Can be used as an alternative to conventional wall outlet and battery-based devices for charging portable consumer electronics.

## Capabilities

- ◆ Delivers 2.5 watts of power with a run time of more than 30 hours per cartridge.
- ◆ Achieves a 5-10 times improvement in volumetric energy density and a 20-40 times increase in gravimetric energy density compared with lithium-ion battery alternatives.

## Benefits

### Efficiency

Increases energy efficiency and reduces carbon footprint relative to using electricity provided from a wall outlet.

### Portability

Provides convenient, on-the-go power and eliminates the need for a wall outlet to re-charge electronic devices.

### Contact Information:

**Alan Ludwizewski**

Email: [aludski@lsinc.biz](mailto:aludski@lsinc.biz)

Phone: (978) 203-1706

**Lilliputian Systems, Inc.**

36 Jonspin Rd.

Wilmington, MA 01887

Website: <http://lilliputiansystemsinc.com/>

# Solid Acid Fuel Cell Stack for Auxiliary Power Unit Applications

Emerging Technology

## New Fuel Cell Technology Enables Versatile and Cost-Effective Auxiliary Power Generation

Commercial trucks and other large vehicles often employ small diesel engines for generating auxiliary power to meet climate control, electrical appliance, and engine block heater needs during downtime while the main engine is off. While the small engines are an improvement over main engine idling, diesel engine auxiliary power units (APUs) still produce noise and emissions from electricity generation via fuel combustion. Fuel-cell-based APUs, which electrochemically convert the energy in fuels to electrical power, represent a quieter, more efficient alternative to diesel fuel combustion.

To address this need for an improved APU design, SAFCell, Inc., with funding from FCT, is developing solid acid fuel cell (SAFC) stacks that generate electricity using hydrogen from a variety of commercial fuel reformat sources. The SAFC stacks will be combined with a proprietary diesel reforming technology, supplied by Nordic Power Systems (NPS), to constitute a complete APU. The core of the SAFCell technology is the use of a solid acid electrolyte ( $\text{CsH}_2\text{PO}_4$ ), a solid-state proton conducting material intermediate between normal salts and normal acids. SAFCs operate from 230-280°C, greatly increasing the tolerances of SAFCell stacks to typical fuel impurities (e.g., CO,  $\text{NH}_3$ , and  $\text{H}_2\text{S}$ ), which pose significant performance problems to other fuel cell technologies operating at lower temperatures (< 200°C). As such, SAFCs offer significant performance and cost advantages over these lower-temperature fuel cell technologies when operating on commercially available fuels.

SAFCell's enhanced capability allows its stacks to operate reliably on a variety of reformed gas and liquid fuels, including diesel fuels commonly used in the commercial trucking industry. Additional advantages include simplified water management and cooling subsystems, and inexpensive manufacturing of cell and stack components. SAFCell is continuing to develop and test stacks with outputs of up to 1.5 kW, which are highly optimized for use with the NPS diesel fuel reformer.



SAFCell's 30 W, 250 W, and 800 W SAFC Stacks

## Technology History

- ◆ Developed by SAFCell, Inc., in partnership with Nordic Power Systems.
- ◆ Continuing development and testing of stacks up to 1.5 kW for use with diesel APUs.

## Applications

Can be used for both mobile and stationary applications requiring auxiliary power generation, including buses, large trucks, mobile homes, boats, and remote residential and premium power (e.g., silent watch) applications.

## Capabilities

- ◆ Operates on a wide range of reformat from commercially available fuels, including propane, butane, methanol, liquid petroleum gas, diesel/bio-diesel, and kerosene.
- ◆ Enhances performance and offers near silent operation, quick start-up time, and ability to handle start-stop cycling.

## Benefits

### Cost Savings

Enables cost-reducing system simplifications when operating on commercially available reformed fuels.

### Emissions Reduction

Reduces emissions by providing a more fuel-efficient alternative to auxiliary power generated from combustion engines.

### Manufacturability

Provides low-cost, high-volume manufacturing because of the solid nature of electrolyte and use of metal and polymer stack components.

### Contact Information:

**Dr. Calum Chisholm**

Email: [calum.chisholm@safcell.com](mailto:calum.chisholm@safcell.com)

Phone: (626) 795-0029 x101

**SAFCell, Inc.**

36 South Chester Avenue  
Pasadena, CA 91106

Website: <http://www.safcell.com>



# Solid Oxide Fuel Cell Auxiliary Power Unit

Emerging Technology

## New Technology Enables High-Efficiency, Environmentally Friendly Auxiliary Power Generation

Heavy-duty truck drivers often leave their main engines idling or use a diesel engine auxiliary power unit (APU) to provide “hotel load power” for in-cab electrical appliances and climate control. These practices produce emissions and noise from electricity generation via fuel combustion. Increasing anti-idling regulations have sparked a need to develop of a cleaner, quieter, more fuel-efficient technology for auxiliary power generation.

To address this need, Delphi Automotive Systems, LLC, with funding from FCT and other government agencies, has developed a solid oxide fuel cell (SOFC) APU. This high-efficiency electrochemical generator is designed to provide up to 3 kW of electrical power. Delphi received input from major truck original equipment manufacturers (PACCAR, Inc., and VTNA) to develop specific technical and performance goals for the APU. Delphi then developed the major subsystems and integrated them into a compact packaging geometry for mounting on a truck chassis.

The design is a very highly integrated package that includes a next-generation stack design with an increased active area, an improved thermal environment around the stack, increased efficiency using an endothermic fuel reformer and high recycle flow, reduced pressure drop of components to minimize parasitic loads, increased insulation thickness to minimize heat loss, and a reformat desulfurizer.

Future versions of the Delphi SOFC could be used to provide power to belt-driven vehicle components, removing those loads from the primary engine and improving overall vehicle fuel economy and engine performance.



*Delphi's Solid Oxide Fuel Cell APU*

## Technology History

- ◆ Developed by Delphi Automotive Systems, LLC.
- ◆ Planned to be used in an anti-idling capacity; future work could enable the diesel powered SOFC APU to supply power to belt-driven vehicle components such as engine cooling fans and water pumps.

## Applications

Can be used to provide auxiliary electrical power for a variety of mobile applications, including heavy-duty trucks, recreational vehicles, boats, truck and trailer refrigeration, and military vehicles.

## Capabilities

- ◆ Operates on a wide range of commercially available fuels, including natural gas, diesel, bio-diesel, propane, gasoline, coal-derived fuel, and military logistics fuel.
- ◆ Reduces the noise and pollutants associated with internal combustion engines.
- ◆ Operates at a higher efficiency than internal combustion engines because of the electrochemical conversion of fuel.

## Benefits

### Emissions Reductions

Achieves Tier 4 emissions standards set by the Environmental Protection Agency for nonroad diesel engines.

### Energy Savings

Saves up to 85% of the fuel currently required for operating the main diesel engine during idling.

#### Contact Information:

**Steven R. Shaffer**

Email: [steven.shaffer@delphi.com](mailto:steven.shaffer@delphi.com)

Phone: (585) 359-6615

**Delphi Corporation**

5500 West Henrietta Rd.

West Henrietta, NY 14586

Website: <http://delphi.com>

# Thermal and Water Management Systems for PEM Fuel Cells

Emerging Technology

## Optimized Technologies Improve Performance and Lifespan of PEM Fuel Cells

The efficient performance of automotive systems using PEM fuel cells depends heavily on balance-of-plant components such as radiators and humidifiers. These auxiliary devices ensure that a PEM fuel cell stack stays properly hydrated and remains at a temperature that will maximize performance without damaging the polymeric proton-conducting membrane. These components also contribute to a significant portion of the total system cost. Thermal and water management systems must be improved for fuel cells to become a practical alternative to internal combustion engines for powering automobiles.

To improve fuel cell thermal and water management systems, Honeywell Aerospace, with funding from FCT, is developing and testing innovative radiator and humidifier designs. The thermal management program examined a variety of radiator designs; and two fin geometries – 18 fins per inch (fpi) louver and 40 fpi microchannel – showed the best performance and cost characteristics. After conducting laboratory-scale evaluation for existing humidification devices, a Perma Pure tubular Nafion® membrane-based system and an Emprise enthalpy wheel-based system were found to meet fuel cell humidity requirements. Honeywell is currently testing full-scale versions of these humidification devices which can support an 80-kW fuel cell stack. In addition to these two designs, Honeywell has recently begun evaluation of a Gore® membrane humidifier with a planar geometry, which will reduce manufacturing cost and increased ease of installation. Testing of the select device at sub-ambient conditions is also planned. At the conclusion of the testing and optimization period, the possible transition of the best designs into commercial products will be examined.

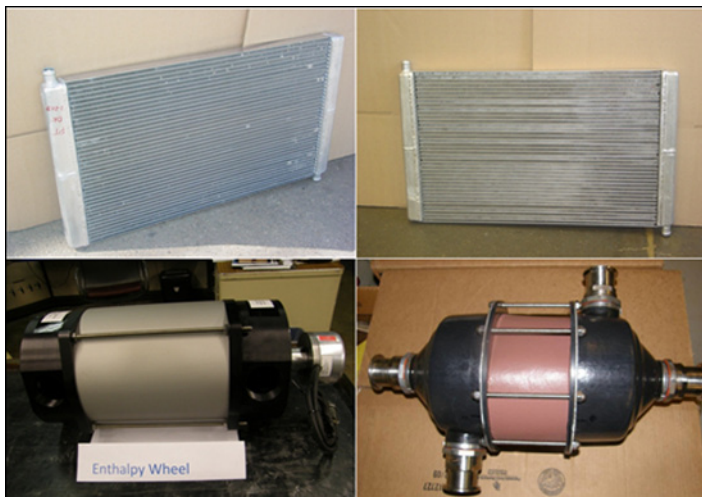

*Full-Scale Radiators and Humidifiers*

## Technology History

- ◆ Developed by Honeywell Aerospace in partnership with Argonne National Laboratory, Emprise Corporation, and the FreedomCAR Tech Team.
- ◆ Continuing development and testing of full-scale radiators and humidification devices sized for an 80-kW PEM fuel cell stack.

## Applications

Can be used to maintain a fuel cell inlet air stream at or above 60% relative humidity (at 80°C) and efficiently reject heat generated by the fuel cell stack to the ambient air.

## Capabilities

- ◆ Meets the 80-kW PEM fuel cell stack cooling requirements of 50 kW with radiator face area of 0.32 m<sup>2</sup> and 70 mm max depth.
- ◆ The preliminary test results of the full-scale humidification devices show that fuel cell inlet stream humidity from 50% to 60% at 80°C can be achieved.

## Benefits

### Cost Savings

Uses advanced fin configurations to minimize the size and weight of the radiator.

### Simplicity

Eliminates the need for an external water source by transferring moisture from a fuel cell's outlet air to its inlet air.

### Contact Information:

**Zia Mirza**

Email: [zia.mirza@honeywell.com](mailto:zia.mirza@honeywell.com)

Phone: (310) 512-3374

**Honeywell Aerospace**

2525 W. 190th Street

Torrance, CA 90504

Website: <http://www.honeywell.com>



<b>E.2 Production/Delivery Technologies</b> .....	E-43
◆ <a href="#">Active Magnetic Regenerative Liquefier</a> .....	E-44
◆ <a href="#">Centrifugal Hydrogen Pipeline Gas Compressor</a> .....	E-45
◆ <a href="#">Ceramic Membrane Reactor Systems for Converting Natural Gas to Hydrogen and Synthesis Gas (ITM Syngas)</a> .....	E-46
◆ <a href="#">High Performance Palladium-Based Membrane</a> .....	E-47
◆ <a href="#">High-Pressure Hydrogen Storage Tank for Gaseous Truck Delivery</a> .....	E-48
◆ <a href="#">HRS-100™ Hydrogen Recycling System</a> .....	E-49
◆ <a href="#">Hydrogen Gas Sensing System</a> .....	E-50
◆ <a href="#">Hydrogen Generation from Biomass-Derived Carbohydrates via Aqueous-Phase Reforming</a> .....	E-51
◆ <a href="#">Hydrogen Production via a Commercially Ready Inorganic Membrane Reactor</a> .....	E-52
◆ <a href="#">Integrated Ceramic Membrane System for Hydrogen Production</a> .....	E-53
◆ <a href="#">Integrated Short Contact Time Hydrogen Generator</a> .....	E-54
◆ <a href="#">Maximizing Light Utilization Efficiency and Hydrogen Production in Microalgal Cultures</a> .....	E-55
◆ <a href="#">Nanotube Array Photocatalysts</a> .....	E-56
◆ <a href="#">Novel Catalytic Fuel Reforming</a> .....	E-57
◆ <a href="#">Novel Stackable Structural Reactor (SSR®) for Low-Cost Hydrogen Production</a> .....	E-58
◆ <a href="#">Oil Free Hydrogen Compressor</a> .....	E-59
◆ <a href="#">Photoelectrochemical Hydrogen Production</a> .....	E-60
◆ <a href="#">Renewable Electrolysis Integrated System Development and Testing</a> .....	E-61
◆ <a href="#">Reversible Liquid Carriers</a> .....	E-62

# Active Magnetic Regenerative Liquefier

Emerging Technology

## Magnetic Cooling Refrigeration Produces LH<sub>2</sub> Efficiently and Cost Effectively

Conventional hydrogen liquefiers have a maximum thermodynamic cycle efficiency or figure of merit (FOM) of ~0.35. This FOM has an intrinsic limitation of simultaneously providing rapid and efficient compression of gaseous working fluids (hydrogen or helium gas). The U.S. Department of Energy (DOE) identified the high cost and low FOM of hydrogen liquefaction as technical barriers to wide-scale market adoption. These barriers affect several hydrogen energy applications: storage for wind or solar generation and fuel cell technologies. DOE has set targets of delivery of liquid hydrogen (LH<sub>2</sub>) at less than \$1.00 per kg and a liquefier FOM of 0.6.

Prometheus Energy Group Inc., with funding from the DOE's Fuel Cell Technologies Program, is developing a highly efficient hydrogen liquefier using active magnetic regenerative liquefaction (AMRL). AMRL cooling uses magnetic field changes of magnetic refrigerants coupled with a helium heat transfer fluid to complete the regenerative cycle. The magnetic solids are both the working refrigerant, using the magnetocaloric effect, and the regenerator material, which is required to complete the AMRL cycle. AMRL hydrogen liquefiers do not require efficient gas compression like typical Claude cycle liquefiers.

Magnetic cooling above ~1 K has been investigated since the 1970s. Recent engineering efforts have focused on non-chlorofluorocarbon refrigeration for a few hundred watts of cooling near room temperature using permanent magnets and also on cryogenic liquefiers with kilowatts of distributed refrigeration to liquefy hydrogen and natural gas. Prometheus Energy Group Inc. has designed, fabricated, and tested a lab-scale AMRL operating between ~290 K and ~240 K with a target of ~290 K to ~120 K. The extended range is made possible using a 7 Tesla superconducting magnet, which is cooled to 4 K by conduction cooling using a Gifford-McMahon cryocooler. The lab-scale prototype results are being used to design an AMRL system that can liquefy hydrogen with a FOM of ~0.5. Prometheus Energy Group Inc. is transferring the project to a new partner company, which will design, fabricate, and test the scaled-up prototype for efficient LH<sub>2</sub> production of ~25 kg/day.



Prometheus' Lab-Scale AMRL Prototype

## Technology History

- ◆ Developed by Prometheus Energy Group Inc.
- ◆ Designing scaled-up AMRL prototype system for producing ~25 kg/day LH<sub>2</sub>.

## Applications

Can be used to produce LH<sub>2</sub> for storage, transport, and delivery to multiple end-users among different energy sectors.

## Capabilities

- ◆ Produces LH<sub>2</sub> with a projected FOM of ~0.5.
- ◆ Achieves a wide operating temperature range that is expected to be between ~290 K to ~20 K.
- ◆ Produces ~25 kg per day of LH<sub>2</sub> at ~101 kPa.

## Benefits

### Cost Savings

Reduces the cost of LH<sub>2</sub> delivery to meet DOE's target of less than \$1.00 per kg.

### Efficiency

Can meet DOE's target FOM of 0.6, which is superior to a conventional gas compression cycle liquefiers' FOM of 0.35.

### Manufacturability

Can be scaled up to provide LH<sub>2</sub> production plant capacity to meet DOE's target of 30,000 kg/day.

### Contact Information:

**John A. Barclay**

Email: [jabarclay@comcast.net](mailto:jabarclay@comcast.net)

Phone: (425) 830-2757

**Prometheus Energy Group Inc.**

8511 154th Ave. NE, Bld. L

Redmond, WA 98052

Website: <http://www.prometheusenergy.com>



# Centrifugal Hydrogen Pipeline Gas Compressor

Emerging Technology

## New Technology Enables High-Efficiency, Low-Cost Pipeline Delivery of Compressed Hydrogen

In order for hydrogen to become a viable replacement for fossil fuels in the transportation industry, infrastructure for its delivery from production sites to vehicle fueling stations must be developed. The cost of delivery will add to the ultimate cost per kg or cost per gasoline gallon equivalent (GGE) charged for hydrogen fuel. It is therefore necessary that the cost of delivery be kept as low as possible. With this in mind, the Department of Energy has set a goal of less than \$1/GGE for hydrogen delivery.

To achieve this goal, Concepts NREC, with FCT funding, is developing a centrifugal compressor system for pipeline transport of hydrogen. The centrifugal-type compressor is able to provide high pressure ratios under acceptable material stresses at flow rates that are higher than what a piston compressor can provide. The design selection utilizes six stages, with each impeller operating at 60,000 rpm with a tip speed of 2,100 ft/s. High impeller tip speeds enable greater pressure ratios to be attained with fewer stages, but also impose increased stresses. For its impeller material, Concepts NREC selected an aluminum alloy that provides a high strength-to-density ratio and resistance to hydrogen embrittlement. Aluminum also helps to reduce the weight of the rotor, which leads to improved rotor dynamic stability at the 60,000 rpm operating speed. The maximum hydrogen compression temperature is maintained at 140°F by providing intercoolers between each of the six stages. The intercoolers cool the hydrogen to 100°F at the inlet to each stage. Additional design features include the use of proven bearings and seal technology to provide isolation of the hydrogen from the lubricating oil and increase system reliability at a competitive cost. The complete modular package occupies about one-half the footprint of a piston-type compressor, and can be transported to the installation site as a pre-assembled package. Concepts NREC is currently conducting detailed subsystems modeling and testing of critical components in the centrifugal compressor design. Future work will focus on assembly of a two-stage compressor, with eventual scale-up and demonstration of the six-stage system.

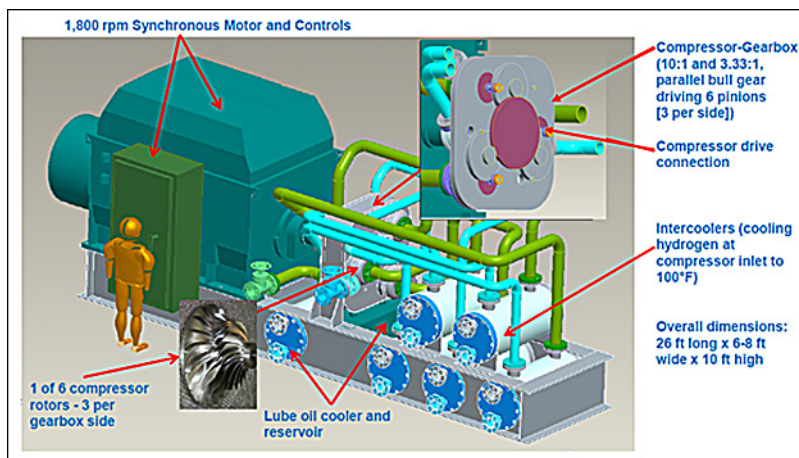

Concepts NREC's Centrifugal Hydrogen Pipeline Gas Compressor

## Technology History

- ◆ Developed by Concepts NREC, in partnership with Praxair, Texas A&M University, and HyGen Industries.
- ◆ Continuing work with assembly field testing and evaluation of a two-stage centrifugal compressor.

## Applications

Can be used to support existing hydrogen pipeline infrastructure in the industrial sector, and for future pipeline transport of high-pressure hydrogen from production sites to vehicle fueling stations.

## Capabilities

- ◆ Achieves higher compression efficiency than conventional reciprocating compression equipment.
- ◆ Delivers hydrogen at a rate of 240,000 kg/day at a discharge pressure of 1285 psig.
- ◆ Reduces maintenance costs to less than \$0.01/kWh.

## Benefits

### Capital Cost Savings

Increases reliability and eliminates the need to purchase redundant systems.

### Ease of Installation

Occupies about one-half of the footprint required by reciprocating compression equipment, and can be transported to the installation site with a minimum of final adjustments required.

### Product Quality

Eliminates the threat of lubricant contamination in the hydrogen supply line through use of proven seal and bearing technology.

#### Contact Information:

Francis A. Di Bella

Email: [fdibella@conceptsnnrec.com](mailto:fdibella@conceptsnnrec.com)

Phone: (781) 937-4718

Concepts NREC

39 Olympia Avenue

Woburn, MA 01801

Website: <http://www.conceptsnnrec.com>



# Ceramic Membrane Reactor Systems for Converting Natural Gas to Hydrogen and Synthesis Gas (ITM Syngas)

Emerging Technology

## New Technology Provides Lower-Cost Route to Syngas

The Ion Transport Membrane (ITM) is a revolutionary technology using ceramic membranes for gas separation being developed by a team led by Air Products and Chemicals, Inc., with FCT funding. ITM membranes are fabricated from nonporous, multi-component metallic oxides, operating at high temperatures with exceptional oxygen flux and infinite theoretical selectivity. The membranes work by transporting an ionized gas through oxygen vacancies in the crystalline ceramic. ITM syngas membranes combine air separation and methane partial oxidation into a single-unit operation. Oxygen from low-pressure air permeates through the ceramic membrane and reacts with natural gas in a partial oxidation process, creating a chemical driving force that pulls oxygen ions across the membrane. The resulting product is a high-pressure hydrogen and carbon monoxide synthesis gas mixture, which can be used to manufacture synthetic ultraclean liquid fuels, hydrogen, and/or chemicals. The ITM syngas process is also readily configured for carbon capture from the high-pressure syngas product. ITM's very high flux and selectivity help reduce both capital and operating costs. These inherent features make it an attractive technology for emerging climate-friendly energy applications.

The economics of the ITM syngas process are most attractive when a high-pressure natural gas feed and a low-pressure air feed are used to produce a high-pressure synthesis gas product that matches downstream processing requirements. This arrangement avoids the expense associated with compressing the air or the synthesis gas. However, ceramic membranes for this application must withstand the stresses generated by the large pressure difference between the high-pressure natural gas/synthesis gas on one side of the membrane and the low-pressure air on the opposite side. The ceramic membrane structure, or wafer, is fabricated using a planar design that can achieve high oxygen fluxes while withstanding the thermo-mechanical stresses encountered during operation. This wafer design incorporates micro-channel features to reduce the stresses and efficiently distribute the gases to the membrane surfaces. Planar wafers also enable very efficient packing of membrane surfaces within the reactor volume. An ITM syngas module is assembled by stacking wafers vertically, with ceramic spacers placed between the individual wafers to create channels for the flow of natural gas and synthesis gas between wafers.

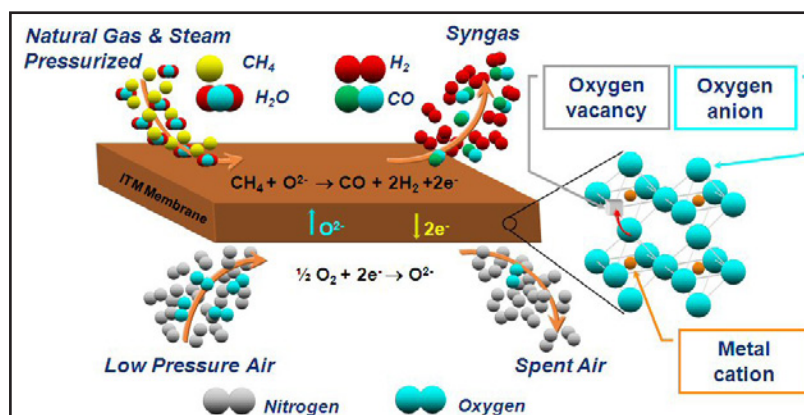

ITM Syngas Process

## Technology History

Being developed by an Air Products led team consisting of Chevron, Sasol, Ceramatec, and others.

## Applications

Can be used to generate syngas, which is used to manufacture synthetic ultraclean liquid fuels, hydrogen, and chemicals.

## Capabilities

- ◆ Generates syngas and hydrogen in a more compact, lower-cost, and higher-efficiency process than competing state-of-the-art technologies.
- ◆ Extracts oxygen from low-pressure air, eliminating the requirement for high-pressure air compression equipment.
- ◆ Retrofits into existing  $\text{H}_2$  reforming facilities to increase capacity and efficiency.
- ◆ Offers feed flexibility when combined with feed gas prereforming.

## Benefits

### Capital Cost

Offers a projected 30% lower capital cost compared with conventional technology using oxygen-blown autothermal reforming (ATR) with a cryogenic air separation unit (ASU). The ITM Syngas process also has a 1% to 2.5% improvement in plant thermal efficiency over the ATR/ASU design.

### Plant Size

Reduces the footprint up to 40% over an ATR/ASU when the 6,000 barrels-per-day gas-to-liquids plant was evaluated for a floating production storage and offloading application.

### Contact Information:

Ted Foster

Email: [ITM@airproducts.com](mailto:ITM@airproducts.com)

Phone: (610) 481-5307

Air Products and Chemicals, Inc.

7201 Hamilton Boulevard

Allentown, PA 18195

Website: <http://www.airproducts.com>

# High Performance Palladium-Based Membrane

Emerging Technology

## New Membrane Allows Cost-Effective Separation of Hydrogen for Fuel Cell Vehicles

The natural gas reforming process is a well established method for converting natural gas ( $\text{CH}_4$ ) to hydrogen ( $\text{H}_2$ ) and carbon monoxide ( $\text{CO}$ ). Additional  $\text{H}_2$  can be produced by the water gas shift reaction (WGSR) that converts  $\text{CO}$  and  $\text{H}_2\text{O}$  to carbon dioxide ( $\text{CO}_2$ ) and  $\text{H}_2$ . However for proper long-term operation, fuel cell vehicles require high purity hydrogen that is free of other gasses. One solution is to integrate a palladium (Pd) metal alloy membrane into this process to separate and purify the  $\text{H}_2$  for use in a fuel cell vehicle. Pall Corporation, with funding from FCT, is developing a Pd-based membrane that is designed to work as a selective barrier to only let  $\text{H}_2$  pass through. A mixed gas stream comes into the membrane device and is separated into two outlet streams, one containing near pure  $\text{H}_2$  at low pressure and the other containing  $\text{CO}_2$  and other components of the incoming gas at high pressure. The near pure  $\text{H}_2$  is the end product or fuel for fuel cell vehicles.

Developing this membrane requires research in the fields of Pd-membrane technology, high-temperature material analysis, and inorganic membrane product development and manufacturing. The resulting membrane will enable the design of a cost-effective natural gas reforming system. Combining the reforming process with the WGSR to create a membrane reactor could realize additional cost savings. The membrane device will also have a relatively small footprint, minimizing the overall plant size. The membrane design effort is focused on the unique requirements of distributed hydrogen production for fuel cell vehicles. These stations would produce up to 1,500 kg per day of  $\text{H}_2$  by reforming natural gas, which is equivalent to 300 cars per day. This is the average number of cars serviced by a typical gasoline fueling station today.



*Pall High-Performance Palladium-Based Membrane*

## Technology History

- ◆ Being developed by Pall Corporation in partnership with the Colorado School of Mines and the Oak Ridge National Laboratory.
- ◆ Successfully demonstrated development of Pd-alloy composite membrane on ceramic coated AccuSep® support media.

## Applications

Can be used to produce hydrogen using natural gas and steam.

## Capabilities

- ◆ Allows for near ideal separation of  $\text{H}_2$  from other gas stream components.
- ◆ Achieves extremely high rates of gas transport as well as high separation factors/high purity.
- ◆ Offers high-temperature and high-pressure operation.

## Benefits

### Cost Effective

Can be economically integrated into the overall  $\text{H}_2$  production process.

### Versatility

Is readily amenable to small-, medium-, or large-scale industrial commercialization.

### Contact Information:

**Jim Acquaviva**

Email: [Jim\\_Acquaviva@Pall.com](mailto:Jim_Acquaviva@Pall.com)

Phone: (516) 801-9210

**Pall Corporation**

25 Harbor Park Drive

Port Washington, NY 11050

Website: <http://www.pall.com>

# High-Pressure Hydrogen Storage Tank for Gaseous Truck Delivery

Emerging Technology

## New Composite Tank Enables Efficient, Low-Cost Transportation of Compressed Hydrogen

Successful commercialization of hydrogen fuel cell vehicles depends on developing a hydrogen delivery infrastructure that provides the same level of safety, ease, and functionality as the existing gasoline delivery infrastructure. Today, compressed hydrogen is typically shipped in tube trailers at pressures of up to 3,000 psi (about 200 bar). However, the low hydrogen-carrying capacity of these tube trailers results in high delivery costs.

Lincoln Composites, Inc., with FCT funding, is developing a large composite tank and International Organization for Standardization (ISO) frame system that can be used to store and transport compressed hydrogen gas over road, rail, or water. The baseline composite tank has an internal volume of 8,500 liters and contains 150 kg of compressed hydrogen at 3,600 psi. Four of these tanks are mounted in a custom-designed ISO frame, resulting in an assembly with a total capacity of 600 kg of hydrogen. In addition to the structure, a system for loading, unloading, and pressure relief has been designed and implemented. Installing the compressed hydrogen tanks into an ISO frame offers one solution for both transportable and stationary tanks, decreasing the amount of infrastructure and equipment required for both applications. The large size of the tank also offers benefits. A limited number of large tanks requires fewer valves and fittings, which increases system reliability and reduces costs. The larger diameter also means thicker tank walls, which make the tank more robust and damage tolerant.

To make additional progress towards achieving DOE's volumetric and total delivery capacity targets, Lincoln Composites is undertaking efforts to develop a 5,000 psi tank using the same design and qualification methods employed in developing the original tank.



Lincoln Composites' 3,600 psi TITAN™ Tank and Frame System

## Technology History

- ◆ Developed by Lincoln Composites, Inc.
- ◆ Continuing work on developing and qualifying a 5,000 psi tank, based on methods used for the original 3,600 psi design.
- ◆ Commercially available outside the U.S. and working with the U.S. Department of Transportation to obtain approval for use in this country.

## Applications

Can be used to transport and store hydrogen and other compressed gases.

## Capabilities

- ◆ Stores 600 kg of compressed hydrogen (150 kg per tank) at 3,600 psi.
- ◆ Achieves a performance of 0.018 kg of hydrogen per liter of tank volume and 0.063 kg of hydrogen per kg of tank weight.

## Benefits

### Cost Savings

Reduces costs by improving volumetric hydrogen storage capacity compared with conventional tube trailers.

### Durability

Demonstrated ability to meet strength (burst and pressure cycling), environmental (corrosive fluids, extreme temperatures), and durability (flaw tolerance, penetration) targets.

### Contact Information:

**Don Baldwin**

Email: [dbaldwin@lincolncomposites.com](mailto:dbaldwin@lincolncomposites.com)

Phone: (402) 470-5017

**Lincoln Composites, Inc.**

5117 N.W. 40th Street

Lincoln, NE 68524

Website: <http://www.lincolncomposites.com>



# HRS-100™ Hydrogen Recycling System

Emerging Technology

## New Technology Reduces Hydrogen Feedstock Costs for Industrial Processes

The high costs associated with hydrogen production and delivery make the recovery and recycling of unconsumed hydrogen an economically attractive option for many hydrogen-consuming industrial processes (e.g., steel heat treating). Traditionally, hydrogen has been recovered using mechanical approaches with multiple subsystems (e.g., a mechanical compressor and a pressure swing adsorption unit).

To improve the efficiency and cost-effectiveness of hydrogen recovery, H2Pump, LLC, developed an electrochemical hydrogen recovery system that separates hydrogen from a mixed gas stream (e.g., furnace exhaust), purifies it, and pumps it back into the feed stream of an industrial process. The hydrogen separation and pumping process occurs in an electrochemical cell stack. Hydrogen and other gaseous impurities (e.g., CO, CO<sub>2</sub>, and CH<sub>4</sub>) enter the anode chamber of a cell, where each hydrogen molecule is oxidized to two protons and two electrons. A direct current power supply provides the electrical potential to drive the electrons and protons to the cathode through an external wire and a proton exchange membrane, respectively. The electrons and protons recombine at the cathode to produce pure hydrogen. The gaseous impurities, which do not pass through the membrane, are directed out of the system as a waste stream. The system operates at high efficiency by avoiding the large heat losses associated with mechanical hydrogen compression, and can be easily scaled to provide a wide range of hydrogen flowrates.

The H2Pump technology was originally developed with support from the New York State Energy Research and Development Authority (NYSERDA). In the summer of 2010, a 10 kg/day demonstration unit was installed for testing at Redifoils, LLC, a steel heat treating company located in Portland, Connecticut. In May 2011, this system was replaced with a prototype HRS-100. This demonstration of the unit's performance in a real-world operating environment will help H2Pump move towards commercialization of the technology. H2Pump is currently developing enhanced technology for a future generation of the HRS-100 with assistance from a Small Business Innovation Research (SBIR) grant.



*H2Pump's 100 kg/day Hydrogen Recycling System*

## Technology History

- ◆ Developed by H2Pump, LLC, with support from NYSERDA.
- ◆ Currently developing enhanced technology for the system with an SBIR Phase II grant.

## Applications

Can be used to recover byproduct or unconsumed hydrogen from industrial process exhaust streams and recycle purified, pressurized hydrogen back to the process feed stream.

## Capabilities

- ◆ Recycles up to 100 kg of hydrogen per day (1,600 standard cubic feet per hour).
- ◆ Recovers up to 90% of the hydrogen present in the exhaust stream.
- ◆ Compresses hydrogen to hundreds of psig.
- ◆ Achieves >80% pumping efficiency.
- ◆ Purifies hydrogen to >99.999% (exact purity value depends on exhaust gas stream composition).

## Benefits

### Cost Savings

Reduces operating expenses by recovering previously wasted hydrogen at a lower cost than would be required for a new supply.

### Durability

Uses high-temperature-compatible materials with enhanced tolerance to gaseous impurities.

### Contact Information:

**Dr. Glenn Eisman**

Email: [glenn.eisman@h2pumpllc.com](mailto:glenn.eisman@h2pumpllc.com)

Phone: (518) 783-2241

**H2Pump, LLC**

11 Northway Lane North  
Latham, New York 12110

Website: <http://h2pumpllc.com/>

# Hydrogen Gas Sensing System

Emerging Technology

## Novel Sensor Detects Hydrogen Leaks in Wide Range of Operating Environments

The hazards associated with using a combustible gas, such as hydrogen, for fuel can be reduced with sensor technology that can monitor the gas supply and warn of a release. An optical sensor technology in which the electrical power is maintained out of the hydrogen environment offers the most inherently safe design. A limiting factor with any sensor technology is that the number of sensors required scales with the supply size, and therefore multiple sensors are needed to provide adequate coverage. With optical sensors, multiple locations distributed over an area can be monitored using fiber optic lines connected to a central data acquisition unit in a safe location. To be commercially viable, the safety sensor technology should be low-cost and reliable and exhibit high levels of accuracy and precision for detecting hydrogen across a wide range of operating conditions.

To address these technical challenges, Intelligent Optical Systems, Inc. (IOS), with FCT funding, is developing the H<sub>2</sub>-dTECT™ gas sensing system, a quick-response sensor that accurately detects hydrogen leaks in a broad range of operating environments from home garages to pipelines. At the heart of the IOS technology is a proprietary chemical formulation that changes color in the presence of hydrogen. The chemical hydrogen indicator is readily immobilized on a porous glass substrate that can be used either in remote fiber optic sensor networks or in compact (handheld or wall-mountable) sensor units.

IOS has designed and fabricated an optoelectronic sensor prototype, which features an integrated user interface, audio and visual alarms, and a microcontroller with digital signal processing capabilities. The prototype supports four channels (signal, reference, temperature, and humidity) and includes both USB and RS-232 serial communication. The device has been tested by the National Renewable Energy Laboratory (NREL) and is available for field trials in operational environments. IOS is currently seeking partnerships to help transition from the sensor prototype to a commercially available product.



*IOS's Prototype H<sub>2</sub>-dTECT Hydrogen Sensor*

## Technology History

- ◆ Developed by IOS in partnership with NREL.
- ◆ Currently field testing the prototype sensor and analyzing the test results.

## Applications

Can be used to detect hydrogen leaks in operating environments ranging from fuel cell vehicle garages to production facilities and refueling stations.

## Capabilities

- ◆ Detects hydrogen at concentrations from 100 ppm to 10% hydrogen-in-air with a response time of less than 5 seconds.
- ◆ Operates over a wide range of conditions, including temperatures of 10-55°C and 0-90% relative humidity.
- ◆ Can be powered via USB cable, AC adapter, or rechargeable lithium ion batteries, with a battery life of 10 hours.

## Benefits

### Cost Savings

Identifies points at which high-purity hydrogen is being lost via leaks along the delivery, storage, and refueling infrastructure for fuel cell vehicles.

### Safety

Alerts users to hydrogen leaks, reducing the risk of hydrogen-related flammability, explosive, or asphyxiation incidents.

### Versatility

Can be handheld, wall mounted, or deployed for remote monitoring of multiple locations where a potential hydrogen leak is expected.

#### Contact Information:

##### Chip Allgrove

Email: [callgrove@intopsys.com](mailto:callgrove@intopsys.com)

Phone: (424) 263-6300

##### Intelligent Optical Systems, Inc.

2520 W. 237th Street

Torrance, CA 90505

Website: <http://www.intopsys.com>

# Hydrogen Generation from Biomass-Driven Carbohydrates via Aqueous-Phase Reforming

Emerging Technology

## New Process Uses Carbohydrates to Cost Effectively Produce Hydrogen

Generation of hydrogen traditionally involves using natural gas in a reforming process. However, natural gas is a nonrenewable resource, and the reforming process generates other products that must be removed from the gas stream to achieve pure hydrogen. The reforming process itself operates at high temperature and needs steam for the chemical transformation, increasing the total energy cost and the cost of the resulting hydrogen. Using renewable resources requires a technology that performs economical bioreforming in an aqueous state at a lower temperature than traditional reforming. Such a technology would also need to be flexible and to be able to use a wide variety of feedstocks for generating hydrogen.

Virent Energy Systems, Inc., with funding from FCT, is adapting their BioForming™ process, a patented aqueous-phase reforming (APR) process, to economically produce hydrogen. A range of biomass-derived feedstocks, including glycerol and sugars, is being tested as feedstocks. The key breakthrough in the BioForming process is a proprietary catalyst that operates in the aqueous phase and has high hydrogen selectivity at low temperature. The process reforms water-soluble oxygenated-hydrocarbons in a single step and produces a hydrogen-rich gas that is easily purified. The BioForming process can be used to produce fuel stock for energy systems requiring a clean source of hydrogen, including for transportation. The process applications are broad, given that hydrogen is a key chemical building block used in many chemical processes, predominately ammonia fertilizer production and, in oil refineries, to upgrade lower quality oil fractions into gasoline and diesel and to remove sulphur contaminants. Other applications include the manufacture of glass, vitamins, personal care products, lubricants, refined metals, and food products.



*Virent's Hydrogen Pilot Plant*

## Technology History

- ◆ Being developed by Virent Energy Systems, Inc., in partnership with Archer Daniels Midland Co. and the University of Wisconsin.
- ◆ Focusing on developing the APR catalyst and reactor system that converts glucose to hydrogen.

## Applications

Can be used to produce hydrogen using biomass-derived carbohydrates.

## Capabilities

- ◆ Uses renewable biomass-derived feedstock to generate hydrogen.
- ◆ Produces hydrogen at low temperatures without forming carbon monoxide.
- ◆ Uses various sugars and sugar alcohols in addition to feedstocks.

## Benefits

### Energy Efficiency

Does not require fossil fuels and generates carbon-neutral hydrogen from widely available biomass-derived feedstocks.

### Versatility

Produces hydrogen from various renewable feedstocks as well as various sugars and sugar alcohols.

#### Contact Information:

**Dr. Randy D. Cortright**

Email: [Randy\\_Cortright@virent.com](mailto:Randy_Cortright@virent.com)

Phone: (608) 663-1630

**Virent Energy Systems, Inc.**

3571 Anderson St.

Madison, WI 53704

Website: <http://www.virent.com>



# Hydrogen Production via a Commercially Ready Inorganic Membrane Reactor

Emerging Technology

## New Carbon Molecular Sieve Separates Hydrogen in Harsh Environments

The production of hydrogen often involves the production of syngas from coal. The syngas contains hydrogen and carbon monoxide as well as sulfur and heavy hydrocarbons. Existing methods to separate out the hydrogen involve two stages. The first stage is a water gas shift reaction using steam and high temperature with a catalyst to initiate a reaction that transforms the carbon monoxide to carbon dioxide and additional hydrogen. The second stage separates the hydrogen from the carbon dioxide and the other contaminants (sulphur and heavy hydrocarbons). Both stages are problematic because of the high temperatures involved and the contamination effect of the sulphur and heavy hydrocarbons. The contaminants can cause plugging, which can decrease the efficiency of the process. A method is needed to remove the contaminants and reduce the process from two steps to one step. Ideally, reducing the temperature of the reaction from the current 400°C to 200°C to 250°C would be beneficial. At high temperatures, the current catalyst membrane is prone to stability problems, and the corrosion effects of the contaminants are increased.

Media and Process Technology (M&P), Inc., with FCT funding, has overcome these problems and developed a commercially viable carbon molecular sieve (CMS) membrane. Although CMS membranes were introduced in 1980, no commercially viable product was available because of the lack of a technically viable module and potential surface poison by contaminants. M&P's robust CMS membrane can function as a hydrogen separator as well as a membrane reactor for the water gas shift reaction, thereby combining two process steps into one. Its inertness offers excellent opportunities for intermediate temperature applications under harsh environment, such as syngas from coal, and hydrogen recovery from sulfur and heavy hydrocarbon containing streams. The CMS membrane has been incorporated into a distributed hydrogen production process called HiCON, which is being pilot-scale tested now and will be field tested.

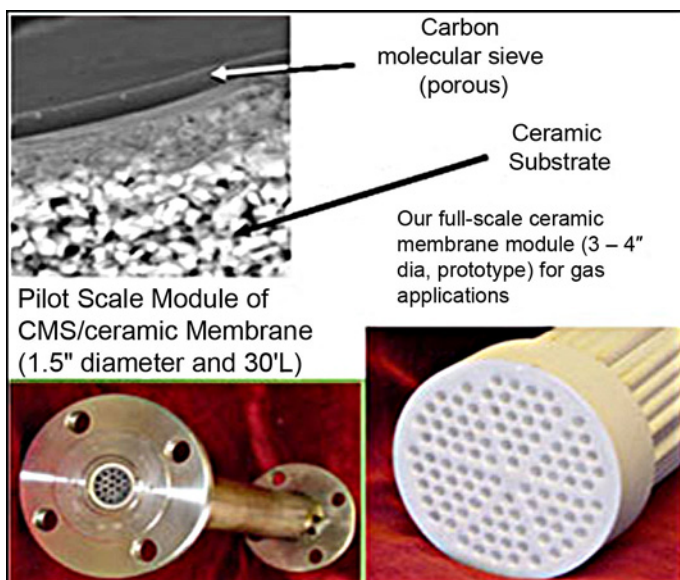

Media and Process Technology's CMS Membrane

## Technology History

- ◆ Being developed by M&P with support from Johnson Matthey, Inc., the University of Southern California, and Chevron Energy Technology Company.
- ◆ Running field trials to demonstrate the optimized HiCON process.

## Applications

Can be used to produce hydrogen using syngas from coal and hydrogen recovery from sulfur and heavy hydrocarbon containing streams.

## Capabilities

- ◆ Uses coal syngas and hydrocarbon waste streams to generate hydrogen.
- ◆ Achieves production and separation of hydrogen at low temperatures in one step.
- ◆ Operates under harsh environments, such as sulfur and heavy hydrocarbon containing streams.

## Benefits

### Durability

Delivers burst pressure in excess of 1500 psi.

### Versatility

Produces hydrogen from syngas from coal and recovers hydrogen from sulfur and heavy hydrocarbon containing streams.

### Contact Information:

**Paul K. T. Liu**

Email: [pliu@mediaandprocess.com](mailto:pliu@mediaandprocess.com)

Phone: (412) 826-3721

**Media and Process Technology, Inc.**

1155 William Pitt Way

Pittsburgh, PA 15238

Website: <http://www.mediaandprocess.com>

# Integrated Ceramic Membrane System for Hydrogen Production

Emerging Technology

## New Palladium-Based Membrane System Produces High-Purity Hydrogen at Reduced Capital Cost

Hydrogen is expected to play a vital role in the transportation sector for fuel cell vehicles (FCVs). One of the crucial factors for successfully introducing FCVs on U.S. roadways is a low-cost supply of hydrogen. The near-term demand for hydrogen at FCV fueling stations is projected to be less than 10,000 standard cubic feet per hour (scfh). To be competitive with gasoline, the cost of hydrogen delivered to a vehicle must be below \$20/MMBtu. A key challenge in achieving this price is to reduce the capital cost of an onsite plant.

One approach to lower capital costs is to reduce both the complexity of the process and the equipment needed to generate hydrogen. The equipment needed to produce hydrogen depends on the hydrogen production process used. In this system, the two main components are the oxygen transport membrane (OTM) and the hydrogen transport membrane (HTM). Air at low pressure (25 psi) is passed to one side of the OTM, and compressed natural gas (200 psia – 300 psia) and steam are passed to the other side of the OTM. Oxygen is transported across the OTM to the permeate side, where it reacts with natural gas to form syngas. A portion of natural gas also reacts with steam to form syngas. Hydrogen is formed by the water-gas shift reaction in the HTM reactor where CO reacts with steam to form more hydrogen and CO<sub>2</sub>. The proper membrane support material and catalysts could reduce the complexity of this process.

Praxair, Inc., with funding from FCT, is researching a hydrogen transport membrane integrated in a water-gas-shift reactor to increase hydrogen yield from the reactor by shifting the equilibrium composition to produce more hydrogen and less CO. The palladium-based membrane has the added advantage of producing hydrogen with extremely high purity, appropriate for polymer electrolyte membrane (PEM) fuel cells. Small on-site hydrogen generators, such as those that would be located at fueling stations, are the target production units for this technology.

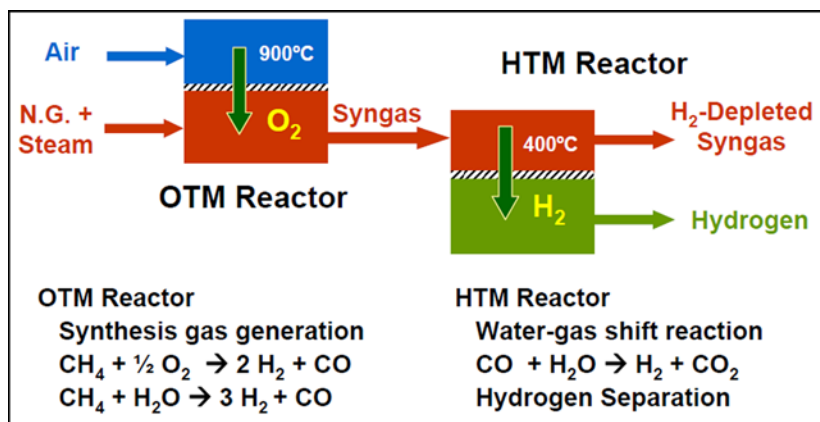

Praxair's Conversion Process for Hydrogen Production

## Technology History

- ◆ Being developed by Praxair, Inc., in partnership with the Research Triangle Institute.
- ◆ Continuing work to improve the palladium-based membrane, reducing its cost, and testing the performance of the system.

## Applications

Can be used to generate hydrogen for use in hydrogen-powered vehicles.

## Capabilities

- ◆ Increases hydrogen yield from any synthesis gas generator, including OTM processes and reforming.
- ◆ Achieves strength with porosity through advanced ceramic substrate technology.
- ◆ Increases production of high-purity hydrogen from syngas

## Benefits

### Capital Cost

Produces hydrogen in a less capital-intensive system because of the simpler integrated membrane system.

### Performance

Produces hydrogen at sufficient purity for PEM fuel cells without further purification.

### Versatility

Combines uniform small pores on the surface to support a thin membrane layer with larger pores in the bulk of the substrate to allow unrestricted flow.

### Contact Information:

**Joseph Schwartz**

Email: [joseph\\_schwartz@praxair.com](mailto:joseph_schwartz@praxair.com)

Phone: (716) 879-7455

**Praxair, Inc.**

175 East Park Drive

PO Box 44

Tonawanda, NY 14151

Website: <http://www.praxair.com>

# Integrated Short Contact Time Hydrogen Generator

Emerging Technology

## New Technology Uses Novel Staged Catalytic Partial Oxidation (SCPO) Technology for Hydrogen Production

One challenge for the realization of the hydrogen economy is the development of a low-cost, compact reforming technology that is fuel flexible and can produce hydrogen ( $H_2$ ) from fossil fuels and renewable fuels. Analysis of existing systems has shown that efficiency is just one of many factors that affect the cost of a  $H_2$  generation system. For example, some system configurations have a higher than expected system efficiency but also have more components, which leads to higher capital cost and lower reliability. Thus, the most efficient system is not necessarily the best technology choice for  $H_2$  production.

A technology is needed that uses fewer components to reduce the cost of  $H_2$  production. Ideally, the technology should be modular for mass production and should be thermally integrated as much as possible to reduce the cost and improve the efficiency.

GE Global Research Center, with funding from FCT, is developing an efficient, unique technology based on integrating four catalyst zones: pre-steam methane reforming (pre-SMR), catalytic partial oxidation (CPO), steam methane reforming (SMR), and water gas shift (WGS). The resulting SCPO technology generates  $H_2$  from natural gas to meet DOE cost and efficiency targets for distributed  $H_2$  generating and dispensing systems of less than 1,500 kg/day. Using this novel system and short-contact time catalysts allows for greater reformer compactness and therefore lower capital costs than conventional approaches. The unique system design, as well as modular component design, will reduce the manufacturing cost after mass production and ease the operation and maintenance for  $H_2$  production. The project has demonstrated that it is a leading technology for  $H_2$  production from natural gas and with minor modifications will allow the use of biofuels, gasoline, or diesel as feedstock.

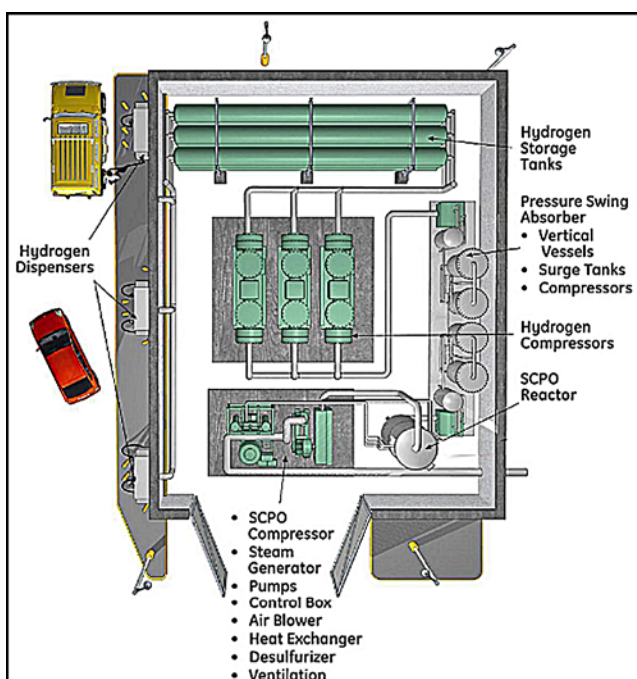

GE Global Research Center's Hydrogen Generator

## Technology History

- ◆ Being developed by GE Global Research Center in partnership with Argonne National Laboratory and the University of Minnesota.
- ◆ Continuing work on SCPO catalyst testing to increase the sulfur tolerance of the system and refinement of the system analysis for updated costs.

## Applications

Can be used in different industries when syngas and hydrogen production are needed.

## Capabilities

- ◆ Can be mass-produced because of its modular design.
- ◆ Achieves  $H_2$  production of 60 Kg/day using test units and working on a system to produce 1,500 kg/day.
- ◆ Reduces peak metal temperature in entire system to  $<600^{\circ}C$  to allow the use of low cost stainless steel

## Benefits

### Cost Effectiveness

Allows cost-effective mass production because of its integrated, modular design.

### Performance

Combines the efficiency advantage of steam reforming and the low capital cost advantage of autothermal reforming.

### Contact Information:

**Mark Thompson**

Email: [thompsonm@research.ge.com](mailto:thompsonm@research.ge.com)

Phone: (949) 330-8977

**GE Global Research Center**

18A Mason

Irvine, CA 92618

Website: <http://ge.geglobalresearch.com/>

# Maximizing Light Utilization Efficiency and Hydrogen Production in Microalgal Cultures

Emerging Technology

## New DNA Research Improves the Ability of Algae to Produce Hydrogen

Hydrogen can be produced in a number of different ways. Unfortunately, only a few of them involve renewable energy sources. Renewable energy sources are preferred whenever possible, but most of the existing renewable energy hydrogen generation technologies involve a large amount of capital outlay and are technically complicated. In addition, some of them create unwanted byproducts such as carbon dioxide or carbon monoxide. The conversion and sequestering of these unwanted byproducts require the use of additional energy and technology.

A simple, low energy, low technology process is needed that uses natural materials and does not produce unwanted byproducts. Ideally, this technology would use a nonpolluting source of energy such as sunlight and a plant type of material that could be grown in a water media.

The University of California (UC)-Berkeley is developing, with funding from FCT, this type of technology by genetically engineering a strain of algae that is proving to be highly efficient at converting sunlight to hydrogen. UC-Berkeley's preliminary investigation discovered that the normal type of algae that grows in the wild suffers from a characteristic that limits efficient conversion of sunlight into hydrogen. This limiting characteristic is the high-density green color resulting from the presence of chlorophyll in the algae. The chlorophyll tends to over-absorb sunlight in individual cells at the surface of the culture, causing heat dissipation and failure of the sunlight to penetrate deeper into the culture. This over-absorption limits the conversion efficiency of the algae, resulting in lower production of hydrogen. By genetically engineering the size of the chlorophyll "antenna," UC-Berkeley has prevented this over-absorption at the surface, which allows the sunlight to penetrate deeper into the culture, thereby decreasing the heat dissipation and increasing the light utilization efficiency of hydrogen production from 3% to 15%.

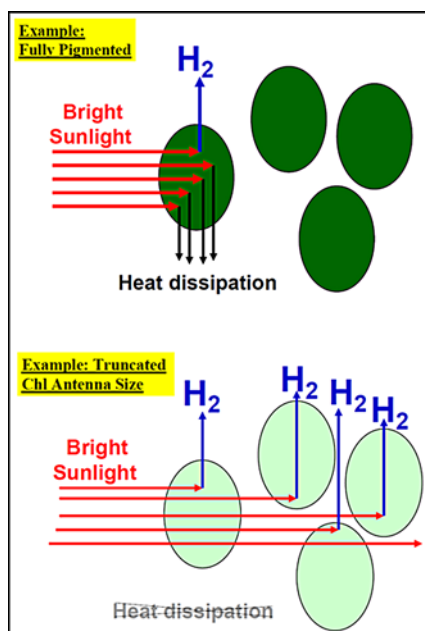

*UC-Berkeley's Production of Hydrogen from Truncated Antenna Algae Cells*

## Technology History

- ◆ Being developed by the UC-Berkeley Plant & Microbial Biology Department.
- ◆ Continuing work on developing genetic strains of truncated chlorophyll antenna algae and advancing the biochemical and molecular characterization of several promising strains that show high utilization of sunlight for hydrogen production.

## Applications

Can be used to produce hydrogen using algae and sunlight.

## Capabilities

- ◆ Uses renewable algae to generate hydrogen.
- ◆ Produces hydrogen in normal sunlight without undesirable byproducts.
- ◆ Increases sunlight utilization in algae from 3% to 15%.

## Benefits

### Energy Efficiency

Requires no fossil fuels and generates carbon-neutral hydrogen from algae and sunlight.

### Versatility

Produces hydrogen from algae in an easily scalable system.

#### Contact Information:

**Tasios Melis**

Email: [melis@berkeley.edu](mailto:melis@berkeley.edu)

Phone: (510) 642-8166

University of California at Berkeley

Berkeley, CA 94720-3102

Website: <http://www.berkeley.edu>



# Nanotube Array Photocatalysts

Emerging Technology

## New Technology Enables Efficient, Cost-Effective Photoelectrochemical Hydrogen Production

Heterogeneous photocatalysis is used in a number of applications, from photo-induced water splitting for hydrogen production to water purification and environmental cleanup. However, the utility of today's photocatalytic materials is limited by several factors, such as poor bandgap match to the solar spectrum, low chemical conversion efficiency, and in many cases poor stability in the application environment. In addition, the cost of materials must be reduced for this technology to achieve widespread market penetration.

Synkera Technologies, Inc., with the assistance of DOE SBIR grants, is developing highly efficient, long-lifetime, and cost-effective photocatalysts to address the current shortcomings associated with photoelectrochemical hydrogen production. Synkera's approach is based on high-density arrays of nanotubes with unique coaxial architecture. These nanotubes integrate a conductive layer, a semiconductor absorber with a vertically integrated bandgap, and chemically robust electrochemical interface coating. This approach enables several photocatalyst designs and takes advantage of a new templated process for nanoarray synthesis developed by Synkera. The ability to reliably and consistently fabricate a device with such complex architecture is key to developing highly competitive photocatalysts.

Synkera demonstrated the feasibility of its approach using doped titanium oxide ( $\text{TiO}_2$ ) nanotube arrays with a coaxial conductor. Significant improvements in photoelectrochemical performance were observed compared with planar structures, including increased photocurrent density and increased stability in 0.1 M potassium hydroxide. Spectral sensitivity and conversion efficiency measurements are currently in progress, and Synkera is seeking product development and commercialization partners.

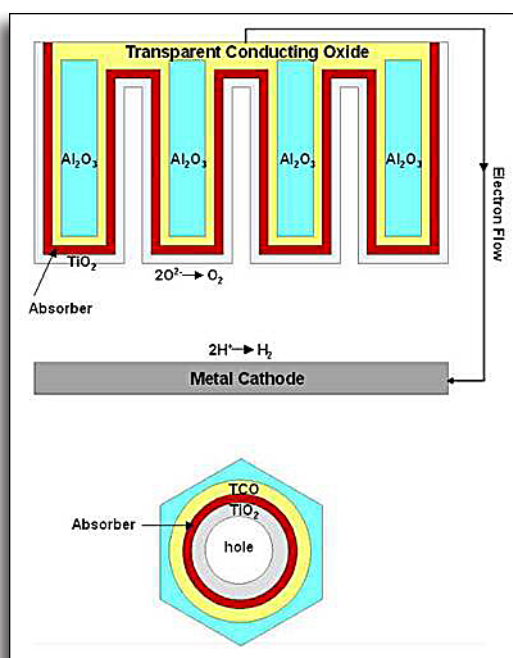

Schematic of Synkera's Nanotube Array with Integrated Absorber

## Technology History

- ◆ Developed by Synkera Technologies, Inc.
- ◆ Continuing work to optimize spectral sensitivity and conversion efficiency.

## Applications

Can be used to produce hydrogen from solar energy.

## Capabilities

- ◆ Enhances light harvesting through a large absorption cross-section and a high surface area to promote catalytic chemistry.
- ◆ Minimizes recombination losses through rapid and efficient charge separation in a very thin absorber.
- ◆ Increases efficiency through broadband light absorption and a vertically graded bandgap.

## Benefits

### Cost Savings

Is scalable to large size and high volumes and lowers costs compared with traditional technologies.

### Durability

Achieves long lifetime by using corrosion-resistant conformal layers of titania as electrochemical interface.

### Contact Information:

**Rikard A. Wind, Ph.D.**

Email: [rwind@synkera.com](mailto:rwind@synkera.com)

Phone: (720) 494-8401 x111

**Synkera Technologies, Inc.**

2021 Miller Dr., Ste B

Longmont, CO 80501

Website: <http://www.synkera.com>

# Novel Catalytic Fuel Reforming

Emerging Technology

## New System Generates Hydrogen from Multiple Fuels

Hydrogen generation from existing fuel production and distribution networks (i.e., natural gas, gasoline, diesel, or jet fuels) offers a significant cost advantage in the final generation and delivery of power compared with using compressed hydrogen. Reformulated hydrocarbon fuel provides high energy density, contributes to increased run times per unit of fuel consumed, and reduces the need for increased on-site fuel storage concerns. However, conventional reformers do not handle multiple fuel types, especially fuels containing sulfur. A reformer is needed that can handle multiple fuels with higher sulfur content and is easy to control and safe to operate. The reformer needs to have a reasonable initial capital cost and must operate with minimal maintenance.

To address these challenges, InnovaTek, Inc., with FCT funding, has developed a novel hydrogen generator that reforms multiple fuel types (natural gas, gasoline, diesel, and biodiesel) to produce pure hydrogen by integrating microreactor and microchannel heat exchanger technology with advanced sulfur-tolerant catalysts and membranes. Microstructured components, especially an integrated system of catalytic and heat exchange microchannels, produce a compact, thermodynamically efficient fuel processor design. The integrated prototype can produce 12 to 60 liters per minute of hydrogen that can fuel a 1- to 5-kW polymer electrolyte membrane (PEM) fuel cell, or other auxiliary power unit. Current work is focused on developing and delivering prototype systems for testing with various types of fuel cells. InnovaTek has partnered with commercial firms to further develop and test the unit for defense missions and for backup or auxiliary power for large trucks that have emissions control restrictions but still need power while idling.

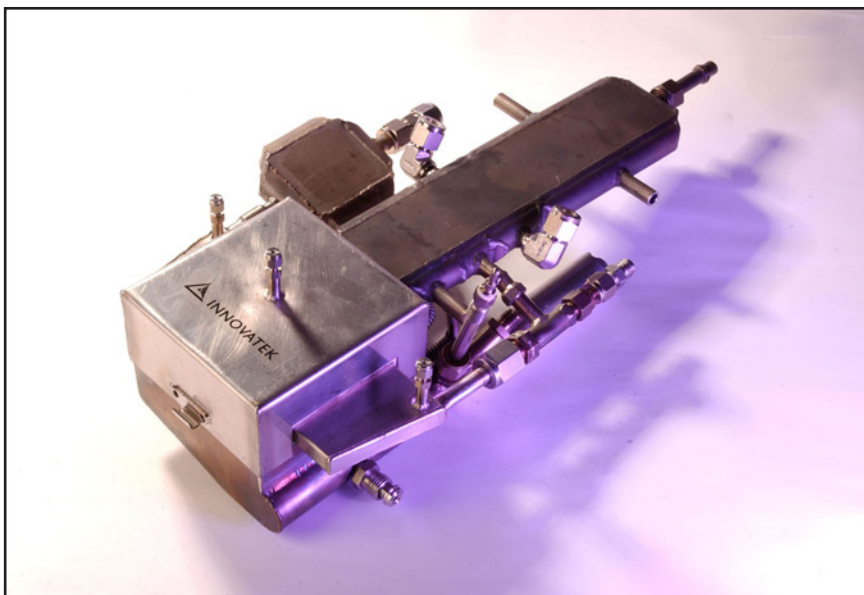

*InnovaTek's Catalytic Fuel Reformer*

## Technology History

- ◆ Developed by InnovaTek, Inc.
- ◆ Continuing work with commercial partners on prototype testing of the unit for use in defense missions and as an auxiliary power unit in large trucks.

## Applications

Can be used to produce hydrogen from multiple fuel sources, including natural gas, gasoline, diesel, biodiesel, or jet fuels.

## Capabilities

- ◆ Produces 30 to 150 grams per hour of hydrogen.
- ◆ Provides an integrated package of reformer components.
- ◆ Allows use of multiple fuel sources to generate hydrogen.

## Benefits

### Cost Savings

Increases the efficiency of the reformer by integrating the microstructured steam reformer, heat exchangers, and fuel injector.

### Performance

Demonstrates thermal efficiency >65%.

#### Contact Information:

**Patricia Irving**

Email: [irving@innovatek.com](mailto:irving@innovatek.com)

Phone: (509) 375-1093

**InnovaTek, Inc.**

3100 George Washington Way, Suite 108  
Richland, WA 99354

Website: <http://www.innovatek.com>



# Novel Stackable Structural Reactor (SSR<sup>®</sup>) for Low-Cost Hydrogen Production

Emerging Technology

## New Device Replaces Loose Ceramic Catalyst Media for Increased Efficiency in Hydrogen Production

For many years bulk hydrogen has been made from natural gas using a steam reforming process. In this process, many stainless steel tubes are suspended vertically in a furnace that operates at 850°C to 900°C. These tubes are normally 3” to 6” in diameter and up to 40 feet tall. The tubes are filled with loose ceramic media that is impregnated with catalyst materials. To maximize surface area, the ceramic media is shaped as balls, small saddles, wheels, and similar configurations. Steam and natural gas are fed to one end of the tubes; as the steam and gas pass over the catalyst-impregnated ceramic shapes, they generate hydrogen (as syngas), which is extracted from the opposite end.

The problem with the process is that it is fundamentally limited by the ability of the ceramic media to transfer heat. Also, the ceramic shapes break down and deteriorate over time, requiring the ceramic catalyst bed be replaced every three to five years.

To address the process limits and need for periodic replacement, Catacel Corp., with FCT funding through the Edison Materials Technology Center, has developed the Catacel SSR as a drop-in replacement for the loose ceramic catalyst media in the stationary steam reforming process. This replacement consists of a cylindrical metallic catalyst-impregnated honeycomb that increases heat transfer and resists mechanical breakdown. The Catacel SSR eliminates the periodic replacement that is required for ceramic packed beds and increases the overall performance of the system. Early tests have demonstrated a significant capacity increase through higher heat transfer.



*Catacel's Stackable Structural Reactor (SSR)*

## Technology History

- ◆ Developed by Catacel Corp. in partnership with Hydro-Chem, a subsidiary of the Linde Group, and the University of Toledo.
- ◆ Currently working with Hydro-Chem to perform a pilot plant test at actual field flow conditions to showcase to manufacturers.

## Applications

Can be used to replace the loose ceramic media in steam reforming furnaces.

## Capabilities

- ◆ Offers increased performance and longer life in high-temperature steam reformers.
- ◆ Provides an alternative to loose ceramic media.
- ◆ Eliminates periodic replacement of deteriorated ceramic shapes.

## Benefits

### Cost Savings

Lowers operating costs by enabling increased throughput or lower energy consumption. Also eliminates the periodic replacement of media.

### Performance

Demonstrates higher heat transfer, resulting in increased throughput or reduced energy consumption.

#### Contact Information:

**William Whittenberger**

Email: [waw@catacel.com](mailto:waw@catacel.com)

Phone: (330) 527-0731

**Catacel Corp.**

7998 Gotham Road

Garrettsville, OH 44231

Website: <http://www.catacel.com>

# Oil Free Hydrogen Compressor

Emerging Technology

## Oil-Free Compressor Being Developed to Reduce the Cost of Hydrogen Transportation and Delivery

Cost-effective compression technology is one of the critical elements needed to effectively deliver hydrogen gas via pipelines for both vehicle transportation and distributed electricity generation with fuel cells. Reciprocating compressors have been widely used in the petrochemical industry for hydrogen gas delivery; however, they are large, noisy units that use oil to lubricate and seal internal parts and are plagued by poor reliability and efficiency as well as in-line contamination of the compressed product gas stream. To ensure availability of the compressed hydrogen gas for refinery processes, two or three reciprocating compressors are often staged at each compressor station, so that one unit can be maintained and repaired without interrupting delivery and service from the station. Centrifugal compressors, which have been commonly used in transporting natural gas because of their simplicity, reliability, durability, and efficiency, have not yet been used to deliver compressed hydrogen gas because of the speed limitations of conventional bearing and seal technologies.

With the focus on hydrogen infrastructure, the advent of high-speed, noncontacting compliant surface foil bearings and seals, and the advances in centrifugal compressor aerodynamics, the potential and need exist to develop technology that substantially improves on the operational characteristics of current technologies and guarantees the delivery of hydrogen that is of the highest achievable purity.

Mohawk Innovative Technology, Inc., with FCT funding, is developing an oil free, high-speed centrifugal compressor that addresses the limitations of current compression technologies. Using advanced compliant foil gas bearings and seals, engineered coatings, in conjunction with advanced high-speed drives, this unique centrifugal compressor approach offers the best solution to overcoming the limitations and risks associated with compressors that use oil for lubrication and sealing. The completely oil free centrifugal compressor technology will have one moving component that will operate without contact between the moving and stationary parts.

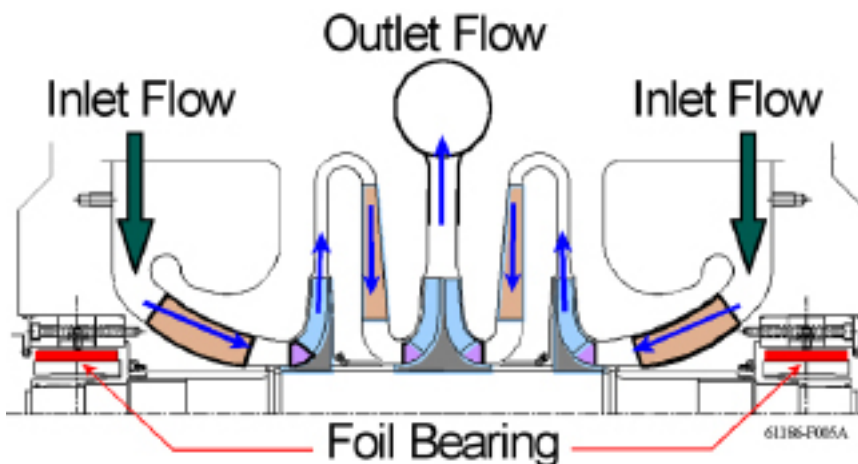

*Schematic of the Oil Free Hydrogen Compressor*

## Technology History

- ◆ Developed by Mohawk Innovative Technology, Inc.
- ◆ Establishing partnerships with large pipeline compressor equipment manufacturers.

## Applications

Can be used in pipeline-sized distribution systems for hydrogen and natural gas, from production facilities through end use.

## Capabilities

- ◆ Centrifugal compressor with foil bearings eliminates the need for oil lubrication.
- ◆ Provides flow rates up to one million kilograms of hydrogen per day with output pressures of 1,200 psi.
- ◆ Provides improved compressor reliability and efficiency.

## Benefits

### Cost Savings

Reduces the acquisition, maintenance, and operations costs for transporting and delivering hydrogen gas from production to local distribution sites.

### Productivity

Eliminates the potential for oil contamination in high-purity hydrogen gas streams.

### Contact Information:

**Jim Walton**

Email: [jwalton@miti.cc](mailto:jwalton@miti.cc)

Phone: (518) 862-4290 ext. 14

**Mohawk Innovative Technology, Inc.**

1037 Watervliet-Shaker Road

Albany, NY 12205

Website: <http://www.miti.cc>

# Photoelectrochemical Hydrogen Production

Emerging Technology

## New Technology Combines Solar, Chemical, and Electrical Hydrogen Generation

One of the methods of producing hydrogen is through water electrolysis. The electricity for the electrolysis process may be obtained from many sources such as solar, wind, or fossil fuels. To maximize the use of renewable energy, solar energy is one source of electrolysis energy that is being investigated. However, current solar conversion devices are separate from the actual hydrogen generation and losses are incurred when the cells are connected to the electrolysis system. In addition, the efficiency of the solar cells themselves needs to be improved.

A method is needed to increase the system's overall efficiency. If the solar cell were in the water media, connecting wires would not be needed. However, this approach requires researching, developing, and testing materials used for the stable and efficient operation of photoelectrochemical (PEC) hydrogen production systems. Basic material requirements include appropriate light absorption over the solar spectrum, high carrier collection efficiency, stability in suitable electrolyte solutions, and favorable kinetics for the electrode reaction.

The University of Hawaii, with FCT funding, is collaborating with numerous partners to identify and develop the most promising material classes to meet current PEC challenges in efficiency, stability, and cost in converting sunlight to hydrogen. Significant effort has focused on developing and determining a comprehensive picture of the properties and their resulting performance for classes of "focus materials" deemed of particular interest for PEC applications. The classes include tungsten-based, zinc-based, iron-based, silicon-based, and copper chalcopyrite-based films. Extensive studies of these materials classes have focused on understanding and improving PEC behavior, specifically by applying theoretical, synthesis, and analytical techniques to identify relevant aspects of structural, optoelectronic, and electrochemical properties.

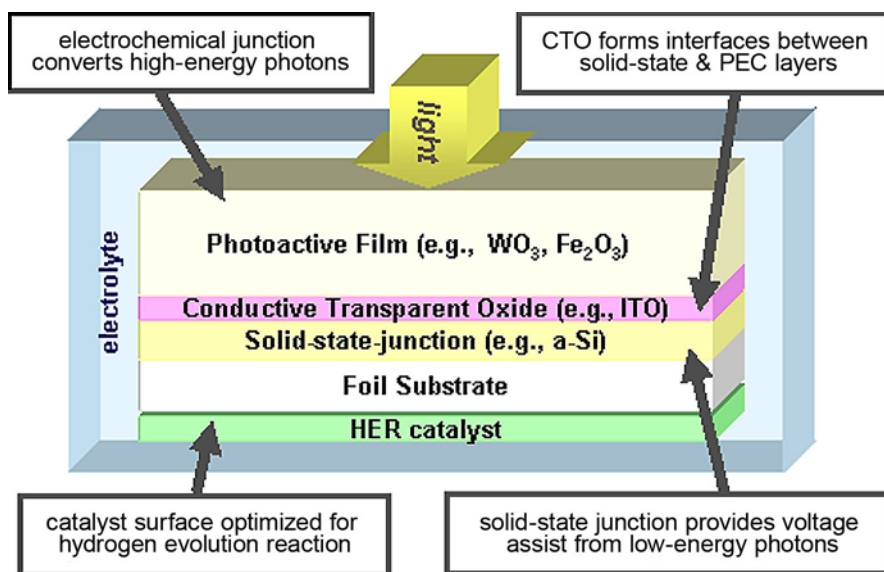

University of Hawaii's PEC Multi-Junction Hydrogen Production Cell

## Technology History

- ◆ Developed by the University of Hawaii in partnership with MVSystems, Inc., Intematix Corp., Altair Nanotechnologies, Inc., University of California-Santa Barbara, and the National Renewable Energy Laboratory.
- ◆ Continuing work to optimize the performance and durability of PEC materials and to accelerate the interface, device, and system development of the PEC hydrogen production cell.

## Applications

Can be used to produce hydrogen from solar energy.

## Capabilities

- ◆ Offers greater absorption in the visible region of the solar spectrum.
- ◆ Uses control over size and morphology of nanostructures to improve performance.
- ◆ Eliminates extra components for higher solar-to-hydrogen conversion efficiency.

## Benefits

### Cost Savings

Reduces costs by using new materials and controlling the size and morphology of nanostructures.

### Performance

Achieves increased conversion efficiency when converting solar energy to hydrogen.

### Contact Information:

**Dr. Eric Miller**

Email: [ericm@hawaii.edu](mailto:ericm@hawaii.edu)

Phone: (808) 956-5337

**University of Hawaii**

1680 East-West Road, Post 109  
Honolulu, HI 96822

Website: <http://www.hnei.hawaii.edu>



# Renewable Electrolysis Integrated System Development and Testing

Emerging Technology

## New Technology Integrates Components to Store Renewable Energy as Hydrogen

Renewable energy sources such as photovoltaics, wind, biomass, hydro, and geothermal can provide clean and sustainable electricity for our nation. Several of these options are already cost-competitive and are contributing nearly 10% of the U.S. electricity supply. Limiting greater penetration of these renewable energy sources, however, is their inherent variability and seasonal energy production. The challenge is to convert this variable energy into a form that can be stored for use as needed.

One solution to this problem is to produce hydrogen through water electrolysis and use the hydrogen in a fuel cell or internal combustion engine to produce electricity during times of low power production or peak demand or as a transportation fuel. The National Renewable Energy Laboratory (NREL), with FCT funding, and in conjunction with numerous partners, is exploring a strategy to reduce the variability of wind generation, with stored available capacity in the form of hydrogen that can be used in fuel cells or hydrogen generator systems. As part of this effort, NREL is undertaking a project called Wind2H2 in collaboration with Xcel Energy to demonstrate to utilities the benefits of shifting wind energy to hydrogen.

Currently, this approach is limited, in part, by the system cost of the renewable energy storage system. First, capital cost reductions can be realized by designing an optimized renewable-capable electrolyzer system. The reduction of redundant electronics and power conversion steps while accommodating varying power to the stack would help reduce capital cost. Second, improved controls for both the renewable source and electrolyzer system are being combined for smoother operation and improved efficiency. In addition to the ongoing efforts to reduce the cost of renewable technologies and to lower the capital requirements for electrolyzers, NREL is working on optimizing these renewable electrolysis systems and tailoring them to realize the most cost-competitive option for co-generation of electricity and hydrogen production.

## Technology History

- ◆ Developed by NREL in partnership with Xcel Energy, Proton Energy Systems, Teledyne Energy Systems, the University of North Dakota, and the University of Minnesota.
- ◆ Continuing work on baseline and renewable energy source testing for the Wind2H2 project, and accelerating cost and performance modeling/simulation of renewable electrolysis systems.

## Applications

Can be used to generate hydrogen from renewable energy sources.

## Capabilities

- ◆ Stores renewable energy in the form of hydrogen.
- ◆ Uses power electronics to regulate variable outputs from various renewable sources.
- ◆ Eliminates pollution from energy production by using clean renewables.

## Benefits

### Cost Savings

Saves renewable energy that would be wasted if it wasn't needed at the time of generation.

### Performance

Allows the use of efficient fuel cells to produce energy from stored renewable sources in the form of hydrogen.

### Contact Information:

**Kevin Harrison**

Email: [Kevin.Harrison@nrel.gov](mailto:Kevin.Harrison@nrel.gov)

Phone: (303) 384-7091

**National Renewable Energy Laboratory**

1617 Cole Blvd.

Golden, CO 80401

**Website:**

[www.nrel.gov/hydrogen/proj\\_wind\\_hydrogen.html](http://www.nrel.gov/hydrogen/proj_wind_hydrogen.html)

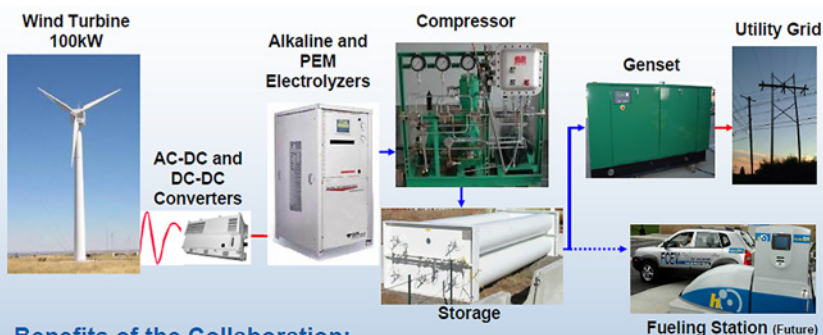

### Benefits of the Collaboration:

- Examine benefit to utility by shifting wind production in time
- Research optimal wind/hydrogen through systems engineering
- Characterize and control wind turbine and H2-producing stack
- Evaluate synergies from co-production of electricity and hydrogen
- Compare alkaline and PEM electrolyzer technologies
- Realize efficiency gains through a unique integrated PE

NREL National Renewable Energy Laboratory

NREL's Wind2H2 Project Collaboration

# Reversible Liquid Carriers

## New Technology Stores and Releases Hydrogen Safely and Efficiently

Hydrogen can be stored for fuel cells in stationary and mobile applications in several ways. Hydrogen may be stored in its gaseous form in high-pressure tanks but requires storage areas that fit the design of the cylinders. In addition, the cylinders must be protected from impact to prevent a catastrophic release of gas. Liquid hydrogen presents even more problems because it must be kept at an extremely low temperature and requires constant venting to prevent excessive pressure buildup. Chemicals can release hydrogen but require special containers to convert the solid and contain the resulting gas. The byproduct needs specialized regeneration if it is to be recycled because the reaction is not easily reversible. A material is needed that produces hydrogen through an easily reversible reaction and is in a safe, liquid form that could be contained in simple tanks.

Air Products and Chemicals, Inc., with FCT funding, developed a carrier in the form of new liquid-phase hydrogen storage materials that can be reversibly hydrogenated, allowing for hydrogen to be stored in an efficient, safe, and easily transportable form. The liquid carriers can be hydrogenated at large central or regional sites, in locations where inexpensive hydrogen is available, allowing for high overall energy efficiency through material recovery and use of the heat generated by exothermic hydrogenation. Alternatively, autothermal hydrogen carriers could provide both hydrogen and the thermal energy needed to liberate the hydrogen from the carrier, where it would be dispensed to a fuel cell. Several acceptable carrier prototypes have been identified, and the economic and technical aspects of field deployment in both stationary and mobile hydrogen fuel applications were evaluated. This solution provides liquid carriers that show appropriate storage capacity (5% to 7% hydrogen by weight), have high selectivity for hydrogenation and dehydrogenation reactions at low temperature, and exhibit low volatility, thus improving the safety and storage of hydrogen.

## Technology History

- ◆ Developed by Air Products and Chemicals, Inc., in partnership with United Technologies Research Corporation, Pacific Northwest National Laboratory, and BMW AG.
- ◆ Project completed at the end of 2010 and currently investigating commercial opportunities. Technology developed is a 0.1-1 kW prototype microchannel dehydrogenation reactor with an autothermal process to drive the dehydrogenation reactor.

## Applications

Can be used in both stationary and portable environments that require the stable, efficient, and safe delivery of hydrogen.

## Capabilities

- ◆ Stores in liquid form at 5% to 7% hydrogen by weight.
- ◆ Allows hydrogen to be stored as gas in a stable, hydrogenated liquid.
- ◆ Stores in a simple, nonpressurized tank.

## Benefits

### Performance

Allows for multiple cycles and long life because of the selective, reversible reaction.

### Safety

Enables use of liquid carriers in simplified systems in vehicles and reduces potential exposure to vapors because of its low volatility.

### Contact Information:

**Alan Cooper**

Email: [cooperac@airproducts.com](mailto:cooperac@airproducts.com)

Phone: (610) 481-2607

**Air Products and Chemicals, Inc.**

7201 Hamilton Boulevard

Allentown, PA 18195

Website: <http://www.airproducts.com>

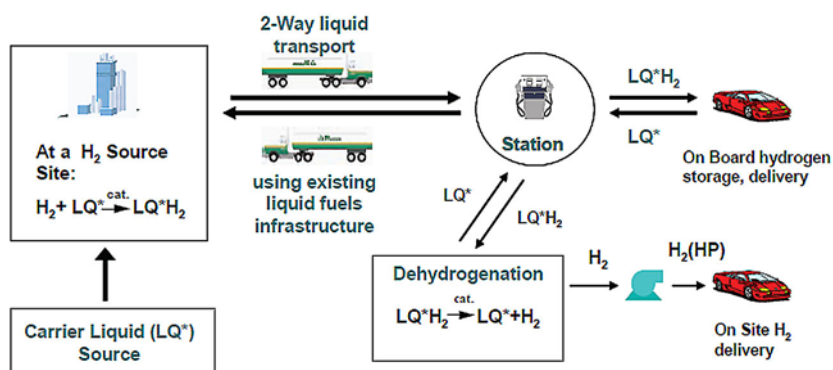

Air Products' Reversible Liquid Carrier System

<b>E.3 Storage Technologies</b> .....	E-63
◆ <a href="#">High-Strength, Low-Cost Microballoons for Hydrogen Storage</a> .....	E-64
◆ <a href="#">Hydrogen Storage in Cryo-Compressed Vessels</a> .....	E-65
◆ <a href="#">Manufacturing Technologies for Low-Cost Hydrogen Storage Vessels</a> .....	E-66
◆ <a href="#">Rapid Manufacturing of Vehicle-Scale, Carbon-Composite, High-Pressure Hydrogen Storage Cylinders</a> .....	E-67
◆ <a href="#">Safe and Effective Storage and Transmission of Hydrogen</a> .....	E-68
◆ <a href="#">Sodium Silicide (NaSi) Hydrogen Generation System</a> .....	E-69



# High-Strength, Low-Cost Microballoons for Hydrogen Storage

Emerging Technology

## New Material Stores Hydrogen Safely and Cost Effectively

If hydrogen-fueled vehicles are to become widespread, effective and safe containment and transport of hydrogen are needed. Conventional hydrogen storage methods involve cylinders operating at high pressure. The high pressure mandates that the cylinders must be symmetrical and free of stress risers such as sharp corners. High-pressure cylinders also are limited in that they have fixed dimensions and require specialized support and protection from damage. Their fixed dimensions dictate the amount of hydrogen storage available, and the receiving vehicle needs a storage area that matches the cylinders' dimensions and configuration. In addition, if the cylinders are damaged, the spontaneous release of their contents can be catastrophic.

To address these problems, a new method of hydrogen storage needs to be devised. The new method should use a material that conforms to the shape of the storage area available in the vehicle. The material should flow like a liquid so it could be stored in different configurations without concern for stress risers. The material should be designed to prevent catastrophic release of all the hydrogen if the storage container is damaged. Finally, the material remaining after the hydrogen is removed should be harmless to the environment and the personnel who use the device.

Powdermet, Inc., has developed such material with funding from FCT, through the Edison Materials Technology Center, in the form of lightweight carbon microballoons, which are used as a scaffold for a high-strength material that can act as a hydrogen-impermeable barrier at room temperature. This structure enables high weight percent storage of hydrogen in safe individual microballoons. The microballoons are easily transported and flow under gravity like a liquid. The waste products after the hydrogen is released (carbon and inert ceramic particles) are harmless to the environment and the personnel who use the device.

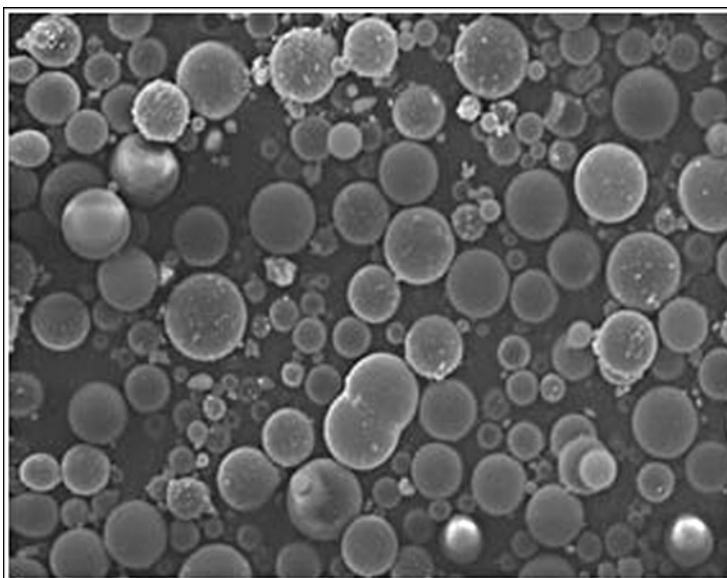

*Powdermet Hydrogen Storage Microballoons*

## Technology History

- ◆ Developed by Powdermet, Inc., in collaboration with AF Research Labs, Precision Energy and Technology, and Protonex Technology Corporation.
- ◆ Designing, building, and testing the hydrogen storage and delivery systems for the microballoons.

## Applications

Can be used to safely and effectively store hydrogen gas for use in vehicles or other applications.

## Capabilities

- ◆ Stores over 18 weight percent of hydrogen with a practical limit of about 12 weight percent of hydrogen in 1 mm spheres.
- ◆ Can be used as a storage and delivery system and to create structural foam.

## Benefits

### Environmental

Produces harmless waste products after hydrogen release.

### Flexibility

Flows like water and conforms to any shape container.

### Safety

Uses pressurized microballoons, but the storage container is at atmospheric pressure.

### Contact Information:

**Andrew Sherman**

Email: [powdermet@earthlink.net](mailto:powdermet@earthlink.net)

Phone: (216) 404-0053

**Powdermet, Inc.**

24112 Rockwell Dr

Euclid, OH 44117

Website: <http://www.powdermetinc.com>

# Hydrogen Storage in Cryo-Compressed Vessels

## New Hydrogen Tank Demonstrates High Energy Density and Results in Increased Driving Range

Liquid hydrogen is a lightweight and compact form for storing hydrogen, making it an ideal choice for space and weight restrictive environments. However, storing liquid hydrogen onboard automobiles presents a significant problem. Because automobiles are often parked for days at a time, the tank holding the liquid hydrogen starts to build pressure as heat from the environment warms the hydrogen inside. Currently, automotive liquid hydrogen tanks must vent the evaporated hydrogen after being parked for only three to four days, even when using the best thermal insulation available.

Lawrence Livermore National Laboratory (LLNL), with funding from FCT, developed cryogenic capable pressure vessels. The cryo-compressed storage tanks present three fundamental advantages over ambient pressure compressed hydrogen tanks, including maintaining the high energy density of liquid hydrogen without evaporative losses, requiring fewer carbon fiber materials of construction yielding long-term cost savings potential, and maintaining fueling flexibility for both liquid and gas fuel sources. The cryogenic pressure vessel can operate at pressures of up to 350 bar, effectively containing the hydrogen even as the pressure increases from heat transfer. The high-pressure capability also improves the vehicle's thermal endurance as the tank is emptied, eventually being able to hold the hydrogen fuel indefinitely.

LLNL's cryogenic pressure vessel was installed in an experimental vehicle, where it demonstrated the longest driving distance on a single hydrogen tank, as well as the longest liquid hydrogen holding time without venting any of the fuel. Continuing research and development are focused on scaling down the existing system while targeting aggressive reductions in the cost, weight, and volume characteristics of the vessel. LLNL is effectively collaborating with industry using the cryogenic pressure vessel as a benchmark for advanced storage system research, such as the 700 bar high pressure storage vessel, ambient temperature systems, and pure liquid hydrogen systems.

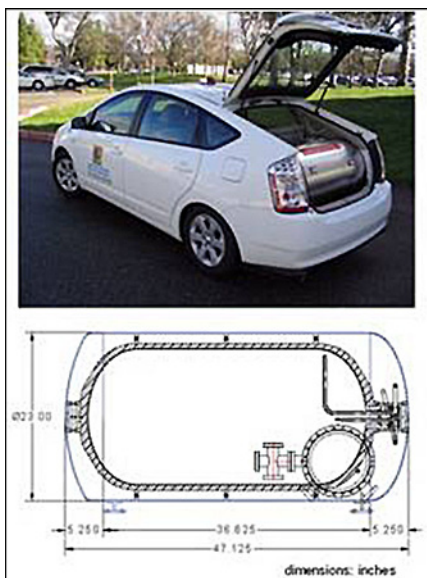

LLNL's Cryo-Compressed Hydrogen Storage Vessel

## Technology History

- ◆ Being developed by LLNL in partnership with Structural Composite Industries.
- ◆ Continuing work on designing, manufacturing, and full-cycle testing of a new cryogenic pressure vessel for onboard vehicle hydrogen storage.

## Applications

Can be used to store hydrogen for use in hydrogen-powered vehicles.

## Capabilities

- ◆ Provides high specific energy and high energy density storage.
- ◆ Achieves flexible refueling with either compressed or liquid hydrogen.
- ◆ Can be dormant for extended periods with no measured loss of fuel from the vessel.

## Benefits

### Performance

Exceeds 500 miles per fill for a single liquid hydrogen tank.

### Versatility

Can be used with either compressed or liquid hydrogen.

### Contact Information:

**Salvador M. Aceves**

Email: [saceves@llnl.gov](mailto:saceves@llnl.gov)

Phone: (925) 422-0864

**Lawrence Livermore National Laboratory**

7000 East Avenue, L-644

Livermore, CA 94551

Website: <http://www.llnl.gov>

# Manufacturing Technologies for Low-Cost Hydrogen Storage Vessels

Emerging Technology

## Hybrid Process Reduces the Amount of Carbon Fiber Used in a Pressure Vessel

Hydrogen has the highest energy content per unit weight of all commonly available fuels but has low energy content by volume. To overcome this limitation, a common hydrogen storage method uses compressed hydrogen stored in high-pressure metal or composite storage vessels. Hydrogen storage systems must overcome the challenges of reducing weight and cost. Durability, safety, and efficiency of hydrogen storage systems are also areas of concern. Composite pressure vessels are traditionally made with carbon fiber by filament winding (FW), which has been standard practice since the 1950's. Advanced fiber placement (AFP) has been around since the 1970's. AFP has been used to strengthen more complex shapes that cannot be manufactured using the continuous FW process, which requires a regular shape, e.g., a cylinder. The drawback of FW is that when additional reinforcement of a vessel's endcaps is necessary, fiber has to travel between the domes in a continuous fashion. The fiber laid down between the domes is considered as parasitic fiber, which adds cost and weight to the vessel.

The novel idea of combining both FW and AFP manufacturing methods has been demonstrated by Quantum Technologies, with funding from the U.S. Department of Energy's Fuel Cell Technologies Program. Quantum Technologies is developing a hybrid manufacturing method to eliminate parasitic fiber. In the hybrid process, the AFP method places fiber where it is needed and does not place fiber in the cylinder section when trying to reinforce the domes. After AFP layers are applied, a FW process step then completes the vessel construction by reinforcing the cylinder section and further reinforcing the domes to bring the vessel up to the required strength. By removing the parasitic fiber, the cost and weight of the pressure vessel are reduced dramatically. A recently constructed demonstration vessel used 23% less carbon fiber. Testing is underway to evaluate the improved AFP hardware as well as safety and performance testing on hybrid vessels according to European Parliament regulation EC-79, which pertains to specifications and requirements for on-board hydrogen storage systems for transportation applications.



*Quantum's Hybrid Manufacturing Technology for Pressure Vessels*

## Technology History

- ◆ Developed by Quantum Technologies and the Boeing Company.
- ◆ Continuing testing to improve AFP manufacturing hardware and performing pressure vessel testing according to EC-79 regulation.

## Applications

Can be used to manufacture high-pressure vessels for fuel storage at lower weight and cost.

## Capabilities

- ◆ Produces pressure vessels using less carbon fiber.
- ◆ Reduces weight without compromising pressure rating.
- ◆ Enables hydrogen and compressed natural gas vehicles to be more cost competitive.

## Benefits

### Cost Savings

Eliminates parasitic fiber in FW to reduce carbon fiber material cost.

### Manufacturability

Separates AFP end-cap manufacturing from the FW process, enabling parallel processing.

### Weight Savings

Optimizes carbon fiber placement for reduced pressure vessel weight without compromising vessel structure integrity.

#### Contact Information:

**Patrick Lam**

Email: [plam@qtw.com](mailto:plam@qtw.com)

Phone: (949) 399-4521

**Quantum Fuel System Technologies  
Worldwide, Inc.**

25242 Arctic Ocean Dr.

Lake Forest, CA 92630

Website: <http://www.qtw.com>

# Rapid Manufacturing of Vehicle-Scale, Carbon-Composite, High-Pressure Hydrogen Storage Cylinders

Emerging Technology

## Novel Process and Materials Accelerate the Production of Hydrogen Tanks

Currently, the cost and production rate of high-pressure storage cylinders for onboard hydrogen are limiting vehicle introduction. High-pressure tanks are a key component of fuel systems involving hydrogen, methane, and natural gas and therefore a key factor in fuel cell applications. Filament winding (FW) has been the process used to produce tanks for over 40 years, with incremental improvements being made in materials, application, and manufacturing technologies. FW technology results in a tank being produced every 5 to 8 hours and is well recognized as inconsistent with commercial introduction of hydrogen vehicles, even in specialty and small fleets.

To support the commercial introduction of hydrogen vehicles, a faster and easier method to fabricate tanks is needed. Materials need to be developed that will support a new method of manufacturing that improves the fabrication cycle time yet maintains structural integrity. The goal is to produce tanks at a rate approaching vehicle production. Ideally, the method and materials must be equally applicable to conformal tanks and scalable to larger-size transportation cylinders.

To satisfy these requirements, Profile Composites Inc., with funding from FCT through the National Center for Manufacturing Sciences, is developing a manufacturing process for fabricating high-pressure hydrogen storage cylinders in an automotive production environment. The process is compatible with low-volume and specialty vehicle production rates of about 20,000 vehicles per year on a single tooling line. The technology will be used in gas cylinders such as hydrogen, methane, and natural gas. It is equally applicable to conformal tanks and scalable to larger-size transportation cylinders. The process can now produce tanks at rates approaching vehicle production. Although materials costs are not significantly changed, total manufacturing costs are reduced as substantially fewer parallel tooling lines are required.

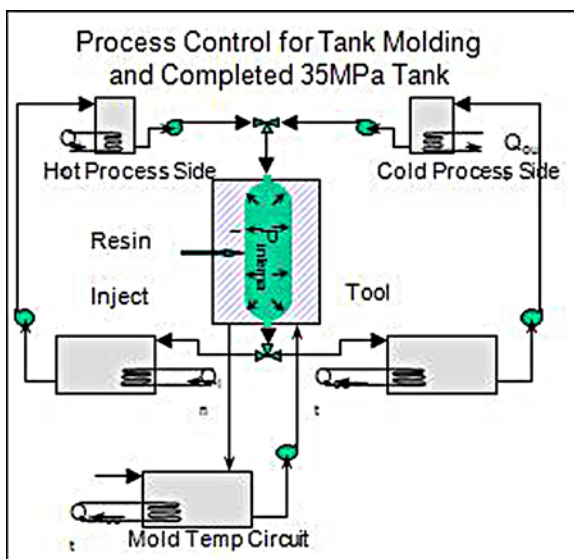

Profile Composites' Hydrogen Tank Fabrication Process

## Technology History

- ◆ Developed by Profile Composites Inc., in partnership with Toyota Motor Engineering and Manufacturing North America, Inc., MAG Cincinnati Automation & Test, A&P Technology, Inc., and Bayer MaterialScience LLC.
- ◆ Planning to commercialize a 5,000 psi cylinder and begin developing a 10,000 psi cylinder. Awaiting certification of the tank so commercialization can start.

## Applications

Can be used in gas cylinders such as hydrogen, methane, and natural gas.

## Capabilities

- ◆ Allows fabrication of high-pressure hydrogen storage tanks in under 20 minutes total cycle time.
- ◆ Produces tanks at rates approaching vehicle production.
- ◆ Reduces the number of parallel tooling lines needed for production.

## Benefits

### Cost Effectiveness

Reduces users' cost through high-volume production of cylinders.

### Safety

Offers benign failure modes compared with filament-wound tanks.

### Contact Information:

**Geoffrey Wood**

Email: [geoff.wood@profilecomposites.com](mailto:geoff.wood@profilecomposites.com)

Phone: (250) 655-7142

**Profile Composites Inc.**

2071B Malaview Avenue West

Sidney, BC Canada V8L 5X6

Website: <http://www.profilecomposites.com>



# Safe and Effective Storage and Transmission of Hydrogen

Emerging Technology

## Liquid Magnesium Hydride Slurry Stores Hydrogen Safely and Efficiently

Traditional storage technologies for hydrogen include bottled compressed hydrogen gas and bottled liquid hydrogen. Using such technologies has been limited because of dangers in storing, handling, and transporting the hydrogen. Storing or transporting hydrogen gas and cryogenic liquid has demonstrated instability and high combustibility. In addition, compressed and liquid hydrogen tanks often don't store sufficient volumes and pose safety risks related to both pressure and flammability. The alternative, solid metal hydride tanks, is heavy and time consuming to fill. The solid metal hydride is not easily transferred and is subject to decomposition from moisture in the air.

Ease of transfer of hydrogen "fuel" is a requirement that must be met before hydrogen can be commercially viable as an alternative energy carrier. Ideally, a hydrogen carrier should be safe and easy to pump in a liquid form. It should fit within the existing liquid transfer system and reduce the risk of fire and explosion. It should have a high energy density, exceeding that of liquid hydrogen, and be capable of recycling and regeneration at a reasonable cost.

To meet these requirements, Safe Hydrogen, LLC, with assistance from FCT, is developing a chemical hydride technology that offers the required storage efficiency and storage safety. The patented technology provides the cost saving advantage of being able to use the existing fossil fuel infrastructure to deliver and store a pumpable and nonexplosive magnesium hydride mineral oil slurry as the future "hydrogen fuel." At approximately the same volume, one unit of liquid magnesium hydride slurry carries the potential of generating twice as much hydrogen (by volume) as one unit of cryogenically cooled liquid hydrogen without the flammability and pressure hazards.

## Technology History

- ◆ Developed by Safe Hydrogen, LLC.
- ◆ Establishing its application using conventional pumping and transportation mediums and infrastructure.

## Applications

Can be used anywhere consistent delivery of gaseous hydrogen is needed.

## Capabilities

- ◆ Delivers hydrogen with low input of energy.
- ◆ Provides a nonexplosive, noncorrosive hydrogen source.
- ◆ Can be reused by recycling the byproducts into the original hydride.

## Benefits

### Efficiency

Displays superior storage density compared with cryogenically cooled liquid hydrogen.

### Safety

Consists of a magnesium hydride slurry, which is a nonexplosive carrier of hydrogen.

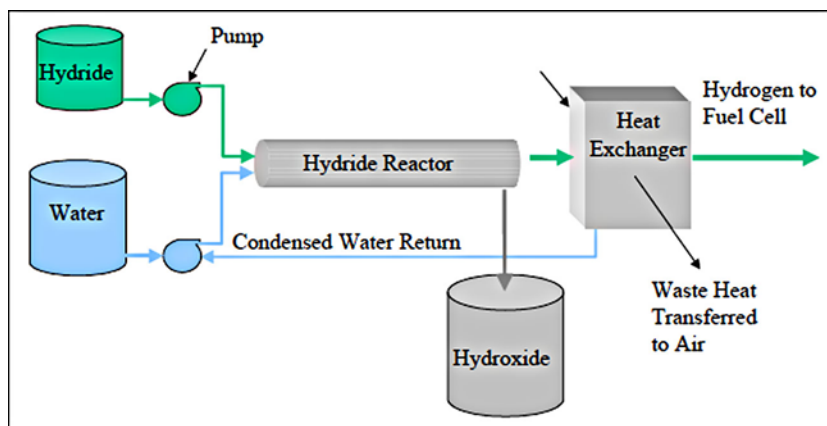

Safe Hydrogen's Hydride Slurry System

**Contact Information:**  
Andrew W. McClaine  
Email: [awmclaine@rcn.com](mailto:awmclaine@rcn.com)  
Phone: (781) 861-7016  
Safe Hydrogen, LLC  
30 York St  
Lexington, MA 02420  
Website: <http://www.SafeHydrogen.com>

# Sodium Silicide (NaSi) Hydrogen Generation System

Emerging Technology

## Novel Technology Provides Low-Cost Hydrogen Generation for Fuel Cell Portable Power Applications

Hydrogen used in portable fuel cell systems is often supplied via fossil fuel reforming, an energy intensive process that requires the use of expensive precious metal catalysts and emits carbon dioxide as a byproduct. Another common method, storing compressed hydrogen under high pressure in an onboard tank, also requires energy expenditure and presents safety hazards of tank leakage and/or rupturing. An alternative is needed that can generate hydrogen safely and reliably while minimizing energy usage and cost.

To address this need, SiGNa Chemistry, Inc., with FCT funding, has developed a novel technology that uses a stable, room-temperature reaction between sodium silicide (NaSi) and water to generate hydrogen. The chemical reaction generates hydrogen gas at pressures from 2 psi to 30 psi, with nontoxic, water-soluble sodium silicate as the only byproduct. SiGNa can customize their NaSi cartridges to suit the shape and electricity generation needs of a particular application. The cartridges are hot-swappable, enabling extended runtimes without an interruption of power. Power output is consistent over the entire runtime, without the degradation associated with batteries. In addition to its performance features, the SiGNa technology is also safe and environmentally friendly. The NaSi powder can be stored in a dry-air container without oxidizing and has a demonstrated storage life of more than 2 years. The sodium silicate byproduct is nontoxic, environmentally benign and remains in the original fuel cartridge for easy recycling or disposal.

SiGNa is currently supplying NaSi powder and customized canisters to the Swedish fuel cell company myFC AB for use in their PowerTrek™ portable fuel cell charger. The company is also using a U.S. Agency for International Development (USAID) grant to develop an NaSi-fueled, fuel-cell-powered electric bicycle that can be deployed in developing countries for personal transportation or to deliver medicines. The NaSi canisters can also aid in disaster situations by powering emergency response systems, medical refrigerators, and telecommunications equipment.

## Technology History

- ◆ Developed by SiGNa Chemistry, Inc., in partnership with Trulite, Inc., and the University of Texas at Austin Center for Electromechanics.
- ◆ Supplying customized NaSi canisters to the Swedish fuel cell company myFC for use in their PowerTrek portable fuel cell charger.
- ◆ Working with the USAID to develop NaSi-fueled, fuel-cell-powered electric bicycles and emergency equipment.

## Applications

Can be used to generate hydrogen for portable fuel cell applications such as backup power, battery re-charging, remote telecommunications, emergency response equipment, and personal mobility devices.

## Capabilities

- ◆ Generates hydrogen at pressures from 2 psi to 30 psi based on specific customer needs.
- ◆ Provides up to 300 W of continuous power and 500 W of peak power when coupled to a fuel cell generator system.

## Benefits

### Cost Savings

Reduces costs by using a room-temperature reaction, which does not require an expensive catalyst to produce hydrogen.

### Safety

Uses a solid powder reactant that does not ignite or oxidize when exposed to air and is stable over all practical temperatures (-55°C to 300°C).

### Contact Information:

**Andrew Wallace**

Email: [apwallace@signachem.com](mailto:apwallace@signachem.com)

Phone: (530) 554-2217

**SiGNa Chemistry, Inc.**

720 Olive Drive, Suite C

Davis, CA 95616

Website: <http://signachem.com/>

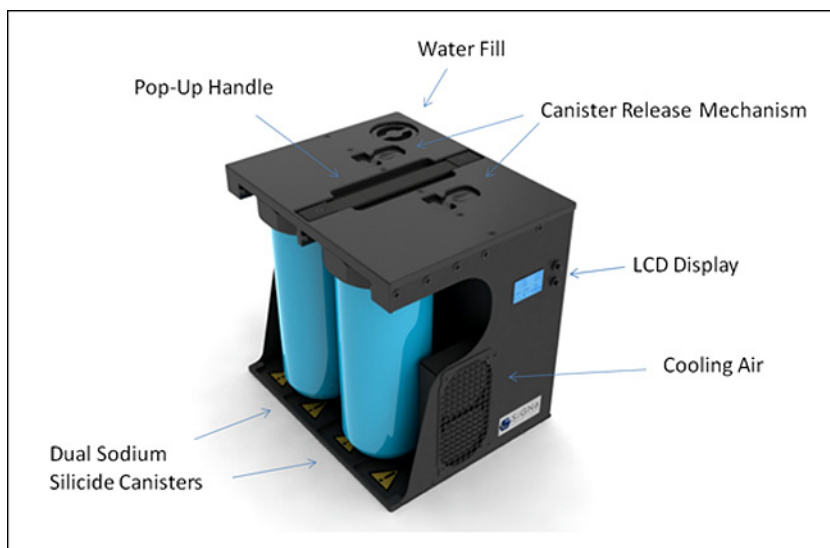

SiGNa Chemistry's H300 Hydrogen Generation System





# Appendix F:

## Directory of Technology Developers

### Commercially Available Fuel Cell Technologies

3M Company	
<a href="#">Advanced Cathode Catalysts and Supports for PEM Fuel Cells</a> .....	D-4
<a href="#">Membranes and Membrane Electrode Assemblies for Dry, Hot Operating Conditions</a> .....	D-28
Argonne National Laboratory	
<a href="#">GCtool: Fuel Cell Systems Analysis Software Model</a> .....	D-16
BASF Fuel Cell, Inc.	
<a href="#">Integrated Manufacturing for Advanced Membrane Electrode Assemblies</a> .....	D-24
Bulk Molding Compounds, Inc.	
<a href="#">Conductive Compound for Molding Fuel Cell Bipolar Plates</a> .....	D-10
DuPont Fuel Cells	
<a href="#">Breakthrough Lifetime Improvements for PEM Fuel Cells</a> .....	D-6
Dynalene, Inc.	
<a href="#">Complex Coolant for Polymer Electrolyte Membrane (PEM) Fuel Cells</a> .....	D-8
Freudenberg-NOK General Partnership	
<a href="#">Manufacture of Durable Seals for PEM Fuel Cells</a> .....	D-26
Fuel Cell Technologies, Inc.	
<a href="#">Corrosion Test Cell for PEM Bipolar Plate Materials</a> .....	D-12
IRD Fuel Cells LLC	
<a href="#">Improved Catalyst Coated Membrane (CCM) Manufacturing</a> .....	D-20
NuVant Systems Inc.	
<a href="#">Improved Fuel Cell Cathode Catalysts Using Combinatorial Methods</a> .....	D-22
Nuvera Fuel Cells, Inc.	
<a href="#">Cost-Effective, High-Efficiency, Advanced Reforming Module (CHARM)</a> .....	D-14
Plug Power Inc.	
<a href="#">GenDrive™ Fuel Cell Power System</a> .....	D-18
Porvair Advanced Materials, Inc.	
<a href="#">Scale-Up of Carbon-Carbon Composite Bipolar Plates</a> .....	D-36
Protonex Technology Corporation	
<a href="#">Novel Manufacturing Process for PEM Fuel Cell Stacks</a> .....	D-30
UltraCell Corporation	
<a href="#">Portable Reformed Methanol Fuel Cells</a> .....	D-32
UTC Power	
<a href="#">PureMotion® Model 120 Fuel Cell Power Plant</a> .....	D-34

## **Commercially Available Production/Delivery Technologies**

Air Liquide Process and Construction	
<a href="#">Hydrogen Distributed Production System</a> .....	D-46
Avalence, LLC	
<a href="#">High-Efficiency, High-Pressure Electrolysis via Photovoltaic Arrays</a> .....	D-44
Genesis Fueltech, Inc.	
<a href="#">Membrane Structures for Hydrogen Separation</a> .....	D-54
Giner Electrochemical Systems, LLC	
<a href="#">PEM Electrolyzer Incorporating an Advanced Low-Cost Membrane</a> .....	D-58
GreenField Compression	
<a href="#">H2 ProGen: A Total Supply Solution for Hydrogen Vehicles</a> .....	D-42
NexTech Materials, Ltd.	
<a href="#">Hydrogen Safety Sensor for Advanced Energy Applications</a> .....	D-50
<a href="#">Nanoscale Water Gas Shift Catalysts</a> .....	D-56
Proton Energy Systems, Inc.	
<a href="#">FuelGen® Hydrogen Fueling Systems</a> .....	D-40
<a href="#">Hydrogen Generation from Electrolysis</a> .....	D-48
REB Research & Consulting	
<a href="#">ME100 Methanol Reforming Hydrogen Generator</a> .....	D-52

## **Commercially Available Storage Technologies**

Digital Wave Corporation	
<a href="#">Non-Destructive Ultrasonic Scanning Technology</a> .....	D-64
Quantum Technologies, Inc.	
<a href="#">Hydrogen Composite Tanks</a> .....	D-62

## **Emerging Fuel Cell Technologies**

3M Company	
<a href="#">Durable Catalysts for Fuel Cell Protection During Transient Conditions</a> .....	E-10
Acumentrics Corporation	
<a href="#">Low-Cost 3-10 kW Tubular SOFC Power System</a> .....	E-21
Arkema Inc.	
<a href="#">Improved Low-Cost, Durable Fuel Cell Membranes</a> .....	E-20
Ballard Material Products, Inc.	
<a href="#">Reduction in Fabrication Costs of Gas Diffusion Layers</a> .....	E-35
BASF Catalysts LLC	
<a href="#">Platinum-Group-Metal Recycling Technology</a> .....	E-30
Brookhaven National Laboratory	
<a href="#">Low Platinum Loading Fuel Cell Electrocatalysts</a> .....	E-24
<a href="#">Platinum Monolayer Electrocatalysts on Stable Low-Cost Supports</a> .....	E-31

Cabot Superior MicroPowders	
<a href="#">High-Performance, Low-Pt Cathodes Containing New Catalysts and Layer Structure</a>	E-18
Delphi Corporation	
<a href="#">Solid Oxide Fuel Cell Auxiliary Power Unit</a>	E-40
Faraday Technology, Inc.	
<a href="#">FARADAYIC ElectroEtching of Stainless Steel Bipolar Plates</a>	E-13
FuelCell Energy, Inc.	
<a href="#">High-Temperature Membrane with Humidification-Independent Cluster Structure</a>	E-19
Giner Electrochemical Systems, LLC	
<a href="#">Dimensionally-Stable High-Performance Membrane</a>	E-6
GrafTech International Ltd.	
<a href="#">Resin-Impregnated, Expanded-Graphite GRAFCELL® Bipolar Plates</a>	E-36
Honeywell Aerospace	
<a href="#">Thermal and Water Management Systems for PEM Fuel Cells</a>	E-41
InnoSense, LLC	
<a href="#">Direct-Write Inkjet Printing for Fabricating Hydrogen Sensors</a>	E-9
Intelligent Energy Inc.	
<a href="#">High-Efficiency Polymer Electrolyte Membrane Fuel Cell Combined Heat and Power System</a>	E-17
Ion Power, Inc.	
<a href="#">Platinum and Fluoropolymer Recovery from PEM Fuel Cells</a>	E-29
Jadoo Power Systems, Inc.	
<a href="#">Portable Solid Oxide Fuel Cell Generator</a>	E-33
Lilliputian Systems, Inc.	
<a href="#">Silicon-Based Solid Oxide Fuel Cell for Portable Consumer Electronics</a>	E-38
Makel Engineering, Inc.	
<a href="#">Low-Cost Hydrogen Sensor for Transportation Safety</a>	E-22
MTI Micro Fuel Cells, Inc.	
<a href="#">Direct Methanol Fuel Cell for Handheld Electronics Applications</a>	E-8
Nanosys, Inc.	
<a href="#">Engineered Nanostructured MEA Technology for Low-Temperature Fuel Cells</a>	E-11
Nanotek Instruments, Inc.	
<a href="#">Low-Cost Manufacturing of Sheet Molding Compound Bipolar Plates for PEM Fuel Cells</a>	E-23
National Renewable Energy Laboratory	
<a href="#">Direct Methanol Fuel Cell (DMFC) Anode Catalysts</a>	E-7
<a href="#">Extended Continuous Pt Nanostructures in Thick, Dispersed Electrodes</a>	E-12
NexTech Materials, Ltd.	
<a href="#">Sensors for Automotive Fuel Cell Systems</a>	E-37
Nuvera Fuel Cells, Inc.	
<a href="#">CIRRUS: Cell Ice Regulation and Removal Upon Start-up</a>	E-5
<a href="#">Power Edge™ Fuel Cell System</a>	E-34

Oak Ridge National Laboratory	
<a href="#">Nitrated Metallic Bipolar Plates for PEM Fuel Cells</a> .....	E-28
Pacific Northwest National Laboratory	
<a href="#">Alternative and Durable High-Performance Cathode Supports for PEM Fuel Cells</a> .....	E-4
Plug Power Inc.	
<a href="#">GenSys® Blue: High-Temperature CHP Fuel System</a> .....	E-16
SAFCCell, Inc.	
<a href="#">Solid Acid Fuel Cell Stack for Auxiliary Power Unit Applications</a> .....	E-39
Sandia National Laboratories	
<a href="#">Fuel-Cell-Based Mobile Lighting</a> .....	E-15
Scribner Associates, Inc.	
<a href="#">Fuel Cell Membrane Measurement System for Manufacturing</a> .....	E-14
Technology Management, Inc.	
<a href="#">Multi-Fuel Solid Oxide Fuel Cell (SOFC) System</a> .....	E-27
UTC Power	
<a href="#">Polymer Electrolyte Membrane (PEM) Fuel Cell Power Plant Development and Verification</a> .....	E-32
W.L. Gore and Associates, Inc.	
<a href="#">Manufacturing of Low-Cost, Durable Membrane Electrode Assemblies</a> .....	E-25
<a href="#">Materials and Modules for Low-Cost, High-Performance Fuel Cell Humidifiers</a> .....	E-26
<b><u>Emerging Production/Delivery Technologies</u></b>	
Air Products and Chemicals, Inc.	
<a href="#">Ceramic Membrane Reactor Systems for Converting Natural Gas to Hydrogen and Synthesis Gas (ITM Syngas)</a> .....	E-46
<a href="#">Reversible Liquid Carriers</a> .....	E-62
Catapel Corporation	
<a href="#">Novel Stackable Structural Reactor (SSR®) for Low-Cost Hydrogen Production</a> .....	E-58
Concepts NREC	
<a href="#">Centrifugal Hydrogen Pipeline Gas Compressor</a> .....	E-45
GE Global Research Center	
<a href="#">Integrated Short Contact Time Hydrogen Generator</a> .....	E-54
H2Pump, LLC	
<a href="#">HRS-100™ Hydrogen Recycling System</a> .....	E-49
InnovaTek, Inc.	
<a href="#">Novel Catalytic Fuel Reforming</a> .....	E-57
Intelligent Optical Systems, Inc.	
<a href="#">Hydrogen Gas Sensing System</a> .....	E-50
Lincoln Composites, Inc.	
<a href="#">High-Pressure Hydrogen Storage Tank for Gaseous Truck Delivery</a> .....	E-48

Media and Process Technology, Inc. <a href="#">Hydrogen Production via a Commercially Ready Inorganic Membrane Reactor</a> .....	E-52
Mohawk Innovative Technology, Inc. <a href="#">Oil Free Hydrogen Compressor</a> .....	E-59
National Renewable Energy Laboratory <a href="#">Renewable Electrolysis Integrated System Development and Testing</a> .....	E-61
Pall Corporation <a href="#">High Performance Palladium-Based Membrane</a> .....	E-47
Praxair, Inc. <a href="#">Integrated Ceramic Membrane System for Hydrogen Production</a> .....	E-53
Prometheus Energy Group Inc. <a href="#">Active Magnetic Regenerative Liquefier</a> .....	E-44
Synkera Technologies, Inc. <a href="#">Nanotube Array Photocatalysts</a> .....	E-56
University of California at Berkeley <a href="#">Maximizing Light Utilization Efficiency and Hydrogen Production in Microalgal Cultures</a> .....	E-55
University of Hawaii <a href="#">Photoelectrochemical Hydrogen Production</a> .....	E-60
Virent Energy Systems, Inc. <a href="#">Hydrogen Generation from Biomass-Derived Carbohydrates via Aqueous-Phase Reforming</a> .....	E-51

## **Emerging Storage Technologies**

Lawrence Livermore National Laboratory <a href="#">Hydrogen Storage in Cryo-Compressed Vessels</a> .....	E-65
Powdermet, Inc. <a href="#">High-Strength, Low-Cost Microballoons for Hydrogen Storage</a> .....	E-64
Profile Composites Inc. <a href="#">Rapid Manufacturing of Vehicle-Scale, Carbon-Composite, High-Pressure Hydrogen Storage Cylinders</a> .....	E-67
Quantum Fuel System Technology Worldwide, Inc. <a href="#">Manufacturing Technologies for Low-Cost Hydrogen Storage Vessels</a> .....	E-66
Safe Hydrogen, LLC <a href="#">Safe and Effective Storage and Transmission of Hydrogen</a> .....	E-68
SiGNa Chemistry, Inc. <a href="#">Sodium Silicide (NaSi) Hydrogen Generation System</a> .....	E-69







Prepared by Pacific Northwest National Laboratory  
for the U.S. Department of Energy Building Technologies Program

PNNL-20709 | September 2011

U.S. DEPARTMENT OF  
**ENERGY** | Energy Efficiency &  
Renewable Energy

**EERE Information Center**  
1-877-EERE-INF (1-877-337-3463)  
[www.eere.energy.gov/informationcenter](http://www.eere.energy.gov/informationcenter)