



U.S. Department of Energy

Office of Electricity Delivery and Energy Reliability

Smart Grid R&D Peer Review

Nov. 2- 4, 2010

Smart Grid Interconnection and Interoperability Standards Development

PI: Tom Basso - NREL

Smart Grid Interconnection & Interoperability Standards Development

Objective

To facilitate the evolution from the existing electric power system (EPS) into a smart grid by standards and best practices that support the advancement of smart grid technologies and implementation via standardized interconnection, integration, and interoperability requirements, conformance test procedures, operating practices, and consumer education.

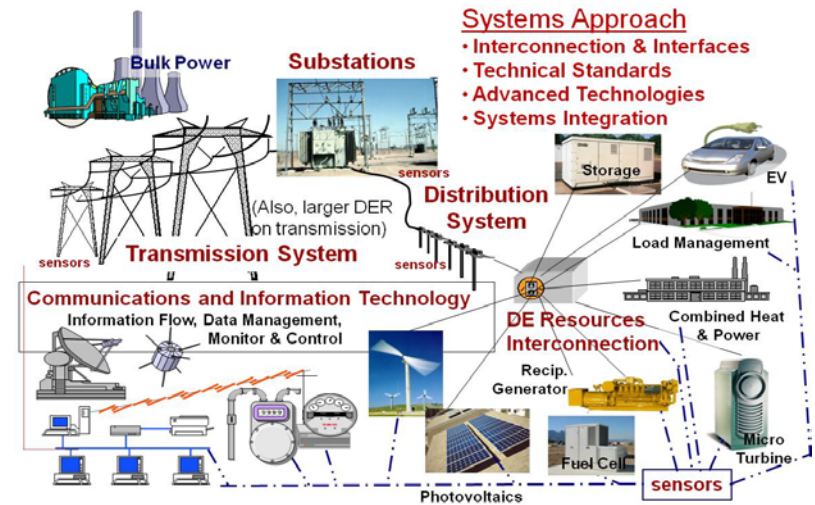

Funding Summary (\$K)

FY 2010	FY 2011
1,000	1,000

Technical Scope

Develop, maintain, & harmonize national and international standards and best practices for electric power system interfaces and interoperability requirements among the electric transmission and distribution systems, system markets, EPS operators, distributed energy resources (DER), customers, end-use applications and loads, including electric vehicles, energy storage and operations.

Contents

- **Needs and Challenges**
- **Technical Approach**
- **FY10 Progress and Milestones**
- **Out-year Planned Progress & Milestones**
- **Impacts and Benefits**
- **Interactions and Collaborations**
- **Contact Information**
- **Backup Slides**

Needs and Challenges

- Lack of common understanding and knowledge base for smart grid (SG) interconnection and interoperability terms and integration among power, information and communications technologies, stakeholders, and roles
- Incomplete set of standards, guidelines and best practices;
- Lack of standards coordination and harmonization;
- Untested or non-validated technology;
- Technology non-uniformity, non-interoperability, quality, and acceptance practices;
- Improved DER integration and proven, agreed upon advanced operating strategies;
- Lack of standardized interfaces – hardware , operational, and informational.
- Lack of uniform, agreed upon implementation protocols

Smart Grid Concepts: Interoperability and Interconnection -- System of Systems Approach

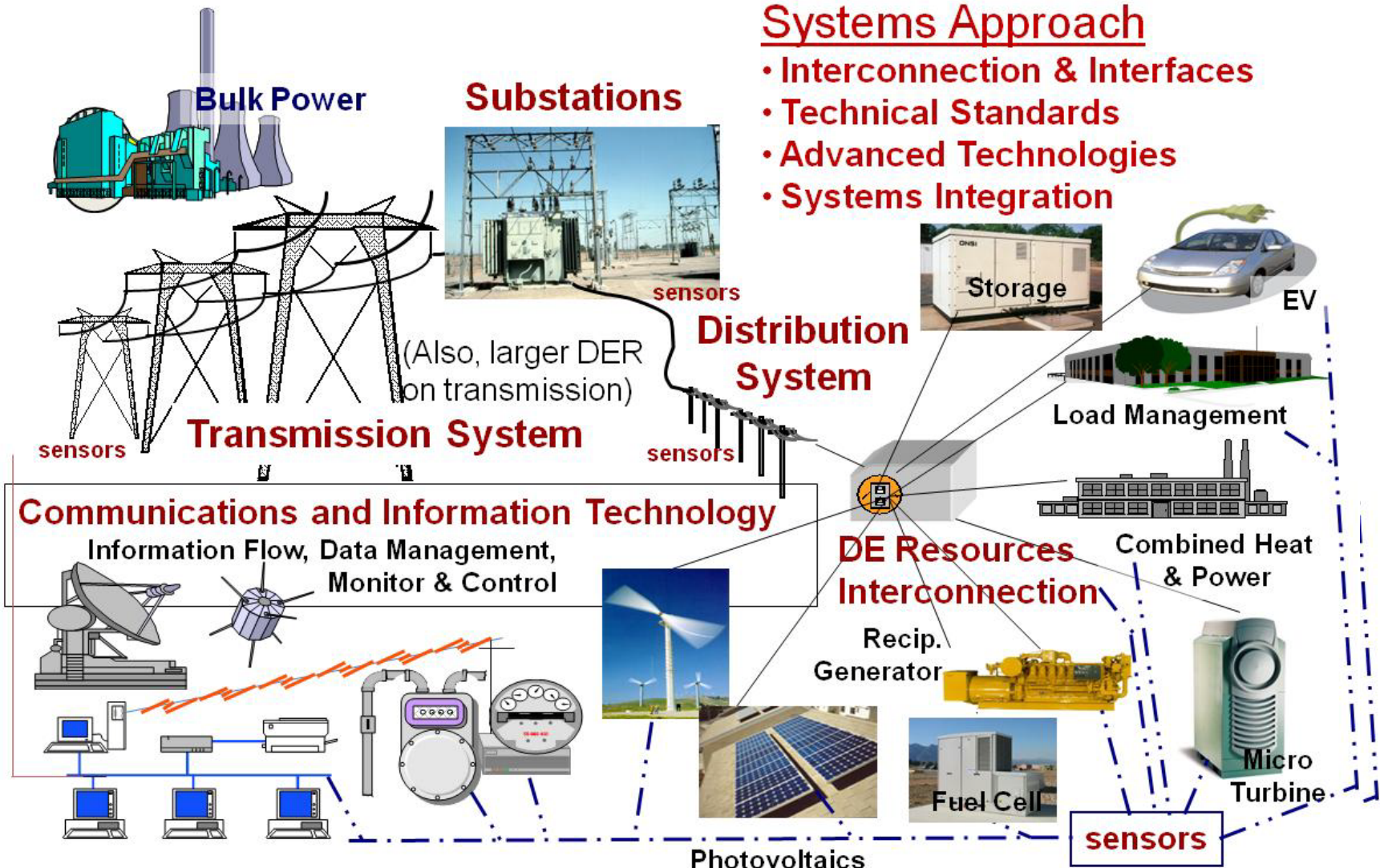

Systems Approach

- Interconnection & Interfaces
- Technical Standards
- Advanced Technologies
- Systems Integration

Technical Approach

- Interoperability standards for smart grid components and the overall system
- Interconnection and integration standards for distributed energy resources (DER), including generation, storage and electric vehicles
- Smart grid architecture & interoperability cyber security related requirements
- Exploratory and conformance test procedures related to smart grid interconnections, interoperability and cyber security requirements
- Smart grid interfaces with the transmission system and local loads, including architectures and interoperability pertinent to demand response
- Distribution system protection, operations, and automation practices
- Improved reliability & ancillary service definitions based on system analysis
- Market systems clarification and uniformity among regions and states
- Identification of gaps and conflicts within existing standards and best practices, e.g., local, national, regional, international standards and codes.

Technical Approach

National Consensus Standards – e.g., IEEE/ANSI; **IEEE 1547 standards** cited in 2005 EPACT Section 1254 *Interconnection*; standards development: industry-driven partnerships, balanced stakeholder participation, open and impartial leadership (e.g., R. DeBlasio [NREL] member IEEE Standards Board of Governors, and IEEE Standards liaison to DOE);

IEEE SCC21 *Fuel Cells, Photovoltaics, Dispersed Generation and Energy Storage* – sponsors and develops **1547 interconnection and P2030 interoperability** series of standards; NREL provides SCC21 leadership (R. DeBlasio SCC21 Chair and T. Basso Vice Chair).

Harmonization of national and international standards -- IEEE SCC21 and IEC/TC8: International Electro-technical Commission/TC8 *System Aspects of Electrical Energy Supply* -- NREL manages IEC US/Technical Advisory Group/TC8; US/TAG/TC8 Co-Technical Advisors: T. Basso and J. Koepfinger (IEEE Standards Board Emeritus member)

NIST *Smart Grid Standards Roadmap & Interoperability Framework* 2007 EISA section 1305; NIST SP-1108; Priority Action Plans (PAPs), e.g., T. Basso PAP7 energy storage interconnection.

IEEE P2030 Series: Smart Grid Interoperability

- IEEE P2030 Draft ***Guide for Smart Grid Interoperability of Energy Technology and Information Technology Operation with the Electric Power System and End-Use Applications and Loads***
- IEEE P2030.1 Draft ***Guide for Electric-Sourced Transportation Infrastructure***
- IEEE P2030.2 – Draft ***Guide for Energy Storage Systems Interoperability with Electric Power Infrastructure***



IEEE 1547 Interconnection Standards

1547- 2008 Standard for Interconnecting Distributed Resources with Electric Power Systems

1547.1 - 2005 Conformance Test Procedures for Equipment Interconnecting DR with EPS

1547.2 - 2008 Application Guide for IEEE 1547 Standard for Interconnection of DR with EPS

1547.3 - 2007 Guide for Monitoring, Information Exchange and Control of DR

P1547.4 Guide for Design, Operation, & Integration of Distributed Resource Island Systems with EPS

P1547.5 Guidelines for Interconnection of EPS >10 MVA to the Power Transmission Grid

P1547.6 Recommended Practice for Interconnecting DR With EPS Distribution Secondary Networks

P1547.7 Draft Guide to Conducting Distribution Impact Studies for DR Interconnection

Microgrids

Current 1547 Projects

P1547.8 (new)
Extend use of 1547
e.g. grid support, energy storage, ride-thru, etc.

- Energy Policy Act (2005) Cites and Requires Consideration of IEEE 1547 Standards and Best Practices for Interconnection.
- Energy Independence and Security Act (2007) Established NIST as Lead to Coordinate Framework and Roadmap for Smart Grid Interoperability Standards and Protocols.



Substation

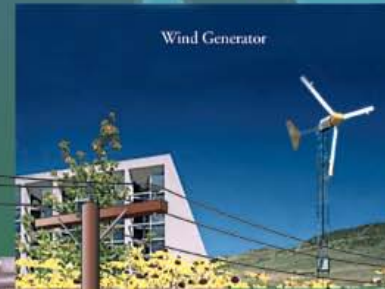

Wind Generator



Generator



Fuel Cells



Photovoltaics



Storage



Microturbines

Federal 2009 ARRA: standards use cited for Smart Grid, and, High Penetration DER projects.

IEEE 1547 & P2030 Standards Development Considerations Related to NIST Roadmap

- Energy Storage Systems, e.g., extend IEEE standards for storage system specific requirements and applications
- Distribution Grid Management Initiatives, e.g., extensions of 1547 and/or P2030, including two-way communications
- Voltage Regulation, Grid Support, etc., e.g., develop specifications in P1547.x and/or P2030-series.
- Management of DER in Planned Islands, P1547.4
- Static and Mobile Electric Storage, including small and large storage facilities (P1547.x and/or P2030 series).
- Plug-in Electric Vehicles (P1547.x and/or P2030 series).



FY10 Progress & Milestones

- IEEE P1547.4 Guide for micro-grids (island systems; Ben Kroposki Chair, T. Basso Secretary; 130 participants) – balloted May 2010 (220 balloters)
- IEEE P1547.6 Recommended Practice for DR on distribution secondary networks (J. Koepfinger, Chair; J. Bzura [US National Grid] Vice Chair, T. Basso Secretary; 185 participants) - ballot June 2010 (250 balloters)
- IEEE Std 1547.1 Standard Conformance Test Procedures for Interconnection Equipment – reaffirmation ballot started July 2010 (T. Basso)
- IEEE P2030 Guide for smart grid interoperability (R. DeBlasio Chair, T. Basso Secretary, 500 participants) – established drafts 1, 2, and 3 (Aug 2010)
- IEEE P1547.7 Guide for DR impact studies (R. Saint [NRECA] Chair; T. Basso Sect'y; 125 participants) – established drafts 1, 2, and 3 (Sept. 2010)
- IEEE P1547.8 Recommended Practice for extended use of IEEE 1547 standard; project started and inaugural meeting Aug 2010 (T. Basso and D. Bassett [PPL] Co-Chairs; 95 participants)
- Managed: 3 IEEE SCC21/1547 meetings; 4 P2030 meetings; 5 P2030 writing group meetings (R. DeBlasio Chair, T. Basso Vice Chair)
- Managed USA Technical Advisory Group & Technical Advisor for the International Electro-technical Commission Technical Committee 8 *Electric Energy Systems* (T. Basso and J. Koepfinger); representing IEEE1547 as new IEC Publically Available Specification (ongoing).

FY10 Progress & Milestones

- Established liaison with IEEE SCC21 and SAE standards EV working groups;
- Participated as member of the NERC Smart Grid Task Force (R. DeBlasio);
- Participated as member in NIST SGIP standards development organizations group
- Participated in NIST PAP7 *Energy Storage* meetings (monthly, T. Basso)
- Coordinated DOE EERE Solar (PV) codes and standards work, e.g., Solar ABCs (Solar America Board for Codes and Standards) Steering Comm. (T. Basso)
- Participated as member of IEEE Standards Board of Governors (R. DeBlasio);
- Participated as IEEE Standards Board liaison to DOE (R. DeBlasio);
- Participated as IEEE SCC21 and P2030 Chair (R. DeBlasio);
- Participated as IEEE SCC21 Vice Chair, P1547.8 Co-chair, and Secretary for P2030, P1547.4, P1547.6, P1547.7 (T. Basso)
- Coordinated with NERC, PJM, MADRI, NEMA, EPRI, additional IEC groups (e.g., TC8, TC57-communications, and TC82-solar) (R. DeBlasio and T. Basso)
- Awarded SGIP Certificate of Appreciation for PAP7 acceleration of P1547.4 & P1547.6 balloting, and initiation of P1547.8 (T. Basso)
- Awarded 2010 IEEE Charles Proteus Steinmetz Award for Exceptional Contributions to Standardization and Global Impact of Distributed Electric Power Systems Interconnection Technology -- (R. DeBlasio).
- Received 2 letters of acknowledgment and support from NIST (G. Arnold, National Coordinator for Smart Grid Interoperability) and IEEE (James Prendergast, Executive Director and Chief Operating Officer) for significant dedication and accomplishments reflected in IEEE Stds 1547 and P2030 series.

Out-year Planned Progress & Milestones

- Initiate IEEE P2030.2 Smart Grid Interoperability with Energy Storage Systems (Fall 2010 initiation)
- Represent IEEE Std 1547 as PAS and help establish in-country approaches to PAS use (Winter 2010 initiation)
- Publish: IEEE Std 1547.4 (micro-grids), IEEE Std 1547.6 (DER on distribution secondary networks), and, reaffirm IEEE Std 1547.1 Test Procedures for Interconnection Equipment (fall 2010 - winter 2011)
- Establish IEEE Std 2030 *Guide for Smart Grid Interoperability of Electric Power Systems with End-Use Applications and Loads* ballot-ready document (Mar 2011) and publish (CY 2011)
- Establish IEEE P1547.7 DER System Impact Studies (how to document) ballot-ready document (summer 2011) and publish (CY2012)
- Establish IEEE P2030.1 *Electric-sourced vehicles Infrastructure* ballot-ready document (Aug 2012)
- Establish IEEE P1547.8 (extended use of 1547) ballot-ready document (CY 2012)
- Establish IEEE P2030.2 *Energy Storage Systems Interoperability with Electric Power Infrastructure* ballot-ready document (2013)

Benefits of Interconnection and Interoperability Standards and Conformity Assessment

- Safeguards against hazards
- Fosters quality design and manufacture
- Increases competitiveness in industry
- Creates and expands markets
- Facilitates Trade and Commerce
- Assurance is provided when products meet quality standards, then users need not be concerned with redundant testing or evaluation of the product

- Accelerates engineering advances & implementation, interoperability, and installation
- Assists increased quality and reliability achievement
- Simplifies compliance to needs, permitting, & rules
- Promotes advanced communications; software platforms interchangeability
- Enables enhanced DE systems and grid intelligence
- Lower cost and quicker deployment for projects.

Impacts and Benefits (Interoperability & Interconnection stds)

- Standards enable national integrated electric-communication-information technology infrastructure to dynamically optimize grid operations and resources, incorporate demand response, and consumer participation. **Example areas for SG enhanced or new standards follow (OE smart grid target/goal headings).**
- **Distributed and renewable energy integration for increased reliability, efficiency, and system security: *standards for ...*** voltage regulation, protection coordination schemes, DER high penetration levels, variability of renewable generation, protection solutions at the utility and customer side integrated with load management, and advanced distribution architectures for buildings or communities.
- **Grid reliability & resilience: *standards for...*** micro-grids, study methods and modeling tools, distribution/feeder automation, advanced distribution operations to reduce outage durations and frequency, provide fast response to outage events, and provide differentiated reliability services.
- **Operational and system efficiency: *standards for ...*** dynamic sensing, monitoring, and control reduce energy losses, enhance utilization of available assets, and improve the overall load factor, e.g., smart-chargers charge PHEVs at off-peak periods, and diagnostic tools for condition-based maintenance reduce O&M costs.
- **Peak demand reduction for system and energy efficiency: *standards for ...*** AMI, grid-responsive devices (e.g., DER) & appliances; cyber security requirements.

Example – Standards Implementation Enabling DER Interconnection

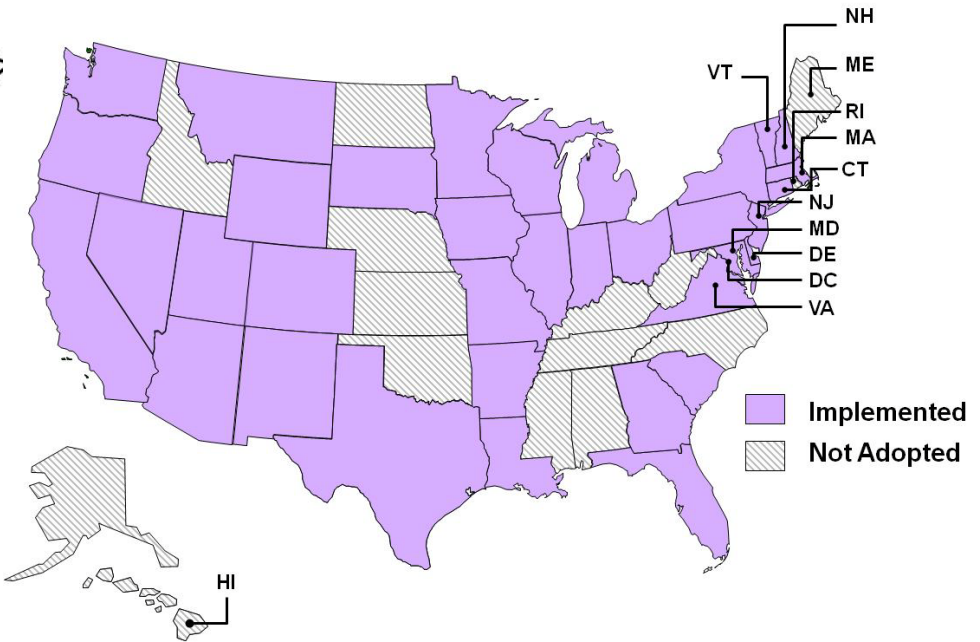
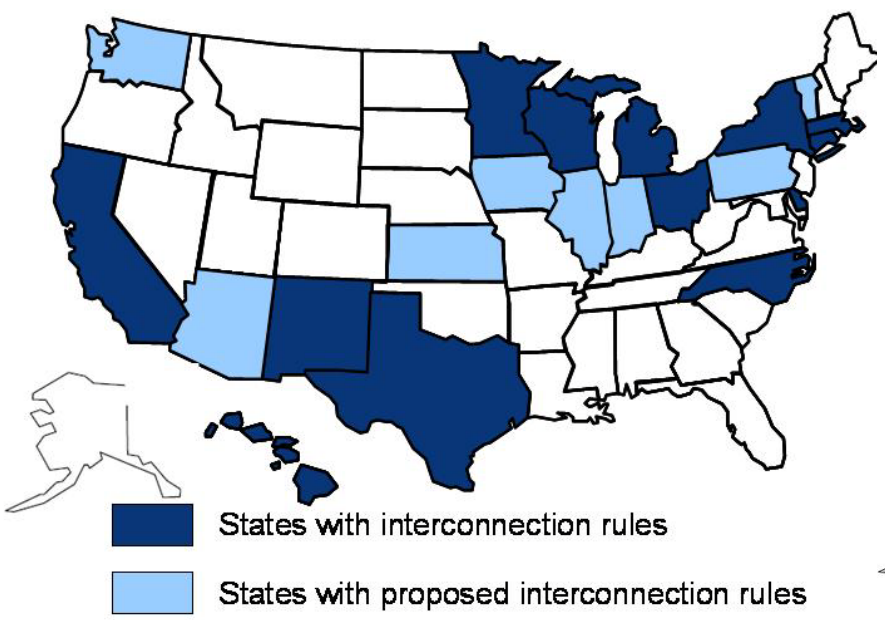

Prior to 2005 EPACK Sec 1254 Interconnection
(... states shall consider IEEE 1547 standards ...)

At the end of 2008...
states that implemented 1547 interconnection standards

IEEE 1547 Interconnection Standards Use:

Federal, Regional, State and Local Authorities/Jurisdictions

IEEE 1547 **Interconnection System and Test Requirements**

- Voltage Regulation
- Grounding
- Disconnects
- Monitoring
- Islanding
- etc.

IEEE 1547.1 **Interconnection System Testing**

- O/U Voltage and Frequency
- Synchronization
- EMI
- Surge Withstand
- DC injection
- Harmonics
- Islanding
- Reconnection

UL 1741* **Interconnection Equipment**

- 1547.1 Tests
- Construction
- Protection against risks of injury to persons
- Rating, Marking
- Specific DR Tests for various technologies

NEC

Article 690 PV Systems;

Article 705: interconnection systems (shall be suitable per intended use per UL1741)

PJM Interconnection, Inc. ***Small Generator Interconnection Standards*** **FERC approved**

*(0-to<10MW and 10-to-20 MW;
incorporate 1547 and 1547.1)*

* UL 1741 supplements and is to be used in conjunction with 1547 and 1547.1

Interactions & Collaborations

- NRECA , e.g., R. Saint P1547.7 Chair
 - PPL, e.g., D. Bassett P1547.8 Co-chair
 - PJM , e.g., member on their SG work group
 - MADRI, e.g., member on their SG subgroup
 - EEI - SCC21 WG members
 - NERC, e.g., member on their SG Task Force; and they liaison with IEEE SCC21
 - NIST SGIP and NIST PAP7 member
 - DOE EERE Solar codes & standards coordination
 - SNL, e.g., SCC21 WG members
 - ORNL, e.g., SCC21 WG members
 - INTEL - P2030 Task Force Chair; hosted P2030 meeting
 - IBM – P2030 Task Force Chair; hosted P2030 meeting
 - DTE/Detroit Edison Co., co-hosted P2030 meeting; members on SCC21 WGs;
 - Kohler, e.g., Mark Siira P2030.2 Chair
 - SAE, e.g., co-hosted P2030 meeting; liaison with SCC21 WGs; and members on SCC21 WGs;
 - NEMA , e.g., member on their Energy Storage Council
 - IEC, e.g., TC8 (manage US members; Technical Advisor for US/TC8 group; coordinate with TC57, TC82 member.
 - UL, e.g., SCC21 Committee
 - TUV/ASU (test lab) SC21 WG member
 - CSA (test lab) SCC WG member
 - Satcon (inverter mfgr) WG member
 - A123 Batteries - WG member
 - Altair Nano (batteries) – WG Member
- Hundreds more stakeholders in IEEE SCC21 standards working groups as consensus volunteers, e.g., GE, Westinghouse, Siemens, Eaton, KEMA, Cooper Power, ...**

Contact Information

Dick DeBlasio* - NREL Chief Engineer (Renewable Electricity and End Use Systems Directorate)

IEEE Standards Board of Governors; IEEE Standards Board Liaison to DOE;
Chair IEEE SCC21, 1547, and P2030;
em: Dick.Deblasio@nrel.gov voice: (303) 275 – 4333

OE SG Stds PI: Tom Basso*

IEEE SCC21 Vice Chair, & Sect'y
P2030 & P2030.2, and P1547.2.3.4.6, .7;
P1547.8 Co-Chair; Solar ABCs Steering
Committee Member.
thomas.basso@nrel.gov (303) 275 - 3753

Ben Kroposki* NREL

Chair P1547.4 & Sec'ty 1547.1
benjamin.kroposki@nrel.gov
(303) 275 – 2979

* NREL <http://www.nrel.gov>

1617 Cole Blvd. MS5202 Golden, CO 80401-3393

IEEE SCC21 -- IEEE Standards Coordinating Committee 21 on ***Fuel Cells, Photovoltaics, Dispersed Generation, & Energy Storage***

<http://grouper.ieee.org/groups/scc21/>

- **IEEE 1547** Series of Interconnection Standards and
- **IEEE P2030** series of smart grid interoperability standards

Back-up Slides

Example Smart Grid Testing (at NREL)

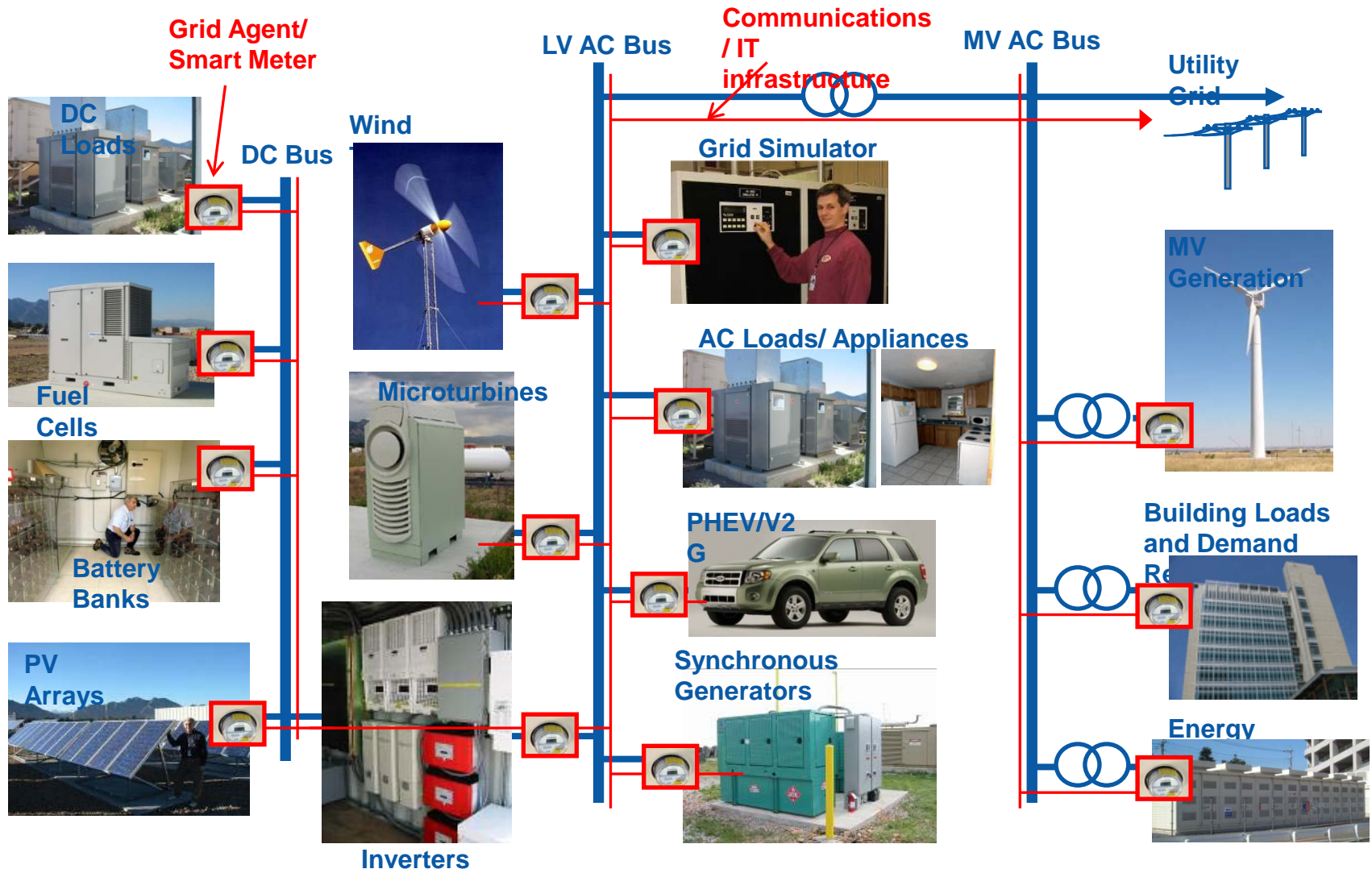

Smart Grid Interoperability Conformance Testing (enhanced FY10 – FY11 proposal)

- Accelerate development and adoption of Smart Grid technologies
- Develop consensus-based standard test protocol.
- Develop interoperability test beds.
- Achieve interoperability between interfaces and devices.

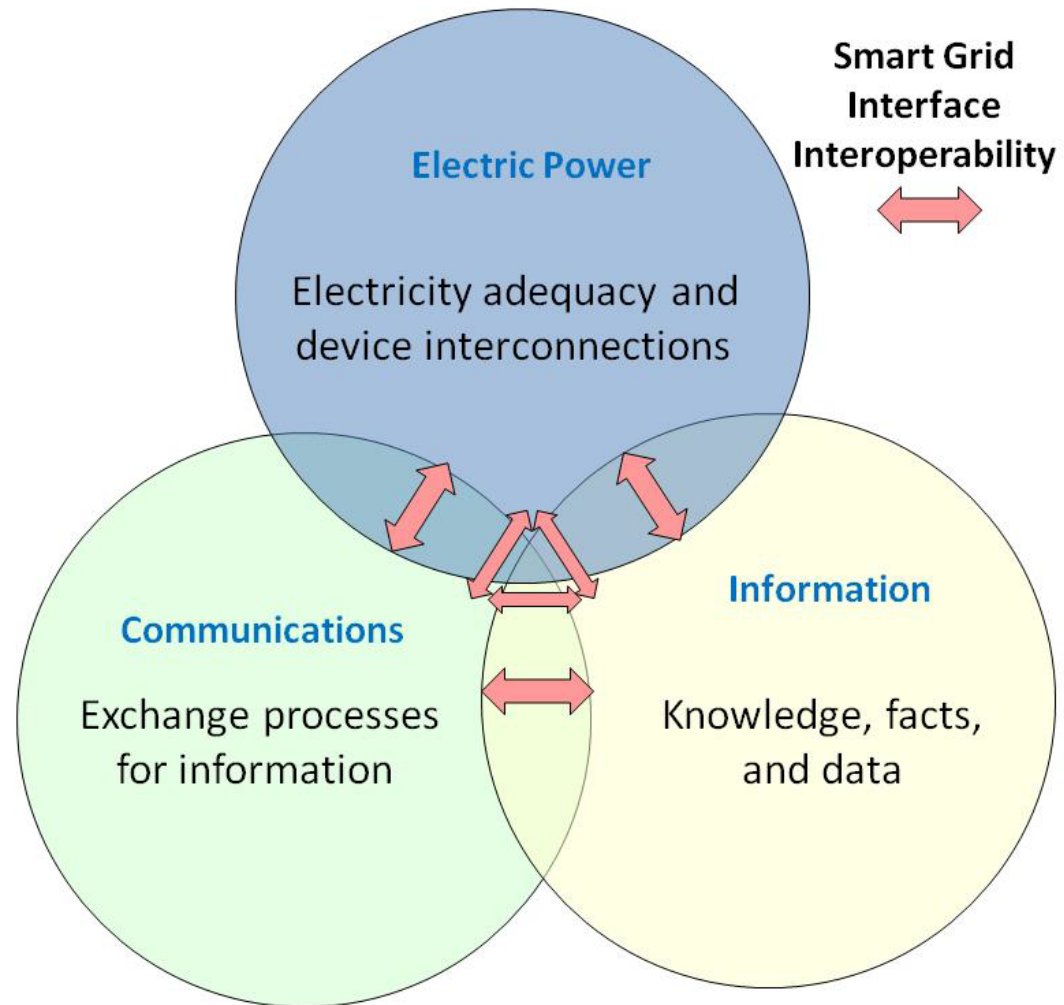

Putting the Pieces Together: Standards, Testing, and Conformance (NREL STAC)

Conformance programs:
*established by stakeholders;
satisfy mandates; quality;
recognized/accepted; not
stagnant.*



Controlled/quality: processes, facilities, equipment personnel. Lab accreditation.
Manufacturer quality. Test @ cradle-to-grave.

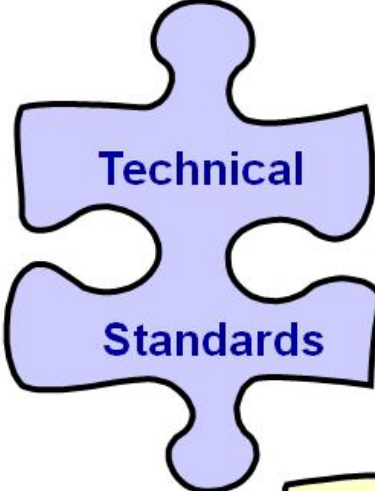

**Consensus driven.
Defined scope & purpose.
Proven/validated.
Maintained/updated.**

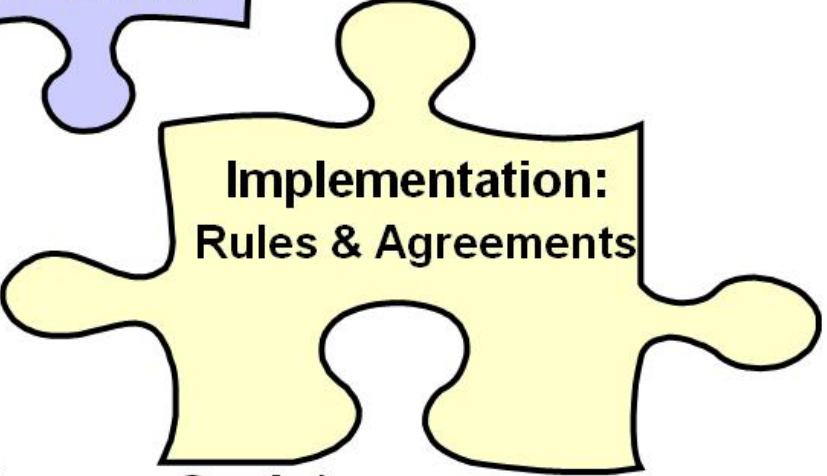

**Goals/purposes.
Which standards & programs?
Authority having jurisdiction.
Dispute resolution.**

PJM* Interconnect, LLC

Small Generator Interconnection Standards

Summary Overview (Gen \leq 10 MW, and, 10-20MW)

1547 Std technical requirements

1547 based test requirements

- Design Test (may be pre-certified)
- Production Test
- Installation Evaluation
- Commissioning Test
- Periodic Testing (per PJM tariff requirements)

PJM SCADA option available

Other Requirements

- e.g. PJM EPS owner voltage regulation
- e.g., PJM EPS metering
- e.g. other National / local codes

Purpose for adopting PJM-wide technical standards based on 1547:

- Limit barriers to interconnection
- Provide transparency
- Allow for pre-certification and other means to expedite interconnection process

* PJM is a regional transmission organization with over 140 GW load; 165 GW generating capacity

NREL Model 1547 Pre-certification and Certification Program for DG Interconnection Systems

DRAFT Design for Utility, State, etc. Certification Interconnection Program

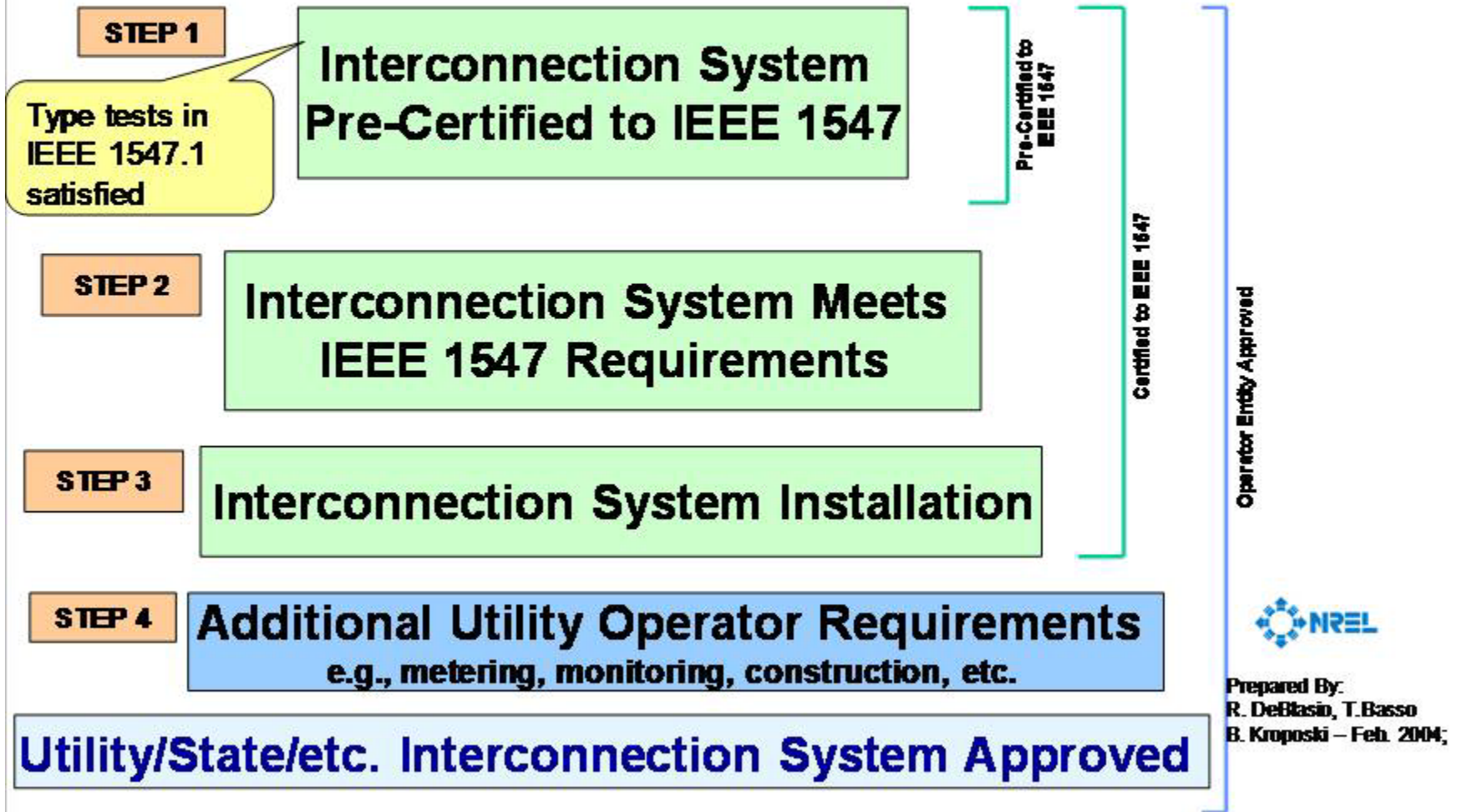

P2030 Draft *Guide for Smart Grid Interoperability of Energy Technology and Information Technology Operation with the Electric Power System and End-Use Applications and Loads*

- Provides guidelines in understanding and defining smart grid interoperability of the EPS with end-use applications and loads
- Focuses on integration of energy technology and information and communications technology
- Achieves seamless operation for electric generation, delivery, and end-use benefits to permit two way power flow with communication and control
- Addresses interconnection and intra-facing frameworks and strategies with design definitions
- Expands knowledge in grid architectural designs and operation to promote a more reliable and flexible electric power system.



IEEE P2030.1 – *Draft Guide for Electric Sourced Transportation Infrastructure*

- Addresses applications for electric-sourced vehicles and related support infrastructure used in road-based personal and mass transit
- Provides a knowledge base addressing terminology, methods, equipment, and planning requirements for such transportation and its impacts on commercial and industrial systems



IEEE P2030.2 – *Draft Guide for the Interoperability of Energy Storage Systems Integrated with the Electric Power Infrastructure*

Scope: This document provides guidelines for discrete and hybrid energy storage systems that are integrated with the electric power infrastructure, including end-use applications and loads. This guide builds upon IEEE Standard P2030 Draft Guide for Smart Grid Interoperability of Energy Technology and Information Technology Operation With The Electric Power System (EPS), and End-Use Applications and Loads. **Purpose:** The purpose is to provide guidance in understanding and defining technical characteristics of energy storage systems, and how discrete or hybrid systems may be integrated with and used compatibly as part of the electric power infrastructure. Further, the standard fills the need for guidance relevant to a knowledge base addressing terminology, functional performance, evaluation criteria, operations, testing, and the application of engineering principles for energy storage systems integrated with the electric power infrastructure.



DER Interconnection

Distributed Energy Resources



Fuel Cell



PV



Microturbine



Wind



Energy Storage



PHEV - V2G



Generator

Interconnection Technologies



Inverter



Switchgear, Relays, & Controls

Functions

- Power Conversion
- Power Conditioning
- Power Quality
- Protection
- DER and Load Control
- Ancillary Services
- Communications
- Metering

Electric Power Systems



Utility System



Microgrids

Loads

Local Loads

Load Management



IEEE 1547 Interconnection Standards

1547- 2008 Standard for Interconnecting Distributed Resources with Electric Power Systems

1547.1 - 2005 Conformance Test Procedures for Equipment Interconnecting DR with EPS

1547.2 - 2008 Application Guide for IEEE 1547 Standard for Interconnection of DR with EPS

1547.3 - 2007 Guide for Monitoring, Information Exchange and Control of DR

P1547.4 Guide for Design, Operation, & Integration of Distributed Resource Island Systems with EPS

P1547.5 Guidelines for Interconnection of EPS >10 MVA to the Power Transmission Grid

P1547.6 Recommended Practice for Interconnecting DR With EPS Distribution Secondary Networks

P1547.7 Draft Guide to Conducting Distribution Impact Studies for DR Interconnection

Microgrids

Current 1547 Projects

P1547.8 (new)
Extend use of 1547
e.g. grid support, energy storage, ride-thru, etc.

ANSI/IEEE Standard 1547

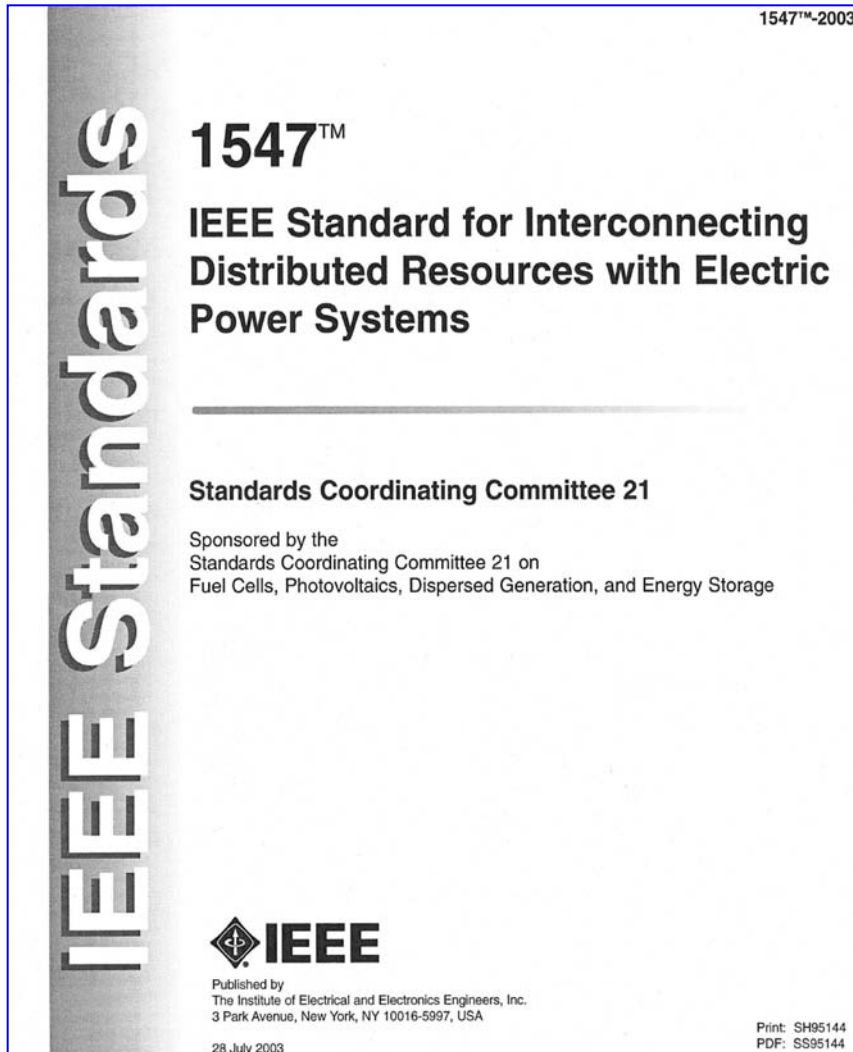

...

4.0 Interconnection Technical Specifications and Requirements:

- . General Requirements
- . Response to Area EPS Abnormal Conditions
- . Power Quality
- . Islanding

5.0 Test Specifications and Requirements:

- . Design Tests
- . Production Tests
- . Interconnection Installation Evaluation
- . Commissioning Tests
- . Periodic Interconnection Tests

IEEE Std 1547.1 (2005)

... **Standard for Conformance Test Procedures** ... specifies the type, production, and commissioning tests that shall be performed to demonstrate that interconnection functions and equipment of a distributed resource (DR) conform to IEEE Std 1547.

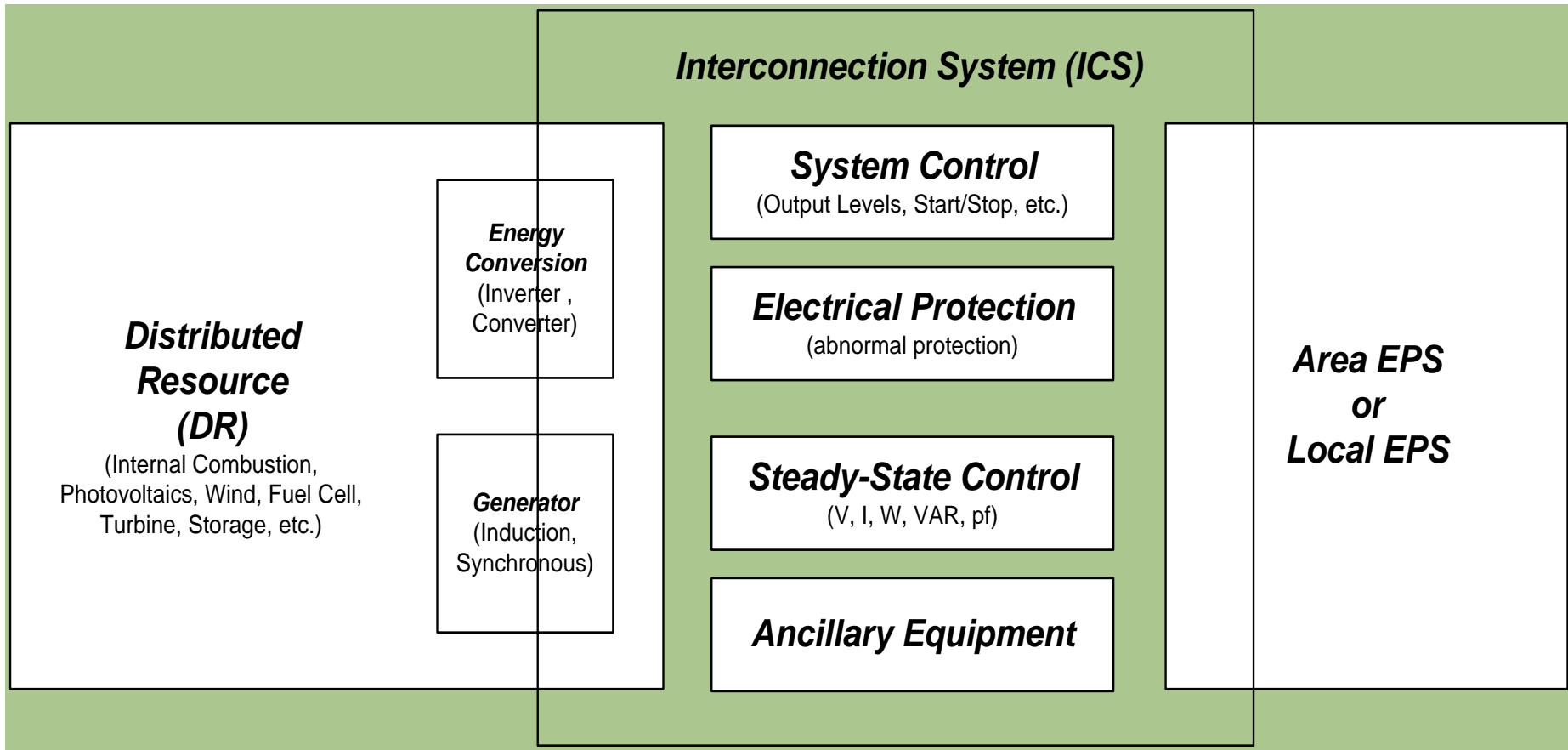

Figure 1. Boundaries between the interconnection system, the EPS and the DR.

IEEE Std 1547.3 MIC for DR

... guidelines for MIC (monitoring, information exchange, and control) for DR (distributed resources) interconnected with electric power systems (EPS).

...

4. General information about monitoring, information exchange and control (MIC)
 - 4.1 Interoperability
 - 4.2 Performance
 - 4.3 Open Systems Approach
 - 4.4 Extensibility
 - 4.5 Automatic Configuration Management
 - 4.6 Information Modeling
 - 4.7 Protocols
 5. Data exchange guidelines based on 4.1.6 of IEEE Std 1547
 6. Business and operation processes
 7. Information exchange model
 8. Protocol Issues
 9. Security guidelines for DR implementation
- Annexes (informative)

IEEE Std 1547.3 Guide for MIC for DR

... guidelines for monitoring, information exchange, and control (MIC) for distributed resources (DR) interconnected with electric power systems (EPS).

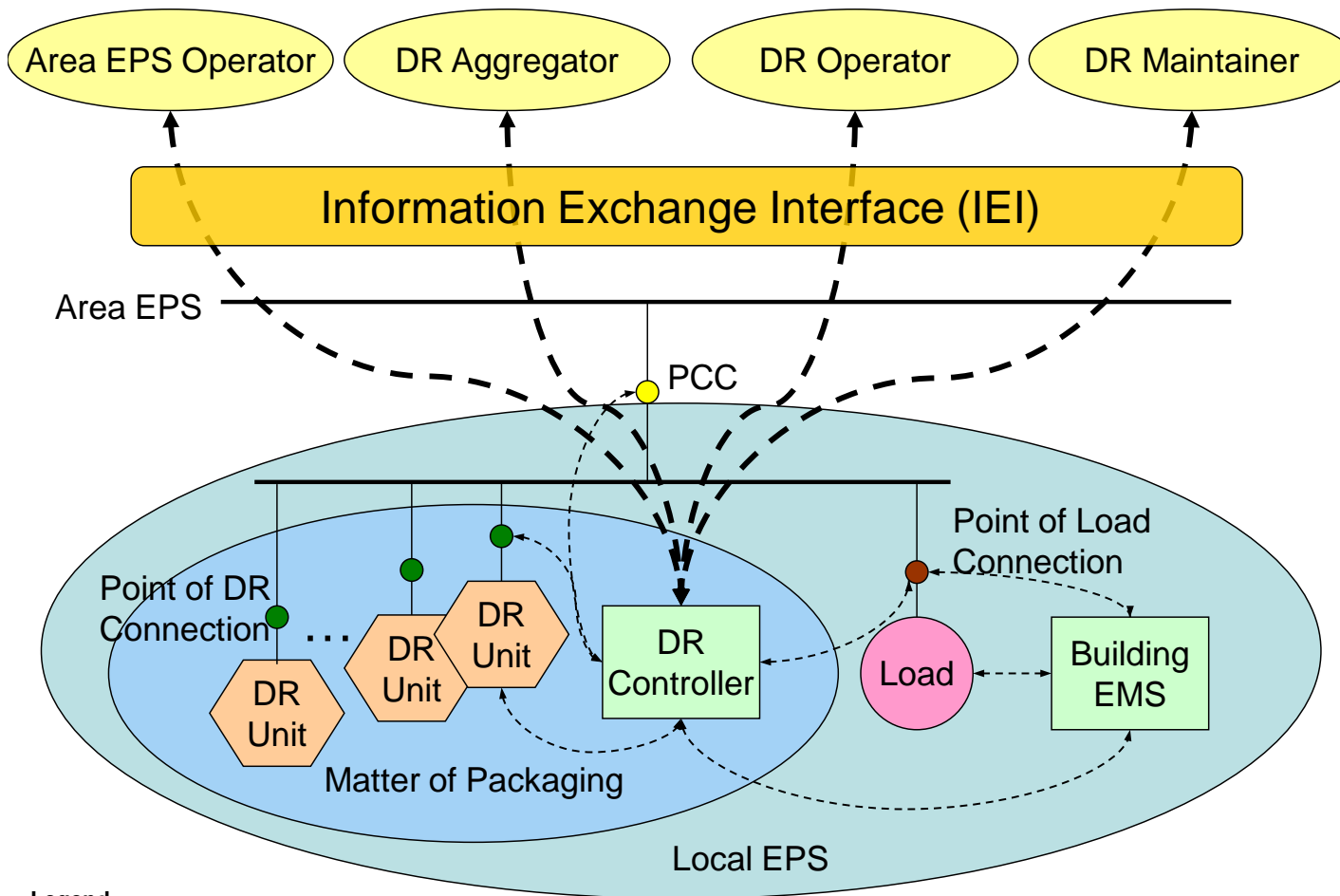

1547.3 Figure 1
Reference diagram for information exchange.

Legend

- Interconnection Info Path (focus of this guide) - - - - -
- Local Info Path (not addressed in this guide) ·········
- Electric Path (not addressed in this guide) _____

P1547.4 (Planned DER Islands) IEEE ballot affirmed May 2010

E.g., DER (generation and energy storage) technologies are integrated with all others including the grid technologies to form **Micro-grids (planned islands)**; includes – load management, voltage & VAR control, active participation, etc.)

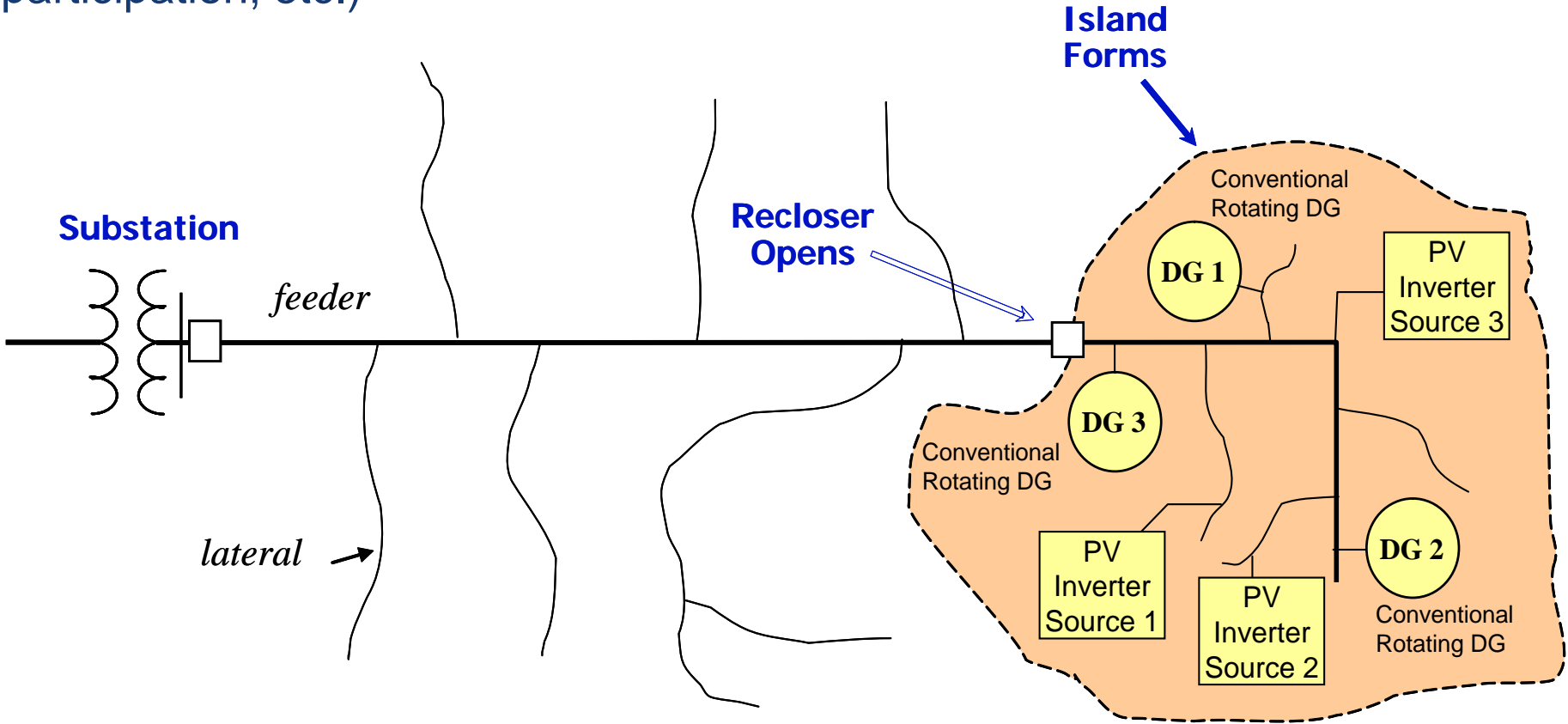

P1547.7 Guide to Conducting DER Impact Studies

- Describes criteria, scope, and extent for engineering studies of the impact of DR on distribution system.
- Methodology for performing engineering studies.
- Study scope and extent described as functions of identifiable characteristics of:
 - the distributed resource,
 - the area electric power system, and
 - the interconnection.
- Criteria described for determining the necessity of impact mitigation.
- Guide allows a described methodology for:
 - When impact studies are appropriate,
 - What data is required,
 - How studies are performed, and
 - How the study results are evaluated.

P1547.8 Recommended Practice

... to Extend Use of 1547

- Need for P1547.8 is to address industry driven recommendations and NIST smart grid standards framework recommendations (e.g., NIST priority action plans).
- Example considerations include: low voltage ride thru; volt-ampere reactive support; grid support; two-way communications and control; advanced/interactive grid-DR operations; high-penetration/multiple interconnections; interactive inverters; energy storage; electric vehicles; etc.