

Teachers' Edition



The Harnessed
ATOM

Foreword

The Harnessed Atom is a middle school science, technology, engineering, and math (STEM) curriculum extension that focuses on nuclear science and energy. It is designed to provide students with accurate, unbiased, and up-to-date information on the roles that energy and nuclear science play in our lives. The curriculum includes essential principles and fundamental concepts of energy science.

This update is based on the original 1985 *Harnessed Atom* curriculum from the U.S. Department of Energy. It has been developed with extensive input from science teachers across the country in pilot test reviews and workshops, as well as technical reviews from scientists and experts at universities, professional societies, and national laboratories.

This update includes new science education standards, updated statistics, new experiments, and interactive games. It also provides information on careers in energy research and production that will help students consider coursework needed to achieve their career goals. It has been redesigned to be flexible so it can be tailored to fit within the schedule of classrooms everywhere.

The Harnessed Atom includes the student edition, a teacher's guide with the complete content of the Student Edition, plus the lesson plans, standards, instructor notes, interactive games, classroom activities, laboratory experiments, and outside resource suggestions.

One responsibility of the U.S. Department of Energy is to keep the public informed about our Nation's different energy sources, research, policies, and options. *The Harnessed Atom* helps meet this goal by providing students with factual information they need to make informed decisions about our nation's energy options and future—and their role in it.

Acknowledgments

The U.S. Department of Energy Office of Nuclear Energy gratefully acknowledges the following educators and subject matter experts for their guidance and suggestions in developing, pilot testing, and reviewing this update of The Harnessed Atom Middle School Edition.

Teachers

Sezai Hakan Armagan, Burke High School, Omaha, NE
Nicole Buchman, Buffalo Middle School, Kenova, WV
Mariano Buttitta, Linwood Middle School, North Brunswick, NJ
Andrea Burns, Chestnut Year Round Middle School, Fayetteville, NC
Jamie L. Campbell, Pine City Jr/Sr High School, Pine City, MN
Kimberly Carroll, Central Middle School, Wartburg, TN
Janet Clarke-Green, Oak Crest Elementary School, Landover, MD
Jacqueline Collier, South Laurel Middle School, London, KY
Keith Cook, Severn River Middle School, Arnold, MD
Richard A. Craig, Prairie School, Racine, WA
Leonila Demiao, Charles Herbert Flowers High School, Springdale, MD
Eric Greenlee, Severn River Middle School, Arnold, MD
Eve Grichting, Mt. Bethel Christian School, Marietta, GA
Pamela Higgins, Holcomb Bridge Middle School, Alpharetta, GA
David Hundermark, Jefferson Middle School, Oak Ridge, TN
Tamara Ingalls, Bull Run Middle School, Gainesville, VA
Tamora Jackson, Bellevue Middle School, Memphis, TN
Sarah Kennelley, George Washington Middle School 1, Alexandria, VA
David Robert Klingensmith, Granite Oaks Middle School, Rocklin, CA
Brian Lowes, Kettering Middle School, Kettering, OH
Mildred Manulat, Mergenthaler Vocational-Technical High School, Baltimore, MD
Jeanette McNally, Miamisburg Middle School, Miamisburg, OH
Timothy R. Micheli, Compass Public Charter School, Meridian, ID

Maggie Marie Miklos, Conotton Valley Jr./Sr. High School, Bowerston, OH
Stacey Militello, Oak Middle School, Shrewsbury, MA
Douglas S. Morrison, Manistique Middle High School, Manistique, MI
Christie Orlosky, West Shamokin Jr/Sr High School, Rural Valley, PA
Aaron Pickering, Oak Ridge High School, Oak Ridge, TN
Kenya Reece, North Gulfport Middle School, Gulfport, MS
Melanie Retterer, Brookpark Middle School, Grove City, OH
Cheryl Robertson, Northwest Middle School, Knoxville, TN
Tammie Schader, Cheney Middle School, Cheney, WA
Dawn Sinters-Rizika, Lakota Middle School, Federal Way, WA
Eric Stansbery, Ooltewah Middle School, Ooltewah, TN
Tricia Swann, Maury Middle School, Dandridge, TN
Deitra Thomas, Hardin County Middle School, Savannah, TN
Erica Waggoner, East Literature Magnet School, Nashville, TN
Cheryl Williamson, Capshaw Middle School, Santa Fe, NM
Rachel Young, C. Vernon Spratley Middle School, Hampton, VA

Advisory Review Panel

Carol Berrigan, Nuclear Energy Institute
Dr. Michael Corradini, President, American Nuclear Society, University of Wisconsin-Madison
Candace Davison, Dept. of Nuclear Engineering, The Pennsylvania State University
Teri Ehresman, Nuclear Science & Technology, Idaho National Laboratory
Melinda Hamilton, Education Programs, Idaho National Laboratory
DaNel Hogan, Physics Teacher, DOE Einstein Fellow
Sharon Kerrick, American Nuclear Society
Lisa Marshall, NC State University Department of Nuclear Engineering
Dr. Kenneth Lee Peddicord, Nuclear Engineering Senior Associate Dean, Texas A&M University
Dr. Kathryn McCarthy, Deputy Associate Laboratory Director, Nuclear Science & Technology, Idaho National Laboratory
Chuck Vincent, American Nuclear Society

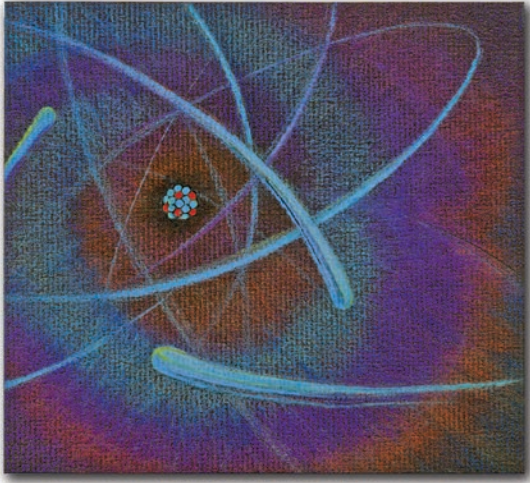

The Harnessed **Atom**

Table of Contents

Pretest

Lesson 1 - Energy Basics

Lesson 2 - Electricity Basics

Lesson 3 - Atoms and Isotopes

Lesson 4 - Ionizing Radiation

Lesson 5 - Fission, Chain Reactions

Lesson 6 - Atom to Electricity

Lesson 7 - Waste from Nuclear Power Plants

Lesson 8 - Concerns

Lesson 9 - Energy and You

Lesson 10 - Review

Posttest

Pretest

Student Version

The Harnessed Atom - Pretest

Directions:

Circle the letter of the answer that best completes each statement.

1. The two basic states of energy are _____ and _____.
 - a. potential and kinetic
 - b. potential and chemical
 - c. chemical and mechanical
 - d. electrical and radiant

2. Energy sources that cannot be replaced are called _____.
 - a. renewable
 - b. secondary
 - c. primary
 - d. non-renewable

3. The flow of electrons is _____.
 - a. radiation
 - b. electricity
 - c. magnetic force
 - d. nucleus

4. In the United States, most electricity is produced by using steam to turn the blades of a _____.
 - a. condenser
 - b. generator
 - c. turbine
 - d. flywheel

5. Atoms of an element with the same number of protons but different numbers of neutrons are _____.
 - a. isotopes
 - b. electrons
 - c. gamma rays
 - d. radioactive

6. The main difference between a nuclear power plant and other kinds of power plants is that at a nuclear power plant _____.
- steam is used to turn the turbine
 - electricity is made by the generator
 - the heat used to make steam is produced by splitting atoms
 - water is used for cooling
7. Alpha, beta, and gamma are types of _____.
- atoms
 - molecules
 - radiation
 - elements
8. Radioactive atoms throw off particles and/or rays in a process called _____.
- half-life
 - decay
 - fission
 - fusion
9. Distance, shielding, and time affect the amount of exposure to _____.
- electricity
 - molecules
 - elements
 - radiation
10. In 2014, more than half of the electricity made in the U.S. that did NOT release carbon dioxide (CO₂) was from _____.
- wind farms
 - solar farms
 - geothermal power plants
 - nuclear power plants
11. Splitting the atom to release energy is called _____.
- fusion
 - fission
 - generation
 - division

12. An atom is identified by the number of _____ in its nucleus.
- protons
 - electrons
 - protons and neutrons
 - neutrons
13. The element now used as fuel in most nuclear power plants is _____.
- cadmium
 - uranium
 - thorium
 - helium
14. Greenhouse gases that trap heat in the atmosphere are associated with _____.
- radioactive decay
 - half-life
 - climate change
 - nuclear chain reactions
15. About 20 percent of electricity used in the United States is generated by using _____.
- coal
 - nuclear fission
 - wind energy
 - solar cells
16. The _____ of an atom contains protons and neutrons.
- nucleus
 - isotope
 - electron
 - molecule
17. The kind of energy released by unstable isotopes is _____.
- electricity
 - static
 - motion
 - radiation

18. The reason that we isolate nuclear waste from the environment is that it _____.
- a. could release greenhouse gases
 - b. is expensive
 - c. is radioactive
 - d. is biodegradable
19. At a nuclear power plant, fission takes place in the _____.
- a. steam-generator
 - b. reactor
 - c. control rods
 - d. turbine
20. The coolant/moderator of a nuclear power plant slows down _____.
- a. neutrons
 - b. protons
 - c. electrons
 - d. nucleus
21. In the United States, most of the low-level radioactive wastes come from _____.
- a. hospitals and industry
 - b. nuclear power plants
 - c. fossil fuel power plants
 - d. NASA's space program
22. When the control rods are inserted into the core of a reactor, _____.
- a. more neutrons are available to cause fission
 - b. the nuclear chain reaction slows or stops
 - c. the nuclear chain reaction speeds up
 - d. the temperature in the core increases
23. After being used in the reactor, nuclear fuel is _____.
- a. not radioactive
 - b. slightly radioactive
 - c. highly flammable
 - d. highly radioactive

24. Our natural environment is the source of _____ of your exposure to radiation each year.

- a. none
- b. half
- c. all
- d. very little

25. Safety barriers at nuclear power plants include _____.

- a. a concrete and steel containment building
- b. the ceramic form of the fuel
- c. a massive steel pressure vessel
- d. all of the above

Pretest

Teacher Version
With Answers

The Harnessed Atom - Pretest Answers

Directions:

Circle the letter of the answer that best completes each statement.

1. The two basic states of energy are _____ and _____.
 - a. potential and kinetic
 - b. potential and chemical
 - c. chemical and mechanical
 - d. electrical and radiant

2. Energy sources that cannot be replaced are called _____.
 - a. renewable
 - b. secondary
 - c. primary
 - d. non-renewable

3. The flow of electrons is _____.
 - a. radiation
 - b. electricity
 - c. magnetic force
 - d. nucleus

4. In the United States, most electricity is produced by using steam to turn the blades of a _____.
 - a. condenser
 - b. generator
 - c. turbine
 - d. flywheel

5. Atoms of an element with the same number of protons but different numbers of neutrons are _____.
 - a. isotopes
 - b. electrons
 - c. gamma rays
 - d. radioactive

6. The main difference between a nuclear power plant and other kinds of power plants is that at a nuclear power plant _____.
- a. steam is used to turn the turbine
 - b. electricity is made by the generator
 - c. the heat used to make steam is produced by splitting atoms
 - d. water is used for cooling
7. Alpha, beta, and gamma are types of _____.
- a. atoms
 - b. molecules
 - c. radiation
 - d. elements
8. Radioactive atoms throw off particles and/or rays in a process called _____.
- a. half-life
 - b. decay
 - c. fission
 - d. fusion
9. Distance, shielding, and time affect the amount of exposure to _____.
- a. electricity
 - b. molecules
 - c. elements
 - d. radiation
10. In 2014, more than half of the electricity made in the U.S. that did NOT release carbon dioxide (CO₂) was from _____.
- a. wind farms
 - b. solar farms
 - c. geothermal power plants
 - d. nuclear power plants
11. Splitting the atom to release energy is called _____.
- a. fusion
 - b. fission
 - c. generation
 - d. division

12. An atom is identified by the number of _____ in its nucleus.
- a. protons
 - b. electrons
 - c. protons and neutrons
 - d. neutrons
13. The element now used as fuel in most nuclear power plants is _____.
- a. cadmium
 - b. uranium
 - c. thorium
 - d. helium
14. Greenhouse gases that trap heat in the atmosphere are associated with _____.
- a. radioactive decay
 - b. half-life
 - c. climate change
 - d. nuclear chain reactions
15. About 20 percent of electricity used in the United States is generated by using _____.
- a. coal
 - b. nuclear fission
 - c. wind energy
 - d. solar cells
16. The _____ of an atom contains protons and neutrons.
- a. nucleus
 - b. isotope
 - c. electron
 - d. molecule
17. The kind of energy released by unstable isotopes is _____.
- a. electricity
 - b. static
 - c. motion
 - d. radiation

18. The reason that we isolate nuclear waste from the environment is that it _____.
- a. could release greenhouse gases
 - b. is expensive
 - c. is radioactive
 - d. is biodegradable
19. At a nuclear power plant, fission takes place in the _____.
- a. steam-generator
 - b. reactor
 - c. control rods
 - d. turbine
20. The coolant/moderator of a nuclear power plant slows down _____.
- a. neutrons
 - b. protons
 - c. electrons
 - d. nucleus
21. In the United States, most of the low-level radioactive wastes come from _____.
- a. hospitals and industry
 - b. nuclear power plants
 - c. fossil fuel power plants
 - d. NASA's space program
22. When the control rods are inserted into the core of a reactor, _____.
- a. more neutrons are available to cause fission
 - b. the nuclear chain reaction slows or stops
 - c. the nuclear chain reaction speeds up
 - d. the temperature in the core increases
23. After being used in the reactor, nuclear fuel is _____.
- a. not radioactive
 - b. slightly radioactive
 - c. highly flammable
 - d. highly radioactive

24. Our natural environment is the source of _____ of your exposure to radiation each year.

- a. none
- b. half
- c. all
- d. very little

25. Safety barriers at nuclear power plants include _____.

- a. a concrete and steel containment building
- b. the ceramic form of the fuel
- c. a massive steel pressure vessel
- d. all of the above

ENERGY BASICS

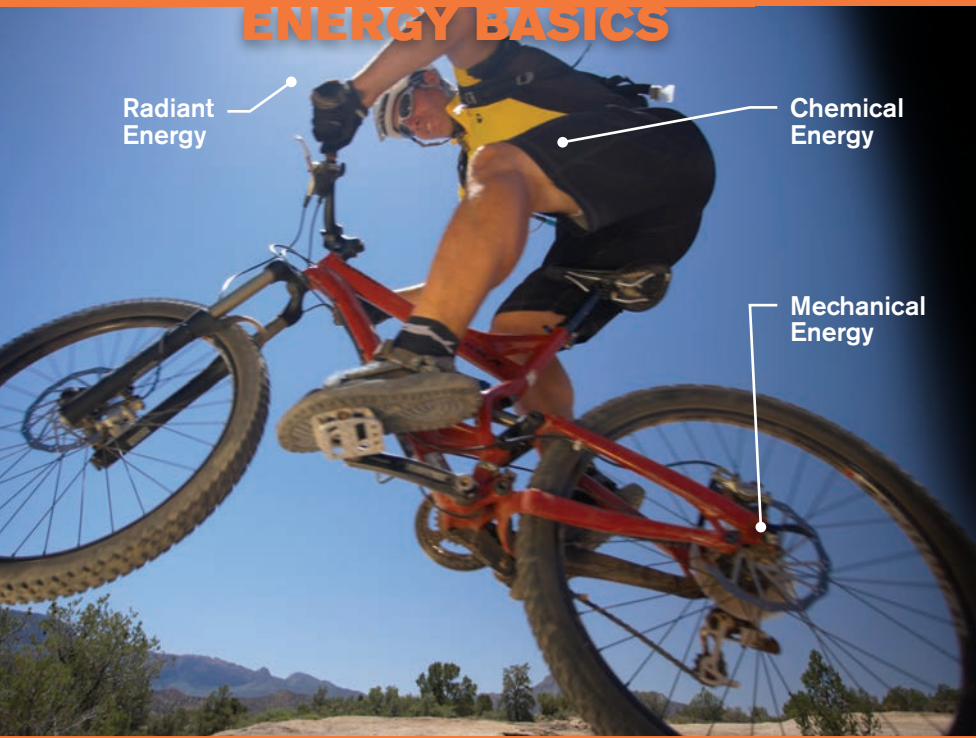

Introduction

This lesson will look at the states and forms of energy. Next we will look at where energy comes from. Finally, we'll explore how the way we live is tied to our energy supply and what that means for the future.

TOPICS:

States of energy

Potential
Kinetic

Forms of energy

Mechanical
Chemical
Nuclear
Electrical
Radiant
Energy from gravity
Thermal

Energy sources

Primary and secondary
sources
Renewable vs non-
renewable
Conversion
Conservation

Environmental effects

Greenhouse effect
Climate change

Future sources

What is energy?

Energy is the ability to do work. But what does that really mean?

You might think of work as cleaning your room, cutting the grass, or studying for a test. And all these require energy.

To a scientist, “work” means something more exact. **Work** is causing a change. It can be a change in position, like standing up or moving clothes from the floor to the laundry basket. It can be a change in temperature, like heating water for a cup of tea. Or it can be a change in form, like the water in tea changing from liquid to steam. All of these things are work and require energy.

We use energy all the time. Whenever work is done, energy is used. All activities involve energy.

We need energy to

- power our factories and businesses
- heat and light our homes and schools
- run our appliances and machines
- stay alive and keep our bodies moving
- build and fuel our cars, trucks, planes, and ships
- run television and videos
- power our phones, computers, music, and games
- make our clothes
- and do everything else that we do

What are the states of energy?

We can divide energy into two basic states: potential energy and kinetic energy. **Potential energy** is stored energy that is waiting to be used. **Kinetic energy** is energy of motion. A roller coaster at the top of the track has potential energy. When the roller coaster speeds down the track, the potential energy is changed into kinetic energy. Heat, light, and motion all indicate that kinetic energy is doing work. Potential energy is often harder to detect. It must be changed into kinetic energy before we can use it.

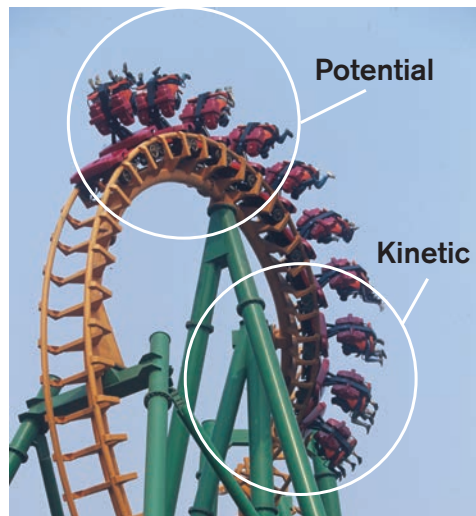

Potential energy is stored energy. Kinetic energy is energy of motion.

Teachers' Notes:

It might help students understand how much they personally rely on energy if the class discusses how they got to school today and what energy was required.

Ask them to list the things they did today that did not require energy. (There probably were none.)

Also ask them:

- How much energy do you think you use on a daily basis? (The average American uses over 11,000 kilowatt hours of electricity per year at home, or about 30,000 watt hours per day. This is 4 times the world average. Each of us, on average, uses more than 365 gallons of gasoline per year.)
- What types of energy do you use?

What are the forms of energy?

There are many forms of potential and kinetic energy. These include mechanical, chemical, thermal, electrical, radiant, and nuclear energy, as well as the energy of gravity.

- **Mechanical energy** is the energy that moves objects by applying a force. It can be kinetic – the motion of a snapping mousetrap. Or it can be potential – the tension in a set mousetrap.

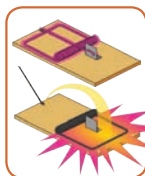

- **Chemical energy** is the energy released when the chemical bonds of a material change. Wood stores chemical energy that is released when it burns.

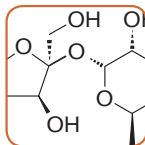

- **Nuclear energy** is the energy stored in the center (nucleus) of an atom. It's the energy that holds the center together. The energy can be released when the center splits apart or when centers fuse together.

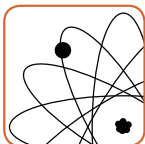

- **Electrical energy** is the flow of tiny charged particles called electrons. Electrons move through a conductor, such as a copper wire.



- **Radiant energy** is energy traveling as waves. It includes visible light, radio waves, x-rays, and gamma rays. The Sun's energy comes to us in this form.



- **Energy from gravity** is the energy of position or place. The potential energy of water held behind a dam is changed to kinetic energy when it is allowed to flow downhill.



- **Thermal energy** is heat energy. We use it to cook meals, to manufacture products, and to generate electricity.



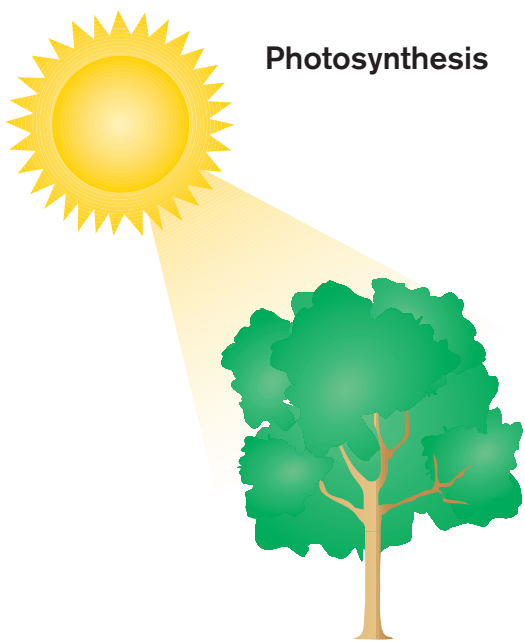

Photosynthesis

Teachers' Notes:

Plants convert light energy, water, and carbon dioxide into glucose (sugar). This process allows plants to store the Sun's energy as chemical energy to use when needed.

The chemical formula for photosynthesis is

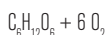
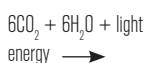

(6 molecules of carbon dioxide + 6 molecules of water produce 1 molecule of glucose + oxygen)

Plants use photosynthesis to store energy from the Sun. In the process of photosynthesis, plants convert radiant energy from the Sun into chemical energy in the form of sugar or starch.

Where does energy come from?

Much of the Earth's energy comes from the Sun in the form of radiant energy. Plants convert this energy to chemical energy by a process called **photosynthesis**. This chemical energy is stored in the form of sugars and starches, which provide energy for the plant as well as people and animals that eat the plant. When we burn plants such as trees, stored chemical energy is converted and released in the form of heat (thermal energy) and light (radiant energy), which we call fire.

Teachers' Notes:

You may need to remind students that the symbol < at the beginning of the time line means *less* than.

BCE = before the common era

Teachers' Notes:

The timeline that begins on this page highlights some important events in world energy use and shows the world population's gradual increase and boom. Ask students how this population increase will affect our energy needs. (More energy will be needed to support more people.)



Early humans control fire

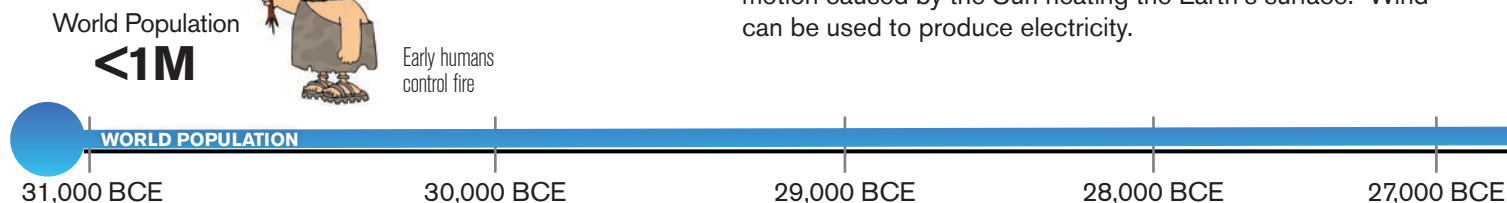

Biomass is the name for materials from plants and animals that have chemical energy stored in them. The energy in biomass originally came from the Sun. A biomass fuel we all know is wood for fireplaces and wood stoves. Other examples are crops such as corn and switchgrass, manure, garbage, and methane gas from landfills. By burning biomass, we release its stored chemical energy as thermal and radiant energy. We also can convert it to liquid fuel, such as **ethanol** and **biodiesel**. Biomass fuels provided about 5 percent of the energy used in the United States in 2013.

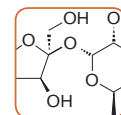

Radiant energy from the Sun's rays make some parts of the Earth warmer than others. Air surrounding these warmer surfaces is heated, which causes it to rise. Cooler air then flows in to replace the heated air that has risen. We call this flow of air **wind**.

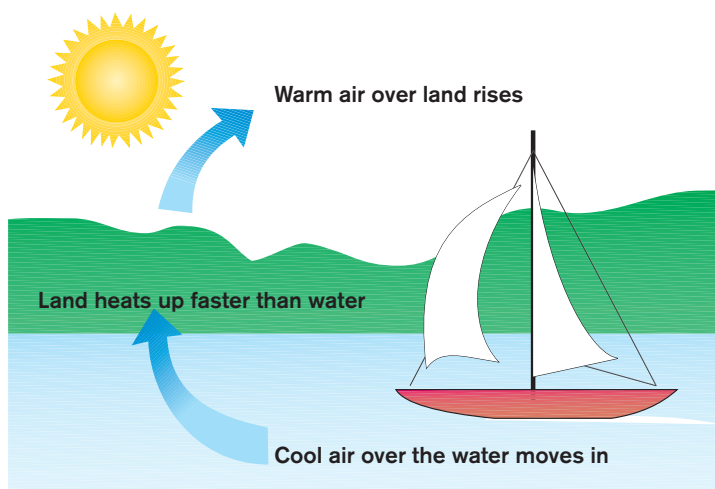

Air moves because of changes in air pressure. Wind is air in motion caused by the Sun heating the Earth's surface. Wind can be used to produce electricity.

Radiant energy from the Sun also causes water to evaporate into water vapor. The water vapor rises into the upper atmosphere where it forms clouds and rain.



This is called the **water cycle**. The tremendous energy in storms and winds is actually caused by the Sun's radiant energy.

When it rains, the water flows down rivers. The energy in moving water can turn a watermill or turbine to make **hydropower**.



About 300 million years ago, countless plants and animals died and were slowly buried beneath layers and layers of dirt and sand. Heat and pressure from these layers concentrated the chemical energy stored in them, slowly changing them to the **fossil fuels** oil, coal, and natural gas.

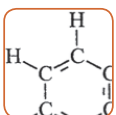

What is primary energy?

Primary energy is energy found in nature before we convert it to do work. Primary energy sources are

- **Solar energy** (sunlight)
- **Water power** (flowing water)
- **Wind energy** (moving air caused by the Sun heating the atmosphere)
- **Biomass** (plants)
- **Tidal energy** (the effect of the gravity of the Moon and Sun on the oceans)
- **Nuclear energy** (energy from inside uranium and plutonium)
- **Geothermal energy** (heat from inside the Earth)
- **Fossil fuel energy** (coal, natural gas, oil).

We consider fossil fuels to be primary energy sources even though they originally took their energy from the Sun and stored it as chemical energy

Teachers' Notes:

Fossil fuels began forming 354 to 290 million years ago in the Carboniferous Period of the Paleozoic Era. This was before the Jurassic era of dinosaurs, 199.6 to 145.5 BCE.

Teachers' Notes:

Ask students: Do you know where the heat inside the Earth comes from?

Radioactive decay of uranium in the Earth's core and friction from movement of tectonic plates generates the heat inside the earth.

Teachers' Notes:

How does tidal energy work?

Tidal energy depends on the rise and fall of the oceans caused by the pull of the gravity of the Moon and Sun and the rotation of the Earth. Twice a day every day the tides rise and fall in ways that can be predicted. The rush of water of the tide turns turbines placed in the water. A tidal range of at least 7 meters is required. There are not many sites on Earth where the difference between the high tides and low tides is great enough to use tidal energy to generate electricity on a big scale using this method.

Teachers' Notes:

Make sure students do not confuse natural gas and gasoline.

Petroleum and Natural Gas Formation

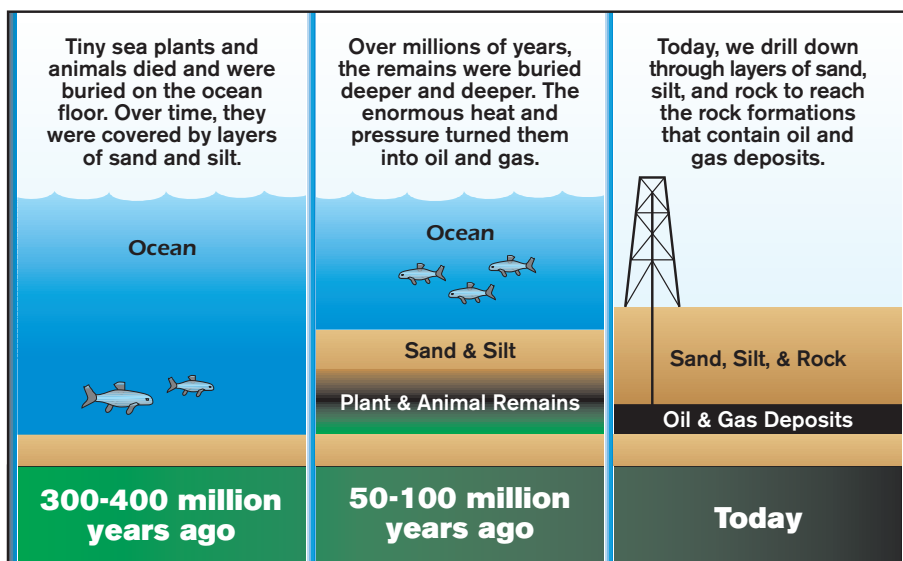

Petroleum was formed millions of years ago from the remains of plants and animals under heat and pressure.

Teachers' Notes:

Ask students: Can you think of a place around where you live that uses renewable energy?

Examples include wind turbines, solar farms, and hydroelectric dams.

Teachers' Notes:

What is the most efficient way to power transportation?

The typical gasoline-powered automobile engine has a thermal efficiency around 25%, whereas an electric motor can convert around 90% of its electrical energy into mechanical energy. But storing the electricity in a battery is only about 70% efficient.

While electric motors in automobiles hold significant promise, it is important to consider the costs of powering and producing them. When fossil fuels are used to produce electricity, thermal efficiency at the power plant (about 33%) and losses in transmission make the comparison between internal combustion engines and electric motors less dramatic.

Teachers' Notes:

In 2014, 90% of energy used in the United States was from non-renewable sources.

To update, check www.eia.gov/kids/energy.cfm?page=stats

What are secondary energy sources?

There are also **secondary energy sources** that are produced by using primary energy. Electricity is a secondary source that can be produced from any of the primary sources listed. Ethanol is a secondary energy source made from biomass.

What are renewable and non-renewable energy sources?

We can further divide the primary and secondary energy sources we use into renewable and non-renewable sources. **Renewable** sources can be continuously replaced. Day after day the Sun shines, the wind blows, plants grow, and rivers flow. We use renewable energy sources in our wood stoves, to make electricity, and to make alcohol and biodiesel fuel for cars. **Non-renewable** sources cannot be replaced. The supplies of coal, oil, natural gas, and uranium are limited. When we

use up these resources, they will be gone. In the United States, most of the energy we now use comes from non-renewable sources. We use them to make electricity, heat our homes, move our cars, and to manufacture goods.

How do we convert energy from one form to another?

The **law of conservation of energy** says that energy can change from one form into another, but it cannot be created or destroyed. In fact, when we say that we use energy, we really mean that we convert and harness it to do the work we need to do.

Energy is converted in hundreds of ways. For example, burning gasoline to power cars is an energy conversion process we rely on. The chemical energy in gasoline is converted to thermal energy, which is then converted to mechanical energy that makes the car move.

Think about it...

Renewable energy sources are constantly being replaced. Having an energy **supply** we can use now and also count on into the future is important.

But right now there are limitations to using renewable energy. First, there is the **intermittent** nature of the sources. The wind does not always blow, the Sun does not shine at night, and dry spells reduce the flow of rivers for hydropower. Second, the high cost of some of the technologies used for harnessing renewable energy drives up the cost of energy from these sources. Third, there are costs for getting power from renewables to customers.

There are also impacts on the environment. For example, hydropower does not produce carbon dioxide like burning fossil fuels, but building a dam does alter the area where it is built. This may affect plants and animals.





Our bodies convert the chemical energy in food we eat into thermal and mechanical energy when we exercise.

this heat because when you work hard you get hot. Your body converts the chemical energy in your food into mechanical energy, but some is lost as wasted heat.

What is efficiency?

Each time we convert energy from one form to another, we lose some of it, often as heat. We must constantly put more energy into machines or they will run down. A machine or system that converts energy without wasting much is very **efficient**. In fact, most energy conversion processes are not very efficient. As a result, energy is lost to the environment. Only about 25 percent of the energy we use in our bodies or automobiles is converted into mechanical energy. The rest is lost as heat. When a conversion process wastes a lot of energy, it is called **inefficient**.

The mechanical energy has been converted to kinetic energy. When we use the brakes to stop a car, that kinetic energy is converted by friction back to heat, or thermal energy.

Our bodies are also powered by converting energy. We must convert the energy in food into other forms of energy, such as mechanical energy so we can move, or thermal energy to maintain body temperature. When we exercise, we also produce a lot of heat energy. You can feel

<p>The first law of thermodynamics explains why...</p>	<p>Energy changes from one form to another, but it can't be created or destroyed.</p>
<p>The second law of thermodynamics explains why...</p>	<p>Every time energy is converted from one form to another, there is less energy available to do useful work.</p>

When we do not convert energy efficiently, it costs money and wastes valuable resources. This is why people today are

Think about it...



An incandescent light bulb gets very hot. A fluorescent bulb gets warm. An LED light stays cool. Which do you think is most efficient in converting electricity into light?

WORLD POPULATION



Teachers' Notes:

How can students make a significant conservation impact at home?

The U.S. Department of Energy estimates that space heating and cooling account for 48% of an average household's energy use. While they may not be as visible as pricier improvements, sealing leaks around doors and windows and setting thermostats higher or lower are the most cost effective means of saving energy in a home.

Ask students:

- What are some ways that you and your family can try to conserve energy?
- Ask for suggestions and hands-on examples of simple energy savings.

looking for ways to save energy by carefully using our energy resources and by trying to convert energy as efficiently as possible.

How can we save energy?

Wasting less energy is called **conservation**. Although conservation is not an energy source, we can use it to make non-renewable energy sources last longer into the future. We can all practice conservation by being careful about how much energy we use. Some things we can do are

- Carpooling
- Driving less, walking, and biking
- Using public transportation, like subways and buses
- Setting the thermostats in our homes, schools, and work places to reduce waste
- Reducing, reusing, and recycling things instead of throwing them away
- Turning off lights and appliances when they are not being used
- Insulating our homes
- Using energy-saving light bulbs
- Unplugging chargers for our phones and music players when we are not using them

Because conserving energy has become more important, manufacturers are making more efficient machines. Choosing cars that are more efficient helps. Also, families can purchase appliances that have good energy efficiency ratings.

What are some environmental impacts of our energy use?

If you've ever been to a greenhouse, you

know it's a place to grow plants, even in winter. Usually a greenhouse looks like a glass building. The glass lets the radiant energy from the Sun in, but as the light passes through the glass, its wavelengths get longer and cannot pass easily back out of the glass. The radiant energy is trapped as heat.

Some gases in the atmosphere trap heat in much the same way as a layer of glass. They are called **greenhouse gases**. The rise in temperature that results is called the **greenhouse effect**.



Sunlight enters the Earth's atmosphere. The land, water, and atmosphere absorb the radiant energy. Some of the energy reflects back through the atmosphere to space, but some is trapped in the atmosphere by greenhouse gases. Increasing the amount of greenhouse gases in the atmosphere traps more heat, causing temperatures to rise. Global warming is a planet-wide rise in temperature. Rising



Recycling is one thing that families can do to help save energy.

temperatures may cause changes in rainfall, the strength of storms, melting polar ice, and rising sea levels. This is called **climate change**.

Greenhouse gases occur both naturally and as the result of human activity. Some of the major greenhouse gases are

- **Carbon dioxide (CO₂)** – released when we burn oil, coal, and natural gas. It also comes from biomass and volcanoes.
- **Methane (CH₄)** – comes from landfills, coal mines, oil and natural gas operations, and agriculture.
- **Nitrous oxide (N₂O)** – comes from the use of nitrogen fertilizers and burning fossil fuels.

Each way we produce energy affects our environment in some way. Think about the effects of

- Mining coal and uranium
- Drilling for oil
- Fracturing underground rock for natural gas and geothermal wells
- Damming rivers for hydropower
- Cutting trees
- Placing turbines in the sea for tidal power
- Using large tracts of land for wind or solar farms
- Disposing of wastes from burning coal or from nuclear power plants

It is important for us to use our energy resources wisely and protect the environment.

Teachers' Notes:

What challenges do we face in expanding renewable energy sources like wind and solar?

Renewable energy sources often produce electricity intermittently. Intermittent sources may produce too little electricity at times and too much at others. Although technologies to transfer or store surplus electricity are improving, there is no efficient way to store energy on a large scale at this time. Nuclear and fossil fuel plants can provide a predictable and scalable base load of electricity to meet demand. This matches the way we use energy but has other environmental impacts.

The Greenhouse Effect

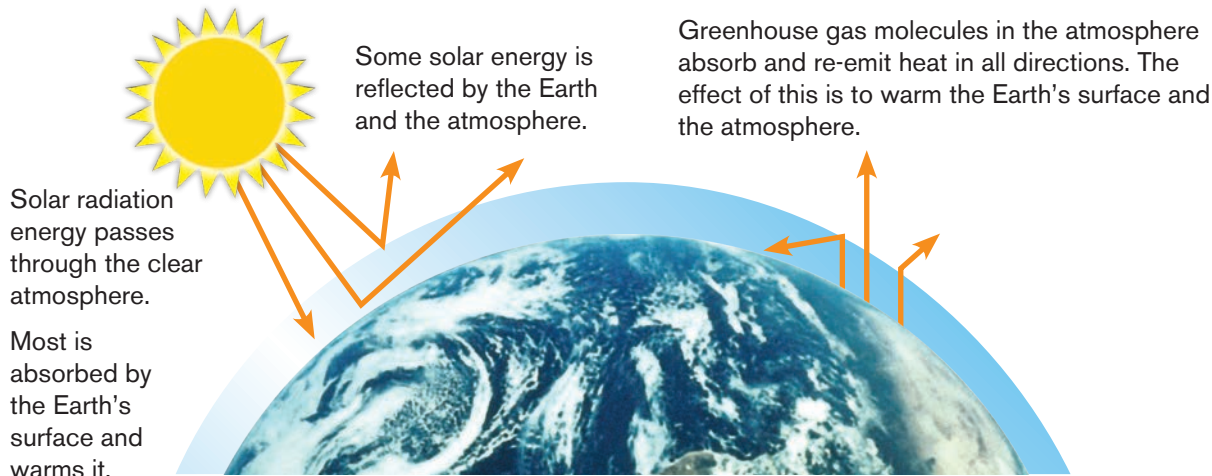

Teachers' Notes:

Water vapor acts as a greenhouse gas but is not considered one by EPA. Most scientists think the water vapor directly from human activity contributes very little to the amount of water vapor in the atmosphere.

World Population

3M

WORLD POPULATION

12,000 BCE

11,000 BCE

10,000 BCE

9,000 BCE

Teachers' Notes:

You can update the information in the pie chart by checking the Department of Energy's Energy Information Administration website: www.eia.gov/kids/energy.cfm?page=renewable_home_basics

Our Total Energy Use, 2014

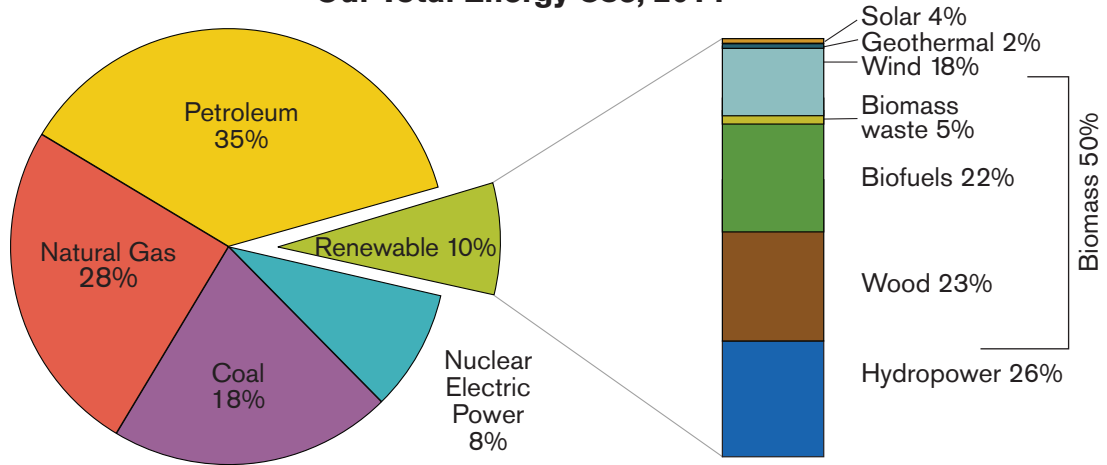

Note: Sum of components may not equal 100% as a result of independent rounding.
 Source: U.S. Energy Information Administration, Monthly Energy Review, Table 1.3 and 10.1 (March 2015), preliminary data.

About 90 percent of the energy used in the United States in 2014 came from non-renewable sources. Renewable sources provided about 10 percent.

Which energy sources will we use?

More and more, people are becoming aware of how crucial energy is to our way of life. There is also a growing awareness that we will need to make some changes in the energy sources we rely on and about how we use energy. Most people think we will need to use many different energy sources. But our choices are complicated.

We'll have to think about

- The available supply of each resource and where it is located. For example, we buy almost half of our oil from other countries. For our national security, many people want us to be able to produce the energy we need from U.S. sources.
- The cost of the energy we need.
- Which resources can provide enough of the energy we need.



Farmers harness oxen to plow fields

World Population
5.3M

8,000 BCE

7,000 BCE

6,000 BCE

5,000 BCE

Lesson 1 ENERGY BASICS

- The impact on the environment from obtaining the energy resource.
- The impact on the environment from using the resource.
- Choosing energy sources that work best in different parts of the country.

During our lifetime, the ways we use and supply our energy will change. We will need to use energy more wisely and protect the environment better.

Teachers' Notes:
 U.S. Energy Information Administration data show that the United States imported 16% of our total energy in 2013. The U.S. relied on imports for about 21% of the petroleum that we consumed in 2013. Have students explore the data that are available on our nation's current and historical energy use and production at www.eia.gov

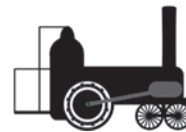

1859 CE First oil production well drilled in Pennsylvania

1826 CE John Ericson builds hot-air engine powered by the sun

1803 CE Steam locomotive invented

1787 CE Steamboat invented

1785 CE First water-powered fabric loom invented

1698 CE First steam pump invented



1300 CE Hopi Indians use coal for heating, cooking, and firing pottery. Anasazi Indians build cliff dwellings with southern exposures for solar heating



1100 CE Windmills introduced in Europe

644 CE First vertical axis windmill used in Iran

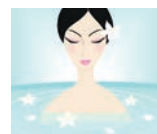

Hot springs used for bathing, cooking, and heating by Romans, Japanese, and others

World Population
85M

WORLD POPULATION

4,000 BCE

3,000 BCE

2,000 BCE

Energy Use Timeline

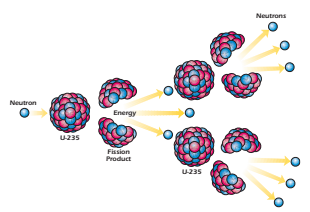

2015 CE
World Population
7.3B
is 1/2 meter
(1.6 feet)
above this page

1957 CE World's first large-scale nuclear power plant, Shippingport, Pennsylvania

1954 CE Solar voltaic cells invented

1942 CE Fermi team's first self-sustaining nuclear chain reaction

1904 CE First geothermal power plant built in Italy

1890 CE Solar engine used to run a printing press

1887 CE First automatically operating wind turbine

1885 CE Gasoline-powered automobile invented

1880 CE Coal is used to generate electricity

1860 CE Gasoline-powered engine invented

1804 CE
World Population
1B

World Population
300M

Water-powered grain mill used in Asia Minor

Romans use coal for heating

1,000 BCE

0

1,000 CE

2015 CE



Summary

Energy is the ability to do work.

There are two basic states of energy — potential and kinetic. Potential energy is stored energy. Kinetic energy is energy in motion.

There are many forms of potential and kinetic energy, including mechanical, chemical, thermal, electrical, radiant, nuclear, and the energy of gravity.

The primary sources we use today are fossil fuel energy, nuclear energy, geothermal energy, solar energy, and tidal energy. All these can be used to make electricity, a secondary source of energy.

Energy sources can be divided into renewable and non-renewable sources. Non-renewable sources cannot be replaced. Renewable sources can be replaced.

We can convert energy from one form to another, but we cannot create or destroy energy.

Saving energy is called conservation. Although conservation is not an energy source, we can use it to extend the time non-renewable sources will be available.

There are environmental impacts from the use of all energy sources. One impact is from greenhouse gases, which most scientists believe are contributing to climate change. Mining, drilling, and building dams affect the land and water. There can be spills that affect the oceans and wildlife.

Meeting our energy needs during your lifetime will be different than in the past.



LESSON PLAN

Lesson 1: Lesson Plan

Energy Basics

Overview

This lesson familiarizes students with the basic concepts of energy, explains how we use energy, and introduces some potential consequences of using energy. Students will review the difference between potential and kinetic energy and the various forms in which energy may exist. The origins of the energy that we use and the conversion of energy into usable forms are also discussed. The lesson concludes with an introduction to the environmental issues of using energy.

Because much of this material may be a review of existing knowledge, it may be possible to combine this lesson with Lesson 2 (Electricity Basics) in a single session.

Concepts

- What is energy?
- States and forms of energy (kinetic and potential)
- Where does energy come from?
- Renewable and nonrenewable energy sources
- Conversion of energy
- Efficiency
- Environmental consequences of energy conversion
- How can we save energy?
- Which energy sources will we use?

Energy and Population Timelines: What is the connection?

Energy and population timelines in this chapter give students an idea of the connection between human's use of energy and the gradual and now rapid population increase. Early populations increased as availability of food increased. That increase continued when homo sapiens became the dominant species on Earth with no rivals in about 33,000 BCE. Other factors contributed to human dominance. Being able to harness energy gave man a huge advantage over beasts. No other animal used fire, for example, and cooking food yields better nutrition for the species. Harnessing muscle energy from animals, like oxen or horses, to plow fields allowed farmers to go beyond human capacity to work.

Using energy to make machines do work was a big leap for mankind. Using fossil fuels for energy powered many advances in civilization. Advances in technology fueled new uses in transportation and agriculture. The 20th century saw the introduction of widespread availability of electricity in developed countries. Ask students to speculate about the connection between the availability of electricity and changes in the way people live. They can also speculate about how it affects us when developing countries improve their standards of living partly through increased use of energy and electricity as they modernize.

Ask students to compare all the energy sources they have learned in this chapter. Ask when the last new source was discovered. (Solar voltaic cells were invented in 1904. New sources of energy since that time have not matched the population's rapid increase.)

Over the last 40 years, global energy use per person has tripled and the world population increase has doubled. In 2015, there were over 7 billion people on Earth. Ask students to discuss how the increase will affect resource consumption. (More resources will need to support more people.) Ask what other issues they would expect. (Technological innovations will have to surpass population expansion. Consumption patterns may have to change. Economies may change.)

National Standards (Grades 5 – 8)

Science

NS.5-8.2 As a result of their activities in Grades 5-8, all students should develop an understanding of

- Properties and changes of properties in matter
- Transfer of energy

NS.5-8.5 As a result of activities in Grades 5-8, all students should develop

- Understandings about science and technology

Social Studies

NSS-EC.5-8.1 At the completion of Grade 8, students will know the Grade 4 benchmarks for this standard and also understand

- Choices involve trading off the expected value of one opportunity against the expected value of its best alternative
- The choices people make have both present and future consequences

NSS-EC.5-8.3 At the completion of Grade 8, students will know the Grade 4 benchmarks for this standard and also understand

- Scarcity requires the use of some distribution method, whether the method is selected explicitly or not
- As consumers, people use resources in different ways to satisfy different wants. Productive resources can be used in different ways to produce different goods and services

NSS-G.K1-12.5 As a result of activities in Grades K-12, all students should

- Understand how human actions modify the physical environment
- Understand how physical systems affect human systems
- Understand the changes that occur in the meaning, use, distribution, and importance of resources

Technology

NT.K-12.1 Basic Operations and Concepts

- Students demonstrate a sound understanding of the nature and operation of technology systems

NT.K-12.2 Social, Ethical, and Human issues

- Students understand the ethical, cultural, and societal issues related to technology

Objectives

Upon completing this lesson, students will be able to

- Give real life examples of energy use
- Define and contrast potential energy and kinetic energy
- Identify primary energy forms (fossil fuels, nuclear, geothermal, solar, wind, water, biomass, and tidal)
- Contrast renewable (wind, solar, geothermal, and hydro) and non-renewable (coal, oil, natural gas, and uranium) energy sources
- Explain how we convert energy into useable forms
- Plan specific actions to save energy in daily activities
- Identify environmental costs of energy use (greenhouse gas emissions, mining and drilling risks, resource depletion)
- Interpret visual information (e.g., charts, graphs, photographs, videos, maps)

Key Terms / Vocabulary

biodiesel – a type of fuel made by processing vegetable oils and other fats; used either in pure form or as an additive to petroleum-based diesel fuel

biofuel – a type of fuel made from plant material or animal waste; examples include bioethanol, alcohol, or biodiesel; used mostly for transportation

biomass – plant material and animal waste used as fuel

carbon dioxide (CO_2) – a greenhouse gas emitted from fossil fuel power plants and from burning biomass

chemical energy – the energy released when the chemical bonds of a material change

climate – the average weather (temperature, precipitation, wind, etc.) for a particular region and time of year, usually figured for decades

climate change – any significant change in measures of climate (temperature, precipitation, wind) that lasts for decades or more

conservation – saving or preserving something

efficient – producing a desired effect, especially in producing the effect without waste

electrical energy – the flow of tiny, negatively charged particles called electrons, usually through a wire

energy – the ability to do work

energy from gravity – the energy of a position or place

ethanol – an alcohol fuel made mainly from grain, such as corn

exports – products we make and sell to other countries

fossil fuel – a natural fuel formed in the geological past from the remains of living organisms; examples are coal, oil, or natural gas

geothermal energy – energy from using the heat of the Earth's interior

global warming – an average increase in the temperature of the Earth's atmosphere and gradual changes in global climate patterns; higher average temperatures do not necessarily mean there will be warmer weather at any particular place on Earth

greenhouse effect – the trapping and build-up of heat in the atmosphere near the Earth’s surface.

Greenhouse gases absorb some of the heat flowing back toward space and then reradiate it to the Earth’s surface. These gases include carbon dioxide, methane, and nitrous oxide. If the atmospheric concentrations of these greenhouse gases rise, the average temperature of the atmosphere will gradually increase

greenhouse gas – any gas that absorbs infrared radiation and traps heat in the atmosphere. Greenhouse gases include carbon dioxide, methane, and nitrous oxide

hydropower – electric power made by water falling at a dam or moving water in a river or the ocean

inefficient – wasteful of time or energy

imports – products we buy from other countries

intermittent – not continuous; stopping and starting at intervals

kinetic energy – energy in action

mechanical energy – the energy that moves objects by applying a force

methane (CH_4) – a greenhouse gas that comes from landfills, coal mines, oil and natural gas operations, and from agriculture

nitrous oxide (N_2O) – a greenhouse gas that comes from using nitrogen fertilizers and from burning fossil fuels

non-renewable energy – energy sources that cannot be replenished (made again) in a short period of time

nuclear energy – the energy stored in the nucleus of an atom; can be released when the center splits apart during fission or when centers join together during fusion

photosynthesis – the process in which plants convert the Sun’s energy to chemical energy stored as sugars or starches. The equation is $6\text{CO}_2 + 6\text{H}_2\text{O} \Rightarrow \text{C}_6\text{H}_{12}\text{O}_6 + 6\text{O}_2$ (carbon dioxide + water \Rightarrow glucose + oxygen)

potential energy – stored energy; the capability to produce energy; for example, coal has potential energy: when it is burned, it gives off heat and light

radiant energy – energy traveling as waves

renewable energy – an energy resource that is replaced rapidly by natural processes; examples include solar, wind, hydropower, geothermal, and biomass

secondary energy source – an energy source we get from converting primary energy sources (coal, oil, nuclear, solar energy); the energy sources we use to make electricity can be renewable or non-renewable, but electricity itself is neither renewable nor non-renewable

solar energy – energy from the Sun

thermal energy – heat energy

tidal energy – a type of hydropower resulting from the rise and fall of the oceans’ tides

uranium – a heavy, hard, shiny metal that is radioactive; used as the fuel for nuclear power plants; symbol is U

water vapor – a greenhouse gas

weather – a short-term state of the atmosphere; measured in temperature, precipitation, wind speed, storms, etc.

wind energy – energy from the flow of air

work – causing change (position, temperature, form, etc.)

Lesson One – Chapter Outline

Energy uses

States of energy

- Potential
- Kinetic

Forms of energy

- Mechanical
- Chemical
- Radiant
- Nuclear
- Thermal
- Energy from gravity
- Electrical

Sources of energy

- Solar
- Biomass
- Geothermal
- Tidal
- Secondary sources
- Fossil fuel
- Nuclear

Renewable and non-renewable sources of energy

Conversion of energy

Environmental consequences of energy use

Saving energy

Choosing energy sources

Reading

Reading for this lesson in the student reader can be assigned as homework prior to this class session, or it can be read in class as guided reading.

Performance Assessment and Extensions

A Reading Review Exercise follows that you can reproduce or project for your class. The labs and activities that follow include inquiry-based questions that can be used to assess student learning. Accompanying this lesson is a PowerPoint lecture with a review that can be used as an interactive assessment. For a project-based assessment, have students create a blog, podcast, or video on a topic from this lesson.

Lesson 1 Reading Review Exercise

A. List the two basic states of energy.

1. _____ 2. _____

B. List five primary energy sources.

1. _____ 4. _____
2. _____ 5. _____
3. _____

C. Indicate whether the following statements are true (T) or false (F) by circling the correct letter. If the statement is false, correct it to make it true.

- | | | |
|---|---|---|
| 1. Energy cannot be created or destroyed. | T | F |
| 2. Fossil fuels originally got their energy from the Sun. | T | F |
| 3. Automobiles are energy efficient. | T | F |
| 4. Kinetic energy is stored energy. | T | F |
| 5. In any energy conversion process, some energy is lost. | T | F |

D. Label the pictures by writing potential or kinetic on the line under the picture.

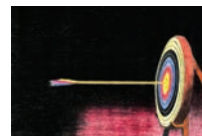
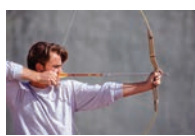

E. Draw a picture showing your own example of potential and kinetic energy or write a sentence giving an example.

F. Write a sentence or two to explain the circle graph on p. 9.

Activities, Labs, and Supplemental Information

Teacher's PowerPoint Presentation

A Teacher's (PowerPoint) presentation is provided on CD and online on the DOE Office of Nuclear Energy website to help you present chapter concepts to your class. Download the teacher presentation at: <http://energy.gov/ne/services/harnessed-atom>

Activities

The primary in-class activity for Lesson 1 is the Energy in a Hamburger discussion. This activity should last approximately 25 minutes and should be done in small groups. The groups will be given about 10 minutes to come up with their list of energy uses that go into getting a hamburger. Next, the class will come back together and have a large group discussion to share and compare ideas. Alternately, groups could produce a video or play to illustrate the production energy needed for a burger.

Once students have completed their lists, have the class convene and share their results. You may want to ask for one item from each group in turn and repeat until your board is full. Record or have students record a comprehensive chart of these steps in a flowchart on the board. Place each list item within a circle and connect the circles with lines, illustrating the energy relationships. You should end up with a huge diagram showing the complex energy and resources that go into what seems like a simple hamburger. More information about "Thinking Maps" is available on the internet.

Labs

The first of two labs for Lesson 1 is the Future Energy Graphs lab. This lab should last approximately 15 minutes. This activity should be done in small groups. The groups will be given a short time to come up with a graph illustrating the mix of energy sources that we should use 25 years in the future. Next, the class will come back together and each group will explain their graph and the rationale for making their choices. A graph on page 9 of the student reader shows the energy sources used in the United States in 2014 for all purposes. In 2014 our energy use relied heavily on non-renewable sources (89%), consisting of fossil fuels (petroleum 35%, natural gas 28%, and coal 18%) and electricity from nuclear (8%). Numerous factors may cause our energy use to change. Use the following link to go to the Energy Information Administration site to update the pie chart: www.eia.gov/kids/energy.cfm?page=stats

The purpose of this lab is to help students consider the benefits and costs of various energy sources and the factors that will guide our future energy choices. Save the graphs. Repeat the activity at the end of Lesson 9, and have students compare their graphs from the beginning of the unit with graphs they produce at the end of the unit.

The second lab for Lesson 1 is Energy Efficiency and the Horseless Carriage. This activity can be done individually or in groups of students. It can be assigned either as homework or as an in-class assignment.

Activity – **Energy in a Hamburger**

Materials

Each group needs writing supplies.

Directions

Energy is everywhere, and everything we do requires it. It plays a huge role in our lives every day, but it is easy to take it for granted and forget just how much we depend on it. To the average person electricity is just something that comes out of the wall, but, in reality, an incredibly complex series of events takes place before it ever reaches the home. The point of this activity is to help us consider just how much energy it takes to make something as simple as getting a hamburger at your favorite fast food restaurant.



Spend 10 minutes brainstorming a list of steps requiring energy that have to take place in order to put that hamburger on your tray at lunch.

Consider these areas to get you started

- Energy to make the beef
- Energy to get the beef to the restaurant
- Energy used in the restaurant
- Energy used in packaging
- Energy that got you to the restaurant
- Energy to make the machines involved in transportation, cooking, etc.

The amount of energy that goes into something as simple as getting a meal at a fast food restaurant is incredible, so you should be able to come up with quite a list!

Remember, it takes an amazing amount of energy to support the lifestyle we are accustomed to. Just 100 years ago convenient energy was not available like it is now and life was very different. Can you imagine what it would have been like to live then?

Lab – Future Energy Graphs

Materials

Each group needs writing supplies or access to a board.

Procedure

Spend 10 minutes discussing U.S. energy sources and what percentage we use. Use your student reader for information or go online. Create a pie graph that illustrates your ideal energy mix for the country in 25 years. You may wish to list the possible energy sources on the board first. Consider these factors to help get discussion started

- Availability of each energy source and where it is located
- The cost of each energy source. Use current cost information from the Energy Information Administration www.eia.gov
- How much energy each energy source can provide
- Which energy sources can provide electricity and which have other uses
- Environmental impacts of obtaining each energy source
- Environmental impacts of using each energy source
- Technology required to use each energy source

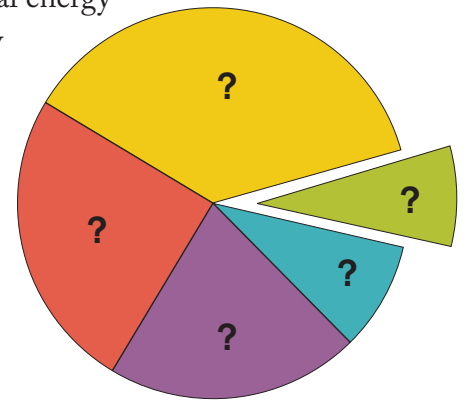

Questions

1. Once you have completed your graph, create a list of pros and cons for each energy source that you choose. Share your results with classmates.

2. What are the most important factors that we consider for our future energy mix?

3. Can or should any one energy source provide the majority of our energy needs?

4. What changes need to be made to allow your future energy graphs to happen?

Lab – Energy Efficiency and the Horseless Carriage

This activity can be done individually or in groups of students. It can be assigned either as homework or as an in-class assignment.

Materials

- Paper or graph paper
- Colored markers or pencils
- Or computer with spreadsheet/graphing software, such as MS Excel or Numbers

Key Concepts

machines	efficiency	friction
energy conversion	waste heat	drag

Background

When we go somewhere in a car, we are using a machine to convert stored chemical energy in gasoline to mechanical energy (kinetic energy of motion). The second law of thermodynamics tells us that every time energy is converted from one form to another, we lose some as wasted energy. In other words, there is less energy available to do useful work.

Procedure

Find the following information and calculate

- What is the average price for a gallon of regular gasoline where you live? \$_.____
- For a typical car, about 15% of the chemical energy in fuel actually helps get passengers to their destination. Therefore, what percentage is wasted? ____%

- Use your answers to a.) and b.) to calculate how much of the cost of a gallon of gasoline is wasted in a car. \$_.____
- Using the diagram on the right, make a pie chart that shows how the money in your answer c.) is lost to each energy inefficiency. Use the first (lower) percentage shown for each category.

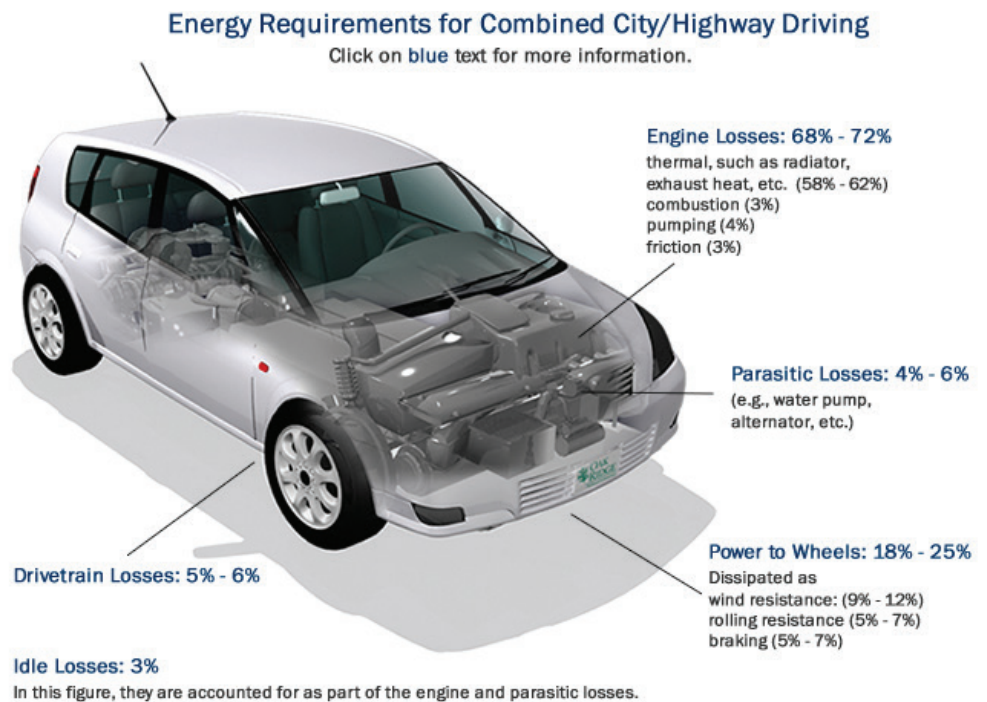

Discussion Questions

Students may get more information about fuel economy in cars at www.fueleconomy.gov/feg/atv.shtml

1. Do you think a car is able to convert the energy in gasoline efficiently?

No. Only about 15 percent of the energy from the fuel you put in your tank moves your car down the road.

2. What does MPG mean? *miles per gallon*

3. Miles per gallon is the way we calculate a vehicle's fuel efficiency. How would you express 30 MPG as a math equation? Can you convert it to SI units?

30 miles / 1 gallon or 30 miles/g; International System of Units (SI) include kilometer per liter (km/l).

1 mile = 1.6 km; 1 gallon = 3.78 liters; $30 \times 1.6 = 48$; $48 / 3.78 = 12.7$; $30 \text{ mpg} = 12.7 \text{ km/l}$

4. The energy conversion process of an engine is inefficient. Most of the energy from a gallon of gas is lost. Where does it go? What other energy form is produced? (Hint: Think of how the hood of a car feels after a trip. Think also about the brakes.)

The engine converts the potential chemical energy of gasoline into kinetic energy: both mechanical energy and heat energy. The heat escapes into the atmosphere and is no longer useable.

5. Why does fuel efficiency matter? Brainstorm ways to make cars more efficient.

Most of the fuels used for car travel today are non-renewable. Because so much energy is lost to engine and driveline inefficiencies, there are ways we can to improve fuel efficiency with advanced technologies such as hybrid vehicles that use electricity stored in batteries. Encourage students to discuss their ideas for efficiency innovations.

ELECTRICITY BASICS



Introduction

It's difficult to imagine life without convenient electricity. You just flip a switch or plug in an appliance, and it's there. But how did it get there? Many steps go into providing the reliable electricity we take for granted.

In this lesson, we will take a closer look at electricity. We will follow the path of electricity from the fuel source to the home, including the power plant and the electric power grid. We'll explore the role of electric utilities in the generation, transmission, and distribution of electricity.

TOPICS:

Basics of electricity
Generating electricity
Similarities of power plants

Distributing electricity
Generation
Transmission
Distribution
Power grids
Smart grids

Utilities
Cost of electricity
Regulation
Deregulation

Planning for the future

What is electricity?

Of all the forms of energy, **electricity** is the one we rely on most in our day-to-day lives. In fact, we are so accustomed to using electrical energy that we tend to take it for granted – until service stops and everything comes to a halt.

Electricity is our most versatile and adaptable form of energy. We use it at home, at school, and at work to run numerous machines and to heat and light buildings.

To scientists, electricity is the flow of tiny particles called electrons that have an electrical charge. Sometimes you see it in the sky as lightning or experience

it as static electricity when your hair is attracted to a comb or when there is a crackling sound as you take off your sweater.

How is electricity produced?

To produce a steady flow of electricity, we use a generator. A generator is a coil of copper wire that spins inside a magnetic field. This produces a flow of electrons through the coil of wire.

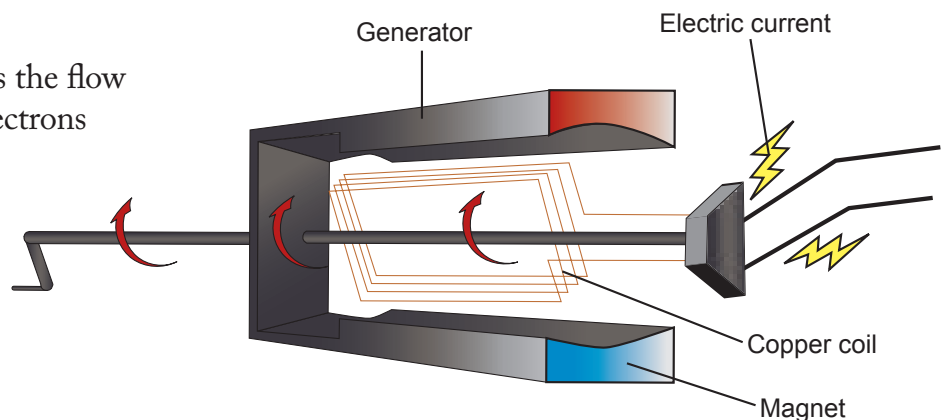

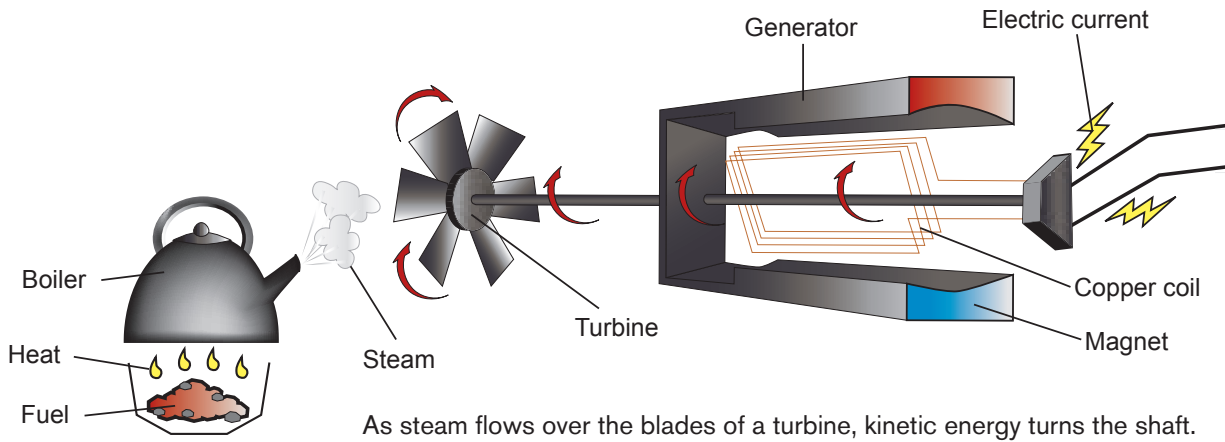

Teachers' Notes:

Why do most municipalities have only one electric company? Although competition is generally best for consumers, local governments usually allow a single utility company to provide electric service. Providing electricity to customers in remote locations is extremely expensive. Utility companies are granted regulated monopolies in exchange for agreeing to serve all citizens instead of just the profitable ones.

Where is electricity produced?

Electricity is generally produced at a power plant by converting one of the primary sources of energy into electricity.

Who makes electricity?

Companies that sell electricity to customers are called **utilities**. A utility provides something useful or essential to the public, like electric power, natural gas, or water.

What energy sources do we use to make electricity?

In the United States, the sources we use to make electricity are fossil fuels (coal, oil, or natural gas), uranium, or falling water. We also use solar power, wind, biomass, and geothermal sources.

Because a utility provides an essential service to its customers, it has special duties. For instance, an electric utility must be able to supply all the electrical needs of its customers. A utility can't promise to deliver its product in two weeks the way some other

Most power plants are similar in several important ways. They generate electricity by heating water to produce **steam**. The steam is then directed against the blades of a **turbine**, making it spin much like the way air makes a windmill's blades spin. The turbine turns the generator and produces electricity.

Fuels Used to Make Our Electricity in 2014

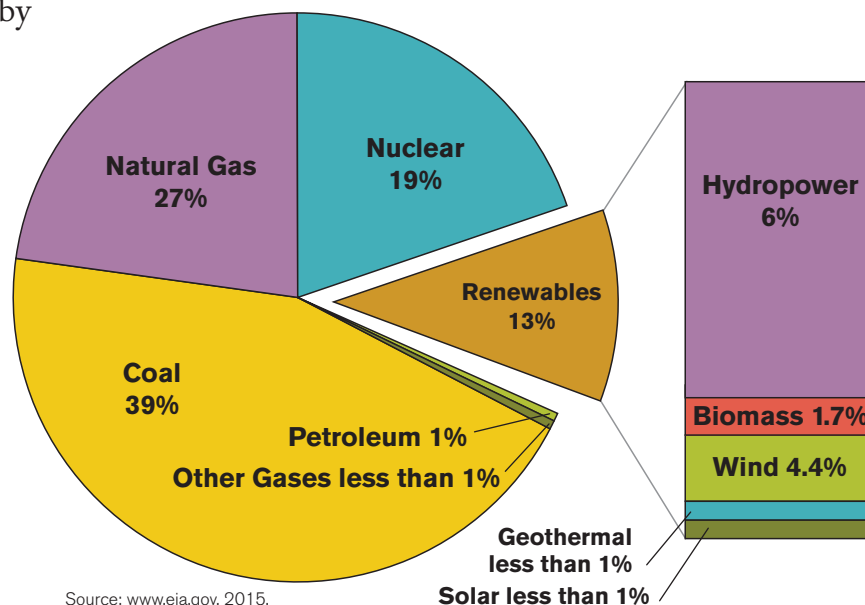

Source: www.eia.gov, 2015.

Teachers' Notes:

Ask students where the electricity they use is generated and what energy sources are used. What local utility or utilities provide your electricity?

Teachers' Notes:

Make sure your students understand that this circle graph shows energy sources used to make electricity. The circle graph in Lesson 1 shows energy sources used for all purposes. Other fuels include non-biogenic waste, batteries, chemicals, hydrogen, pitch, sulfur, tire-derived fuel, etc. Other gases = blast furnace gas, propane, manufactured and waste gases from fossil fuels. Note: Sum of components may not equal 100% due to independent rounding.

Teachers' Notes:

Why have some States deregulated their electric industry?

There are advantages of competition. If electric utilities compete with one another for customers, there is more incentive to develop the technology that will increase efficiency and thus lower prices. Such an atmosphere can produce benefits for customers, the environment, and the industry as a whole.

However, it does not always work out well, especially in markets with smaller populations, and some areas are re-regulating. Ask students to think about the pros and cons of deregulating.

Teachers' Notes:

How efficiently can we transmit electricity?

Transmitting electricity across the country provides tremendous flexibility, but it comes at a cost. The U.S. Energy Information Administration estimates that 6.5% of the electricity that is produced is lost to conductor resistance during transmission. Smaller power plants and grid-connected microgenerators have become more popular in recent years as a way to mitigate these losses. Small modular reactors are one-third the size of current nuclear reactors. They can be made in factories and shipped to sites ready to "plug and play" upon arrival, reducing capital costs and construction time. The smaller size is suited for areas that do not require large reactors. More information is available at www.energy.gov/ne

companies can. Electricity must be ready for use all the time. This means there must be generating plants, fuel, and enough power lines to provide service at any instant. The supply must be reliable. The cost must be reasonable.

To make sure these conditions are met, State and local governments **regulate** utilities. When governments regulate, they make sure the utility provides good services at prices that are fair to customers and the utility. In return, the utility is allowed to be the only one in its area. In some areas of the country, **deregulation** now allows customers to choose which company they buy their electricity from the same way they can select a phone or internet company. However, State public utility commissions still regulate rates for customers, approve sites for generation facilities, and enforce State environmental regulations.

How do we get electricity to the place where we use it?

The electricity produced in the generator is sent out over wires to homes, schools, hospitals, farms, offices, and factories. Getting it there is not a simple job.

One way to think about how electricity is distributed is to imagine water being pumped through pipes. The water flows from high pressure at the pump down the pipes toward the lower pressure at your home.

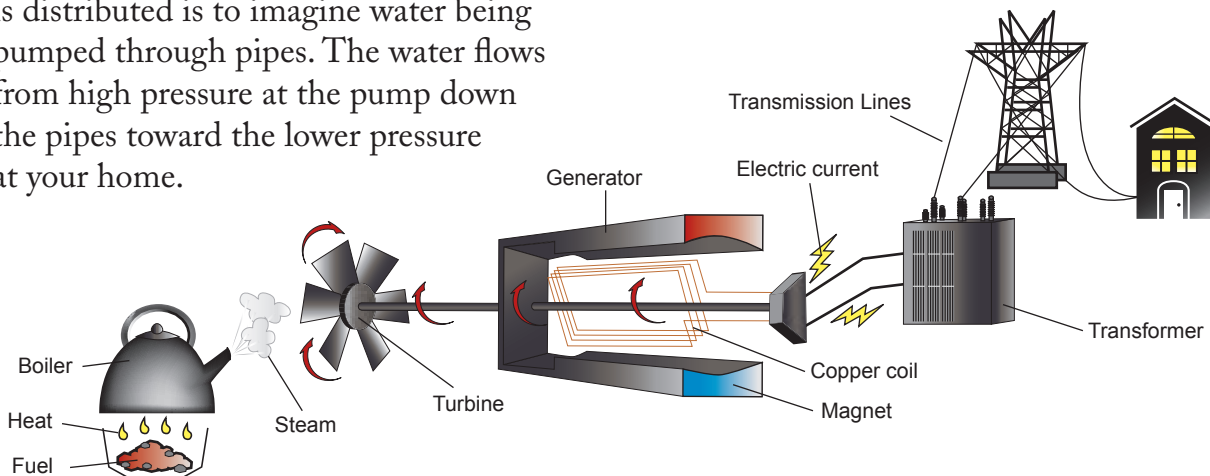

With electricity, this “pressure” difference is called **voltage**.

There are three main steps in getting electricity to customers:

- **Generation** – using a source of energy to produce electricity
- **Transmission** – using high voltage lines from the power plant to distribute electricity to areas that may be far from the power plant
- **Distribution** – using lower voltage lines, **substations**, and transformers to deliver electricity to local customers

At one time, almost all of the electricity used in the United States came from companies that owned the power plants, transmission lines, and distribution systems. Today, some companies are involved in generation, transmission, and distribution, while other companies are involved in only one aspect of the industry.

What is the power grid?

To get electricity to everyone who needs it, utilities send large amounts of electrical power over long distances. This is done through a network of transmission lines called the **power grid**. At the power plant, the voltage from the

The Main Interconnections of the U.S. Electric Power Grid

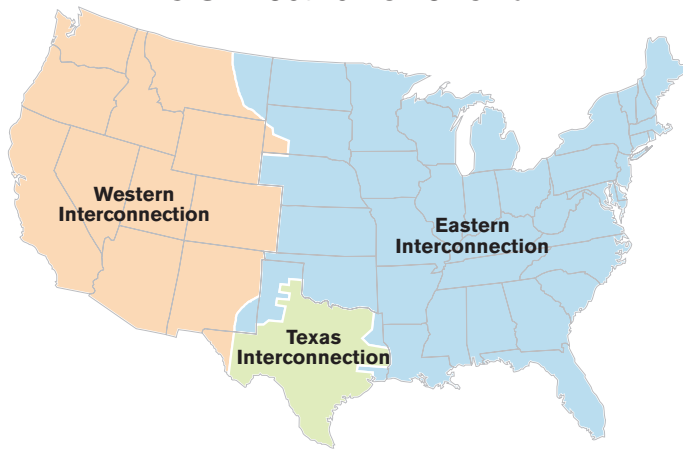

The national power grid connects the 48 continental U.S. States. Alaska and Hawaii have their own grids.

generator is increased to transmit it more efficiently. The high-voltage current is then sent through the power grid to a substation where it is transformed to lower voltages for distribution to homes, schools, and industries.

Over the years, transmission networks have evolved into three major power grids in the 48 connected States. These networks allow electricity to transfer from

one part of the grid to another. The three networks are the

- Eastern Interconnection
- Western Interconnection
- Texas Interconnection

These interconnections between utilities allow them to meet changing energy demands. For example, a utility that has a power shortage can buy electricity from a utility that has a surplus. It also allows small companies or even individuals to sell the electricity they generate to others. This is important because it helps us use intermittent energy sources like hydropower, wind, and solar power. It also means that if a company or even a family generates more electricity than it can use, the electricity can be sold so it isn't wasted.

Teachers' Notes:

What is the smart grid?

Demand for electricity is much higher during the day than it is at night. To help balance the load, newer electric meters and appliances allow two-way communications between utility companies and customers. If an electricity need is flexible, the smart grid can dynamically schedule these uses during periods of lower demand and scale them back during periods of high demand. Smart grid technologies save electricity and offer environmental benefits.

What is the "smart grid"?

To make sure electricity is there when customers need it, utilities are investing in **smart grid** equipment. This wireless equipment lets the utility know what is

The Power Grid

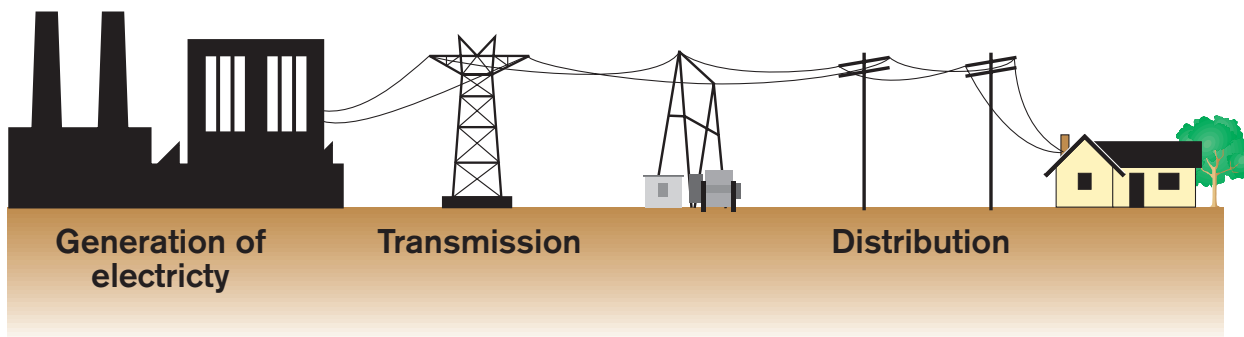

Electricity is distributed to homes and industry through a power grid.



The smart grid communicates with other wireless equipment the way smart phones do.

happening in real time. It helps the utility find and fix problems like damaged power lines quickly.

A smart grid can also tell the power company when more electricity

is needed to meet demand. This helps utilities be more efficient. It also helps customers choose to use more electricity at times when power rates are cheaper.

Why do we have to pay for electricity?

The electric industry must build power plants, run them, buy fuel for the plants, string wires or bury them underground to every home and business, and pay workers to do all the jobs that must be done. As you can imagine, all that takes a lot of money.

Teachers' Notes:

Ask students what their predictions are about the future use of electricity.

How will using electric-powered cars affect electric utilities?

How about an increasing population?

Customers pay the utility for the electricity that they use. Meters keep track of how much electricity travels from a power company's wires into our homes, businesses, schools, and factories. The company either sends a worker to read the meter or newer meters send a signal through the power lines to the power company that shows how much each customer has used. Then the power company sends each user a bill.

How do utilities plan for the future?

Because an electric utility must serve the needs of the public, the people who manage it must plan carefully so they can produce enough electricity. Decisions made today must predict the public's need for electricity in the future. These decisions can be difficult. It takes from 5 to 15 years to build a new fossil fuel or nuclear plant. It also takes time to build a power plant that uses renewable energy, like a dam, solar project, or a wind farm. Because it can take so long, utilities must act on predictions of what customers will need in the future.



Meters measure a customer's use of electricity so that bills are accurate.



Summary

Electricity is our most versatile form of energy. Electricity is created by the flow of tiny particles called electrons that have an electrical charge.

At power plants, electricity is produced by converting an energy source into electricity. In the United States, the sources include fossil fuels, uranium, and water power. We also use solar power, wind, biomass, and geothermal energy.

Most U.S. power plants generate electricity by heating water to produce steam and then use steam to turn the blades of a turbine attached to a generator.

Companies that sell electricity are called utilities. Utilities are often regulated so that our electricity supply is steady and costs are fair.

There are three main steps in getting electricity to customers – generation, transmission, and distribution.

Electricity is sent through the power grid to customers. Customers pay for the electricity they use. New smart grid systems help utilities track the demand for electricity and operate efficiently.

LESSON PLAN

Lesson 2: Lesson Plan

Electricity Basics

Overview

This lesson familiarizes students with the basic concepts of electricity generation, transmission, and distribution. The students will learn about the operation of steam-driven power plants, utility companies, and the power grid. The steps of generation, transmission, and distribution are presented. Students also learn about the costs of electricity and the importance of careful planning to meet our future energy needs.

Concepts

- What is electricity?
- Similarities of power plants
- Using steam and turbines to produce electricity
- The power grid and electricity transmission
- Utility companies and government regulation
- Costs of electricity generation, transmission, and distribution

National Standards (Grades 5 – 8)

Science

NS.5-8.2 As a result of their activities in Grades 5-8, all students should develop an understanding of

- Properties and changes of properties in matter
- Transfer of energy

NS.5-8.5 As a result of activities in Grades 5-8, all students should develop

- Abilities of technological design
- Understandings about science and technology

Social Studies

NSS-G.K1-12.1 As a result of activities in Grades K-12, all students should

- Understand how to analyze the spatial organization of people, places, and environments on Earth's surface

NSS-EC.5-8.16 At the completion of Grade 8, students will know the Grade 4 benchmarks for this standard and also understand

- In the United States, the federal government enforces antitrust laws and regulations to try to maintain effective levels of competition in as many markets as possible; frequently, however, laws and regulations also have unintended effects, for example, reducing competition

Technology

NT.K-12.1 Basic Operations and Concepts

- Students demonstrate a sound understanding of the nature and operation of technology systems

Objectives

Upon completing this lesson, students will be able to

- Identify electricity as being caused by the flow of charged particles called electrons
- Describe how most power plants heat water to produce steam and turn turbines
- Assemble and demonstrate the operation of a simple electric generator
- Evaluate the reasons that governments regulate utilities (electricity has become a necessity which requires adequate capacity, reliability, and reasonable pricing)
- Explain the steps in delivering electricity to customers (generation, transmission, and distribution)
- Give specific examples of when the power grid would be used to transmit electricity between different interconnections and regions
- Identify the costs associated with delivering electricity to consumers
- Explain the complex and time-consuming nature of making future energy choices
- Read and interpret a circle graph (pie chart)

Key Terms / Vocabulary

deregulation – removing or reducing government restrictions and rules

distribution – the process of sending electricity from power plants to customers

electrical energy – the flow of tiny, negatively charged particles called electrons, usually through a wire

electric meter – a device for measuring the amount of electricity being used so that the utility knows how much to charge the customer

electricity – *see electrical energy*

generation – the making of electricity

generator – a machine that makes electricity

power grid – the nationwide linked system that moves electricity from one place to another

regulation – a rule or directive made and maintained by an authority; the status of being required to follow rules made and maintained by an authority

regulatory agency – a public authority or government agency responsible for supervising or exercising authority over some area of human activity

smart grid – a name given to the use of computer intelligence applied to the transmission and distribution of electricity

steam – water in vapor form; invisible gas made when water is heated to the boiling point

substation – a part of an electrical generation, transmission, and distribution system where voltage is transformed from high to low or the reverse

transmission – the sending or moving of electricity

turbine – a wheel with many blades that are spun and connected to a generator to make electricity

utility – a company that provides a public service or product, such as electricity, water, or telephone

voltage – the difference in electrical charge between two points

Lesson Two – Chapter Outline

What is electricity?

- Electron flow
- Static electricity

How is electricity produced?

- Sources of energy
- Similarities of power plants
- Using steam, turbines, and generators

Where is electricity produced?

What energy sources do we use to make electricity?

Who makes electricity?

- Utility companies
- Reliability and reasonable pricing
- Regulation and deregulation

How do we get electricity to the place where we use it?

- Generation
- Transmission
- Distribution

What is the power grid?

- Transmission and high voltage
- Three U.S. interconnections
- Intermittent sources
- Transferring surplus power to cover shortages

What is the “smart grid”?

Why do we have to pay for electricity?

- Costs of producing and distributing electricity
- Electric meters

How do utilities plan for the future?

- Projecting future demand
- Lengthy plant construction

Reading

Reading for this lesson in the student reader can be assigned as homework prior to this class session, or it can be read in class as guided reading.

Performance Assessment and Extensions

A Reading Review Exercise follows that you can reproduce or project for your class. The labs and activities that follow include inquiry-based questions that can be used to assess student learning. Accompanying this lesson is a PowerPoint lecture with a review that can be used as an interactive assessment. For a project-based assessment, have students create a blog, podcast, or video on a topic from this lesson.

Lesson 2 Reading Review Exercise

A. Circle the letter of the best answer for each item.

1. Most power plants make electricity by heating water to produce

a. oil	c. electrons
b. steam	d. turbines

2. In most power plants, generators produce electricity when they are turned by a shaft connected to a

a. turbine	c. containment vessel
b. meter	d. grid

3. Which of these is not one of the steps in getting electricity to customers?

a. distribution	c. generation
b. transmission	d. drilling

B. Indicate whether the following statements are true (T) or false (F) by circling the correct letter. If the statement is false, correct it to make it true.

- | | | |
|---|---|---|
| 1. Electricity is created by the flow of tiny particles that have an electrical charge. | T | F |
| 2. Electricity can only be transmitted short distances. | T | F |
| 3. Meters keep track of how much electricity you use. | T | F |
| 4. Demand for electricity is always the same. | T | F |
| 5. Power plants can be constructed quickly to meet demands. | T | F |

C. List three reasons why governments regulate utilities.

1. _____

2. _____

3. _____

D. Write three or four sentences to explain the circle graph of fuels used to make electricity.

Lesson 2 Reading Review Exercise - Answers

A. Circle the letter of the best answer for each item.

1. Most power plants make electricity by heating water to produce

a. oil	c. electrons
b. steam	d. turbines

2. In most power plants, generators produce electricity when they are turned by a shaft connected to a

a. turbine	c. containment vessel
b. meter	d. grid

3. Which of these is not one of the steps in getting electricity to customers?

a. distribution	c. generation
b. transmission	d. drilling

B. Indicate whether the following statements are true (T) or false (F) by circling the correct letter. If the statement is false, correct it to make it true.

- | | | |
|--|-----|-----|
| 1. Electricity is created by the flow of tiny particles that have an electrical charge. | (T) | F |
| 2. Electricity can only be transmitted short distances.
<i>Can be transmitted long distances</i> | T | (F) |
| 3. Meters keep track of how much electricity you use. | (T) | F |
| 4. Demand for electricity is always the same.
<i>Changes constantly. For example, there is less demand at night when people are asleep.</i> | T | (F) |
| 5. Power plants can be constructed quickly to meet demands.
<i>It takes several years to build a power plant.</i> | T | (F) |

C. List three reasons why governments regulate utilities.

1. Electricity is an essential service to customers. Utilities must be able to supply all of the electrical needs of its customers at any given time.
2. Electricity service must be reliable.
3. Electricity service must be reasonably priced.

D. Write three or four sentences to explain the circle graph of fuels used to make electricity.

In 2014 we used coal to make 39% of our electricity, natural gas for 27%, nuclear for 19%, renewable sources for 13%, petroleum (oil) for 1%, and other gases for less than 1%. The sources that made up the 13% for renewables were hydropower 6%, biomass 1.7%, wind 4.4%, geothermal less than 1%, and solar less than 1%.

Activities, Labs, and Supplemental Information

Teacher's PowerPoint Presentation

A Teacher's (PowerPoint) presentation is provided on CD and online on the DOE Office of Nuclear Energy website to help you present chapter concepts to your class. Download the teacher presentation at: <http://energy.gov/ne/services/harnessed-atom>

Activity - Prediction

Before students read this chapter, ask them to make their own pie chart to predict what fuels or energy sources are used to make electricity in the United States. Compare predictions to the pie chart on page 14 of Lesson 2.

To get the most recent information for the pie chart on electricity generation go to www.eia.gov/tools/faqs/faq.cfm?id=427&t=3

Activity - Home Energy Audit

The primary out-of-class activity for Lesson 2 is the Home Energy Audit. Students will collect data on their energy use at home and answer response questions based on these data. This activity can be used as a grade and the basis for classroom discussion. The Home Energy Audit activity handout is provided later in Lesson 2.

Lab - Before Your Very Eyes

In order to understand how a generator works, students need to grasp the naturally occurring current flow in a magnet field. The lab Before Your Very Eyes quickly demonstrates the electrical current field that occurs between a magnet and copper. It can be done by the teacher or by students.

Labs - Make a Simple Motor and Make a Two-Pole Motor

These two labs give instructions that students can follow to make a simple motor.

Labs - Put Electrons on the Move and Make an Electromagnetic Generator

Depending on the availability of materials, students will construct one or more generators and produce electricity in the classroom. The labs provide the basis for understanding how power plants produce electricity. Both lab plans are provided later in Lesson 2. In both labs, students can see the relationship between magnetism and the induction of electrical current by making a simple generator. The Put Electrons on the Move generator is an AC generator, meaning the voltage generated at the two ends of the wire alternates between positive and negative as the magnet shifts in the container. This activity can be done by each of your students or in groups of students, depending on the availability of supplies. Make sure students are aware of and follow safety precautions on lab sheet when soldering. The Put Electrons on the Move lab is adapted from Dr. Jonathan Hare, "Physics on a Shoestring" *Journal of Physics Education*, Vol. 37, 2002 and his website www.creative-science.org.uk

Lab - Build Your Own Turbine

This lab gives students instructions to make a turbine (a.k.a., pinwheel) and see how they work. This activity can be done by individual students or in groups. Students will build and test their own turbines to use the kinetic energy of flowing air, water, and steam. Make sure students are aware of and follow precautions regarding steam.

Videos

Smart Grid – An 8½ minute video that gives an excellent overview of the complexity of bringing electricity to people and describes how a smart grid works can be found at www.pbs.org/wgbh/nova/tech/power-grid.html

Toward a Smart Grid - Written Q&A – This supplemental source of information could be assigned as an extension for more advanced students who could either write a short summary or report verbally to the class. Go to www.pbs.org/wgbh/nova/tech/toward-smart-electric-grid.html

Activity – Home Energy Audit

Your Electricity Company

1. What is the name of the company that generates the electricity you use in your home?

2. What energy source or sources does this company use to generate electricity?

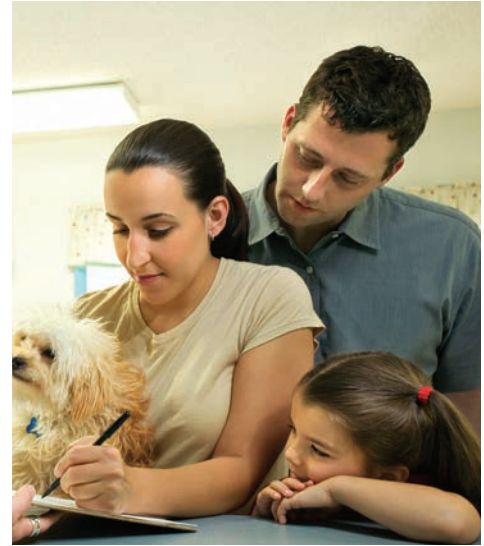

Energy Consumption

1. List the energy-consuming devices in your kitchen.

<hr/>	<hr/>
<hr/>	<hr/>
<hr/>	<hr/>
<hr/>	<hr/>

2. List the energy-consuming devices in your bathroom.

<hr/>	<hr/>
<hr/>	<hr/>
<hr/>	<hr/>
<hr/>	<hr/>

Heating and Cooling

1. Thermostat settings:

Cooling Season: Day _____ °F Night _____ °F
 Heating Season: Day _____ °F Night _____ °F

2. Are there any heat-emitting devices located near the thermostat? _____
3. Does your home have a programmable thermostat? _____
4. How is your home heated (natural gas/electricity/propane/wood-burning stove/solar)?

5. How is your home cooled (central air conditioner/window air conditioner/fans/opening windows)? _____
6. Number of times per year the furnace filter is changed. _____
7. Does your family use blinds and drapes to help control temperature in your home? _____
8. Does your home have storm windows and doors? _____

Lighting

1. Number of incandescent lightbulbs in your home. _____
2. Number of compact fluorescent lightbulbs in your home. _____
3. Number of LED (light-emitting diode) lightbulbs in your home. _____

Water Heating and Use

1. If you wash your dishes by hand, do you leave hot water running to rinse as you wash? _____
2. Number of times your dishwasher is run per week. _____
3. How often is the energy saving feature on the dishwasher is used? (circle one)
0% 25% 50% 75% 100%
4. Number of loads of laundry washed at home per week. _____
5. Percentage of the laundry loads washed in cold water. (circle one)
0% 25% 50% 75% 100%
6. Total number of baths taken by all family members each week. _____
7. Total number of showers taken by all family members each week. _____
8. Average length of each shower. _____
9. Is your water heater wrapped with an insulation blanket? _____
10. A setting of 120° is adequate for most home water heaters. What is the temperature setting for your water heater? _____
11. When you are away on vacation, do you turn the thermostat on your water heater to its lowest setting? _____
12. Does the building where you live have solar panels for heating water? _____

Connections and Reflections

1. Describe two things your family does to save energy at home.

2. Describe one way your family could reduce electricity consumption at home. How you might get everyone in your family to participate?

3. What are two ways to be comfortable at home without adjusting the temperature and using more energy?

4. What can your family do to reduce your hot water use?

5. If you could change one thing about the way you use energy, what would it be and why?

Bonus Activity

Ask a local business if you can do an energy audit for them. Make a report for the business with suggestions and ideas they can use to improve energy conservation and save money.

Lab – Before Your Very Eyes

Materials

- PVC pipe, about 1 meter (3.2 feet) long and 2 cm (.8 inch) diameter or larger
- Copper pipe, about 1 meter (3.2 feet) long and 2 cm (.8 inch) diameter or larger (Pipes can be nearly any size as long as both are about the same.)
- Neodymium disk magnet (also called super magnet)

Procedure

1. Hold the PVC pipe vertically. Drop the magnet into the pipe.
2. Observe the motion of the magnet in the pipe as gravity pulls it toward the floor.
3. Repeat the procedure using the copper pipe.

Questions

1. Was the magnet attracted to the PVC pipe? _____
Was it attracted to the copper pipe? _____
2. How was the movement of the magnet in the PVC and copper pipes different? _____

3. Why do you think the magnet behaved differently in the PVC and copper pipes? _____

4. Is this current similar to electrical currents produced by conductors at electric power plants? How? _____

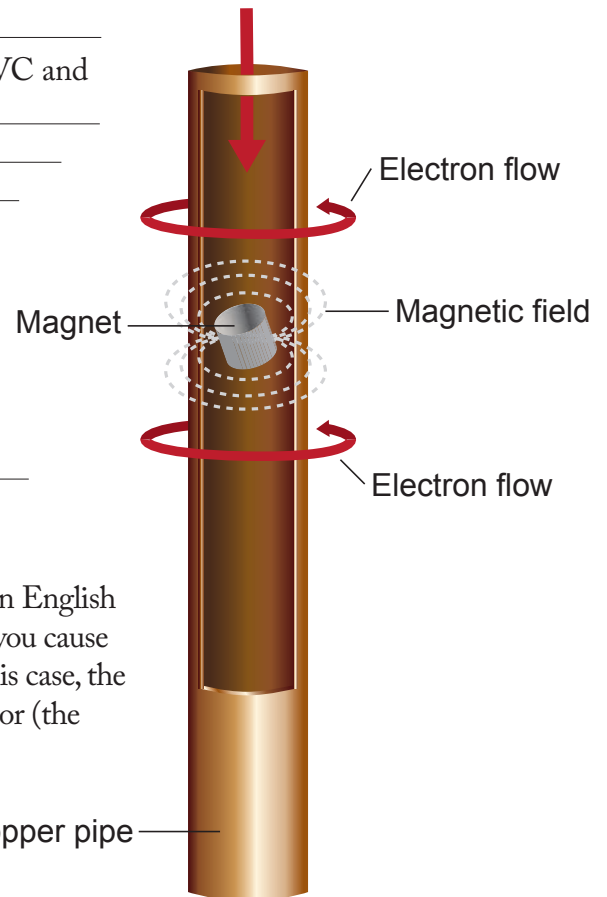

Faraday's Law of Induction

Michael Faraday's law of induction is working here. Faraday was an English scientist who lived from 1791—1867. He observed that any time you cause change in a magnetic field, an electrical current is generated. In this case, the magnetic field is changed as the magnet moves through a conductor (the copper pipe), creating an electron flow.

Note: A web cam and light can be used to record or project the falling magnet for the class.

Copper pipe

Lab – Before Your Very Eyes - Answers

Materials

- PVC pipe, about 1 meter (3.2 feet) long and 2 cm (.8 inch) diameter or larger
- Copper pipe, about 1 meter (3.2 feet) long and 2 cm (.8 inch) diameter or larger (Pipes can be nearly any size as long as both are about the same.)
- Neodymium disk magnet (also called super magnet)

Procedure

1. Hold the PVC pipe vertically. Drop the magnet into the pipe.
2. Observe the motion of the magnet in the pipe as gravity pulls it toward the floor.
3. Repeat the procedure using the copper pipe.

Questions

1. Was the magnet attracted to the PVC pipe? *No*
Was it attracted to the copper pipe? *No*
2. How was the movement of the magnet in the PVC and copper pipes different? *The magnet seems to slowly float downward in the copper pipe.*
3. Why do you think the magnet behaved differently in the PVC and copper pipes? *The resistance from the electric current generated by the magnet moving inside the copper acts like a brake to its downward drop, making the magnet seem to float. The electric currents that form as the magnet moves through the copper are caused by electromagnetic induction.*
4. Is this current similar to electrical currents produced by conductors at electric power plants? How? *Yes. It is similar. Electromagnetic induction is used to generate electricity at power plants. Moving a magnet through a copper pipe acts the same way as moving a coil of copper wire in a generator's magnetic field. Both generate an electric current.*

Faraday's Law of Induction

Michael Faraday's law of induction is working here. Faraday was an English scientist who lived from 1791—1867. He observed that any time you cause change in a magnetic field, an electrical current is generated. In this case, the magnetic field is changed as the magnet moves through a conductor (the copper pipe), creating an electron flow.

Note: A web cam and light can be used to record or project the falling magnet for the class.

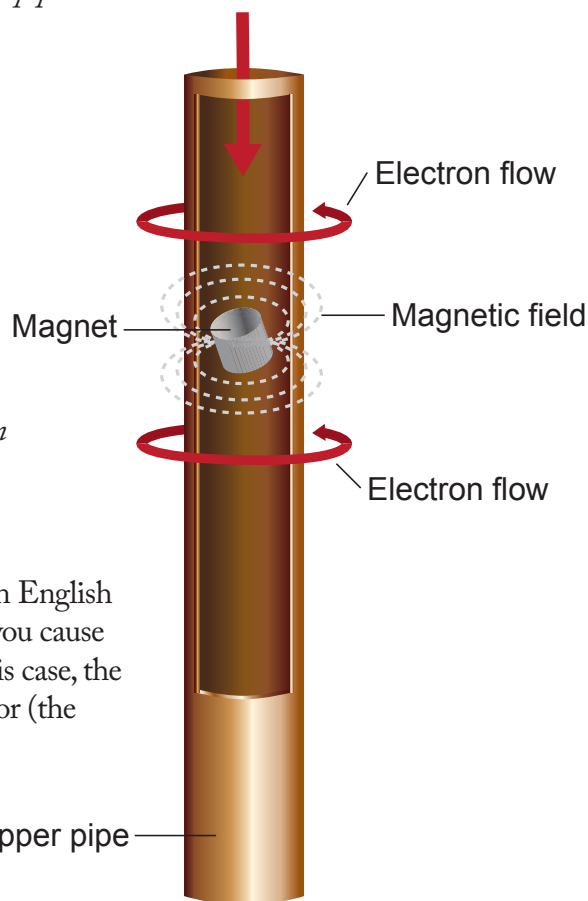

Lab – Make a Simple Motor

This activity also illustrates energy conversion and can be done by each student at his desk as a class activity led by the teacher. Also known as the homopolar motor, this activity should take about 10 minutes.

Materials

- D battery
- Neodymium disk magnet (also called super magnets) Everyday ceramic magnets will not work. You can buy neodymium magnets at electronic supply or craft stores or online.
- Copper wire, 18 gauge, remove insulation on ends
- 5 cm sheetrock screw

Procedure

1. Place the magnet on the head of the screw.
2. Turn the battery positive side down and hold with one hand. Using the other hand, allow the magnet to attract through the screw and attach to the battery.
3. Bend the wire into a shape that makes good contact with the negative terminal of the battery. Hold in place against the battery.
4. Touch the copper wire on the head of the screw and make small adjustments until it spins.

Questions

1. The battery has potential energy in what form? _____
2. Does this activity illustrate energy conservation? _____

3. What secondary energy source do we rely on most to run most of our machines and motors? _____

Note: If the screw doesn't start to spin soon after contact, the polarity of the magnet or battery should be reversed.

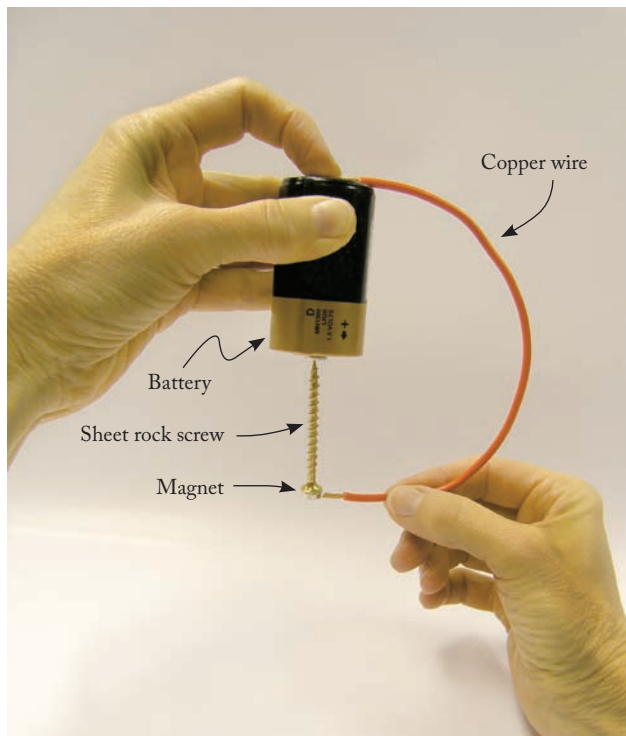

Lab – Make a Simple Motor - Answers

This activity also illustrates energy conversion and can be done by each student at his desk as a class activity led by the teacher. Also known as the homopolar motor, this activity should take about 10 minutes.

Materials

- D battery
- Neodymium disk magnet (also called super magnets) Everyday ceramic magnets will not work. You can buy neodymium magnets at electronic supply or craft stores or online.
- Copper wire, 18 gauge, remove insulation on ends
- 5 cm sheetrock screw

Procedure

1. Place the magnet on the head of the screw.
2. Turn the battery positive side down and hold with one hand. Using the other hand, allow the magnet to attract through the screw and attach to the battery.
3. Bend the wire into a shape that makes good contact with the negative terminal of the battery. Hold in place against the battery.
4. Touch the copper wire on the head of the screw and make small adjustments until it spins.

Questions

1. The battery has potential energy in what form? (*Chemical*)
2. Does this activity illustrate energy conservation? Why or why not? [*Yes. Chemical (potential) energy changes to electrical energy, which changes to mechanical (kinetic) energy.*]
3. What secondary energy source do we rely on most to run most of our machines and motors? (*Electricity*)

Note: If the screw doesn't start to spin soon after contact, the polarity of the magnet or battery should be reversed.

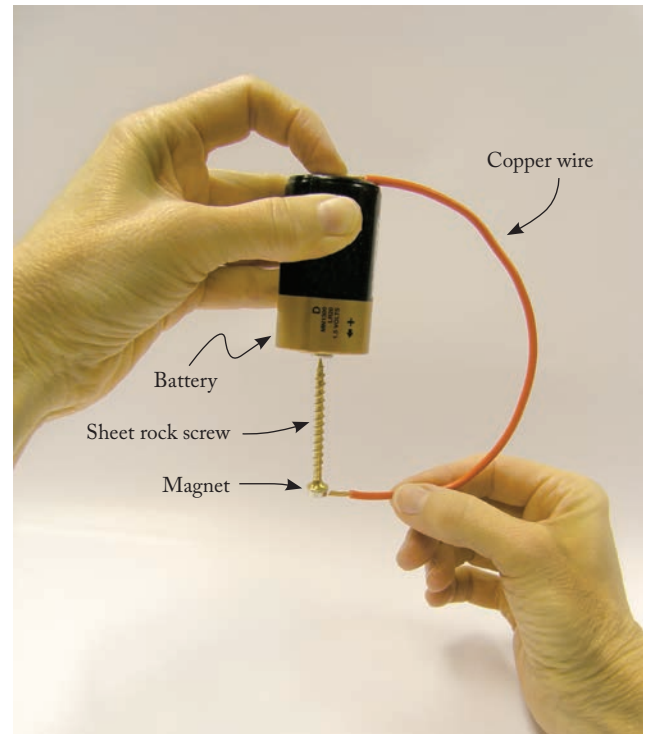

Lab – Make a Two-Pole Motor

Materials

- 80 cm #20 enameled copper wire
- Fine sandpaper
- Paperclips
- Thumbtacks or screws
- Masking tape
- Magnets (1")
- Hammer
- Pliers
- 2 pieces of enameled copper wire to connect motor and battery
- 10 cm x 10 cm piece of thin wood
- D-cell battery

Procedure

I. Make a Frame

1. Bend large end of paper clip.

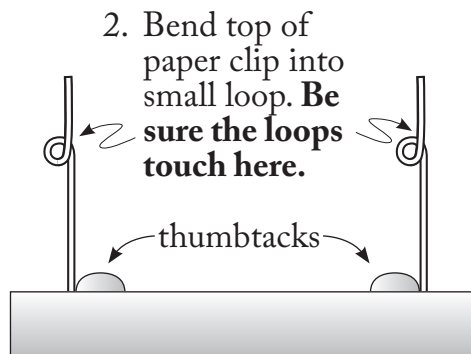

3. Attach the loops to the board with the thumbtacks holding down the paper clip through the end that was not bent up.

II. Make an Armature

4. Make the 80 cm of copper wire into a coil. Be sure the ends of the wire stick out at the center of the coil. Sandpaper the enamel coating off the ends of the armature.

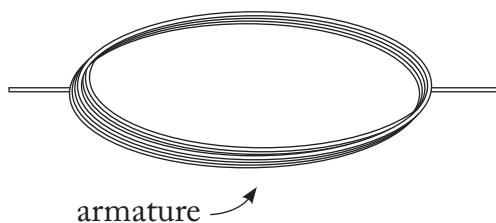

5. Make sure the ends of the wire are long enough to fit between the paperclips, resting in the small loops you made.

III. Put the Motor Together

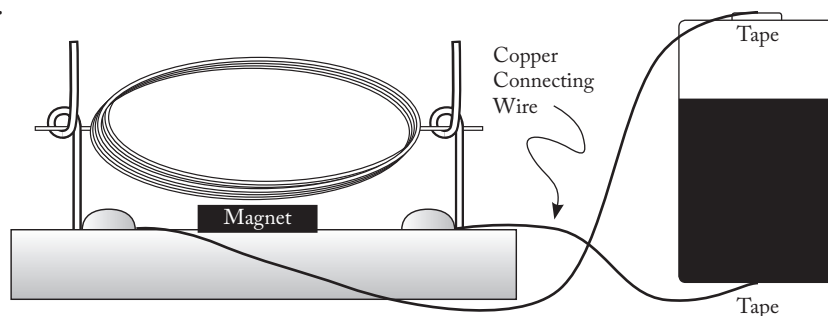

6. Sand the enamel coating off each end of each connecting wire.
 7. Attach one end of each connecting wire to the thumbtack part of the frame. Attach the other end of each wire to the battery as shown.
 8. Put the magnet under the armature.
 9. Gently spin the armature to get the motor started.
- Note:** You may need to press the wire to the battery with your fingertips to make sure there is good contact.

Lab – Put Electrons on the Move

(Adapted from an activity by Dr. Jonathan Hare, University of Sussex)

Materials

- 35mm film cans, pill bottles, or plastic spice bottles with plastic lids
- Coil of thin, insulated copper wire
- LED (light emitting diodes)
- Strong magnets (rare earth neodymium type)

Caution:

Even tiny neodymium magnets are powerful and can cause blood blisters and other injuries if skin or other body parts are allowed to come between them.

- Cardboard
- Sandpaper
- Insulation and transparent tapes
- Soldering tool and solder

Procedure

1. Cut two cardboard circles with centers cut to snugly fit the plastic bottle. Space the circles about 2 cm apart. Wind a few turns of insulation tape on the edge of the circles to hold them in place.



Put Electrons on the Move (continued)

2. Wind 500 to 1,000 turns of wire around the center of the bottle. Leave about 10 cm of wire free at each end of the coil. Wrap a layer of transparent tape to hold the wire in place.
3. Use sandpaper to remove some of the insulation from the ends of the free wires. Connect the ends to the LED. Solder the connections.* Use some transparent tape to secure the LED to the bottom of the bottle.

Caution:

A soldering iron can heat to 400°C. It can burn your skin or start a fire.

Safe Handling of a Heated Soldering Iron:

- Unplug the iron when it is not in use.
- Keep the power cord away from foot traffic or work bench movements.
- Always return the soldering iron to its stand when not in use. Never lay it on the work bench.
- Use in a well-ventilated area.
- Do not breathe the smoke that forms as you melt solder. It can be harmful. Avoid it by keeping your head to the side of, not above, your work.
- Solder contains lead, a poisonous metal. Wash your hands after handling the materials.



4. Put the magnet in the bottle, and snap on the lid. Use thumb and forefinger on the ends of the bottle to hold the lid. Shake and the LED will light.

Alternatives

- Have groups of students increase the voltage by increasing the number of turns of wire on the coil.
- Vary the type of wire used: Thick wire will lose power more slowly than fine wire but the coil needs to be larger.

Questions

1. Ask students to investigate the difference in results using different magnets. Does using more than one magnet (joined together) at a time make a difference in the light? _____

2. Do you get twice as much light with twice the number of magnets? _____

Put Electrons on the Move - Answers

- Wind 500 to 1,000 turns of wire around the center of the bottle. Leave about 10 cm of wire free at each end of the coil. Wrap a layer of transparent tape to hold the wire in place.
- Use sandpaper to remove some of the insulation from the ends of the free wires. Connect the ends to the LED. Solder the connections.* Use some transparent tape to secure the LED to the bottom of the bottle.

Caution:

A soldering iron can heat to 400°C. It can burn your skin or start a fire.

Safe Handling of a Heated Soldering Iron:

- Unplug the iron when it is not in use.
- Keep the power cord away from foot traffic or work bench movements.
- Always return the soldering iron to its stand when not in use. Never lay it on the work bench.
- Use in a well-ventilated area.
- Do not breathe the smoke that forms as you melt solder. It can be harmful. Avoid it by keeping your head to the side of, not above, your work.
- Solder contains lead, a poisonous metal. Wash your hands after handling the materials.



- Put the magnet in the bottle, and snap on the lid. Use thumb and forefinger on the ends of the bottle to hold the lid. Shake and the LED will light.

Alternatives

- Have groups of students increase the voltage by increasing the number of turns of wire on the coil.
- Vary the type of wire used: Thick wire will lose power more slowly than fine wire but the coil needs to be larger.

Questions

- Ask students to investigate the difference in results using different magnets. Does using more than one magnet (joined together) at a time make a difference in the light? *Results will vary. More magnets should make the light brighter.*
- Do you get twice as much light with twice the number of magnets? *Yes.*

Lab – Make an Electromagnetic Generator

Materials

- Hand-crank generator
- Two wires with alligator clips
- Small light bulb or electric motor

Procedure

Part 1 –

- Use the wires and alligator clips to attach the hand crank generator to a light bulb or a motor.
- Turn the crank.
- Document what you observe.
- Try turning the crank faster or slower. What happens?

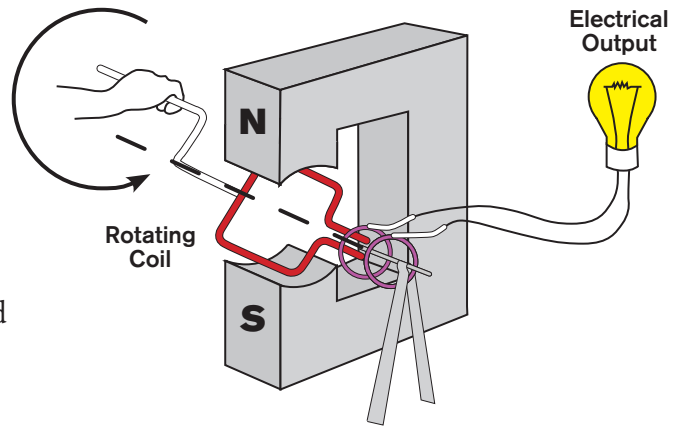

Questions

1. Briefly describe to your lab partner how the hand crank generates electricity. Explain why you did or did not get different results by turning the crank faster or slower. _____

2. Compare the hand crank to a power plant. What does the hand crank represent? What does the energy you supply represent? _____

3. How does what you observed relate to the first law of thermodynamics? _____

Part 2 –

- Find a way to use the wires, alligator clips, and two hand cranks to demonstrate the second law of thermodynamics.

Questions

1. Describe how you used your supplies to prove that every time energy is converted from one form to another there is less energy available to do work. _____

2. Where is energy being lost? Where does it go? Why can't you use the lost energy to do work?

Extensions and Alternative Activities

- List all the activities you have done so far today and decide where kinetic and potential energy were present.
- Research how you can save energy at home.
- Current induces magnetic field. Demonstrate how a compass will change direction around a wire carrying a current.

Faraday's Law of Induction

Electromagnetic induction underlies the operation of power plant generators. You can feel the resistance to the change in the magnetic field when you crank the handle of a generator. If there were no resistance, the generator would spin freely as you generate electricity. But because you already know that there is “no free lunch” in energy conversion, you probably know that won't happen when we make electricity.

Lab – **Make an Electromagnetic Generator - Answers**

Materials

- Hand-crank generator
- Two wires with alligator clips
- Small light bulb or electric motor

Procedure

Part 1 –

- Use the wires and alligator clips to attach the hand crank generator to a light bulb or a motor.
- Turn the crank.
- Document what you observe.
- Try turning the crank faster or slower. What happens?

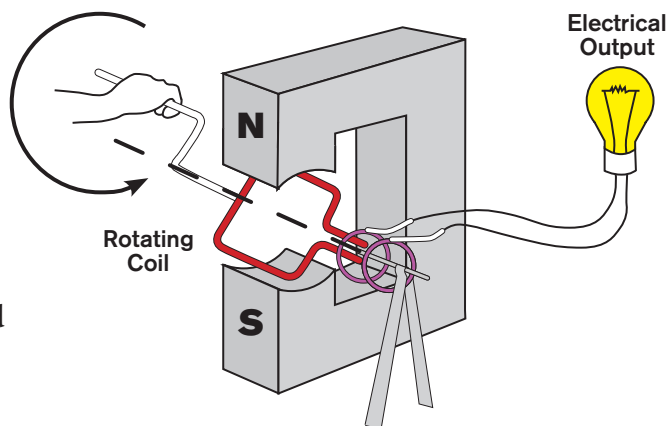

Questions

1. Briefly describe to your lab partner how the hand crank generates electricity. Explain why you did or did not get different results by turning the crank faster or slower. *Turning the generator moves the copper coil within the magnetic field and produces a flow of electrons. A steady flow produces a steady light. Decreasing or increasing the crank time varies the amount of electricity generated and directly affects the speed of electron flow.*
2. Compare the hand crank to a power plant. What does the hand crank represent? What does the energy you supply represent? *The hand crank represents the turbine. The energy supplied by the student who turns the crank represents the steam that turns the turbine. This energy comes from the fuel that generates the heat to boil water at a power plant.*
3. How does what you observed relate to the first law of thermodynamics? *The first law of thermodynamics shows us that energy can be converted from one form to another, but it can't be created or destroyed. The mechanical energy of turning the crank converts into an equal amount of energy in other forms—electrical energy, light, sound, and heat energy.*

Part 2 –

- Find a way to use the wires, alligator clips, and two hand cranks to demonstrate the second law of thermodynamics.

Questions

1. Describe how you used your supplies to prove that every time energy is converted from one form to another there is less energy available to do work. *Results will vary. One scenario could involve connecting the alligator clips between two hand crank generators. With both handles aligned vertically, one student gives one full crank of a generator, while the other student allows the second generator handle to move freely. By recording how many rotations are matched or not matched, students should be able to prove the second law of thermodynamics: When useable energy is converted to another form, there is always some non-useable energy.*

2. Where is energy being lost? Where does it go? Why can't you use the lost energy to do work?

The mechanical energy of the crank is converted into electrical energy, light, sound, and heat energy. Heat energy from the bulb radiates into the surrounding air and is no longer concentrated or available to do work. The second law of thermodynamics states there will always be energy from a conversion that's lost and no longer available to do work.

Extensions and Alternative Activities

- List all the activities you have done so far today and decide where kinetic and potential energy were present.
- Research how you can save energy at home.
- Current induces magnetic field. Demonstrate how a compass will change direction around a wire carrying a current.

Faraday's Law of Induction

Electromagnetic induction underlies the operation of power plant generators. You can feel the resistance to the change in the magnetic field when you crank the handle of a generator. If there were no resistance, the generator would spin freely as you generate electricity. But because you already know that there is “no free lunch” in energy conversion, you probably know that won't happen when we make electricity.

Lab – **Build Your Own Turbine**

This activity can be done by individual students or in groups. Students will build and test their own pinwheel “turbines” to use the kinetic energy of flowing air, water, and steam.

Materials

- 13 x 13 cm (5 inch x 5 inch) piece of paper or plastic overhead transparency sheets
- Crayons or markers (optional)
- Pencil
- Scissors
- Beads
- Thumb tack or push pin
- Pencils with eraser
- Pitcher, water, and bowl if there is no sink with running water
- Tea kettle and heat source to generate steam

Procedure

1. Using the template at end of this lab, students may color each triangle with a marker or crayon.

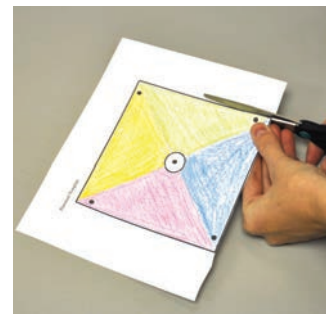
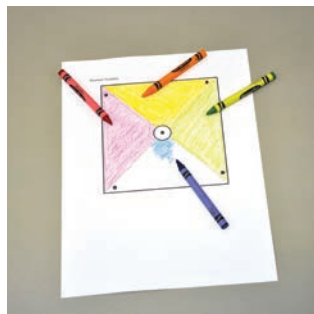

2. Cut the square and diagonal lines, stopping at the circle in the center.
3. Fold one corner of each square into the center, overlapping the dots in each corner over the dot in the center of the pinwheel.

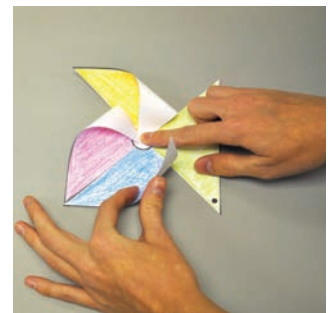
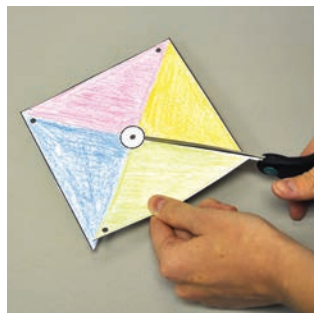

4. Secure the center with a pushpin and slide a bead on the tip of the pin. The bead allows spinning by reducing friction.
5. Lay the stick on a flat surface and push the pin into the pencil’s eraser.

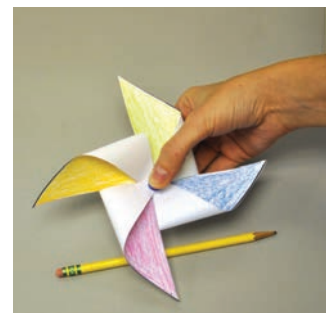
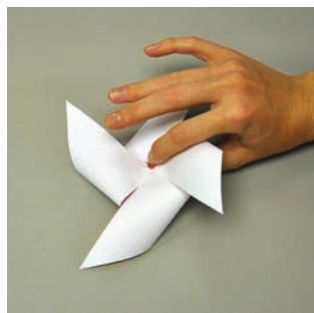

Build Your Own Turbine (continued)**Questions**

1. Blow on the pinwheel. Ask, "What type of primary energy sources harness moving air?"
2. One group may now demonstrate what happens when their pinwheel is held under running water. What type of primary energy source is harnessed now?
3. Another group can demonstrate what happens when their pinwheel is held over the steam from a boiling tea kettle. What type of primary energy is converting energy now?

Caution:

Steam can burn your skin. Use caution when you put your turbine over the steam. Keep your hands away from the heat source and the steam. Hold your head the side of the steam. Do not allow any part of your body to contact the steam.

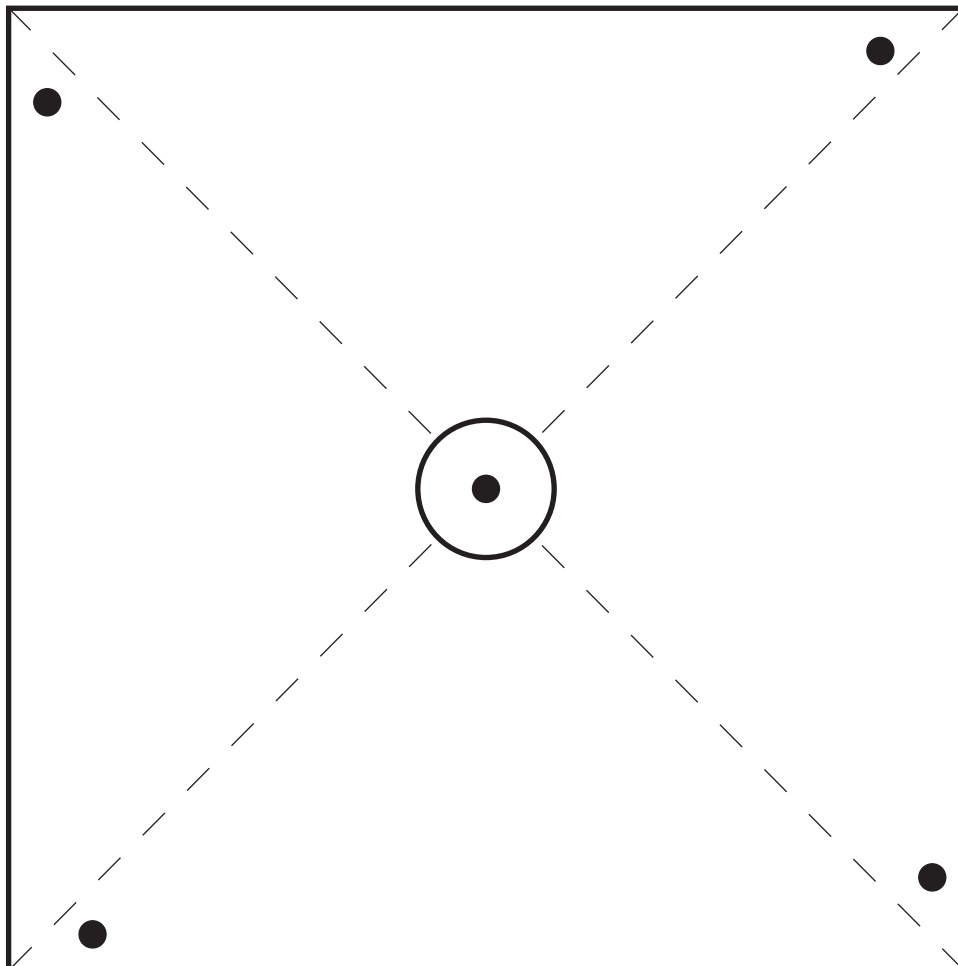

Build Your Own Turbine (continued) - Answers

Questions

1. Blow on the pinwheel. Ask, "What type of primary energy sources harness moving air?"
Wind energy turns turbines called windmills.
2. One group may now demonstrate what happens when their pinwheel is held under running water.
What type of primary energy source is harnessed now? *Flowing water is harnessed in a hydroelectric dam to turn turbines. Also, tidal energy uses the moving tides of the ocean to turn turbines.*
3. Another group can demonstrate what happens when their pinwheel is held over the steam from a boiling tea kettle. What type of primary energy is converting energy now? *Steam is not a primary energy source. Heat from fossil fuels or nuclear fuels are primary energy sources that heat water and convert it to steam. The steam then turns a turbine. All turbines mentioned here spin a coil of wire in a generator to make electricity.*

Caution:

Steam can burn your skin. Use caution when you put your turbine over the steam. Keep your hands away from the heat source and the steam. Hold your head the side of the steam. Do not allow any part of your body to contact the steam.

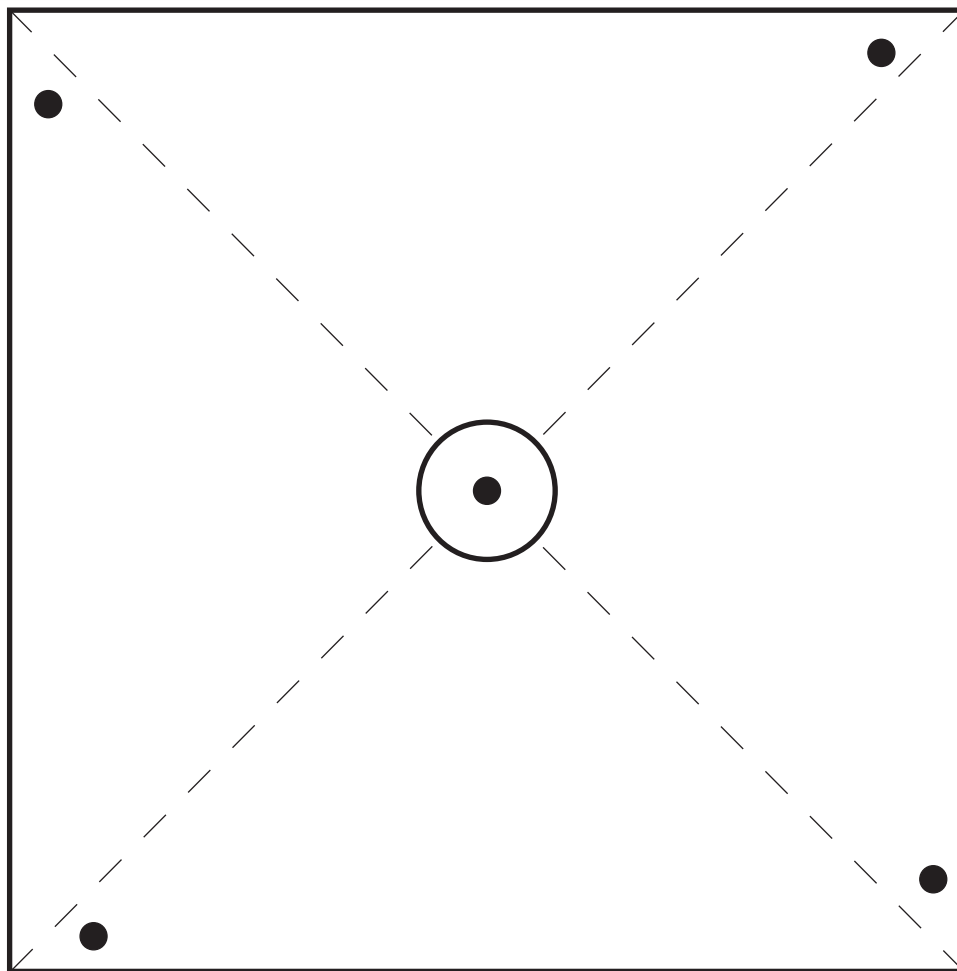

ATOMS AND ISOTOPES

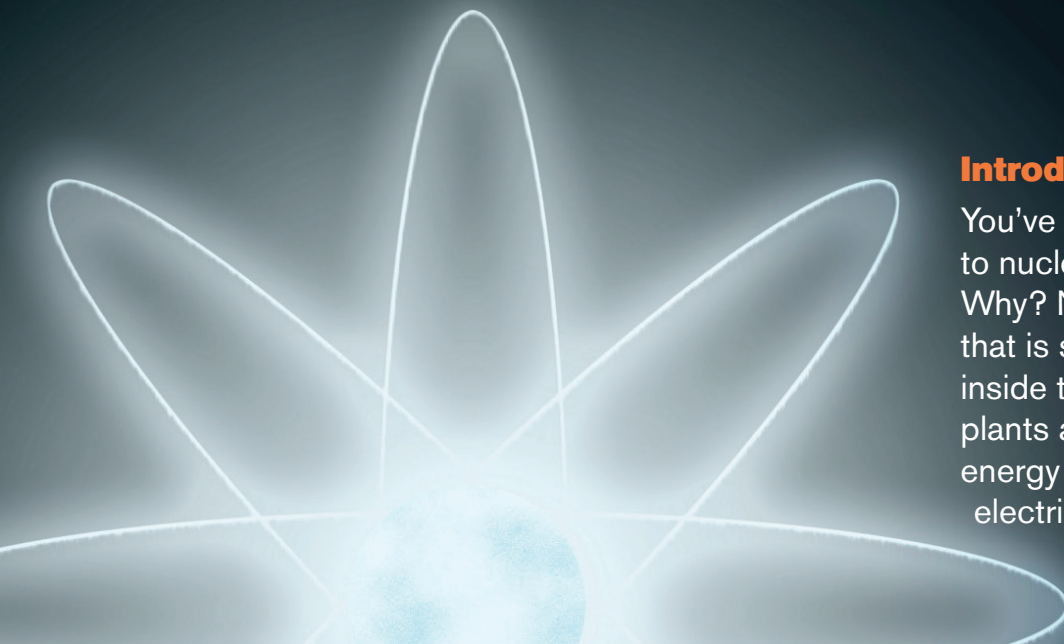

Introduction

You've probably heard people refer to nuclear energy as "atomic energy." Why? Nuclear energy is the energy that is stored in the bonds of atoms, inside the nucleus. Nuclear power plants are designed to capture this energy as heat and convert it to electricity. In this lesson, we will look closely at what atoms are and how atoms store energy.

TOPICS:

Matter

Molecules

Elements

Chemical reaction

Periodic Table

The atom

Parts of an atom

Isotopes

Unstable isotopes

Scientists and discoveries

What are molecules, elements, and atoms?

To understand nuclear energy, it is important to first understand **atoms**, which are the building blocks of **matter**.

What do you suppose would happen if you took a lump of salt and began to break it up into smaller and smaller pieces? Sooner or later you would get pieces so small that you wouldn't be able to see them. The smallest piece that is still salt is called a **molecule**. Everything is made of molecules – sugar, salt, tables, chairs, and even the cells of your own body. However, all molecules are not alike. A molecule of sugar is different from a molecule of salt. But that is not the whole story.

What is an atom?

Molecules are made of even smaller parts, which are called atoms. An atom is the smallest part of any element that has all the properties of that element. Atoms are so small that it takes millions of them to make a speck of dust.



Image Credit: Jon Reis

A molecule consists of two or more atoms bonded together. In the model built here, the black spheres represent carbon atoms. The connectors that join the spheres represent the chemical bonds.

Teachers' Notes:

Atoms are much too small to be seen with the naked eye, so much of what we know about them is based on indirect observation. Students should understand the difference between direct and indirect observation. Direct observation is seeing something yourself. Indirect observation requires observing its properties and effects without seeing the object or the activity itself. Ask students for examples.

Lesson 3 ATOMS AND ISOTOPES

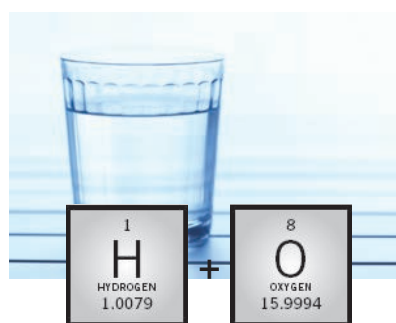
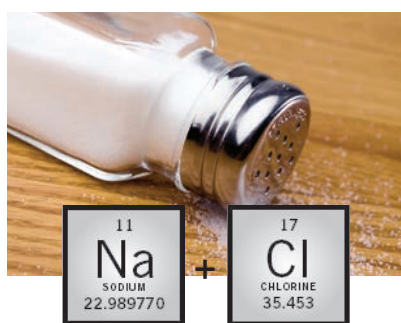
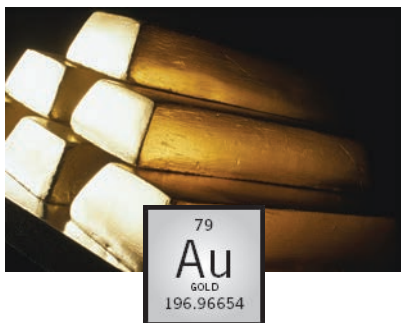

Today, we know that at least 92 different kinds of atoms occur in nature. More kinds of atoms have been made by scientists. Each of these different kinds of atoms is a unique **element**.

Combining atoms of different elements – or atoms of the same element – forms molecules. The kind of molecule depends on which atoms combine. This combining is called a **chemical reaction**. In chemical reactions, atoms do not change. Instead, they combine with or separate from other atoms.

For example, gold is an element. A bar of pure gold contains only atoms of one element: gold. On the other hand, table salt is a combination of more than one kind of atom. It is made of atoms grouped into molecules. A molecule of table salt has one atom of the element sodium and one atom of the element chlorine. Another familiar example is water. A molecule of water has two atoms of hydrogen and one atom of oxygen. That is why chemists call water H_2O .

Atoms are the basic building blocks of everything in the universe. They are the smallest particles of matter that still have all of the properties of an element.

Think about it...



The word “atom” comes to us from a Greek philosopher named Democritus. Around 420 BCE, Democritus wondered, “What is the smallest piece you could cut something like a piece of gold into?” Although he did not have a laboratory, he realized that at some point, the gold would become too small to cut any more. He called the smallest piece *atomos*, which means “indivisible,” or “cannot be cut.” He proposed that all matter was made of these infinitely small particles that cling together in different combinations to make things. Democritus couldn’t see atoms. But he understood that they must exist.

In 1803, English chemist John Dalton began to question ideas about structure of matter. He proposed an atomic theory that said

- Elements are made of very small particles—atoms
- For each element, all the atoms have the same size, mass, and properties
- Atoms cannot be divided, created, or destroyed
- Atoms combine to form chemical compounds
- In chemical reactions, the atoms in a compound rearrange or separate

Dalton performed experiments and found that matter seemed to consist of 35 elements that he could identify.

Teachers’ Notes:

There is some academic debate about the number of “naturally occurring” elements. We know for sure the 92 elements exist in nature. Physical evidence indicates that at least two others are present from time to time because they are part of the decay chain of some naturally occurring elements. Students may become confused because the Periodic Table indicates 118 elements (or more, depending on how current the version). The reason for the discrepancy is that scientists have produced small amounts of heavy elements in the laboratory and not all tables show them.

Teachers’ Notes:

Democritus’s theory was a brilliant insight. However, at that time most people believed that there were only four elements: earth, air, water, and fire. If the balance between these elements could be changed, perhaps a metal like lead could be changed into gold. This became a goal of experiments until about 2000 years later, after the Renaissance. Although the experiments were based on the wrong idea, the people doing them made advances in chemistry and discovered many real chemical elements.

Teachers' Notes:

See the Reading Review that follows for models of the atom that students can label.

Teachers' Notes:

In this curriculum, we are only discussing key particles (proton, neutron, and electron). However, high energy research has identified the even smaller quarks, neutrinos, and bosons. If your students are interested, you may want to assign an investigation and class report on these small elementary particles.

What are the parts of an atom?

As small as atoms are, they are made of even smaller particles. There are three basic particles in most atoms – protons, neutrons, and electrons.

Protons carry a positive electrical charge (+). **Neutrons** have no electrical charge. Protons and neutrons together make a dense bundle at the center of an atom. This bundle is called the **nucleus**.

Electrons have a negative electrical charge (-) and move around the nucleus. They are extremely small compared to the other parts of an atom. Normally, an atom has the same number of protons and electrons. If the positively charged protons and the negatively charged electrons are equal in number, they balance each other. As a result, the atom has no electrical charge.

We use the number of protons in an atom to identify it. For instance, an atom of oxygen has 8 protons in its nucleus. Carbon has 6, iron 26, gold 79, lead 82, uranium 92, and so on.

How was the periodic table developed?

Imagine discovering a few pieces of a jigsaw puzzle, but not knowing what the

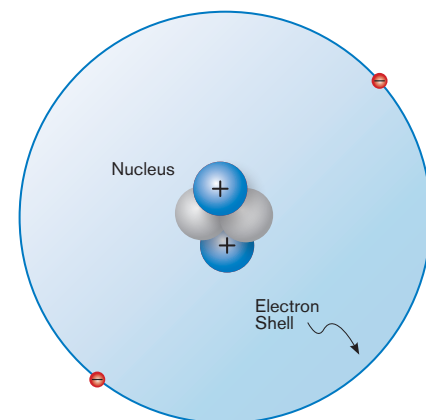
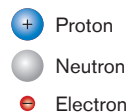
Structure of an Atom

The Rutherford-Bohr model provides a simple representation of the structure of an atom. Modern physics theory places the movement of electrons in a cloud of possible orbits around the nucleus.

picture on the puzzle was supposed to look like, or even if it would make a picture. Now imagine that jigsaw puzzles had not been invented yet. Could you solve it?

That's similar to the challenge that scientists in the 1800s faced. They had discovered chemical elements but did not know how, or if, they fit together. Many elements were missing. No one had ever tried to make a chart that organized the information. But science is a process of organizing what we know to help us make sense of it all.

Building on what was being learned about atomic structure, Dmitri Mendeleev began sorting the known elements into categories. His sorting became the foundation of the



Image Credit: University of Tennessee

If you could enlarge an atom to the size of a stadium, its nucleus would be about the size of a grape on the mid-field stripe. Electrons would be smaller than grains of salt whirling around the upper deck. And the rest of the stadium would be empty space.

Periodic Table of the Elements

1A		2A		3A - 8B										1B		2B		3A		4A		5A		6A		7A		8A																																								
Atomic Number		Atomic Number		Atomic Number										Atomic Number		Atomic Number		Atomic Weight (aka Atomic Mass)		Atomic Number		Atomic Number		Atomic Number		Atomic Number		Atomic Number		Atomic Number																																						
1 H 1.00794 Hydrogen	3 Li 6.941 Lithium	4 Be 9.012182 Beryllium	11 Na 22.98976 Sodium	19 K 39.0983 Potassium	21 Sc 44.955912 Scandium	22 Ti 47.867 Titanium	23 V 50.9415 Vanadium	24 Cr 51.9961 Chromium	25 Mn 54.938045 Manganese	26 Fe 55.845 Iron	27 Co 58.933195 Cobalt	28 Ni 58.6934 Nickel	29 Cu 63.546 Copper	30 Zn 65.38 Zinc	31 Ga 69.723 Gallium	32 Ge 72.64 Germanium	33 As 74.92160 Arsenic	34 Se 78.96 Selenium	35 Br 79.904 Bromine	36 Kr 83.798 Krypton	41 Sc 44.955912 Scandium	42 Ti 47.867 Titanium	43 V 50.9415 Vanadium	44 Cr 51.9961 Chromium	45 Mn 54.938045 Manganese	46 Fe 55.845 Iron	47 Co 58.933195 Cobalt	48 Ni 58.6934 Nickel	49 Cu 63.546 Copper	50 Zn 65.38 Zinc	51 Ga 69.723 Gallium	52 Ge 72.64 Germanium	53 As 74.92160 Arsenic	54 Se 78.96 Selenium	55 Br 79.904 Bromine	56 Kr 83.798 Krypton	57-103 See Below Lanthanides	71 Lu 174.9668 Lutetium																														
37 Rb 85.4678 Rubidium	38 Sr 87.62 Strontium	39 Y 88.90585 Yttrium	40 Zr 91.224 Zirconium	41 Nb 92.90638 Niobium	42 Mo 95.96 Molybdenum	43 Tc [98] Technetium	44 Ru 101.07 Ruthenium	45 Rh 102.90550 Rhodium	46 Pd 106.42 Palladium	47 Ag 107.8682 Silver	48 Cd 112.411 Cadmium	49 In 114.818 Indium	50 Sn 118.710 Tin	51 Sb 121.760 Antimony	52 Te 127.60 Tellurium	53 I 126.90447 Iodine	54 Xe 131.283 Xenon	55 Cs 132.9054519 Cesium	56 Ba 137.327 Barium	57-103 See Below Actinides	71 Lu 174.9668 Lutetium	72 Hf 178.49 Hafnium	73 Ta 180.94788 Tantalum	74 W 183.84 Tungsten	75 Re 186.207 Rhenium	76 Os 190.23 Osmium	77 Ir 192.217 Iridium	78 Pt 195.084 Platinum	79 Au 196.966569 Gold	80 Hg 200.59 Mercury	81 Tl 204.3833 Thallium	82 Pb 207.2 Lead	83 Bi 208.98040 Bismuth	84 Po [209] Polonium	85 At [210] Astatine	86 Rn [222] Radon	87 Fr [223] Francium	88 Ra [226] Radium	89 Ac [227] Actinium	90 Th 232.03806 Thorium	91 Pa 231.03588 Protactinium	92 U 238.02891 Uranium	93 Np [237] Neptunium	94 Pu [244] Plutonium	95 Am [243] Americium	96 Cm [247] Curium	97 Bk [247] Berkelium	98 Cf [251] Californium	99 Es [252] Einsteinium	100 Fm [257] Fermium	101 Md [258] Mendelevium	102 No [259] Nobelium	103 Lr [262] Lawrencium	104 Rf [261] Rutherfordium	105 Db [262] Dubnium	106 Sg [263] Seaborgium	107 Bh [264] Bohrium	108 Hs [265] Hassium	109 Mt [266] Meitnerium	110 Ds [268] Darmstadtium	111 Rg [269] Roentgenium	112 Cn [285] Copernicium	113 Uut [285] Ununtrium	114 Fl [289] Flerovium	115 Uup [289] Ununpentium	116 Lv [293] Livermorium	117 Uus [294] Ununseptium	118 Uuo [294] Ununoctium

Actinides

Alkali Metals	Alkaline Earth Metals	Transition Metal	Basic Metal	Halogen	Noble Gas	Nonmetal	Semi-Metal	Lanthanides	Actinides
---------------	-----------------------	------------------	-------------	---------	-----------	----------	------------	-------------	-----------

Key:

The Periodic Table of the Elements tells the names, symbols, and number of protons in each element. It also shows the relationships among the elements. Elements are placed on the table in order of their atomic number and are arranged by their properties.

Periodic Table. By 1869, he had grouped elements by common properties. For example, elements with the smallest relative atomic mass went into the far left column. As he learned more about the chemical properties of the elements, Mendeleev grouped together metals, gases, and non-metals. His later tables even left gaps where Mendeleev suspected an element was missing, but he didn't know what it was yet. By the early 1890s, he and others had identified about 80 elements.

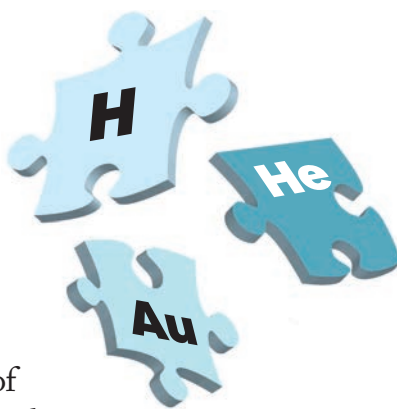

Today the Periodic Table includes 118 elements. Most occur in nature. But those with an atomic number higher than 92 (uranium) were made by scientists. In the future, the Periodic Table will likely continue to change based on new discoveries.

What is an isotope?

The nucleus in every atom of an element always has the same number of protons. For example, oxygen always has eight protons. However, the number of neutrons may vary. The different numbers of neutrons determine **isotopes** of the element.

To show which isotope of an element we are talking about, we total the number of protons and neutrons. Then we write the sum after the chemical symbol for the element. For example, in the nucleus of one isotope of uranium there are 92 protons and 143 neutrons. We refer to it as uranium-235 or U-235 ($92 + 143 = 235$). A second isotope of uranium, which contains three additional neutrons, is uranium-238 or U-238 ($92 + 146 = 238$).

The isotopes of an element have the same chemical properties, but they may differ in their nuclear properties.

What are stable and unstable isotopes?

Some proton-neutron combinations are more **stable** than others. Those that are stable do not change. Those that are **unstable** will change at some time.

What happens if you pull a rubber band to its limit? It will break, and the energy that was holding it together will be suddenly released.

As you just learned, the isotopes of an element have different numbers of neutrons in their centers. Some of these isotopes are like rubber bands that are stretched too far. We call these elements unstable isotopes. They break and change instantly to a different energy level.

Teachers' Notes:

In nuclear science, what is a daughter or daughter product?

Isotopes that are formed by the radioactive decay of some other isotope are called daughters or daughter products. For example, in the case of radium-226, there are ten successive daughter products, ending in the stable isotope lead-206.



Isotopes of an element are kind of like siblings in a family. Although siblings share many genetic characteristics, each child is unique.

Scientists observe that the elements do this to become more stable. Everything in the universe seeks these lower, more stable energy levels.

When a stretched rubber band breaks, you can't see its energy, but you can see the effect on the rubber band, which shoots across the room.

Sometimes similar things happen when unstable isotopes break down and new bonds are formed. Energy is released. And although all atoms are extremely small, the energy holding together their centers is the strongest force known in nature. It is called **strong force**. When the strong force is broken and a new bond is formed, the energy that is released is vast.

How was the energy of atoms discovered?

As scientists from around the world continued their experiments, they realized that the atom held large amounts of energy. In 1895, German physicist Wilhelm Roentgen discovered that an invisible energy was given off by an electrical current inside a vacuum tube. He called this unknown energy an “x ray” because it had no name. In 1896, French physicist Henri Becquerel observed that uranium gave off a similar energy. French chemist Marie Curie studied these “uranium rays” and discovered what they were: radioactivity. She realized that the energy came from within the atom itself.

In 1904, British physicist Ernest Rutherford recognized that, “If it were ever possible to control the rate of

disintegration of radio elements, an enormous amount of energy could be obtained from a small amount of matter.”

The following year, Albert Einstein proposed his famous theory

about the relationship between energy and matter: $E=mc^2$ which means “energy equals mass times the speed of light squared.” This is a huge number. If correct, it confirmed that a vast amount of energy was contained within the atom.



Image Credit: NASA

Scientists released energy from the nucleus by splitting atoms about 20 years later. Experiments by Italian Enrico Fermi and a team of scientists surprised everyone, even Fermi himself. When he bombarded uranium with neutrons, he expected it to become heavier. Instead, the resulting elements were lighter in mass. German scientists Otto Hahn and Fritz Strassman also fired neutrons into uranium and were surprised to find lighter elements, like barium, in the leftover materials. Hahn and Strassman worked with Lise Meitner, from Austria. She observed that in her experiments, the mass of lighter elements almost, but not quite, equalled the total of the uranium mass. Meitner used Albert Einstein's equation $E=mc^2$ to show that lost mass had changed into energy.

Teachers' Notes:

How do the weak force and strong force help explain why such an enormous amount of energy is released when these forces are broken?

The repulsive Coulomb's force (weak force) and the nuclear strong force are the two strongest forces in nature. Even gravity is negligible by comparison, being 1029 times weaker. This helps explain why such an enormous amount of energy is released when these forces are broken.

Teachers' Notes:

Ask students if they know what the speed of light is.

186,000 miles/second
or 299,792,458 meters/
second.



Summary

Atoms are the smallest units of matter that have all the properties of an element. Atoms combine to form molecules. Atoms are composed of smaller particles known as protons, neutrons, and electrons.

Protons have a positive electrical charge, neutrons have no electrical charge, and electrons have a negative electrical charge. Protons and neutrons together form the nucleus or central mass of the atom. Electrons move around the nucleus.

The nucleus of each atom of a specific element contains the same number of protons, but the number of neutrons may vary. Isotopes of an element are identified by adding the number of protons and neutrons together and writing the sum next to the chemical symbol for the element.

Stable isotopes do not change. Unstable isotopes will change at some time.

The energy that holds the nucleus of an atom together is the strongest force known in nature.

The Periodic Table of the Elements gives the names, symbols, and number of protons for each element.

Many scientists have contributed to our knowledge of elements and atoms. They have come from many countries and have included both men and women. Some have been honored by having elements named after them.

LESSON PLAN

Lesson 3: Lesson Plan

Atoms and Isotopes

Overview

While this lesson may be a review for many students, this material is an important foundation for understanding nuclear reactions and nuclear energy. The chapter covers the make up of molecules, elements, atoms, isotopes, and the concept of stability. It also provides historical context for our current knowledge of atomic structure.

Concepts

- What is an atom?
- What are protons, neutrons, and electrons?
- What is an isotope?
- What are stable and unstable isotopes?
- Many scientists contributed to our understanding of atoms
- The Periodic Table gives the names, symbols, and atomic numbers of the elements

National Standards (Grades 5 – 8)

Science

NS. 5-8.2 As a result of their activities in Grades 5-8, all students should develop an understanding of

- Properties and changes of properties in matter
- Transfer of energy
- The properties of matter

Mathematics (Common Core)

8.EE.4 Perform operations with numbers expressed in scientific notation, including problems where both decimal and scientific notation are used. Use scientific notation and choose units of appropriate size for measurements of very large or very small quantities (e.g., use millimeter per year for seafloor spreading). Interpret scientific notation that has been generated by technology.

Objectives

Upon completing this lesson, students will be able to

- Describe the basic structure of matter
- Describe a molecule and an atom and name the parts of an atom
- Explain what an element is
- Explain what an isotope is
- Explain what the Periodic Table is and what information it provides
- State that the number of protons in the nucleus identifies the element

Key Terms / Vocabulary

atom – the smallest part of an element that has all the properties of that element

chemical reaction – a process in which the make-up of a substance is changed to form another substance; a process that involves changes in the structure and energy content of atoms, molecules, or ions, but not their nuclei

electron – the smallest existing particle with a negative electrical charge; one of the three basic types of particles that make up an atom; particles that orbit the nucleus of an atom

element – one of more than 100 simple substances that cannot be chemically broken down and of which all matter is composed

emit – to send out or put forth; shooting out

isotopes – atoms of the same element that have equal numbers of protons but different numbers of neutrons; examples are uranium-235 and uranium-238

mass – the amount of matter that makes up an object

matter – every substance that takes up space; something physical

molecule – the smallest part of a substance that keeps all the characteristics of a substance and is composed of one or more atoms

neutron – a particle that appears in the nucleus of all atoms except hydrogen atoms; one of the three basic particles that make up the atom; has no electrical charge

nuclei – the plural form of nucleus

nucleus – the central part of an atom that contains protons, neutrons, and other particles

proton – an extremely small particle or bit of matter located in the nucleus and carrying one positive charge of electricity; one of the three particles that make up an atom

stable isotope – an isotope that does not undergo change

strong force – the strongest known force; the interactions within the nucleus of an atom that hold its nucleus together

unstable isotope – a radioactive isotope that will undergo change

Lesson Three – Chapter Outline

Matter

- Molecules
- Elements
- Chemical reaction

The Atom

- The parts of an atom

Periodic Table

Isotopes

- Stable and unstable isotopes

Scientists

- Contributions to our understanding of the atom

Reading

Reading for this lesson in the student reader can be assigned as homework prior to this class session, or it can be read in class as guided reading.

Performance Assessment and Extensions

A Reading Review Exercise follows that you can reproduce or project for your class. The labs and activities that follow include inquiry-based questions that can be used to assess student learning. Accompanying this lesson is a PowerPoint lecture with a review that can be used as an interactive assessment. For a project-based assessment, have students create a blog, podcast, or video on a topic from this lesson.

Lesson 3 Reading Review Exercise

A. Write the word that best fits the definition given.

1. _____ the smallest unit of matter that has all the properties of an element
2. _____ the bundle consisting of protons and neutrons, which is found in the center of an atom
3. _____ atoms of an element containing the same number of protons, but different numbers of neutrons
4. _____ a part of an atom with a positive charge
5. _____ a part of an atom with a negative charge

B. Indicate whether each statement is true (T) or false (F) by circling the correct letter.
If the statement is false, correct it to make it true.

1. An atom is identified by the number of protons in its nucleus. T F
2. Protons and electrons together make up the nucleus of an atom. T F
3. Atoms are so small that humans cannot see them. T F
4. Atoms combine to form molecules. T F

C. Using the Periodic Table, tell which elements make the molecules of the following substances.

1. H_2SO_4 _____
2. $\text{C}_6\text{H}_{12}\text{O}_6$ _____
3. KOH _____
4. AgNO_3 _____
5. ZnCl_2 _____

D. Models

1. Label the model of the carbon atom shown below. An atom of carbon has 6 protons, 6 neutrons, and 6 electrons. Remember that protons have a positive (+) charge, electrons have a negative (-) charge, and neutrons have no electrical charge.

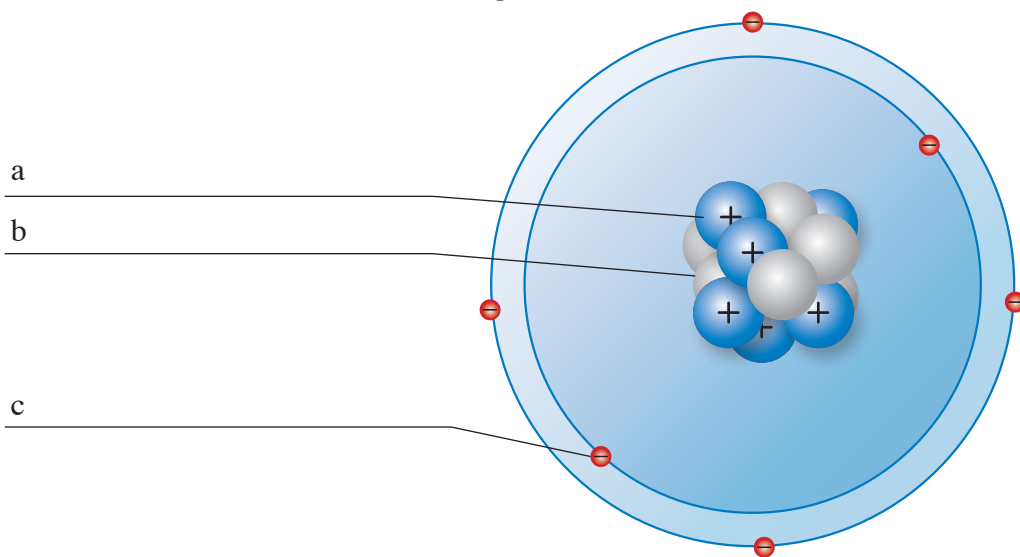

2. Draw a model of a boron atom. Refer to the Periodic Table to see how many protons, electrons, and neutrons to show. Show protons as (+), electrons as (-), and neutrons as (○).

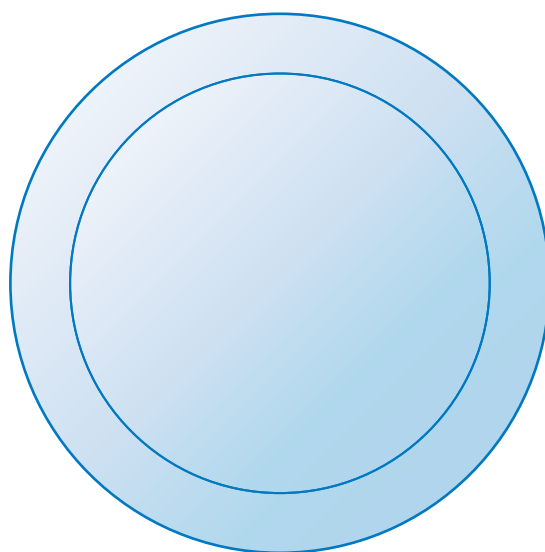

Lesson 3 Reading Review Exercise – Answers

A. Write the word that best fits the definition given.

1. atom the smallest unit of matter that has all the properties of an element
2. nucleus the bundle consisting of protons and neutrons, which is found in the center of an atom
3. isotopes atoms of an element containing the same number of protons, but different numbers of neutrons
4. proton a part of an atom with a positive charge
5. electron a part of an atom with a negative charge

B. Indicate whether each statement is true (T) or false (F) by circling the correct letter. If the statement is false, correct it to make it true.

1. An atom is identified by the number of protons in its nucleus. (T) F
2. Protons and electrons together make up the nucleus of an atom. T (F)
Protons and neutrons together make up the nucleus of an atom.
3. Atoms are so small that humans cannot see them. (T) F
4. Atoms combine to form molecules. (T) F

C. Using the Periodic Table, tell which elements make the molecules of the following substances.

- | | | | |
|--|------------------|-----------------|-----------------|
| 1. H_2SO_4 | <u>hydrogen</u> | <u>sulfur</u> | <u>oxygen</u> |
| 2. $\text{C}_6\text{H}_{12}\text{O}_6$ | <u>carbon</u> | <u>hydrogen</u> | <u>oxygen</u> |
| 3. KOH | <u>potassium</u> | <u>oxygen</u> | <u>hydrogen</u> |
| 4. AgNO_3 | <u>silver</u> | <u>nitrogen</u> | <u>oxygen</u> |
| 5. ZnCl_2 | <u>zinc</u> | <u>chlorine</u> | |

D. Models

1. Label the model of the carbon atom shown below. An atom of carbon has 6 protons, 6 neutrons, and 6 electrons. Remember that protons have a positive (+) charge, electrons have a negative (-) charge, and neutrons have no electrical charge.

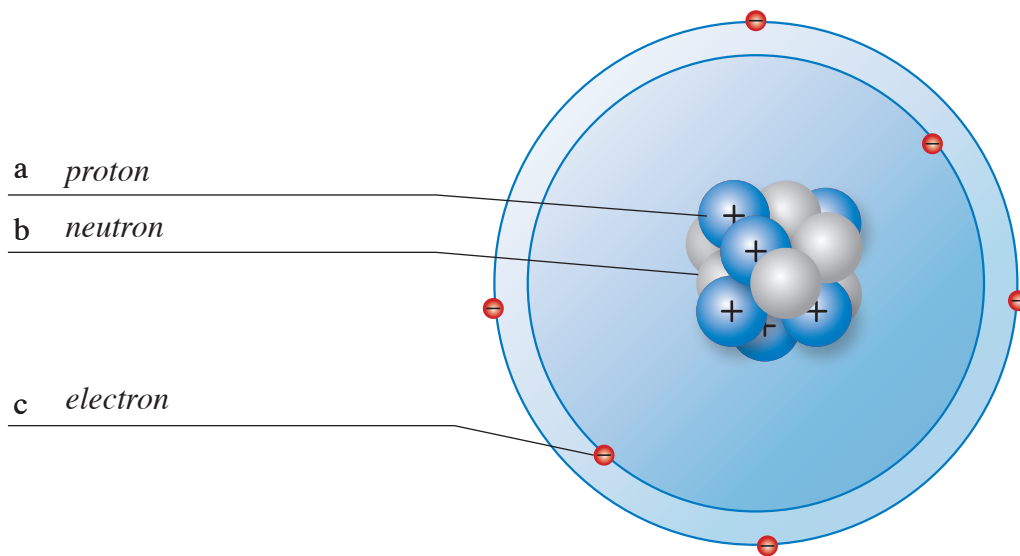

2. Draw a model of a boron atom. Refer to the Periodic Table to see how many protons, electrons, and neutrons to show. Show protons as (+), electrons as (-), and neutrons as (○).

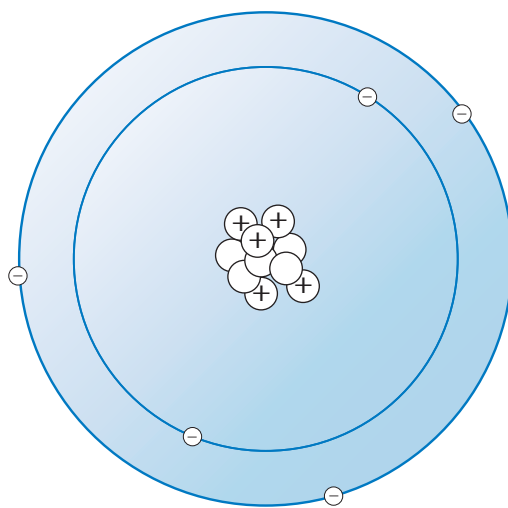

Activities, Labs, and Supplemental Information

Teacher's PowerPoint Presentation

A Teacher's (PowerPoint) presentation is provided on CD and online on the DOE Office of Nuclear Energy website to help you present chapter concepts to your class. Download the teacher presentation at: <http://energy.gov/ne/services/harnessed-atom>

Activity - The Day Tomorrow Began

The Day Tomorrow Began is a 30-minute historic film about the scientists and world events that led to building the first nuclear reactor in Chicago in 1942 by Enrico Fermi and a team of brilliant young researchers. It is available on DVD and at <http://energy.gov/ne/services/harnessed-atom>. It was produced in 1967 for the Atomic Energy Commission by Argonne National Lab.

Activity - Interactive Computer Game

The interactive computer game, Making Matter: Build an Atom is provided on a CD or available online at www.orau.org/center-for-science-education/files/build-an-atom/index.html. Using information from the Periodic Table, students use the basic building blocks of matter to build chemical elements.

Note: The Making Matter game presents a simple introduction to the Rutherford-Bohr model of the atom and the way we organize the elements. For this game, the most common isotopes of the chemical elements are used. General questions about the properties of elements assume standard temperature and pressure. (For example, helium is liquid below -268°C , and gold is liquid above 1064°C). They are intended to get players thinking about what they already know about elements. Students may be interested in the even smaller particles of quantum physics like quarks, bosons, neutrinos, and antineutrinos.

Player Information

- In the Making Matter game, use the basic building blocks of matter to build chemical elements. Find the answers you need using scientific tools like the Periodic Table.
- This game shows the most common form (isotope) of each element. There are others!
- You'll be asked general questions about elements. Think about the elements at "room temperature." You probably know that gas becomes liquid when it's very cold or under pressure, and solids turn to liquids when they reach their melting point.
- There are other even smaller building blocks of matter. Research them after you've played this game.

Activity - Rap it Up!

After this activity, the student will be able to

- Describe the basic structure of matter
- Name the parts of an atom
- Have experience using the Periodic Table
- Explain elements
- Have the background to understand isotopes
- Understand that scientists build on the work of those who came before them

Lab - Atom Model

This hands-on lab teaches the structure and composition of the atom. Part 1 offers students a chance to use information available in the Periodic Table to build a lithium atom and then to change the lithium atom to a beryllium atom by adding a proton to the nucleus.

In Part 2, students build models of three forms of hydrogen, reinforcing the concept that the number of neutrons in the nucleus determines the isotopes of a hydrogen atom.

Social Studies Extension - Atoms Shaped the World

This activity introduces students to the concept that energy science discoveries may be understood in the context of their historical periods. Students will create a timeline using the chronology of people, countries, and events in 19th or 20th century, according to the historical period you are teaching. They will link scientific discoveries and the people behind them to other movements and changes in a time period. The activity will help visual learners to link events and to recognize possible relationships among them. Reference students to Lesson 1's timeline as an example.

The timeline can be a useful reference throughout the school year. Display it in your classroom or hallway.

Extended Learning Discussion: Strong Force

There are four fundamental forces in nature: gravity, electromagnetism, strong force, and weak force. Scientists have theorized for a long time that they are all connected, or perhaps even different aspects of the same force. But each has different properties and acts over a different distance. The strong force is the most powerful, but it acts only over a very small distance (10^{-15} cm) inside the nucleus of atoms.

Think About It

What would you say is the difference between matter and force?

You might think about matter as something that you can see and hold in your hand. That's a good way to understand it, even though you would need incredible vision and very tiny hands to see and hold atoms.

Force is what causes matter to move, change, or react. You cannot see it, but you can see its effect.

Of the four fundamental forces, you observe the effects of two of them every day. When you let go of a ball, it falls toward the Earth. The force of gravity causes objects to attract. There is no limit to how far this force reaches, but it grows weaker as distances increase.

Electromagnetism is the second force. It causes charged particles to attract or repel within areas called electromagnetic fields. It acts only over fairly short distances of centimeters to meters.

By the 1930s, scientists realized that there must be other forces that act at the atomic scale. By then, they

knew that atoms were made of positively charged protons and other particles. Protons should repel each other because of their charge, so there must be another, powerful force that glues the nucleus of atoms together. The strong force explained this observation.

But realizing that there had to be a strong force did not entirely explain what scientists observed. How did radioactivity, where beta particles and positrons actually do fly out of the nucleus, fit this explanation?

The weak force was the final piece of the puzzle. It was solved by Enrico Fermi in 1934. He theorized that there must be another force that can convert protons into neutrons, and neutrons into protons, emitting electrons or positrons in the process. Like the strong force, the weak force acts only over the tiny distance inside the nucleus of atoms. As the particles inside the nucleus are converted, pieces break off, releasing electromagnetic energy. This is what we know as radiation.

Extended Learning Topic: Quarks, bosons, and neutrinos

What actually happens in beta decay through weak force? Using the powerful tools that science has developed to study particle physics, we now know that there are even smaller particles that make up the building blocks of atoms. We have given them peculiar names, and the science gets more complicated. In beta decay, a down quark in the neutron changes into an up quark by emitting a virtual W^- boson. This is converted into an electron and an electron antineutrino. If you want to know more, there are many good books about quarks, bosons, and particle physics. An internet search will help you find short videos that may help students understand these topics.

Activity – Rap it Up!

In this activity, students will create an educational rap about the parts of an atom. Students may work in groups or as individuals. YouTube has several free rap rhythm instrumental downloads; however, the site may be blocked by your school's network. If YouTube is blocked, there are alternatives available at teachertube.com or at melodyloops.com. There are also many software programs that can be used, including Garageband, Audacity, Ableton Live, and Adobe Audition.

Materials

- Projector
- Paper/pencils
- Looped rap instrumental download

Procedure

1. Provide students with a Word document with the beginning lines of a rap.

For example:

My name is Atom/
So small you can't see/
but look around, everything is made of me!

Or show CERN LHC rap at vimeo.com/1431471

2. Project the document or video onto a screen.
3. Have students write down the first lines.
4. If working as a group, choose a student who types well and who is a good speller to take dictation at a computer.
5. Have students contribute lines to a rap. To begin, ask students for suggestions for a line that ends with a word that rhymes with "me."
6. After about 30 minutes, read the rap from the top, so students can see what they've composed. Students may take turns reading each line.

Lab – Build an Atom Model

Although atoms cannot be directly observed without special instruments, we do know about their structure and composition. This activity introduces the basic make up of simple atoms and isotopes.

Materials

- Styrofoam blocks, 4
- Styrofoam balls, 2 sizes (20 large size; 10 small size)
- Toothpicks and longer sticks, such as kebab or coffee stir sticks
- Water-based or acrylic paint, 2 colors
- Non-toxic black marker

Procedure

1. **Protons.** Paint the larger of the foam balls using one color. (An easy way is to pour the paint into a sandwich bag, add the foam balls, roll them around until coated, and then carefully remove each one with a toothpick. Set each ball in the block to dry. It may take overnight.) When dry, mark them with a plus sign (+) to show a positive charge.
2. **Electrons.** Paint the smaller foam balls with the other color. When dry, mark them with a minus (-) sign to show a negative charge.
3. **Neutrons.** Leave some larger foam balls unpainted. Leave them unmarked to show they have no electrical charge.

Part 1: Build a model of a lithium atom

- A. Use the Periodic Table to see how many protons, neutrons, and electrons you will need for a lithium atom. Group the protons and neutrons together as the nucleus, using broken toothpicks for a tight fit. Then arrange some electrons on toothpicks and some on kebab or coffee stir sticks so they are further away from the nucleus. Two electrons on toothpicks will represent the first shell, and the electrons on the longer sticks will represent the second shell. To display your model, use one toothpick or longer stick to attach your model to the foam block.



- B. Add 1 proton, 1 neutron, and 1 electron to your model. Use the Periodic Table to see what element your model represents now that you have added a proton, a neutron, and an electron.
1. The second atom you have made represents what element? _____
 2. If you added yet another proton, electron, and neutron, what element would your model represent? _____
 3. The number of _____ in the nucleus determines what an element is.

Part 2: Build models of three forms of hydrogen

Build models of the following:

Hydrogen – 1 proton and 1 electron

Heavy hydrogen (deuterium) – 1 proton, 1 neutron, 1 electron

Very heavy hydrogen (tritium) – 1 proton, 2 neutrons, 1 electron

1. What is the same about each form of hydrogen? _____
2. What is different? _____
3. Do all atoms except hydrogen always have the same number of protons and electrons?

4. Tritium is so heavy that it is unstable. It throws off energy and particles to become stable. What word describes atoms like this? _____
5. Atoms of an element that have the same number of protons but different numbers of neutrons are _____ of the atom.

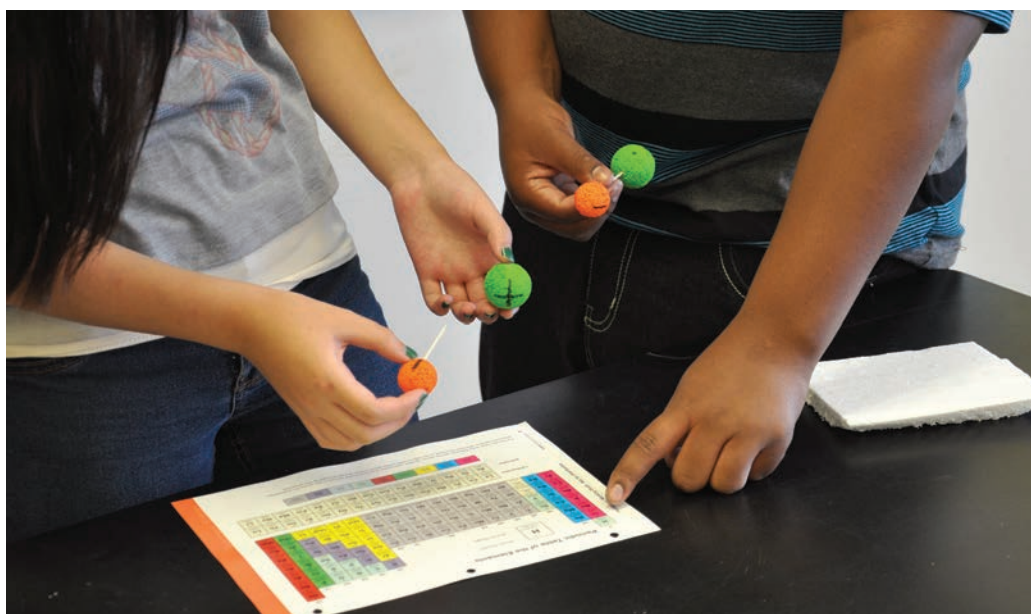

Lab – Build an Atom Model - Answers

Although atoms cannot be directly observed without special instruments, we do know about their structure and composition. This activity introduces the basic make up of simple atoms and isotopes.

Materials

- Styrofoam blocks, 4
- Styrofoam balls, 2 sizes (20 large size; 10 small size)
- Toothpicks and longer sticks, such as kebab or coffee stir sticks
- Water-based or acrylic paint, 2 colors
- Non-toxic black marker

Procedure

1. **Protons.** Paint the larger of the foam balls using one color. (An easy way is to pour the paint into a sandwich bag, add the foam balls, roll them around until coated, and then carefully remove each one with a toothpick. Set each ball in the block to dry. It may take overnight.) When dry, mark them with a plus sign (+) to show a positive charge.
2. **Electrons.** Paint the smaller foam balls with the other color. When dry, mark them with a minus (-) sign to show a negative charge.
3. **Neutrons.** Leave some larger foam balls unpainted. Leave them unmarked to show they have no electrical charge.

Part 1: Build a model of a lithium atom

- A. Use the Periodic Table to see how many protons, neutrons, and electrons you will need for a lithium atom. Group the protons and neutrons together as the nucleus, using broken toothpicks for a tight fit. Then arrange some electrons on toothpicks and some on kebab or coffee stir sticks so they are further away from the nucleus. Two electrons on toothpicks will represent the first shell, and the electrons on the longer sticks will represent the second shell. To display your model, use one toothpick or longer stick to attach your model to the foam block.



B. Add 1 proton, 1 neutron, and 1 electron to your model. Use the Periodic Table to see what element your model represents now that you have added a proton, a neutron, and an electron.

1. The second atom you have made represents what element? beryllium
2. If you added yet another proton, electron, and neutron, what element would your model represent? boron
3. The number of protons in the nucleus determines what an element is.

Part 2: Build models of three forms of hydrogen

Build models of the following:

Hydrogen – 1 proton and 1 electron

Heavy hydrogen (deuterium) – 1 proton, 1 neutron, 1 electron

Very heavy hydrogen (tritium) – 1 proton, 2 neutrons, 1 electron

1. What is the same about each form of hydrogen? 1 proton and 1 electron
2. What is different? different number of neutrons
3. Do all atoms except hydrogen always have the same number of protons and electrons?
No, not always (Losing or gaining an electron creates an electrically charged atom.
Remind students of the danger of words like “always” and “never”.
4. Tritium is so heavy that it is unstable. It throws off energy and particles to become stable. What word describes atoms like this? radioactive
5. Atoms of an element that have the same number of protons but different numbers of neutrons are isotopes of the atom.

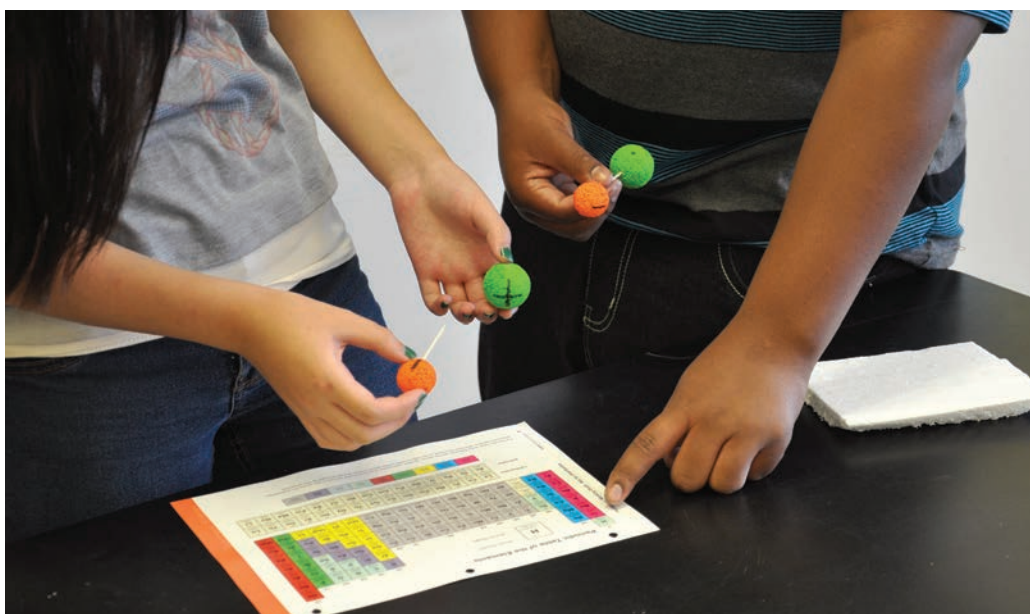

Social Studies Extension: **Atoms Shaped the World**

Timelines can help you understand how people and events connect in history. This timeline will focus on how nuclear science, events, and the people behind them have changed the world.

Materials

- Long strip of butcher paper
- Note cards, poster board, markers, and tape
- String or yarn and clothes pins
- Or use a Microsoft® PowerPoint timeline template

Procedure

1. Mark your timeline with a bold horizontal line representing the century you are studying. Add vertical lines for 10-year increments.
2. Look at Lesson 1 of *The Harnessed Atom* to learn what a timeline can show. Then read Lesson 3 and other resources to find the dates, people, and discoveries relevant to the discovery of the atom and its energy within.
3. Gather energy science images, photos of people, and documents that relate to your assigned time period. Look for significant cultural, social, and economic events and draw or write them down.
4. Tape your significant events to the timeline. You can also make smaller posters and use string to connect them to the line. Your drawings, primary sources, notecards, and printed online images should cover timeline.
5. Be ready to discuss your observations with the class. Learn about connections between national and international historical events and the scientific events you found.
6. Or write a short essay about the causes and consequences of advances in nuclear science.

IONIZING RADIATION

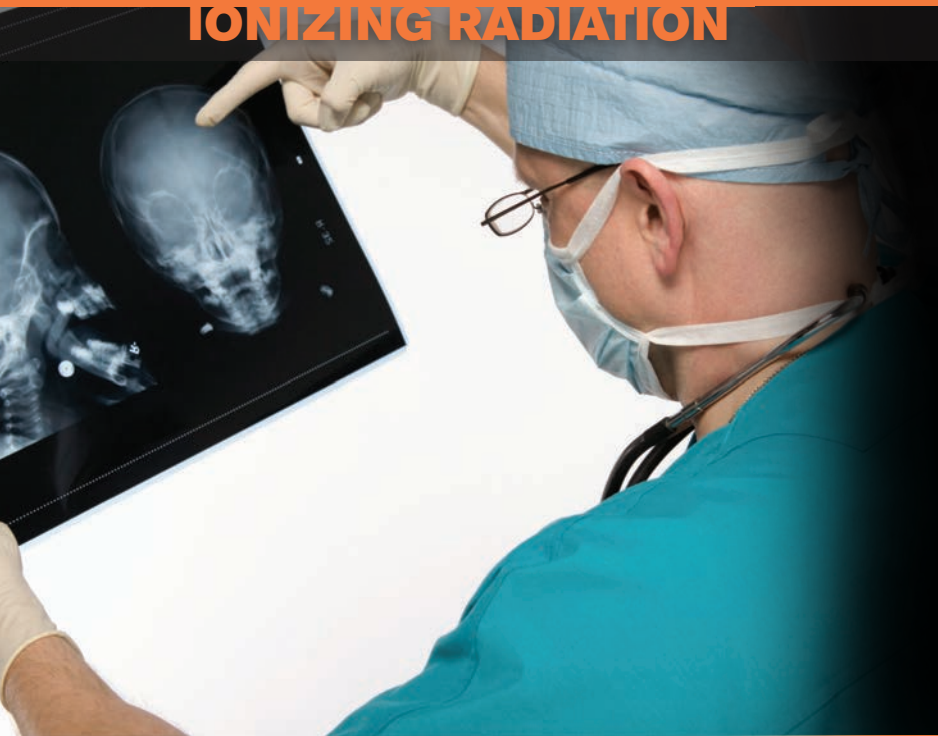

Introduction

In the last lesson, we learned that unstable isotopes emit energy as they become more stable. This energy is known as radiation. This lesson will explore forms of radiation, where radiation is found, how we detect and measure radiation, what sources of radiation people are exposed to, whether radiation is harmful, and how we can limit our exposure.

TOPICS:

Types of radiation
Non-ionizing
Ionizing

Forms of ionizing radiation
Alpha particles
Beta particles
Gamma rays

Radiation
Decay chain
Half life
Dose

Radiation Measurements

Sources of radiation
Average exposure

What is radiation?

Radiation is energy moving through space in the form of waves and particles. Radiation is everywhere – in, around, and above the world we live in. It is a natural energy force that surrounds us. It is a part of our natural world that has been here since the birth of our planet.

Radiation can be described as **non-ionizing** or **ionizing**. Non-ionizing radiation does not have enough energy to knock electrons from atoms as it strikes them. Sunlight, radio waves, and cell phone signals are examples of non-ionizing radiation. However, it can still cause harm, like when you get a sunburn.

Ionizing radiation is the type of radiation most people think of when they hear the word *radiation*. **Ionizing radiation** can knock electrons from an atom, creating electrically charged particles called **ions**.

Because we cannot see, feel, hear, smell, or taste ionizing radiation, no one knew it existed until 1895. But it was here all along. Since its discovery, radiation has been one of the most thoroughly studied subjects in modern science. Scientists have found important uses for ionizing radiation. They have also studied its effects on human health.

What are the forms of ionizing radiation?

Ionizing radiation includes the **alpha** and **beta particles** and **gamma rays** emitted from radioactive materials. Cosmic radiation that reaches the Earth from outer space is ionizing. Ionizing x-ray radiation is produced by x-ray machines.

Gamma rays, x-rays, and cosmic rays are waves of pure energy, without mass or charge. They appear at the high frequency (high energy) end of what we call the **electromagnetic spectrum**.

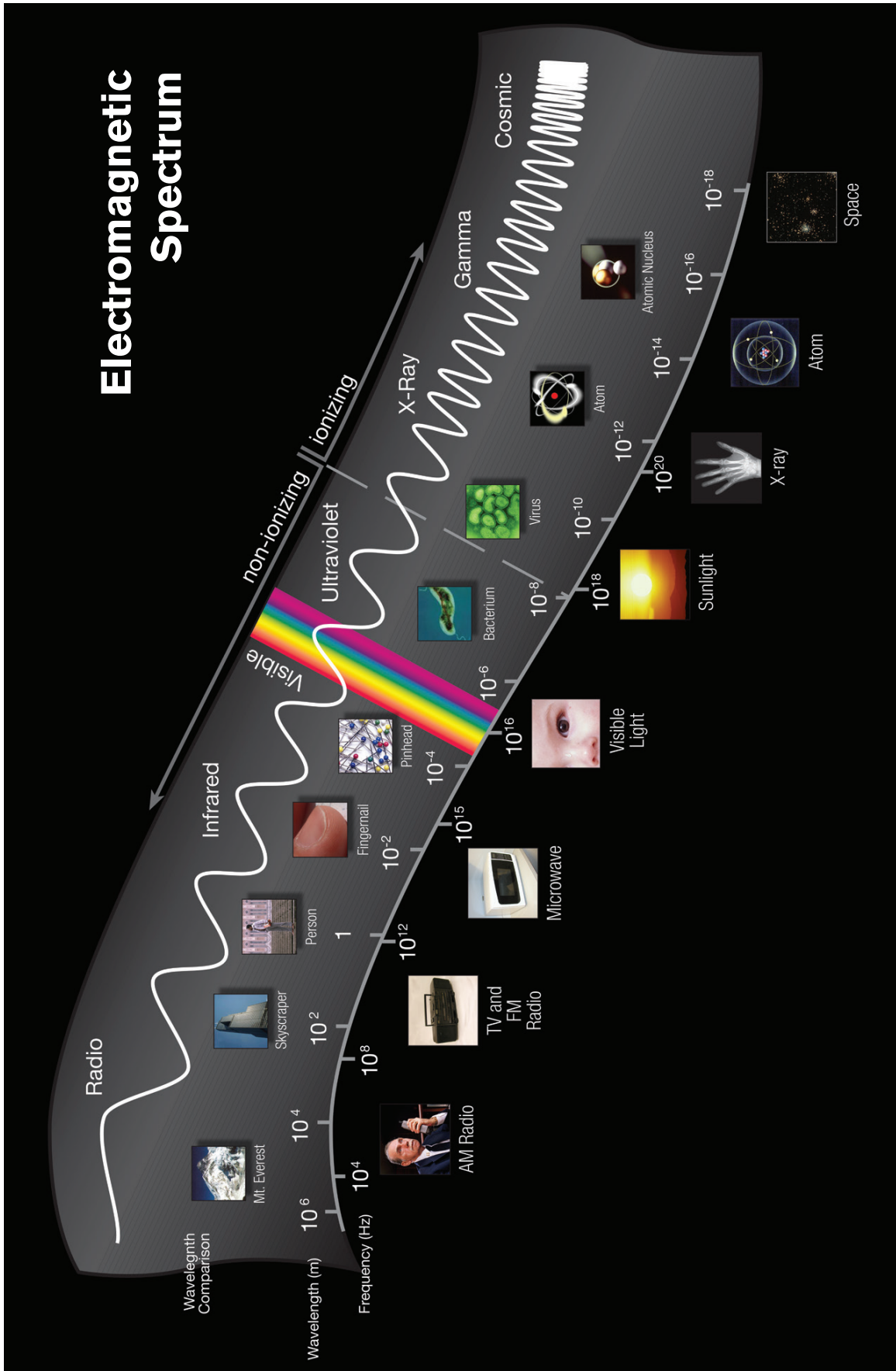

X-rays, gamma rays, and cosmic rays are waves of pure energy. They are part of the electromagnetic spectrum that also includes radio waves, visible light, and ultraviolet light. Because they are higher energy and frequency, they can knock electrons off molecules and cause them to become "ionized."

Teachers' Notes:

All types of electromagnetic radiation travel at the speed of light. Their energies are determined by their frequencies (the number of waves or cycles per second) not their speed. Alpha and beta particles are not part of the electromagnetic spectrum. They travel at very fast rates but slower than the speed of light.

Teachers' Notes:

Ask your students if they remember what the speed of light is.

186,000 miles/second or about 3×10^8 (299,792,458) meters/second. Students can observe that TV waves travel at the speed of light and no faster when they watch TV news or sports programs. For example, when an interviewer asks a question of someone who is in another part of the world, there is a short

but noticeable pause before the person being interviewed hears the question and begins to answer.

Teachers' Notes:

UV radiation is from the Sun. Is it cosmic radiation?

'Cosmic radiation' is the name for radiation from space (the cosmos). In the electromagnetic spectrum, it is at the high frequency end, but is mostly very low energy. Cosmic radiation includes photons and neutrinos from the origin of the universe. It also includes higher energy gamma radiation (photons) from our Sun, stars, quasars, and objects near black holes. Most cosmic radiation is either shielded by Earth's atmosphere, or passes through our bodies without interacting with cells.

Students may be aware that UV radiation also comes from the Sun and is quite harmful. In a sense, UV is also "cosmic" radiation because it comes from the Sun. However, UV is at a lower frequency than cosmic radiation and is not ionizing.

The spectrum also includes non-ionizing radiation (radio and television waves, microwaves, light, etc.) at the lower frequency (lower energy) end.

How does ionizing radiation deposit energy?

Because it can knock electrons from the atoms and molecules in its path, ionizing radiation can cause chemical changes in living cells. However, the types of ionizing radiation are different in how much they penetrate and deposit energy through ionization.

Alpha particles are relatively large and carry a double positive charge (++). They are not very penetrating and a piece of paper or your skin can stop them. They travel only a few centimeters but deposit all their energies along their short paths. In delicate tissue, alpha can do a large amount of damage.

Beta particles (electrons) are much smaller than alpha particles. They carry a single negative charge (-). They are more penetrating than alpha particles, but thin aluminum metal can stop them. They can travel several meters but deposit less energy at any one point along their paths than alpha particles.

Gamma rays are waves of energy without mass or electrical charge. They can travel 10 meters or more in air. This is a long distance compared to alpha or beta particles. However, gamma rays deposit

Types of Ionizing Radiation

Alpha particle:
- easily stopped
- least penetrating



Beta particle:
- much smaller
- more penetrating



Gamma ray and x-ray:
- pure energy with no mass
- most penetrating

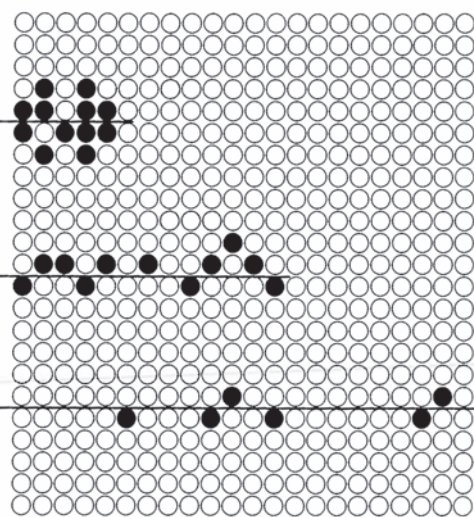

● ion ○ neutral atom or molecule

Alpha, beta, and gamma are ionizing radiation. The distance each can travel is limited by how it interacts with other atoms.

less energy along their paths. Lead, water, and concrete stop gamma radiation.

Where does radiation come from?

Some unstable isotopes become more stable by emitting or shooting out energy rays similar to x-rays. Others may emit particles from their nuclei and change into different elements. The rays and particles unstable isotopes shoot out are **radiation**. Substances that give off radiation in this way are **radioactive**.

Radioactive decay is the process of isotopes emitting particles or rays from an atom's nucleus to become more stable. An unstable isotope will eventually decay into a stable element. However, this process may take many steps and a long time. These steps are called a **decay chain**. For example, the isotope uranium-238 transforms into more than 15 different isotopes before it becomes stable lead-206.

What is half-life?

Radioisotopes decay at random, and it is impossible to guess which one will decay next. Yet, in a group of atoms, we can see a pattern. We describe this pattern by using the term **half-life**. The amount of time it takes for a given isotope to lose half of its radioactivity is known as its half-life.

If a radioisotope has a half-life of 14 days, half of its atoms will have decayed within 14 days. In 14 more days, half of that remaining half will decay, and so on.

Some isotopes may change in the next second, some in the next hour, some tomorrow, and some next year. Other isotopes will not decay for thousands of years. Half-lives range from fractions of a second to several billion years.

Decay Chain

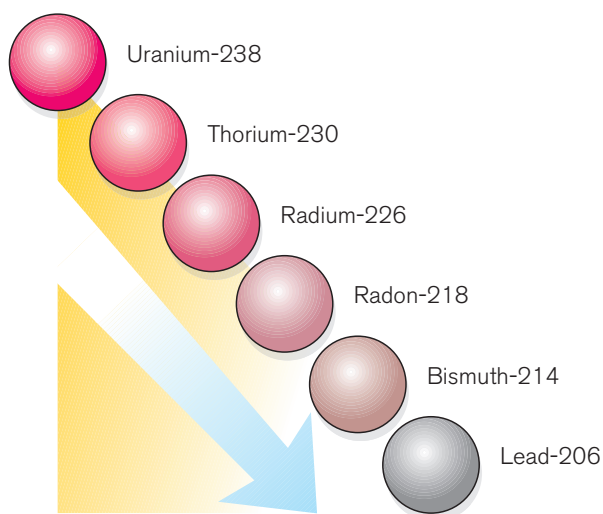

Uranium slowly decays to lead. It happens in a chain of events called a decay chain. Here are some of the steps in the uranium decay chain. The half-life of uranium-238 is 4.5 billion years.

Half-lives of Some Radioactive Isotopes

Americium-241	432.7 years
Fluorine-18	109.7 minutes
Carbon-14	5,715 years
Hydrogen-3 (tritium)	12.32 years
Iodine-131	8 days
Iridium-191	4.9 seconds
Krypton-85	10.7 years
Technetium-99m	6.01 hours
Uranium-235	700 million years

Technetium-99m and fluorine-18 are useful in medical diagnosis because of their short half-lives.

What is radiation dose?

To measure how different amounts of ionizing radiation affect people, we use the term **radiation dose**. When you take medicine, the effects of a dose depend on the type of medicine, the amount of the medicine you take, the period of time in which the medicine is taken, and how your own body responds. Two aspirin may cure your headache. Twenty aspirin in a week may cure ten headaches. But 20 aspirin taken all at once could do serious damage.

Another example to think about is your exposure to the non-ionizing radiation from the Sun's rays. If you spend a short time in the Sun each day, or limit your exposure by wearing sunscreen and clothing, your skin will get less damage than if you spend an entire day on the beach in just your bathing suit (ouch!).

People who work with radiation limit their extra radiation exposure as much as

Teachers' Notes:

Ask students which of the types of ionizing radiation they think is more likely to cause injury. The answer is complicated.

Alpha radiation won't penetrate a layer of dead skin cells on your hand. However, in soft tissue like lungs, it is more dangerous because it deposits its energy along a short path.

Teachers' Notes:

How do we use half-lives to determine the age of ancient objects?

Because we know the half-lives of various isotopes, we are able to figure out how long they have been present in certain objects and, thus, determine the age of those objects. Carbon-14 is especially useful. New carbon-14 is constantly being formed by cosmic particles striking nitrogen-14 atoms in Earth's atmosphere. Carbon, including carbon-14, accumulates in living cells. When organisms die, they no longer absorb carbon. The decay of carbon-14 means that after a few years, the percent of carbon-14 in an old object is less than in a newer one. By measuring the difference, scientists calculate the age of an object in question. This process is called carbon dating.

Teachers' Notes:

Make sure your students understand that when radioactive decay occurs, matter does not disappear. The atom changes into a different, more stable atom.

possible. Your dentist may step out of the room during your x-ray, for example. To minimize dose, workers can apply the rule of **time, distance, shielding**:

- *Decrease* the time of exposure
- *Increase* the distance from a source of radiation
- *Increase* shielding with dense material like lead or concrete

Teachers' Notes:

Ask your students how they can apply the time, distance, and shielding rule at the beach. Or ask them if they have seen workers at their dentist's office or a hospital apply the rule when they take x-ray images.

Because we cannot detect radiation with our senses and because exposure to too



much radiation is harmful, we use a special symbol to warn us when radioactive materials are present. We put the symbol on packages of radioactive materials

when we ship them by truck, train, plane, or ship. We also put the symbol on doors to rooms or areas where we use or store radioactive materials. You have probably seen the symbol if you have had an x-ray.

Teachers' Notes:

Laws also require special labeling for explosives, poisons, flammable materials, combustible gases, and other hazardous materials to protect people.

Ask your students if they can name or describe the caution symbol for "flammable" on trucks carrying gasoline. It's a flame.

How do we measure radiation?

Scientists use different units to measure radiation depending on what they want to measure. If a friend asks how far it is from school to your home, you can answer the question several different ways.

Measurements of Radiation

What is measured	Traditional unit	International Unit (SI)
Total amount of radioactivity contained in a source	curie (Ci)	becquerel (Bq) 37 billion Bq = 1 Ci
Radiation dose absorbed by a person (amount of energy deposited in human tissue)	rad (radiation absorbed dose)	gray (Gy) 1 Gy = 100 rad
Biological effect of exposure to radiation (dose equivalent)	rem (radiation equivalent man) or millirem (mrem)	sievert (Sv) or millisievert (mSv) 1 Sv = 0.1 rem 1 mSv = 100 mrem

For instance, you may live a half mile away, but you also live 2,640 feet from school, 804 meters, or an 18-minute walk away. It's the same with measuring radiation.

The unit most often used to measure ionizing radiation in the United States is **millirem (mrem)**. The international unit is **millisievert (mSv)**. Both measure the risk that the ionizing radiation will cause tissue damage in a person. One millisievert equals one hundred millirem (1 mSv = 100 millirem).

We use the curie (Ci) or becquerel (Bq) to measure the amount of radioactivity in a substance. We use the rad or gray (Gy) to talk about the energy in radiation absorbed by a person.

What does radiation do?

Scientists have studied the effects of radiation for almost a century. High doses are well understood. If an exposure is very high and happens quickly, it is dangerous. Radiation exposures of over 1,000 millisieverts (100,000 millirems) cause radiation sickness. Very high exposures over 5,000 millisieverts (500,000 millirem) received all at once usually cause death. Fortunately, exposures this high are extremely rare.

Where Our Exposure to Ionizing Radiation Comes From

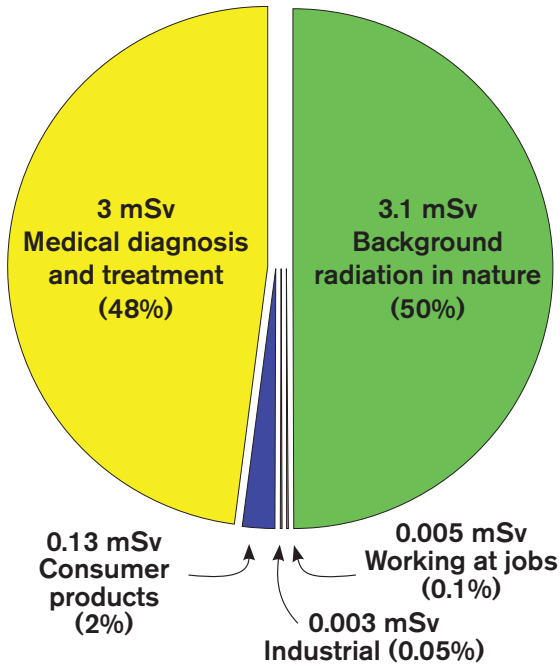

Adapted from NCRP Report No. 160, Ionizing Radiation Exposure of the Population of the United States, March 2009.

People who work in industry or medicine are permitted to receive up to 50 millisievert (5,000 millirems) a year. It takes 10 times this

amount received all at once before doctors can detect any harmful effects on a person.

Some scientists believe that any amount of radiation may have a harmful effect. However, most scientists believe that low levels do not have much effect on people. If radiation exposure is low, or the radiation is received over a long period of time, the body repairs any damage. Even so, sometimes the body makes an incorrect repair. If this happens, there is a possibility of a delayed effect that doesn't show up for years. Cancer can be one delayed effect.

Where does our exposure to radiation come from?

In the United States, the average person receives about 6.25 millisievert (625 millirem) a year. About half of this is from natural radiation and half is from medical procedures.

Teachers' Notes:

Students may be concerned when they learn that we are all exposed to low levels of radiation every day. Is background radiation dangerous to our health? This is a very hard question to answer. Even experts disagree. But most experts agree that there is little, if any, danger from background radiation which is always present in our environment and always has been, because it is part of nature. One exception is radon. There is concern about buildup of radon in buildings and testing is recommended. There may be a cumulative effect of background radiation, somewhat like the effects of growing older.

Radiation Moves Through Our Environment

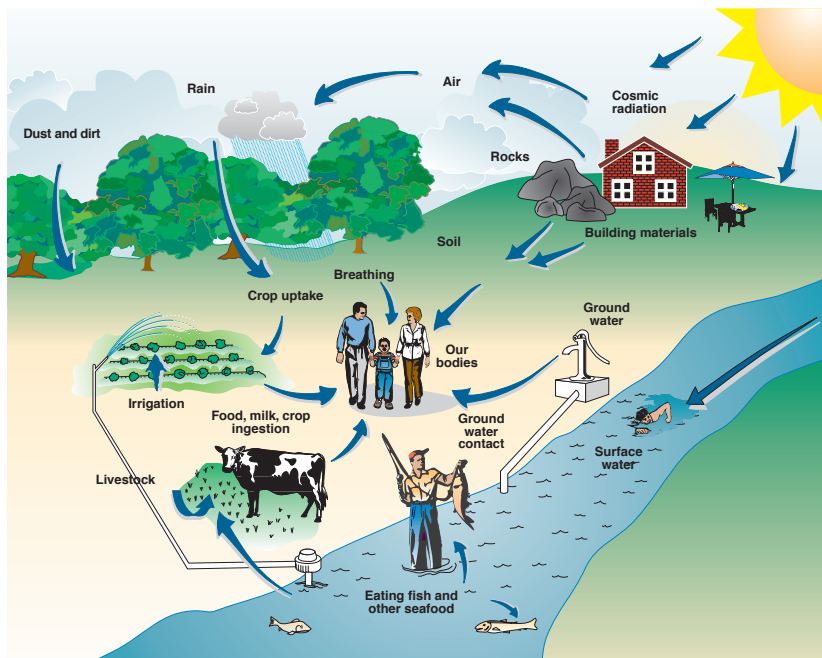

Everything around us exposes us to small amounts of radiation.

Teachers' Notes:

Students might enjoy learning the word "ubiquitous." It's a cool word to know and applies very well to background radiation. Definition: Existing or being everywhere at the same time; constantly encountered.

Terrestrial Radiation by Region

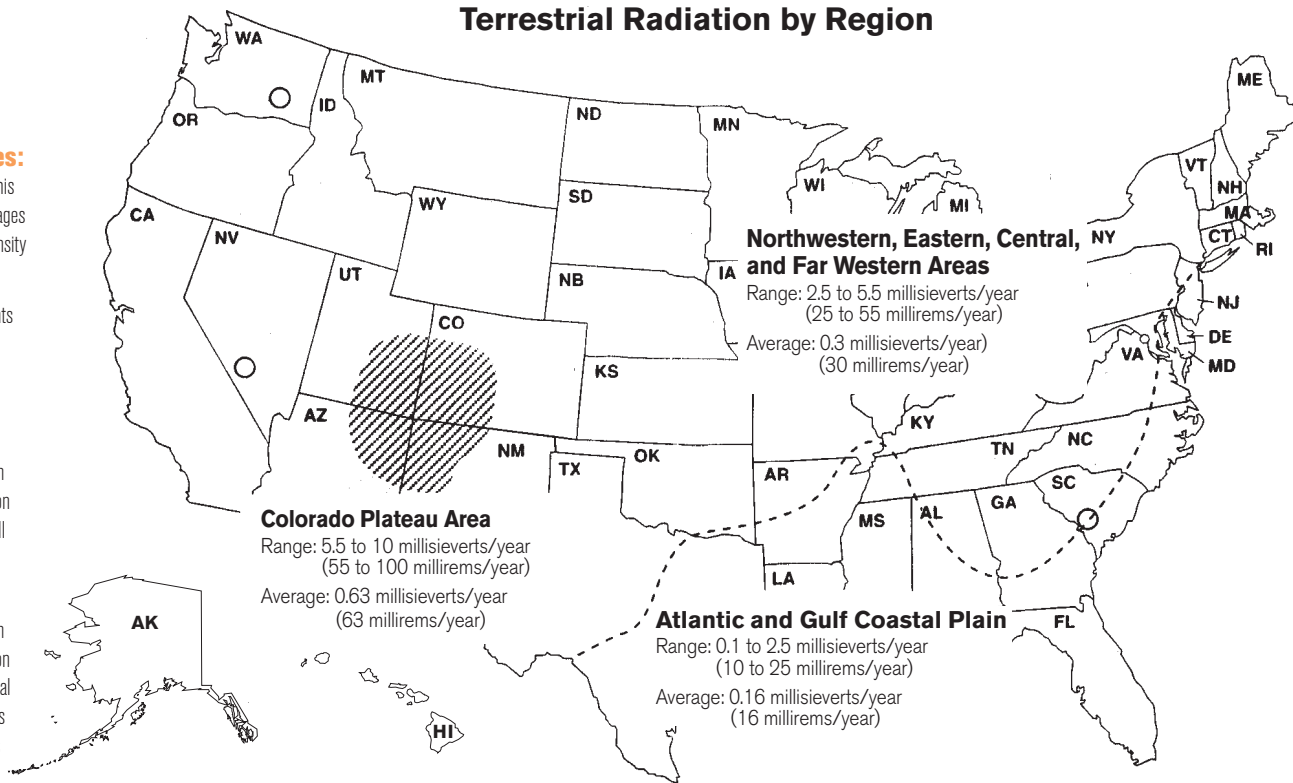

Teachers' Notes:

The measurements in this map are weighted averages that take population density into account.

It may help your students understand weighted averages if you give an example of weighted averages for grades.

Grades of 70, 80, 90 on chapter tests and 100 on the final = 85 if they all count equally. $(340 / 4 = 85)$

Grades of 70, 80, 90 on chapter tests and 100 on the final = 90 if the final test score of 100 counts three times as much as each chapter test. $(540 / 6 = 90)$

The average yearly dose of ionizing radiation in the United States is increasing. That's because we use radiation much more often as a tool in medicine. As imaging technology improves, doctors are using x-rays and computed tomography (CT) scans more often for diagnosis. Doctors are also using radiation to treat diseases such as cancer.

What is background radiation?

Let's look more closely at where we find radiation. Everything in the world is radioactive and always has been. The ocean we swim in, the mountains we climb, the air we breathe, the foods we eat, and the water we drink all expose us to small amounts of radiation from nature. This is because there are unstable isotopes that emit ionizing radiation everywhere on Earth.

The main natural sources of radiation are

- **Terrestrial radiation** from the rocks and soils around us
- **Cosmic radiation** from space
- **Radon** in the atmosphere
- **Internal radiation**, the radioactive elements in our bodies, mainly from what we eat or drink

The sum of our exposure from these sources is called **background radiation**.

What is terrestrial radiation?

Terrestrial radiation is background radiation that comes from the Earth. About 7 percent of natural background radiation is terrestrial radiation that comes from elements like potassium, uranium, and thorium. Most soils around the world contain at least small amounts of these elements. These elements constantly decay and emit radiation.

Radon Can Be Trapped in Buildings

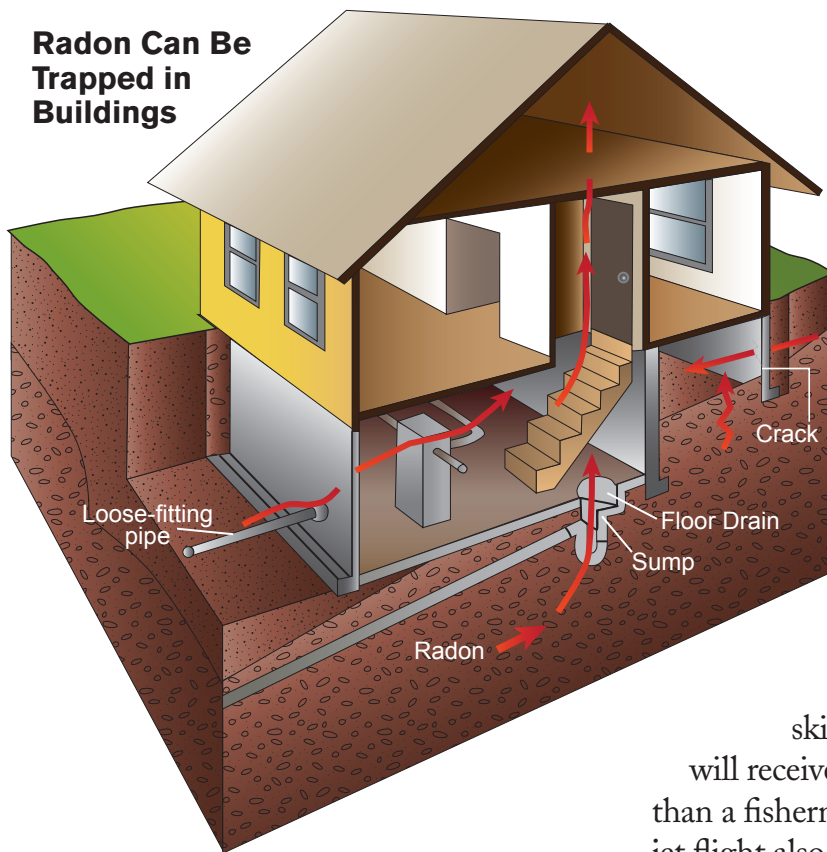

Radon gas finds its way into buildings from surrounding soil and rocks.

The average dose to a person in the United States from terrestrial sources is about 0.2 millisievert (200 millirem) per year. However, average exposure varies throughout the country, taking into account soils and the populations of different regions. For example, on the coastal plains of the Atlantic and Gulf regions, the average annual dose is lower than it is in the mountains in the western United States.

What is space radiation?

Space radiation comes from solar particles and cosmic rays from outer space. It accounts for about 11 percent of the total dose you get from background radiation. This radiation is filtered by the Earth's atmosphere, so the elevation where you live

affects your exposure from space radiation. How close you live to the equator also affects your dose. In Honolulu (at sea level and near the equator), the average annual dose from space radiation is 0.26 millisievert (26 millirem). In Denver, (farther from the equator and higher altitude) the dose is 0.52 millisievert (52 millirem). This means a

ski instructor at a mountain resort will receive more background radiation than a fisherman at sea level. Taking a jet flight also results in exposure to space radiation. However, there is no evidence of increased radiation health effects for people who live at high altitudes or for people, like airline pilots, who fly often.

What is radon?

Radon is a radioactive gas that comes from the natural decay of uranium found in nearly all soils and water. It has no color, odor, or taste. It can get into our buildings through cracks in the foundation. When this happens, it can build up indoors. Radon gas can damage lung tissue if we breathe too much of it. Simple tests can help you check a building or home for high radon levels.

What is internal radiation?

Natural radiation is also found in plants, animals, and people. After all, living things are made entirely of atoms of the elements from Earth, including such elements

Teachers' Notes:

The FAA estimates that an airline crewmember receives an added exposure of 68 millisievert (6,800 millirem) over a 25-year career.

as potassium and carbon. Some are radioactive. The radiation we receive from elements inside our bodies is called **internal radiation**.

Americans get about 2.66 millisieverts (266 millirems) of radiation each year from the food we eat, what we drink, and elements we breathe in. Of course, this number varies depending on what we eat or drink, where it is grown, and how much we eat. However, all foods contain some radioactive elements, and certain foods – bananas and Brazil nuts, for example – contain higher amounts than other foods. These are not harmful, and potassium and carbon are essential for our health.



from medical uses like x-rays, CT scans, and treatments for cancer that use radiation. But human-made sources include consumer products, such as smoke detectors.

Other human-made sources are related to technology. We get a trace amount of radiation from the nuclear power industry (0.1 percent of our exposure). It also comes from naturally occurring radiation in coal, ash, and smoke from coal-fired power plants. Other examples include increased terrestrial radiation from disturbing soils during construction or road building and fertilizers made from phosphates. Building materials, such as bricks and stone, also emit natural background radiation. So our homes, schools, factories, and businesses are all sources of background radiation.



Teachers' Notes:

Ask students to explain why bricks and stone building materials are sources of radiation.

Because they are from the Earth and contain minerals like uranium, thorium, potassium, so they emit terrestrial radiation.

What are some human-made sources of radiation?

We get additional radiation from products that use radiation. You already know that almost half of our average annual exposure to radiation (48 percent) comes



Summary

Radiation is energy moving through space in the form of waves and particles. It is a part of natural world and has been since the beginning of our planet. It can be described as non-ionizing (low energy) or ionizing (high energy). Some important forms of ionizing radiation are alpha and beta particles, gamma rays, and x-rays.

Unstable isotopes change by emitting particles or energy rays in a process called radioactive decay. As an unstable atom decays, it changes to a different element. Eventually, unstable isotopes decay to stable elements. The half-life of an isotope is the amount of time it takes to lose half of its radioactivity by decay.

The main natural sources of ionizing radiation we are exposed to are called background radiation. Background radiation includes

- Terrestrial radiation from the rocks and soils around us
- Solar particles and cosmic radiation from space
- Radon in the atmosphere
- Internal radiation - radioactive materials in our bodies mainly from what we eat, drink, and breathe in

There are also human-made sources of radiation. These include medical uses such as x-rays and CT scans and some products like smoke detectors. The average yearly dose of ionizing radiation for a person in the United States from all sources is 6.25 millisieverts (625 millirems). Half comes from background radiation (50 percent), 48 percent comes from medical uses, and 2 percent comes from consumer products and 0.15 percent from working and industry, including making electricity.

Because it can knock electrons from the atoms and molecules in its path, ionizing radiation can cause changes in human tissue. Most scientists believe low levels of exposure to radiation have an insignificant effect on people. If exposure is low or the radiation is received over a long period of time, the body can usually repair itself. However, if an exposure is high enough, it can cause damage. Fortunately, exposures to large amounts are extremely unusual.

People who work with radiation minimize their exposure using the rule of time, distance, and shielding:

- Decrease the length of time of exposure
- Increase the distance from a source
- Increase shielding



LESSON PLAN

Lesson 4: Lesson Plan

Ionizing Radiation

Overview

This chapter introduces the topics of radioactive decay and half-lives. It also explains what radiation is, where radiation is found in nature (background radiation), human-made radiation, exposure pathways, and effects of radiation on the body. The lesson includes information that may be new to students, but it is an important topic that many people do not understand well.

Concepts

- Definition of radiation
- Ionizing and non-ionizing radiation
- Electromagnetic spectrum
- Types of ionizing radiation
- Radioactive decay
 - Decay chain
 - Half-life
 - Radiation dose
- Radiation protection for workers
- Measurement units for radiation
- Effects of radiation exposure
- Average annual dose of radiation to Americans
- Sources of radiation
 - Background radiation
 - Human-made radiation (medical uses, consumer products, work-related uses)

National Standards (Grades 5-8)

Science

NS. 5-8.1 As a result of their activities in Grades 5-8, all students should develop

- Abilities necessary to do scientific inquiry
- Understanding about scientific inquiry

NS. 5-8.2 As a result of their activities in Grades 5-8, all students should develop an understanding of

- Properties and changes of properties in matter
- Transfer of energy

NS. 5-8.5 As a result of activities in Grades 5-8, all students should develop

- Understandings about science and technology

NS. 5-8.6 As a result of their activities in Grades 5-8, all students should develop understanding of

- Personal health
- Populations, resources, and environments
- Natural hazards
- Risks and benefits
- Science and technology in society

Social Studies

NT.K-12.2 Social, Ethical and Human Issues

- Students understand the ethical, cultural, and societal issues related to technology
- Students practice responsible use of technology systems, information, and software
- Students develop positive attitudes toward technology uses that support lifelong learning, collaboration, personal pursuits, and productivity

Technology

NT.K-12.1 Basic Operations and Concepts

- Students demonstrate a sound understanding of the nature and operation of technology systems
- Students are proficient in the use of technology

NT.K-12.3 Technology Productivity Tools

- Students use technology tools to enhance learning, increase productivity, and promote creativity

NT.K-12.5 Technology Research Tools

- Students use technology to locate, evaluate, and collect information from a variety of sources
- Students use technology tools to process data and report results

Objectives

Upon completing this lesson, students will be able to

- Explain what radiation is
- Describe radioactive decay
- Define half-life
- Explain the difference in energy levels of non-ionizing and ionizing radiation
- Name some examples of non-ionizing radiation
- Name the three main types of ionizing radiation
- Name the sources that constitute background radiation (e.g., terrestrial, space (cosmic), radon, internal)
- Name some sources of human-made radiation
- Describe the units of measure for radiation (e.g., millisievert and millirem)
- Explain how time, distance, and shielding are used in protection from radiation
- Discuss the average annual dose of radiation for U.S. residents
- Recognize the symbol for the presence of radioactive materials

Key Terms / Vocabulary

alpha particle – a positively charged particle emitted by certain radioactive materials; alpha particles can be stopped by a piece of paper

averages – an estimation of or approximation to an arithmetic mean

background radiation – the natural radioactivity in the environment; usually results from cosmic rays from space and from naturally radioactive elements

becquerel (Bq) – an international unit of measure of how much radiation is in a substance; named for French physicist, Henri Becquerel

beta particle – a fast moving electron that is emitted from unstable atoms that are becoming stable; beta particles can be stopped by aluminum foil

cosmic radiation – a source of natural background radiation that originates in outer space and is composed of penetrating ionizing radiation

CT scan – a method of taking images of internal organs; combines x-rays and computer technologies; abbreviation for computed tomography; also known as CAT scan (computerized axial tomography)

curie (Cu) – a traditional unit of measure to describe the intensity of radioactivity in materials

dose – the quantity of radiation administered or absorbed

electromagnetic spectrum – the entire range of wave lengths or frequencies of electromagnetic radiation extending from gamma rays to the longest radio waves and including visible light

emit – to send out or put forth

gamma ray – a type of radiation released in waves by unstable atoms as they become stable; gamma rays can be stopped by lead

Geiger counter – an electronic instrument for detecting and measuring radiation and radioactive substances

half-life – the time needed for half of the atoms in a radioactive substance to disintegrate or undergo radioactive decay

imaging technology – machines capable of making pictures for medical purposes or for collecting data

internal radiation – the radiation we receive from elements inside our bodies based on the foods we eat, the water we drink, and the air we breathe

ion – an atom that has too many or too few electrons, causing it to have an electrical charge

ionizing radiation – radiation that has enough energy to remove electrons from substances that it passes through, thus forming ions

ionization – the process of adding or removing one or more electrons to or from atoms or molecules, thereby creating ions

millirem (mrem) – a traditional unit of measure for the biological effect of exposure to ionizing radiation; a traditional unit being replaced by the international unit millisievert

millisievert (mSv) – an international unit of measure for the biological effect of exposure to ionizing radiation; an international unit replacing millirem

non-ionizing radiation – low energy electromagnetic radiation that does not have enough energy to remove electrons

potassium – an element essential for nerve health; its symbol is K

radioactive decay – the spontaneous change of the atom into a different atom or a different state of the same atom

radiation – fast particles and electromagnetic waves emitted from the center of an atom during radioactive disintegration

radiation dose – term used to refer to the amount of energy absorbed by an object or person per unit mass

radon – heavy radioactive gas formed by the decay of radium; it contributes to the background radiation people are exposed to from nature

rem (from radiation equivalent man) – a traditional unit of absorbed dose of ionizing radiation

sievert – an international unit of measure for the biological effect of exposure to ionizing radiation; an international unit replacing rems

space radiation – radiation from space; see *cosmic radiation*

thorium – a naturally radioactive element with atomic number 90 and an atomic weight of 232; its symbol is Th

ubiquitous – occurring everywhere

uranium – a heavy, hard, shiny metallic element that is radioactive and is used as the fuel for nuclear power plants; its symbol is U

weighted average – an average resulting from the multiplication of each component by a factor reflecting its importance

Lesson Four – Chapter Outline

What is radiation?

- Non-ionizing radiation
- Ionizing radiation

What is the electromagnetic spectrum?

What are the forms of ionizing radiation?

- Alpha and beta particle, gamma rays

How does ionizing radiation deposit energy?

- Alpha particle penetration and deposition
- Beta particle penetration and deposition
- Gamma ray and x-ray penetration and deposition

Where does radiation come from?

- Unstable isotopes becoming more stable
- Radioactive decay

What is half-life?

- Definition
- Examples

What is radiation dose?

- Rule of time, distance, shielding
- Symbol

How do we measure radiation?

- Traditional and international units

What does radiation do?

- High doses
- Low doses

Where does our exposure to radiation come from?

- Average annual dose of 6.25 millisievert (mSv) or 625 millirem (mrem) in United States
- Medical, commercial, industrial, and background percentages

What is background radiation?

- Terrestrial, cosmic, radon, internal

What is terrestrial radiation?

- Averages in U.S. regions

What is space radiation?

- Effect of elevation, distance to equator

What is radon?

- Description
- Entries into buildings

What is internal radiation?

- From food, water, air we take into our bodies

What are some human-made sources of radiation?

- Medical
- Products like smoke detectors, building materials
- Contribution from nuclear power plants

Reading

Reading for this lesson in the student reader can be assigned as homework prior to this class session, or it can be read in class as guided reading.

Performance Assessment and Extensions

A Reading Review Exercise follows that you can reproduce or project for your class. The labs and activities that follow include inquiry-based questions that can be used to assess student learning. Accompanying this lesson is a PowerPoint lecture with a review that can be used as an interactive assessment. For a project-based assessment, have students create a blog, podcast, or video on a topic from this lesson.

Supplemental Information

Direct and indirect observation

You may want to discuss direct and indirect observation. You might engage students' interest by having a paper bag or small box with some unseen items such as a strong magnet, something with a strong odor of cinnamon, a marble, a cat collar with a bell, etc. Let individual students come to the front of the class and hold a strong magnet to it, roll it around, smell it, shake it, etc., and make guesses about its contents. You can also give the following examples of direct and indirect observation: Direct observation is seeing a bear. Indirect observation is a person on a camping trip discovering his backpack ripped open, claw marks on a tree, large paw prints on the ground, and saying, "A bear probably did this."

Decimals, Averages, and Weighted Averages

Students may need a review of decimals. Students could also discuss the effect of the fact that weighted averages (using population densities) are used to establish the exposure for the average American. They should also understand that the numbers they are adding for their personal exposure are averages. They give an idea or estimate of exposure but are not exact.

Using their grades as a quick example of weighted averages may help students understand the concept. For example: If a student takes four tests and the tests all count equally, the grade will be different from what it would be if one test counted more. If there are four tests in the grading period – three chapter tests and one final test for the grading period – with scores of 70, 80, 90, and 100, the average is 85 if they all count equally. ($340 / 4 = 85$)

But if the final test counts three times as much as a chapter test, the weighted average of the same test scores of 70, 80, 90, and 100 is 90. ($540 / 6 = 90$)

Lesson 4 Reading Review Exercise

A. Fill in the blanks below.

1. Name three sources of natural background radiation.

2. Name three sources of human-made radiation.

B. Indicate whether each statement is true (T) or false (F) by circling the correct letter. If the statement is false, correct it to make it true.

- | | | |
|--|---|---|
| 1. Radiation exists in nature. | T | F |
| 2. Unstable isotopes can change from one form to another by emitting particles and rays. | T | F |
| 3. People who live at sea level are exposed to more background radiation than people who live at high altitudes. | T | F |
| 4. High energy electromagnetic radiation is called non-ionizing radiation. | T | F |
| 5. We are exposed to radiation from the food we eat and the water we drink. | T | F |
| 6. The average American receives 6.25 millisieverts (625 millirem) each year. | T | F |
| 7. Background radiation includes radiation from rocks and soils, space, the food we eat and water we drink, and medical imaging. | T | F |
| 8. Where we live affects our exposure to ionizing radiation. | T | F |
| 9. Most of the radiation the average American is exposed to comes from nuclear power plants. | T | F |
| 10. Having an x-ray to see if your arm is broken exposes you to radiation. | T | F |

Lesson 4 Reading Review Exercise - Answers

A. Fill in the blanks below.

1. Name three sources of natural background radiation.

space, rocks, soils, plants, food, water, milk, radon

2. Name three sources of human-made radiation.

medical and dental x-rays, building materials such as bricks, smoke detectors, some dish-ware, tiles

B. Indicate whether each statement is true (T) or false (F) by circling the correct letter. If the statement is false, correct it to make it true.

- | | |
|--|-------|
| 1. Radiation exists in nature. | (T) F |
| 2. Unstable isotopes can change from one form to another by emitting particles and rays. | (T) F |
| 3. People who live at sea level are exposed to more background radiation than people who live at high altitudes. <i>High altitude receives more</i> | T (F) |
| 4. High energy electromagnetic radiation is called non-ionizing radiation.
<i>High energy electromagnetic radiation is ionizing radiation</i> | T (F) |
| 5. We are exposed to radiation from the food we eat and the water we drink. | (T) F |
| 6. The average American receives 6.25 millisieverts (625 millirem) each year. | (T) F |
| 7. Background radiation includes radiation from rocks and soils, space, the food we eat and water we drink, and medical imaging. <i>Radon, not medical imaging</i> | T (F) |
| 8. Where we live affects our exposure to ionizing radiation. | (T) F |
| 9. Most of the radiation the average American is exposed to comes from nuclear power plants. <i>Largest sources are natural background and medical uses.</i> | T (F) |
| 10. Having an x-ray to see if your arm is broken exposes you to radiation. | (T) F |

Activities, Labs, and Supplemental Information

Teacher's PowerPoint Presentation

A Teacher's (PowerPoint) presentation is provided on CD and online on the DOE Office of Nuclear Energy website to help you present chapter concepts to your class. Download the teacher presentation at: <http://energy.gov/ne/services/harnessed-atom>

Activity - Calculating Your Personal Radiation Dose

The primary out-of-class activity for Lesson 4 is *Calculating Your Personal Radiation Dose*. Students will complete a form to determine their personal exposure. Completing this activity will help students understand that their personal exposure may differ from the exposure of the average American. They can compare the results for their personal radiation exposure to the exposure for the average American. Students can use the attached worksheet or a longer online version available on the American Nuclear Society's site at www.new.ans.org/pi/resources/dosechart/

Lab - The Cloud Chamber

A favorite lab for many students is the cloud chamber, which can be conducted following directions provided later in this section. The lab can be done by groups of four or five students or one cloud chamber can be done for the class. Cloud chamber kits are available from science supply houses. Dry ice can be obtained in many grocery stores. A CO₂ fire extinguisher can also be used as a source for the dry ice. (Blowing it through a burlap bag reduces mess.)

Safety Precautions

- Do not touch dry ice. Frozen CO₂ has a surface temperature of -78.5°C (-109.3°F) and will injure skin on contact. Use gloves or tongs to handle it. Use in a well-ventilated area. Dispose of dry ice outside in a protected place.
- Ethyl alcohol is flammable. Do not use it near an open flame or a heat source. Use in a well-ventilated area.

Before doing the activity, review the Material Safety Data Sheets (MSDS) for dry ice and ethyl alcohol. This lab provides an opportunity to introduce students to MSDS by having one of the students enter "MSDS for dry ice" or "MSDS for ethyl alcohol" in a search engine.

Doing the cloud chamber as a hands-on activity is highly recommended. Students find this lab very interesting, and they usually remember it for a long time. However, if you cannot do the activity as a lab, a video of a cloud chamber is available in the Teachers' PowerPoint Presentation. You will find it on the CD provided or at <http://energy.gov/ne/services/harnessed-atom>

While observing the cloud chamber, the students should look for alpha, beta, and gamma radiation. An explanation of the type of the types of "footprints" is on the activity sheet. They should understand that

they are not seeing radiation. It's an indirect observation. They are seeing the tracks of atom "pieces" the atoms are throwing out as they break down. The activity can lead to a review of radiation, half-life, and radioactive decay.

Lab - Half-Life Penny

This lab simulates the mathematical principles of radioactive decay and demonstrates how half-life can be determined. Directions for this lab are provided later in this section.

Lab - Half-Life Licorice

This in-class lab also simulates the mathematical principles of radioactive decay graphically and has directions provided later in this section. Follow your school's rules about eating the "decayed" licorice.

Lab - Using a Geiger Counter

Students will test items to determine which items have the highest readings on a Geiger counter. They will record their results. They will also repeat the lab using various shielding materials and record their results. Then they can draw conclusions about the shielding materials they used. It might be interesting to videotape the activity and post it. Note: possible sources for a Geiger counter include a local utility, a local college or university, local emergency response personnel, and online sources.

Supplemental Information

Pictures of Radioactive Consumer Products

Pictures of consumer products that are radioactive are available at the following link:

www.orau.org/ptp/collection/consumer%20products/consumer.htm

In addition to pictures, text is also provided that explains why each product is radioactive.

Geiger Counters and Film Badges

Remember that ionizing radiation has enough energy to knock electrons off atoms it interacts with. Since electrons have a negative charge, atoms that lose electrons become positively charged. This is because the number of positively charged protons left in the nucleus is greater than the number of negatively charged electrons left. By using this idea, scientists have designed Geiger counters that react to tiny electrical impulses caused by ionizing radiation. A clicking noise or a needle that moves on a dial tells us radiation is being emitted.

Photographic film can also be used to test for exposure to radiation. Radiation that strikes photographic film affects it much the same way light does. The difference is that radiation can penetrate through materials that can stop light. As a result, people who might be exposed to radiation often wear a film badge that will record exposure to radiation, by exposing the photographic film. By developing the film, radiation technicians can precisely determine how much radiation the person wearing the badge received.

Activity – Calculating Your Personal Radiation Dose

Calculate how much radiation you receive each year

Radiation is energy or tiny particles given off by certain kinds of energetic atoms. We live in a radioactive world. Radiation is all around us and is part of our natural environment. It comes from the surface of the Earth, from space, the food we eat and the water and milk we drink. Even your body is radioactive. We also get radiation from human-made things like bricks, x-rays machines, and smoke detectors.

Small amounts of radiation are measured in units called millirem or millisievert. The average American receives about 620 millirem (6.2 millisievert) a year from all sources. This average is for the entire population of the United States. It is a weighted average that takes into account things like the population density in the various regions of the country.

Elevation

Find your elevation online or in the library for where you live. Use the numbers below to fill in the chart on the next page.

0 – 1000 ft	26 millirem
1001 – 2000 ft	31 millirem
2001 – 3000 ft	35 millirem
3001 – 4000 ft	41 millirem
4001 – 5000 ft	47 millirem
5001 – 6000 ft	52 millirem
6001 – 7000 ft	66 millirem
7001 – 8000 ft	79 millirem
8001 – 9000 ft	96 millirem

(Source: American Nuclear Society)

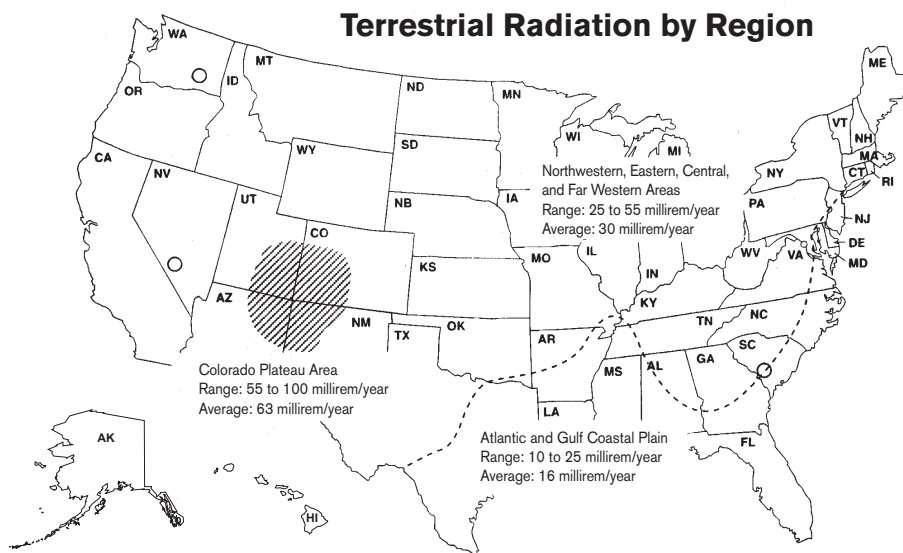

After you have filled in the chart on the next page, answer the following questions:

1. What three radiation sources contribute the most to your yearly total dose? _____

2. The least? _____
3. What source surprises you the most? _____

Personal Dose Chart

millirem

Radiation from the Sun and outer space

Some radiation is stopped by the atmosphere. Find the elevation of your home town. Use the table on the previous page to select the amount of space radiation you receive based on elevation.

Terrestrial radiation (from the Earth)

Use the map on the previous page to find the amount of radiation in your area from rocks and soils. (Use the average amount.)

Your home and activities

Building materials are radioactive.

If your home is brick, adobe, or concrete, add 7 millirem.

For each hour you have spent flying on a jet this year, add 0.5 millirem.

Power plants

If you live within 50 miles of a nuclear power plant, add 0.01 millirem.

If you live with 50 miles of a coal-fired power plant, add 0.03 millirem

Internal radiation

From food, milk, water, add 40 millirem

From air (radon you inhale), add 228 millirem

Consumer products

If there is a smoke detector in your home, add 0.008 millirem.

Medical

For each dental x-ray you have had this year, add 0.5 millirem.

For each x-ray of an arm, hand, leg, or foot you have had this year, add 0.5 millirem.

For each x-ray of your skull you have had this year, add 10 millirem.

For each CT scan of your head, add 200 millirem.

For each CT scan of your arm, hand, leg, or foot you have had this year, add 10 mrem.

YOUR YEARLY TOTAL

Lab – Cloud Chamber

Have you seen the “footprints” of radiation?

While radiation cannot be seen, the cloud chamber allows you to see the tracks radiation leaves in a dense gas.



Caution:

- Wear eye protection for this lab.
- Do not touch dry ice. Use tongs or insulated gloves.
- Ethyl alcohol is flammable. Do not use near an open flame or hot surface.
- Pebbles containing uranium, or lantern mantles, are not hazardous, but keep them away from your face. Wash your hands after handling.

Materials

- Clear plastic lab dish with black bottom, clear lid, and ring of felt or Velcro® around top (see picture)
- Pure ethyl alcohol
- Thin block of dry ice, slightly larger than dish
- Gloves or tongs to handle the dry ice
- Radioactive source (chips of orange antique Fiestaware, uranium ore pebble or lantern mantle)
- Bright flashlight (LED flashlight works well) or projector lamp

Procedure

1. Pour several drops of alcohol along the top rim of the cloud chamber so that it wets the felt or Velcro® strip. Do not use so much that it pools at the bottom of the chamber. If it pools, pour out excess.
2. Place the radioactive source in the cloud chamber and put the lid on tightly.
3. Place the cloud chamber on top of the dry ice to chill it.
4. Wait 2 to 5 minutes.
5. Darken the room. After a few minutes, visible tracks should begin to appear in the chamber. Shine a strong flashlight from the top or side to highlight tracks. The black bottom of the dish makes them easier to see. You are looking for little “puffs” or “trails” coming from the source. They will look like the trails jets leave in the sky. Warming the top with your hand can help get it started. It may also help to move the angle of the flashlight.

Try to identify these types of “footprints”

Alpha – bright, short, straight tracks about 1 cm long

Beta – thin, twisting tracks about 3 cm to 10 cm long. Beta’s small mass and negative charge cause it to bounce away from air molecules it strikes.

Gamma – long, thin, scattering tracks. Gamma rays can knock off air molecules, causing a scattering track.

Questions

1. Because you could not actually see the radiation, what kind of observation did you carry out?

2. What is actually happening to the radioactive source? _____

3. What radiation “footprints” did you see? Describe them.

Lab – Cloud Chamber - Answers

Have you seen the “footprints” of radiation?

While radiation cannot be seen, the cloud chamber allows you to see the tracks radiation leaves in a dense gas.



Caution:

- Wear eye protection for this lab.
- Do not touch dry ice. Use tongs or insulated gloves.
- Ethyl alcohol is flammable. Do not use near an open flame or hot surface.
- Pebbles containing uranium, or lantern mantles, are not hazardous, but keep them away from your face. Wash your hands after handling.

Materials

- Clear plastic lab dish with black bottom, clear lid, and ring of felt or Velcro® around top (see picture)
- Pure ethyl alcohol
- Thin block of dry ice, slightly larger than dish
- Gloves or tongs to handle the dry ice
- Radioactive source (chips of orange antique Fiestaware, uranium ore pebble or lantern mantle)
- Bright flashlight (LED flashlight works well) or projector lamp

Procedure

1. Pour several drops of alcohol along the top rim of the cloud chamber so that it wets the felt or Velcro® strip. Do not use so much that it pools at the bottom of the chamber. If it pools, pour out excess.
2. Place the radioactive source in the cloud chamber and put the lid on tightly.
3. Place the cloud chamber on top of the dry ice to chill it.
4. Wait 2 to 5 minutes.
5. Darken the room. After a few minutes, visible tracks should begin to appear in the chamber. Shine a strong flashlight from the top or side to highlight tracks. The black bottom of the dish makes them easier to see. You are looking for little “puffs” or “trails” coming from the source. They will look like the trails jets leave in the sky. Warming the top with your hand can help get it started. It may also help to move the angle of the flashlight.

Try to identify these types of “footprints”

Alpha – bright, short, straight tracks about 1 cm long

Beta – thin, twisting tracks about 3 cm to 10 cm long. Beta’s small mass and negative charge cause it to bounce away from air molecules it strikes.

Gamma – long, thin, scattering tracks. Gamma rays can knock off air molecules, causing a scattering track.

Questions

1. Because you could not actually see the radiation, what kind of observation did you carry out?
Indirect observation.
2. What is actually happening to the radioactive source? *It is undergoing radioactive decay.*
3. What radiation “footprints” did you see? Describe them.
Answers will vary. Descriptions are given on the lab sheet. Students should identify tracks from alpha or beta particles and/or gamma rays that they saw in this lab.

Lab – Penny Half-Life

In this lab, the class will simulate radioactive decay and show how the half-life of pennies can be determined.

Materials (For each pair of students)

- Plastic baggie with 50 pennies
- Graph paper
- Colored pencils
- Paper plate

Procedure

1. Gently pour the pennies onto the paper plate. If a penny lands heads side up, it is still “radioactive.”
2. Count the pennies that are still “radioactive.” Record the results in the table below. Remove the pennies that are no longer “radioactive.”
3. Put the “radioactive” pennies back in the bag and shake gently. Repeat steps until there are no “radioactive” pennies.
4. Graph results. In making the graph, use the X axis for the number of the trial and the Y axis for the number of “radioactive” pennies remaining.
5. If there is time and enough pennies, repeat the activity with a second bag of 50 pennies. Use a different color pencil to graph your results so you can tell the results apart.

Pour Number	Number Decayed	Number Radioactive
1		
2		
3		
4		
5		
6		
7		
8		
9		
10		



1. Is the number of decays on each turn always one half number of pennies poured? _____
2. Why or why not? _____

Lesson 4 IONIZING RADIATION

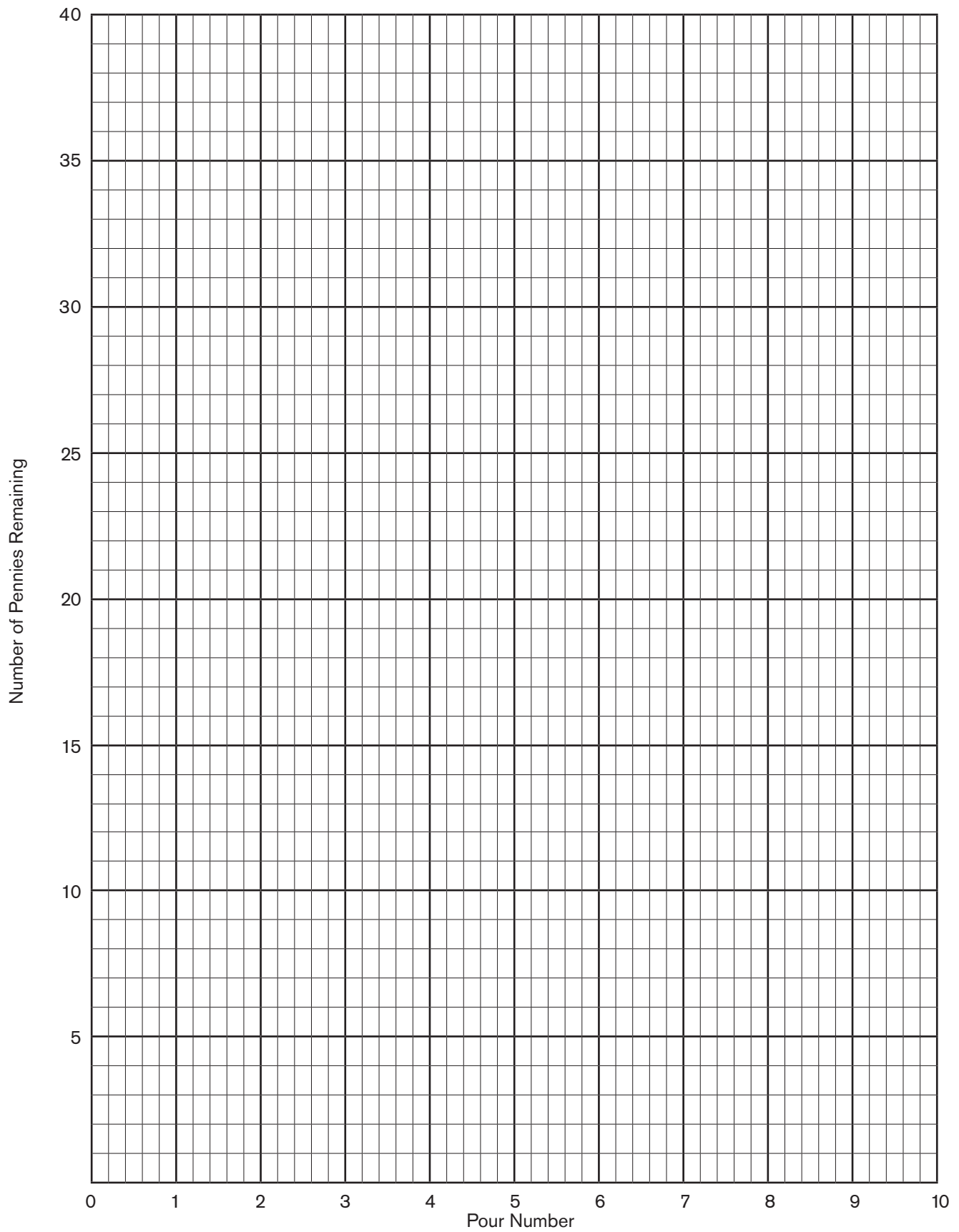

Lab – Penny Half-Life - Answers

In this lab, the class will simulate radioactive decay and show how the half-life of pennies can be determined.

Materials (For each pair of students)

- Plastic baggie with 50 pennies
- Graph paper
- Colored pencils
- Paper plate

Procedure

1. Gently pour the pennies onto the paper plate. If a penny lands heads side up, it is still “radioactive.”
2. Count the pennies that are still “radioactive.” Record the results in the table below. Remove the pennies that are no longer “radioactive.”
3. Put the “radioactive” pennies back in the bag and shake gently. Repeat steps until there are no “radioactive” pennies.
4. Graph results. In making the graph, use the X axis for the number of the trial and the Y axis for the number of “radioactive” pennies remaining.
5. If there is time and enough pennies, repeat the activity with a second bag of 50 pennies. Use a different color pencil to graph your results so you can tell the results apart.

Pour Number	Number Decayed	Number Radioactive
1		
2		
3		
4		
5		
6		
7		
8		
9		
10		



1. Is the number of decays on each turn always one half number of pennies poured? No
2. Why or why not? This is an average. Just as radiation is random, so is the way pennies land.

Lab – Licorice Half-Life

(Adapted from Tim DeVries, Penn State)

Half-life is the time required for one-half of a radioactive material to decay, changing into something else. Radioactive atoms have nuclei that are unstable. By emitting particles or rays, these nuclei become more stable. The half-life of an isotope is a physical property. The half-life can be from fractions of a second to billions of years. Half-lives are constant. There is no way to speed up or slow down the natural process of decay.

Materials

- One piece of “shoelace” licorice per student or group of two students
- Graph paper

Procedure

1. Set up your graph as follows:
 - Title: Half-life of Licorice
 - Label the y-axis as “Percent licorice remaining.”
 - Label the x-axis as “Time (seconds).” The values on this axis should range from -10 to 90.
2. Place a piece of licorice on the graph paper and stretch it full length up and down over the zero mark. With a pencil, mark the graph paper at the very top of the piece of licorice. This mark represents 100% of the licorice, so write 100 on the y-axis (100% of licorice remaining) at the very top of the piece of licorice.
3. When your teacher says, “Go,” you will have 10 seconds to break off and dispose of exactly half of your licorice. Then place the remaining licorice on the graph over the 10-second line and mark the height of the remaining licorice. Write “50” at the correct place on the y-axis.
4. At time 20 seconds, your teacher will again say, “Go,” and you should again break off exactly half of the remaining licorice. Record the new height of the licorice at 20 seconds and write 25 on the y-axis. Continue the procedure as directed by your teacher until 90 seconds have gone by.
5. Connect all the height marks with a line between each 10-second interval, completing the graphs of the “half-life of licorice.”

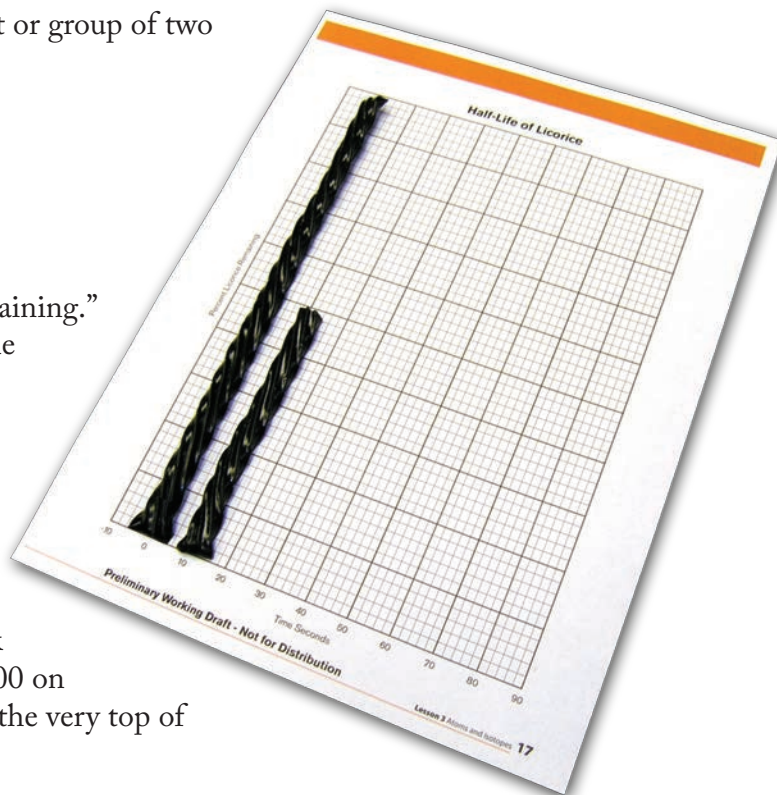

Half-Life of Licorice

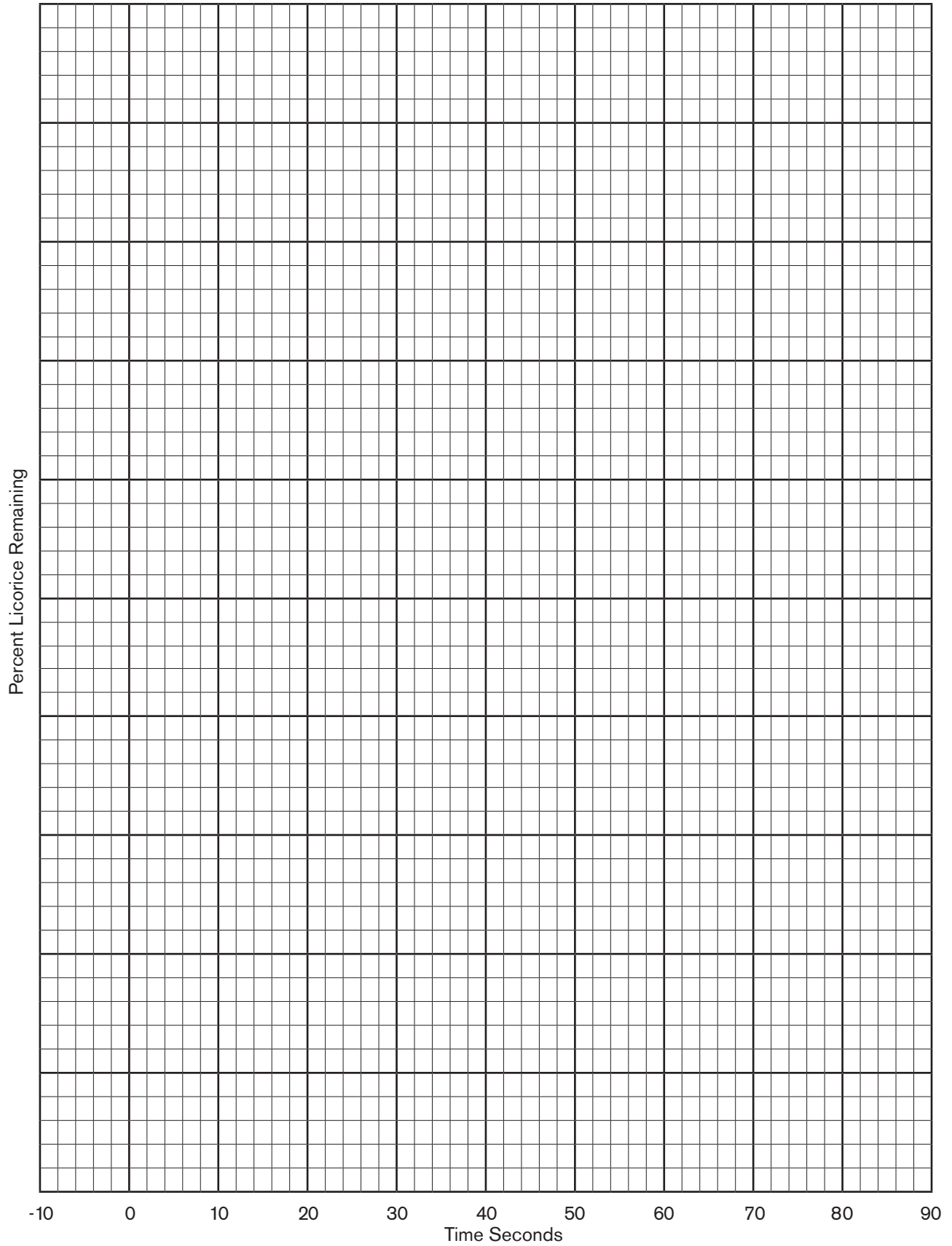

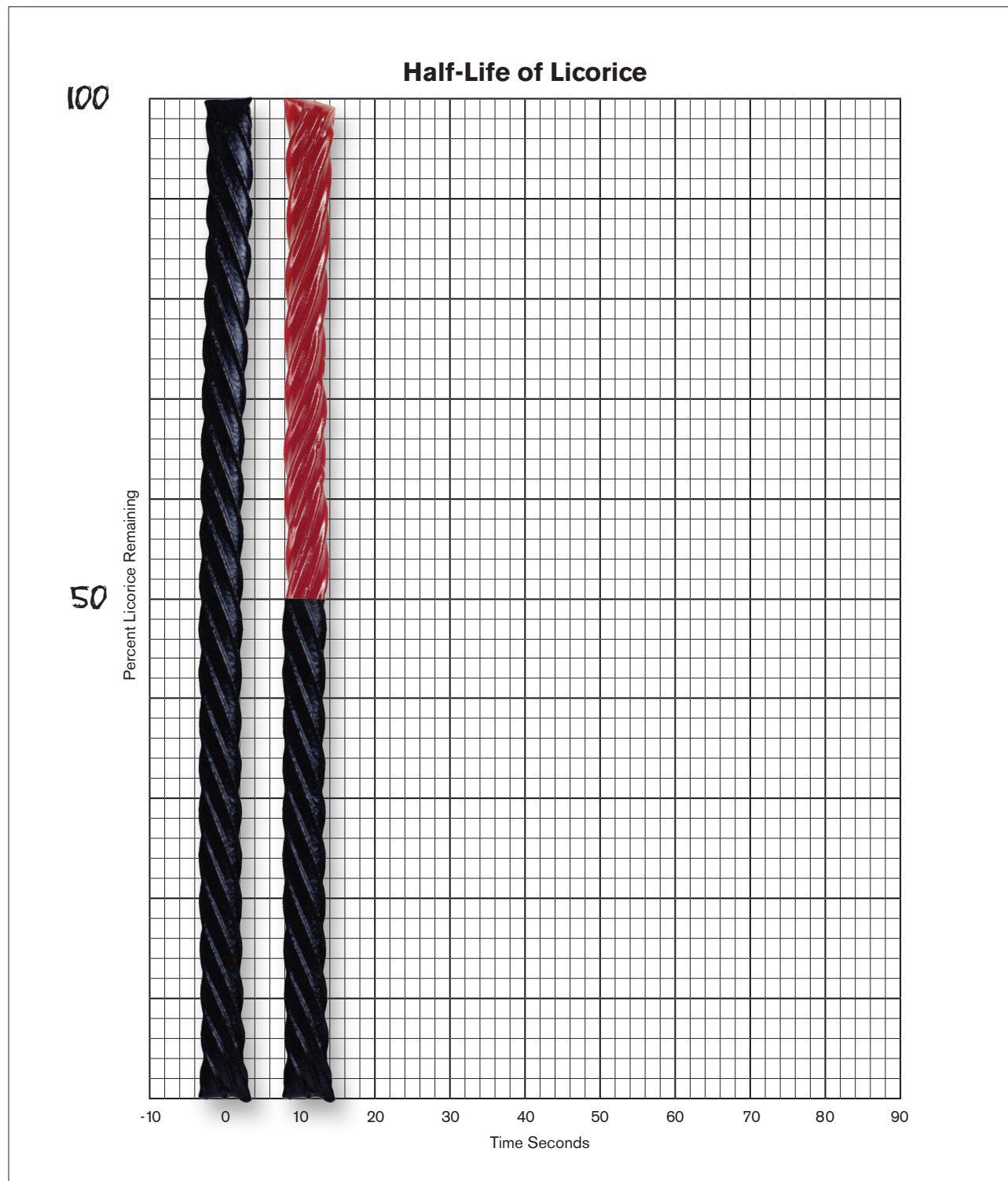

Half-life is the time required for one-half of the radioactivity of a material to decay. The original material does not disappear as the radioactivity decreases. Radioactive atoms decay into more stable nuclides. The total number of atoms stays the same.

Lab – Using a Geiger Counter

How radioactive are different materials?

Materials

- Geiger counter
- **Radioactive sources such as:**
 - Gas lantern mantle
 - Cloisonné jewelry
 - Orange-glazed ovenware
 - Commercially available source from scientific supply company
 - Luminescent clock face
 - Smoke detector
 - Salt substitute (containing potassium)
- **Shielding materials such as:**
 - Paper
 - Aluminum foil
 - Brick
 - Jar of water
 - Piece of wood
 - Glass pane
 - Sheet of lead
 - Piece of cloth

Procedure

1. One at a time, test each item that is a source of radioactivity by placing the source 2 inches from the Geiger counter probe. Use the chart to record your readings.

Which item has the highest reading? _____

The lowest? _____

2. Now place the radioactive source that had the highest reading 2 inches from the Geiger counter probe. One at a time, test each of your shielding materials by placing it between the source and the probe. Use the chart to rate each of the shielding materials.

Do you think the density of the shield is important?

Why? _____



Other Ideas To Explore

What happens when the radioactive source is moved further from the Geiger counter?

Will less radiation be counted if you pass the source quickly by the counter?

How do doctors and dentists shield themselves when taking x-rays?

Why is it important that all materials be measured at exactly the same spot with the probe at the same distance?

Source	Geiger Counter Reading

Shielding Material	Geiger Counter Reading

Lab – Using a Geiger Counter - Answers

How radioactive are different materials?

Materials

- Geiger counter
- **Radioactive sources such as:**
 - Gas lantern mantle
 - Cloisonné jewelry
 - Orange-glazed ovenware
 - Commercially available source from scientific supply company
 - Luminescent clock face
 - Smoke detector
 - Salt substitute (containing potassium)
- **Shielding materials such as:**
 - Paper
 - Aluminum foil
 - Brick
 - Jar of water
 - Piece of wood
 - Glass pane
 - Sheet of lead
 - Piece of cloth

Procedure

1. One at a time, test each item that is a source of radioactivity by placing the source 2 inches from the Geiger counter probe. Use the chart to record your readings.

Which item has the highest reading? Answers will vary.

The lowest? Answers will vary.

2. Now place the radioactive source that had the highest reading 2 inches from the Geiger counter probe. One at a time, test each of your shielding materials by placing it between the source and the probe. Use the chart to rate each of the shielding materials.

Do you think the density of the shield is important?

Yes. The more dense the material, the more shielding it provides.

Why? Shielding results vary according to the type of ionizing radiation. Alpha particles are blocked by paper. Beta particles are stopped by aluminum foil. Lead, water, and concrete stop gamma rays.



Other Ideas To Explore

What happens when the radioactive source is moved further from the Geiger counter?

Increasing distance from the source reduces radiation that reaches the counter.

Will less radiation be counted if you pass the source quickly by the counter?

Yes. Decreasing the time of exposure reduces dose.

How do doctors and dentists shield themselves when taking x-rays?

Apply the rules of time, distance, shielding.

Why is it important that all materials be measured at exactly the same spot with the probe at the same distance?

Because distance from a radiation source affects the measurements.

Source	Geiger Counter Reading

Shielding Material	Geiger Counter Reading

FISSION, CHAIN REACTIONS



Introduction

We have learned how the nuclei of atoms store energy and how unstable atoms decay and release energy. How do nuclear engineers use this knowledge to help them harness energy to make electricity? The answer lies in being able to start a nuclear chain reaction in fuel inside a nuclear power plant and keep it going. In this lesson, we'll look closely at nuclear reactions called fission. We'll also learn how uranium is processed from ore to fuel.

TOPICS:

- Fission
- Chain reactions
- Uranium fuel
- Mining
- Milling
- Enrichment
- Fuel fabrication

What is fission?

When scientists began to understand the forces that bind atoms together, they wondered if a machine could be built to harness this energy. A team of scientists led by Enrico Fermi built a machine to harness the energy within atoms in 1942 at the University of Chicago. The machine, a **reactor**, caused uranium atoms to split in a process called **fission**. Fission releases energy from the nucleus of the atoms.

When a **neutron** strikes the nucleus of uranium-235, the nucleus becomes more unstable, vibrates, and then splits apart. All this takes about a millionth of a second.

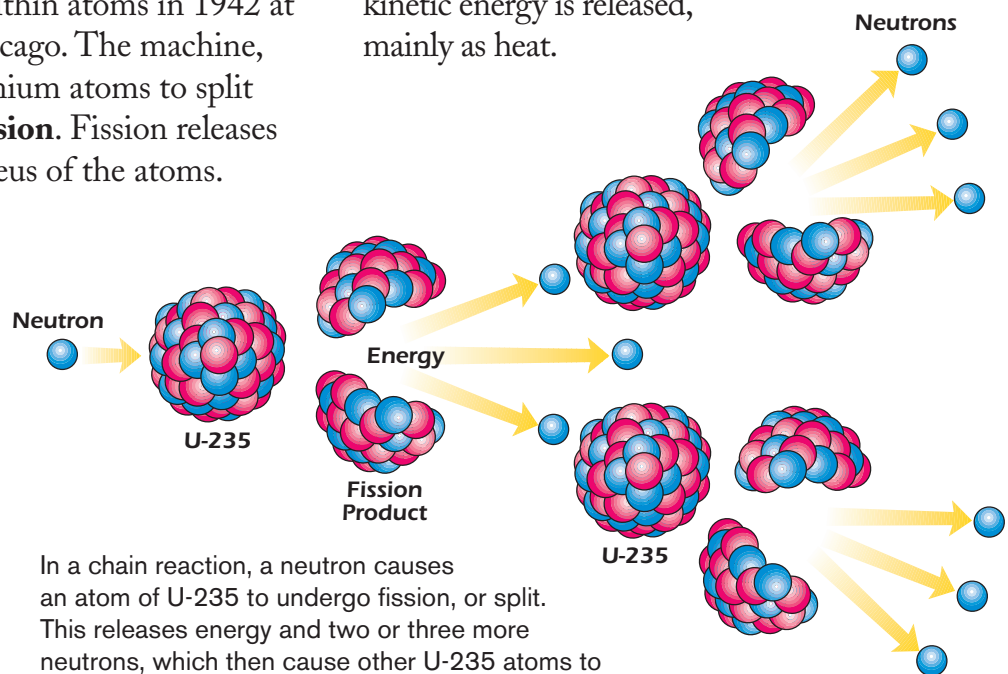

In a chain reaction, a neutron causes an atom of U-235 to undergo fission, or split. This releases energy and two or three more neutrons, which then cause other U-235 atoms to split. This continues the reaction.

What is a nuclear chain reaction?

Splitting an atom apart releases a lot of energy, especially considering its size. But splitting one atom does not produce enough heat to be useful. We need to fission millions of atoms to get enough heat to do work.

How can we do that? The answer lies in the two or three neutrons that fly off when the first atom is split. If these neutrons hit other uranium-235 atoms, these atoms also fission, each releasing heat and two or three more neutrons. Under the exactly right conditions, we can get millions of atoms fissioning. When that happens, it gives off enormous heat. This chain of events is called a **nuclear chain reaction**.

Keeping a chain reaction going is actually very difficult. This is because many of the neutrons that fly away from each fission will not hit another uranium atom's nucleus. If more miss than hit, the chain reaction will quickly slow down and stop.

The heat we get from a chain reaction comes from breaking the strong force in the nucleus and forming new bonds. In this process, a tiny amount of mass is converted into energy ($E=mc^2$).

As fission products bounce off neighboring atoms, kinetic energy is converted to heat by friction.

What is the fuel at a nuclear power plant?

The fuel at a nuclear power plant is uranium-235. The heat produced by the

fissioning of billions of uranium-235 atoms heats water, which produces steam. This steam turns turbines to generate electricity. The major difference between a nuclear power plant and one that burns coal is the way the heat to make steam is produced. The rest of the nuclear power plant is very similar.

Where does uranium come from?

Uranium formed in the supernovae that created our solar system about 4.6 billion years ago. It was part of the material in space that became the Earth. Uranium is a dense metal element that holds a tremendous amount of energy in its nucleus. This element occurs in small amounts all over the world, even in

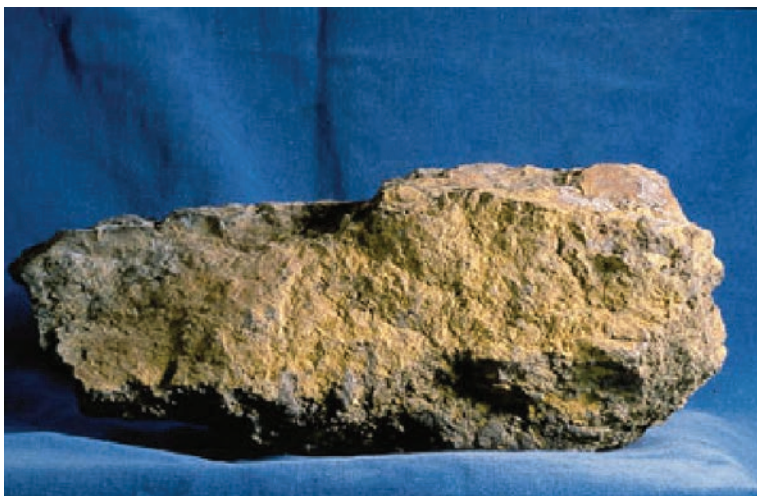

Uranium is found in rocks and soil around the world. Rock that contains 2 to 4 pounds of uranium per ton is called uranium ore.

seawater. Rocks that contain uranium are called **uranium ore**. Typically, a ton of uranium ore contains 2 to 4 pounds of uranium. Before we can use uranium to generate electricity, we must mine it, separate it from the ore, and process it. Let's look at the steps in taking uranium from a mineral in the Earth to nuclear fuel.

Teachers' Notes:

Do most fuels have to be changed before they can be used?

Kerosene, gasoline, and heating oil are produced from crude oil by a series of processing steps called refining. Crude oil is refined to produce kerosene, gasoline, and heating oil by fractional distillation or "cracking."

Coal is cleaned and ground to the consistency of talcum powder before it is used in a coal-fired power plant.

A distinctive odor is added to natural gas so people can detect its presence. Adding odor does not affect its use but makes it safer.

How is uranium mined?

Workers can mine uranium ore in much the same way they mine coal, either in deep underground mines or in open-pit surface mines. They can use machines to dig the ore from the Earth. However, today, miners often take uranium from the ground by a process called **in-situ leaching**. Workers drill into the rock and inject solutions that dissolve the uranium from the ore. Then they pump out the solution that contains the dissolved uranium from a second well.

Teachers' Notes:

Uranium in nature is 99.2739 percent U-238, 0.7205 percent U-235, and 0.0056 percent U-234.

Mining any mineral alters the environment and disturbs the habitat of plants and animals. To minimize damage and to protect the environment, when mining ends, mining companies must replant and restore the land. This process is called **reclamation**. Federal, state, and local agencies enforce mining laws that help protect mine workers and the environment.

Teachers' Notes:

Uranium ore is not the only type of ore that must be milled before processing. Few metals are found in their pure form. Generally, they must be extracted from the rock they are found in before they can be used.

What is uranium milling?

If miners remove the ore as rock, the uranium ore is crushed. Crushed ore is put in an acid. The acid dissolves the uranium but not the rock. The solution is dried, leaving a yellow powder called **yellowcake**, which is mostly uranium. The process of removing uranium from the ore is called uranium **milling**.

The leftover rock is known as **mill tailings**. Mill tailings contain other minerals, including the element radium. Radium gives off a radioactive gas called radon. Uranium mill tailings are disposed of by putting them back in the ground and covering them with soil and clay to keep radon in and water out.



The end result of uranium milling is a dry, yellow powder known as yellowcake.

What is enrichment?

Less than 1 percent of the atoms in natural uranium are uranium-235 atoms. Most of the rest of the uranium atoms are uranium-238. However, power plants need uranium that is about 4 percent uranium-235. This means that before it can be made into reactor fuel, we must increase the concentration of uranium-235 in a process called **uranium enrichment**.

How do we enrich uranium?

Isotopes of uranium-238 contain three more neutrons than isotopes of uranium-235. This gives them a tiny bit more mass. This tiny difference in mass makes it possible to separate these two isotopes of uranium. We can make fuel richer in uranium-235.

Before uranium can be enriched, it is purified and combined with fluorine at a conversion plant. This compound is **uranium hexafluoride**, also known by its chemical name, UF_6 .

Next, it is shipped to a facility where it is heated to a gas and pumped through barriers that contain extremely tiny holes that act as filters. Because it has about 1 percent less mass, uranium-235 moves through the holes a bit more easily than uranium-238. By the time the gas has gone through thousands of filters, the percentage of uranium-235 has enriched from less than 1 percent to about 4 percent.

Gaseous Diffusion Enrichment

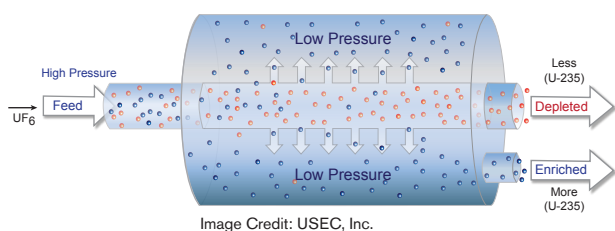

In gaseous diffusion, uranium hexafluoride gas is pumped through many filters called barriers. Each time the gas goes through a filter, the concentration of uranium-235 gets slightly richer.

A more energy-efficient process uses a **centrifuge** to enrich uranium. A centrifuge separates heavier materials from lighter ones by spinning them. UF_6 gas is placed in a cylinder, which then rotates at a very high speed. The rotation makes the heavier uranium-238 molecules move toward the outside wall while the lighter uranium-235 molecules collect near the center. This process is repeated until the percentage of uranium-235 has increased to about 4 percent.

How is the uranium prepared for the reactor?

We can't just put uranium into the reactor the way we pour coal into a furnace. Enriched

uranium must be taken to a fuel fabrication plant where it is made into reactor fuel. At the fabrication plant, uranium is pressed into solid, ceramic **fuel pellets**. These fuel pellets can withstand very high temperatures, much like ceramic tiles or oven-proof cookware. Fuel pellets are about 1 centimeter (3/8 inch) in diameter and about 2 centimeters (3/4 inch) long. Workers stack fuel pellets in fuel rods. Then they bundle fuel rods together as fuel assemblies.

How much energy is in uranium fuel?

Energy in uranium is extremely concentrated. A uranium fuel pellet weighs less than 14 grams (0.5 ounce), which is less than an empty aluminum soft drink can. Each pellet can release as much energy as 477 liters (126 gallons) of oil, 1 metric ton (2,200 pounds) of coal, or 2.3 metric tons (5,000 pounds) of wood. This means that there is a very large amount of energy available to generate heat and make electricity.

Centrifuge Enrichment

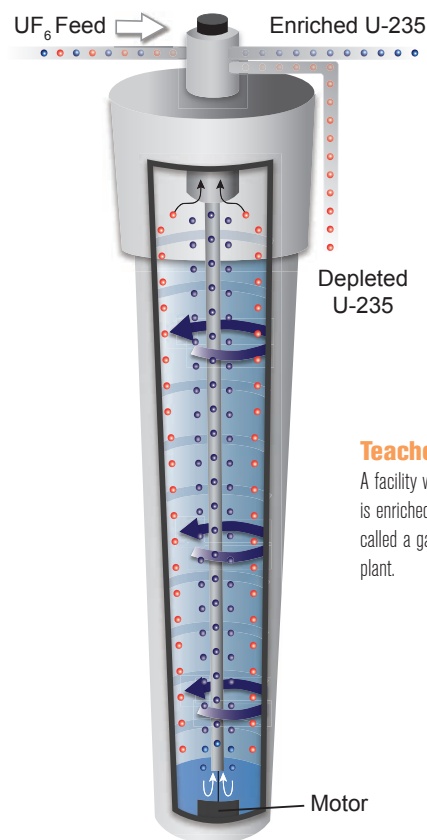

Teachers' Notes:

A facility where uranium is enriched by diffusion is called a gaseous diffusion plant.

Centrifuge enriches fuel by spinning uranium hexafluoride. Heavier uranium-238 moves toward cylinder walls. Uranium-235 collects near the center.

Fuel Equivalents

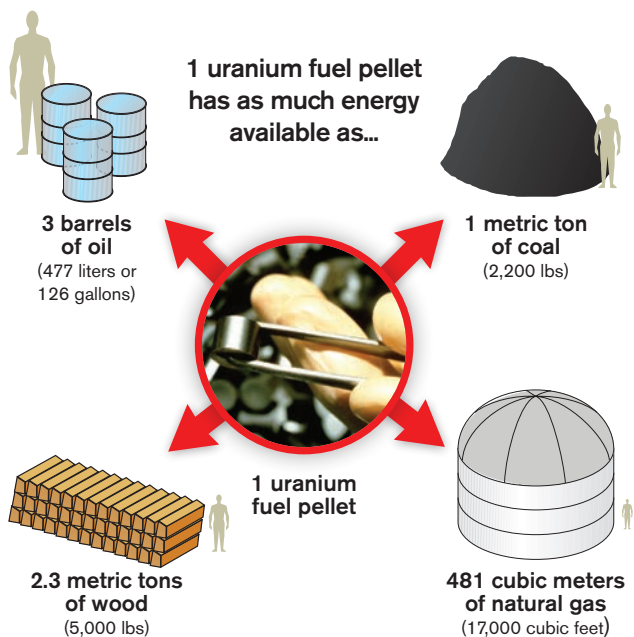

Each fuel rod holds about 200 fuel pellets and is about 4 meters long. A single fuel rod does not contain enough uranium-235 for a fission chain reaction. So, depending on the design of the power plant where they will be used, 63 to 264 fuel rods are bundled together in a fuel assembly. A reactor core has 200 to 800 fuel assemblies. Nuclear plants replace one-third of their fuel assemblies about every two years as the uranium-235 gets used up.

Fuels have different energy content. Less uranium is required to produce electricity.



Workers stack uranium fuel pellets inside fuel rods and group the fuel rods in fuel assemblies.

Teachers' Notes:

Why is uranium formed into ceramic pellets?

Using uranium in a ceramic form contributes to safety. In this form, the fuel can resist the effects of heat and corrosion in the reactor. Preventing the fuel from corroding or melting keeps radioactive material from being dispersed in water. This is discussed further in later sections on safety systems.

Think about it...



Fission gives off energy when the heaviest elements are split. Another kind of reaction, **fusion**, gives off energy when the lightest elements are combined, or fused together.

When two hydrogen atoms fuse to form a helium atom, a huge amount of energy is released. Thanks to the pioneering work of Albert Einstein, the formula $E = mc^2$ tells us exactly how much energy the fusion reaction releases.

Fuel used for fusion is abundant and can be taken from sea water. But there are huge challenges to harnessing this power. The greatest challenge is how to heat the hydrogen fuel to 100 million degrees Celsius (180 million degrees Fahrenheit) and confine it long enough for fusion to occur. So far, scientists have been able to maintain a controlled, continuous fusion reaction for only fractions of a second.

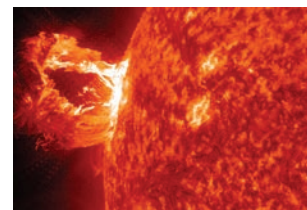



Summary

Fission occurs when a neutron strikes the nucleus of a uranium-235 atom, causing the atom to split apart. Two new lighter-weight atoms, two or three neutrons, and a lot of energy — mostly as heat — are released. If the neutrons that were released hit other uranium-235 atoms, these atoms may fission. This way, millions of atoms can be made to fission. This sequence of events is called a nuclear chain reaction.

The fuel for nuclear power plants is uranium, a dense metal found in rocks and soil around the world. Rock that contains 2 to 4 pounds of uranium per ton is known as uranium ore. Uranium is mined, milled, converted to a gas, enriched, and then made into solid ceramic pellets that are stacked in fuel rods that are bundled together as fuel assemblies.

Less than 1 percent of the atoms in uranium are uranium-235. But power plants need uranium that is about 4 percent uranium-235. The uranium enrichment process raises the concentration of uranium-235 based on the fact that uranium-238 atoms have a tiny bit more mass than uranium-235 atoms. We enrich uranium by using gaseous diffusion or by using centrifuges.

In addition to fission, or splitting atoms of heavy elements, scientists are learning how to control another type of nuclear reaction called fusion. Fusion occurs when light atoms of hydrogen join together (or fuse) to create helium and release a large amount of energy. So far, scientists have been able to maintain a controlled, continuous fusion reaction for only fractions of a second.

LESSON PLAN

Lesson 5: Lesson Plan

Fission, Chain Reactions

Overview

This chapter presents fission and the nuclear chain reaction. It also presents steps in uranium processing.

Concepts

- What is fission?
- What is a nuclear chain reaction?
- What is the fuel at a nuclear power plant?
- Where does uranium come from?
- Steps in preparing fuel
 - mining
 - milling
 - enrichment
 - gaseous diffusion
 - centrifuge
 - fabrication (fuel pellets, fuel rods, and fuel assemblies)
- How do we enrich uranium?
- How is the uranium prepared for the reactor?

National Standards (Grades 5 – 8)

Science

NS. 5-8.1 As a result of their activities in Grades 5-8, all students should develop

- Abilities necessary to do scientific inquiry
- Understanding of scientific inquiry

NS. 5-8.2 As a result of their activities in Grades 5-8, all students should develop an understanding of

- Properties and changes of properties in matter
- Transfer of energy

NS. 5-8.5 As a result of activities in Grades 5-8, all students should develop

- Abilities of technological design
- Understanding of science and technology

Technology

NT.K-12.1 Basic Operations and Concepts

- Students demonstrate a sound understanding of the nature and operation of technology systems
- Students are proficient in the use of technology

NT.K-12.2 Social, Ethical, and Human Issues

- Students understand the ethical, cultural, and societal issues related to technology
- Students practice responsible use of technology systems, information, and software
- Students develop positive attitudes toward technology uses that support lifelong learning, collaboration, personal pursuits, and productivity

NT.K-12.3 Technology Productivity Tools

- Students use technology tools to enhance learning, increase productivity, and promote creativity

NT.K-12.5 Technology Research Tools

- Students use technology to locate, evaluate, and collect information from a variety of sources
- Students use technology tools to process data and report results

Objectives

Upon completing this lesson, students will be able to

- Explain what fission is
- Diagram a nuclear chain reaction
- Explain how uranium is extracted from the Earth and processed for use as nuclear fuel
- Explain why we enrich uranium
- Explain how the difference in weight of uranium-238 and uranium-235 is used for enrichment

Key Terms / Vocabulary

centrifuge – a machine used to enrich uranium or separate uranium-235 from uranium-238 so the uranium-235 can be made into fuel for nuclear power plants

ceramic – a very hard, non-metal material that can withstand very high temperature without melting and does not easily corrode; used for fuel pellets for nuclear power plants

fission – to divide or split apart; the process of splitting apart; at a nuclear power plant it refers to splitting atoms

fission products – the atomic fragments left after a large atomic nucleus fissions or splits

fuel assembly – structure containing fuel rods that hold stacked uranium pellets; bundles of fuel rods that are loaded in the reactor core

fuel pellet – a cylinder about the size of your fingertip that is the fuel for nuclear power plants

fuel rod – long metal tube that holds nuclear fuel pellets

fusion – a nuclear reaction in which light isotopes of hydrogen fuse together

inertia – the property of matter to resist change in its motion. An object in motion remains in motion unless another force acts on it. An object that is not in motion remains at rest unless a force acts upon it.

in-situ – situated in the original, natural place

leaching – the movement of a substance that has dissolved in a liquid

milling – process of grinding and crushing ore

mill tailings – the radioactive, sand-like materials that remain after uranium is extracted from uranium ore; contain hazardous substances and radium, which decays to produce radon; require special disposal

neutron – a particle that appears in the nucleus of all atoms except hydrogen atoms; one of the three basic particles that make up the atom; has no electrical charge

nuclear chain reaction – process in which neutrons released in fission produce an additional fission in at least one further nucleus

ore – a metal-bearing mineral that can be profitably mined

reactor – the part of a nuclear power plant where fission takes place

reclamation – restoration to a useful condition

uranium enrichment – the process of increasing the percent of uranium-235 for nuclear power plant fuel

uranium hexafluoride (UF_6) – a compound made from uranium and fluorine; changes to a gas when heated; used in uranium enrichment process

yellowcake – a yellow powder that is mostly uranium

Lesson Five – Chapter Outline

Fission

- Releases energy from the nucleus of atom
- Fission is used in a reactor
- Neutron strikes the nucleus
- Fission products
- Heat is produced

Nuclear chain reaction

- Millions of fissioning atoms are needed for enough heat to produce electricity
- Keeping a chain reaction going
- Friction creates the heat
- Heat is used to make steam to run power plants

Uranium

- Dense metal with energy in its nucleus
- Found all over the world
- Mined as uranium ore

Processing uranium

- Mined in underground mine or in open pit surface mines
- In-situ leaching dissolves uranium from the ore
- Mines must be reclaimed to protect workers and the environment
- Yellowcake is the result of uranium milling
- Mill tailings are waste products
- To be useful in power plants, uranium is enriched

Enrichment

- Natural uranium is less than 1% uranium-235
- Enriched uranium is about 4% uranium-235
- Uranium hexafluoride
- Gaseous diffusion
- Centrifuge

Uranium fuel

- Ceramic fuel pellets
- Fuel rods
- Fuel assemblies
- Equivalent energy value of a fuel pellet

Reading

Reading for this lesson in the student reader can be assigned as homework prior to this class session, or it can be read in class as guided reading.

Performance Assessment and Extensions

A Reading Review Exercise follows that you can reproduce or project for your class. The labs and activities that follow include inquiry-based questions that can be used to assess student learning. Accompanying this lesson is a PowerPoint lecture with a review that can be used as an interactive assessment. For a project-based assessment, have students create a blog, podcast, or video on a topic from this lesson.

Lesson 5 Reading Review Exercise

A. Fill in the blanks below.

From the reading, select the word or phrase that best fits the statement.

1. When a uranium-235 atom splits, it releases energy and two or three neutrons from its _____.
2. To protect the environment, when mining is finished, the land is replanted and restored in a process called _____.
3. Before it can be used as a reactor fuel, uranium has to be treated to increase the concentration of uranium- _____.
4. Mill tailings produce a small amount of radioactive gas called _____.
5. At a fuel fabrication plant, enriched uranium is made into a ceramic material that can withstand _____ and _____.

B. Indicate whether each statement is true (T) or false (F) by circling the correct letter. If the statement is false, correct it to make it true.

1. Rocks that contain a lot of uranium are called uranium ore. T F
2. Milled uranium is called yellowcake because it is sweet. T F
3. Less than 1 percent of the atoms in ordinary yellowcake are uranium-235. T F
4. A uranium fuel pellet is so small it does not contain much energy. T F
5. Nuclear power plants require uranium that is at least 4 percent uranium-238. T F
6. Uranium is very rare and is found in only a few places in the world. T F
7. During the process of uranium enrichment, gold is added to the fuel. T F
8. Uranium-238 weighs much less than uranium-235. T F
9. The gas centrifuge process is a way to enrich uranium. T F
10. The fuel for fusion can be found in sea water. T F

Lesson 5 Reading Review Exercise - Answers

A. Fill in the blanks below.

From the reading, select the word or phrase that best fits the statement.

1. When a uranium-235 atom splits, it releases energy and two or three neutrons from its nucleus.
2. To protect the environment, when mining is finished, the land is replanted and restored in a process called reclamation.
3. Before it can be used as a reactor fuel, uranium has to be treated to increase the concentration of uranium- 235.
4. Mill tailings produce a small amount of radioactive gas called radon.
5. At a fuel fabrication plant, enriched uranium is made into a ceramic material that can withstand high temperatures and corrosion.

B. Indicate whether each statement is true (T) or false (F) by circling the correct letter. If the statement is false, correct it to make it true.

1. Rocks that contain a lot of uranium are called uranium ore. (T) F
2. Milled uranium is called yellowcake because it is sweet. T (F)
It is yellow
3. Less than 1 percent of the atoms in ordinary yellowcake are uranium-235. (T) F
4. A uranium fuel pellet is so small it does not contain much energy. T (F)
A fuel pellet contains a lot of energy
5. Nuclear power plants require uranium that is at least 4 percent uranium-238. T (F)
uranium-235
6. Uranium is very rare and is found in only a few places in the world. T (F)
Found in small amounts all over the world
7. During the process of uranium enrichment, gold is added to the fuel. T (F)
Concentration of U-235 is increased from less than 1% to 4%
8. Uranium-238 weighs much less than uranium-235. T (F)
U-238 weighs slightly more.
9. The gas centrifuge process is a way to enrich uranium. (T) F
10. The fuel for fusion can be found in sea water. (T) F

Activities, Labs, and Supplemental Information

Teacher's PowerPoint Presentation

A Teacher's (PowerPoint) presentation is provided on CD and online on the DOE Office of Nuclear Energy website to help you present chapter concepts to your class. Download the teacher presentation at: <http://energy.gov/ne/services/harnessed-atom>

DVD - *Splitting Atoms, An Electrifying Experience*

In addition, you can show the 11-minute DVD titled *Splitting Atoms, An Electrifying Experience*, which has information about fission and uranium fuel. This is a U.S. Department of Energy program and is available online at <http://energy.gov/ne/services/harnessed-atom>

Lab - Simulation of Fission Chain Reaction

This demonstration allows students to simulate a nuclear chain reaction.

Lab - Controlling the Speed of a Nuclear Chain Reaction

This demonstration illustrates a chain reaction using dominoes.

Lab - The Mystery of Centrifugal "Force"

This demonstration illustrates that what we call centrifugal force is actually the combination of centripetal force and inertia.

Lab - Use "The Force" that Doesn't Really Exist

This experiment illustrates the concept of uranium enrichment using centrifuge technology as demonstrated by a salad spinner.

Advanced Topic – What is Fusion?

This research activity introduces fusion to interested students.

Math Extension: Chain Reactions – Theory and Calculations

Using the nuclear engineering principle called the neutron multiplication factor, this math extension allows students to use ratios to predict and calculate the results of chain reactions. Students graph their calculations to visualize critical ($k=1$), subcritical ($k<1$), and supercritical ($k>1$) reactions.

Supplemental Information - Other Simulations Available Online

- Basic Nuclear Fission: www.atomicarchive.com/Fission/FissionMov1.shtml
- Animation Nuclear Fission: www.classzone.com/books/earth_science/terc/content/visualizations/es0702/es0702page01.cfm
- Hot Fusion Plasmas: www.youtube.com/watch?v=wQYKAoNSz8g

Lab – Simulation of Fission Chain Reaction

Materials

- Large box with transparent top or clear plastic for a cover
- Mousetraps (snap-spring type)
- Ping-pong balls
- Long-handled tongs

Procedure

1. Set the box where it can be easily viewed.
2. Set the mousetraps. Using the tongs, carefully place the traps in the bottom of the box.
3. Carefully place two ping-pong balls on each trap, using the tongs.
4. Move the cover in place.
5. Drop one ping-pong under the cover.

Caution:

Because there is a danger that the mousetraps could go off accidentally, this demonstration is best done by the teacher.

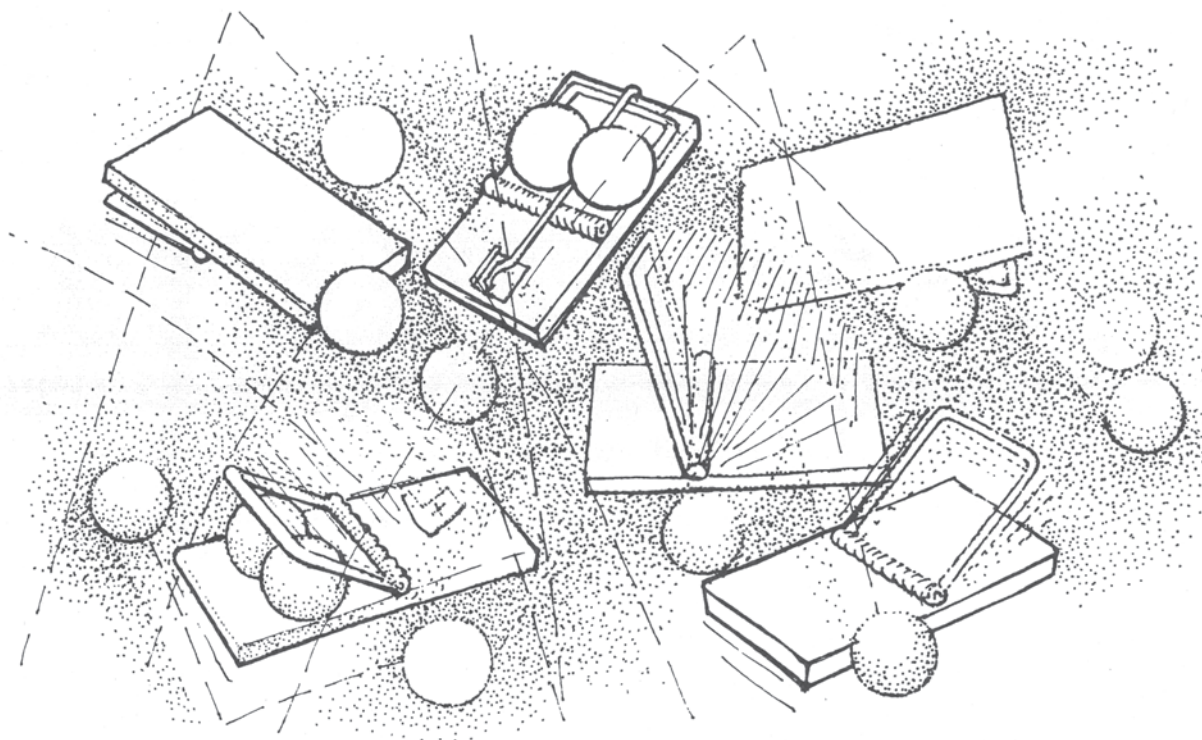

Lab – Controlling the Speed of a Nuclear Chain Reaction

Materials

- Stop watch
- Dominoes

Procedure

In theory, a nuclear reaction can take place very rapidly. Each time an atom fissions, two neutrons are released and these neutrons can each cause a new atom to fission. We can make a model of a chain reaction by using dominoes.

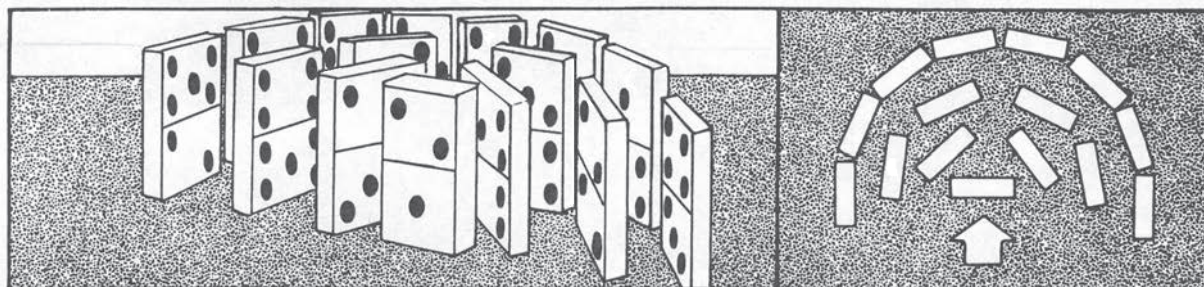

1. Place the dominoes in an order that allows each falling domino to strike two additional dominoes. By toppling the first domino, you can quickly see the effect of an uncontrolled chain reaction.

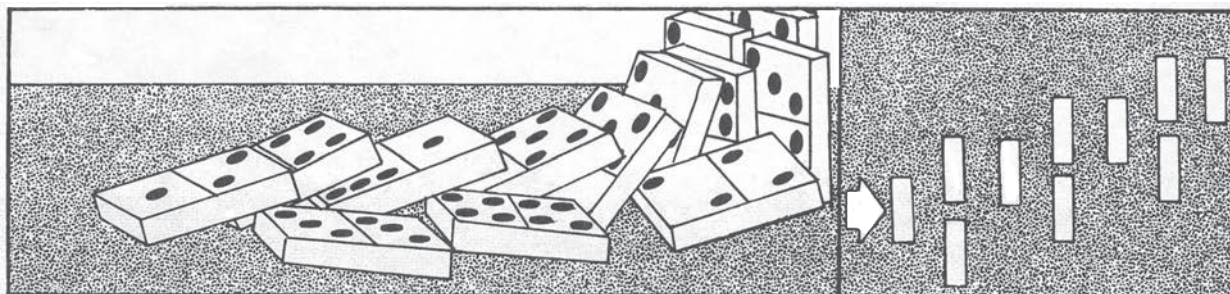

2. Now set the dominoes up again, but this time, for each domino that hits another domino, one domino should fall without hitting another domino. This models a controlled chain reaction.
3. The object of controlling a chain reaction is to release a steady amount of energy over a prolonged period of time. You may want to use a stop watch to time the seconds it takes for different setups to fall.

Other Ideas to Explore

Are there other ways to control the domino reaction?

Try your own setups for the dominoes.

Lab – The Mystery of Centrifugal “Force”

When you go upside down on a roller coaster or a spinning ride at the fair, what force keeps you from falling out? How does it make you feel? Does it feel like you are being flung outward?

You are feeling what people call “centrifugal force.” A *centrifuge* uses the concept of flinging outward. Medical technicians use centrifuges to separate materials that have different mass, like red and white blood cells. Scientists and engineers can also use centrifuges to separate atoms of U-235 from U-238, even though the difference in their mass is very slight.



But is centrifugal force really a force? Try these experiments.

Experiment 1: Observe the “Force”

Materials

- Small pail or bucket with strong handle
- .5m rope or strong string
- 10 pennies
- .25 L water

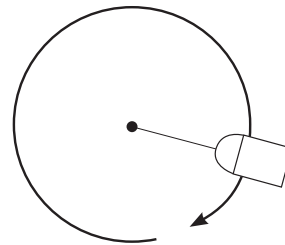

Procedure

1. Tie the rope securely to the handle of the pail.
2. Place the pennies in the pail.
3. Hold the rope and swing the pail quickly in a circle so that it goes upside down at the top of the arc.
4. Now try another experiment, but do this one outside. Instead of pennies, pour the water in the pail and repeat step 3.

Observations

- A. Describe what happened to the pennies in Step 3. _____
- B. Describe what happens to the water. _____
- C. If the pail stopped at the top of the arc, what would happen to the water? _____
- D. Place the pennies back in the pail. Turn it upside down. Describe what happens to the pennies now.

- E. What force caused the pennies to fall out when the pail was not moving in a circle?

- F. Does this mean that the force that kept the water in the moving pail disappears (in step 4)? Is it possible for a force to disappear? (Hint: think about gravity). _____

Extended Learning Topic: First Law of Motion

In 1687, Sir Isaac Newton changed our understanding of the Universe when he realized that moving objects always behaved in certain ways. He proposed that there were laws that explained this. Newton's First Law of Motion was that *an object in motion will stay in motion, in the same direction and at the same speed, unless it is acted upon by an outside force.*

An object in motion has **inertia**. Inertia resists change. If an object is moving, inertia keeps it moving. If an object is not moving, inertia keeps it at rest.

What happens when you're riding in a car and the driver suddenly puts on the brakes?

What keeps your body from continuing to move in a straight line at the same speed?

What keeps your body from continuing in a straight line when you go around a curve quickly?

As Isaac Newton observed, an object in motion has inertia and moves in a straight line. Any motion on a curved path must have another force that makes the object move toward the center of the curve. That force is called *centripetal force*, which means "center seeking."

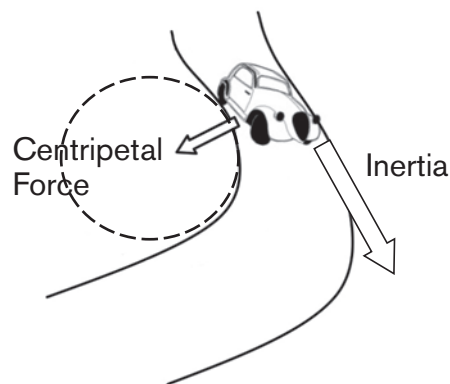

In Experiment 1, if you swing the pail clockwise, which direction would it travel if you let go of the rope? ___A___ ___B___.

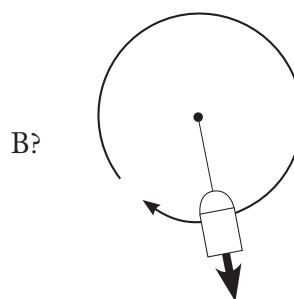
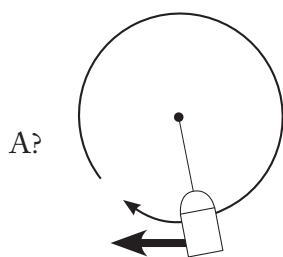

What outside forces are acting on the moving pail to keep it moving in a circle? _____

What outside forces keep the pennies and the water in place? _____

Do you think "centrifugal force" is a real force? _____

You can watch this video about centripetal force: www.youtube.com/watch?v=yyDRI6iQ9Fw

Lab – The Mystery of Centrifugal “Force” - Answers

When you go upside down on a roller coaster or a spinning ride at the fair, what force keeps you from falling out? How does it make you feel? Does it feel like you are being flung outward?

You are feeling what people call “centrifugal force.” A *centrifuge* uses the concept of flinging outward. Medical technicians use centrifuges to separate materials that have different mass, like red and white blood cells. Scientists and engineers can also use centrifuges to separate atoms of U-235 from U-238, even though the difference in their mass is very slight.



But is centrifugal force really a force? Try these experiments.

Experiment 1: Observe the “Force”

Materials

- Small pail or bucket with strong handle
- .5m rope or strong string
- 10 pennies
- .25 L water

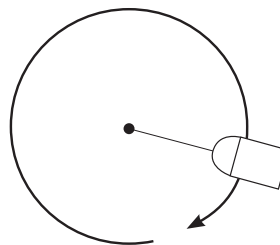

Procedure

1. Tie the rope securely to the handle of the pail.
2. Place the pennies in the pail.
3. Hold the rope and swing the pail quickly in a circle so that it goes upside down at the top of the arc.
4. Now try another experiment, but do this one outside. Instead of pennies, pour the water in the pail and repeat step 3.

Observations

- A. Describe what happened to the pennies in Step 3. *Inertia and centripetal force kept pennies in pail.*
- B. Describe what happens to the water. *Inertia and centripetal force kept water in pail.*
- C. If the pail stopped at the top of the arc, what would happen to the water? *Water would spill and pail drop.*
- D. Place the pennies back in the pail. Turn it upside down. Describe what happens to the pennies now. *Pennies drop to ground.*
- E. What force caused the pennies to fall out when the pail was not moving in a circle? *Gravity or gravitational force.*
- F. Does this mean that the force that kept the water in the moving pail disappears (in step 4)? Is it possible for a force to disappear? (Hint: think about gravity). *No. No.*

Lab – Use “The Force” that Doesn’t Really Exist

Materials

- Salad spinner (available online for about \$3 or at many secondhand stores, flea markets, or thrift shops)
- .5 L dry pinto beans
- .5 L puffed corn cereal (Generic brand is fine. Look for round plain or cocoa puffs.)

Procedure

1. Place the beans and the puff cereal in the spinner bowl and mix them together.
2. Hold the outside still and turn the handle to spin quickly for 20 seconds.
3. Carefully open the lid without shaking the spinner.
4. Repeat this experiment, but this time, use beans but add only two pieces of puffed cereal.

Observations

- A. When you began the experiment, the beans and puffs were mixed together. Are they still? ___ Yes ___ No.
- B. What do you notice about how they now are positioned in the spinner? _____
- C. Count beans and puffs along the outside edge: ___ beans and ___ puffs.
Why do you think this difference in number happened? _____
- D. What was different when you only used two cereal puffs? Where did they end up? _____
- E. The beans and puffs have similar size and shape. They have different mass, though. Which has greater mass, the beans or the puffs? _____.

Discussion

Uranium-235 (U-235) and uranium-238 (U-238) can be separated in a very advanced spinning centrifuge. However, both types of atoms are mixed together in solid form in uranium metal or oxide. To separate the U-235, it is mixed with fluorine and heated to a gas, then spun at tremendous speed.

1. Which of the uranium isotopes do you think goes to the outside of the centrifuge, U-235 or U-238?

2. Remember that natural uranium is more than 99 percent U-238. Also remember that there is only about a 1 percent difference in mass between U-235 and U-238. Can you explain why this makes it difficult to enrich uranium?

You can watch a salad spinner work (using salad and water) here:
www.youtube.com/watch?v=naR8C4lGUgw

Math Extension: Calculate Centripetal Force

The formula for calculating centripetal force is $T = \frac{mv^2}{r}$

Where: T= tension (force)

m= mass

v= velocity

r= radius

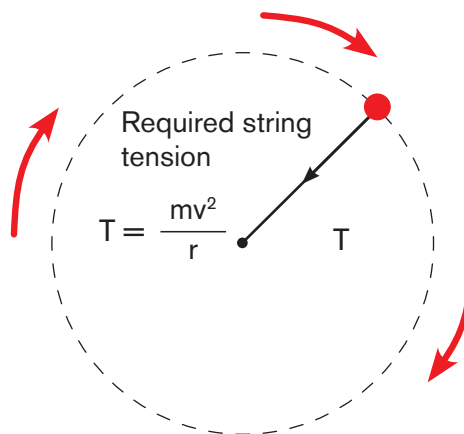

Calculate centripetal force T (in newtons) where:

r = 4 m

m= 2 kg

v =4 meters/second

T = _____

(answer: 8 N)

Lab – Use “The Force” that Doesn’t Really Exist – Answers

Observations

- A. When you began the experiment, the beans and puffs were mixed together. Are they still? ___ Yes X No.
- B. What do you notice about how they now are positioned in the spinner? Beans are on outside edge.
- C. Count beans and puffs along the outside edge: ___ beans and ___ puffs.
Why do you think this difference in number happened? Beans are heavier than puffs.
- D. What was different when you only used two cereal puffs? Where did they end up? in center of spinner
- E. The beans and puffs have similar size and shape. They have different mass, though. Which has greater mass, the beans or the puffs? beans.

Discussion

Uranium-235 (U-235) and uranium-238 (U-238) can be separated in a very advanced spinning centrifuge. However, both types of atoms are mixed together in solid form in uranium metal or oxide. To separate the U-235, it is mixed with fluorine and heated to a gas, then spun at tremendous speed.

1. Which of the uranium isotopes do you think goes to the outside of the centrifuge, U-235 or U-238?
Heavier U-238 moves toward outside centerfuge walls
2. Remember that natural uranium is more than 99 percent U-238. Also remember that there is only about a 1 percent difference in mass between U-235 and U-238. Can you explain why this makes it difficult to enrich uranium?
There is not much difference in the masses so separating them is gradual and has to be repeated many times.

Advanced Topic – What is Fusion?

In addition to fissioning, or splitting atoms of heavy elements, modern scientists are learning how to bring about another type of nuclear reaction called fusion. Fusion occurs when light isotopes of the element hydrogen join together (or fuse) to create a new atom and release a large amount of energy.

The isotopes of hydrogen used in fusion are called deuterium and tritium. They are driven together with tremendous force at incredibly high temperatures, producing an atom of the element helium, a neutron, and a lot of energy.

The energy of the Sun and stars is produced through fusion. Scientists are trying to build machines that can imitate the Sun to produce heat for power plants. However, on the Sun, gravity holds atoms together so they can fuse. On Earth, scientists are trying to use magnetic fields to confine hydrogen isotopes for fusion.

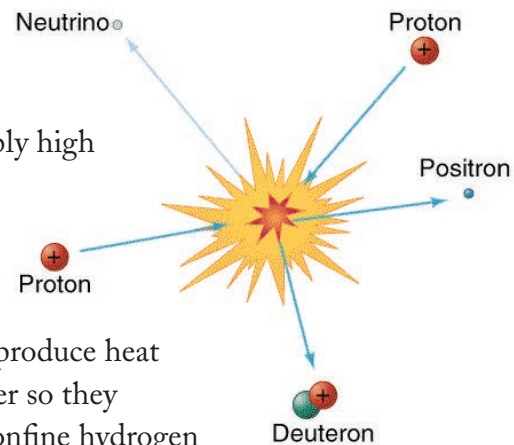

Atoms can be forced together more easily at very high temperatures. The greatest challenge in producing fusion energy is to heat the hydrogen fuel to 100 million degrees C (180 million degrees F) and confine it long enough for fusion to occur. Such temperatures are more than six times hotter than the surface of the Sun.

At high temperatures, hydrogen fuel becomes a plasma. Plasma is similar to a gas, but it differs slightly because electricity alters it and magnetism molds it.

Imagine how difficult it is to hold a plasma heated to 100 million degrees C. One method being developed would use incredibly strong magnetic fields to keep the hot plasma away from container walls. In one type of fusion experiment, magnetic fields spin the plasma in a donut shape. Magnetic coils “squeeze” the plasma until atoms are forced together. Scientists are also studying other methods that use powerful lasers or intense x-rays to strike tiny targets that hold hydrogen fuel. So far, scientists have been able to maintain a controlled, continuous fusion reaction for only fractions of a second.

Despite the fact that fusion research is very difficult and expensive, many nations are working together on fusion energy. The main reason there is so much interest in fusion is that the fuel used for fusion is abundant and can be taken from sea water. One gallon of sea water contains enough hydrogen isotopes for fusion to equal the energy that would be released by burning 300 gallons of gasoline. If this research is successful, it is expected that fusion could begin to contribute clean, abundant, economical energy to our country and the world in the 21st century.

If fusion research is difficult and expensive, is it worth it? What do the students think?

Math Extension – Chain Reactions: Theory and Calculations

Steady-State Fission Chain Reaction

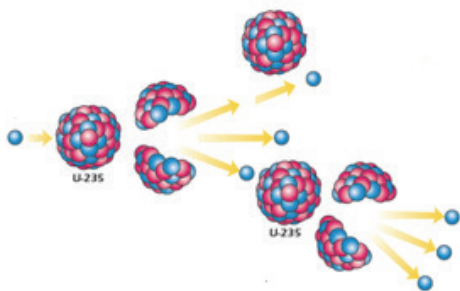

Supercritical Fission Chain Reaction

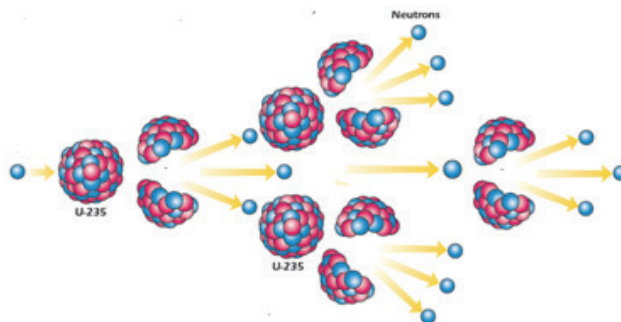

To keep a steady chain reaction, at least one neutron from each splitting uranium atom must strike another uranium atom and cause it to split. Nuclear engineers call the average number of neutrons from one fission that create another fission the *neutron multiplication factor*, represented as k . When $k=1$, the chain reaction is steady and the reactor is called *critical*. A steady chain reaction will continue without increasing or decreasing. A reactor's power level changes if the ratio of neutrons changes.

Materials

- Graph paper

Procedure

1. Describe the difference in the drawings of steady-state fission and supercritical fission.

2. Uranium-235 fission reactions produce 2 or 3 neutrons. What is the average number of neutrons released when a uranium-235 atom splits? _____ What is the average ratio of a neutron striking one uranium atom to the neutrons released? _____
3. What happens if less than one of the neutrons strikes another uranium atom to cause it to split? _____ Why is it called subcritical? _____
4. Calculate the values for the number of fission events and fill in the following table using the k values shown in the first column. Round to the nearest integer.

Multiplication Factor	Fission 1	Fission 2	Fission 3	Fission 4	Fission 5	Fission 6	Fission 7	Fission 8	Fission 9	Fission 10
$k=0.8$	100									
$k=1.1$	100									

5. Plot your data on graph paper.

Math Extension – Chain Reactions: Theory and Calculations – Answers

Procedure

- Describe the difference in the drawings of steady-state fission and supercritical fission.
Both release 3 neutrons. The steady state hits one other atom. The supercritical hits more than one other atom.
- Uranium-235 fission reactions produce 2 or 3 neutrons. What is the average number of neutrons released when a uranium-235 atom splits? 2.5 What is the average ratio of a neutron striking one uranium atom to the neutrons released? 1 : 2.5
- What happens if less than one of the neutrons strikes another uranium atom to cause it to split?
The chain reaction slows and stops. Why is it called subcritical? *It is below what is needed to be critical.*
- Calculate the values for the number of fission events and fill in the following table using the k values shown in the first column. Round to the nearest integer.

Multiplication Factor	Fission 1	Fission 2	Fission 3	Fission 4	Fission 5	Fission 6	Fission 7	Fission 8	Fission 9	Fission 10
k=0.8	100	80	64	51	41	33	26	21	17	13
k=1.1	100	110	121	133	146	161	177	195	214	236

- Plot your data on graph paper.

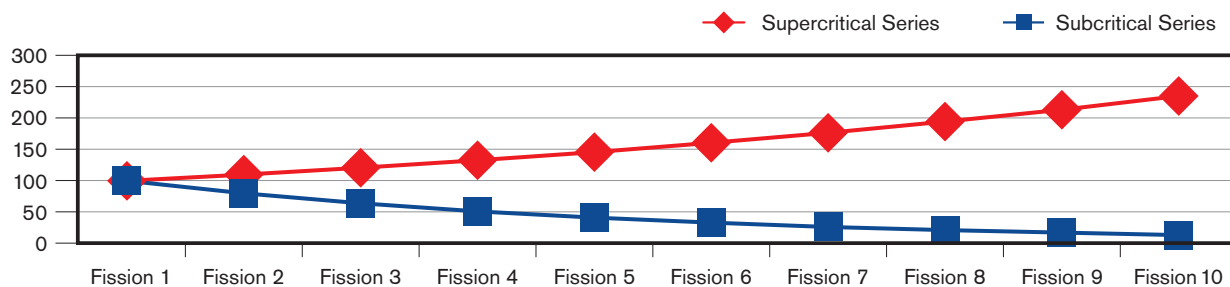

Ask students: What do you predict a line on this graph will look like when $k=1$?

The answer is close to a horizontal line. In designing nuclear power plants, engineers want steady, safe levels of power from the reactor, so they use fuel with just barely enough uranium-235 to keep the chain reaction going, where $k=1$. Reactor fuel contains about 4 percent uranium-235.

ATOMS TO ELECTRICITY



Introduction

Most power plants make electricity by boiling water to make steam that turns a turbine. A nuclear power plant works this way, too. At a nuclear power plant, splitting atoms produce the heat to boil the water.

TOPICS:

Inside the reactor

Heat
Pressure
Steam

Fission control

Fuel assemblies
Control rods
Coolant
Pressure vessel

Electricity generation

Turbine
Generator
Condenser
Cooling tower

How does splitting atoms produce electricity?

A nuclear power plant is built to produce electricity. But splitting atoms, or fission, does *not* produce electricity directly. Splitting atoms produces heat. At a power plant, heat energy is converted to mechanical energy that is then converted to electrical energy.

How is the electricity produced?

The heat from fission turns water into steam. The mechanical energy from steam pressure turns a **turbine**. This spins a generator, which produces electricity. The way heat energy is changed into electrical energy in a nuclear power plant is the same as in a coal power plant.

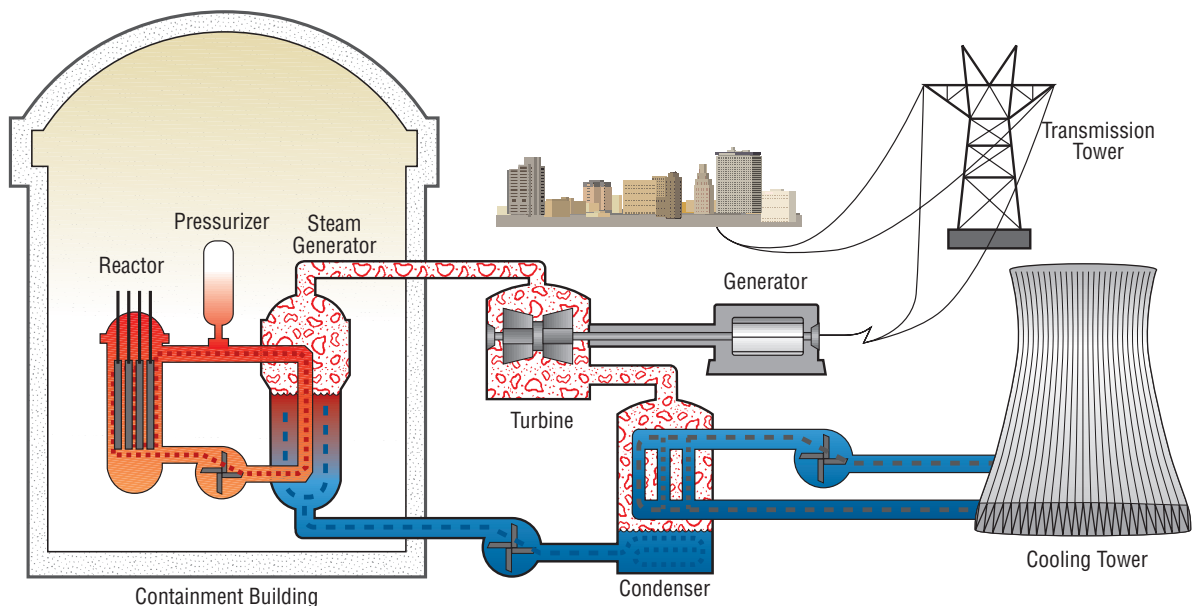

Teachers' Notes:

Heat in a coal plant is released from a chemical reaction through combustion. In a nuclear plant, it is released in a nuclear reaction from fission.

Outside the reactor and containment building, coal and nuclear plants are similar in the way they operate.

Some natural gas-fired plants also use steam turbines, but most new natural gas power plants use gas turbines and drive the blades directly with combustion gases, much like a jet engine.

A **nuclear reactor** is basically a machine that heats water. Like other large power plants, nuclear plants have specialized pipes, electrical equipment, and buildings. They are built to extremely high standards so that they will work reliably and produce electricity that customers need.

Utilities use two different types of nuclear reactors in the United States. One is the **pressurized water reactor**, and the other is the **boiling water reactor**. Both use ordinary water and work in a similar way. In this lesson, we use a pressurized water reactor to explain the science of how nuclear power plants work.

Where does fission take place?

Fission takes place in the fuel sealed inside the **core** of a nuclear reactor.

Uranium **fuel assemblies** form the core of the reactor. A reactor core has 200 to 800 fuel assemblies, depending on its design. Because uranium has so much energy, the fuel in the core lasts about three to five years. To maintain the plant, utility workers turn off the reactor about every 2 years and replace one-third of the fuel, rather than changing it all at once. This helps to schedule regular maintenance on the plant and keeps the power supply steady.

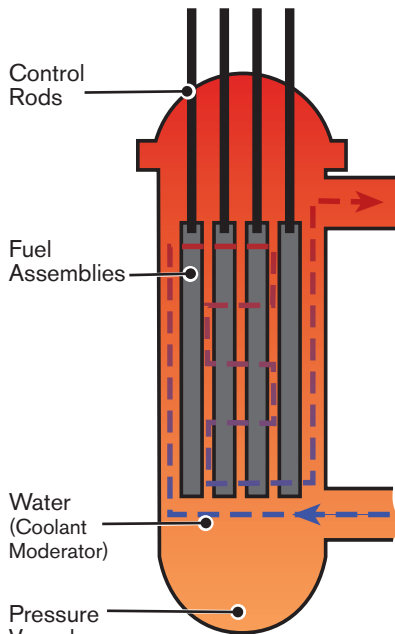

The fuel assemblies, control rods, and coolant make up the reactor's core. The core is surrounded by a massive steel pressure vessel.

What are control rods?

The **control rods** help regulate, or control, the rate of fission. Control rods are made of **cadmium** or **boron** metal. They slide in and out of the reactor core and act like sponges for neutrons.

When control rods are inserted in the fuel, they absorb neutrons. Keeping control rods in the fuel prevents a fission chain reaction. Pulling the control rods out of the fuel allows the reaction to begin.

Who controls the control rods?

Highly trained operators work in the control room. They monitor the reactor with the help of computers and sensors. The operators in the control room are the “brain” of the power plant. To start the reactor, they slowly pull the control rods out of the core. Without the control rods to absorb neutrons, fission begins and produces heat.

Teachers' Notes:

Why are control rods made of substances such as cadmium and boron?

Cadmium and boron can capture neutrons more readily than other metals; their atoms present a larger target. Scientists call the ability of an atom to absorb neutrons its “neutron capture cross section.” This is the effective area that the atom presents for neutron capture. They measure this ability in units called “barns.” Limiting the number of neutrons available for fission by the use of boron or cadmium control rods allows plant operators to control the multiplication factor of a chain reaction.



Nuclear power plant operators use computers and sensors in the control room to monitor the reactor.

Operators monitor the temperature in the reactor closely. As the temperature in the core rises, they adjust the reactor to keep the rate of fission constant so the temperature stays at about 315°C (600°F). If there is any sudden change in temperature or pressure, the reactor automatically shuts down by sliding all the control rods into the fuel. It takes only seconds to stop the nuclear chain reaction.

Teachers' Notes:

What other uses of coolants are students familiar with in their every day lives?

The coolant in the radiator of your car removes engine heat. The radiator keeps the coolant under pressure to prevent it from boiling.

What is the coolant and moderator?

Water is the reactor's **coolant**. Water circulates around the fuel to transfer heat from the core. Water also keeps the core from getting too hot.



Just as it is easier to catch a ball that is thrown softly, neutrons are more likely to be captured and cause fission when they are not moving too fast.

Water serves another purpose in a reactor. It is also a **moderator**. Passing through water slows the neutrons down, or “moderates” their speed. This helps make fission possible.

It is easier for uranium-235 atoms to capture neutrons when they are moving more slowly. Using water to slow the neutrons down allows enough neutrons to be captured by the uranium fuel for a chain reaction to occur.

What is a pressure vessel?

The reactor is surrounded by a huge steel **pressure vessel**. Its walls are over 20 cm (7.87 inches) thick, and it weighs more than 300,000 kg (331 tons). It is filled with the coolant water that protects the reactor core by removing heat.



The reactor pressure vessel is cast from solid steel 20 cm (9 inches) thick.

Pressure vessels are machined to the highest standards. Every square centimeter is x-rayed to make sure there are no hidden defects inside the metal. The steel vessel can withstand very high temperatures and pressure.

The entire reactor system is surrounded by a **containment building** made of thick concrete that is reinforced with steel. This building protects the reactor from problems outside, and it protects the environment in case of a problem in the reactor.

Teachers' Notes:

How does slowing down neutrons make a chain reaction more likely?

When neutrons are moving too fast, they fly past atoms and do not cause fission. If they are slowed down, they are more likely to be “captured” by an atom, thus causing the atom to fission.



The reactor is surrounded by a massive concrete and steel reinforced containment building 2 to 3 meters (6 to 10 feet) thick. This picture shows the two containment buildings for reactors at St. Lucie plant in Florida.

What is heat transfer?

The science of how heat moves is called **thermodynamics**. The laws of thermodynamics show that when heat is added to a system, some of the heat moves, or transfers, to the systems around it. Heat moves from hotter systems to cooler ones. This scientific law helps us understand how we move the heat energy produced inside the reactor.



When you pour hot cocoa into a mug, the mug quickly becomes warm. This is because heat always flows from hotter materials to colder ones.

How does the heat make steam?

Heat moves from the hot fuel to the cooler water that surrounds it. The water gets hot. Normally, water boils when it reaches 100° C (212° F). When water boils, it turns into steam. Steam is water in the form of a gas rather than a liquid. Gases take up more volume than liquids.

Engineers design a pressurized water reactor so that there is not space for the hot water to

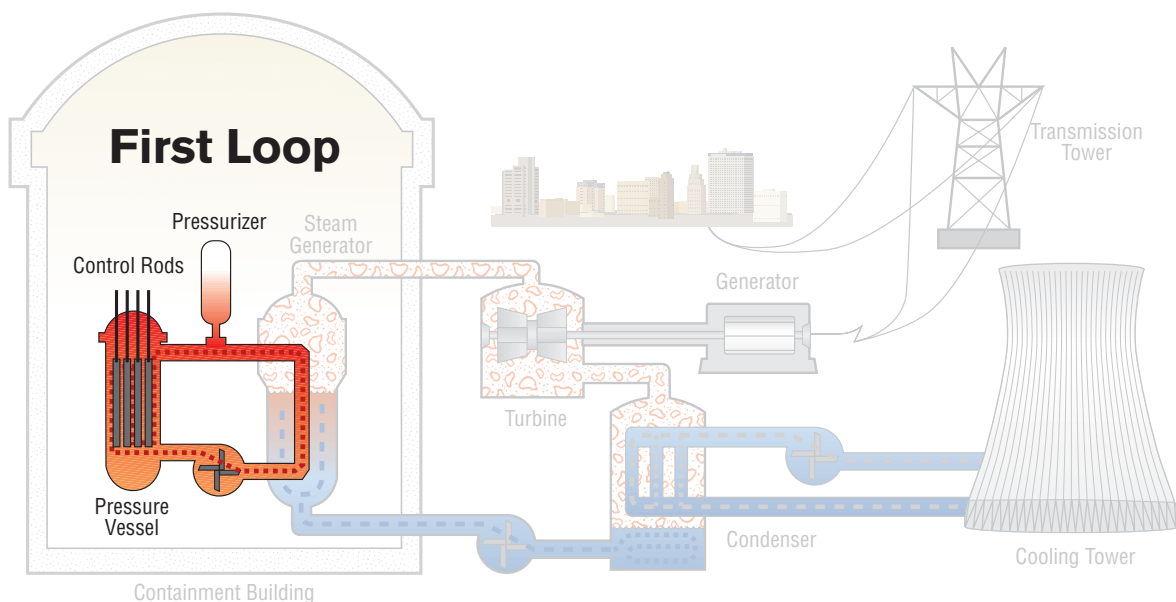

turn into steam. The heated water builds up **pressure** because it cannot expand. Power plant operators use this pressure to heat water to 315° C (600° F) and keep it a liquid. Higher temperatures make the system more energy efficient.

The power plant has three separate loops of piping. Water in one loop does not mix with water in the other loops. However, the heat transfers from one loop to another. How?

In a pressurized water reactor, superheated water in the first loop flows through tubes



The huge blades of the turbine are spun by steam. The turbines are attached to the generators. Generators convert the mechanical energy of the spinning turbines into electricity by rapidly spinning a coil of wire inside a magnetic field.



A generator at a large power plant is about twice the size of a school bus. It can produce enough electricity to supply a city of half a million people.

in the steam generator, making them very hot. Heat energy is transferred as water in the second loop touches these hot tubes. This causes the water in the second loop to boil, building pressure as the water expands from liquid to vapor. The steam pressure provides mechanical energy that can be used to do work.

How does the steam drive turbines to make electricity?

Steam pressure blows across the blades of the turbine and spins it. A turbine works like a pinwheel with many blades. The spinning turbine is attached to a **generator**. The

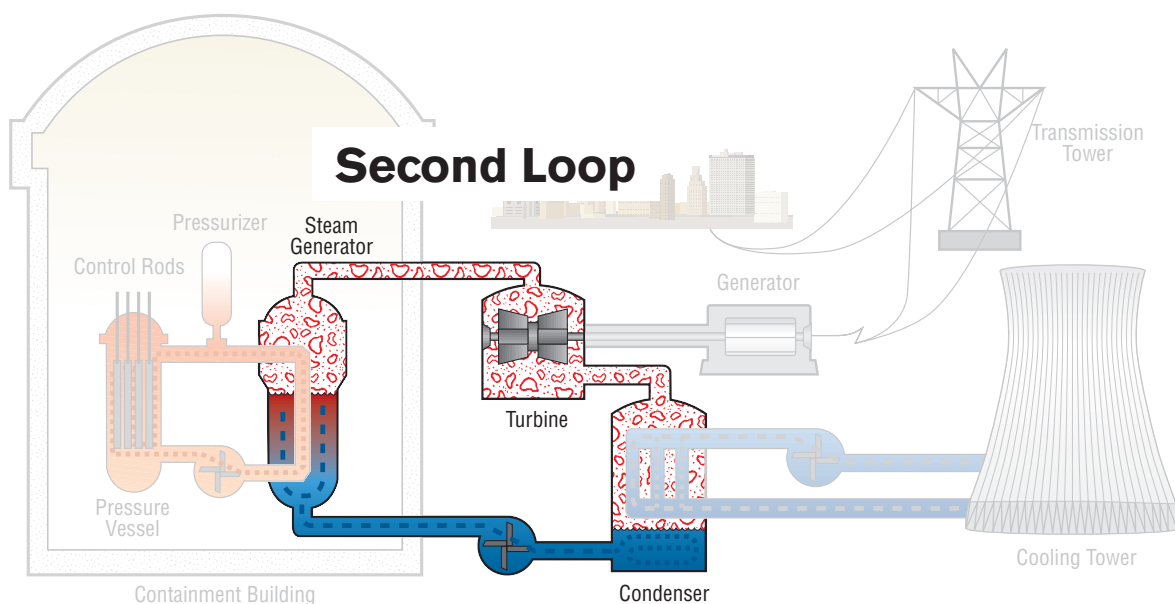



A glass of ice water in the summer is a model of how a condenser works. If you pour ice water into a glass, beads of water form on the outside. The glass seems to be sweating. What is going on? We know water does not leak through the glass. The drops have come from water vapor in the air. Heat energy from the warm air has moved to the cold glass. Water vapor in the air condenses into liquid when it loses heat energy.

What happens after steam spins the turbine?

As steam turns the blades of the turbine, it loses much of its mechanical energy. The temperature and pressure drop. Before it can be used again, the steam must be cooled back into water. Then it can be pumped back through the second loop to be re-heated and turned back to steam to build up pressure, starting the cycle again.

How does the condenser work?

Cooling the steam back into water is the purpose of the third loop. It starts with the **condenser**, which is located below the turbine. In the condenser, steam from the second loop flows over tubes filled with cool water from a lake, river or ocean. The steam transfers its heat to the third loop. The water does not mix. Only the heat is transferred.

generator changes the mechanical energy of the spinning turbine into electrical energy.

The generator works by rotating a coil of wire inside a magnetic field. This causes electrons to move in the wire.

Why do we remove the heat from the water in the third loop?

Warmer water might harm fish or plant life if it were put back into the lake. So power plant operators cool the water to protect

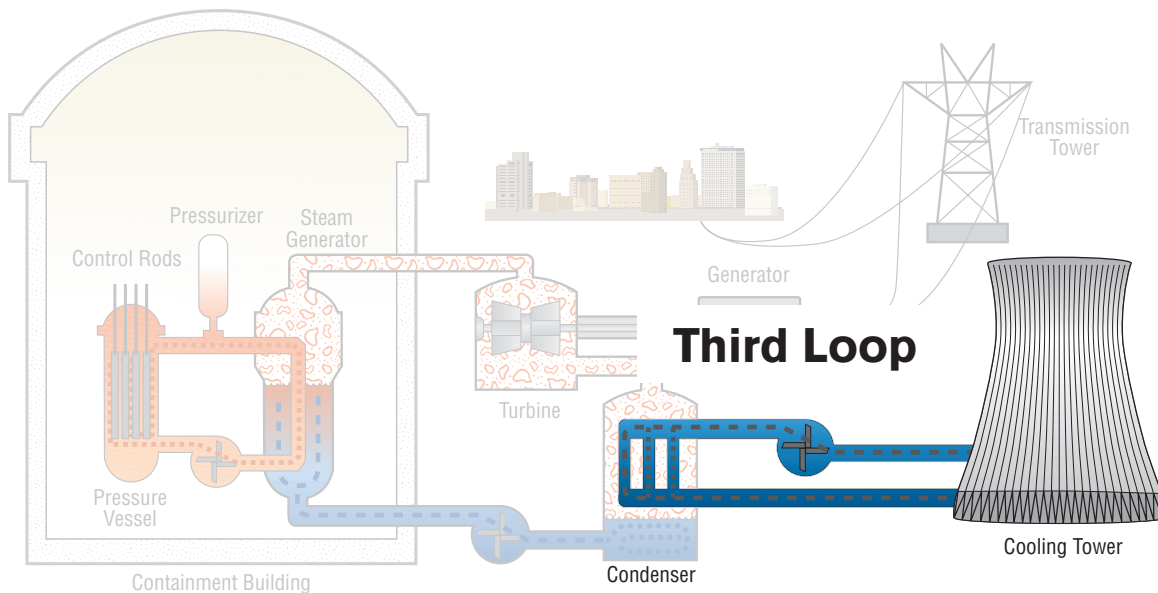

the environment. Laws require water to be within 2.8° C (5° F) of the lake's normal temperature before it is released. Therefore, some nuclear and coal power plants use cooling towers to get rid of waste heat.

How does the cooling tower work?

At 200 meters (656 feet) high, a **cooling tower** is usually the power plant's tallest structure. It is a giant, hollow concrete cylinder. It sits on legs that allow air to flow up under it. Inside the tower, warm lake water from the third loop is sprayed in the air and trickles down through the stair-stepped layers of the interior.

Heat transfers from the water into the air. Some of the water evaporates. The warm, moist air rises inside the tower. This pulls in cool air from the bottom. A natural draft begins to flow up and out of the top of the tower. The water is collected at the bottom of the cooling tower and used again in the third loop. Water that evaporates is replaced with more water from the river.

Heat and moisture leave the top of the tower at

about 16 km per hour (10 miles per hour) into the atmosphere. What looks like smoke coming from the top of the cooling tower is really vapor from lake water. This water has never been near the reactor. It is not radioactive.

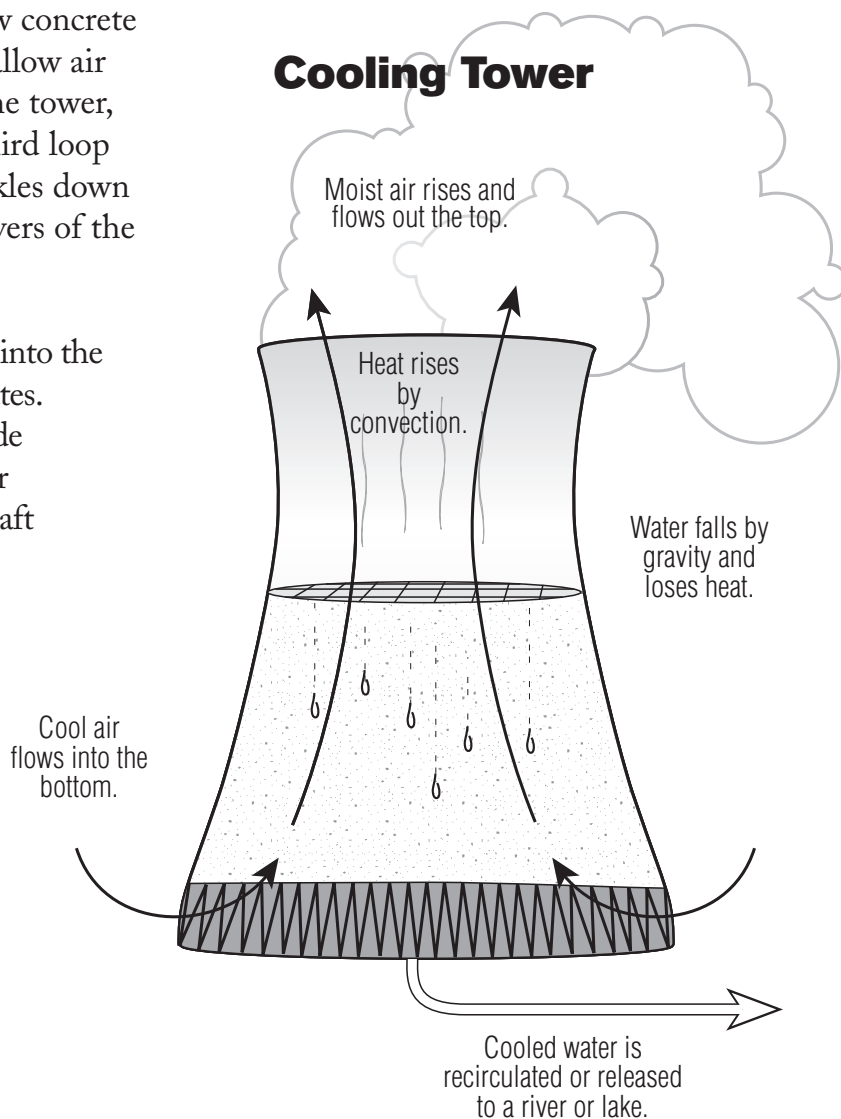



Summary

The way nuclear power plants produce heat energy through fission is unique. However, the way heat energy is changed into electrical energy is basically the same as in a coal power plant.

At a nuclear power plant, fission takes place in the reactor. A reactor has four main parts:

- uranium fuel assemblies
- control rods
- water (the coolant and moderator)
- pressure vessel

The fuel assemblies, control rods, and coolant/moderator make up the reactor's core. The core is surrounded by the pressure vessel. The entire reactor system is within the huge containment building.

The reactor has separate loops of piping that use water to move heat energy. Water in these loops never mixes together. However, heat energy moves from one loop to another.

In a pressurized water reactor, the first loop carries water that has been heated

to a very high temperature in the reactor to the steam-generator. In the steam generator, heat energy from the first loop transfers to the second loop.

The second loop carries the heat energy as steam to the turbines and spins the turbine's blades. The turbines are attached to the generators, which change the mechanical energy of the spinning turbine into electricity. From the turbines, water in the second loop goes to the condenser. In the condenser, steam in the second loop is cooled when some of its remaining heat transfers to the water in the third loop. When it is cooled, the steam changes from a gas back into liquid water.

The third loop contains cooling water drawn from the river or lake. Because heated water could harm the environment, water in the third loop is pumped to the cooling tower where heat is removed. Some of the water evaporates and leaves the cooling tower as water vapor. Most is used again in the third loop.

LESSON PLAN



Lesson 6: Lesson Plan

Atoms to Electricity

Overview

Preceding lessons have given students all the necessary information to understand what atoms are and how uranium-235 atoms fission. In this lesson, students will learn how nuclear engineers apply their knowledge to help them harness nuclear energy to make electricity inside a nuclear power plant. Depending on the class, this lesson can be one or two days.

In addition, you can show the 11-minute DVD titled *Splitting Atoms, An Electrifying Experience*, which has good information about fission and uranium fuel. This is a Department of Energy production and is available online at [www.energy.gov](#). If your students see *Splitting Atoms, An Electrifying Experience*, you can probably cover this lesson in one day because much of the information is covered in that presentation.

Concepts

- What are the parts of the nuclear reactor?
- How do the parts of the nuclear power plant work together to generate electricity?
- How is the reaction in the reactor core controlled?
- How do the form of the fuel, the design of the pressure vessel, the presence of the coolant/moderator, and the use of a containment building contribute to safety?
- What is heat transfer?
- What is the effect of having water in the core kept under pressure?
- What law explains why heat from the first loop transfers to the water in the second loop?
- Why doesn't water in the first loop turn to steam? Why does water in the second loop turn to steam?
- How does a condenser work?
- Why is water in one loop never allowed to mix with water in the second loop?
- Why does heat have to be removed from water in the third loop?
- What is a cooling tower? How does it work?

National Standards (Grades 5 – 8)

Science

NS. 5-8.2 As a result of their activities in Grades 5-8, all students should develop an understanding of

- Properties and changes of properties in matter
- Transfer of energy

NS.5-8.5 As a result of activities in Grades 5-8, all students should develop

- Understanding of science and technology

Technology

NT.K-12.1 Students demonstrate a sound understanding of the nature and operation of technology systems

Benchmarks - Project 2061

Project 2061 is a program of AAAS (American Association for the Advancement of Science). Benchmarks for Science Literacy is AAAS' statement of what all students should know and be able to do in science, mathematics, and technology by the end of Grades 2, 5, 8, and 12. The recommendations at each grade level suggest reasonable progress toward the adult science literacy goals laid out in the project's 1989 report *Science for All Americans*.

Grades 6 – 8

By the end of the 8th Grade, students should know that

- Transformations and transfers of energy within a system usually result in some energy escaping into its surrounding environment. Some systems transfer less energy to their environment than others during these transformations and transfers. 8C/M1
- People have invented ingenious ways of deliberately bringing about energy transformations that are useful to them. 8C/M8

Objectives

Upon completing this lesson, students will be able to

- Identify the parts of a reactor, including fuel assemblies, control rods, coolant/moderator, and pressure vessel
- Explain how control rods work
- Explain the purpose of the containment building
- Explain the process of heat transfer
- Describe how water moves heat through a power plant
- Discuss the function of the cooling tower and how it works
- Explain why water must be cooled before it returns to the river

Key Terms / Vocabulary

- boiling water reactor (BWR)** – type of nuclear reactor in which water boils in the core to make steam to generate electricity; one of two reactor designs used in the United States
- boron** – a non-metallic element used in the control rods and coolant water in nuclear reactors to absorb neutrons and thus help control the rate of fission; symbol is B
- cadmium** – a soft, bluish-white metallic element that is used in control rods in nuclear reactors to absorb neutrons and, thus, help control the rate of fission; symbol is Cd
- condenser** – the equipment at a nuclear power plant that cools steam and turns it back into water
- containment** – a structure that keeps something harmful under control or within limits
- containment building** – a large building of steel-reinforced concrete that surrounds and protects the reactor and also protects the environment
- control rods** – devices that can be pulled out of and inserted into the reactor core to absorb neutrons and regulate the chain reaction; used to control the speed of a chain reaction
- convection** – the transfer of heat due to the automatic circulatory motion that occurs in a fluid at non-uniform temperature, owing to the variation of its density and the action of gravity
- coolant** – a substance used for cooling
- coolant/moderator** – a substance used to cool the reactor and to slow neutrons. In most nuclear power plants, water is used to keep the reactor from getting too hot and also slow the neutrons down so they are more likely to cause uranium-235 atoms to fission.
- cooling tower** – a structure in a nuclear power plant used to remove heat from cooling water; prevents thermal pollution of lakes and rivers
- core** – where fission occurs in a nuclear reactor; made up of the fuel assemblies, control rods, and moderator
- fuel assembly** – structure containing fuel rods that hold stacked uranium pellets; bundles of fuel rods that are loaded in the reactor core
- generator** – a machine that makes electricity
- heat transfer** – the movement of heat from a hotter object to a cooler object; the transfer can be made by conduction, convection, or radiation
- moderator** – a substance that slows neutrons down in the reactor so they are more likely to cause uranium atoms to fission. In U.S. reactors, the moderator is water.
- pressure** – the effect of a force applied to a surface. Keeping water under pressure in the reactor of a pressurized water reactor means the water can be heated to a temperature greater than 100° C or 212° F without boiling.
- pressure vessel** – an extremely strong steel container that surrounds the core of the nuclear reactor; may also be called the reactor vessel
- pressurized water reactor (PWR)** – type of nuclear reactor in which water is kept under pressure in the reactor core so that the water can be heated to a temperature greater than 100°C or 212°F without boiling
- reactor** – the part of a nuclear power plant where fission takes place
- steam generator** – a machine that uses heat in a power plant to produce steam to turn turbines
- thermodynamics** – the science of the way heat transfers or moves
- turbine** – a wheel with many blades that are spun and connected to a generator to make electricity

Lesson Six – Chapter Outline

The nuclear reactor

- Fuel assemblies
- Control rods
- Coolant/moderator
- Pressure vessel (can also be called reactor vessel)
- Containment building

Heat transfer via loops of piping

- Heating water in the first loop
- Generating steam in the second loop
- Turning the turbine
- Spinning the generator
- Cooling water in the third loop

Types of nuclear power plants (supplemental information for teachers)

Reading

Reading for this lesson in the student reader can be assigned as homework prior to this class session, or it can be read in class as guided reading. A Reading Review Exercise follows so that you can reproduce or project it for your class.

Performance Assessment and Extensions

A Reading Review Exercise follows that you can reproduce or project for your class. The labs and activities that follow include inquiry-based questions that can be used to assess student learning. Accompanying this lesson is a PowerPoint lecture with a review that can be used as an interactive assessment. For a project-based assessment, have students create a blog, podcast, or video on a topic from this lesson.

Lesson 6 Reading Review Exercise

A. Indicate whether the following statements are true (T) or false (F) by circling the correct letter. If the statement is false, correct it to make it true.

1. To speed up a chain reaction, control rods are inserted into the reactor core. T F
2. Control rods regulate the speed of a chain reaction by absorbing neutrons that could otherwise cause fission. T F
3. The faster neutrons move, the more likely they are to cause uranium-235 atoms to fission. T F
4. Water is used to keep the core of the reactor from becoming too hot. T F
5. Fission takes place inside the steam generator. T F
6. A nuclear power plant and a coal-fired power plant both use steam to turn a turbine to generate electricity. T F
7. The fuel assemblies, control rods, coolant/moderator, and pressure vessel make up the reactor core. T F
8. The water from the reactor and the water in the steam generator never mix. T F
9. Although water reaches very high temperatures in the reactor, it does not turn to steam because it is under pressure. T F
10. Heat always flows from a cold object to a warmer object. T F

B. Your goal is to keep the temperature inside the reactor at 315° C (600° F).

1. If the temperature reaches 350° C (662° F), do you put in or take out the control rods?
2. If the temperature is 200° C (392° F), do you put in or take out the control rods?

C. Label the following in the drawing below:

fuel assemblies

coolant/moderator

turbine

pressure vessel

containment building

cooling tower

control rods

condenser

generator

pressurizer

steam generator

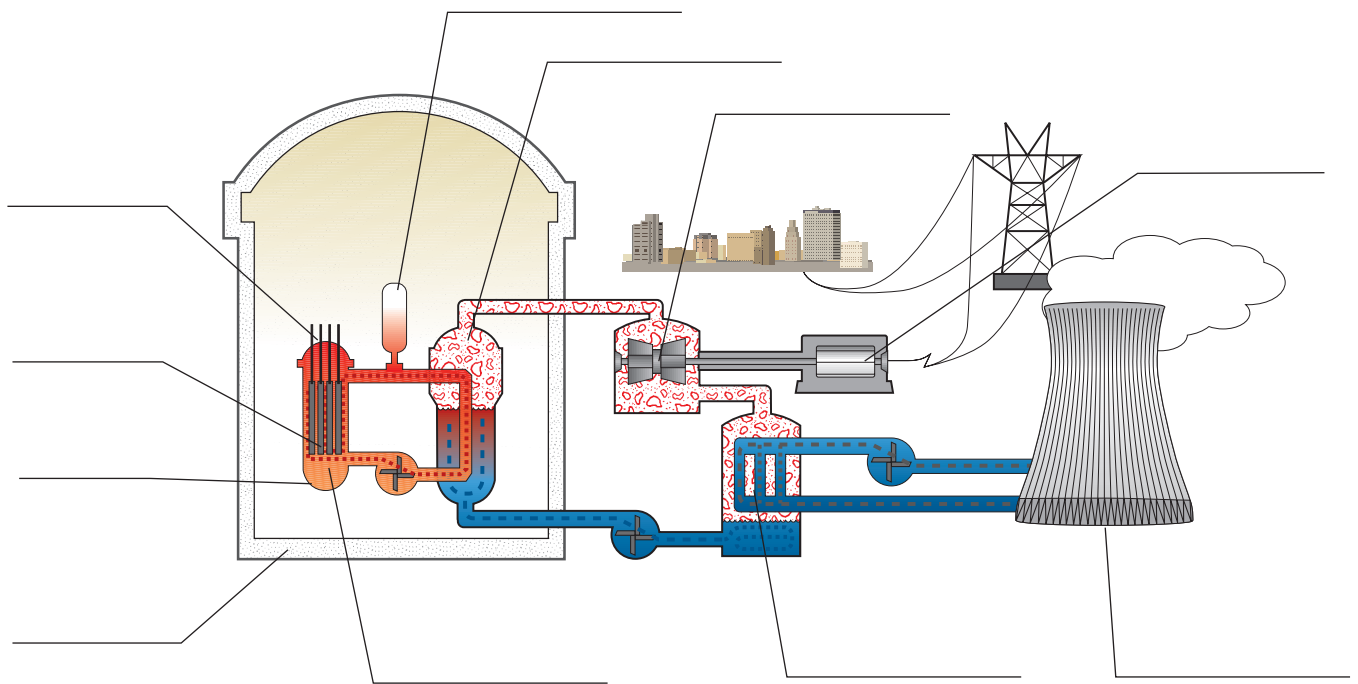

Lesson 6 Reading Review Exercise - Answers

A. Indicate whether the following statements are true (T) or false (F) by circling the correct letter. If the statement is false, correct it to make it true.

1. To speed up a chain reaction, control rods are inserted into the reactor core. *Inserting control rods slows the reaction* T (F)
2. Control rods regulate the speed of a chain reaction by absorbing neutrons that could otherwise cause fission. (T) F
3. The faster neutrons move, the more likely they are to cause uranium-235 atoms to fission. T (F)
If neutrons move too fast, they are less likely to cause fission
4. Water is used to keep the core of the reactor from becoming too hot. (T) F
5. Fission takes place inside the steam-generator. T (F)
Fission occurs inside the reactor core's fuel assemblies in the core
6. A nuclear power plant and a coal-fired power plant both use steam to turn a turbine to generate electricity. (T) F
7. The fuel assemblies, control rods, coolant/moderator, and pressure vessel make up the reactor core. (T) F
8. The water from the reactor and the water in the steam generator never mix. (T) F
9. Although water reaches very high temperatures in the reactor, it does not turn to steam because it is under pressure. (T) F
10. Heat always flows from a cold object to a warmer object. T (F)
Heat moves from a warm object to a cooler object

B. Your goal is to keep the temperature inside the reactor at 315° C (600° F).

1. If the temperature reaches 350° C (662° F), do you put in or take out the control rods?
2. If the temperature is 200° C (392° F), do you put in or take out the control rods?

C. Label the following in the drawing below:

fuel assemblies

pressure vessel

control rods

pressurizer

coolant/moderator

containment building

condenser

steam generator

turbine

cooling tower

generator

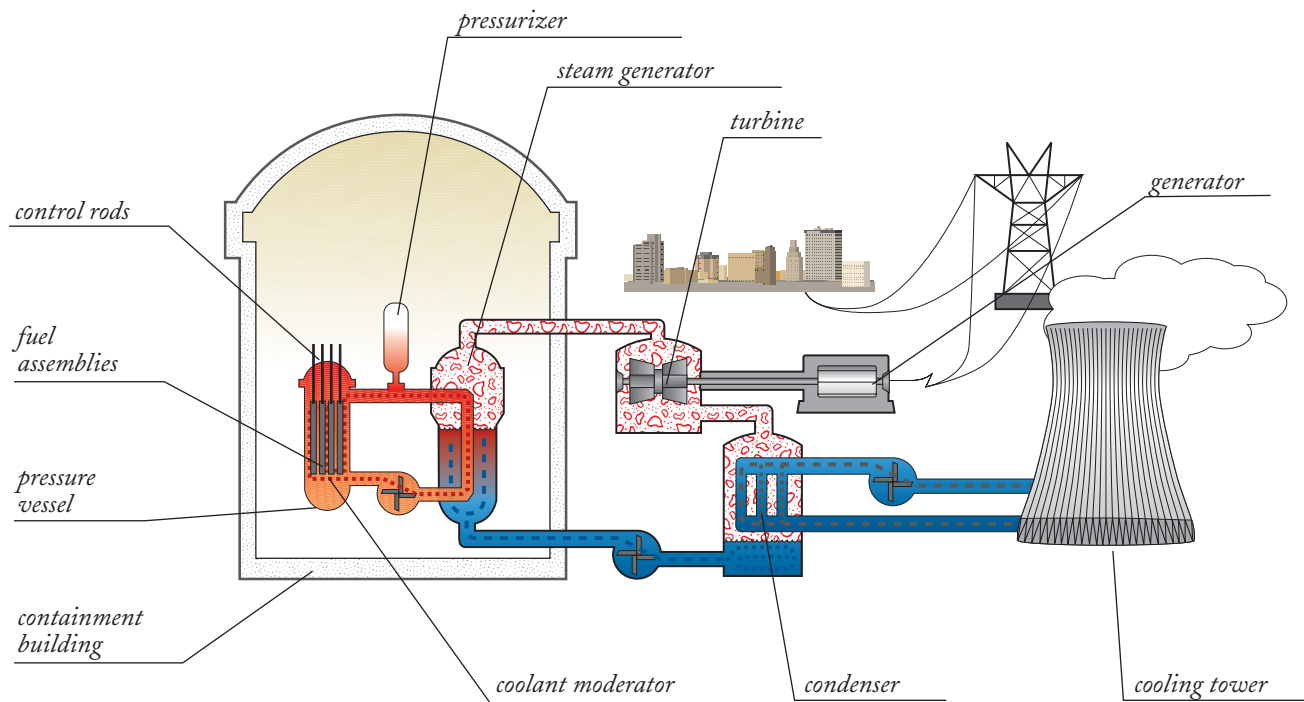

Activities, Labs, and Supplemental Information

The primary in-class activities for Lesson 6 provide a review of the parts of a nuclear power plant and how they operate. These activities will reinforce what the main parts are and what the function is of each part.

Animation for pressurized water reactor (PWR)

www.nrc.gov/reading-rm/basic-ref/students/animated-pwr.html

Animation for boiling water reactor (BWR)

www.nrc.gov/reading-rm/basic-ref/students/animated-bwr.html

Inside a Nuclear Control Room

www.pbs.org/wgbh/nova/tech/nuclear-control-room.html

(8 panels of photos with explanatory text give a picture of the control room)

A good animation of a coal-fired power plant

Coal-fired plant animation

www.duke-energy.com/about-energy/generating-electricity/coal-fired-how.asp

Teacher's PowerPoint Presentation

A Teacher's (PowerPoint) presentation is provided on CD and online on the DOE Office of Nuclear Energy website to help you present chapter concepts to your class. Download the teacher presentation at: <http://energy.gov/ne/services/harnessed-atom>

Interactive Computer Game

The interactive computer game "Power it Up" is provided on CD or is available online at <http://energy.gov/ne/services/harnessed-atom>. The interactive puzzle teaches students how electricity is produced within a power plant. Students are challenged to assemble the major parts of a power plant in the correct positions.

Players must first answer a question, then select the part, according to the question asked, and drag it into place in the plant diagram. Correct answers add points to their score as students build the plant. For a team-based activity, divide the class into teams and challenge them to compare their times and their scores.

Each power plant build will take students less than 10 minutes to complete.

Careers in the Nuclear Industry

Watch the video included with this curriculum, Careers in Nuclear Science. Middle school is not too early for students to begin thinking about their future and the kinds of careers they may want to investigate. This lesson provides a good opportunity to introduce students to careers at nuclear power plants or in other segments of the nuclear industry, as well as in other areas related to energy. DOE's Energy Information Agency website has a link to a Career Corner, courtesy of the National Energy Education Development project. This site has information about careers in the nuclear industry, energy management, offshore energy, oil and natural gas, petroleum offshore oil rigs, solar energy, and wind energy: tonto.eia.doe.gov/kids/energy.cfm?page=activities_career_corner

Lab – Model of a Power Plant

Students can build a paper model of a pressurized water power plant, either individually or in teams. Later in the lesson plan are the main pieces of the power plant for you to photocopy. Students should cut out the pieces and then assemble them. Several pieces may be placed on top of other pieces in the model. Students should be able to describe the function of the various power plant parts. In addition, cut-outs are available to show a coal-fired plant. Using the coal and nuclear cut-outs will emphasize that the means for generating heat is the difference between these plants. You may want to start this lesson by asking students to put the model together before they know how. Repeating the assembly at the end of the lesson serves as an assessment.

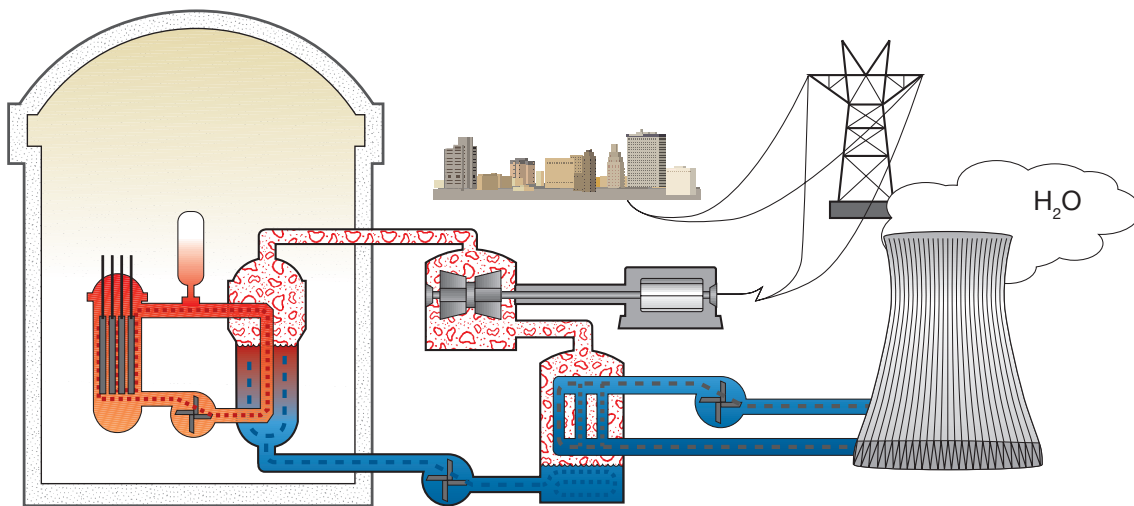

Nuclear Power Plant

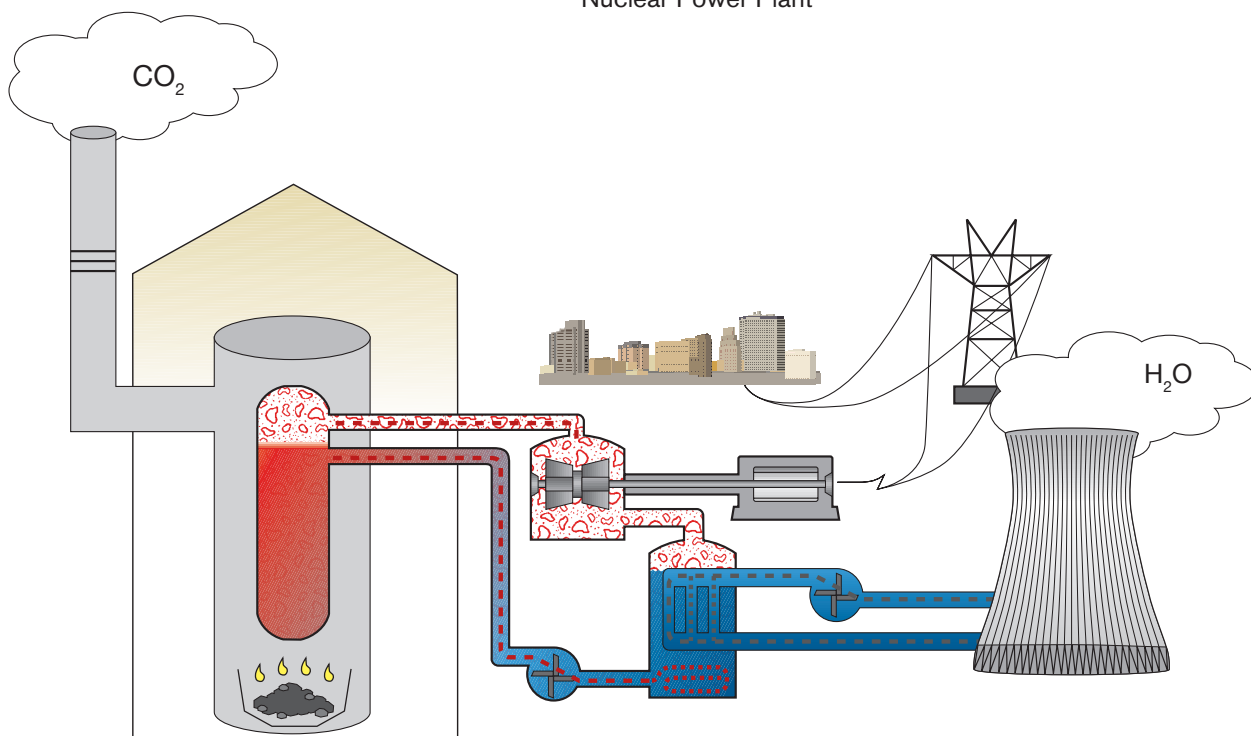

Coal-fired Power Plant

Lab - Fission Food Fight

This activity was suggested by Stacy Militello, physical and earth science teacher, Oak Middle School, Shrewsbury, MA. Have each student make two “neutrons” by crumpling two sheets of recycle paper. Begin the activity by tossing one “neutron” to hit a student. When that student is hit by a neutron, he or she throws the two neutrons at two different students, etc. Directions for this activity follow.

Math and Social Studies Extensions - Nuclear Power Reactors in the World

Direct your students to find the most recent world nuclear power reactor information from the International Atomic Energy Agency (IAEA) publication, *Nuclear Power Reactors in the World*, updated annually. Developing inquiry-based skills, students will pull information from a verified source to cite evidence for their conclusions.

Social Studies Extension - Be a Detective

This activity features a rich collection of photographs and other primary sources from the National Archives. Primary sources are the original documents and objects that were created at the time under study. From diaries and letters to newspapers and maps, primary sources tell us about the circumstances of significant historical events in terms of everyday life. Using photographs as primary sources can make history come alive for students. Besides developing critical thinking and deductive reasoning skills, your students may enjoy becoming “detectives” by looking at photographs for evidence to help them draw conclusions. You can find more information about using primary sources in your classroom from the Smithsonian Institute at <http://historyexplorer.si.edu/PrimarySources.pdf>

Supplemental Information**Ask a Scientist**

The Nuclear Regulatory Commission (NRC) website maintains a resource that will enable you to ask a question and have a scientist try to help you. Email your question to OPA.Resource@nrc.gov and someone from the NRC will try to help you.

What are Some Other Types of Reactors?

The pressurized water reactor (PWR) is the most common type of reactor in the United States. The second type is the boiling water reactor (BWR). These two types are the only kinds currently in operation in the United States. Both PWRs and BWRs are in a family of reactors called light water reactors.

See www.nrc.gov/reactors/power.html for more information.

The main difference between a PWR and a BWR is that the PWR has three loops, while the BWR has only two. This means that a BWR does not have a steam generator. Instead, water in a BWR boils inside the pressure vessel, and the steam is used directly to turn the turbine. The control rods come up from the bottom instead of coming down from the top.

Why are there different types of reactors?

Engineers have worked on different designs to improve safety and efficiency and to reduce the cost of fueling and operating these power plants. Different companies specialize in each design.

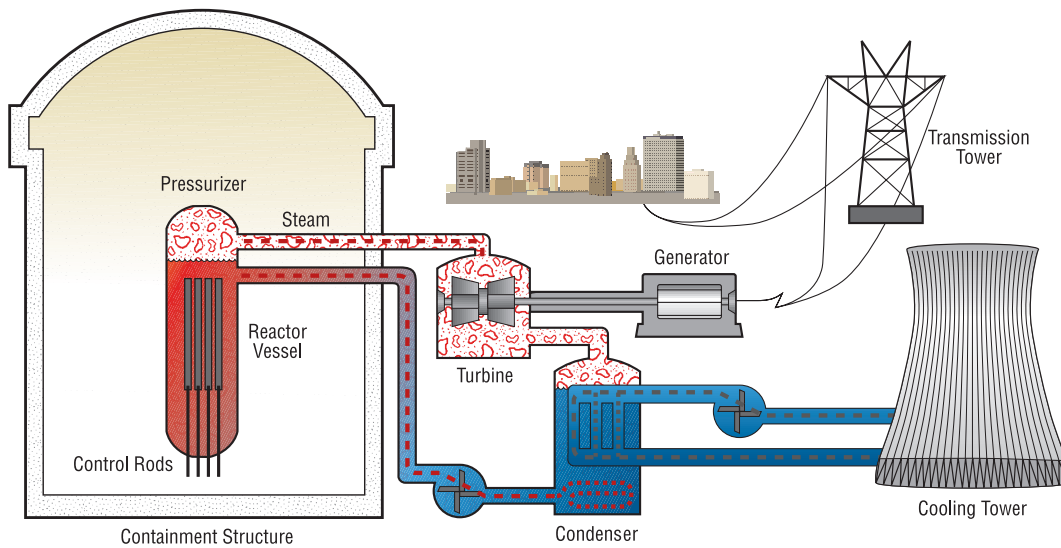

Boiling Water Reactor (BWR)

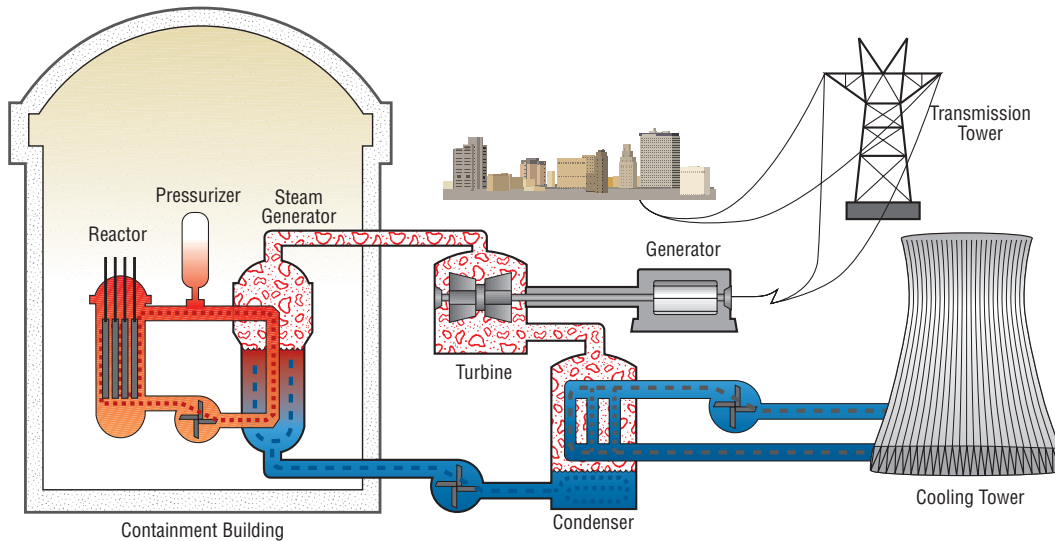

Pressurized Water Reactor (PWR)

Other Nuclear Power Plant Designs Around the World, 2014

Reactor type	Main countries	Number	Fuel	Coolant	Moderator
Pressurized Water Reactor (PWR) ¹	U.S., France, Japan, Russia, China, U.K., South Korea, Sweden	277	Enriched UO ₂	Water	Water
Boiling Water Reactor (BWR) ¹	U.S., Japan, Sweden, Taiwan, Mexico, Spain, Germany	80	Enriched UO ₂	Water	Water
Gas-cooled Reactor (GCR) ²	UK	15	Natural U (metal), enriched UO ₂	CO ₂	Graphite
Pressurized Heavy Water Reactor 'CANDU' (PHWR) ³	Canada, Argentina, South Korea, India, Romania	49	Natural UO ₂	Heavy water	Heavy water
Light Water Graphite Reactor (LWGR) ⁴	Russia	15	Enriched UO ₂	Water	Graphite
Fast Neutron Breeder Reactor (FBR) ⁵	China, Russia	2	PuO ₂ and UO ₂	Liquid sodium	None needed
	TOTAL	438			

Source: IAEA 2015, Nuclear Power Reactors in the World (as of 31Dec. 2014).

- 1 Light water is ordinary water—two hydrogen atoms and an oxygen atom.
- 2 Gas-cooled reactors. This approach uses an inert gas, such as carbon dioxide or helium, instead of water to cool the reactor. Because it is already a gas, the coolant does not have the potential to boil when it reaches high temperatures inside the graphite core. Gas transfers heat to water to power the steam turbine.
- 3 Heavy water reactors. Heavy water has two deuterium molecules—an isotope of hydrogen with an extra neutron—and one oxygen atom. This extra neutron reduces interaction between water and neutrons from the fission reactions. As we have already learned, uranium enrichment is a complex and expensive process. When heavy water is used as a moderator, the reactor can operate on natural instead of enriched uranium.
- 4 Graphite reactors. The first reactors used graphite as a moderator. Russia built a number of power plants using this design, in which water is circulated through channels in the graphite core to cool the reactor and transfer heat to the steam turbine. Because of safety concerns, however, this design is not used in new power plants. Graphite is used in new designs for high temperature gas-cooled reactors.
- 5 Fast neutron breeder reactors. Using a design similar to a pressurized water reactor, breeder reactors produce new plutonium-239 fuel as they operate. Instead of water, the reactor is cooled with liquid metal (sodium), which conducts heat efficiently and does not slow the neutrons from the fission reaction. Therefore, these “fast” excess neutrons can be used to strike uranium-238 atoms in a blanket surrounding the core. Adding a neutron converts the uranium-238 to plutonium-239.

Math and Social Studies Extensions – Nuclear Power around the World

Reactor type	Main countries	Number	Fuel	Coolant	Moderator
Pressurized Water Reactor (PWR)					
Boiling Water Reactor (BWR)					
Gas-cooled Reactor (GCR)					
Pressurized Heavy Water Reactor 'CANDU' (PHWR)					
Light Water Graphite Reactor (LWGR)					
Fast Neutron Breeder Reactor (FBR)					
	TOTAL				

Materials

Computer (laptop, desktop, or tablet)

Paper, pencil or pen, and markers or crayons or create a file on your computer

Math Procedure

1. Go to the International Atomic Energy Agency's website: <http://www-pub.iaea.org/books/>.
2. Search for the current "Nuclear Power Reactors in the World." Open the booklet on your computer's browser. Find the table in the booklet that tells how many plants are "operational." Use it to update the table above. [Note: "Operational" means a power plant is working to produce electricity.]
3. Create a circle graph to show the percentages of reactor types to total reactors.
4. Add a column to the table above that shows the operational capacity of each reactor type. Create another circle graph to show the percent of gigawatts per type to total production.

Social Studies Procedure

1. Follow step one above. Find the table in the booklet that tells how many plants are "operational." [Note: "Operational" means a power plant is working to produce electricity.]
2. Got to the NASA website at http://er.jsc.nasa.gov/seh/mission_geography/map_index.pdf and choose the blank outline world map.
3. Using your geography knowledge and the IAEA booklet, color code the countries that generate electricity using nuclear energy.
4. Look at your map and give it a title. Write a caption for your map that tells how many countries harness atoms to make electricity.

Lab – Model of a Reactor

Make a model of a pressurized water nuclear power plant by cutting the pieces out and arranging them in the correct order. Several pieces may be placed on top of other pieces in your model.

For a nuclear power plant

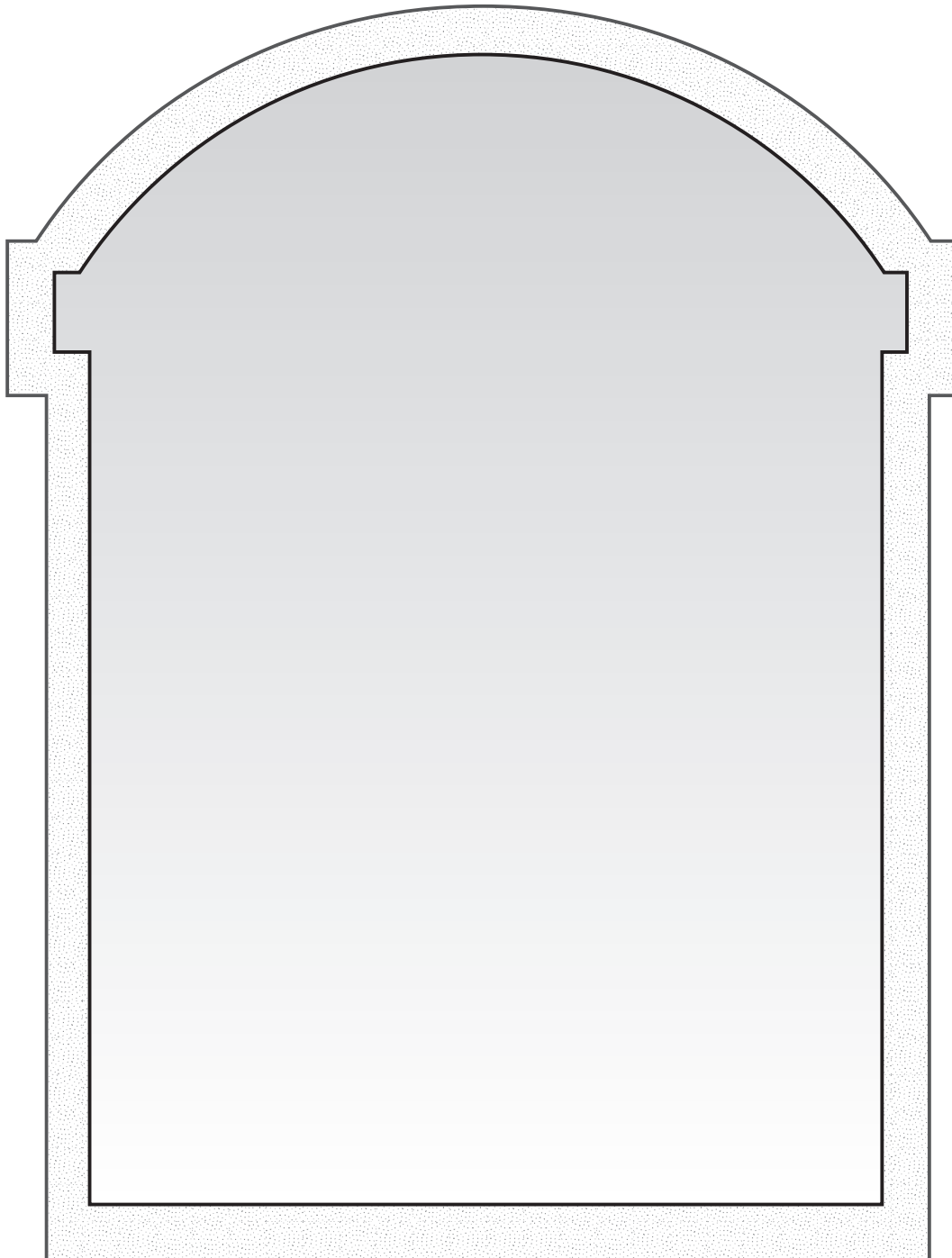

condenser

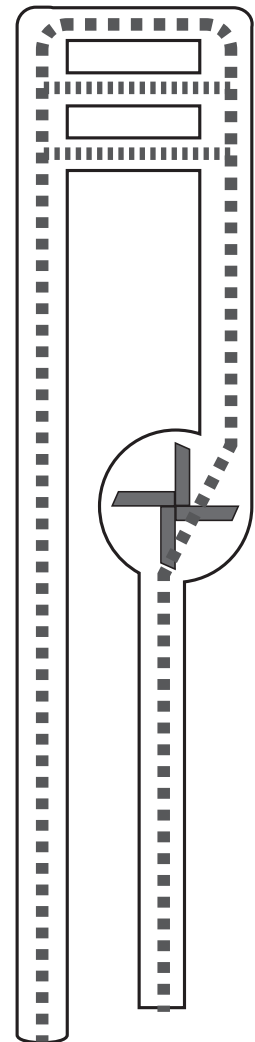

containment building

For a nuclear power plant (*continued*)

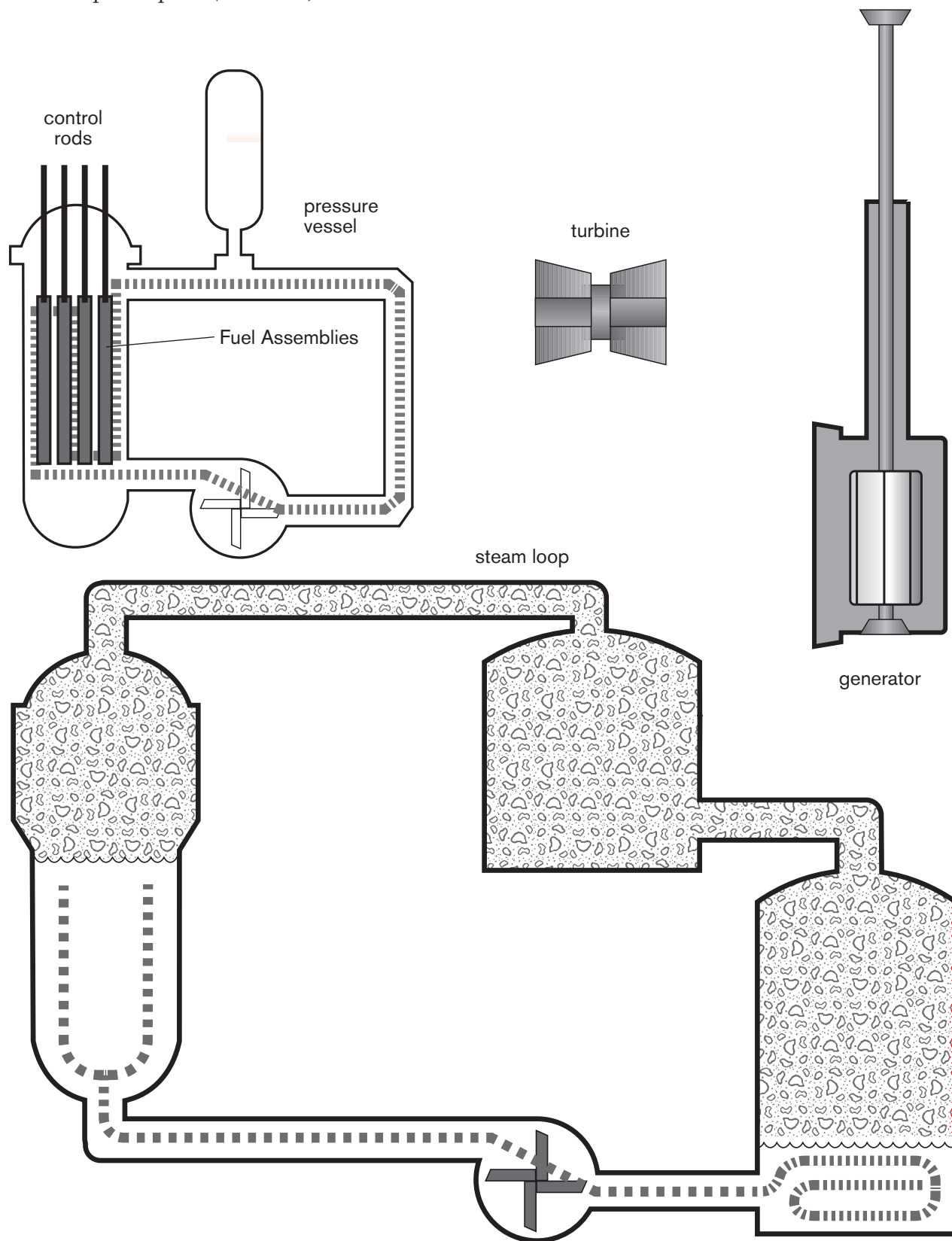

For a nuclear power plant *(continued)*

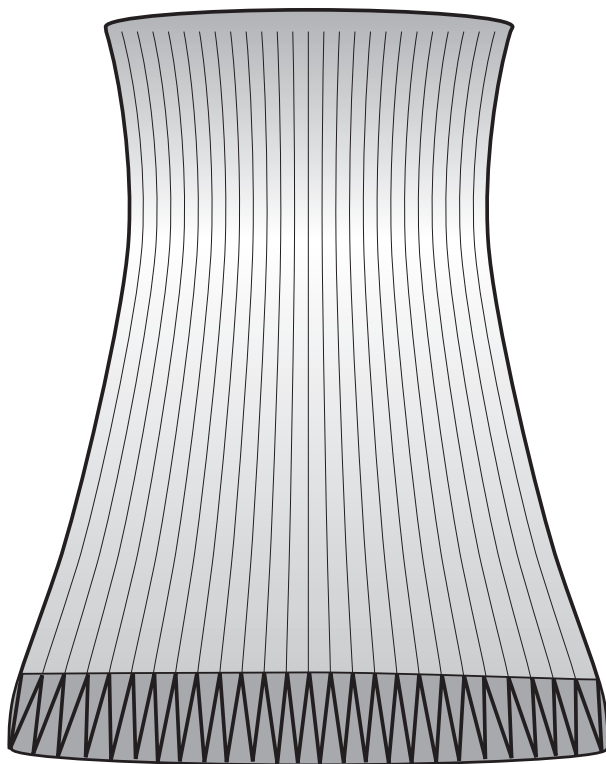
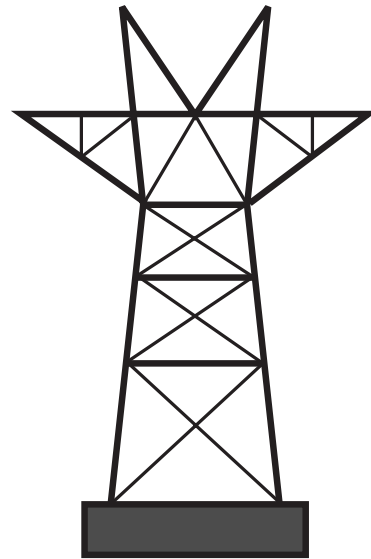
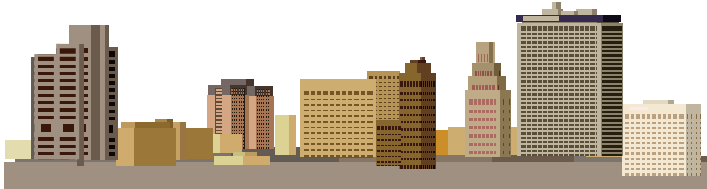

cooling tower



For a coal-fired power plant

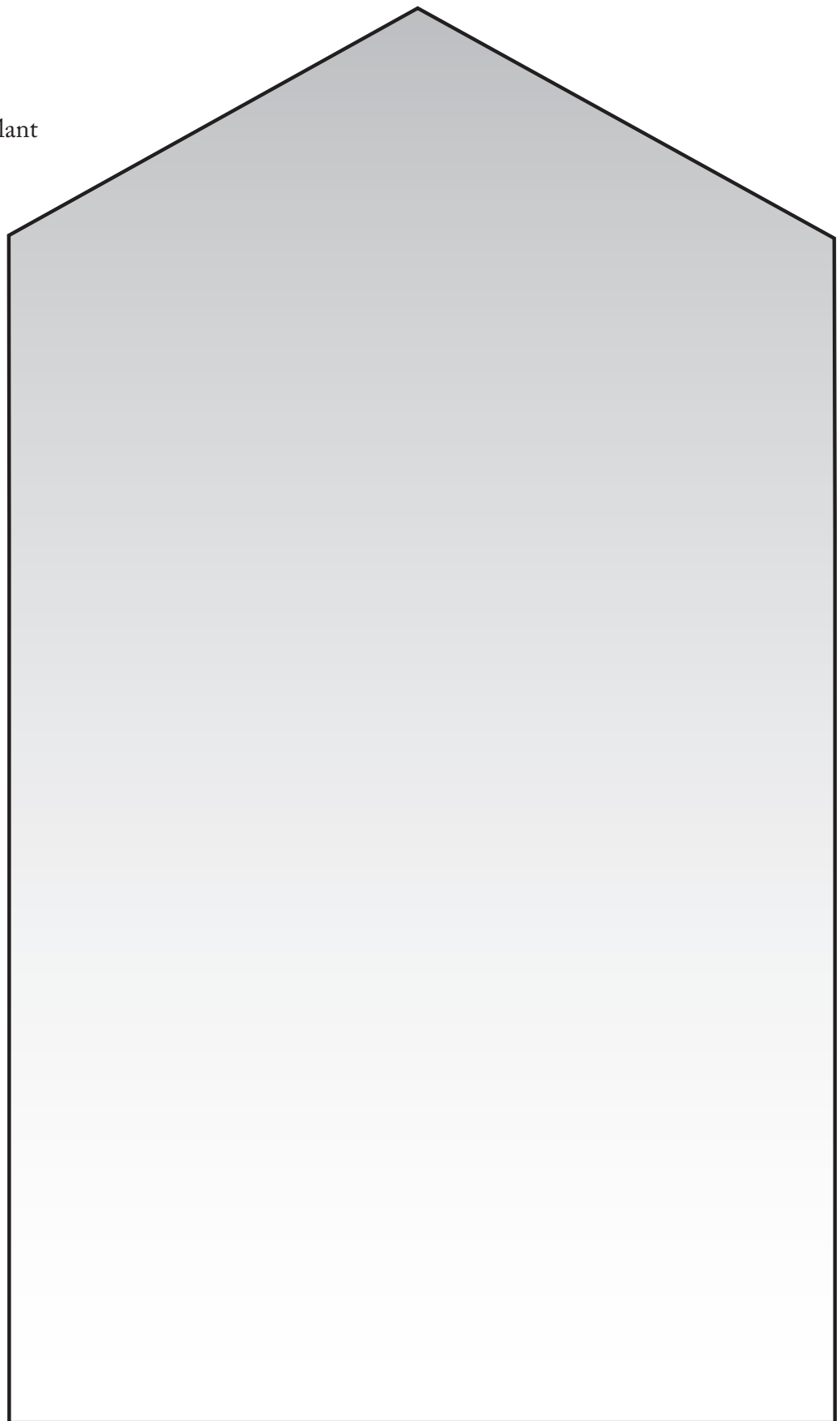
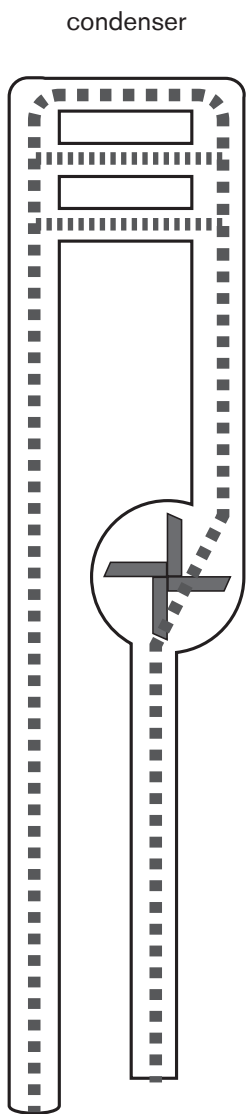

containment building

For a coal-fired power plant (continued)

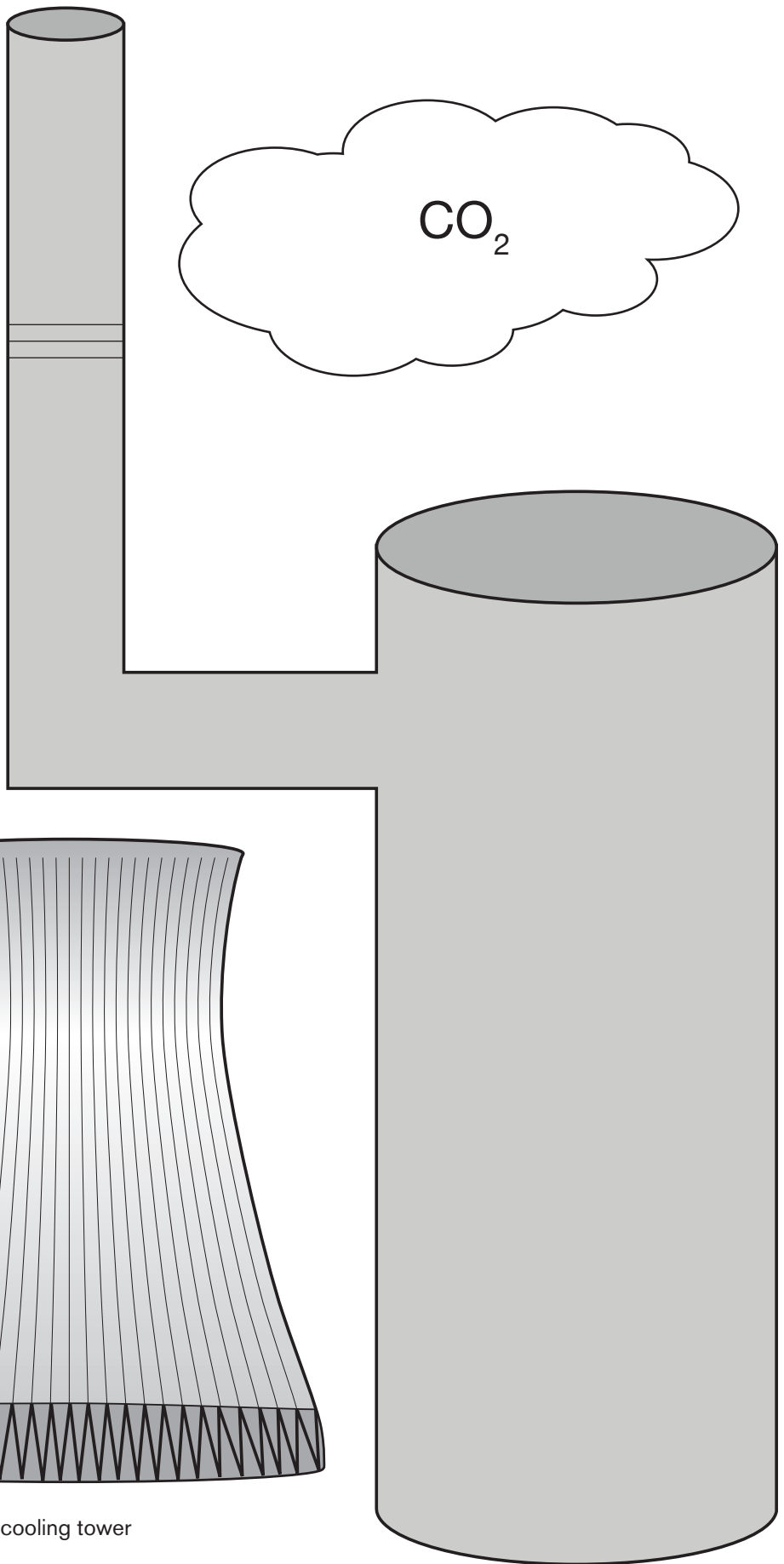
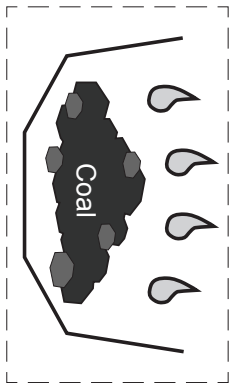
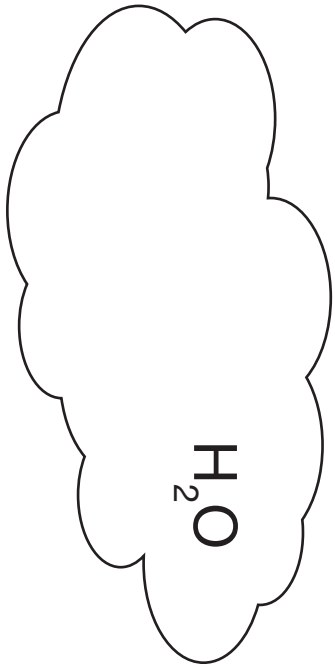

cooling tower

Lab – Fission Food Fight

For a chain reaction to work, precise conditions must be met. Try this experiment to see (and feel) how it works. For the “food fight,” we’ll use paper wads instead of food so you won’t have so much mess to clean up.

Background

Enrico Fermi was the first scientist to achieve a nuclear fission chain reaction. He and a group of young scientists were experimenting at the University of Chicago on December 2, 1942.

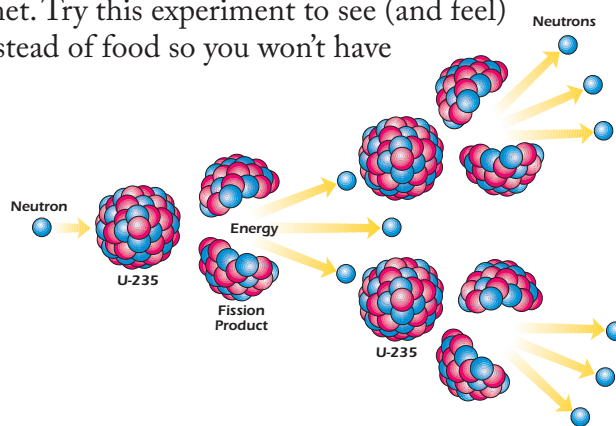

Materials

- 20 to 40 students. Each student equals one uranium-235 atom.
- 41 to 81 paper wads (Two wads per student, made from 8 ½ x 11 paper sheets from a recycle bin) Each paper wad equals one neutron.
- Video camera or phone (optional)
- Stopwatch or timer

Procedure

1. Clear an area in the classroom so students can stand in a square area about 1 meter apart.
2. Students each take two paper wads. The teacher takes one. Students hold a paper wad in each hand.
3. Start the video recording.
4. Students close their eyes and turn around in place for 1 second, then stand still and wait.
5. The teacher starts the timer and tosses a paper wad into the square of students to start the reaction.
6. Tell students, “When you feel a paper wad strike your body, toss both of your paper wads in opposite directions across the front of your body.”
7. Stop the timer and recording when the paper stops flying. Students can now open their eyes.
8. Have students who still have their paper wads hold them up. Note where they are standing.

Discussion

Watch your video. Describe what happened. _____

What part of the reactor do the students inside the square represent? _____

What do the students represent? _____

What do the paper wads represent? _____

Where were most of the atoms that did not undergo fission? _____

How does this explain why used fuel is removed from the center of the core first?

Who do you think should be responsible for cleaning the waste? _____

Try This Next

- A. Repeat the experiment, but with students standing 2 meters (6.5 feet) apart. What condition would this simulate? _____
- B. Repeat the experiment, but with students standing .5 meters (1.5 feet) apart. What condition would this simulate? _____
- C. Repeat the experiment with only half of the students holding neutrons. What would this simulate? _____
- D. Repeat the experiment with four students in the group holding up sheets of poster board to block the flying paper wads. What would this simulate? _____
- E. Repeat the experiment, but add a circle of students around the outside holding neutrons. Whenever a neutron from the core escapes without hitting another student inside, the students around the circle collect it. What would this simulate? _____

Math Extension

1. Compare the duration of the first experiment with the *Try This Next* experiments A-D. Show the results as a graph.
2. Record the number of students on the outer part of the square (x) who still have their “neutrons” after the experiment and compare it with the number of those in the inner part (x). Express this comparison as a percentage of the total in each group.

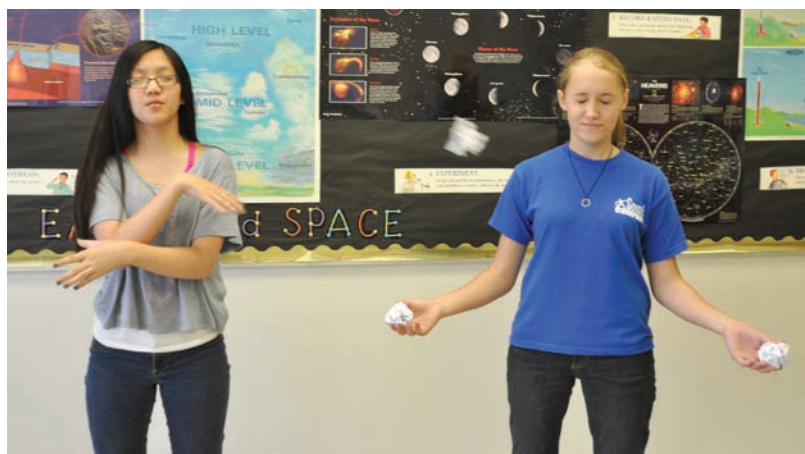

Lab – Fission Food Fight - Answers

For a chain reaction to work, precise conditions must be met. Try this experiment to see (and feel) how it works. For the “food fight,” we’ll use paper wads instead of food so you won’t have so much mess to clean up.

Background

Enrico Fermi was the first scientist to achieve a nuclear fission chain reaction. He and a group of young scientists were experimenting at the University of Chicago on December 2, 1942.

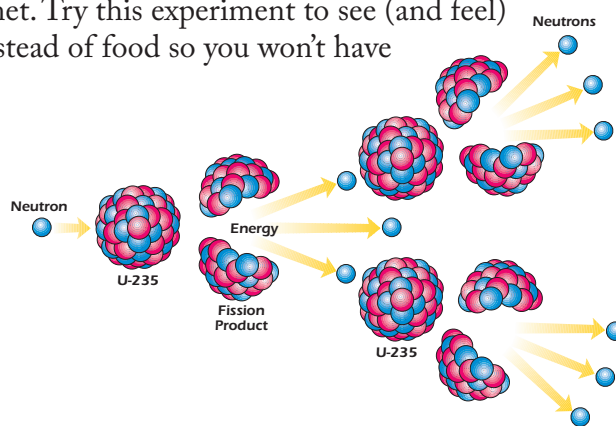

Materials

- 20 to 40 students. Each student equals one uranium-235 atom.
- 41 to 81 paper wads (Two wads per student, made from 8 ½ x 11 paper sheets from a recycle bin) Each paper wad equals one neutron.
- Video camera or phone (optional)
- Stopwatch or timer

Procedure

1. Clear an area in the classroom so students can stand in a square area about 1 meter apart.
2. Students each take two paper wads. The teacher takes one. Students hold a paper wad in each hand.
3. Start the video recording.
4. Students close their eyes and turn around in place for 1 second, then stand still and wait.
5. The teacher starts the timer and tosses a paper wad into the square of students to start the reaction.
6. Tell students, “When you feel a paper wad strike your body, toss both of your paper wads in opposite directions across the front of your body.”
7. Stop the timer and recording when the paper stops flying. Students can now open their eyes.
8. Have students who still have their paper wads hold them up. Note where they are standing.

Discussion

Watch your video. Describe what happened. answers vary

What part of the reactor do the students inside the square represent? the core

What do the students represent? uranium-235 atoms that make up the fuel of the reactor

What do the paper wads represent? neutrons released by the uranium-235 atoms during fission

Where were most of the atoms that did not undergo fission? where students did not throw their paper wads

How does this explain why used fuel is removed from the center of the core first?

atoms in the reactor core are mostly likely to be struck by a neutron and fission

Who do you think should be responsible for cleaning the waste? answers vary

Try This Next

- A. Repeat the experiment, but with students standing 2 meters (6.5 feet) apart. What condition would this simulate? lower density core slows the reaction
- B. Repeat the experiment, but with students standing .5 meters (1.5 feet) apart. What condition would this simulate? more highly enriched uranium, a super-critical reaction
- C. Repeat the experiment with only half of the students holding neutrons. What would this simulate? lower enrichment fuel—more U-238 atoms, which do not fission
- D. Repeat the experiment with four students in the group holding up sheets of poster board to block the flying paper wads. What would this simulate? control rods that absorb neutrons and slow or stop the reaction
- E. Repeat the experiment, but add a circle of students around the outside holding neutrons. Whenever a neutron from the core escapes without hitting another student inside, the students around the circle collect it. What would this simulate? a breeder reactor, where the core is surrounded by a blanket of U-238, and escaping neutrons breed new fuel

Math Extension

1. Compare the duration of the first experiment with the *Try This Next* experiments A-D. Show the results as a graph.
2. Record the number of students on the outer part of the square (x) who still have their “neutrons” after the experiment and compare it with the number of those in the inner part (x). Express this comparison as a percentage of the total in each group.

x x x x x x
 x x x x x x
 x x x x x x
 x x x x x x

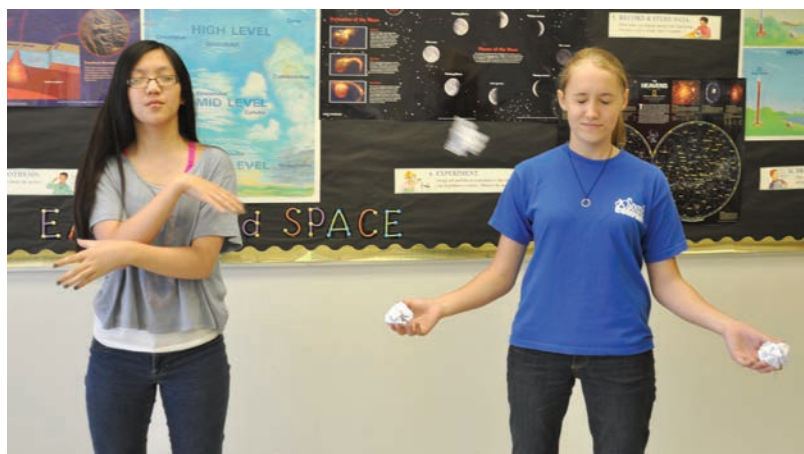

Social Studies Extension – Using Photographs as Primary Sources

Primary sources are crucial to the study of history. Besides developing critical thinking and deductive reasoning skills, your students may enjoy becoming “detectives” by looking at photographs for not only a glimpse of the past but for evidence that will help them draw conclusions.

1. Divide students into groups of three or four and assign each group one of the four photographs from the collection available from the National Archives site: <http://www.archives.gov/atlanta/exhibits/tva-nuclear.html>
2. Project or hand out copies or send student groups to computer stations in your classroom or school computer laboratory.
3. Have each student record answers to these questions and ask for cited evidence:
 - What are your first impressions of this photo? (Encourage answers to who, what, when, where?)
 - What is happening in the photograph? How do you know?
 - Using what you have learned about types of power plants, what can you theorize about the photograph?
 - What are you confident is true in this photo? What questions do you have about the photograph that you cannot answer through analyzing it? What are the limitations and strengths of photographs for historians? Where could you go next to learn more?

Find more information about using primary sources in the classroom from the Smithsonian Institute at <http://historyexplorer.si.edu/PrimarySources.pdf>

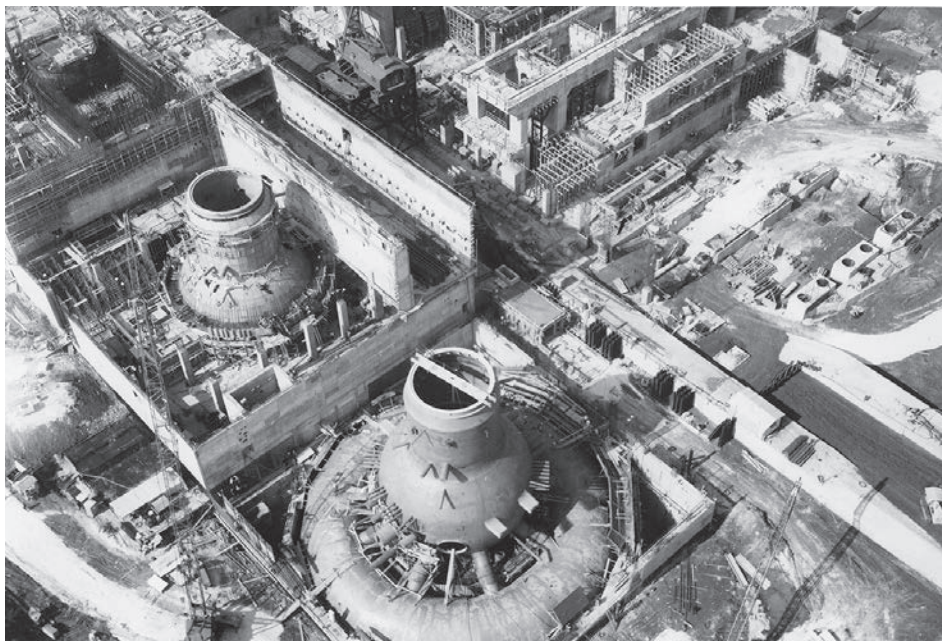

Browns Ferry Nuclear Plant. Construction began on Browns Ferry Nuclear Plant in 1966, and when completed in 1974, it was the largest nuclear plant in the world.

WASTE FROM NUCLEAR POWER PLANTS



Spent Fuel

Low-level Waste

Introduction

This lesson takes a look at the waste from electricity production at nuclear power plants. It considers the different types of waste generated, as well as how we deal with each type of waste.

TOPICS:

- Waste
- Types of radioactive waste
- Low-level waste
- High-level waste
- Disposal
- Transporting waste
- Reprocessing
- Waste isolation
- Decommissioning

Teachers' Notes:

By volume, the amount of high-level waste from power plants is small. If all the used fuel ever generated from 100 U.S. nuclear reactors were stacked end to end, it would cover a football field to a depth of only about 10 meters. However, the amount of radioactivity it contains is very high, and it is not feasible to put this waste into such a small space.

What is waste?

In our day-to-day living, we make a lot of trash. Think of how much garbage your family collects in one week. Think of how much trash you have from just one visit to a fast-food restaurant. It probably includes wrappers, bags, straws, drink containers, and leftover food. Industries also have trash each time they do or make something. These leftovers are called **by-products** or **wastes**.

What is nuclear waste?

Like all industries, nuclear power plants produce wastes. One of the main concerns about nuclear power plants is getting rid of the wastes safely.

The problem with wastes at nuclear plants is not the amount they make, which is quite small in comparison with the amount of

waste from other industries. The problem is that some nuclear power plant wastes are radioactive. This means that disposing of the waste requires special care to protect workers, the public, and the environment.

How do we decide the way to dispose of waste?

When you finish your lunch in the school cafeteria, do you just throw your tray and everything on it in a pile for someone else to deal with later? Probably not. There is a place for your tray, another place to sort dishes, and a bin for the silverware. Your trash goes in the garbage

If all the electricity you used in your lifetime was generated by nuclear power plants, your share of the highly radioactive waste would fit in a soda can.



can, and there might even be separate places to put recyclables and compost. Why are there so many ways to get rid of what is left after lunch? Because it is best to handle different wastes in different ways.

It is the same with wastes from a nuclear power plant. There is a special way for disposing of each type of waste. The way it is disposed of depends on

- How radioactive the waste is
- The half-life of the waste
- The physical and chemical form of the waste

What is low-level waste?

In the United States, most low-level radioactive wastes comes from hospitals, research labs, industry, and nuclear power plants. **Low-level waste** includes items that have become contaminated with radioactive material. This waste includes shoe covers, mops, water and air filters, cleaning rags, lab supplies, broken tools, gloves, and used protective clothing.

Doctors perform 100 million medical procedures each year that use radiation or radioactive materials, and many of these produce low-level waste.



Low-level radioactive waste is stored in containers and covered with soil.

Many companies also use radioactive materials and have low-level waste to dispose of. These companies

- Make smoke detectors
- Make instruments used to inspect for defects in highways, pipelines, and aircraft
- Test and develop 80 percent of our new drugs
- Make supplies for medical procedures that use radiation or radioactive materials
- Make electricity at nuclear power plants

How do we dispose of low-level waste?

Low-level radioactive waste is sealed in containers and shipped to a licensed disposal site. The containers are put in the ground and covered with soil. Then a “cap” of soil and clay is put over the site. The cap keeps the site dry. The site is monitored with sensors that can detect radiation.

Workers and regulatory agencies also regularly check radiation levels at open and filled trenches and around the site boundary.

Teachers' Notes:

See later in this lesson illustrations of wastes/disposal for all steps in the nuclear fuel cycle.

Teachers' Notes:

Ask students why it is important to keep waste dry (to prevent migration; contamination of water sources).

Why does half-life matter? (Half-life determines how long the waste will remain radioactive.)

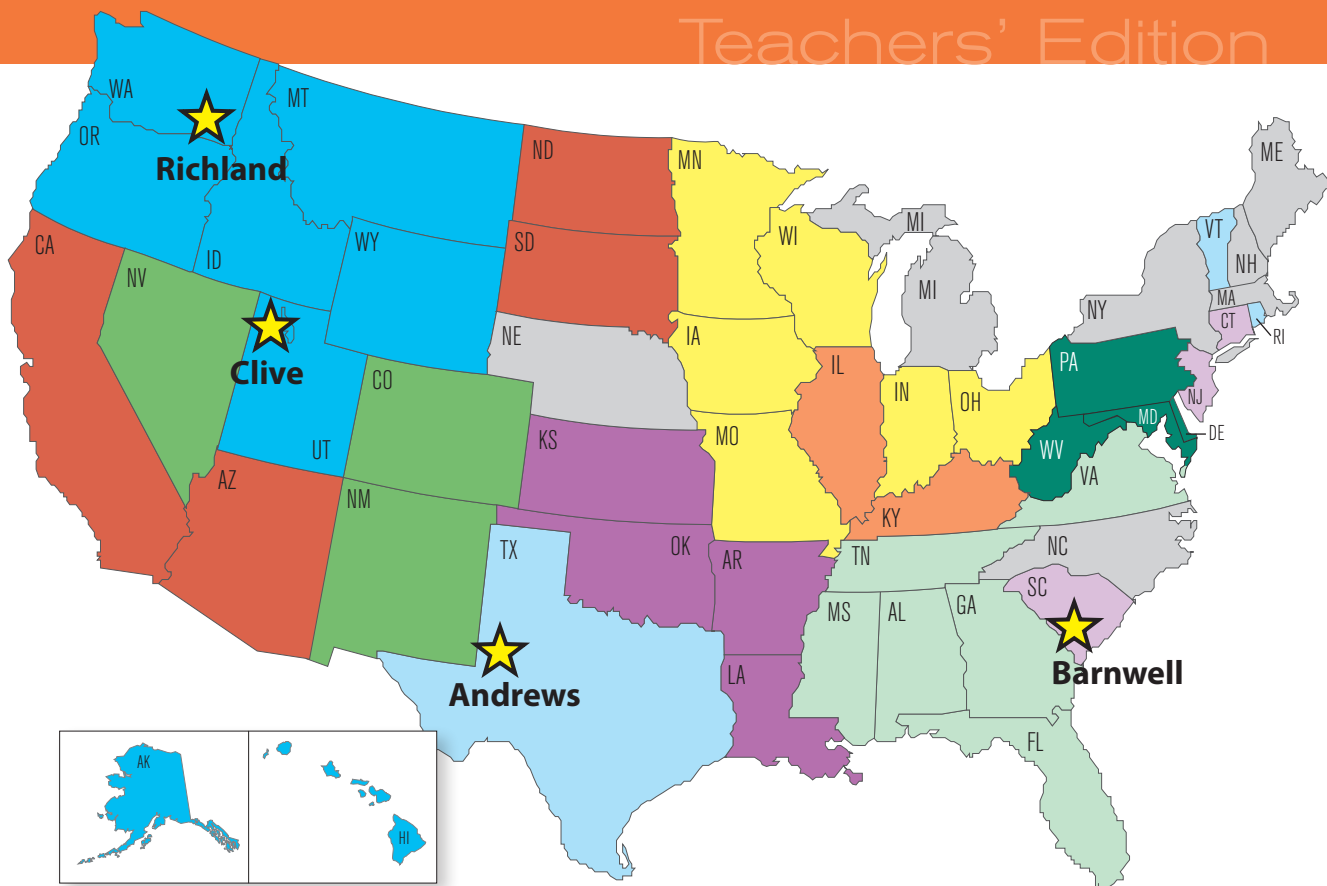

Teachers' Notes:

This lesson discusses commercially generated nuclear waste. Wastes from defense programs are the responsibility of the federal government and are handled separately.

However, States are responsible for disposal of low-level wastes from federal government facilities like veterans' hospitals or non-weapons-related government facilities.

The federal government is responsible for disposal of low-level waste generated by the U. S. Department of Energy, including wastes from the atomic weapons program and from the decommissioning of nuclear reactors that power naval vessels.

Ask students: Do you know if our State is part of a low-level waste compact?

Teachers' Notes:

Barnwell accepts waste only from the Atlantic Compact States. Richland accepts waste only from the Northwest Compact and Rocky Mountain Compact States. Clive accepts waste from all regions of the United States. Andrews accepts waste from the Texas Compact and from the federal government.

★ Operating Low-level waste disposal sites

What is a low-level waste compact?

By law, each State is responsible for disposal of low-level waste from industries, hospitals, utilities and research institutions within its borders.

Instead of every State building its own site, most States have joined **low-level waste compacts**. They have legal agreements to share the cost of disposing of their low-level waste at one site in the compact.

Where are low-level waste disposal sites?

Four States have licensed disposal sites. They have agreements with compacts or States not in a compact to accept and dispose of low-level wastes. Private companies operate the sites and charge a fee for waste disposal. The sites are located at

- Barnwell, South Carolina
- Richland, Washington
- Clive, Utah
- Andrews, Texas

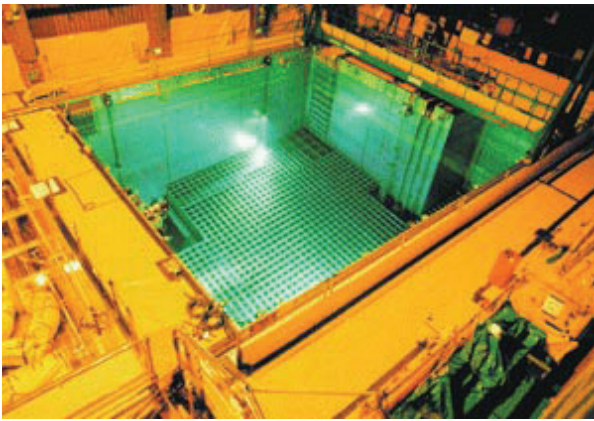

A spent fuel pool allows spent fuel to cool and also shields workers from radiation.

What is high-level waste?

High-level waste is the highly radioactive by-product produced inside a nuclear reactor. It can be either

- **Spent fuel** (used fuel), or
- Waste materials remaining after spent fuel is recycled

Every two years, about one third of the fuel assemblies in the reactor are replaced with new ones. Fuel that is removed from the reactor is called spent fuel. Spent fuel can be considered high-level radioactive waste.



These dry storage casks hold spent nuclear fuel assemblies that have cooled for at least one year.

If spent fuel is recycled, then the waste that is left over is also considered high-level waste.

How is spent fuel stored?

Spent fuel produces a lot of heat during the first year as radioactivity decays. The utility stores it near the reactor in a pool of water called the **spent fuel pool**. The pool is typically 12 meters (40 feet) deep. Here, the water cools the spent fuel and also shields the radiation. During storage, spent fuel becomes less radioactive through radioactive decay. After one year, 99 percent of the radioactivity decays away. But it still remains radioactive for thousands of years.

Some utilities use **dry cask storage** for spent fuel that has already been cooled in the spent fuel pool. The casks are typically steel cylinders that are either welded or bolted closed. The steel cylinder provides a leak-tight containment for spent fuel. More steel, concrete, or other material surrounds each cylinder to provide radiation shielding.

How will we transport the waste?

Eventually, utilities will ship spent fuel assemblies to a central storage site or a permanent repository. The utility will ship spent fuel in special spent fuel shipping casks.

Teachers' Notes:

In 2015 spent fuel was stored at 75 sites in 33 states.

If you play a musical instrument in band, you probably take it to school in a case to keep it safe. The purpose of spent fuel shipping cask is similar to the purpose of an instrument case. Both are specially made to protect their contents. A spent fuel shipping cask must also protect people and the environment from the radiation given off by the fuel it holds. Engineers design spent fuel shipping casks with heavy shielding and thick walls that prevent radiation in the spent fuel assemblies from getting into the environment.



Teachers' Notes:

If the United States decides to reprocess spent nuclear fuel, some of what is now waste will become fuel.



Transportation specialists carefully plan and manage fuel shipments for safety and security.

A spent fuel shipping cask must be strong enough to withstand even the worst transportation accidents. To be sure they work as they are supposed to, scientists and engineers have performed crash tests with these casks. They used high-speed cameras to study what would happen to the casks in a very serious accident. The tests included slamming a truck and cask into a concrete barrier at over 113

kilometers (70 miles) an hour, burning casks in jet fuel, sinking them underwater, dropping them from a crane onto a steel spike, and crashing a high speed train into a cask on a trailer. In all of the tests, the casks protected their contents, even though the trucks and trains were destroyed.

What is reprocessing?

Some parts of the spent fuel can be recycled and used again as reactor fuel. This is called **reprocessing**. Spent fuel is taken out of a reactor when there is not enough uranium-235 to power a chain reaction.

However, it is still 95.6 percent unused uranium, including 1 percent uranium-235. It also contains **plutonium** produced by the reaction. Both uranium-235 and plutonium can be recycled to make new reactor fuel.

At present, the United States has decided not to do nuclear fuel recycling. One reason is that a by-product of reprocessing is plutonium, and safeguards must be taken because the plutonium could be used to make weapons. Another reason is that reprocessing is expensive.

If we do not reprocess spent fuel, then it will be treated as high-level waste. If we do reprocess spent fuel, there will still be some high-level waste that requires disposal.

How can we isolate high-level waste for thousands of years?

Nuclear technicians can seal high-level waste in heavy metal canisters and then store them deep underground in a **geologic repository** drilled into a dry, stable rock formation. In 1982, U.S. Congress passed the Nuclear Waste Policy Act. This law called for a deep geologic repository to safely store or dispose of high-level radioactive waste. This geologic repository would be as much as 1 kilometer (.6 mile) underground with tunnels for storing waste. The Act required nuclear power plants to pay a fee for the cost of the waste repository.

In the years since it passed, there have been a number of changes to the Act. Yucca Mountain, in Nevada, was chosen by Congress as a site for a repository. In 2010, work at that site was stopped. Today,

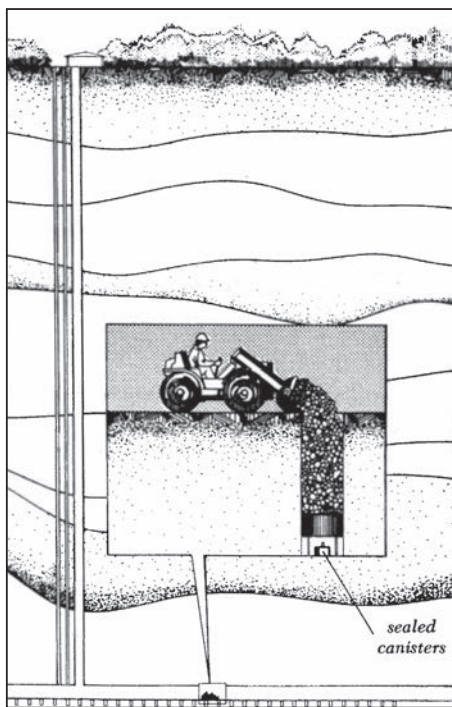

This drawing shows how spent fuel and high-level waste could be isolated 1,000 to 3,000 feet beneath the surface of the Earth in a geologic repository.

utilities store spent fuel at power plants as other solutions are being evaluated.

What happens to a nuclear power plant when it closes?

A license to operate a nuclear power plant lasts for 40 years. After that, the utility company can ask to renew its license for 20 years longer, or it can shut down the plant and **decommission** it.

During the years nuclear power plants produce electricity, many parts become radioactive. When the plant closes, the radioactivity begins to decrease through the process of radioactive decay. With each passing year, materials at the reactor become less radioactive. This means it becomes easier to **dismantle** after 10 or more years because the level of radioactivity is lower.

What is the nuclear fuel cycle?

All of the steps involved in using uranium to make electricity are known as the **nuclear fuel cycle**. The fuel cycle begins with mining uranium ore and ends with nuclear waste disposal. The fuel cycle includes all the steps to refine the uranium, enrich the concentration of uranium-235, manufacture fuel, use it in a reactor, store the spent fuel, and recycle or dispose of the waste. People who have jobs in nuclear energy carefully manage each step in the fuel cycle to protect the public and the environment.

Teachers' Notes:

A Blue Ribbon Commission was named to study options for nuclear waste management. They concluded in 2012 that permanent disposal is needed and that geologic disposal is the best option. They suggested finding a suitable site where the community wants to host a disposal facility.

More information on the strategy for managing and disposing of used nuclear fuel and high-level radioactive waste, issued in January 2013, can be found at www.energy.gov/downloads/strategy-management-and-disposal-used-nuclear-fuel-and-high-level-radioactive-waste

Teachers' Notes:

Scientists want to be sure that high-level waste is stored where water cannot reach it. Some people have wondered whether future changes in weather might cause dry desert areas to have more rainfall. How would your students resolve this question? Why do they think a dry location is important? (water table, water infiltration, migration)



Summary

Like all industries, nuclear power plants produce wastes. Some of the wastes are radioactive and require special methods of disposal. The way we dispose of radioactive waste depends on

- How radioactive the waste is
- The half-life of the waste
- The physical and chemical form of the waste

Waste that has been contaminated with radioactive material at hospitals, research labs, industry, and power plants is called low-level waste. Most of the radioactive waste from a nuclear power plant is low-level. Usually it is sealed in steel drums and buried at licensed low-level waste disposal sites.

Nuclear fuel is removed from the reactor when it can no longer support fission efficiently. This spent fuel from power plants can be considered high-level waste. Spent fuel is stored in water in spent fuel pools near the reactor where it cools and undergoes radioactive decay. After a year or two in the spent fuel pool, spent fuel can be removed from the pool and stored in dry casks.

The United States has not made a final decision about how to permanently dispose of high-level waste. The usable parts of spent fuel can be recycled through a process called reprocessing, but the United States is not currently reprocessing spent fuel. High-level waste requires permanent isolation because it remains radioactive for thousands of years. Spent fuel and high-level waste left after reprocessing need to be isolated deep beneath the Earth's surface in a geologic repository.

LESSON PLAN

Lesson 7: Lesson Plan

Waste from Nuclear Power Plants

Overview

This lesson takes a look at the by-products of electricity production at nuclear power plants and the nuclear fuel cycle. It considers the different types of waste generated, as well as how each type of waste is dealt with.

Concepts

All the steps required for producing electricity by using nuclear energy produce waste or by-products. These steps are called the nuclear fuel cycle and include

- Mining
- Milling
- Uranium enrichment
- Fuel fabrication
- Electricity production
- Spent fuel storage and high-level waste management
- Permanent disposal in a geologic repository
- Potential future reprocessing

Radioactive waste from a nuclear power plant includes

- Low-level waste
- High-level waste (spent fuel)
- Residue left after reprocessing if reprocessing is used in the future.

The level of radioactivity, the half-life, and the physical and chemical form of waste determine the manner of disposal.

National Standards (Grades 5 – 8)

Science

NS.5-8.5 As a result of activities in Grades 5-8, all students should develop

- Abilities of technological design
- Understanding of science and technology

NS.5-8.6 As a result of activities in Grades 5-8, all students should develop understanding of

- Natural hazards
- Risks and benefits
- Science and technology in society

Social Studies

NSS-G.K-12.1 As a result of activities in Grades K-12, all students should

- Understand how to use maps and other geographic representations, tools, and technologies to acquire, process, and report information from a spatial perspective
- Understand how to use mental maps to organize information about people, places, and environments in a spatial context
- Understand how to analyze the spatial organization of people, places, and environments on Earth's surface

NSS-G.K-12.2 As a result of activities in Grades K-12, all students should

- Understand the physical and human characteristics of places
- Understand that people create regions to interpret Earth's complexity

NSS-G.K-12.3 As a result of activities in Grades K-12, all students should

- Understand the characteristics and spatial distribution of ecosystems on Earth's surface

NSS-G.K-12.5 As a result of activities in Grades K-12, all students should

- Understand how human actions modify the physical environment
- Understand how physical systems affect human systems
- Understand the changes that occur in the meaning, use, distribution, and importance of resources

Technology

NT.K-12.1 Basic Operations and Concepts

- Students demonstrate a sound understanding of the nature and operation of technology systems
- Students are proficient in the use of technology

NT.K-12.2 Social, Ethical, and Human Issues

- Students understand the ethical, cultural, and societal issues related to technology
- Students practice responsible use of technology systems, information, and software
- Students develop positive attitudes toward technology uses that support lifelong learning, collaboration, personal pursuits, and productivity

NT.K-12.3 Technology Productivity Tools

- Students use technology tools to enhance learning, increase productivity, and promote creativity
- Students use productivity tools to collaborate in constructing technology-enhanced models, prepare publications, and produce other creative works

NT.K-12.5 Technology Research Tools

- Students use technology to locate, evaluate, and collect information from a variety of sources
- Students use technology tools to process data and report results
- Students evaluate and select new information resources and technological innovations based on the appropriateness for specific tasks

NT.K-12.6 Technology Problem-Solving and Decision-Making Tools

- Students use technology resources for solving problems and making informed decisions
- Students use technology tools to process data and report results
- Students employ technology in the development of strategies for solving problems in the real world

Objectives

Upon completing this lesson, students will be able to

- Describe low-level and high-level radioactive wastes
- Explain why we need to isolate low-level and high-level wastes from the environment
- Explain why half-life is an important consideration in planning for safe disposal of wastes from nuclear power plants
- Explain how we dispose of low-level radioactive waste in the United States
- Explain two ways utilities store spent fuel at nuclear power plants
- Explain the concept of a geologic repository
- Discuss the pros and cons of dismantling a nuclear power plant immediately upon shutdown versus waiting several years before dismantling
- Discuss safety measures used in transporting nuclear materials, including waste

Key Terms / Vocabulary

by-product – something produced in an industrial process in addition to the main, wanted product; sometimes an unexpected or unintended result

compact – a legal agreement between two or more States

decommission – the process of closing a nuclear power plant after it has outlived its usefulness

dismantle – to take apart; to break into pieces

dry cask storage – a method for storing spent fuel at a nuclear power plant in steel cylinders that are surrounded by more steel, concrete, or other material to provide radiation shielding

geologic repository – a facility for disposal of high-level nuclear waste and spent fuel located deep beneath the surface of the Earth in a stable geologic environment

high-level radioactive waste – nuclear power plant waste that is very radioactive; examples include spent fuel or the waste left after reprocessing (see *reprocessing*) spent fuel to recover usable materials

low-level radioactive waste – items that have been contaminated with radioactive material; examples include used protective clothing, broken tools, gloves, cleaning rags, and filters

low-level waste compact – a legal agreement by States for the disposal of low-level radioactive wastes generated within the borders of member States

nuclear fuel cycle – all the steps, from mining to disposal, involved in using nuclear energy to generate electricity

plutonium – a naturally radioactive, silvery metal whose atoms can be split when bombarded with neutrons; found in small quantities in uranium ores but is usually man made in nuclear reactors; used as reactor fuel; symbol is Pu

reprocessing – extraction of uranium and plutonium from spent fuel rods for reuse as fuel

spent fuel – uranium fuel that has been used and then removed from the reactor; a form of high-level radioactive waste

spent fuel pool – a deep pool of water in a building near the reactor where spent fuel from a nuclear power plant is stored while it cools and undergoes radioactive decay

wastes – unwanted by-products

Lesson Seven – Chapter Outline

Opening the lesson:

1. Students may not see waste management and waste disposal as relevant to their own lives. To engage their interest and make the topic relevant on a personal level, leave classroom litter and trash around the classroom for the beginning of the lesson. Invite students to take their seats without making any effort at cleanup other than gently pushing aside anything that is an obstacle. After students are seated with the trash around them for a few minutes, ask if they feel the condition of the classroom is a problem. If there is agreement that a problem exists, ask students what they think should be done and who is responsible for doing it.
2. After this brief beginning, ask students to identify types of trash specifically related to energy. One way of encouraging them to think about energy-related wastes and their own contribution to the production of these wastes is to turn the classroom light switch off and then on again. Then ask students to list the wastes that have probably been the by-products of producing the electricity that turned on the lights in their classroom. Have students consider who is responsible for the clean-up and permanent disposal of any nuclear waste that has been produced.

What is waste?

- Waste in general

What is nuclear waste?

- Wastes from nuclear power plants that are radioactive
- Disposal requires special care to protect people and the environment
- Disposal methods take into account how radioactive the waste is, half-lives, and the physical and chemical form of the waste

How do we decide the way to dispose of the waste?

- Disposal method depends on level of radioactivity, half-life, physical and chemical form of the waste

What is low-level waste?

- Items that have become contaminated with radioactive material
- Examples – filters, cleaning rags, broken tools, used protective clothing, needles, tubing, etc.

How do we dispose of low-level waste?

- Sealed drums or casks
- Capped trenches
- Monitoring

What is a low-level waste compact?

- Legal agreement of States to share costs of disposal at one site
- Map showing compacts
- If a State is not a member of a compact, it has to have a low-level waste disposal site inside its borders or make an agreement with one of the operating disposal sites to accept its low-level waste

Where are the low-level waste disposal sites?

- Locations of disposal facilities in four States
- Private companies operate disposal sites and charge fees

What is high-level waste?

- Spent fuel and waste left over after reprocessing
- Very radioactive

How is spent fuel stored?

- Decays while in storage
- Spent fuel pool
- Dry cask storage

How will we transport the waste?

- Special spent fuel shipping casks
- Casks designed to protect cask contents
- Cask also designed to protect the environment

What is reprocessing?

- Recycling to recover useful fuel
- Recovers uranium and also plutonium
- U.S. not reprocessing
- Reasons to not reprocess (concerns about plutonium, costs)

How can we isolate high-level waste for thousands of years?

- Concept of geologic repository
- Status of U.S. plans for repository

What happens to a nuclear power plant when it closes?

- Decommissioning
- Dismantling

Reading

Reading for this lesson in the student reader can be assigned as homework prior to this class session, or it can be read in class as guided reading. A Reading Review Exercise follows so that you can reproduce or project it for your class.

Performance Assessment and Extensions

A Reading Review Exercise follows that you can reproduce or project for your class. The labs and activities that follow include inquiry-based questions that can be used to assess student learning. Accompanying this lesson is a PowerPoint lecture with a review that can be used as an interactive assessment. For a project-based assessment, have students create a blog, podcast, or video on a topic from this lesson.

Lesson 7 Reading Review Exercise

A. From the reading, write the word that best fits the definition given.

_____ Nuclear power plant waste that includes shoe covers, mops, filters, rags, and used gloves

_____ Nuclear power plant waste that includes spent fuel

_____ Facility where spent fuel is stored when it is first removed from the reactor

_____ Spent fuel becomes less radioactive over time because of this natural process

_____ Type of facility where spent fuel or high-level waste can be isolated from the environment for thousands of years

B. Circle the letter of the best answer for each item.

1. The problem with nuclear power plant waste is

- a. there is a huge amount of waste
- b. some of the waste is radioactive
- c. the waste can easily catch on fire
- d. all of the above

2. Most radioactive waste from a nuclear power plant is

- a. low-level
- b. high-level
- c. ceramic
- d. spent fuel

3. Low-level waste is usually

- a. burned at high temperatures
- b. dumped in city landfills
- c. sealed in steel drums and buried at special sites
- d. disposed of in the ocean

4. After it has cooled under water for a year or two, spent fuel can be moved for storage to
 - a. a low-level waste disposal site
 - b. specially designed dry casks at the power plant site
 - c. storage sites maintained by compacts
 - d. ocean disposal sites

5. Disposal of low-level waste is the responsibility of the
 - a. city where the power plant is located
 - b. county where the power plant is located
 - c. State where the power plant is located
 - d. President of the United States

C. Indicate whether the following statements are true (T) or false (F) by circling the correct letter. If the statement is false, correct it to make it true.

1. A spent fuel cask protects its contents and also protects people and the environment from radiation. T F

2. After shutdown, the longer you wait to dismantle a nuclear power plant, the more radioactive it becomes because of radioactive decay. T F

3. In most States, low-level radioactive waste comes only from nuclear power plants. T F

4. High-level waste must be isolated from the environment for thousands of years because of the very short half-lives of elements in the waste. T F

5. If spent fuel is reprocessed, there will still be a need for very long term isolation of high-level waste because all of the fuel cannot be reused and there will still be leftover high-level waste. T F

6. The cost for the permanent disposal of spent fuel is being paid by a fee that each nuclear power plant pays as it generates electricity. T F

Advanced Student Exercise

D. Write a sentence or two about each of the topics below.

1. Explain why radioactive waste becomes less hazardous over time. Include the name of the process that occurs in your explanation.

2. Why would a State that does not have a nuclear power plant within its borders still need to provide for the disposal of low-level waste?

3. Explain why a utility that owns a nuclear power plant that is shut down because it has outlived its usefulness might wait for a number of years before dismantling it. Include the name of the process that occurs that would influence this decision.

4. Explain why it is important for you as a citizen to understand how nuclear waste is managed and disposed of.

5. Is it fair to have a law that requires every State to have a way to dispose of its low-level radioactive waste? Defend your answer in a full paragraph.

Lesson 7 Reading Review Exercise - Answers

A. From the reading, select the word that best fits the definition given.

low-level waste Nuclear power plant waste that includes shoe covers, mops, filters, rags, and used gloves

high-level waste Nuclear power plant waste that includes spent fuel

spent fuel pool Facility where spent fuel is stored when it is first removed from the reactor

radioactive decay Spent fuel becomes less radioactive over time because of this natural process

geologic repository Type of facility where spent fuel or high-level waste can be isolated from the environment for thousands of years

B. Circle the letter of the best answer for each item.

1. The problem with nuclear power plant waste is

- a. there is a huge amount of waste
- b. some of the waste is radioactive
- c. the waste can easily catch on fire
- d. all of the above

2. Most radioactive waste from a nuclear power plant is

- a. low-level
- b. high-level
- c. ceramic
- d. spent fuel

3. Low-level waste is usually

- a. burned at high temperatures
- b. dumped in city landfills
- c. sealed in steel drums and buried at special sites
- d. disposed of in the ocean

4. After it has cooled under water for a year or two, spent fuel can be moved for storage to
 - a. a low-level waste disposal site
 - b. specially designed dry casks at the power plant site
 - c. storage sites maintained by compacts
 - d. ocean disposal sites

5. Disposal of low-level waste is the responsibility of the
 - a. city where the power plant is located
 - b. county where the power plant is located
 - c. State where the power plant is located
 - d. President of the United States

C. Indicate whether the following statements are true (T) or false (F) by circling the correct letter. If the statement is false, correct it to make it true.

1. A spent fuel cask protects its contents and also protects people and the environment from radiation. T F

2. After shutdown, the longer you wait to dismantle a nuclear power plant, the more radioactive it becomes because of radioactive decay. T F
It becomes less radioactive. T F

3. In most States, low-level radioactive waste comes only from nuclear power plants. *Industries, hospitals, research institutions, and nuclear power plants all produce low-level waste.* T F

4. High-level waste must be isolated from the environment for thousands of years because of the very short half-lives of elements in the waste. *It is isolated because of very long half-lives.* T F

5. If spent fuel is reprocessed, there will still be a need for very long term isolation of high-level waste because all of the fuel cannot be reused and there will still be leftover high-level waste. T F

6. The cost for the permanent disposal of spent fuel is being paid by a fee that each nuclear power plant pays as it generates electricity. T F

D. Write a sentence or two about each of the topics below.

1. Explain why radioactive waste becomes less hazardous over time. Include the name of the process that occurs in your explanation.

Radioactive waste becomes less hazardous over time because the atoms in the waste undergo radioactive decay. Eventually, the atoms become stable and no longer emit radiation.

2. Why would a State that does not have a nuclear power plant within its borders still need to provide for the disposal of low-level waste?

A State that does not have a nuclear power plant within its borders would still need to dispose of low-level waste from medical procedures. It would also still need to provide disposal for the low-level waste from industry or research. If it did not provide for disposal of low-level waste, many medical procedures that use radioactive materials could not be performed in the State. Industries and research could not use radioactive substances.

3. Explain why a utility that owns a nuclear power plant that is shut down because it has outlived its usefulness might wait for a number of years before dismantling it. Include the name of the process that occurs that would influence this decision.

As years go by, the parts of the power plant that are radioactive become less radioactive because of the radioactive decay process. This means there is less hazard to workers if the utility waits to dismantle the plant in a process called decommissioning.

4. Explain why it is important for you as a citizen to understand how nuclear waste is managed and disposed of.

In the United States, citizens have input in making decisions about things like the management and disposal of nuclear waste. They can also tell elected officials their opinions. They need to understand the science behind nuclear waste and how nuclear waste is managed so they can make informed decisions.

5. Is it fair to have a law that requires every State to have a way to dispose of its low-level radioactive waste? Defend your answer in a full paragraph.

Answers will vary.

Activities, Labs, and Supplemental Information

Teacher's PowerPoint Presentation

A Teacher's (PowerPoint) presentation is provided on CD and online on the DOE Office of Nuclear Energy website to help you present chapter concepts to your class. Download the teacher presentation at: <http://energy.gov/ne/services/harnessed-atom>

Activity - The Nuclear Fuel Cycle

You can reproduce or project this activity that follows.

Students demonstrate their knowledge of the steps involved in generating electricity using nuclear energy by putting pictures of the steps in order. The activity can be done by students individually, in groups, or by the whole class.

Lab - The Nuclear Waste Cube

Students can get a visual idea of the volume of high-level waste from nuclear power plants by making a paper cube. In the United States one person's share of high-level radioactive waste from nuclear power plants for a 20-year period could be placed inside the cube. (Note: This is the amount of waste that would be leftover after all usable materials had been recycled.) After students see "their" share, the activity can be extended by having them make enough cubes to represent the share of their family. Or the class can combine all the cubes they made to see the share for the whole class.

Discussion Questions and Sample Answers

1. Would a small leak of radioactive waste from a nuclear repository be detected?
Yes, radiation can be detected with devices like Geiger counters and similar instruments.
2. How would immediate detection of even a very small leak of radioactive waste differ from leak detection of other types of industrial toxic wastes?
Because radioactivity can be easily detected with Geiger counters, it would be easier to detect than most other hazardous or toxic wastes. Leaks of hazardous or toxic wastes other than radioactive wastes are often detected by smell, color, or sensitive chemical analytical methods that take longer to perform. Some have to be detected by analysis at laboratories, which takes quite a lot longer.
3. Why are there special sites for disposal of low-level waste?
Low-level waste is radioactive and must be isolated from the environment.
4. Why have some States formed compacts to support a single nuclear waste disposal site that serves several States?
The Low-Level Radioactive Waste Policy Amendments Act of 1985 gives States the responsibility to dispose of low-level radioactive waste generated within their borders and allows them to form compacts to locate facilities to serve a group of States. The Act allows States within a compact to share the costs of disposal, including building disposal sites.

5. How would it affect health care in your State if there were no low-level waste disposal sites available?

If no low-level waste site were available, radioactive materials could not be used in the State. This would affect diagnosis of some illnesses, and it would affect the treatment of other illnesses, including some cancers.

6. Why is there a controversy about disposal of high-level nuclear waste?

Because high-level waste will remain radioactive for thousands of years, many people don't want a disposal site located near them. They are concerned that some of the radioactive material might get into the environment. Some people are worried that there could be a transportation accident during shipments. On the other side, people understand that waste must be disposed of safely. Some communities are interested in managing a disposal site because it could bring jobs and scientific skills to their areas.

Supplemental Information

Classes of Commercial Low-Level Radioactive Waste

Class A low-level waste contains radionuclides with the lowest concentrations and the shortest half-lives. About 95 percent of all low-level waste is categorized as Class A. The radioactivity in this class of low-level waste fades to background levels within 100 years.

Classes B and C contain greater concentrations of radionuclides with longer half-lives, fading to background levels in less than 500 years. They must meet stricter disposal requirements than Class A waste.

Low-level waste that exceeds the requirements for Class C waste—known as “Greater Than Class C” waste—is, under federal law, the responsibility of the U.S. Department of Energy. This material accounts for less than 1 percent of all low-level waste.

Under federal law, every State is ultimately responsible for providing disposal for the waste generated within its borders—by either in-State disposal, joining with other States to form a compact, or contracting with a State or compact that has a disposal facility.

Decommissioning

The Nuclear Regulatory Commission (NRC) has very strict rules for shutting down a plant. NRC requires plants to finish the process within 60 years of closing. Because it may cost \$300 million or more to shut down and decommission a plant, the NRC requires plant owners to set aside money when the plant is still operating to pay for the future shutdown costs.

Nuclear power plants can be decommissioned using three methods:

1. **Dismantling** - Parts of the reactor are removed or decontaminated soon after the plant closes and the land can be used.
2. **Safe Storage** - The nuclear plant is monitored and radiation is allowed to decay; afterward, it is taken down.
3. **Entombment** - Radioactive components are sealed off with concrete and steel, allowing radiation to “decay” until the land can be used for other purposes.

Information about how U.S. commercial nuclear plants store spent nuclear fuel is available at www.nrc.gov/waste/spent-fuel-storage/faqs.html

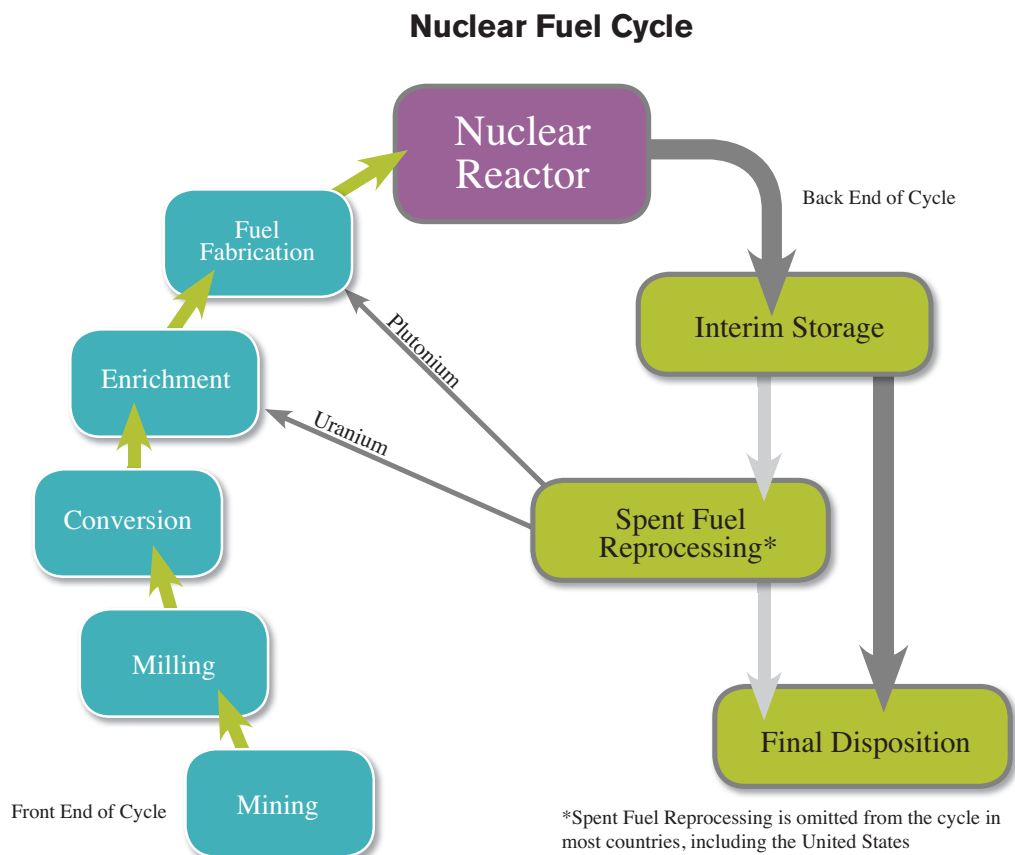

Useful websites for further information

U.S. Department of Energy's Office of Nuclear Energy
www.energy.gov/ne

Nuclear Energy Institute
www.nei.org

American Nuclear Society
www.new.ans.org

Nuclear Regulatory Commission
www.nrc.gov/waste.html

U.S. Department of Energy's Energy Information Administration
www.eia.gov

Strategy for the Management and Disposal of Used Nuclear Fuel and High-level Radioactive Waste
energy.gov/downloads/strategy-management-and-disposal-used-nuclear-fuel-and-high-level-radioactive-waste

Nuclear Fuel Cycle Wastes (from Commercial Nuclear Electric Power)

Activity	Type of Waste	Form of Waste	Disposal	Comments
Mining	Spoils	Leftover rock	Left at the mine	Mostly western States
Milling	Mill tailings	Solid	Dried and capped with soils	Mills are close to mines. Tailings also release radon gas from radium that is found with uranium.
Enrichment	Depleted uranium hexafluoride (UF ₆)	UF ₆ solid	Very dense metal is used in armor-piercing shells or stored for possible future use in breeder reactors	There are about 700,000 metric tons of depleted UF ₆ stored in the U.S. in 57,000 steel containers.*
Conversion	UF ₆ to uranium dioxide	Oxide	Most recycled	Some low-level radioactive scrap and dust, filters, protective clothing are compacted and sent to waste sites.
Fabrication	Metals	Metal	Most recycled	Similar to other high-value metal fabrication industries
Electricity generation	Spent fuel	Solid	Can be recycled or buried in a deep geologic repository	Currently (2016), most used fuel is stored in spent fuel pools or in dry casks at power plant sites.
Reprocessing (fuel recycling)	High-level wastes	Liquids are dried and mixed with glass	Unused uranium and plutonium can be extracted from fuel to be used again to generate electricity. Leftover waste requires permanent disposal in a geologic repository	The U.S. is not recycling fuel at this time (2016). If reprocessing is used in the future, there will still be some high-level waste that needs to be isolated from environment for thousands of years.
Disposal	Spent fuel and high-level waste	Solids	Geologic repository	Final political decision on location not made (2016)

* Source: DOE Argonne National Laboratory at web.ead.anl.gov/uranium/faq/storage/faq16.cfm

Activity – The Nuclear Fuel Cycle

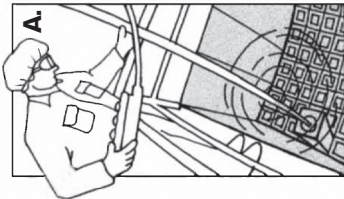

Spent fuel is stored in a spent fuel pool.

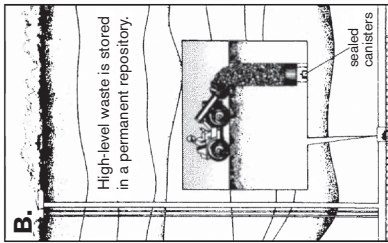

High-level waste is stored in a permanent repository.

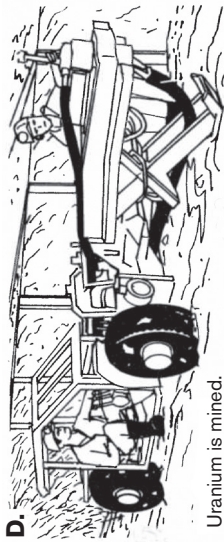

Uranium is mined.

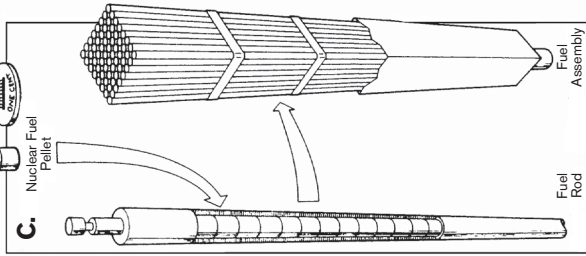

Uranium fuel pellets are placed in rods, which are placed into fuel assemblies.

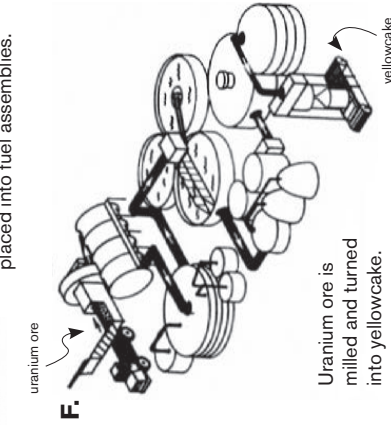

Uranium ore is milled and turned into yellowcake.

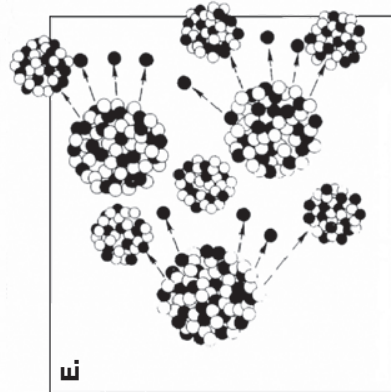

Uranium fissions to produce heat energy.

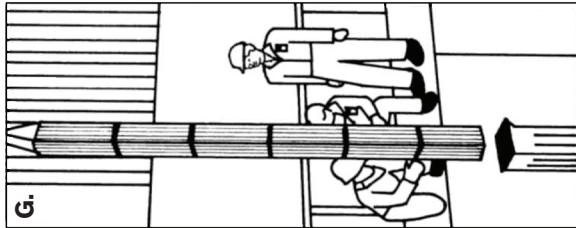

Fuel assemblies are lowered into the reactor core.

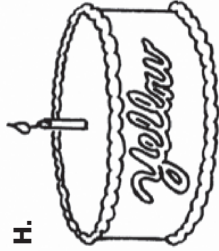

Yellowcake is converted to uranium hexafluoride.

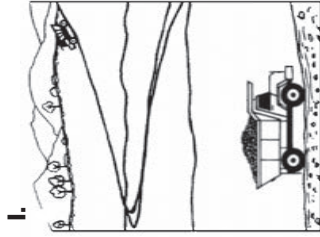

Uranium ore is taken to the mill.

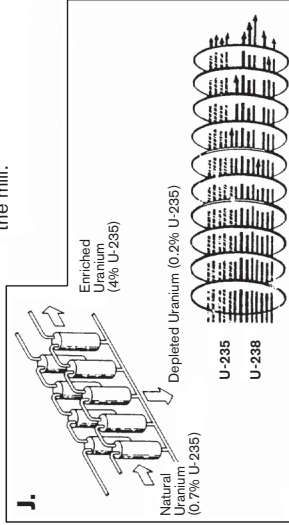

Prospecting for uranium deposits

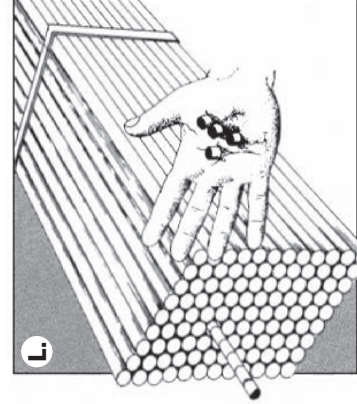

Uranium is formed into ceramic fuel pellets about the size of a fingertip.

Directions: Arrange the pictures in the correct order by placing their letters in the blanks provided.

1. _____ 3. _____ 7. _____ 11. _____
2. _____ 4. _____ 8. _____ 12. _____

Activity – The Nuclear Fuel Cycle - Answers

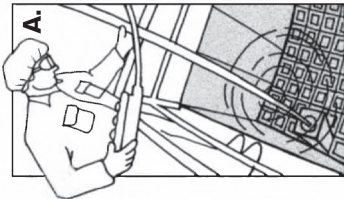

Spent fuel is stored in a spent fuel pool.

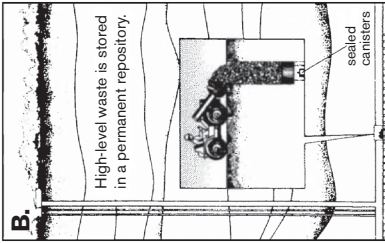

High-level waste is stored in a permanent repository.

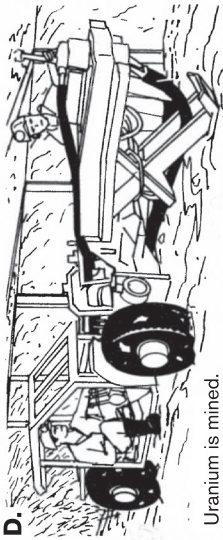

Uranium is mined.

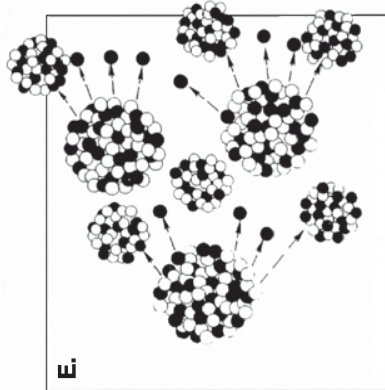

Uranium fissions to produce heat energy.

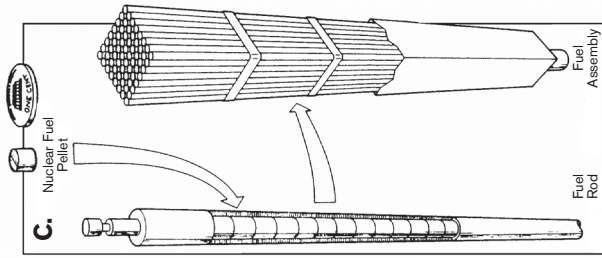

Uranium fuel pellets are placed in rods, which are placed into fuel assemblies.

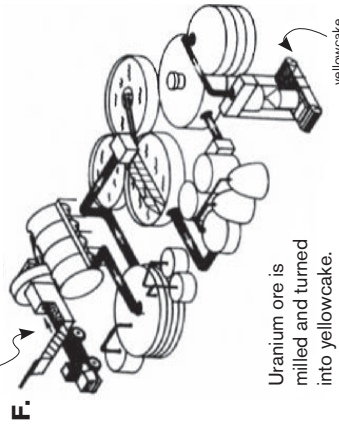

Uranium ore is milled and turned into yellowcake.

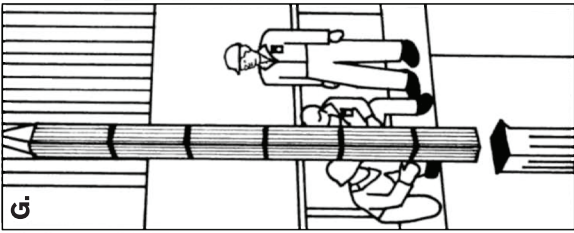

Fuel assemblies are lowered into the reactor core.



Prospecting for uranium deposits

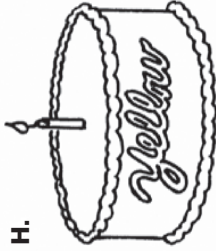

Yellowcake is converted to uranium hexafluoride.

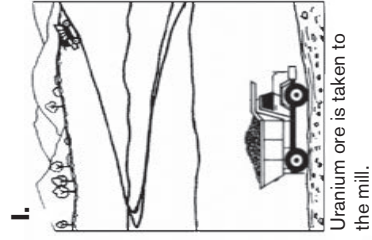
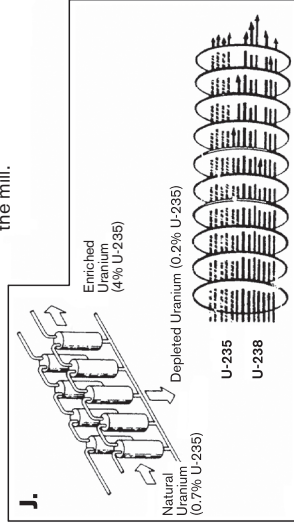

Uranium ore is taken to the mill.

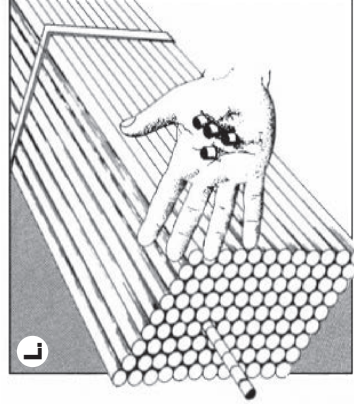

Uranium is formed into ceramic fuel pellets about the size of a fingertip.

Directions: Arrange the pictures in the correct order by placing their letters in the blanks provided.

1. K 3. I 5. H 7. L 9. G 11. A
2. D 4. F 6. J 8. C 10. E 12. B

Lab – Nuclear Waste Cube

Materials

- Scissors
- Glue or tape

Procedure

Using the diagram as a guide, cut out and fold the pattern to make a cube.

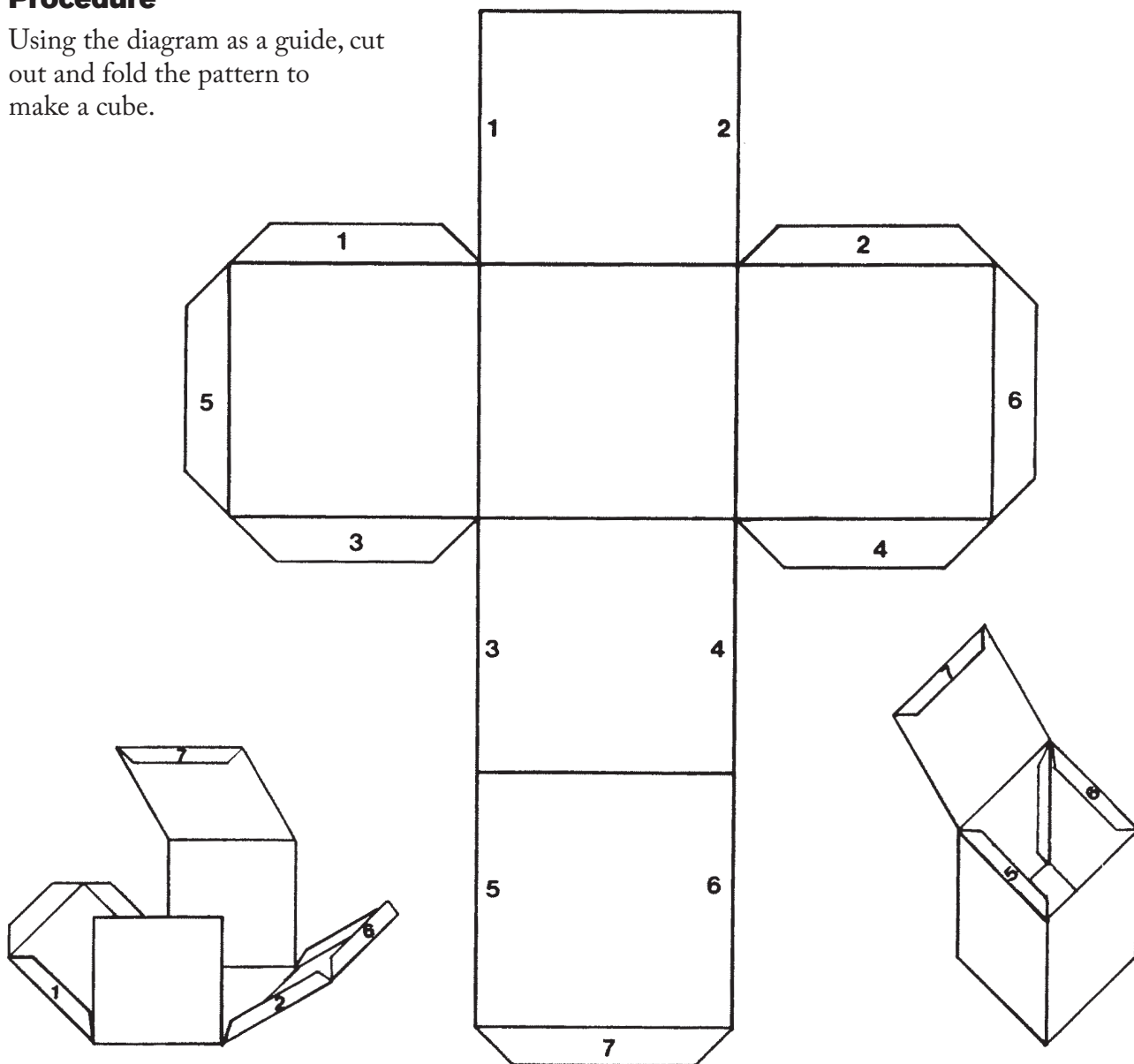

In the United States, one person's share of high-level radioactive waste from nuclear power plants for a 20-year period could be placed inside the cube. This is the amount of waste that would be left over after all usable materials had been recycled.

CONCERNS



Introduction

Nuclear energy is one of our three largest sources of electricity. It is important for us to make sure nuclear power plants are safe and reliable. In decisions to build and operate a nuclear power plant, safety and security are essential concerns. Learning from past accidents, understanding this energy source, and protecting against risk are important in our energy mix.

TOPICS:

Safety at nuclear power plants

Design features
Engineering safety
Barriers and backups
Regulations

Security

Accidents
Three Mile Island
Chernobyl
Fukushima

Learning from accidents

Informed decisions
Risk and benefits
Utility costs
Tradeoffs

What concerns do people have about nuclear power plant safety?

Safety must be the primary concern when we plan, build, and operate a nuclear power plant. The main questions people have about nuclear power plant safety center around radiation because the fuel in a reactor becomes very radioactive. Nuclear power plants release very little radiation as they make electricity. However, if an accident released a large amount of radiation, it would be serious.

Safety includes protecting people who work at the nuclear power plant as well as the people living nearby. It also includes protecting the environment and the power plant itself from damage. Safety is every employee's responsibility. Working at a nuclear power plant is one of the safest

jobs in industry. Each year, the injury rate is lower in the nuclear power industry than other jobs, even office work like finance and real estate.

Preventing accidents is the focus when people design, build, and operate nuclear power plants. As a result, nuclear power



Nuclear power plants have safety systems that are inspected by workers and regulators.

plants in the United States have been very reliable and have a record for operating safely. However, the record is not perfect. There have been accidents at nuclear power plants in the past.

Each way that we have of producing electricity has its own safety concerns. For this reason, each type of power plant—coal, nuclear, hydro, gas, solar, wind—has special **design features** to protect people and the environment. The safety requirements for nuclear power plants are the strictest.

What keeps U.S. nuclear plants safe?

Nuclear engineers focus on safety when they design reactor systems. Scientists, **engineers, architects,** and **regulators** all work together as they plan plants. They use the natural properties of the fuel and fission for a safe design. Then they add **engineered safety systems** that protect against failure. Around this, they build strong **barriers** to keep radioactive material inside the plant. To make sure that the plant is run properly, operators take years of special training and tests.



Regulators inspect the way nuclear power plants are operated and maintained.

The Nuclear Regulatory Commission – the **NRC** – must grant a license to the power plant before it can operate. Then NRC experts conduct regular inspections to make sure the plant runs safely and that the utility performs proper maintenance. Each nuclear power plant has an NRC inspector assigned to work at the power plant as his or her full time job.

Design safety. The physics of a nuclear power plant design help keep it safe. The characteristics of the fuel, the coolant, and the chain reaction itself **safeguard** against accidents. Fuel in a reactor is concentrated just enough to keep the reaction going. It is too diluted to explode like a bomb.

As fuel gets hotter, the chain reaction slows down. This property naturally helps limit the rate of fission.

Teachers' Notes:

Ask students how this is similar to the way we help make cars safer. Carmakers use laws of physics to design cars so they are stable to drive. They design the brakes with two separate brake lines to stop the car even if one fails. Then they add a separate parking brake that will stop the car in an emergency. They surround passengers with strong materials like steel. If the driver does get in an accident, seatbelts and air bags help prevent injuries. Drivers must study the rules and take tests on their knowledge and driving skill. Police watch to make sure that drivers follow the laws for safety.

Teachers' Notes:

You may want to help your students learn to read and understand the style for technical documents: Ask students why we often talk about government agencies like the NRC using letters. In a technical report or news story, the long agency name is written out the first time it appears, followed by an abbreviation (an acronym) for the name. After the first use, the author uses only the abbreviation.

The water used as a coolant is also necessary for a chain reaction. If cooling water is lost from around the fuel, the chain reaction will stop and the heat from the fuel will drop to 1.5 percent within an hour. Although the remaining heat would damage the reactor, the fission reaction would not keep going.

Teachers' Notes:

Discuss what a regulator does. For nuclear power plants, a regulator makes sure the plants are safe and follow the laws and regulations. Ask students to think of examples of other regulators. Government regulators they may know about include the EPA, FDA, or FAA. They may also know of non-government regulators like the NCAA, the International Olympic Committee, FIFA, or the association in your State that regulates school sports.

Engineered safety. Every safety-related system in a nuclear plant has **backup** systems. For example, designers include backup pumps to circulate water in the reactor if the main pumps should ever quit working. There are also more backup pumps just in case the first backups should fail. There are also backup cooling systems, instruments, and electric power systems.



The containment building around a reactor is built from concrete reinforced with steel like the exhibit shown here.



Nuclear power plants are built to withstand hazards like tornadoes.

Safety barriers. Utilities build nuclear power plants to withstand all environmental hazards, including tornadoes, hurricanes, fires, floods, and earthquakes. Engineers design for safety in the event of an earthquake, even for plants located in areas of moderate or low earthquake activity.

The containment building that houses the reactor works as a barrier that keeps radiation inside, away from the environment. Other barriers also hold in radiation. Uranium fuel is in solid ceramic form that does not rust or dissolve. It can withstand very high temperatures. The ceramic fuel is sealed inside metal fuel rods that make up the core. A massive steel pressure vessel surrounds this reactor core. All of these barriers keep radiation in the reactor and out of the environment.

Comparison of Radiation Exposures

In late March 2011, scientists at Cook Nuclear Power Plant in Michigan took measurements of the radiation around their site. They recorded a level of 0.05 millirem (mrem). The graphic below shows how this level compares to other naturally occurring and human-made radiation that Americans are exposed to each year.



0.08 MREM
smoke detector



1–2 MREM
watching TV



10 MREM
chest X-ray



30 MREM
cosmic rays
(average for most of U.S.)

Teachers' Notes:

Ask your students to convert millirem shown in the table to millisievert.

0.08 mrem = 0.0008 mSv

1–2 mrem = 0.01–0.02 mSv

10 mrem = 0.1 mSv

30 mrem = 0.3 mSv

Teachers' Notes:

Ask students to think about whether the radiation measurement taken at Cook is a high or low in comparison to other sources. Have them compare 0.05 to the 620 millirem that an average American is exposed to each year. Ask students to quickly calculate about how many times less it is. Using scientific notation and moving the decimal point to the left, they should determine that it is roughly 10,000 times less, or 1/10,000th.

Teachers' Notes:

Ask your students how many mSv (or mrem) come from background radiation.

3.1 mSv (310 mrem)

What regulations apply to U.S. nuclear power plants?

Regulations require utilities to develop detailed plans to prepare for emergencies. The utility must immediately notify the public, the NRC, and State and local governments if a problem occurs. The utility must also have plans for evacuating people who live nearby. Emergency officials, plant employees, firefighters, rescue teams, and police teams regularly practice putting the plans into action to be ready to respond to accidents.

Isn't even a small amount of radiation harmful?

Some people are concerned about low levels of radioactivity released by nuclear power plants generating electricity. As you learned

in Lesson 4, everyone receives natural and human-made radiation all the time.

U.S. nuclear power plants add about 0.0001 millisievert (0.01 millirem) a year to the radiation received by people living within 50 miles of a nuclear power plant. Most scientists agree that this is insignificant when compared to the 6.2 millisievert (620 millirem) of total radiation the average American receives each year.

What about the radioactivity from spent fuel?

When reactor operators take fuel out of the reactor, it is very radioactive. It must be handled carefully and shielded to protect workers. Today, spent fuel (used fuel) is stored securely at power plants under water

in spent fuel pools or in dry casks. This keeps radiation away from workers and people living near the plant. In the future, we will use **permanent disposal** to isolate high-level radioactive waste for thousands of years.

Teachers' Notes:

Students may have heard of a "dirty bomb." The fear is that terrorists might try to use dynamite or explosives to spread radiological contamination. There would be danger from the explosion, and people would be afraid of the contamination. But, it is not a nuclear explosion.

Can terrorists use nuclear power plant fuel to make nuclear bombs?

No. The uranium fuel used in nuclear power plants will not work for a nuclear bomb. It is not enriched enough to explode as a weapon. Some people worry that terrorists might try to steal or hijack a fuel shipment to try to make a "dirty bomb" by using explosives to spread contamination in the environment. Although this would scare people, it would not be very effective. However, nuclear fuel is kept under strict **security** to prevent anyone from getting access to it.

How do nuclear power plants affect other kinds of security?

So far, we have talked about physical safety. Another kind of security involves protecting our economy. The United States depends on energy for every part of our economy. When energy is not available, or the price goes up quickly, it affects every person. We import much of our energy from other countries. Using nuclear energy to make electricity is one way our nation maintains a reliable electricity supply at a reasonable price.

What happened at Three Mile Island?

A 1979 accident at the **Three Mile Island** plant in Pennsylvania was the most serious nuclear power plant accident in the United States. Plant operators mistook readings from the reactor systems and turned off automatic safety systems. This caused the reactor to lose cooling water. The reactor fuel overheated and seriously damaged the core. High levels of radiation were released into the containment building, and the heat ruined the reactor unit.

The protective barriers at the plant kept most radiation inside, but traces of radioactive iodine and xenon gas were released off the plant site. The average radiation exposure to people living in that area was about 0.01 millisievert (1 millirem) from the accident. This is less than the radiation from a chest x-ray, which is about 0.06 millisievert (6 millirem). It's also far less than the natural background radiation in that part of Pennsylvania, which is about 1 to 1.25 millisievert (100 to 125 millirem) per year. There were no serious injuries. However, it took weeks before authorities fully understood what had happened and people living near the plant were concerned that it could be dangerous. It was costly for the utility to clean up the damaged reactor and to replace the electricity it produced.

What about accidents in other countries? What happened at Chernobyl?

In April 1986, there was a very serious accident at a reactor in **Chernobyl**, Ukraine, in the former Soviet Union. Operators were performing unauthorized tests that caused a steam explosion and fire that destroyed the reactor. Two workers died in the accident. Another 28 workers died several months later.

The Chernobyl reactors were an entirely different design than power plants in the United States. Chernobyl reactors did not have containment buildings like the ones required for U.S. power plants. The Chernobyl accident released a large amount of radioactive contamination to areas of Belarus, Ukraine, and other countries in Europe.

Studies by a United Nations scientific committee indicate that there were more than the normal number of cases of thyroid cancer in children near the site. No other increase in cancer or other diseases has been found in 25 years since the accident. However, it is possible that we could see some increase in diseases linked to radiation from Chernobyl in the future.

What happened at Fukushima in Japan?

In March 2011, there was a massive earthquake off the coast of Japan. The earthquake caused a 14 meter (49 foot)

tsunami, or tidal wave that flooded the coast and killed about 19,000 people and injured 28,000 more. The **Fukushima Dai-Ichi** nuclear power station is on the coast. The plant has six reactors, but three were shut down for regular maintenance. When the earthquake occurred, the three operating reactors automatically shut down and emergency cooling systems came on. However, the earthquake cut off the supply of electricity to the plant, so emergency backup generators started to supply electricity. Then the tsunami flooded over the emergency backup generators. Without electricity, plant operators were not able to keep the reactor and spent fuel cooled. Damage to the nuclear fuel caused explosions of hydrogen gas. There were releases of radiation. People were evacuated from areas around the plant. Some food and water supplies were contaminated, and workers were exposed to radiation. No one died because of the damage to the power plant, but one worker died in the tsunami.

What do these accidents mean for reactor safety?

Whenever there is an accident or problem at a nuclear power plant, experts in the United States and around the world study it to see what we can learn to make our nuclear plants safer. For example, after Three Mile Island, all reactors in the United States had to meet new safety regulations, and the operators had more training. After

Teachers' Notes:

Again ask students how they will have input into making power plants safer in the future.

Answers could include training for energy-related jobs, attending meetings to speak for or against a project, or deciding how they use energy.

In deciding how to make our electricity, we will have to weigh the risks and benefits of using various energy sources.



the earthquake in Japan, the U.S. Nuclear Regulatory Commission analyzed reactors to make sure they could withstand similar natural disasters. The lessons learned led to changes in the safety systems to protect the reactor fuel in case power is cut off at a plant.

How do these concerns affect U.S. energy decision making?

There are good aspects and problems with every energy source. The good aspects are called **benefits**. The problems are called **risks**. Most people feel that the benefits of a reliable energy supply outweigh certain risks. The question is really about how we can better understand and protect against risks when using energy resources like nuclear power.

There is an area of science called **risk assessment** that has been used to study the risks in various industries. Risk assessment can involve detailed mathematical

calculations and analysis. For example, to study risk in the nuclear power industry, scientists examine every step, beginning with mining fuel, building and operating power plants, and ending with decommissioning the power plants and disposing of nuclear wastes.

Risk assessment helps us understand the risks involved by comparing them to other situations. It also helps pinpoint ways to make things safer.

How do people make decisions about risks?

Scientists who study human behavior tell us that people are more likely to distrust new or unfamiliar things. When electricity, trains, and automobiles were first developed, some people were too frightened to use them. In more recent times, the same was true with microwave ovens and cell phones.

When given choices, we are most likely to pick things that are familiar. For example, some people refuse to fly in airplanes but will travel in cars, even though statistics show that airplanes are less likely to have accidents. Medical vaccinations, prescription drugs, food preservatives, and cell phones are other examples of new technologies that have changed the way we live, but that also concern some people.

We have grown accustomed to certain hazards even though they are comparatively dangerous. You accept certain risks when you bicycle or skateboard, go sledding or swimming, or participate in sports like football, basketball, soccer, or softball. All of our activities involve risk.

What are the risks and benefits of nuclear energy?

As with all energy sources, nuclear energy has both risks and benefits. Major questions we must consider about the risks and benefits of our energy options are

1. What are the risks of using an energy source to generate electricity?
2. Do the benefits outweigh the risks?
3. What are the risks of not having affordable electricity and the quality of life that goes with it?

These are very difficult questions and there are no simple answers. But these are questions you and other Americans are going to be answering in the future.



Many of our favorite activities involve risk.

Teachers' Notes:

The latest projections for growth in U.S. energy demand are available from the Energy Information Administration at www.eia.gov



Summary

In decisions to design, build, license, and operate nuclear power plants, safety is the primary concern. Engineers design a series of barriers to provide layers of containment to keep radiation from being released during regular operations of a nuclear plant or during an emergency. They design nuclear power plants to withstand natural disasters, including fire, floods, tornadoes, earthquakes, tsunamis, and hurricanes.

The security of nuclear power plants is also part of safety. To ensure safety and security, workers at nuclear power plants spend many hours planning, training, and practicing for emergencies.

Nuclear power plants in the United States have been very reliable and have a record for operating safely. However, the record

is not perfect. There have been accidents at nuclear power plants. The most serious ones did not happen in the United States. When there is a problem at a power plant anywhere in the world, experts study what happened to find ways to make plants safer.

One issue in the United States today is how to meet our future electricity demands. All choices involve some risk. In order to make decisions about this issue, it is important to understand risks and benefits. Risk assessment is an area of science that studies and measures risk to help us make decisions.

Being informed about nuclear energy involves defining the concerns people have, gathering the facts, and evaluating the information.



LESSON PLAN

Lesson 8: Lesson Plan

Safety

Overview

This lesson focuses on concerns about nuclear safety and security. It talks about the physics, engineering, and regulatory steps taken to make sure nuclear power plants are safe and secure. Three accidents at nuclear power plants are discussed, as are the lessons learned from these events. Benefits and risks are defined by how they affect decision making, including electricity generation decision making.

Concepts

- Safety is of prime importance in decisions to license, build, and operate nuclear power plants and to transport nuclear materials.
- Safe design and engineering and a series of barriers provide layers of containment so there are no releases of radiation during regular operation of a nuclear plant or during an emergency
- The security of nuclear power plants and shipments of nuclear materials is also a priority
- Training workers and testing safety systems are important parts of ensuring safety
- Learning from accidents in the United States and other countries helps make the design of U.S. reactors safer
- Scientists use risk analysis to measure risk
- Informed decisions require risks-benefits analysis

National Standards (Grades 5 – 8)

Science

NS.5-8.5 As a result of activities in Grades 5-8, all students should develop

- Abilities of technological design
- Understandings about science and technology

NS.5-8.6 As a result of activities in Grades 5-8, all students should develop understanding of

- Natural hazards
- Science and technology in society

Technology

NT.K-12.1 Basic Operation and Concepts

- Students demonstrate a sound understanding of the nature and operation of technology systems

NT.K-12.2 Social, Ethical, and Human Issues

- Students understand the ethical, cultural, and societal issues related to technology
- Students practice responsible use of technology systems, information, and software
- Students develop positive attitudes toward technology uses that support lifelong learning, collaboration, personal pursuits, and productivity

NT.K-12.3 Technology Productivity Tools

- Students use technology tools to enhance learning, increase productivity, and promote creativity
- Students use productivity tools to collaborate in constructing technology-enhanced models, prepare publications, and produce other creative works

Social Studies

NSS-EC.5-8.1 At the completion of Grade 8, students will know and understand

- Choices involve trading off the expected value of one opportunity against the expected value of its test alternative
- The choices people make have both present and future consequences
- The evaluation of choices and opportunity costs is subjective; such evaluations differ across individuals and societies

Objectives

Upon completing this lesson, students will be able to

- Discuss steps taken to ensure safety at nuclear power plants
- Discuss steps taken to ensure security at nuclear power plants
- Explain the role of the Nuclear Regulatory Commission in ensuring safety
- Explain the security value of a stable energy supply
- Explain the risks and benefits of using nuclear energy to generate electricity

Useful Websites for Further Information

U.S. Department of Energy's Office of Nuclear Energy – www.energy.gov/ne

Nuclear Energy Institute – www.nei.org

American Nuclear Society – www.new.ans.org

Nuclear Regulatory Commission – www.nrc.gov/waste.html

U.S. Department of Energy's Energy Information Administration – www.eia.gov

Key Terms / Vocabulary

- architect** – one who designs buildings and advises builders during construction
- backup** – to support or be available to serve as a substitute; a person or thing that recovers a system in the event of an accident or equipment failure
- barrier** – an obstacle that prevents movement or access
- benefits** – good things that come from a choice; something that helps an individual or a society
- Chernobyl** – the site in Ukraine in the former Soviet Union where the most serious nuclear power plant accident occurred in 1986
- “dirty bomb”** – a device designed to spread radioactive material
- design feature** – an intended or understood part of a plan or thought; one of many characteristics that defines the plan for a structure, form, or device
- engineer** – a designer or builder who applies principles of science and mathematics to make structures, machines, products, systems, and processes; to design or build
- exposure** – contact with something; may be harmful or beneficial
- Fukushima Dai-Ichi** – the site in Japan where a nuclear power plant accident resulted from an earthquake and tsunami in 2011
- Nuclear Regulatory Commission (NRC)** – an independent federal agency that ensures the safe use of radioactive materials for beneficial civilian purposes while protecting people and the environment
- permanent disposal** – a deep geologic repository for spent fuel and high-level nuclear waste
- regulation** – a rule or directive made and maintained by an authority; the status of being required to follow rules made and maintained by an authority
- regulator** – a person who supervises a particular industry or business activity
- regulatory agency** – a public authority or government agency responsible for supervising or exercising authority over some area of human activity
- risk** – a situation involving exposure to danger from which there may be an unwanted outcome
- risk assessment** – the scientific study of the risk of a situation
- safeguard** – a way to prevent a problem or accident; to protect against something undesirable
- safety system** – a design that works automatically to prevent accidents; a system that reduces possible hazards due to human error
- security** – the safety of an organization against criminal activity such as terrorism, theft, or spying
- Three Mile Island** – the site of a 1979 nuclear power plant accident in Pennsylvania
- tsunami** – an unusually large sea wave produced by an undersea earthquake

Lesson Eight – Chapter Outline

Opening the Lesson

Students may want to discuss the accident at Fukushima Dai-Ichi in Japan. For a detailed update on what happened, you can go to the American Nuclear Society *Nuclear News* magazine for April 2011 and read Special Report: Fukushima Daiichi after the Earthquake and Tsunami at www.ans.org/pubs/magazines/nn/y_2011/m_4

The U.S. Nuclear Regulatory Commission answers frequently asked questions about the Japanese earthquake and tsunami at www.nrc.gov/japan/faqs-related-to-japan.pdf

A detailed discussion of the Three Mile Island accident can be found at www.nrc.gov/reading-rm/doc-collections/fact-sheets/3mile-isle.html

What concerns do people have about nuclear power plant safety?

- Release of radiation
- Design to prevent accidents
- Safety record in U.S.

What keeps U.S. nuclear plants safe?

- Team of professionals – scientists, engineers, architects, regulators
- Engineered safety systems
- Regulatory agencies
- Design safety
- Engineered safety – backup systems
- Safety barriers/protection against natural disasters
- Licensing and oversight

What regulations apply to U.S. nuclear power plants?

- Role of Nuclear Regulatory Commission (NRC)
- Emergency Planning
- Training
- Notification

Isn't even a small amount of radiation harmful?

- Level of exposure from nuclear plants
- Reminder of average exposure from all sources: U.S. nuclear plants add less than 0.01 mrem a year

What about the radioactivity from spent fuel?

- Handling spent fuel
- Shielding and storage
- Permanent disposal

Can terrorists use nuclear power plant fuel to make bombs?

- Security
- Not enriched enough
- Protection against “dirty bomb”

How do nuclear power plants affect other kinds of security?

- Protecting our economy
- Role of nuclear as domestic energy source

What happened at Three Mile Island?

- Discussion of accident and results

What about accidents in other countries? What happened at Chernobyl?

- Discussion of accident and results
- Lack of containment building like those required in U.S.

What happened at Fukushima in Japan?

- Discussion of accident and results

What do these accidents mean for reactor safety?

- Responses to accidents as lessons learned

How do these concerns affect U.S. energy decision making?

- Benefits/risks
- Risk assessments

How do people make decisions about risks?

- Trust of the familiar
- Concern over the unknown

Reading

Reading for this lesson in the student reader can be assigned as homework prior to this class session, or it can be read in class as guided reading.

Performance Assessment and Extension

A Reading Review Exercise follows that you can reproduce or project for your class. The labs and activities that follow include inquiry-based questions that can be used to assess student learning. Accompanying this lesson is a PowerPoint lecture with a review that can be used as an interactive assessment. For a project-based assessment, have students create a blog, podcast, or video on a topic from this lesson.

Lesson 8 Reading Review Exercise

A. Indicate whether the following statements are true (T) or false (F) by circling the correct letter. If the statement is false, correct it to make it true.

1. All backup safety systems in nuclear power plants are tested regularly to make sure they are working properly. T F
2. After highly trained operators finish their training and begin working at the power plant, they do not have to do any more training. T F
3. The containment building is strong enough to withstand earthquakes, hurricanes, thunderstorms, and even the crash of a large airplane. T F
4. Because they make electricity, nuclear power plants are not required to have backup generators that can supply electricity to the plant if there is a blackout. T F
5. The Three Mile Island accident was the worst nuclear power plant accident that has occurred in the world. T F
6. There are good aspects and problems with every energy source. T F

B. Safety Around You - List systems, equipment, backup systems, training for safety for your home, your school, and a car. You should be able to think of at least five items for each.

Your Home _____

Your School _____

A Car _____

Lesson 8 Reading Review Exercise - Answers

A. Indicate whether the following statements are true (T) or false (F) by circling the correct letter. If the statement is false, correct it to make it true.

- 1. All backup safety systems in nuclear power plants are tested regularly to make sure they are working properly. (T) F
- 2. After highly trained operators finish their training and begin working at the power plant, they do not have to do any more training. T (F)
They continue to take training often.
- 3. The containment building is strong enough to withstand earthquakes, hurricanes, thunderstorms, and even the crash of a large airplane. (T) F
- 4. Because they make electricity, nuclear power plants are not required to have backup generators that can supply electricity to the plant if there is a blackout. T (F)
They are required to have backup generators.
- 5. The Three Mile Island accident was the worst nuclear power plant accident that has occurred in the world. T (F)
The worst was Chernobyl.
- 6. There are good aspects and problems with every energy source. (T) F

B. Safety Around You - List systems, equipment, backup systems, training for safety for your home, your school, and a car. You should be able to think of at least five items for each.

Your Home door lock, window lock, smoke alarm, fire extinguisher, family fire drills, family plans for meeting place in case of fire or other emergency, telephone to 911 for fire or police department, home protection system, electrical breakers, hand rails for stairs

Your School fire drills, tornado drills, earthquake drills, fire alarms, fire extinguishers, PA/announcement system, phones to call 911 for police or fire department, door locks, window locks, police assigned to school, rules about bringing guns or knives to school, metal detectors, smoke detectors, fire suppression sprinkler systems, hand rails for stairs

A Car seat belts, air bags, brakes, emergency brake, brake lights, turn signals, horn, flashing emergency light, wind shield wipers, defroster to keep windshield clear, traffic laws, police checking for unsafe driving, rules and tests for getting driver licenses

Activities, Labs, and Supplemental Information:**Teacher's PowerPoint Presentation**

A Teacher's (PowerPoint) presentation is provided on CD and online on the DOE Office of Nuclear Energy website to help you present chapter concepts to your class. Download the teacher presentation at: <http://energy.gov/ne/services/harnessed-atom>

Activity - What Does Safety Engineering Mean?

This activity starts with a class discussion about the meaning of redundancy and what it has to do with nuclear reactor safety. After the discussion, group work follows where students design their own redundant systems.

Activity - Ranking Risk

The primary in-class activity for Lesson 8 is the Ranking Risk Activity found on the CD or on the web site. The opening screen looks like the image to the right.

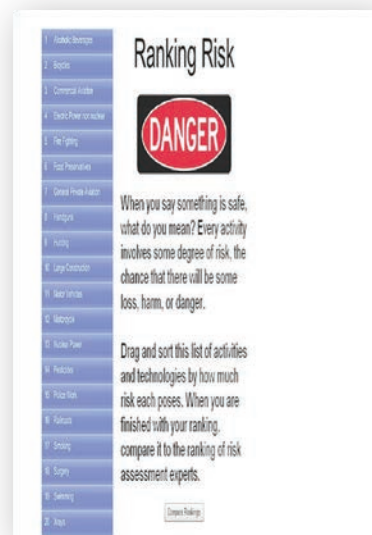
**Lab - Designing for Safety**

Students design a “cask” to protect a raw egg. Then they test the “cask” by dropping it. If the egg survives intact, the design was successful. [Viewing *An American Success Story: The Safe Shipment of Used Nuclear Fuel*, a 9-minute video, would be a great introduction to this activity. To access the video, enter the title into a search engine.]

Social Studies Extension – Go to the Source

This activity features a rich collection of original documents from the National Archives to give students a sense of history and a glimpse of the complexity of the past. Primary sources are the original documents and objects which were created at the time under study. From diaries and letters to newspapers and maps, primary sources tell us about the circumstances of significant historical events in terms of everyday life. Engaging students with primary sources aligns with national standards for teaching civics, government, and history. Citing evidence from primary sources can also build better critical thinking and analysis skills for constructed response testing. You can find more information about using primary sources from the Smithsonian Institute at <http://historyexplorer.si.edu/PrimarySources.pdf>

Online Information

Training for a Nuclear Crisis –

www.pbs.org/wgbh/nova/tech/training-nuclear-crisis.html (7-minute video that discusses training of operators at a nuclear power plant)

Safe and Sound: Protecting Our Nuclear Energy Facilities – nei.org/keyissues/safetyandsecurity/

Click on Video and More to access the video (6-minute video that discusses training and security at nuclear power plants)

An American Success Story: The Safe Shipment of Used Nuclear Fuel – (9-minute video that discusses safe transportation of spent nuclear fuel and also shows a variety of jobs related to the nuclear industry) For access, enter the title into a search engine.

Activity – What does safety engineering mean?

The concept behind any engineered safety system is redundancy. This means that there are backups to protect each system to make sure it continues to work in an emergency.

Backup safety systems are used in many of the machines we rely on. Most of your students will be familiar with the redundant safety of cars. Ask students what they do when they get into a car that helps keep themselves safe. (*We put on seat belts to hold us in place in case of an accident. If students don't do it routinely, tell them you want them to start.*) Ask them about redundant systems if seat belts aren't enough. (*Air bags*)

Now divide students into small groups and challenge them to design redundant systems of their own.

1. Ask them if they can think of situations in their lives that need redundant safety systems. Get them started with these two scenarios:
 - They have a dog to walk who can sometimes wiggle out of his neck collar and run away. What can they devise to keep him contained? What about a backup plan to that backup plan? (Imaginative answers include additional leashes, harnesses, training, etc.)
 - They want to swim at a pool. They know how to swim but what do they do to stay safe? (Answers may include swim with a friend, have a life guard, equip the life guard with devices, etc.)
2. Then assign the groups to illustrate their redundant design safety:
 - Make a student-written television ad, play, or skit.
 - Make a radio advertisement.
 - Write and draw illustrations for an article for a magazine.
 - Create a pop-up book or a tunnel book. Free templates for pop-up and tunnel books are available online.



Materials

- Writing paper, pens
 - Cardboard or poster board
 - Markers
 - Construction paper
 - Scissors
 - Glue
 - Tape
3. Ask students if they can name any redundant or backup system at nuclear power plants. (*During operation, control rods absorb neutrons to regulate nuclear chain reactions. The control rod system can be instantly engaged to shut down fission in the reactor core. In many reactors, there are additional shutdown rods ready. Another engineered safety feature is the supply of emergency cooling water in addition to coolant in the system. If there were a loss of cooling water, the emergency cooling system would immediately provide water to cool the nuclear fuel. Within the reactor, there are many other examples of redundancy. All important systems have two, three, or more backup systems.*)

Activity – Ranking Risk

Risk Ranking is an online game on CD and will be available online at <http://energy.gov/ne/services/harnessed-atom>

Note: This activity runs in your browser using free software called Shockwave Player. Some computers have the security default set to block Shockwave until you “Allow” it to run. If you have problems launching this game, drag the icon onto your computer desktop and double-click. If the game does not open, check the top of your browser for a security warning and click on it to allow the program to run.

Ideally, this activity should be done by each student individually. Each student will rank 20 activities or technologies according to how much risk they think each poses. The activity or technology posing the most risk should be #1 and the activity posing the least risk should be #20. Assure your students that there are no “right” or “wrong” answers. Each student is ranking according to their perception of the risk of each activity or technology.

When students have completed their personal ranking, they should click the COMPARE RANKINGS button and see how the same activities and technologies were ranked by people who are experts in risk assessment.

When students have completed the ranking, the class can discuss reasons students made the choices they did and why their rankings don’t necessarily match those done by risk assessment professionals.

Directions

When students open the risk ranking computer activity, they will see the following directions.

Ranking Risk

When you say something is safe, what do you mean? Every activity involves some degree of risk and the chance that there will be some loss, harm, or danger.

Drag and sort this list of activities and technologies by how much risk each poses. When you are finished with your ranking, compare it to the ranking of risk assessment experts.

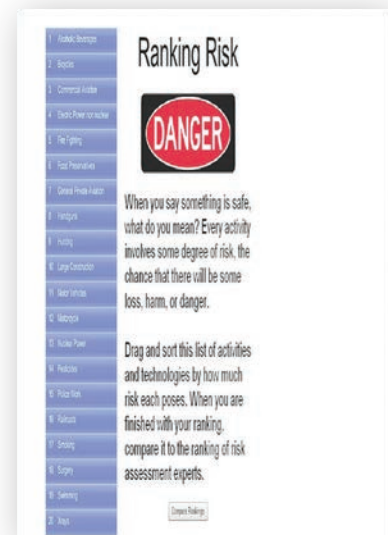

Lab – Designing for Safety

Materials

Each Team

- 1 uncooked egg
- 5 sheets of 8.5” by 11” paper (preferably recycled paper)
- 1 meter of tape

Entire Class

- Plastic sheet
- Meter stick
- Marking pens

Scientists, engineers, and architects work together to design and build a nuclear power plant. One of their main goals is to build barriers that keep radiation from harming workers, the public, or the environment. They call this protection “containment.”

To help you understand the challenge of designing for safety, you will be part of a team that will design and build a “cask” for the protection of an uncooked egg. Your cask design will be tested by dropping the cask from a high location under the direction of your teacher. Before the drop, the team will explain 1) **what** you did and 2) **why** you built the cask the way you did.



Procedure

1. Using the materials provided, each team will construct one cask.
Note: Your team will not receive additional materials.
2. Mark your cask so that it can be recognized. (Your team may even choose to name your design and mark the cask with the design name.)
3. One team member will drop the team’s egg cask in the area designated by the teacher. The dropping height will be 2.0 meters (or a height determined by your teacher).
4. After each team has dropped their cask, then meet and analyze the results for their cask. If the egg survived the drop, the team should think about what they did that worked. If it didn’t, the team should figure out why. Each team should also figure out what changes they would make for a second cask and prepare a short report giving their analysis of the performance of the first cask and changes for a second cask.

Activity – Go to the Source

Primary sources are the original documents and objects which were created at the time under study. From diaries and letters to newspapers and maps, primary sources tell us about the circumstances of significant historical events in terms of everyday life.

Materials

- Computer (laptop, desktop, or tablet)
- Paper, pencil, or pen

Procedure

1. Working in groups or on your own, choose one of the four documents from the collection available from the National Archives at Atlanta site:

<http://www.archives.gov/atlanta/exhibits/tva-nuclear.html>

2. Read the document and answer these questions:

What kind of document is it (letter, ad, newspaper, etc)? How do you know? _____

Is there a date on it? If so, what is it? _____ Where does it happen? _____

List any unusual words: _____

Speculate about each source, its creator, and its context. Who created this primary source? _____

What was happening during this time period? _____

What was the creator's purpose in making this primary source? _____

What does the creator do to get his or her point across? _____

Who were the readers of this document? _____

What is the relationship between the writer and the audience? _____

How can you tell? _____

What does the writer imply without stating it directly? _____

Do you think the writer is objective? _____ Why do you think that? _____

Where could you go next to learn more about the subject? _____



ENERGY AND YOU



Introduction

The United States depends on a plentiful supply of energy that is available at affordable prices. Why does that matter to you? Energy costs affect your family, your community, and the businesses around you all the time. When you enter the job market, your fresh ideas on clean energy sources, fuel efficiency, and new technologies can keep America the leader in energy innovation and production.

TOPICS:

Supply and demand

Energy decisions

Energy and the economy

Utilities

Energy and you

Your future career options

Do energy decisions affect you?

Yes. Rising energy prices affect everyone – workers, farmers, truck drivers, and restaurant owners. If businesses have to spend more for energy, they may earn less profit. Families feel the pinch when they pay their energy bills. That’s why the United States is working to secure our energy supply and meet our demand for energy.

If demand is greater than supply, something will change

- Sellers may charge more for their product
- Buyers may be willing to pay more
- Buyers may choose to go without
- Buyers may choose to buy something else

Teachers' Notes:

The latest projections for growth in U.S. energy demand are available from the Energy Information Administration at www.eia.gov

What is supply and demand?

Supply is how much of something is available. **Demand** is how much of it people want. Supply and demand determine the value of things. For example, the supply of oil on the world market determines the price of gasoline. When supply and demand are in balance, we say they are **stable**. Prices don’t change much.

Teachers' Notes:

Ask students for examples of products they have wanted that have been affected by the laws of supply and demand.



Imagine you and your friends have a bag of gummy bears. The bears are the supply. What if everyone likes the red ones best? Red bears are in demand. When you divide the bears, what do you think will happen?

What do supply and demand have to do with energy?

Energy costs are determined by supply and demand. When energy demand is greater than supply, prices go up. We also know that energy markets are global. This means that what happens in any part of the world affects everyone.

Energy is not like most other things we buy. With energy, it is hard for buyers to simply go without or to choose to buy something else.

How do utilities balance supply and demand?

Utilities build power plants to meet our demand for electricity. However, the demand for electricity changes from year to year. Before deciding to build a power plant, utilities consider supply and demand. Because it takes years to build a new power plant, utilities hire people to plan for what their customers will need in future. In planning, they figure the cost of building power plants, including the cost of borrowing money. They estimate the cost of operating the power plant over its entire lifetime. They also base their choice on the cost of the fuel and whether they can get a steady supply.

How can we plan for energy demand in the future?

To meet tomorrow's energy demand, we must look carefully at the energy

sources we have available. This is called our **energy mix**. Then we must make choices that will provide clean energy at a reasonable cost.

Current energy research focuses on expanding cleaner sources of electricity, including wind and solar, biomass, nuclear energy, clean coal, and natural gas. The United States is working toward making 80 percent of our electricity from clean energy sources by 2035. Keeping America on the cutting edge of **clean energy technology** sparks new jobs, new industry, and innovations that keep us safe, healthy, and protect our economy.

For the future, engineers are working on a new generation of smaller, safer, and more

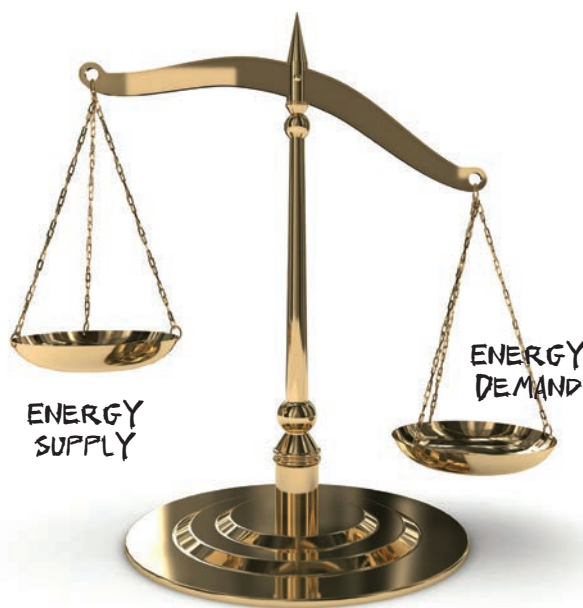

Utilities must plan ahead to meet the future demand for electricity by constructing power plants that help keep supply in balance. Clean energy sources will need to meet most of our demand by 2035.

Teachers' Notes:

Challenge your students to discover if the United States has a current energy policy. Ask them to identify what goals it establishes for our nation.

Teachers' Notes:

Ask students how they will have input into future energy use decisions.

Answers could include training for energy-related jobs, attending meetings to speak for or against a project, or deciding how they use energy.

Teachers' Notes:

Remind students that they learned in Lesson 1 that carbon dioxide is a greenhouse gas that is released when we burn oil, coal, and natural gas. It also comes from biomass, volcanoes, and other sources.

Teachers' Notes:

Nuclear energy and science careers include many skilled crafts and trades that do not require a college degree. These include

- Power plant operators, distributors, and dispatchers
- Nuclear-certified welders and pipefitters
 - Hazardous materials workers
- Water and wastewater treatment plant and system operators
- General maintenance and repair workers
- Transportation workers and drivers
- Robotic and remote-sensing operators
- Laboratory technicians

Students who are not on a college track still need strong skills in science, technology, engineering, and math in a competitive work force.

Teachers' Notes:

Explain associate's degree, bachelor's degree, master's degree, and PhD levels in college education.

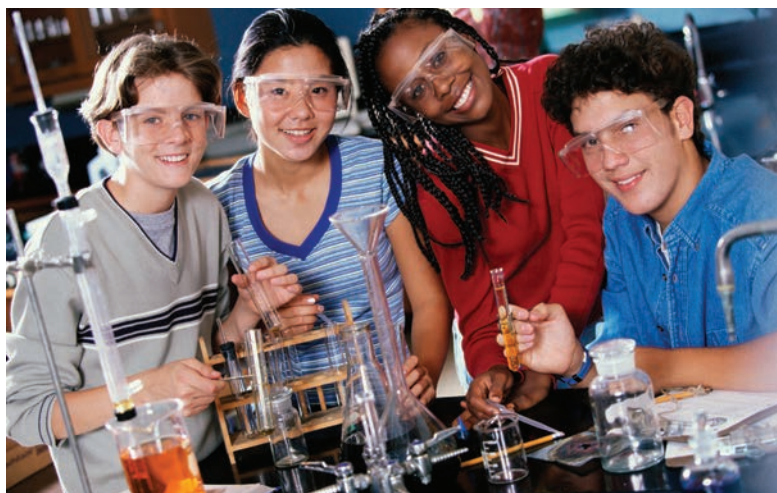

Skills that you learn in your science and math classes connect to your life outside school. They will also matter for jobs.

efficient nuclear reactors. Nuclear scientists and engineers from around the world are also working together to design a way to generate electricity using nuclear fusion.

A global race is underway to develop cleaner energy technology. Other countries are playing to win, too. To rise to this challenge, we need to tap into the greatest resource we have – your **ingenuity.**

Why should I think about this now?

Tomorrow's energy careers will require a deep understanding of science, and technology.

No matter what kind of job you want to do when you graduate, you need a strong foundation in computers and math. To take advantage of the career opportunities in your future, you will need to understand how science works and have the skills to use technology for learning more.

What are some jobs in nuclear science?

Your nuclear science career could focus on electricity production, nuclear fuel design, medical research, environmental protection, or even archaeology. Throughout the world, nuclear science is used in industry, medicine, agriculture, and environmental research to provide energy, help save lives, boost productivity, increase food output, and protect resources.

You have many options within those fields. Choosing your career starts with your interests, skills, and talents.

After graduating from high school, you have options that can lead to careers in nuclear science...

- 2-year college degree (called an associate's degree)
- Trade school certificate
- Apprenticeship
- 4-year college degree (called a bachelor's degree)
- Graduate school (called a master's or doctoral degrees)

CareerSnapshot:



Brent - Nuclear Engineering

I work with Advanced Reactor Systems and Safety on nuclear policy and safeguards to prevent spread of hazardous materials. My next assignment will be helping design systems for the next generation of smaller, safer, and more efficient reactors.

Education: I have a bachelor's degree in mechanical engineering and a master's degree in nuclear engineering, and am now finishing a doctorate. My employer is paying my tuition.

What are some energy jobs that use nuclear science?

Electricity demand is growing around the world. Nuclear energy is a clean energy resource that supplies electrical demand without releasing carbon dioxide into the atmosphere. Nuclear energy also powers satellites, ships, and space laboratories.

Career choices in nuclear energy include

- Reactor operators, who run the systems at a power plant to produce electricity
- Engineers, who design power plants and supervise operations
- Mathematicians and statisticians, who calculate energy costs and future demand
- Nuclear scientists, who explore ways to improve safety and efficiency
- Technologists, who locate natural resources underground

What are some other nuclear science jobs?

As the world's population grows, the need for food is increasing rapidly. Scientists use radiation to develop crops that produce higher yields, eliminate pests without chemicals, and improve food safety. For example, most pasta consumed today is made from a wheat variety developed by using this research. In Africa, radiation helped control the tsetse fly that transmits deadly disease to cattle and people.

Career choices in environmental research and nuclear technology include

- Gamma facility operators, who use radiation to destroy microorganisms like salmonella or *E. coli*.
- Biologists, who conduct experiments to develop new varieties of crops

CareerSnapshot:



Jenna - Nuclear Scientist

I am a food scientist with a specialization in nuclear science. I use radiation techniques to produce higher yield crops and protect livestock from disease. I also look for ways to eliminate pests without the use of traditional chemicals.

Education: I have a bachelor's degree in nuclear science and bachelor's degree in biology.

- Agricultural technicians, who use radiation to destroy disease-causing germs in food and spices
- Research assistants, who help scientists and food engineers collect and analyze data
- Technologists, who study natural resources to help make the most of limited water supplies

What are some nuclear medical science jobs?

Discoveries in nuclear science have dramatically improved people's health. **Nuclear medicine** benefits over 40,000 patients daily. Doctors rely on x-rays to diagnose broken bones or find tumors without surgery. They use radiation to treat leukemia and other types of cancer. More than half of all medical equipment used

CareerSnapshot:



Anthony - Nuclear Physicist

I do research at a national laboratory on energy and matter. My team is looking at the structure of matter and ways to use energy within the atom's nucleus.

Education: I have a master's degree in physics, which took another 2 years after my bachelor's degree. Most jobs in my field require at least a B.S. in physics or a related area, as well as strong math and writing skills.

CareerSnapshot:



Madison - Radiological Technologist

I assist doctors with x-rays and imaging scans that help diagnose tumors, certain types of cancer, and other diseases.

Education: After high school, I took two years of college courses that led to an associate's degree. My coursework included anatomy, pathology, patient care, radiation physics and protection, and image evaluation.

in hospitals is sterilized with radiation. Scientists use radioisotopes to develop more than 80 percent of all new drugs.

Career choices in nuclear medicine and biology include

- Health physicists, who assure that people who work with radiation do it safely
- Physicians, who use nuclear medicine to diagnose and treat diseases
- Nuclear medicine technologists, who run tests in hospitals
- X-ray technicians, who work with patients in hospitals

I WANT A JOB IN NUCLEAR SCIENCE

SCIENCE

Science exercises the mind and teaches logical thinking. It encourages looking at things in different ways.



TECHNOLOGY

Technology skills increase your ability to use, understand, and change many of the tools you already use, like computers or your cell phone, and to help develop new ones.



ENGINEERING

Engineering uses science and math, and applies them to design, create, or modify nearly any structure, machine, or material.



MATHEMATICS

Math skills give you the ability to identify and analyze patterns and use logic. It develops critical thinking skills and problem-solving skills.



I like to work with my hands.

I like to help people.

I am logical, precise, and creative.

I'm good with numbers.



maybe you would be interested in becoming a...

Power Plant Operator, Distributor, or Dispatcher who controls the systems that generate and distribute electric power. Nuclear power reactor operators regularly check power plant equipment to ensure it is working properly.

Requires

High school diploma, technical skills, continuous on-the-job training. College or Navy career is desirable.

Demand

60,000 jobs in 2015 expected to decline through 2024

Nuclear Medicine Technologist who uses scanners to create images of areas of a patient's body. They prepare radioactive drugs and administer them to patients undergoing scans. Radioactive drugs cause abnormal areas of the body to appear different from normal areas in the images.

Requires

2-year college degree

Demand

20,700 jobs in 2015 with 2% expected increase in positions through 2024

Nuclear Engineer who could help find industrial or medical uses for nuclear energy and radiation. You could also design nuclear power plants. Some nuclear engineers work for NASA, testing space shuttles to ensure safety in orbit and on launch.

Requires

4-year college degree

Demand

16,800 jobs in 2015 with 4% expected increase in positions through 2024

Applied Mathematician who creates models to solve practical problems in fields like business, government, engineering, and the sciences. You could work with a team of engineers and scientists and solve real-world energy problems.

Requires

6-year college degree

Demand

3,500 jobs in 2015 with 21% expected increase in positions through 2024

What are other careers in nuclear science?

Teachers' Notes:

You may want to explain that the process for dating ancient objects is called carbon dating. Because we know the half-lives of various isotopes, we are able to figure out how long they have been present in certain objects and, thus, determine the age of those objects. Carbon-14 is especially useful. New carbon-14 is constantly being formed by cosmic particles striking nitrogen-14 atoms in Earth's atmosphere. Carbon, including carbon-14, accumulates in living cells, but when organisms die, they no longer absorb carbon. The carbon-14 decays at a known rate. Scientists measure the carbon-14 that remains to calculate the age of the object.

Lots of other careers use nuclear science. **Archaeologists** and **paleontologists** use nuclear techniques to determine the age of objects. Crime investigators test evidence using neutron activation analysis. Art experts use nuclear tools like x rays to study paintings to see if they are valuable original art or fakes.

Why does energy science matter to you?

You will be making choices about how we should supply our future energy demands. Learning about the world's energy resources and the science behind how they can be used, will make you a better decision-maker in the future.

Meeting the world's energy demands will take many solutions. A mix of energy supplies is what Americans use now. That mix will change as supply and demand change. Planning for the best future energy mix will require smart scientists, engineers, and inventors working to create new energy options and to conserve what we have. Perhaps you will be one of these people.



Today's students will be tomorrow's energy decision makers, designers, and workers.

Teachers' Notes:

Ask students how they can influence important decisions our country makes, e.g., voting, contacting government officials, and even by what they and their families buy and use.



Summary

Supply and demand determine the cost of all things, including electricity.

The question we need to answer is how America will supply our demand for electricity. In deciding what type of power plant to build, utilities must consider construction, fuel, and operating costs. The sum of these costs will help them decide how to make electricity in the future.

You and your classmates will be making decisions about how we should meet our future energy demands. Planning the best mix of energy for the future will require smart scientists, engineers, inventors, and citizens. What will you be?



LESSON PLAN

Lesson 9: Lesson Plan

Energy and You

Overview

This lesson introduces students to the basic concepts of supply and demand and discusses how they then affect energy choices and costs. Supply and demand impact how the United States produces electricity and will continue to do so in the future. The 2011 *Blueprint for a Secure Energy Future* identifies goals for expanding cleaner sources of electricity, including renewables like wind and solar, as well as clean coal, natural gas, and nuclear power. The mix of clean energy sources is presented to students. The lesson also challenges students to anticipate how their science, math, and technology education will prepare them to enter the changing workforce in the future.

Concepts

- Our economy depends on the benefits of affordable electricity
- Supply and demand affect cost and decision making
- Energy is affected by supply and demand
- Math, science, and technology form the foundations of nearly every job now and in the future

National Standards (Grades 5 - 8)

Science

As a result of activities in Grades 5-8, all students should develop an understanding of

- Populations, resources, and environments
- Science and technology in society

Mathematics (Common Core)

7.RP.3. Use proportional relationships to solve multistep ratio and percent problems. Examples: simple interest, tax, markups and markdowns, gratuities and commissions, fees, percent increase and decrease, percent error

Social Studies

NSS-C.5-8.3 Principles of Democracy

How does the government established by the Constitution embody the purposes, values, and principles of American democracy?

- How does the American political system provide for choice and opportunities for participation?

NSS-C.5-8.5 Roles of the Citizen

What are the roles of the citizen in American democracy?

- What are the rights of citizens?
- What are the responsibilities of citizens?
- How can citizens take part in civic life?

NSS-EC.5-8.1 Scarcity

Productive resources are limited. Therefore, people cannot have all the goods and services they want; as a result, they must choose some things and give up others

At the completion of Grade 8, students will know the Grade 4 benchmarks for this standard and also understand:

- Scarcity is the condition of not being able to have all of the goods and services that one wants. It exists because human wants for goods and services exceed the quantity of goods and services that can be produced using all available resources
- Like individuals, governments and societies experience scarcity because human wants exceed what can be made from all available resources
- Choices involve trading off the expected value of one opportunity against the expected value of its best alternative
- The choices people make have both present and future consequences

NSS-EC.5-8.2 Marginal Cost/Benefit

At the completion of Grade 8, students will know the Grade 4 benchmarks for this standard and also understand

- Effective decision-making requires comparing the additional costs of alternatives with the additional benefits. Most choices involve doing a little more or a little less of something: few choices are “all or nothing” decisions
- To determine the best level of consumption of a product, people must compare the additional benefits with the additional costs of consuming a little more or a little less

NSS-EC.5-8.8 Role of Price in Market System

Prices send signals and provide incentives to buyers and sellers. When supply or demand changes, market prices adjust, affecting incentives.

At the completion of Grade 8, students will know the Grade 4 benchmarks for this standard and also understand

- An increase in the price of a good or service encourages people to look for substitutes, causing the quantity demanded to decrease, and vice versa. This relationship between price and quantity demanded, known as the law of demand, exists as long as other factors influencing demand do not change

Technology

NT.K-12.2 Social, Ethical and Human Issues

- Students understand the ethical, cultural, and societal issues related to technology

Objectives

Upon completing this lesson, students will be able to

- Explain the concept of supply and demand and how they set the price of a product and affect consumers' behavior
- Explain the value of a stable energy supply
- Name the costs associated with building a power plant
- State why a mix of energy technologies is needed
- Explain the qualities of clean energy technology

Key Terms / Vocabulary

clean energy – energy sources and technologies that release no or less carbon into the atmosphere than traditional sources and technologies

construction costs – money required to buy land and materials, pay workers' salaries, and pay interest to borrow money to build

costs – the amount of money we must pay now and in the future; consequences like environmental damage, dependence on another country, and health risks

demand – the amount of product people want and can buy

economics – the study of how we decide to use our resources to meet our needs and wants

energy mix – the combination of all fuel sources and technologies that meet our national demand for energy

fuel costs – money required to buy fuel

informed decisions – the outcome of considering the risks and benefits of choices

interest – an amount of money charged for borrowing money, usually a percentage of the amount borrowed

operating costs – money required to keep a system running

scarcity – a situation where demand for a product is greater than the supply; a shortage

stable – not likely to change

supply – the amount of a product available

Chapter Nine – Chapter Outline

How does energy affect the way we live?

- Link between energy use/availability/affordability and the way we live

What are supply and demand?

- Explanation of concept
- How supply and demand affect energy use

How do energy prices affect our economy?

- Extent of impact of abundant and affordable energy

What do utility companies consider when deciding what kind of power plant to build?

- Construction costs
- Fuel costs
- Operating costs

How do utilities plan for the future?

- Need to predict future energy needs
- Need to use energy resource mix
- Need to use clean energy technologies
- Role of students in answering questions about energy future

What are some nuclear energy jobs?

- Reactor operators
- Engineers
- Mathematicians/statisticians
- Nuclear scientists
- Technologists

Reading

Reading for this lesson in the student reader can be assigned as homework prior to this class session, or it can be read in class as guided reading.

Performance Assessment and Extension

A Reading Review Exercise follows that you can reproduce or project for your class. The labs and activities that follow include inquiry-based questions that can be used to assess student learning. Accompanying this lesson is a PowerPoint lecture with a review that can be used as an interactive assessment. For a project-based assessment, have students create a blog, podcast, or video on a topic from this lesson.

Lesson 9 Reading Review Exercise

A. Circle the letter of the best answer for each item.

1. Supply and demand determine the
 - a) Climate
 - b) Value of things
 - c) Responsibilities of people
 - d) Environment

2. If demand is greater than supply
 - a) Sellers may charge more for their product
 - b) Buyers may be willing to pay a higher price
 - c) Buyers may choose to go without
 - d) Buyers may choose to buy something else
 - e) All of the above are possible

3. Nuclear energy is one clean energy resource for meeting electrical demand because it
 - a) Is faster to build the plants
 - b) Does not require educated workers
 - c) Does not release carbon dioxide into the atmosphere
 - d) Eliminates mosquitoes

B. Indicate whether the following statements are true (T) or false (F) by circling the correct letter. If the statement is false, correct it to make it true.

- | | |
|--|-----|
| 1. Clean energy is an energy source or technology that releases less or zero carbon into the atmosphere than traditional sources. | T F |
| 2. Utilities build power plants to meet our supply for electricity. | T F |
| 3. The United States is working to secure our energy future by harnessing all the resources available. This is called an energy mix. | T F |
| 4. Very few present and future jobs require workers to use math or science. | T F |
| 5. A nuclear energy career must focus on electricity production. | T F |

C. List four clean energy sources. _____

D. Write two sentences to describe a job that uses nuclear science. _____

Lesson 9 Reading Review Exercise - Answers

A. Circle the letter of the best answer for each item.

1. Supply and demand determine the
 - a) Climate
 - (b)** Value of things
 - c) Responsibilities of people
 - d) Environment

2. If demand is greater than supply
 - a) Sellers may charge more for their product
 - b) Buyers may be willing to pay a higher price
 - c) Buyers may choose to go without
 - d) Buyers may choose to buy something else
 - (e)** All of the above are possible

3. Nuclear energy is one clean energy resource for meeting electrical demand because it
 - a) Is faster to build the plants
 - b) Does not require educated workers
 - (c)** Does not release carbon dioxide into the atmosphere
 - d) Eliminates mosquitoes

B. Indicate whether the following statements are true (T) or false (F) by circling the correct letter. If the statement is false, correct it to make it true.

1. Clean energy is an energy source or technology that releases less or zero carbon into the atmosphere than traditional sources. (T) F

2. Utilities build power plants to meet our supply for electricity. T (F)
Utilities build power plants to meet our demand for electricity.

3. The United States is working to secure our energy future by harnessing all the resources available. This is called an energy mix. (T) F

4. Very few present and future jobs require workers to use math or science T (F)
Nearly all jobs now and in the future require workers to use math and science.

5. A nuclear energy career must focus on electricity production. T (F)
Nuclear energy careers include many options.

C. List four clean energy sources. _____
hydroelectric, wind, solar, nuclear power, clean coal, natural gas

D. Write two sentences to describe a job that uses nuclear science. _____

Answers will vary

Activities, Labs, and Supplemental Information

Teacher's PowerPoint Presentation

A Teacher's (PowerPoint) presentation is provided on CD and online on the DOE Office of Nuclear Energy website to help you present chapter concepts to your class. Download the teacher presentation at: <http://energy.gov/ne/services/harnessed-atom>

Activity – Supply and Demand at the Pump

This worksheet allows students to see how price fluctuations are linked to supply and demand.

Activity – Using Informational Graphics

This activity asks students to create graphic representations of their clean energy research. Introduces students to the use of a thesis, or conclusion which they reach through analysis and interpretation of what they learn. You may choose to assign this activity to individual students or to groups.

Lab - Energy Expert

Allows students to become an expert on one clean energy source and present their findings to the class. Their presentations can take many forms, as suggested in the lab.

Lab – Future Energy Graphs

This lab allows students to use their math skills to present their predictions for future energy sources. Compare their results to what they had produced in Lesson 1.

Social Studies Extension – Power to the People

In this activity, students access primary sources from the National Archives to learn about the ways electricity shaped rural America. Primary sources are the original documents and objects that were created at the time under study. Students will use the collection of photographs, comic books, and newspaper and magazine articles to construct conclusions based on source evidence.

Supplemental Information

Supply and Demand, Lessons from Toy Fads

In this advanced extension, students can use a web resource to learn about supply and demand as taught through the toy fads of Hula Hoops and Silly Bandz. This extension offers an entire lesson plan: www.econedlink.org/lessons/index.php?lid=961&type=educator

Extended Learning (Planning for After High School)

The U.S. Department of Energy supports scholarships to help educate the next generation of nuclear scientists and engineers. A list of schools that are part of the program follows. Ask students to look at the list and see if there is a school in your state or one in another state of interest.

Math Extended Learning: Plan Ahead to Get Ahead

Middle school students are ready for the practical applications of learning money budgeting basics. Students can imagine themselves earning an income, budgeting expenses, and setting up a savings account. These activities apply fractions, decimals, and percentages to real life situations. Ask students to consider their academic strengths and interests and choose a career from page 74. Assign them to use that information and fill out a National Security Agencies budget worksheet: https://www.nsa.gov/academia/_files/collected_learning/middle_school/interdisciplinary/how_will_i_survive.pdf

Extended Learning: Planning for After High School

The U.S. Department of Energy supports scholarships to help educate the next generation of nuclear scientists and engineers. Here is a list of schools that are part of the program.

Abilene Christian University	Texas A&M University
Alfred University	Texas State Technical College
Auburn University	The Ohio State University
Boise State University	Thomas Edison State College
Brigham Young University	University of Alabama
Chattanooga State Community College	University of California, Berkeley
Clemson University	University of California, Davis
College of Southern Maryland	University of California, Irvine
Colorado School of Mines	University of California, Los Angeles
Colorado State University	University of California, Santa Barbara
Duke University	University of Colorado, Boulder
Excelsior College	University of Dallas
Florida International University	University of Florida
Florida State University	University of Idaho
Francis Marion University	University of Illinois, Urbana-Champaign
Georgia Institute of Technology	University of Maryland
Idaho State University	University of Massachusetts, Lowell
Illinois Institute of Technology	University of Michigan
Kansas State University	University of Missouri, Columbia
Lakeshore Technical College	University of Nevada, Las Vegas
Louisiana State University	University of Nevada, Reno
Massachusetts Institute of Technology	University of New Mexico
Miami Dade College	University of Notre Dame
Missouri University of Science & Technology	University of Pittsburgh
North Carolina State University	University of South Carolina
Northwestern University	University of Tennessee
Old Dominion University	University of Texas, Arlington
Onondaga Community College	University of Texas, Austin
Oregon State University	University of Texas of the Permian Basin
Pennsylvania State University	University of Utah
Polytechnic Institute of New York University	University of Washington
Purdue University	University of Wisconsin, Madison
Rensselaer Polytechnic Institute	Utah State University
Salem Community College	Vanderbilt University
South Dakota State University	Virginia Commonwealth University
Southeast Community College	Virginia Polytechnic Institute and State University
State Technical College of Missouri	Washington State University
Syracuse University	Wilberforce University/Central State University
Tennessee Technological University	William Marsh Rice University

Activity – Supply and Demand at the Pump

Finish the story by filling in the blanks. Words are listed that may be used for some of the answers. Some words may be used more than once. The other answers can be found by working math problems.

Possible answers:

supply demand shortage surplus raised lowered

Mr. Smith, a gasoline station owner, received 200 gallons of gasoline each week. His 20 regular customers were used to buying all the gas they need from him. Although some weeks people bought more and some people bought less, the average customer bought 10 gallons a week. The total demand for gasoline each week at the station was _____ gallons. As you know, Mr. Smith's supply was _____ gallons. Everybody was pretty happy about the whole thing. The supply was equal to the _____.

Mr. Smith charged \$1.00 a gallon for gasoline, a price that was about the same as that charged by the other station in town. Each customer spent an average of _____ each week. Mr. Smith received _____ for the 200 gallons of gasoline that he sold. When the other station reduced its price per gallon by a penny, four of Mr. Smith's regular customers deserted him and went across the street. He was still getting a delivery of 200 gallons a week, but now the demand was only _____ gallons. He had _____ gallons left over. This unbought quantity of gasoline is called a _____. To get rid of the extra gasoline, Mr. Smith _____ his price. His sixteen remaining customers bought up the _____ and took a few more pleasure trips into the city.

Several weeks later, Mr. Smith and the other station each week received only 100 gallons of gasoline. Their suppliers were short of gasoline that week. Their customers' demand were still

the same, so the pumps soon became empty. Halfway through the week, Mr. Smith had a _____ of gasoline. The sign out front said, 'No More Gas!' Also, by charging \$1.00 a gallon, he didn't make enough to pay the costs of his station.

The next week he raised the price to \$1.25 a gallon. The station across the street raised its price to \$1.30 and his regular customers came back. Even at the higher price, most of his customers still had to buy gas to drive to work and do errands, so he sold all 100 gallons to his regular customers. He received _____ from selling the 100 gallons. The average amount of gas each customer used was _____ gallons. The average amount each of the 20 regular customers spent was _____.

Some of Mr. Smith's customers wanted to drive as much as they usually had, which required 10 gallons of gas. At the new prices, 10 gallons of gas cost _____. Because they were on a fixed budget, these customers could not afford to spend more than \$10.00 a week for gas. Some of the other station's customers couldn't afford to spend more than \$10.00 a week for gas. Some of the other station's customers came over to Mr. Smith's station, and the demand was greater than the _____. Mr. Smith _____ his gasoline prices again. Mr. Smith's customers weren't so happy anymore.

Activity – Supply and Demand at the Pump - Answers

Finish the story by filling in the blanks. Words are listed that may be used for some of the answers. Some words may be used more than once. The other answers can be found by working math problems.

Possible answers:

supply demand shortage surplus raised lowered

Mr. Smith, a gasoline station owner, received 200 gallons of gasoline each week. His 20 regular customers were used to buying all the gas they need from him. Although some weeks people bought more and some people bought less, the average customer bought 10 gallons a week. The total demand for gasoline each week at the station was 200 gallons. As you know, Mr. Smith's supply was 200 gallons. Everybody was pretty happy about the whole thing. The supply was equal to the demand.

Mr. Smith charged \$1.00 a gallon for gasoline, a price that was about the same as that charged by the other station in town. Each customer spent an average of \$10.00 each week. Mr. Smith received \$200.00 for the 200 gallons of gasoline that he sold. When the other station reduced its price per gallon by a penny, four of Mr. Smith's regular customers deserted him and went across the street. He was still getting a delivery of 200 gallons a week, but now the demand was only 160 gallons. He had 40 gallons left over. This unbought quantity of gasoline is called a surplus. To get rid of the extra gasoline, Mr. Smith lowered his price. His sixteen remaining customers bought up the surplus and took a few more pleasure trips into the city.

Several weeks later, Mr. Smith and the other station each week received only 100 gallons of gasoline. Their suppliers were short of gasoline that week. Their customers' demand were still

the same, so the pumps soon became empty. Halfway through the week, Mr. Smith had a shortage of gasoline. The sign out front said, 'No More Gas!' Also, by charging \$1.00 a gallon, he didn't make enough to pay the costs of his station.

The next week he raised the price to \$1.25 a gallon. The station across the street raised its price to \$1.30 and his regular customers came back. Even at the higher price, most of his customers still had to buy gas to drive to work and do errands, so he sold all 100 gallons to his regular customers. He received \$125.00 from selling the 100 gallons. The average amount of gas each customer used was 5 gallons. The average amount each of the 20 regular customers spent was \$6.25.

Some of Mr. Smith's customers wanted to drive as much as they usually had, which required 10 gallons of gas. At the new prices, 10 gallons of gas cost \$12.50. Because they were on a fixed budget, these customers could not afford to spend more than \$10.00 a week for gas. Some of the other station's customers couldn't afford to spend more than \$10.00 a week for gas. Some of the other station's customers came over to Mr. Smith's station, and the demand was greater than the supply. Mr. Smith raised his gasoline prices again. Mr. Smith's customers weren't so happy anymore.

Activity – Using Informational Graphics

The 2011 *Blueprint for a Secure Energy Future* projects that by 2035, the United States will generate 80 percent of our electricity from a diverse set of clean energy sources. This activity will assist students in creating graphic representations of research they do about clean energy.

Directions

1. Ask students to brainstorm different ways they could illustrate clean energy information. List their responses. (Some responses might include advertisements, posters, TV commercials, charts, graphs, maps, political cartoons, Internet web site.)
2. Ask students to review their responses and consider which particular format will best allow them to present information on research they have performed. For example, statistical information is best represented in a chart, table, or graph as opposed to a written paragraph. Political commentary might be best represented using a political cartoon. They may conclude that informational graphics will best show clean energy information.
3. Divide students into working groups or assign individual students energy research topics.
4. Allow students to gather data and create a series of informational graphics about their research topic. If your school offers a computer lab, students can create these graphs using an online resource available at:
nces.ed.gov/nceskids/graphing/classic/
nces.ed.gov/nceskids/createagraph/
 These sites provide graph tutorials that may be helpful to your students.
5. Ask students to prepare a class presentation of their findings. Remind students that good research addresses an issue, problem, or controversy that is generally answered with a conclusion, otherwise known as a thesis. The thesis or conclusion is based on an analysis and interpretation of relevant information and materials. More information on thesis development is available at schools.nyc.gov/documents/teachandlearn/project_basedfinal.pdf

Informational graphics are visuals, such as maps, charts, tables, graphs and timelines, that give facts at a glance. Each type of graphic has its own purpose. Being able to read informational graphics is a valuable skill. Being able to prepare information graphics will enable students to present a lot of information in a visual form.



Lab – Energy Expert

In this lab, you will become an expert and explain to your audience about the costs and benefits of an energy source.

My energy source is _____.

Procedure

Step 1: Research

- How does your energy source produce usable energy?
- Where does your energy source come from and where is it used?
- How does its cost compare to other sources of energy?
- What are the benefits and risks of using this energy source?
- How much does it contribute to the energy supply today?
- What would take to dramatically increase its contribution within 4 years?

Step 2: Create Visual Aids

Present to the class in 3 minutes.

Your team may do this using

1. A video, in interview format
2. An animated film (video)
3. A public service announcement (video)
4. A slide briefing (using PowerPoint or similar tool)
5. A live presentation using flip charts and visuals

Research

Here are some places to look as you research your energy source:

- The Harnessed Atom

Ask your librarian for your school user name and passwords for

- www.school.eb.com Encyclopedia Britannica Online – provides a good overview
- EBooks from ABC-CLIO - A Student Guide to Energy © 2011
- Database: Global Issues in Context links to up-to-date international news articles, journals, reference articles, website links, videos and podcasts

Other sources

- Search engine: www.sweetsearch.com for student researchers to use instead of Google
- www.eere.energy.gov U.S. Department of Energy, Energy Efficiency and Renewable Energy
- www.fueleconomy.gov U.S. Department of Energy, Energy Efficiency & Renewable Energy, Fuel Economy information
- www.eia.gov U.S. Energy Information Administration, Independent Statistics and Analysis

Lab – Future Energy Graphs

Materials

- Each group needs writing supplies or access to a board.

Procedure

Spend 10 minutes discussing U.S. energy sources and what percentage we use. Use your student reader for information or go online. Create a pie graph that illustrates your ideal energy mix for the country in 25 years. You may wish to list possible energy sources on the board first. Consider these factors to help get discussion started:

- Availability of each energy source and where it is located
- The cost of each energy source. Use current cost information from the Energy Information Administration www.eia.gov
- How much energy each energy source can provide
- Which energy sources can provide electricity and which have other uses
- Environmental impacts of obtaining each energy source
- Environmental impacts of using each energy source
- Technology required to use each energy source



Once you have completed your graph, share your results with classmates. Create a list of pros and cons for each energy source that you choose.

1. What are the most important factors when choosing our future energy mix?

2. Can or should any one energy source provide the majority of our energy needs?

3. What changes need to be made to allow your future energy graphs to happen?

Social Studies Extension – Power to the People

In the years following World War II, the number of rural electricity consumers increased by 150% in the United States. Many utilities responded by expanding their generating and advertising its availability and benefits. Take a look at the photographs, comic books, and newspaper articles from those years to learn about how access to electricity shaped rural America. Historians call the links in this activity “primary sources” because they were created during the historical period you are studying.

Materials

- Computer (laptop, desktop, or tablet) with Internet access
- Paper, pencil, or pen

Procedure

1. Go to the National Archives website <http://www.archives.gov/atlanta/exhibits/tva-power-people.html> and select a primary source to analyze. Read your choice and look closely for key details.
2. Record your answers to these questions and cite your evidence:

What are your first impressions? (Answer: who, what, when, where?) _____

List details you see: _____

Who created this source, and what do I know about him/her/them? _____

What does the creator do to get his or her point across? _____

What was this primary source’s audience? _____

What biases or stereotypes do you see? _____

What was happening during this time period? _____

How is that relevant to the source? _____

What questions do you have about it that you cannot answer through analyzing it? What are the limitations and strengths of primary sources for historians? _____



REVIEW

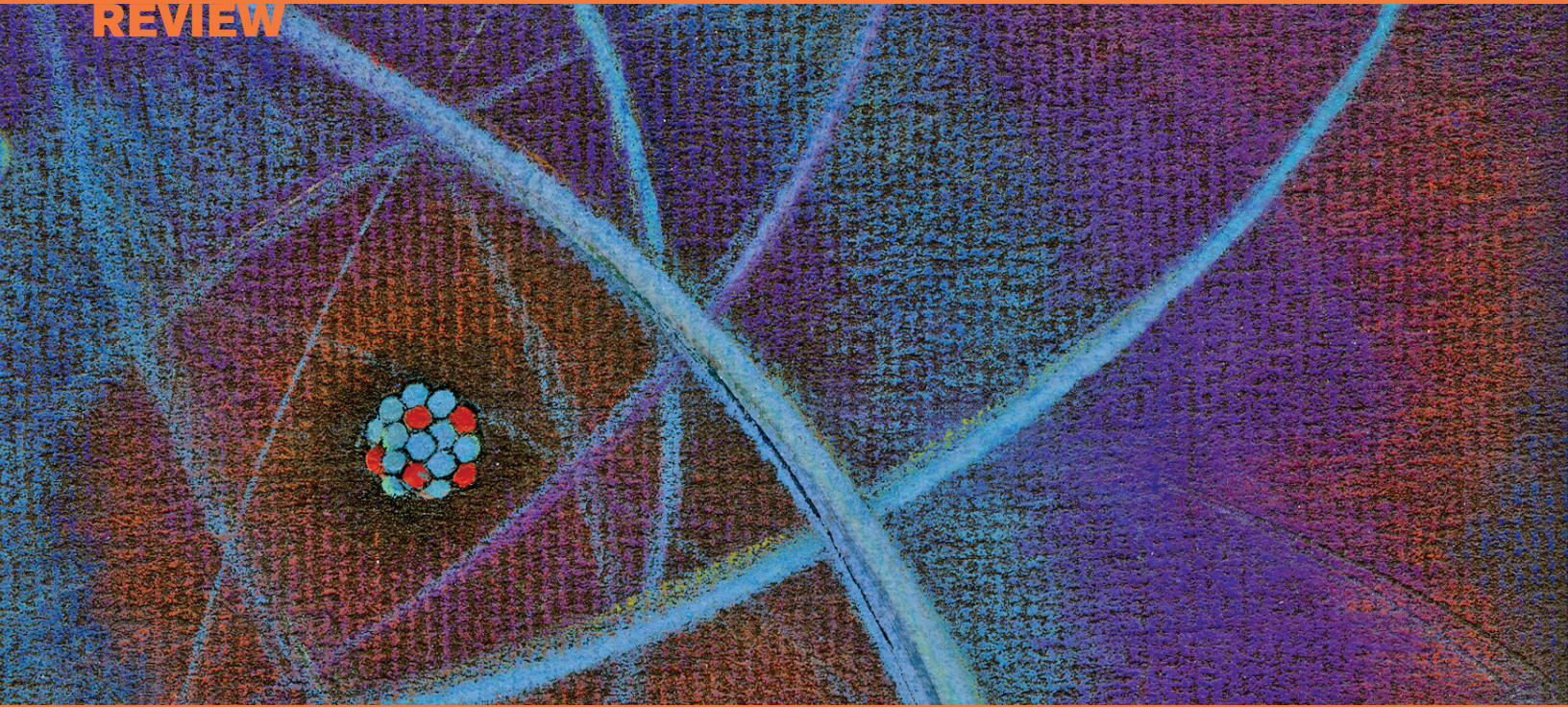

Lesson 10: Lesson Plan

Review

Overview

This final lesson provides students with a review of concepts and terms from this curriculum on energy and nuclear science. The format is flexible and can be adapted to your classroom needs and teaching style. The emphasis is on critical thinking and problem solving that goes beyond the scientific concepts covered in this kit.

Objectives

Upon completing the lessons, students will be able to

- Explain how nuclear energy is used to generate electricity
- Discuss key nuclear science concepts, including atoms, isotopes, radioactive decay, half-life, radiation, background radiation, and fission
- Discuss the role of nuclear energy in meeting the needs of the United States for electricity
- Discuss the importance of energy and electricity in their lives
- Discuss the importance of energy and electricity for the economy of the United States
- Discuss the complex choices society must make in order to meet future electricity demand

Post-test

A post-test is included at the end of this lesson. It provides an evaluation instrument to measure student gains in understanding this topic.

Extended Learning

Here are several activities that provide reviews/extensions for learning

- Civic Debate: Energy Choices Activity
- 'Consequence' Map Activity
- Selecting a Site for a Nuclear Power Plant Activity
- Power Plant Safety Nucleoglyphics Activity

Content Review Activities

Fermi Feud Activity

Using a “Jeopardy” format, this game is available on the CD ROM in this kit and is downloadable from the DOE Harnessed Atom website at energy.gov/ne/services/harnessed-atom

The game runs in Microsoft Excel and can be played at the classroom level with teams using a smartboard or projector. Sound files are part of the program but are not required.

Activity – **Civic Debate: Energy Choices**

Teacher Notes for Civic Debate

Directions

Allow one to three class periods for this activity.

You might wish to post these "Debate Do's" in the classroom and referenced often.

- Show respect
- Be polite and courteous
- Listen attentively
- Do not make inappropriate noises
- Speak only when recognized by the moderator
- Allow others to express their opinions; do not monopolize the debate
- Use grammatically correct language
- Speak clearly, slowly, and loudly enough to be heard by the audience
- Speak with passion and excitement

Distribute 4" x 6" index cards. On the front side, have students will write their names and either PRO or CON in large, bold letters. Raising the card will indicate the student's request to speak. Students will track their participation by making a fold in a corner of the card every time they speak. To ensure equal participation, after three folds, students should not speak until all students have had an opportunity to voice their opinions.

At the end of the debate, direct students to use the backs of their index cards to record

- Their names
- Their votes (PRO or CON)
- Two reasons for their votes

Teachers review and evaluation

- Were facts and sources given?
- Did everyone have a corner bent in his or her card?
- Did debaters follow the Debate Dos?
- Review index cards.

Adapted from LEARN NC (Pamela Myrick and Sharon Pearson) at www.learnnc.org/lp/pages/636

Activity – Civic Debate: Energy Choices

A debate is a discussion in which participants state their positions on an issue.

Directions

1. Select a topic

- Can the United States generate 80% of our electricity using clean energy sources by 2035?
- Should the United States limit the amount of carbon that can be released into the atmosphere?
- Should the United States construct a new generation of advanced nuclear power plants to meet our electricity needs?
- Should spent fuel be stored in an underground repository?
- Should the United States reprocess spent fuel?

2. Take a stand

Who's pro and who's con? Every debate has two sides, the affirmative side and the negative side.

The affirmative side, "pro," supports a proposition. The opposing or negative side, "con," opposes the proposition. Your teacher can divide the class into pros and cons, or students may choose their own stance.

3. Gather your facts

Support your point of view with facts and use this framework to support them.

Each student should have a fact gathering table that supports his or her point of view. *The Harnessed Atom* student book should be one of a minimum of three sources.

Opinion: We believe the U.S. should have underground repositories for spent fuel.	
Source 1:	
Fact:	
Source 2:	
Fact:	
Source 3:	
Fact:	

4. Start the debate

The moderator (teacher or a student) formally introduces the debate topic and recognizes students to speak, alternating between pro and con speakers.

5. Opening and closing statements

Appoint one student in each stance to make opening and closing statements. The debate begins with an opening statement from the pro side, followed by a statement from the con side. Opening statements should include each side's opinion with a brief overview of the supporting evidence.

The debate ends with closing statements from both sides. Again the pro side speaks first followed by the con side. The planned closing statements (one to three minutes) should restate the opinions with strong supporting evidence.

6. Review and evaluate

At the conclusion of the presentations, students may vote for what they think was the most persuasive statement.

Adapted from LEARN NC (Pamela Myrick and Sharon Pearson) at www.learnnc.org/lp/pages/636

Activity – Consequence Map

Key Term

Here, consequence means both good and bad outcomes

Part 1 - Consequences Map

Directions

1. Split students into groups (3-4 students/group)
2. Review the example for eating a chocolate bar.
3. Give each group an energy source
 - Nuclear
 - Hydroelectric
 - Wind
 - Solar
 - Coal
 - Natural Gas
4. Draw a concept map with the "Connecting Words" on the arrows between main ideas.
5. Students present/discuss maps. Each group can see what the other groups said.
6. Each group puts its energy source on a risk/benefit chart or line.

Use this consequence map for eating a chocolate candy bar as an example.

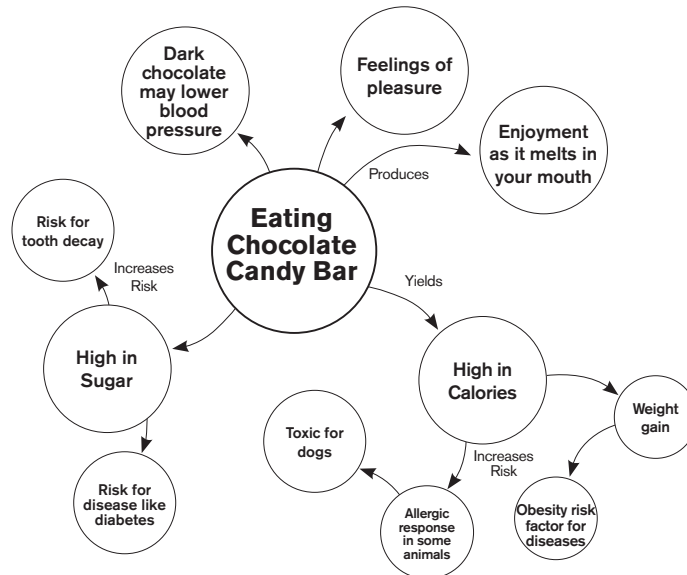

Part 2 - Risk/ Benefit Chart

6. Have each group put their energy on a risk/benefit chart or line. Compare the lines the groups generate. Have each group explain its thinking.

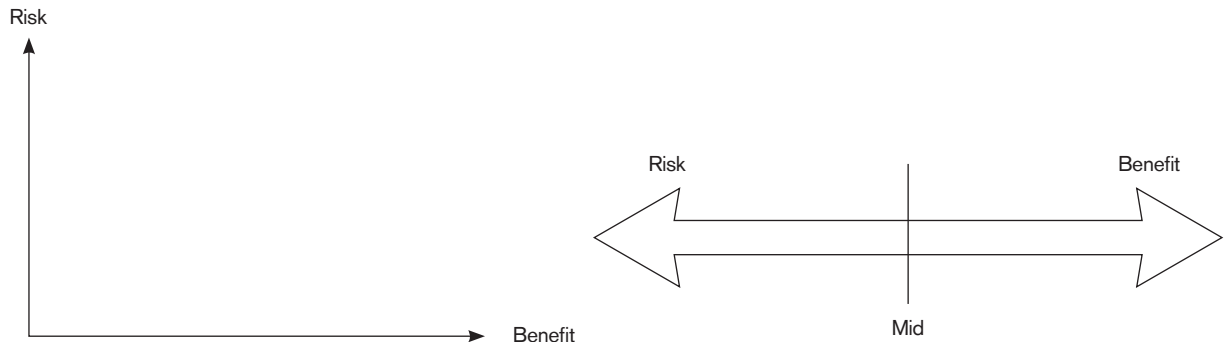

This sample consequence map for the use of nuclear energy is an example of how students might diagram their energy source.

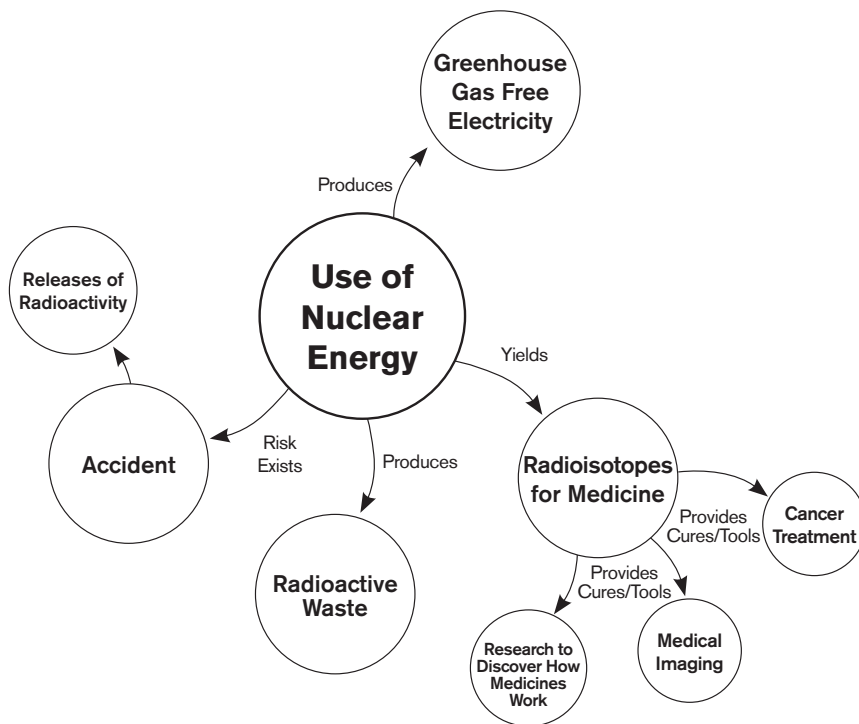

6. Have each group put their energy on a risk/benefit chart or line.

Results will vary.

Activity – **Selecting a Site for a Nuclear Power Plant**

Using the map provided, fill in the blanks which apply for each of the possible power plant sites. Then select the site that you think is best. Write a paragraph explaining why you selected the site and why you did not select each of the other sites.

If this site is selected	Site A	Site B	Site C	Site D	Site E
Supplies could be easily delivered by railroad					
Plenty of water would be available to the plant					
The plant would be downwind from centers of population					
The plant would be built on stable land					
The plant would be away from centers of population					
No historical objects would be lost by building a power plant					

Activity – Selecting a Site for a Nuclear Power Plant

Using the map provided, fill in the blanks which apply for each of the possible power plant sites. Then select the site that you think is best. Write a paragraph explaining why you selected the site and why you did not select each of the other sites.

If this site is selected	Site A	Site B	Site C	Site D	Site E
Supplies could be easily delivered by railroad			✓		
Plenty of water would be available to the plant	✓		✓		✓
The plant would be downwind from centers of population			✓	✓	✓
The plant would be built on stable land			✓	✓	✓
The plant would be away from centers of population			✓		✓
No historical objects would be lost by building a power plant	✓	✓	✓		✓

Activity – Power Plant Safety Nucleoglyphics

NUCLEAR POWER PLANT SAFETY IS VERY IMPORTANT
 $\Omega \psi \gamma \theta \pi E \Delta \delta \Sigma \omega \pi \Delta \delta \theta E \Omega \Theta \& E \phi \pi \Theta \Rightarrow \alpha \& \int \pi \Delta \Rightarrow \alpha \vartheta \delta \Sigma \Delta \Theta E \Omega \Theta$

Directions: Decipher the coded words by using the symbols given in the phrase above.

WARNING: Five letters are mysteries for you to solve.

1. $\Delta E \sigma \alpha E \Theta \alpha \Sigma \Omega$

— — — — —

7. $\gamma \Sigma \Omega \Theta E \alpha \Omega \vartheta \pi \Omega \Rightarrow$

— — — — —

2. $\varepsilon E \gamma \aleph \psi \S \& \Rightarrow \& \Theta \pi \vartheta \&$

— — — — —

8. $\omega E \& \Theta \pi$

— — — — —

3. $\& \pi \gamma \psi \Delta \alpha \Theta \Rightarrow$

— — — — —

9. $\wp \pi \Sigma \theta \Sigma \wp \alpha \gamma$

— — — — —

4. $\varepsilon E \Delta \Delta \alpha \pi \Delta$

— — — — —

10. $\Delta \pi \S \Sigma \& \alpha \Theta \Sigma \Delta \Rightarrow$

— — — — —

5. $\& \S \pi \Omega \Theta \quad \prod \psi \pi \theta$

— — — — —

11. $\Theta \pi \gamma \Upsilon \Omega \Sigma \theta \Sigma \wp \Rightarrow$

— — — — —

6. $\pi \Omega \int \alpha \Delta \Sigma \Omega \vartheta \pi \Omega \Theta$

— — — — —

12. $\vartheta \alpha \theta \theta \alpha \& \alpha \pi \int \pi \Delta \Theta \&$

— — — — —

Activity – Power Plant Safety Nucleoglyphics - Answers

NUCLEAR POWER PLANT SAFETY IS VERY IMPORTANT
 $\Omega \psi \gamma \theta \pi \epsilon \Delta \delta \Sigma \omega \pi \Delta \delta \theta \epsilon \Omega \Theta \& \epsilon \phi \pi \Theta \Rightarrow \alpha \& \int \pi \Delta \Rightarrow \alpha \vartheta \delta \Sigma \Delta \Theta \epsilon \Omega \Theta$

Directions: Decipher the coded words by using the symbols given in the phrase above.

WARNING: Five letters are mysteries for you to solve.

1. $\Delta \epsilon \sigma \alpha \epsilon \Theta \alpha \Sigma \Omega$
RADIATION

7. $\gamma \Sigma \Omega \Theta \epsilon \alpha \Omega \vartheta \pi \Omega \Rightarrow$
CONTAINMENT

2. $\epsilon \epsilon \gamma \varkappa \psi \S \& \Rightarrow \& \Theta \pi \vartheta \&$
BACKUP SYSTEMS

8. $\omega \epsilon \& \Theta \pi$
WASTE

3. $\& \pi \gamma \psi \Delta \alpha \Theta \Rightarrow$
SECURITY

9. $\wp \pi \Sigma \theta \Sigma \wp \alpha \gamma$
GEOLOGIC

4. $\epsilon \epsilon \Delta \Delta \alpha \pi \Delta$
BARRIER

10. $\Delta \pi \S \Sigma \& \alpha \Theta \Sigma \Delta \Rightarrow$
REPOSITORY

5. $\& \S \pi \Omega \Theta \prod \psi \pi \theta$
SPENT FUEL

11. $\Theta \pi \gamma \Upsilon \Omega \Sigma \theta \Sigma \wp \Rightarrow$
TECHNOLOGY

6. $\pi \Omega \int \alpha \Delta \Sigma \Omega \vartheta \pi \Omega \Theta$
ENVIRONMENT

12. $\vartheta \alpha \theta \theta \alpha \& \alpha \pi \int \pi \Delta \Theta \&$
MILLISIEVERTS

Posttest

Student Version

The Harnessed Atom - Posttest

Directions:

Circle the letter of the answer that best completes each statement.

1. The energy of motion is _____.
 - a. kinetic energy
 - b. smart energy
 - c. potential energy
 - d. none of the above

2. Electricity is the flow of _____.
 - a. protons
 - b. neutrons
 - c. electrons
 - d. atoms

3. Most electricity in the U. S. is made by using _____ to turn turbine-generators.
 - a. coal
 - b. oil
 - c. steam
 - d. uranium

4. Isotopes of an atom have the same number of _____.
 - a. electrons but different numbers of neutrons
 - b. neutrons but different numbers of protons
 - c. protons but different numbers of neutrons
 - d. electrons, neutrons, and protons

5. Nuclear power plants are different from other kinds of power plants because at a nuclear power plant _____.
 - a. pollution is released into the atmosphere
 - b. water is boiled to make steam
 - c. electricity is produced
 - d. the heat used to make steam is produced by fissioning atoms

6. The type of radiation that can be stopped by a piece of notebook paper is _____.
- alpha
 - beta
 - gamma
 - x-ray
7. The amount of time it takes for a quantity of radioactive material to lose half of its radioactivity is its _____.
- atomic number
 - half-life
 - radiation ratio
 - radiation life
8. You can protect yourself from radiation by _____.
- going up to a higher elevation
 - increasing the time you are exposed
 - increasing water intake
 - getting further away from the radiation source
9. In the U.S. in 2014, nuclear power plants made _____ of the electricity where the process did NOT release carbon dioxide (CO₂).
- all
 - none
 - less than half
 - more than half
10. Fission means that we release large amounts of energy by _____.
- splitting the nuclei of atoms
 - joining the nuclei of two atoms
 - splitting the electron of an atom
 - joining the electrons of two atoms
11. The number of protons in its nucleus gives us the identify of _____.
- a compound
 - a molecule
 - an electron
 - an atom

12. In today's nuclear power plants, the main fuel used is _____.
- cadmium
 - uranium
 - boron
 - helium
13. Climate change occurs partly because _____ is added to the atmosphere.
- radiation
 - carbon dioxide (CO₂)
 - radioactive decay
 - an isotope
14. In the United States we generate about _____ percent of our electricity by using nuclear fission.
- 5%
 - 10%
 - 20%
 - 40%
15. The nucleus of an atom contains _____.
- electrons and protons
 - protons and neutrons
 - neutrons and electrons
 - electrons and nuclides
16. Energy given off or released by unstable isotopes is called _____.
- electricity
 - chemistry
 - radiation
 - half-life
17. Because high-level waste from a nuclear power plant is radioactive, we _____.
- burn it at high temperatures
 - freeze it
 - isolate it while it loses radioactivity
 - dispose of it in the ocean

18. The reactor at a nuclear power plant is where _____.
- electricity is generated
 - fission takes place
 - water cools spent fuel
 - the turbine spins
19. The coolant/moderator in a nuclear power plant _____ neutrons to produce a chain reaction.
- slows down
 - speeds up
 - enriches
 - splits
20. In the United States, low-level radioactive wastes _____.
- are produced only at nuclear power plants
 - are disposed of in a geologic repository
 - are not produced at nuclear power plants
 - are produced at nuclear power plants and hospitals
21. The nuclear chain reaction speeds up when_____.
- the control rods are pulled out of the reactor core
 - the control rods are inserted into the reactor core
 - the control rods absorb neutrons
 - the control rods cool the reactor core
22. Before it is used in the reactor, nuclear fuel is _____.
- not radioactive
 - slightly radioactive
 - highly flammable
 - highly radioactive
23. Most of the radiation the average American is exposed to each year is from _____.
- nuclear power plants and the natural environment
 - medical uses and the natural environment
 - coal-fired and nuclear power plants
 - nuclear power plants

24. Storing spent fuel in a pool of water _____.

- a. keeps the fuel moist so it won't flake
- b. transfers radiation to the water so it can be filtered out
- c. provides shielding while fuel undergoes radioactive decay
- d. turns steam back into water

25. The containment building, pressure vessel, and ceramic form of the fuel help prevent releases of radiation at a nuclear power plant _____.

- a. in emergencies
- b. during tornadoes
- c. during normal operation
- d. all of the above

Posttest

Teacher Version
With Answers

The Harnessed Atom - Posttest Answers

Directions:

Circle the letter of the answer that best completes each statement.

1. The energy of motion is _____.
 - a. kinetic energy
 - b. smart energy
 - c. potential energy
 - d. none of the above

2. Electricity is the flow of _____.
 - a. protons
 - b. neutrons
 - c. electrons
 - d. atoms

3. Most electricity in the U. S. is made by using _____ to turn turbine-generators.
 - a. coal
 - b. oil
 - c. steam
 - d. uranium

4. Isotopes of an atom have the same number of _____.
 - a. electrons but different numbers of neutrons
 - b. neutrons but different numbers of protons
 - c. protons but different numbers of neutrons
 - d. electrons, neutrons, and protons

5. Nuclear power plants are different from other kinds of power plants because at a nuclear power plant _____.
 - a. pollution is released into the atmosphere
 - b. water is boiled to make steam
 - c. electricity is produced
 - d. the heat used to make steam is produced by fissioning atoms

6. The type of radiation that can be stopped by a piece of notebook paper is _____.
- a. alpha
 - b. beta
 - c. gamma
 - d. x-ray
7. The amount of time it takes for a quantity of radioactive material to lose half of its radioactivity is its _____.
- a. atomic number
 - b. half-life
 - c. radiation ratio
 - d. radiation life
8. You can protect yourself from radiation by _____.
- a. going up to a higher elevation
 - b. increasing the time you are exposed
 - c. increasing water intake
 - d. getting further away from the radiation source
9. In the U.S. in 2014, nuclear power plants made _____ of the electricity where the process did NOT release carbon dioxide (CO₂).
- a. all
 - b. none
 - c. less than half
 - d. more than half
10. Fission means that we release large amounts of energy by _____.
- a. splitting the nuclei of atoms
 - b. joining the nuclei of two atoms
 - c. splitting the electron of an atom
 - d. joining the electrons of two atoms
11. The number of protons in its nucleus gives us the identify of _____.
- a. a compound
 - b. a molecule
 - c. an electron
 - d. an atom

12. In today's nuclear power plants, the main fuel used is _____.
- a. cadmium
 - b. uranium
 - c. boron
 - d. helium
13. Climate change occurs partly because _____ is added to the atmosphere.
- a. radiation
 - b. carbon dioxide (CO₂)
 - c. radioactive decay
 - d. an isotope
14. In the United States we generate about _____ percent of our electricity by using nuclear fission.
- a. 5%
 - b. 10%
 - c. 20%
 - d. 40%
15. The nucleus of an atom contains _____.
- a. electrons and protons
 - b. protons and neutrons
 - c. neutrons and electrons
 - d. electrons and nuclides
16. Energy given off or released by unstable isotopes is called _____.
- a. electricity
 - b. chemistry
 - c. radiation
 - d. half-life
17. Because high-level waste from a nuclear power plant is radioactive, we _____.
- a. burn it at high temperatures
 - b. freeze it
 - c. isolate it while it loses radioactivity
 - d. dispose of it in the ocean

18. The reactor at a nuclear power plant is where _____.
- a. electricity is generated
 - b. fission takes place
 - c. water cools spent fuel
 - d. the turbine spins
19. The coolant/moderator in a nuclear power plant _____ neutrons to produce a chain reaction.
- a. slows down
 - b. speeds up
 - c. enriches
 - d. splits
20. In the United States, low-level radioactive wastes _____.
- a. are produced only at nuclear power plants
 - b. are disposed of in a geologic repository
 - c. are not produced a nuclear power plants
 - d. are produced at nuclear power plants and hospitals
21. The nuclear chain reaction speeds up when_____.
- a. the control rods are pulled out of the reactor core
 - b. the control rods are inserted into the reactor core
 - c. the control rods absorb neutrons
 - d. the control rods cool the reactor core
22. Before it is used in the reactor, nuclear fuel is _____.
- a. not radioactive
 - b. slightly radioactive
 - c. highly flammable
 - d. highly radioactive
23. Most of the radiation the average American is exposed to each year is from _____.
- a. nuclear power plants and the natural environment
 - b. medical uses and the natural environment
 - c. coal-fired and nuclear power plants
 - d. nuclear power plants

24. Storing spent fuel in a pool of water _____.

- a. keeps the fuel moist so it won't flake
- b. transfers radiation to the water so it can be filtered out
- c. provides shielding while fuel undergoes radioactive decay
- d. turns steam back into water

25. The containment building, pressure vessel, and ceramic form of the fuel help prevent releases of radiation at a nuclear power plant _____.

- a. in emergencies
- b. during tornadoes
- c. during normal operation
- d. all of the above

Credits

Cover

Cover Leidos

Content Standards, Grades 5-8, National Science Education Standards, 1996; Reprinted with permission from the National Academy of Sciences, Courtesy of the National Academies Press, Washington, D.C.

Lesson 1

Pg 1 Photos.com
Pg 2 Thinkstock
Pg 2 Leidos
Pg 3 Leidos
Pg 3 Thinkstock
Pg 4 Leidos
Pg 6-8 Photos.com
Pg 9 Leidos
Pg 9 Thinkstock
Pg 10 Thinkstock
Pg 11 Leidos
Pg 11 Thinkstock
Pg 12 Thinkstock
L1 6-9 Thinkstock
L1 10 Leidos
L1 11 DOE and EPA

Lesson 2

Pg 13 Photos.com
Pg 13 Leidos
Pg 14-16 Leidos
Pg 17-18 Thinkstock
L2 9 Thinkstock
L2 12-16 Leidos
L2 17-19 Jonathan Hare
www.creative-science.org.uk
L2 20, 22 Leidos
L2 24-26 Leidos

Lesson 3

Pg 19 Photos.com
Pg 19 Jon Reis Photography
Pg 20 Photos.com
Pg 21 Leidos
Pg 21 University of Tennessee
Pg 22 Leidos
Pg 23 Thinkstock
Pg 23 Photos.com
Pg 24 NASA
Pg 25 Thinkstock
L3 5, 7 Leidos
L3 12-15 Leidos

Lesson 4

Pg 27 Photos.com
Pg 28-30 Leidos
Pg 31 Thinkstock
Pg 32-34 Leidos
Pg 35 Thinkstock
Pg 35 Photos.com
Pg 36 Thinkstock
L4 11 Leidos
L4 13 Leidos
L4 17 Leidos
L4 20, 22 Leidos
L4 23, 25 Thinkstock

Lesson 5

Pg 37 Photos.com
Pg 37 Leidos
Pg 38 USGS and the Mineral
Information Institute
Pg 39 EIA
Pg 40 USEC, Inc.
Pg 40 Leidos
Pg 41 Leidos
Pg 41 NRC
Pg 41 NASA
Pg 42 Thinkstock
L5 9-10 Leidos
L5 11, 13 Thinkstock
L5 11-14 Leidos
L5 16-17 Leidos

Lesson 6

Pg 43 Photos.com
Pg 43-44 Leidos
Pg 44 NRC
Pg 45 Photos.com
Pg 45 SNPTC, Westinghouse
Pg. 46 NRC
Pg 46 Photos.com
Pg 46 Leidos
Pg 47 Leidos
Pg 47 Photos.com
Pg 47 NRC
Pg 48 Thinkstock
Pg 48 Leidos
Pg 49 Thinkstock
L6 6-23 Leidos

Lesson 7

Pg 51 NRC
Pg 51 Dounreay Site Restoration
Limited, Caithness, Scotland
Pg 51 Thinkstock
Pg 52 NRC
Pg 53 Leidos
Pg 54 NRC
Pg 55 Thinkstock
Pg 55 NRC
Pg 56 Leidos
Pg 57 Thinkstock
L7 18-22 Leidos

Lesson 8

Pg 59 Thinkstock
Pg 59 NRC
Pg 60 NRC
Pg 61 NOAA
Pg 61 Entergy Nuclear
Pg 62 Thinkstock
Pg 65-67 Thinkstock
L8 8 Leidos
L8 9 Thinkstock
L8 11 Leidos

Lesson 9

Pg 69 Thinkstock
Pg 69 Photos.com
Pg 70-73 Thinkstock
Pg 74 Leidos
Pg 75-76 Thinkstock
L9 11 Thinkstock
L9 13 Leidos

Lesson 10

Pg 77 Leidos
Pg 81-87 Leidos

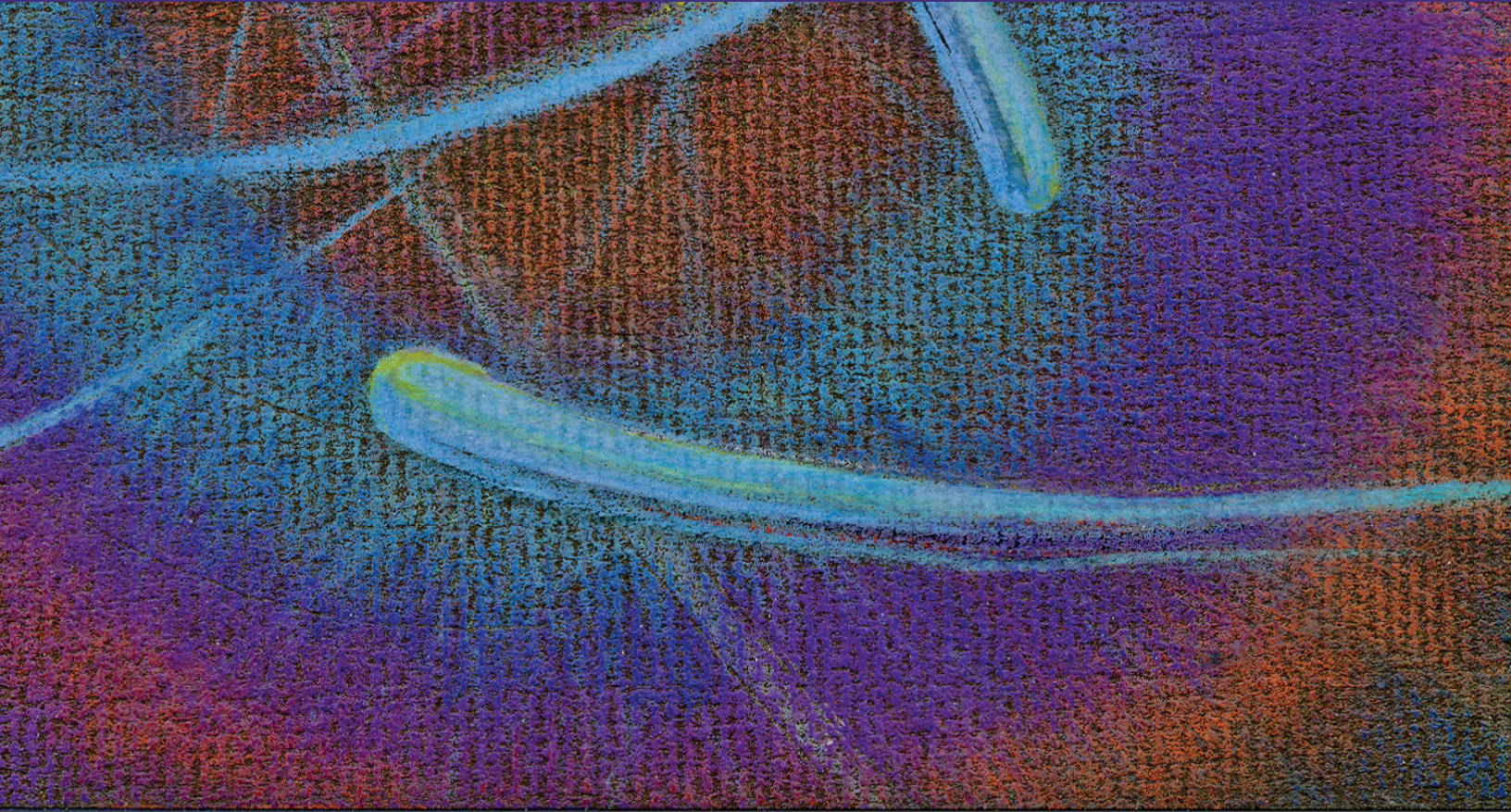

U.S. DEPARTMENT OF
ENERGY

Office of
Nuclear Energy