

# Coloring and Activity Book

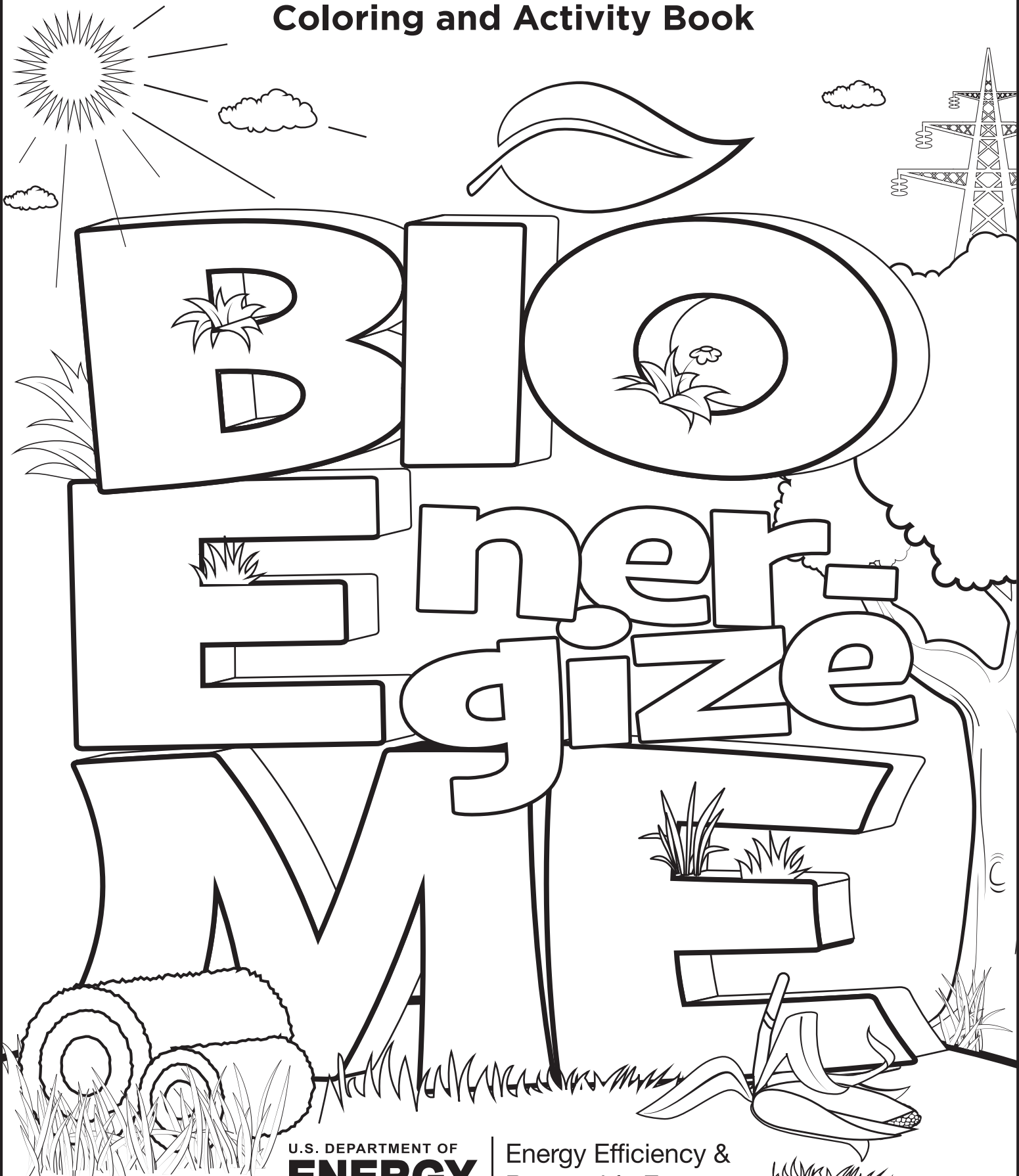

U.S. DEPARTMENT OF  
**ENERGY**

Energy Efficiency &  
Renewable Energy

BIOENERGY TECHNOLOGIES OFFICE

*Handwritten signature*

# What is Bioenergy and Where Does it Come From?

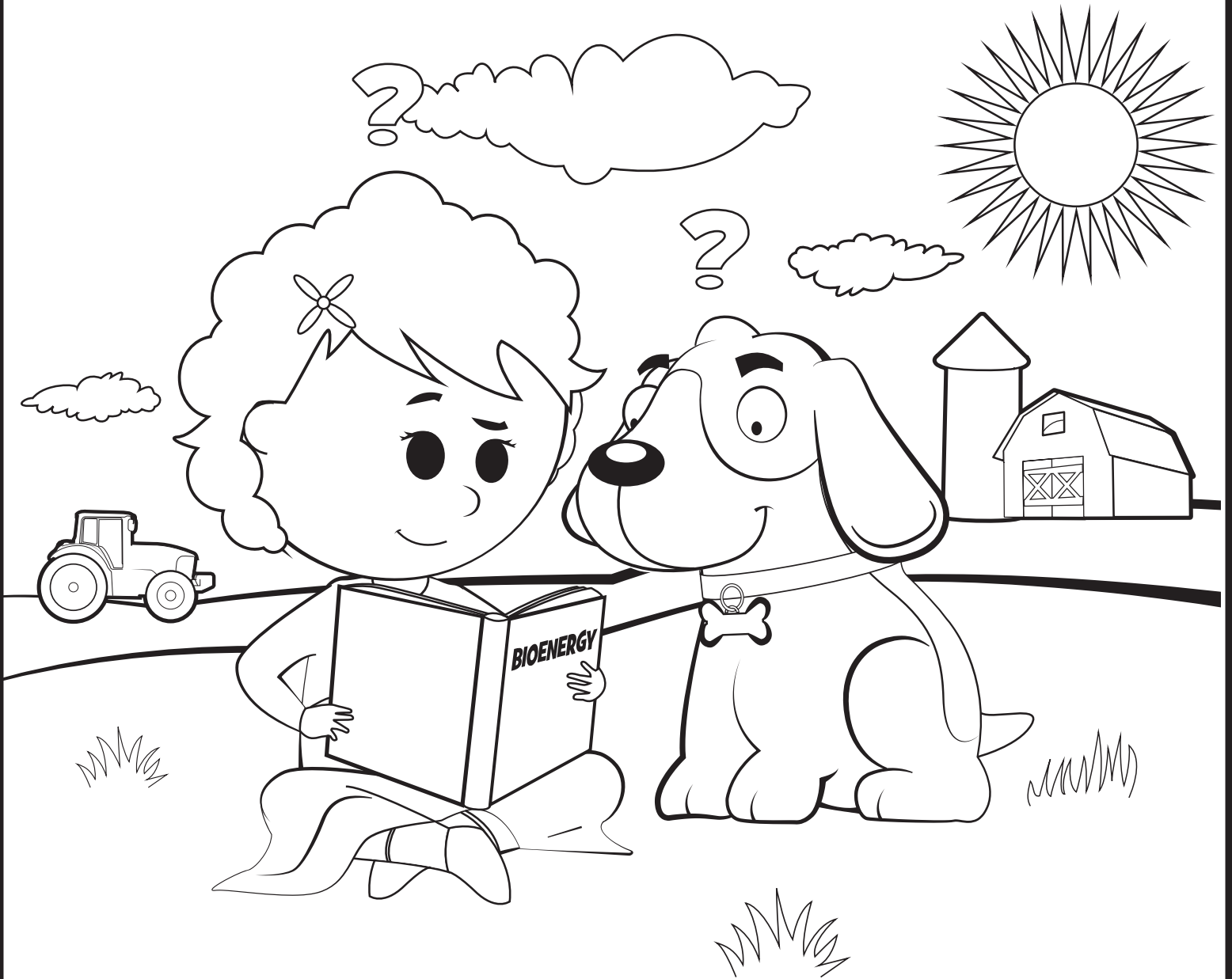

**Bioenergy is a form of renewable energy derived from biomass to generate heat, electricity, renewable products, and liquid fuels for transportation.**

# Biofuels Come From Plants and Trees (Biomass) and Waste

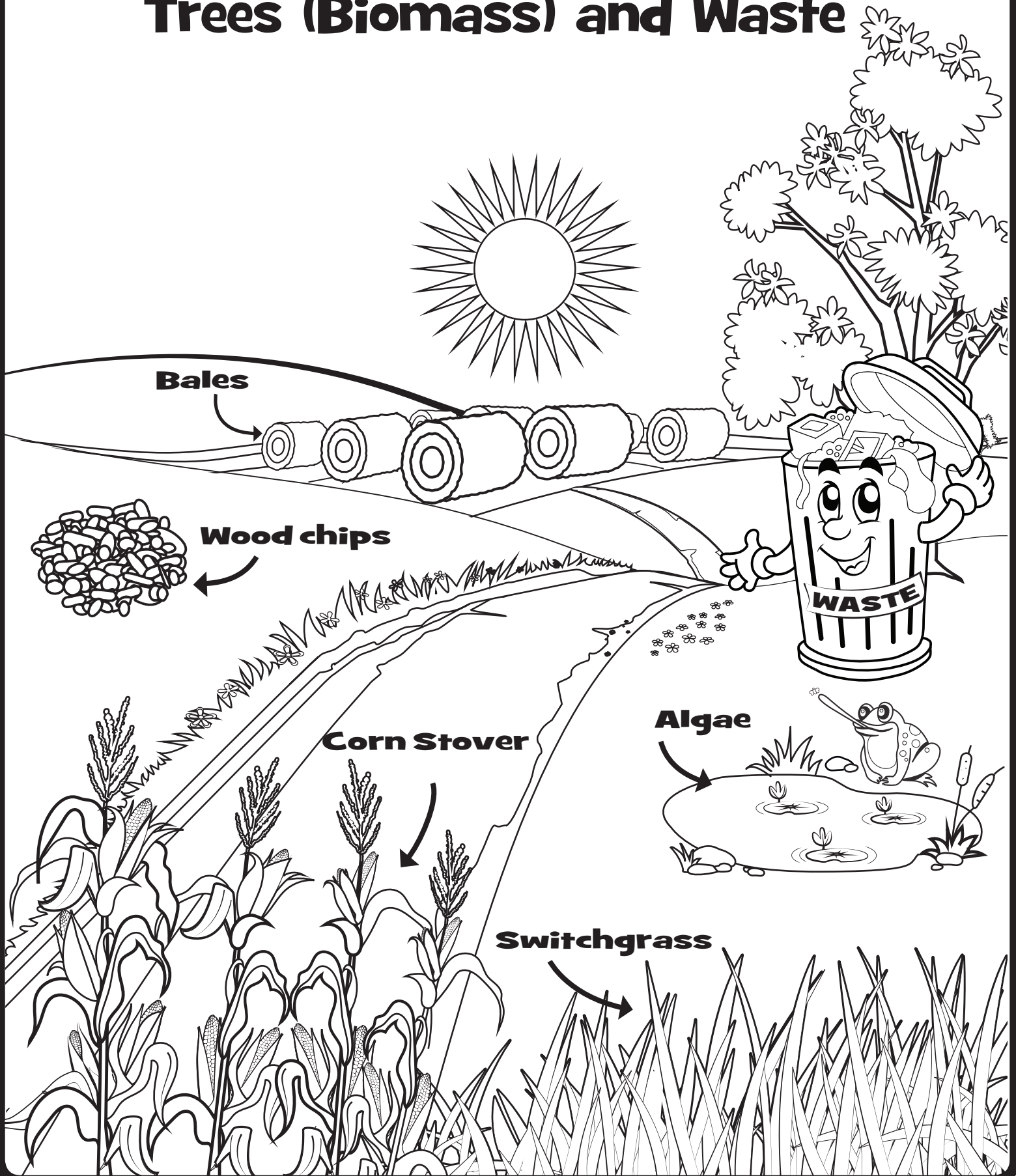

# What can Biomass Produce?

**Fuel**

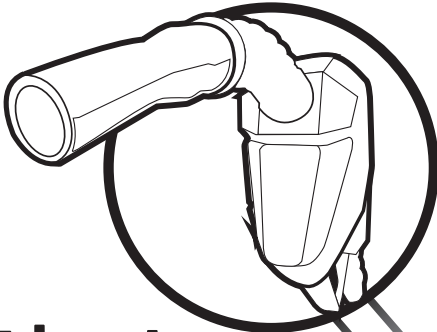

**Ethanol**  
**Biodiesel**  
**Jet Fuel**  
**Diesel**  
**Gasoline**

**Electricity**

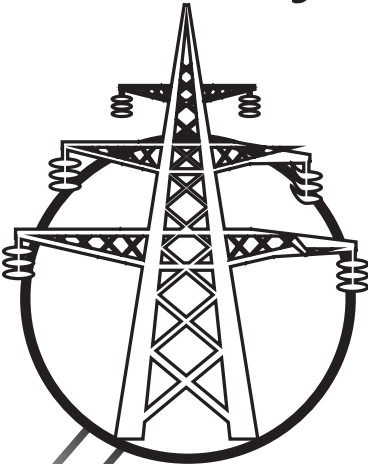

**BIOMASS**

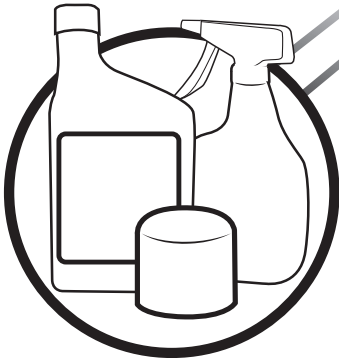

**Products**

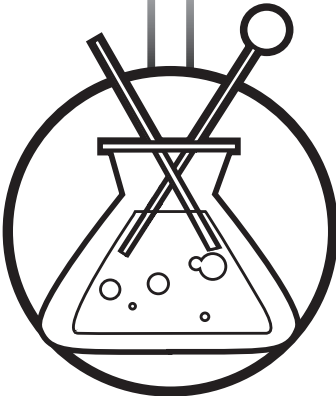

**Chemicals**

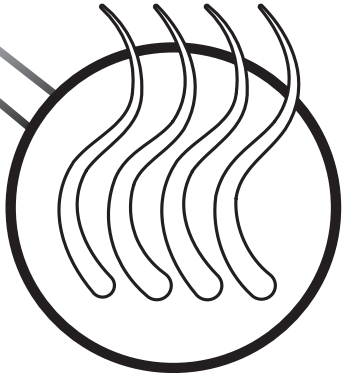

**Heat & Steam**

# Where can Biofuels be Used?

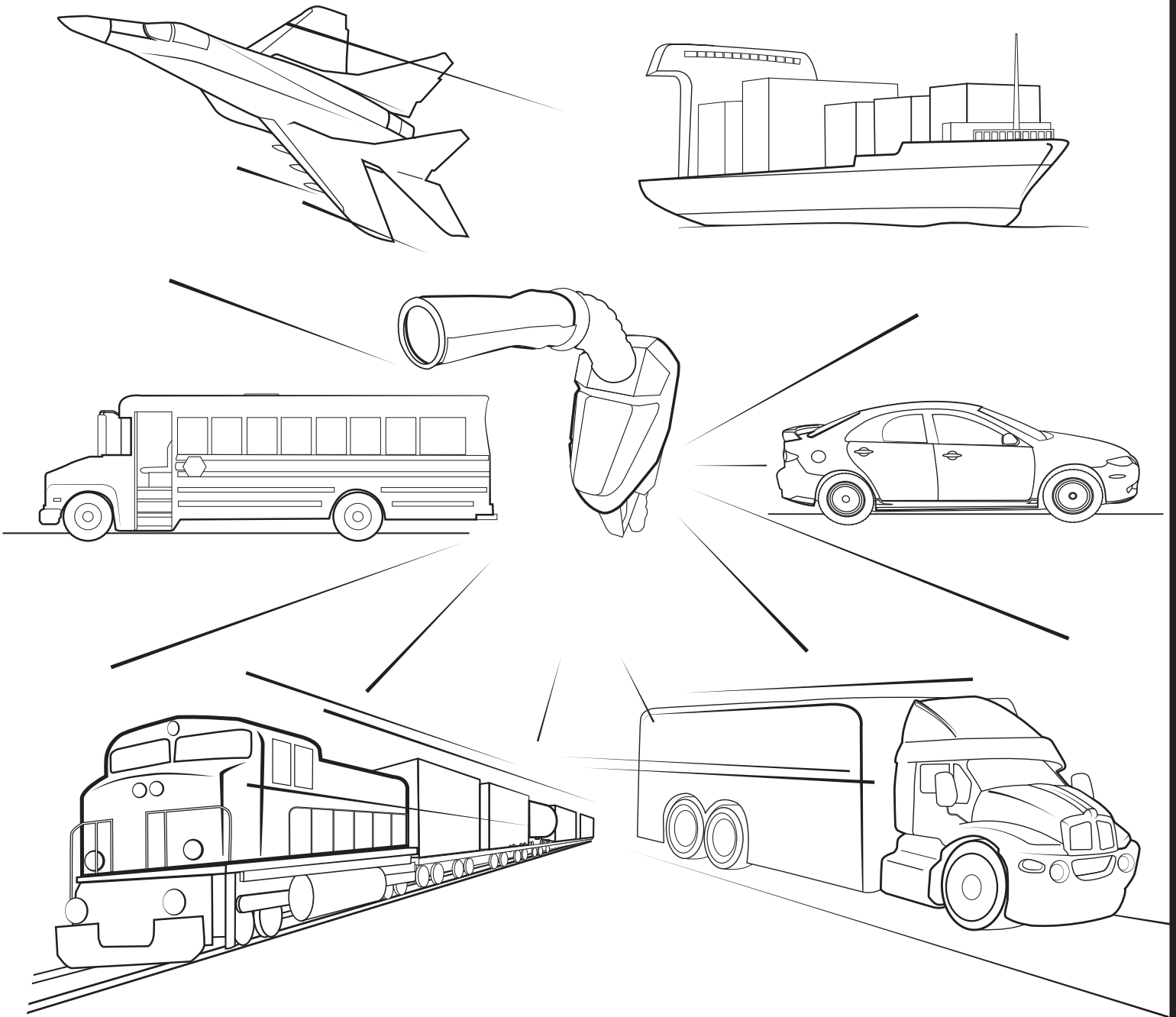

**Biofuels can be used in airplanes, ships, cars, trucks, buses, and trains. Have you noticed fuel at most gas stations contains some ethanol?**

# Ethanol is a Biofuel

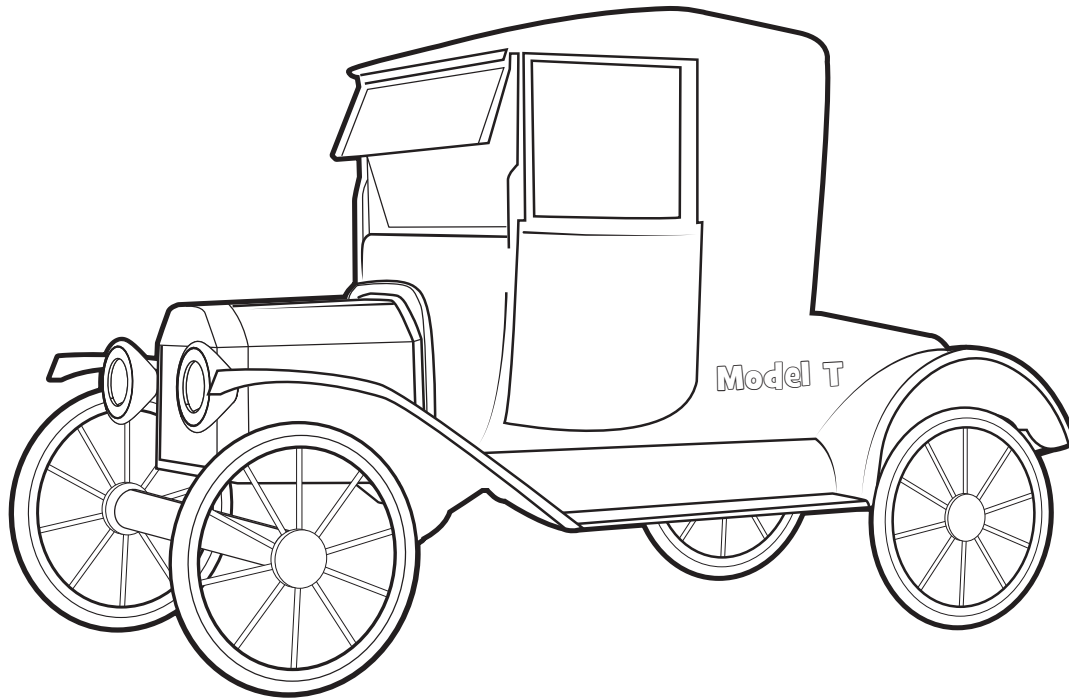

**In 1908, Ford Motor Company's first car used ethanol made from corn.**

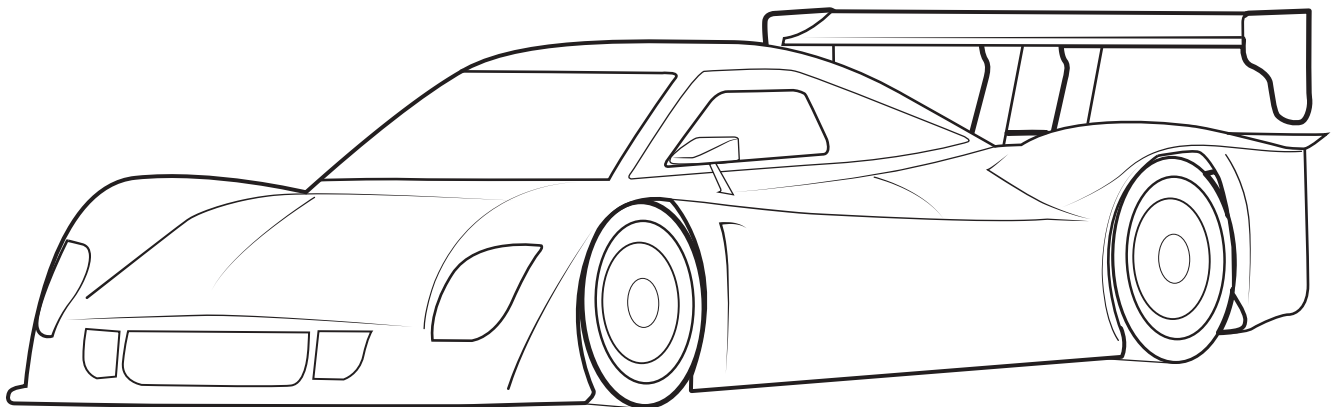

**Today, race cars can run on ethanol made from biomass.**

# Biofuel: From Field to Fuel Pump

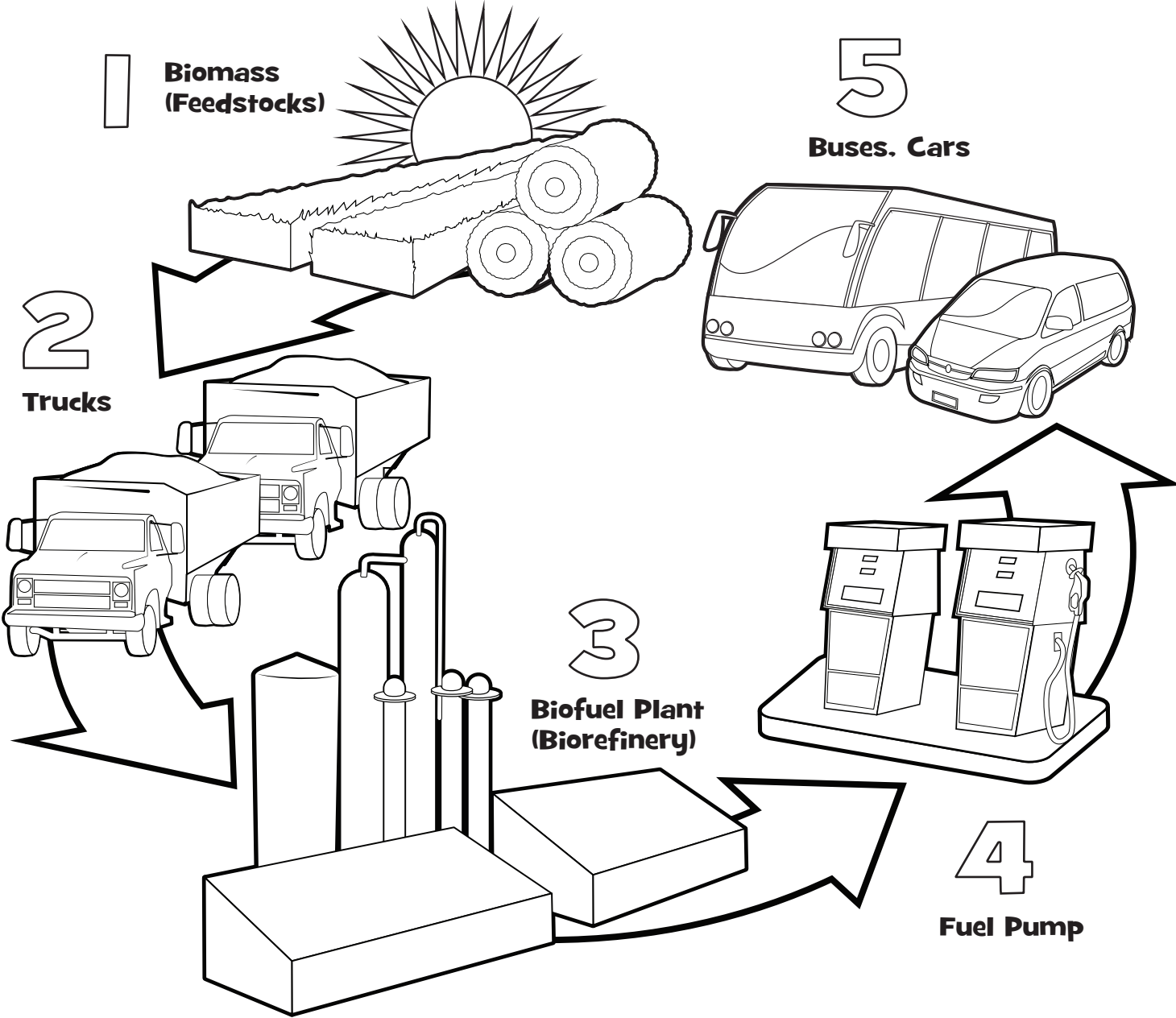

**Plant-based biomass feedstocks include cornstalks, grasses, trees, and waste.**



# How is Biomass Processed?

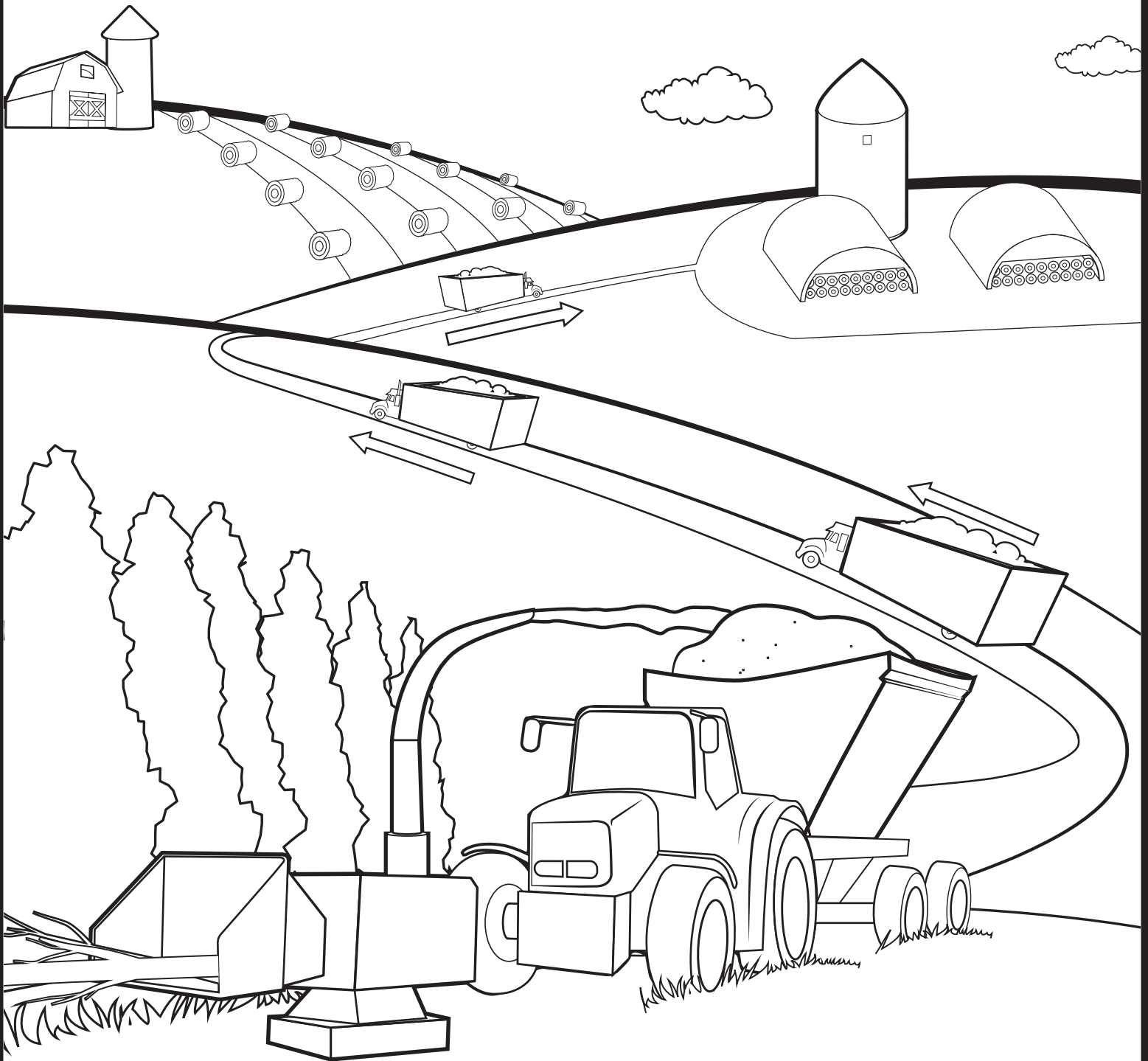

**Plant-based renewable biomass is harvested, chopped into small pieces, or rolled into bales. Processed biomass is transported to a storage site at a biofuel plant or biorefinery.**



# How Does a Biorefinery Operate?



**Processed biomass is treated with heat and chemicals.**

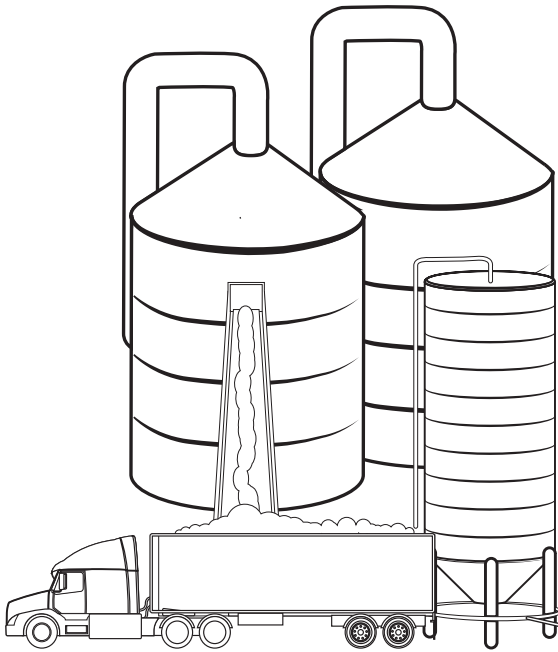

**2**

**Enzymes break down cellulose into sugar**

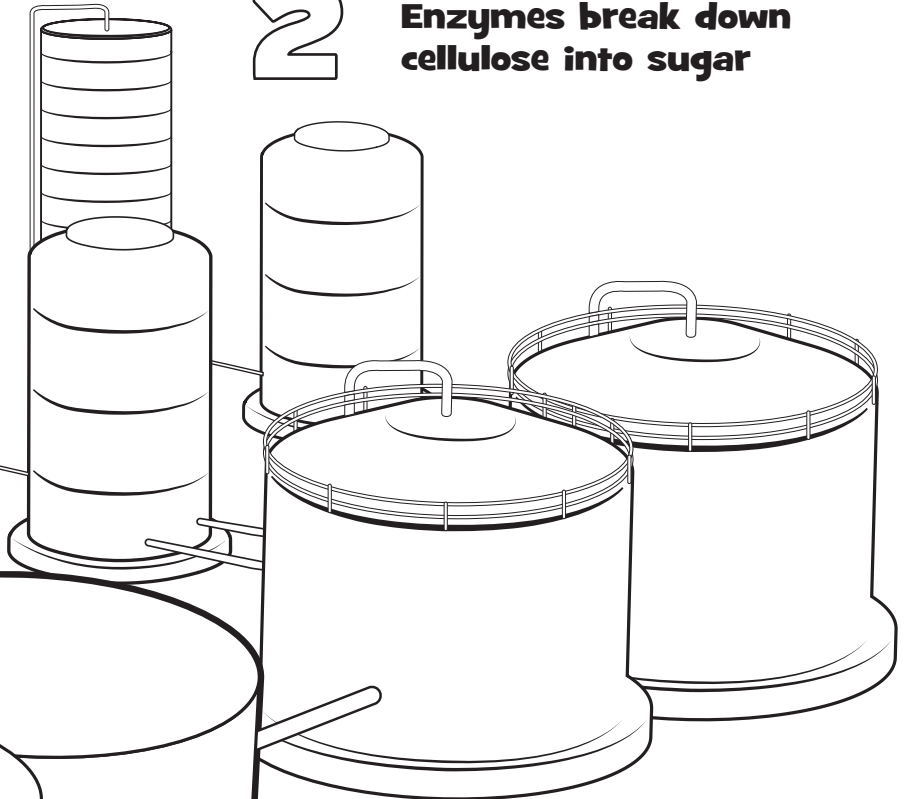

**3**

**Microbes ferment sugar into ethanol**

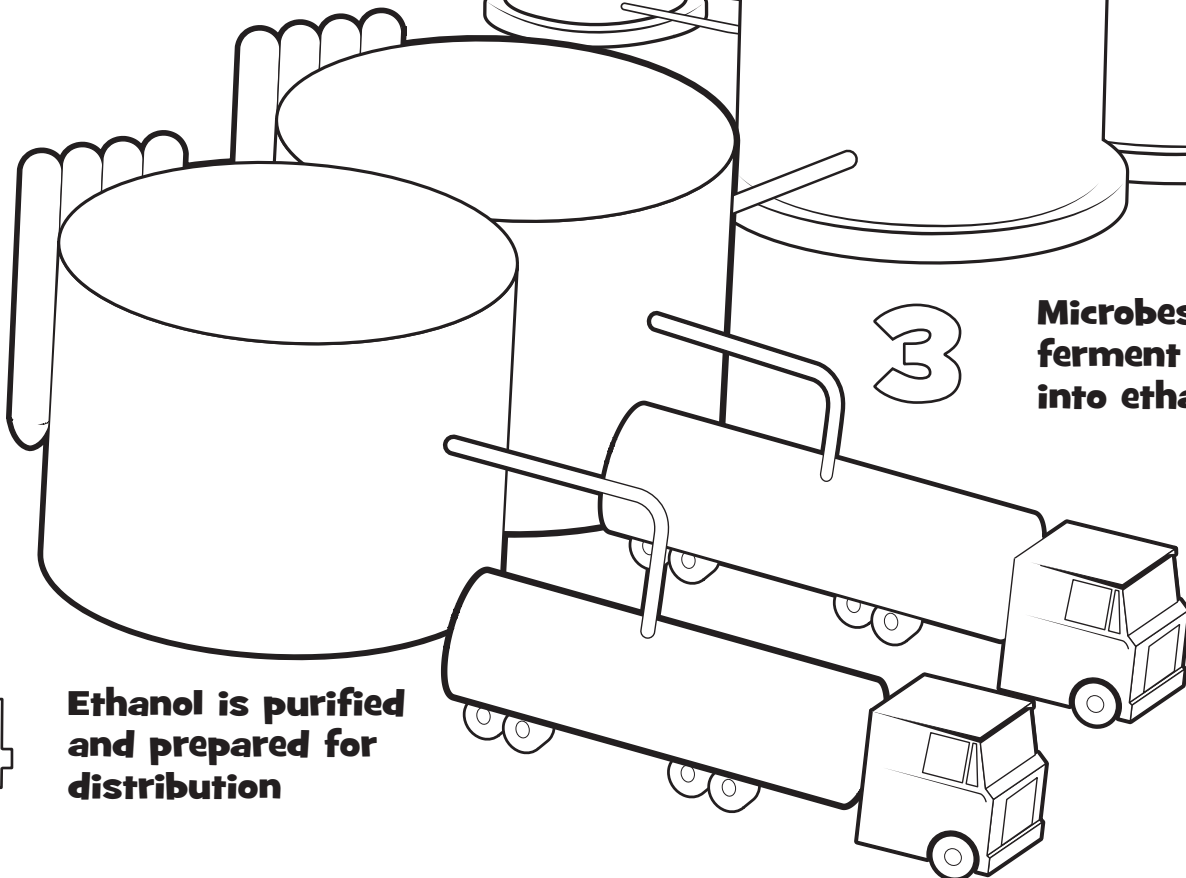

**4**

**Ethanol is purified and prepared for distribution**

# Make the Biofuels Connection

Draw a line connecting the feedstock with its name.

**Corn stover**

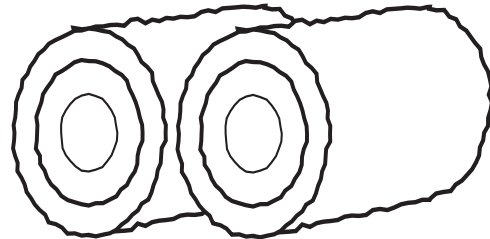

**Bales**

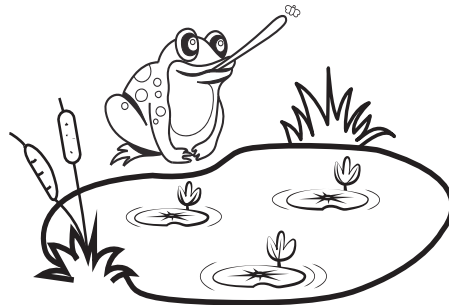

**Algae**

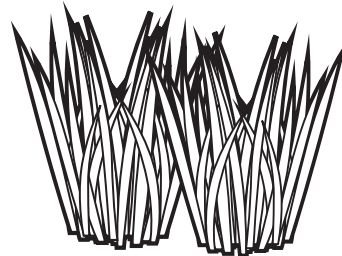

**Switchgrass**



# Biomass Crossword Puzzle

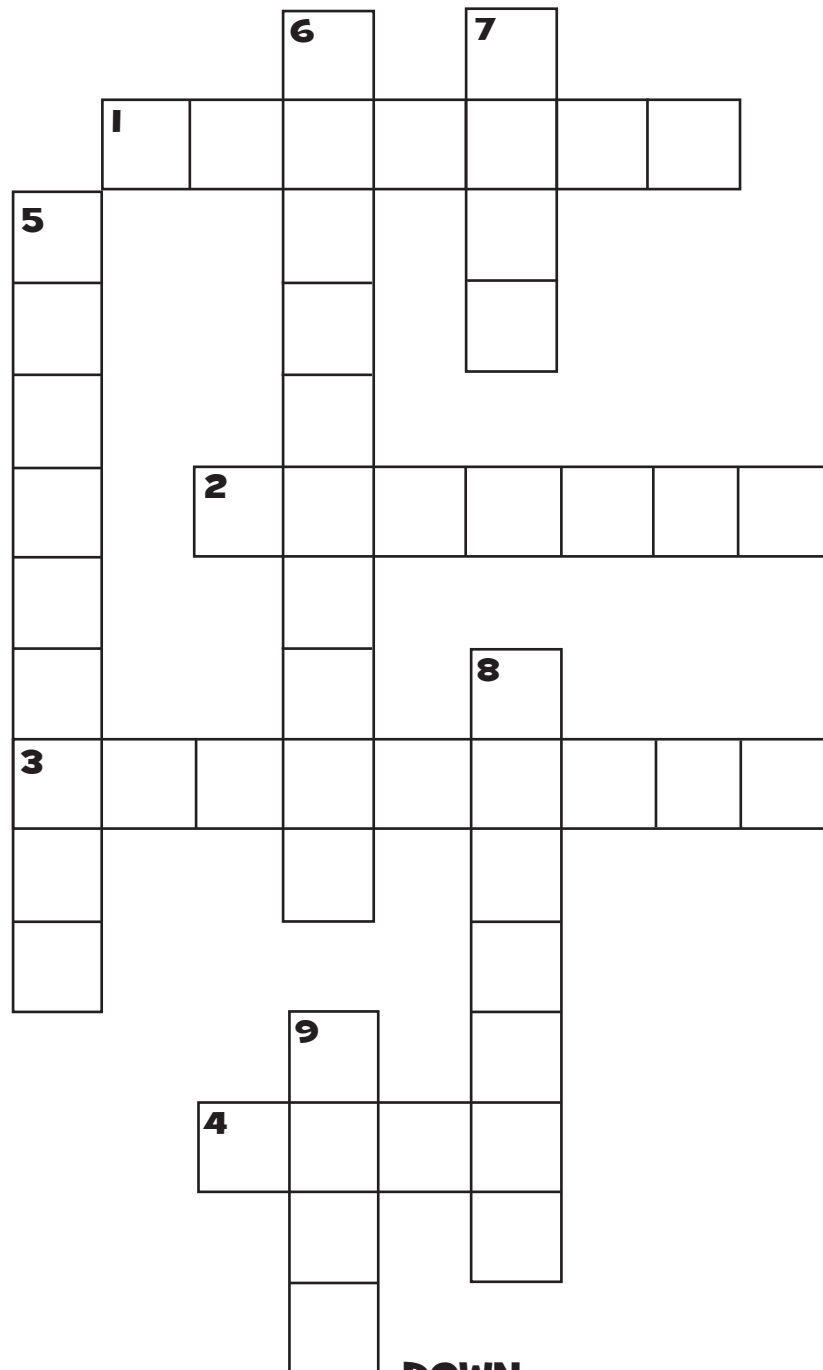

## ACROSS

1. Plants or trees for energy
2. A fuel made from biomass
3. Biomass is \_\_\_\_\_ because it can be regrown
4. What can be powered by biofuels?

## DOWN

5. Energy produced from plant-based materials
6. Crop waste that can be used to make biofuel
7. Rolled up corn stover
8. Seasonal collection of crops
9. Where biomass feedstocks can be grown?

# Find the Way to the Fuel Pump

Find your way through the maze.

**Start**

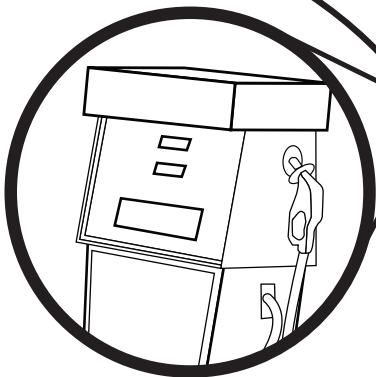
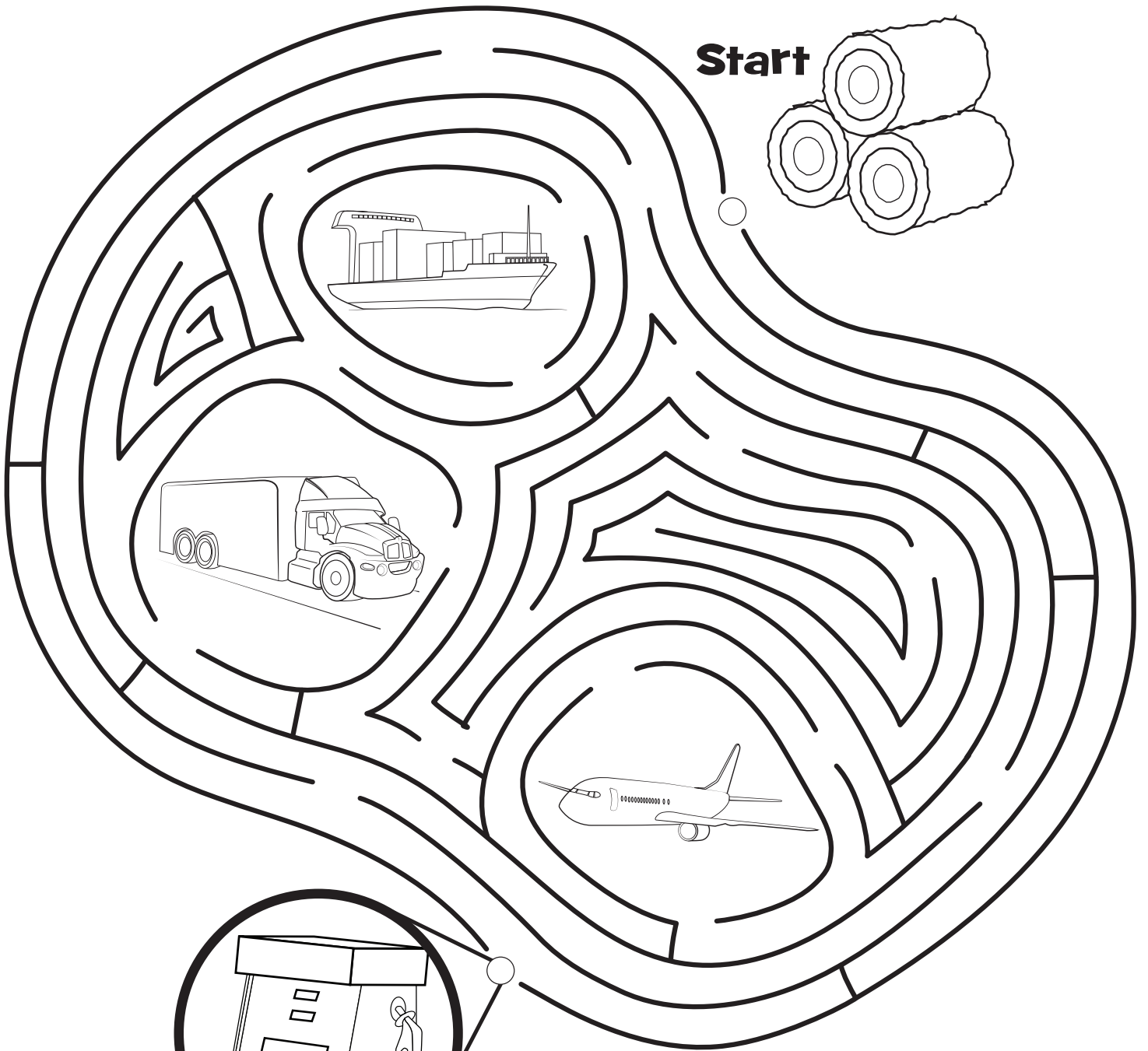
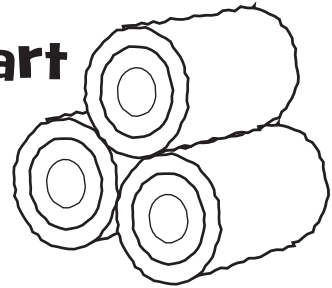

**Finish**

# Bioenergy Word Search

Find these words:

Algae

Bioenergy

Biofuel

Biomass

Biorefinery

Clean

Ethanol

Farm

Feedstock

Forest

Fuel

Green

Natural

Renewable

Switchgrass

Transportation

B Y F O R E S T G O F A R M C  
U I B I O F U E L X Q N P D B  
C I O S G E P Q W H V A D R S  
S B O R P R T F A R B T K E W  
X I G Z E Y M H T F J U S N I  
R O F R F F W Q A B T R U E T  
U E V R E U I D Y N I A N W C  
O N J G R E E N P N O L E A H  
D E R G S H N L E G M L F B G  
K R B Q A N A K L R T V I L R  
Q G X R C B I T V A Y S K E A  
T Y I B I O M A S S V G D F S  
G F S C L E A N J A L G A E S  
T R A N S P O R T A T I O N U  
E D T K F E E D S T O C K W I

# Some Words to Learn

**Harvesting:** Only an appropriate amount of biomass is removed to ensure the process is sustainable and the soil health is maintained.

**Corn Stover:** Stalks, leaves, and cobs that remain after removal of corn.

**Bale:** Harvested corn stover, either round or square shaped.

**Cellulose:** Main component of plant cell walls.

**Algae:** Plantlike small aquatic organisms that convert sunlight into energy – the green stuff in ponds or seaweeds in oceans or lakes. Most algae grow in freshwater or seawater.

**Biodiesel:** A renewable fuel that can be made from vegetable oils, animal fats, or recycled restaurant grease. For example, lipids, or oils, can be extracted from the walls of the algae cells and turned into biodiesel fuel.

**Municipal Solid Waste (MSW):** Trash or garbage, such as everyday items we use and then throw away, can be converted to a clean gas by using heat. With chemical processes, gas is turned into liquid alcohol fuels.

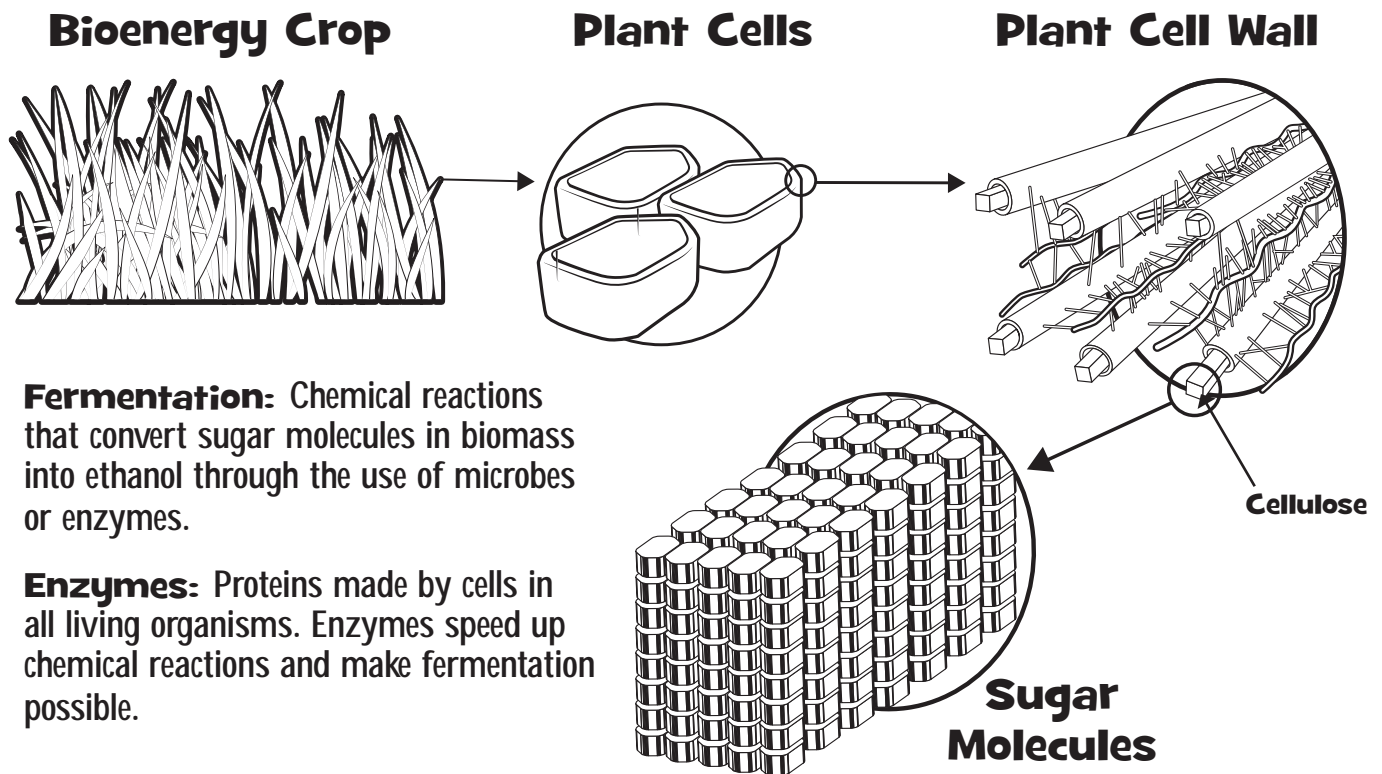

**Fermentation:** Chemical reactions that convert sugar molecules in biomass into ethanol through the use of microbes or enzymes.

**Enzymes:** Proteins made by cells in all living organisms. Enzymes speed up chemical reactions and make fermentation possible.

# Solutions

## ACROSS

- |                                               |           |
|-----------------------------------------------|-----------|
| 1. Plants or trees for energy                 | Biomass   |
| 2. A fuel made from biomass                   | Ethanol   |
| 3. Biomass is _____ because it can be regrown | Renewable |
| 4. What can be powered by biofuels?           | Cars      |





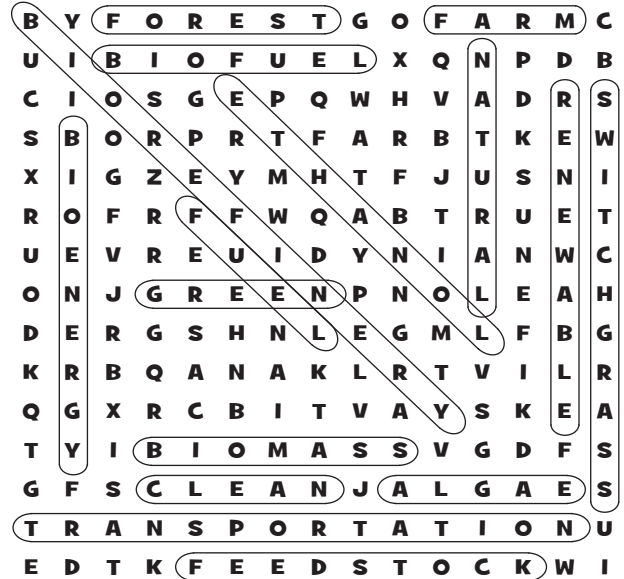

## DOWN

- |                                                |             |
|------------------------------------------------|-------------|
| 5. Energy produced from plant-based materials  | Bioenergy   |
| 6. Crop waste that can be used to make biofuel | Corn stover |
| 7. Rolled up corn stover                       | Bale        |
| 8. Seasonal collection of crops                | Harvest     |
| 9. Where biomass feedstocks can be grown?      | Farm        |





# Energy Literacy Principles

- 1** Energy is a physical quantity that follows precise natural laws. 
- 2** Physical processes on Earth are the result of energy flow through the Earth system. 
- 3** Biological processes depend on energy flow through the Earth system. 
- 4** Various sources of energy can be used to power human activities, and often this energy must be transferred from source to destination. 
- 5** Energy decisions are influenced by economic, political, environmental, and social factors. 
- 6** The amount of energy used by human society depends on many factors. 
- 7** The quality of life of individuals and societies is affected by energy choices. 

## U.S. Department of Energy

Office of Energy Efficiency and Renewable Energy  
[www.energy.gov/eere/education/teach-and-learn](http://www.energy.gov/eere/education/teach-and-learn)

## Energy Information Administration

[www.eia.gov/kids/](http://www.eia.gov/kids/)

## Energy Star Kids

<http://www.energystar.gov/kids>



This coloring and activity book is developed as part of OPERATION BioenergizeME initiative of the Bioenergy Technologies Office. BioenergizeME is an education and workforce development base camp for students and educators and anyone seeking to better understand the promises and challenges in developing a thriving bioeconomy.