

Final Report of the Mid-Atlantic Marine Wildlife Surveys, Modeling, and Data: Workshop to Establish Coordination & Communication

Appendix C: Compendium of Pre-Workshop Answers for Mid-Atlantic Survey & Modeling Efforts

July 2013

Appendix C: Compendium of Pre-Workshop Answers¹

Mid-Atlantic Survey & Modeling Efforts

Prepared by Participants in Advance of:

**Mid-Atlantic Marine Wildlife Surveys, Modeling and Data: Workshop to
Establish Coordination & Communication**

¹ These responses were provided by workshop participants in advance of the workshop. This appendix records the verbatim responses of participants.

Table of Contents

SURVEYS

Aerial Surveys of Seabirds South of Martha’s Vineyard and Nantucket, Massachusetts.....	59
AMAPPS NMFS Shipboard and Aerial Surveys.....	61
Atlantic Coast Wintering Sea Duck Survey and AMAPPS Marine Bird Surveys Broadscale Seabird Surveys of the NW Atlantic, Maine to Cape Hatteras	71
Broadscale Seabird Surveys of the NW Atlantic, Maine to Cape Hatteras	73
Cape Hatteras AFAST Aerial Survey	75
Determining Offshore Use of Diving Bird Species in Federal Waters of the Mid-Atlantic U.S. Using Satellite Tracking.....	78
Mid-Atlantic Right Whale Aerial Surveys	84
Modeling Wildlife Densities and Movements Across Spatial and Temporal Scales on the Mid-Atlantic Outer Continental Shelf	87
New Jersey Ocean/Wind Power Ecological Baseline Studies	98
Northeast Large Pelagics Survey Collaborative	105
Rhode Island Ocean Special Area Management Plan (OSAMP)-Avian Surveys.....	116
VA Whale Migration Corridors for Marine Spatial Planning.....	124
VA/MD Sea Turtle Research & Conservation Initiative.....	127
Wallops Island and Onslow Bay USWTR Aerial Survey	133
MODELING EFFORTS	
AMAPPS	137
Atlantic Coast Wintering Sea Duck Survey.....	142
Duke Cetacean Habitat Models for US Atlantic (SERDP/NASA).....	144
New Jersey Ocean/Wind Power Ecological Baseline Studies	148
NOAA/NOS/NCCOS Biogeography Branch Mid-Atlantic Seabird Predictive Modeling (BOEM/USGS)	153
North Carolina State University Collaborative Projects.....	160
Rhode Island Ocean Special Area Management Plan (OSAMP)-Avian Surveys.....	164
SUPPLEMENTAL DATA SYSTEMS INFORMATION	
OBIS-USA Summary Statistics	170

SURVEYS

Aerial Surveys of Seabirds South of Martha's Vineyard and Nantucket, Massachusetts

1. Project name

Aerial Surveys of Seabirds South of Martha's Vineyard and Nantucket, Massachusetts
City University of New York

Funded by Massachusetts Clean Air Center

2. Objectives

Quantify abundance and distribution of seabirds

3. Proposed data products

Annual report will be produced at end of project in 2014.

4. Area covered and proposed (or actual) track lines (append map)

Map attached

5. Dates of past, present, and future surveys

16 surveys, October 2011 - October 2012

6. Data collection methods (append protocol document)

We use strip transects collected from aircraft. We count all seabirds and marine mammals. No environmental data, apart from general weather conditions.

7. Data analysis methods

Basic statistics - see attached papers.

8. Where and how data will be stored (include software/format(s) used for data storage and access)?

Data will be stored in USGS database, as well as at CUNY lab and at Mass CEC

9. **How often will data be updated and how will updated data/history of updates be made available?**

Data will be updated after each survey.

10. **Contact info, including website if applicable**

veitrr2003@yahoo.com, simonperkins2010@yahoo.com, tim.p.white@gmail.com

11. **Bibliographic resources for methodology if appropriate**

Veit, R.R., P. Pyle and J.A. McGowan. 1996. Ocean warming and long-term change in pelagic bird abundance within the California Current System. *Marine Ecology Progress Series* 139: 11-18.

Veit, R.R., J.A. McGowan, D.G. Ainley, T.R. Wahl, and P. Pyle. 1997. Apex marine predator declines 90% in association with changing oceanic climate. *Global Change Biology* 3: 23-28.

Veit, R.R., E.D. Silverman, and I. Everson. 1993. Aggregation patterns of pelagic predators and their principal prey, Antarctic krill, near South Georgia. *Journal of Animal Ecology* 62: 551-564.

AMAPPS NMFS Shipboard and Aerial Surveys

1. Project name:

AMAPPS NMFS shipboard and aerial surveys

2. Objectives:

The primary objective of this series of surveys is to collect data and samples to improve the assessment of marine mammal stocks (in particular the abundance, stock structure and habitat usage), as required under the Marine Mammal Protection Act (MMPA) and to support the spatial-temporal assessment of the abundance, habitats, and distributions of cetaceans, sea turtles and sea birds within U.S. waters.

The surveys since 2010 were conducted as part of the Atlantic Marine Assessment Program for Protected Species (AMAPPS) initiative. Northern waters are covered by the Northeast Fisheries Science Center (NEFSC) and southern waters are covered by the Southeast Fisheries Science Center (SEFSC).

3. Proposed data products:

1) Seasonal abundance estimates of as many species of cetaceans, sea turtles and sea birds as the data allow.

2) Spatially explicit density distribution maps that incorporate habitat factors.

4. Area covered and proposed (or actual) track lines (append map):

Aerial surveys are generally flown from the shoreline to the 200 or 2000 m depth contours from Florida to Nova Scotia, Canada. Shipboard surveys generally start at the offshore border of the aerial surveys and extend to the U.S. EEZ or slightly beyond (Figure 1). Shipboard surveys have only been conducted in the summer (Jun – Aug), while the aerial surveys are intended to occur each season.

5. Dates of past, present and future surveys:

Previous NMFS AMAPPS surveys are:

- a) Summer: Jul – Aug 2010 aerial survey
- b) Winter: Jan – Mar 2011 aerial survey
- c) Summer: Jun – Aug 2011 aerial and shipboard surveys
- d) Spring: Apr – May 2012

Future NMFS AMAPPS surveys are proposed to be conducted during:

- a) Fall: Sep – Nov 2012 aerial survey
- b) Winter: Jan – Mar 2013 aerial survey
- c) Summer: Jun – Aug 2013 shipboard and aerial surveys
- d) Spring: Apr – May 2014 aerial survey
- e) Fall: Sep – Nov 2014 aerial survey

Other similar surveys conducted by the NEFSC and SEFSC are depicted in Figures 2 – 3 and Table 1.

6. Data collection methods (append protocol document)

- a. Species of focus**
- b. Data collection methods, including type of platform, speed, altitude, and weather condition limits.**
- c. Associated environmental data collected**

Aerial surveys

Target species: Cetaceans, seals, sea turtles, ocean sunfish and basking sharks. Other sharks and fish are recorded opportunistically.

Data collection methods: Line-transect methods that include the estimation of observer perception bias. In particular, the two independent team method (Laake and Borchers 2004) and the Hiby circle-back method (Hiby and Lovell 1998; Hiby 1999) have been used. Surveys are conducted using Twin Otter aircraft (have at least two large bubble windows) and travel at about 110 knots at 600 ft above the water surface in sea state conditions of 4 or below. See Palka 2012 for a more detailed description of the data collection protocols (attached).

Currently, to correct line transect abundance estimates of loggerhead sea turtles for availability bias, separate projects are being conducted where loggerheads are tagged to collect information on dive and surface times (NEFSC 2011).

Environmental data collected from the sighting platform: GPS location, sea surface temperature (during some years), Beaufort sea state, water turbidity, cloud cover, and glare severity.

Shipboard surveys

Target species: Cetaceans, sea birds, seals, sea turtles, ocean sunfish and basking sharks. Other sharks and fish are recorded opportunistically.

Data collection methods: The two-independent team line-transect method that allows the estimation of observer perception bias has been used. Surveys are conducted using NOAA large ships (100 – 300 ft long), where both of the observation platforms are 11 or more meters above the sea surface, and surveys are conducted while traveling at about 10 – 12 knots in sea state conditions of 4 or below. See Palka 2011 for a more detailed description of the data collection protocols (attached).

Environmental data collected: GPS location, sea surface temperature, Beaufort sea state, cloud cover, glare severity, wind speed, samples of sub-surface temperatures and depths (using CTDs and XBTs), and on some surveys the following are also collected: plankton samples (using bongo nets and a visual plankton recorder), fish and other trophic level information (using backscatter active acoustic scientific echosounders), and passive acoustic detections of vocalizations of cetaceans and other animals.

For both aerial and shipboard surveys:

Environmental data collected via satellite or other sources include the following: sea surface temperature, chlorophyll, water depth, distance from shore, temperature and chlorophyll frontal intensities, distance to a temperature and chlorophyll front, and sediment type.

Depth specific environmental data collected from ocean models include: mixed layer depth, salinity, sea surface height, and vertical velocity.

7. Data analysis methods

Previously, estimates of abundance have been based on the independent observer approach assumes point independence (Laake and Borchers 2004) and was calculated using either the mark-recapture distance sampling (MRDS) option in the computer program Distance (version 6.0, release 2, Thomas *et al.* 2009) or using the direct duplicate estimation method (Palka 1995) which incorporates results from the computer program Distance. A recent example is the abundance estimate of loggerhead sea turtles, which corrects for perception and availability biases (NEFSC 2011).

8. Where and how data will be stored (include software/format(s) used for data storage and access)?

The data already collected are, or will be, archived in Oracle on the NEFSC server. Data can be accessed by contacting me (see number 10 below). A list of the sighting and effort variables are detailed in Table 2.

Sighting and effort data from one observation team of the shipboard and aerial data are available at OBIS-SEAMAP for some years (<http://seamap.env.duke.edu/>).

9. How often will data be updated and how will updated data/history of updates be made available?

Data in the Oracle archive database are updated after new dataset is collected, checked, and usually after preliminary abundances have been estimated.

10. Contact info, including website if applicable:

Dr. Debra Palka
Northeast Fisheries Science Center
166 Water St.
Woods Hole, MA 02543
Debra.palka@noaa.gov

Website of NEFSC cruise reports:

<http://www.nefsc.noaa.gov/read/protspg/mainpage/surveys/aerialsurveys.htm>

11. Bibliographic resources for methodology if appropriate

Buckland ST, Anderson DR, Burnham KP, Laake JL, Borchers DL, Thomas L. 2004. *Advanced Distance Sampling: Estimating Abundance of Biological Populations*. Oxford University Press, New York, NY. 416 pp.

Hiby AR, Lovell P. 1998. Using aircraft in tandem formation to estimate abundance of harbor porpoise. *Biometrics* 54:1280-1289.

Hiby AR. 1999. The objective identification of duplicate sightings in aerial survey for porpoise. In: Garner, GW, Amstrup SC, Laake JL, Manly BFJ, McDonald LL, Robertson DG, editors. *Marine mammal survey and assessment methods*. Rotterdam (Netherlands): A.A. Balkema. p. 179-189.

Laake JL, Borchers DL. 2004. Methods for incomplete detection at distance zero. In: *Advanced Distance Sampling*. Buckland, ST, Anderson, DR, Burnham, KP, Laake, JL, and Thomas, L. (eds.). Oxford University Press, 411 pp.

Northeast Fisheries Science Center. 2011. Preliminary summer 2010 regional abundance estimate of loggerhead turtles (*Caretta caretta*) in northwestern Atlantic Ocean continental shelf waters. US Dept Commer, Northeast Fish Sci Cent Ref Doc. 11-03; 33 p. Available from: National Marine Fisheries Service, 166 Water Street, Woods Hole, MA 02543-1026, or online at <http://www.nefsc.noaa.gov/nefsc/publications/>

Palka, D. 2012. Northeast aerial AMAPPS survey data collection procedures (attached)

Palka, D. 2011. AMAPPS – NE 2011: Information for NE shipboard observers (attached)

Palka, D. 2000. Abundance of the Gulf of Maine/Bay of Fundy harbor porpoise stock based on shipboard and aerial surveys in 1999. *NMFS Northeast Fisheries Science Center Reference Document 00-07*.

Palka, D. 1995. Abundance estimate of the Gulf of Maine harbor porpoise. Pgs 27-50 in A. Bjorge and G.P. Donovan, eds. *Biology of Phocoenids. Reports of the International Whaling Commission*. Special Issue 16.

Palka, D. 1995. Influences on spatial patterns of Gulf of Maine harbor porpoises. pp. 69-75 In: A.S. Blix, L. Walløe and Ø. Ulltang (eds.) *Whales, seals, fish and man*. Elsevier Science B.V. The Netherlands.

Palka, D. 1996. Effects of Beaufort sea state on the sightability of harbor porpoises in the Gulf of Maine. *Rep. Int. Whal. Commn* 46: 575-582.

Scheidat M, Gilles A, Kock K-H, Seibert U. 2008. Harbour porpoise *Phocoena phocoena* abundance in the southwestern Baltic Sea. *Endangered Species Research* 5:215-223.

Thomas L, Laake JL, Rexstad E, Strindberg S, Marques FFC, Buckland ST, Borchers DL, Anderson DR, Burnham KP, Burt ML, Hedley SL, Pollard JH, Bishop JRB, Marques TA. 2009. Distance 6.0. Release 2. Research Unit for Wildlife Population Assessment, University of St. Andrews, UK. <http://www.ruwpa.st-and.ac.uk/distance/>

12. Papers published based on this work and associated citation information. If possible, please attach the paper with your response.

Northeast Fisheries Science Center. 2011. Preliminary summer 2010 regional abundance estimate of loggerhead turtles (*Caretta caretta*) in northwestern Atlantic Ocean continental shelf waters. US Dept Commer, Northeast Fish Sci Cent Ref Doc. 11-03; 33 p. Available from: National Marine Fisheries Service, 166 Water Street, Woods Hole, MA 02543-1026, or online at <http://nefsc.noaa.gov/publications/crd/crd1103/>

Northeast Fisheries Science Center (NEFSC) and Southeast Fisheries Science Center (SEFSC). 2010. *Annual Report to the Inter-Agency Agreement M10PG00075/0001: A Comprehensive Assessment of Marine Mammal, Marine Turtle, and Seabird Abundance and Spatial Distribution in in US Waters of the western North Atlantic Ocean*. Available online at: http://www.nefsc.noaa.gov/read/protsp/mainpage/AMAPPS/docs/Final_2010AnnualReportAMAPPS_19Apr2011.pdf.

Figure 1. Tracklines completed during the summer (Jun-Aug) 2011 AMAPPS aerial and shipboard surveys conducted by the NEFSC (NE) and SEFSC (SE).

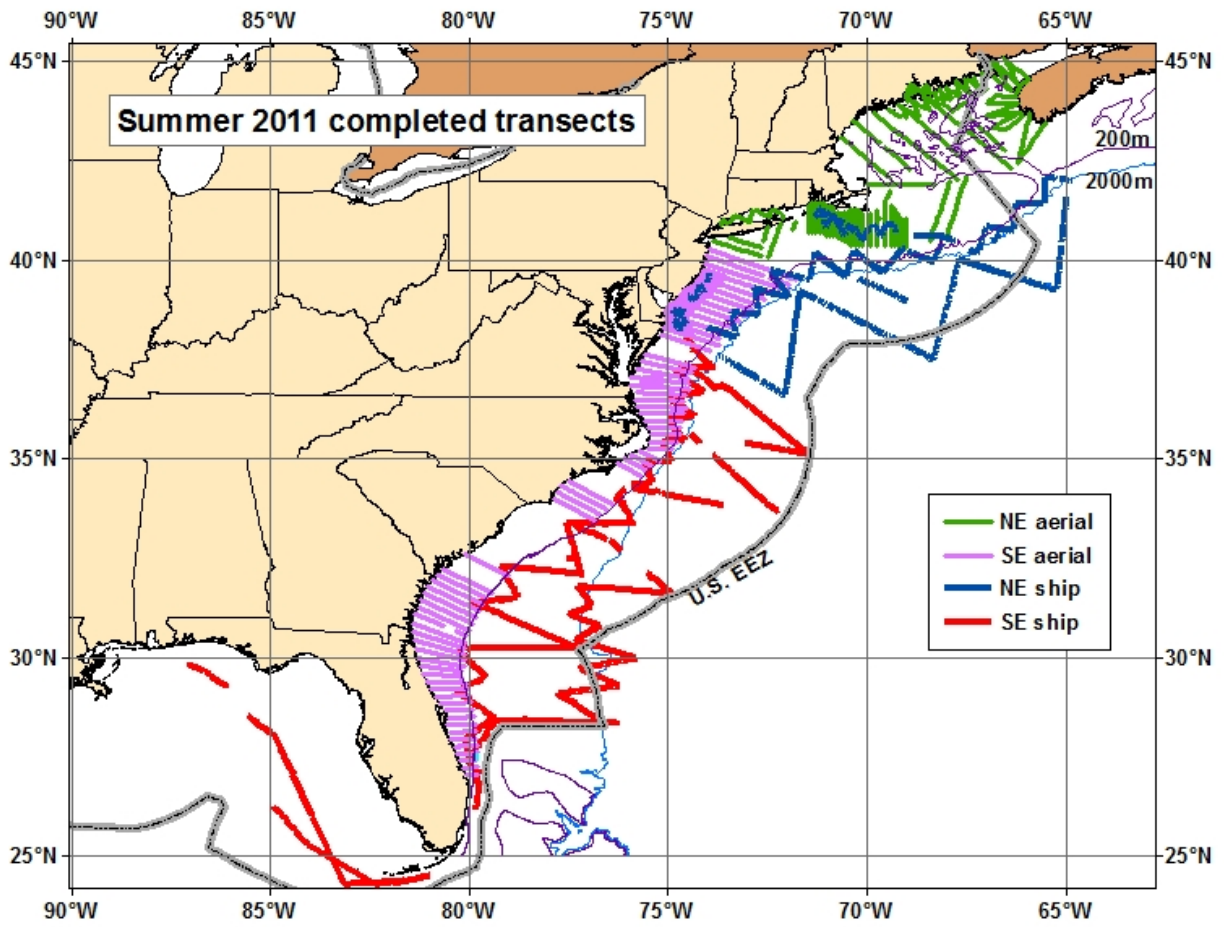

Figure 2. Aerial line-transect surveys conducted by the Northeast and Southeast Fisheries Science Centers before 2009. Brief survey descriptions are provided in Table 1.

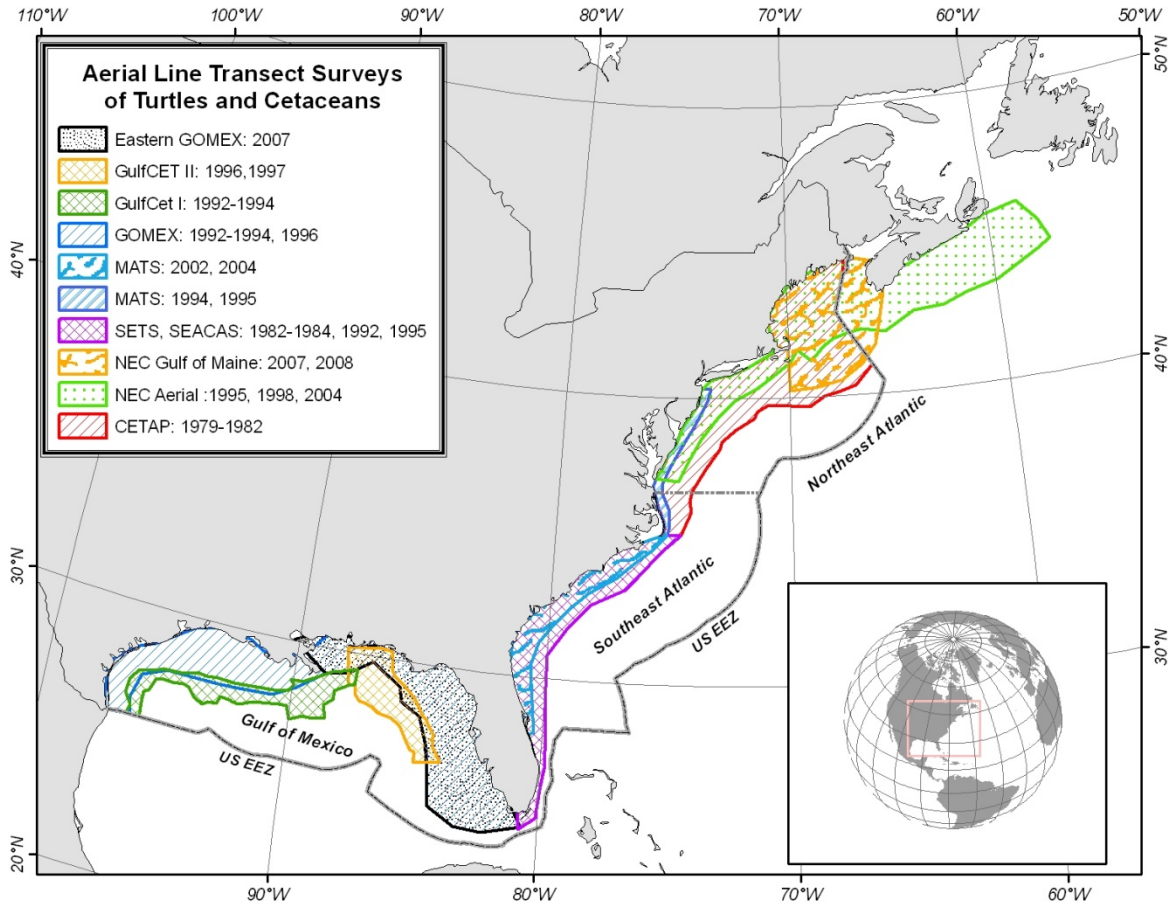

Figure 3. Shipboard line-transect surveys conducted by the Northeast and Southeast Fisheries Science Centers before 2009. Brief survey descriptions are provided in Table 1.

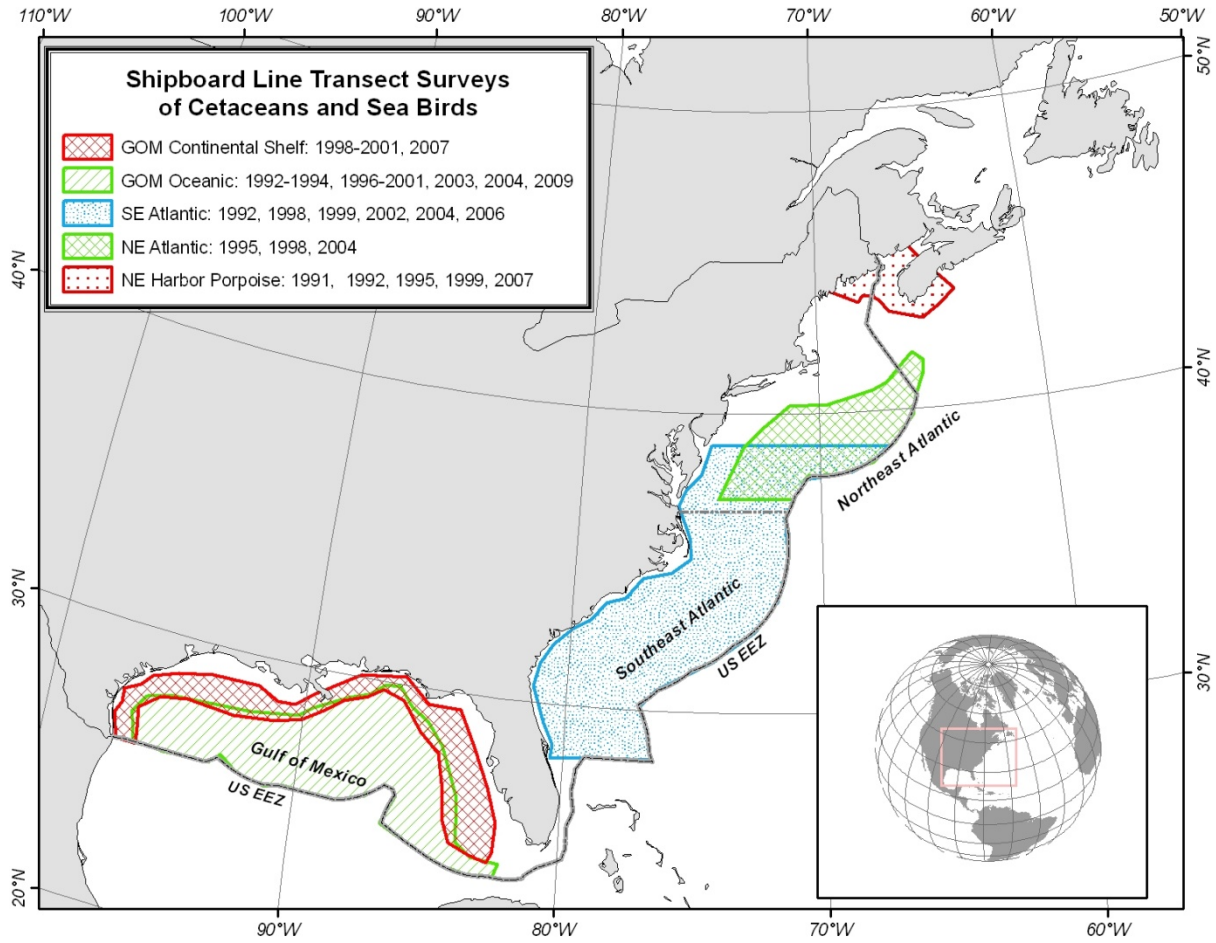

Table 1. Line-transect surveys conducted by the Southeast Fisheries Science Center and Northeast Fisheries Science Center before 2009.

Survey	Years	Season(s)	Region	Offshore Range
<i>Aerial Surveys</i>				
CETAP	1979 - 1982	Win, Spr, Sum, Fal	NE Atlantic	Shore to 2,000 m isobaths
NEC Aerial	1995, 1998, 2004, 2010, 2011	Sum	NE Atlantic (to Scotian Shelf in 1998)	Shore to Shelf Break (~200 m isobaths)
NEC Gulf of Maine	2006, 2007, 2008	Sum	Gulf of Maine	Gulf of Maine and Georges Bank
SETS	1982-1984	Win, Spr, Sum, Fal	SE Atlantic	Shore to Gulf Stream Edge
SECAS	1992, 1995	Win	SE Atlantic	Shore to Gulf Stream Edge
MATS	1994, 1995	Sum	NE Atlantic	Shore to 25m depth
MATS	2002, 2004	Sum, Win	SE/NE Atlantic	Shore to 40m depth
<i>Vessel Surveys</i>				
NE Harbor Porpoise	1991, 1992, 1995, 1999, 2007	Sum	Gulf of Maine	
NE Atlantic	1995, 1998, 2004	Sum	NE Atlantic	Shelf break to U.S. EEZ
SE Atlantic	1992, 1998, 1999	Sum	SE Atlantic	Continental shelf to U.S. EEZ
SE Atlantic	2002	Spr	SE Atlantic	Continental shelf to U.S. EEZ
SE Atlantic	2004, 2006	Sum	SE Atlantic	Shelf Break to U.S. EEZ

Table 2. List of variables in the sightings and effort Oracle tables.

<u>SIGHTINGS</u>	<u>EFFORT</u>
TRIPID	TRIPID
TEAM	DATETIMEEF
SIGHTNUM	TRANSECT
SIGHT_TYPE	LEG
SIGHTDATE	EVENT
LEG	ENDEVENTDATE
TRANSECT	LATBEG
SIGHTLAT	LONGBEG
SIGHTLON	LATEND
OBSERVER	LONGEND
CUE	STRATA
BEHAVIOR	LEGDISTNMI
SWIMDIR	SPEED
CALVES	COURSE
BEARING	GLAREWIDTH
RETICLE	GLAREMAGNITUDE
RADIALDIST	BEAUFORT
PERPDIST	COMMENTS
BINOTYPE	SUBJSTAR
SIZEBEST	SUBJPORT
SIZELOW	LEGTYP
SIZEHIGH	TURBIDITY
COMMENTS	
SPECIES	
DECANGLE	
LINETYPE	
ORIGSIGHTNUM	
CONFIDENCE	
GYRO	

Atlantic Coast Wintering Sea Duck Survey and AMAPPS Marine Bird Surveys

1. Project name

I am involved with both the FWS' effort to develop an Atlantic coast wintering sea duck survey and the AMAPPS marine bird survey effort through FWS/ACJV.

2. Objectives

The sea duck surveys have two distinct objectives: (1) to provide efficient estimates of wintering sea duck abundance with the potential to detect trends/substantial drops in abundance and to support harvest and habitat management, and (2) to provide information on regional distributions (regional abundance, annual variation in abundance, proportion of wintering population in region, etc.) and identify critical wintering areas for sea ducks. The focus is on 5 species: common eider, long-tailed duck, and black, surf, and white-winged scoters. As to the AMAPPS surveys, I am somewhat unclear as to what their objectives are. So, I will answer the remaining questions w/r/t the sea duck surveys.

3. Proposed data products

Models that provide the framework for regional and coast-wide abundance estimates with associated measures of precision. Abundance estimates for the 5 species of interest, and possibly also goldeneye, bufflehead, mergansers, and loons. A database of raw observations, including measures of effort, observation condition, and survey metadata.

4. Area covered and proposed (or actual) track lines (append map)

The experimental survey currently covers the U.S. coast from the Canadian border to the GA/FL state line. Transects are run east-west to the longer of 8 nm/16m depth, with some additional lines in areas important to sea ducks (CH, DE Bay, Nantucket Shoals, some additional length of proposed wind areas off MD/VA, etc.). Lines would likely be amended (shortened in some cases) in a final operational survey because they extend well beyond the offshore range of the five species of interest.

5. Dates of past, present and future surveys

Survey work was conducted in Jan-Mar 2008-11 with some limited work in 2012 and possibly 2013. Future surveys are not currently planned, as the experimental survey results and survey objectives are under review.

6. Data collection methods (append protocol document)

- a. Species of focus
- b. Associated environmental data collected.

7. Data analysis methods

See attached *draft* survey report. The report will be finalized in October 2012.

8. Where and how data will be stored (include software/format(s) used for data storage and access)?

The data are currently maintained by the Population and Habitat Assessment Branch, Division of Migratory Bird Management, USFWS in an Access database and will likely be added to/made available through the DMBM data center.

9. How often will data be updated and how will updated data/history of updates be made available?

This depends on if the survey is made operational and the agreed upon survey frequency.

10. Contact info, including website if applicable

11. Bibliographic resources for methodology if appropriate

12. Papers published based on this work and associated citation information. If possible, please attach the paper with your response.

Paper entitled "Fitting statistical distributions to sea duck count data: implications for survey design and abundance estimation" under review in *Stats Methodology* coauthored with Zipkin, Leirness, Kinlan, and O'Connell. Additional manuscripts are in preparation.

Broadscale Seabird Surveys of the NW Atlantic, Maine to Cape Hatteras

1. Project name

Broadscale Surveys of NW Atlantic Seabirds
City University of New York and US Fish and Wildlife Service
Funded by BOEM

2. Objectives

Quantify seasonal and yearly variability of seabird abundance off US East Coast

3. Proposed data products

Reports are generated annually. These include distributional maps and densities of most common species.

4. Area covered and proposed (or actual) track lines (append map)

Maine to Cape Hatteras, N.C. Stratified random sampling of stations. About three weeks to sample entire area. All inshore from continental slope.

5. Dates of past, present and future surveys

2007 to present (funded through 2014). Four to seven cruises per year.

6. Data collection methods (append protocol document)

We use a combination of line and strip (strip width = 300 m) transects. We count all species of birds and mammals. environmental data varies with cruise. We are implementing acoustic data on zooplankton (begun in 2011).

7. Data analysis methods

Basic statistical analysis. Time series methods for bird/plankton co-occurrence

8. Where and how data will be stored (include software/format(s) used for data storage and access)?

Data are stored at seabird database at USGS (Andrew Gilbert, Allen O'Connell)

9. How often will data be updated and how will updated data/history of updates be made available?

Data are updated after each cruise, so about 4 times per year.

10. Contact info, including website if applicable

Contact Richard Veit veitrr2003@yahoo.com

11. Bibliographic resources for methodology if appropriate

Camphuysen CJ, Garthe S (2004) Recording foraging seabirds at sea: standardised recording and coding of foraging behavior and multi-species foraging associations. *Atlantic Seabirds* 6: 1-32

Tasker, M.L., P.H. Jones, T. Dixon, and B.F. Blake. 1984. Counting seabirds at sea from ships: a review of methods employed and a suggestion for a standardized approach. *Auk* 101: 567-577.

12. Papers published based on this work and associated citation information. If possible, please attach the paper with your response.

No publications. Will attach 2010 annual report.

Cape Hatteras AFAST Aerial Survey

1. Project name:

Cape Hatteras AFAST aerial survey

2. Objectives

Estimate the distribution and abundance of cetaceans and sea turtles in this area of interest.

3. Proposed data products

4. Area covered and proposed (or actual) track lines (append map)

Boundaries of survey area are:

North: 36.12234, West: 75.95404, East: 74.33367, South: 34.315878

Map is attached

5. Dates of past, present and future surveys

Surveys from May 26, 2011 – Present

6. Data collection methods (append protocol document)

Aerial surveys consisted of 2-3 days of effort a month using a Cessna 337 Skymaster flying at 1000ft and 100 knts using standard distance sampling techniques. Observations from left and right observers are treated separately resulting in two strip-width datasets.

- a. Surveys targeted cetacean and sea turtle species inside the survey area.
- b. Also recorded cloud cover and Beaufort Sea State.

7. Data analysis methods

Density and abundance estimates are generated by the University of St Andrews, Scotland.

8. Where and how data will be stored (include software/format(s) used for data storage and access)?

Data is stored locally on the University of North Carolina Wilmington network.

Formats of data include excel spreadsheets, digital images are in standard JPEG format, Maps of sightings are in JPEG and also ArcGIS.mxd files.

9. How often will data be updated and how will updated data/history of updates be made available?

All data from this project is currently loaded to the OBIS SEAMAP website and is available to the public. Data usage requests can be made through this site using the standard agreement supplied through OBIS SEAMAP.

10. Contact info, including website if applicable

Please contact William McLellan at the University of North Carolina Wilmington

OBIS SEAMAP: <http://seamap.env.duke.edu/>

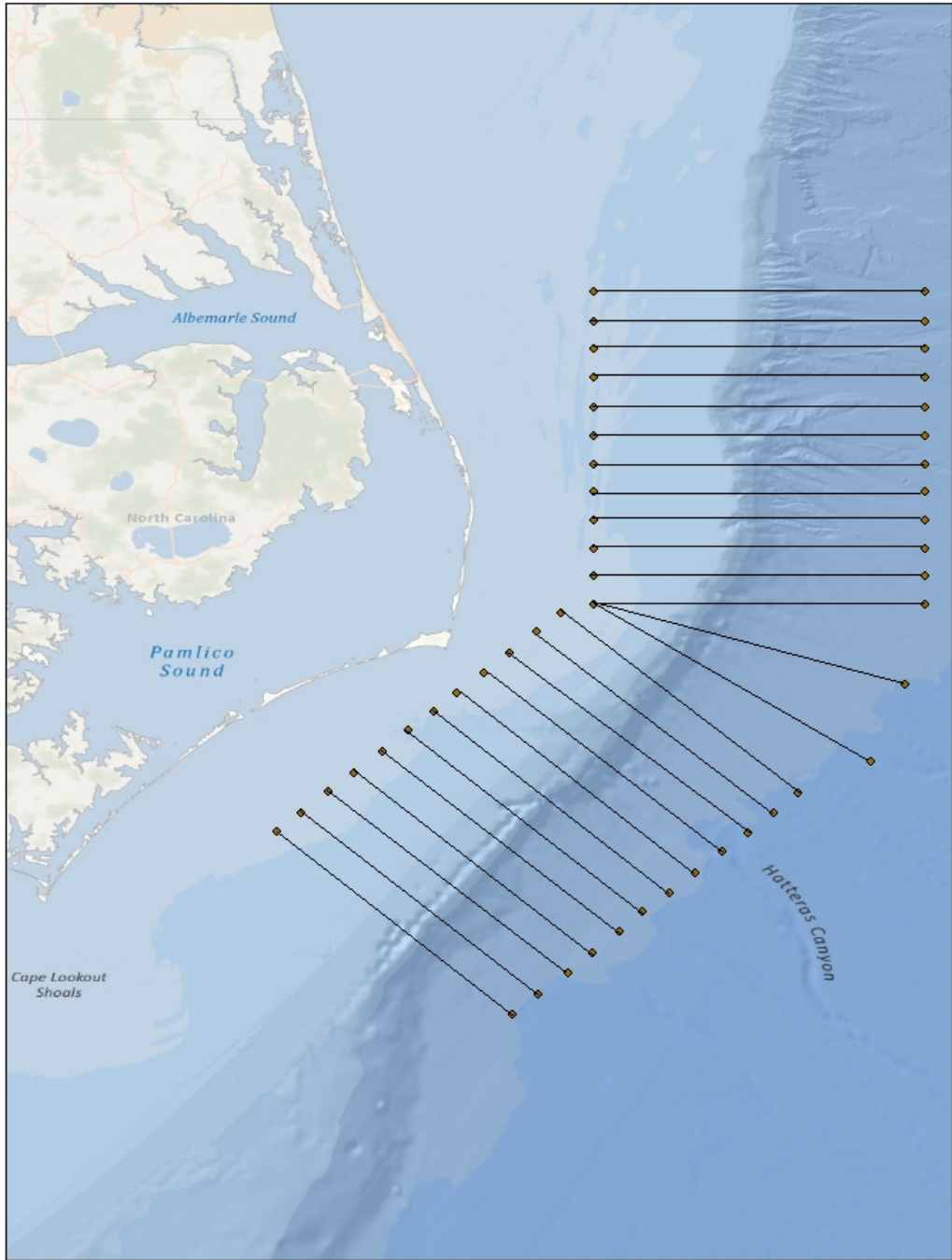

Determining Offshore Use of Diving Bird Species in Federal Waters of the Mid-Atlantic U.S. Using Satellite Tracking

1) Project name

Determining offshore use of diving bird species in Federal waters of the Mid-Atlantic U.S. using satellite tracking (a.k.a. “BOEM Mid-Atlantic diving bird tracking study”)

2) Objectives

Primary Objective:

Determine fine-scale occurrence and local movement patterns of Red-throated Loons (*Gavia stellata*), Surf Scoters (*Melanitta perspicillata*), and Northern Gannets (*Morus bassana*) in Federal waters of the mid-Atlantic U.S. during migration and winter, using platform terminal transmitter satellite tracking tags (PTTs).

Secondary Objectives:

(1) Design and test hydrodynamic (low profile) externally mounted solar PTTs for Red-throated Loons and Surf Scoters, with goals of increasing PTT longevity and reducing bird mortality.

(2) Test and compare at-sea winter capture methods and PTT attachment techniques (implant and external) for Northern Gannets with a goal of increasing total tracking durations above currently attainable levels.

(3) Better identify connectivity and distribution of all three study species across seasons, including delineating source breeding populations, using PTTs.

Findings from this study, funded by the Bureau of Ocean Energy Management (BOEM), will be used to evaluate the potential for interactions between wind energy facilities and wildlife within Federal waters of the mid-Atlantic U.S., and inform permitting and regulation of future offshore wind development in these areas. The work will complement other federally-funded (BOEM, Department of Energy, National Marine Fisheries Service, U.S. Fish and Wildlife Service) current and future research, including AMAPPs and the “Modeling wildlife densities and movements across temporal and spatial scales on the mid-Atlantic continental shelf” project (DOE-Biodiversity Research Institute).

3) Proposed data products

- 1) Detailed maps of occurrence and movement patterns of focal diving bird species within the study area, relative to offshore energy lease blocks.
- 2) Distribution and use estimates for winter and migration periods, potentially incorporating data from offshore survey studies and other tracking projects (e.g., Sea Duck Joint Venture/USGS Patuxent Atlantic Sea Duck Migration Study).

4) Area covered and proposed (or actual) track lines

PTTs will document all locations used by individuals during a complete annual cycle, including Arctic and sub-Arctic breeding areas and staging sites. Our priority study area includes all Federal waters (3 nautical miles to the outer continental shelf break) of the mid-Atlantic U.S., from the southern coast of Long Island, NY to the southern border of North Carolina (Figure 1). These areas will be used by satellite-tagged loons, gannets, and scoters during winter and both migrations. PTTs will be set to maximize data transmission (approximately two 4 hr. periods/day) during these periods.

5) Dates of past, present and future surveys

Prior tagging:

Winter 2012 (Jan-Apr): $n = 17$ loons, 6 gannets, 15 scoters

Future tagging:

- a) Summer 2012 (Sep): *target* $n = 9$ gannets (breeding colony, Cape St. Mary's, Newfoundland)
- b) Fall 2012 - Winter 2013 (Nov-Mar): *target* $n = 15$ loons, 15 gannets, 15 scoters
- c) *TENTATIVE* - Summer 2013 (Sep): gannets only, *target* $n = \text{TBD}$
- d) Fall 2013 - Winter 2014 (Nov-Mar): *target* $n = 15$ loons, 15 gannets, 15 scoters

Past, present, future tracking:

Year-round

6) Data collection methods (append protocol document)

a) Species of focus:

Red-throated Loons (*Gavia stellata*), Surf Scoters (*Melanitta perspicillata*), and Northern Gannets (*Morus bassana*)

b) Data collection methods, including type of platform, speed, altitude, and weather

Capture locations:

WINTER - North Carolina (Pamlico Sound, Outer Banks); Maryland/Virginia (Chesapeake Bay, intercoastal waterways/inlets, nearshore); New Jersey/Delaware (Delaware Bay, intercoastal waterways/inlets, nearshore)

*Note, in summer 2012, and possibly 2013 gannets will also be captured on breeding colonies in Newfoundland and Quebec, Canada

Capture methods (boat based):

Nightlighting & dipnetting (Long 2011); mist netting (Ronconi et al. 2010)

PTT attachment:

Externally-attached tracking devices interfere with effective foraging in several species of aquatic birds that use pursuit diving to capture prey, increasing their mortality (e.g., Perry 1981). As pursuit divers, Red-throated Loons and Surf Scoters could be adversely affected by external PTTs. To avoid this risk, veterinarians surgically implanted sterile PTTs into the abdominal cavity of each loon, using a modified version of the technique described by Korschgen et al. (1996). A similar technique was used successfully with Red-throated Loons in Alaska (Schmutz et al. 2009) and Surf Scoters in the mid-Atlantic (SDJV 2011). Each veterinarian had prior experience performing similar surgeries, prior to the 2012 field season. Post-operative birds were held in captivity for several hours, hydrated, checked by experienced veterinary staff to ensure they were in stable condition (strong vital signs, no signs of lethargy, etc.), and released at capture sites. To reduce adverse impacts of PTTs on locomotion of study subjects, PTTs weighed $\leq 50\text{g}$ ($< 5\%$ of an individual's body mass).

Recent evidence suggests that some diving birds implanted with PTTs experience elevated rates of mortality (Fast et al. 2011, T. Bowman, Sea Duck Joint Venture, pers. comm.), reducing effective sample sizes and raising ethical concerns. We attempted to reduce mortality by ensuring that crews were proficient at trapping techniques, using the best possible equipment (including sterile surgical facilities), and only selecting birds in good body condition (as assessed by body mass, fat stores, and plumage). We are currently testing a newly designed externally mounted PTT on loons and scoters in captivity in an attempt to alleviate increased mortality associated with PTT implants. If successful, this alternative attachment method would replace implants in subsequent study years.

c) Associated environmental data collected

n/a

7) Data analysis methods

Methods are currently in development, and must take into account data constraints from location data that is currently being collected and archived. Preliminary mapping and summary statistics have already been produced.

8) Where and how data will be stored (include software/format(s) used for data storage and access)?

All location data are currently being collected from satellite data provider CLS-ARGOS and archived in raw format in a database housed and managed by USGS Patuxent Wildlife Research Center. These location data can be converted into any desired format (e.g., .txt, .xls, .kmz) for display and/or analyses. Project collaborators at USGS have developed a web-based interface to project location data onto a Google Map-based raster layer. Standard automated data filters (e.g., “Douglass filter”) are available to reduce spurious locations. Location data are sortable by individual, species, date, etc. As data have not yet been proofed or analyzed, access to this web-based map is not currently available to the public. However, maps have been produced upon request and for presentations (e.g., by Biodiversity Research Institute), with the caveat that “caution should be used in identifying patterns or drawing conclusions from the data”. A data analyst will soon be hired by USFWS to produce mapping products, and mid-Atlantic distribution and use estimates.

9) How often will data be updated and how will updated data/history of updates be made available?

Raw location data are updated daily by CLS-ARGOS and relayed to project collaborators, USGS Patuxent and Biodiversity Research Institute. Data summaries and mapping products will be published in annual progress reports to BOEM in November 2012, 2013, and 2014, with a final report, to include analyzed data and comprehensive maps, in mid-2015. In the interim, real-time tracking data may be made available through a publically-accessible mapping website. However, this option is still being discussed among project staff and funders, and the creation of such a website is TBD.

10) Contact info, including website if applicable

Caleb Spiegel, M.S.
Wildlife Biologist
U.S. Fish and Wildlife Service
Division of Migratory Birds
300 Westgate Center Dr.
Hadley, MA 01341
caleb_spiegel@fws.gov

James R. Woehr, Ph.D., C.W.B.
Avian Biologist
Bureau of Ocean Energy anagement
Division of Environmental Sciences
Mail Stop HM3115
381 Elden St.
Herndon, VA 20170
James.woehr@boem.gov

No public website currently available, but may be created within the next year. Preliminary tracking maps are available, based on raw (unanalyzed/unvetted) location data. Please contact Caleb Spiegel for more information.

11) Bibliographic resources for methodology if appropriate

Korschgen, C. E., K. P. Kenow, A. Genron-Fitzpatrick, W. L. Green, and F. J. Dein. 1996. Implanting intra-abdominal radio transmitters with external whip antenna in ducks. *Journal of Wildlife Management* 60: 132-137.

Long, D. 2011. Capture technique for loons at wintering, maturation, and migratory staging locations. Unpublished report. Biodiversity Research Institute, Gorham, ME.

Perry, M. C. 1981. Abnormal behavior of canvasbacks equipped with radiotransmitters. *Journal of Wildlife Management* 45: 786-789.

Ronconi, R. A., Z. T. Swaim, H. A. Lane, R. W. Hunnewell, A. J. Westgate, and H. N. Koopman. 2010. Modified hoop-net techniques for capturing birds at sea and comparison with other capture methods. *Marine Ornithology* 38: 23-29.

Schmutz, J. A., K. A. Trust, and A. C. Matz. 2009. Red-throated loons (*Gavia stellata*) breeding in Alaska, USA, are exposed to PCBs while on Asian wintering grounds. *Environmental Pollution* 157: 2386-2393.

SDJV. 2011. [online]. Atlantic and Great Lakes sea duck migration study factsheet. Sea Duck Joint Venture, 2 pp
http://seaduckjv.org/atlantic_migration_study/atlantic_sea_duck_general_outreach_feb2011.pdf> (31 August 2011).

12) Papers published based on this work and associated citation information. If possible, please attach the paper with your response.

No publications available yet. Our project just commenced in February, 2012, and birds are currently being tracked.



Figure 1. Map of mid-Atlantic offshore (3 nautical miles to outer continental shelf break) priority study area (blue shaded area). Approximate locations of at-sea winter capture sites are represented by circles. Potential breeding colony capture sites for Northern Gannets are represented by red triangles.

Mid-Atlantic Right Whale Aerial Surveys

1) Project name

Mid-Atlantic Right Whale Aerial Surveys

2) Objectives

Document Right whale movement patterns across the mid-Atlantic region. Identify individual whales through photo-documentation of callosity patterns or scars enabling a finer scale monitoring of this species. Collect calving data to be incorporated in calving habitat models.

3) Proposed data products

Data collection is part of a larger multi-agency monitoring and conservation efforts to assess the recovery of this species

4) Area covered and proposed (or actual) track lines

Area covered varied by year, in total tracklines ran from Savannah GA up to Temperance VA above the mouth of the Chesapeake Bay. All tracklines originated at the shore line and ran offshore between 28-35nm. Tracklines below Cape Hatteras were 35nm long while those above Cape Hatteras were 28nm long.

5) Dates of past, present and future surveys

Timing and duration of surveys varied by year.

- a. 2001: January 6, 2001 – March 2, 2001 GA to VA
- b. 2002: January 22, 2002 – March 19, 2002 GA to VA
- c. 2006-06: October 27, 2005 – April 20, 2005 NC/SC to VA
- d. 2006-07: December 5, 2006 – May 2, 2007 NC/SC to VA
- e. 2008: February 2, 2008 – June 14, 2008 NC/SC to VA

6) Data collection methods (append protocol document)

Right whales and any large whales were targeted for photo-documentation when encountered. Observations of the left and right observers are combined into a single dataset.

7) Data analysis methods

Analysis – GIS plots of all sightings of each species were generated. The frequencies of right whale sightings were calculated by month to assess the timing of the species movements North and South.

8) Where and how data will be stored (include software/format(s) used for data storage and access)?

Data is stored locally on the University of North Carolina Wilmington network. Formats of data include excel spreadsheets, digital images are in standard JPEG format, Maps of sightings are in JPEG and also ArcGIS.mxd files.

9) How often will data be updated and how will updated data/history of updates be made available?

Final report and complete data set was submitted to Lance Garrison. All datasets from these projects are currently loaded to the OBIS SEAMAP website. Data usage requests can be made through this site using the standard agreement supplied through OBIS SEAMAP.

10) Contact info, including website if applicable

Please contact William McLellan at the University of North Carolina Wilmington

OBIS SEAMAP: <http://seamap.env.duke.edu/>

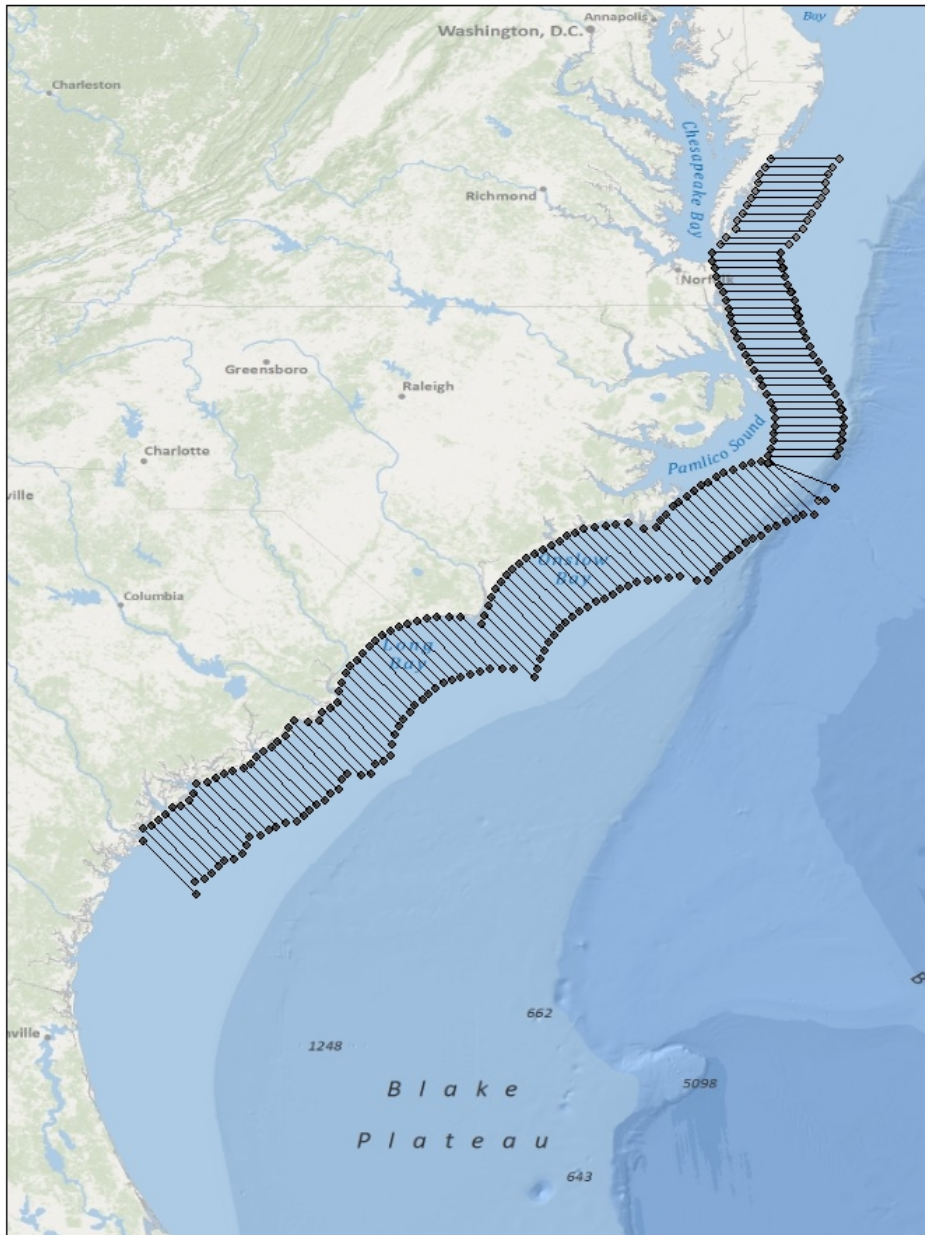

Modeling Wildlife Densities and Movements Across Spatial and Temporal Scales on the Mid-Atlantic Outer Continental Shelf

1. Project name

Mid-Atlantic Baseline Studies Project

(Formal project name: Modeling Wildlife Densities and Movements Across Spatial and Temporal Scales on the Mid-Atlantic Outer Continental Shelf)

2. Project Background and Objectives

The Mid-Atlantic Baseline Studies Project is an effort to gather baseline information on the distribution, abundance, and movements of wildlife (marine birds, marine mammals, and sea turtles) on the mid-Atlantic outer continental shelf. The three-year project, begun in 2012, is a collaborative effort that includes researchers from the Biodiversity Research Institute, North Carolina State University, Duke University, the City University of New York, HiDef Aerial Surveying Inc., and others. The project is funded by the U.S. Department of Energy (DOE), with collaborative funding for certain project components also being provided by the Bureau of Ocean Energy Management, U.S. Fish and Wildlife Service, and private foundations.

The objective of this study is to produce the data required to inform siting and permitting processes for offshore wind energy development on the mid-Atlantic Outer Continental Shelf. Data on bird, sea turtle, and marine mammal abundance and movements will be collected and analyzed in scientifically sound ways, using a variety of technologies and methods, and will be presented to stakeholders and regulators in easily accessible formats that are useful for planning and decision-making.

3. Proposed data products

- Database from two full years of high-definition video aerial and boat surveys (for a total of 14 aerial and 16 boat surveys) on bird, sea turtle, and marine mammal distributions and densities.
- A comparison of high definition video aerial and boat-based survey data, to establish the validity of high definition aerial surveys as a survey method for offshore development in U.S. waters.
- Methodology for incorporating information on animal movements and site fidelity from satellite tracking studies of focal bird species (Northern Gannets, Surf Scoters, Red-throated Loons, and Peregrine Falcons) into hierarchical modeling efforts.
- Hierarchical models that use remote sensing data; environmental covariate data from the project boat surveys; boat and aerial survey project data;

historical survey data; and bias estimation information from satellite telemetry work in order to estimate (with geographic specificity) animal distributions during all seasons.

- Exploration of the utility and functionality of nocturnal passive acoustic migration monitoring and NEXRAD (next generation radar) data analysis in understanding avian migratory patterns and timing offshore.
- Publicly accessible technical and summary reports, geospatial map layers, and scientific manuscripts, as well as significant outreach and communication efforts.

4. Area covered and proposed (or actual) track lines (append map)

The project study area extends from the southern border of New Jersey to the Virginia-North Carolina border, and from three miles offshore to the 30-meter isobath (e.g., in offshore federal waters on the mid-Atlantic Outer Continental Shelf). The study is particularly focused on the federally identified Wind Energy Areas (WEAs) off the coasts of Maryland, Delaware and Virginia. Aerial survey transects are one kilometer apart within the footprint of these WEAs, providing 20% ground coverage within these areas; a broader-scale “saw-tooth” series of transects covers the remainder of the study area at a rate of 3.2% ground coverage (Figure 1). Twelve boat transects, spaced 10 kilometers apart, cover the areas in and around the WEAs (Figure 2). Nocturnal passive acoustic monitoring of birds from the boat generally occurs in Delaware and Maryland waters during nights at sea.

Satellite telemetry projects, while focused on obtaining data relevant to this study area, are following birds throughout their annual migratory cycle. In the winter of 2011-2012, seabirds were captured in Chesapeake and Delaware Bays and Pamlico Sound, North Carolina, and these birds have since been tracked as far as Greenland (for more information, see the compendium entry titled, “Determining Offshore Use of Diving Bird Species in Federal Waters of the Mid-Atlantic U.S. Using Satellite Tracking”). Additional capture locations include Nova Scotia (for Northern Gannets) and Rhode Island (for Peregrine Falcons).

5. Dates of past, present and future surveys

Surveys are taking place over a two-year period between March of 2012 and April of 2014. Seven aerial and eight boat surveys are planned per year (Tables 1-2). Three aerial surveys (March 26-28, May 6-7, and June 16 and 18, 2012) and two boat surveys (April 25-29 and June 18-21, 2012) have been completed to date; weather permitting, future surveys will be conducted according to the schedules outlined in Tables 1-2. Satellite transmitters are being deployed on focal bird species between March 2012 and October 2013.

6. Data collection methods (append protocol document)

Aerial Surveys

- a. **Species of focus:** Seabirds, sea mammals, sea turtles, ocean sunfish, sharks, other large fish.
- b. **Data collection methods:** Aerial surveys are conducted by project vendor HiDef Aerial Surveying, Inc., out of the company's Boston, Massachusetts office. Subject to safe flying conditions, surveys are performed in wind conditions up to and including Beaufort Scale 5, but are restricted by low clouds (below 2,000ft), mist, and fog. In each survey, the 'saw-tooth' transect pattern is flown over the entire area for the purposes of baseline monitoring and abundance estimates (Figure 1). The saw-tooth transects are flown at a ground spatial resolution of 2 centimeters, for a minimum ground coverage of 2.2%. More detailed, one-kilometer spaced transects are flown perpendicularly to the coastline over the three WEAs to obtain 20% coverage of each WEA (also at 2 cm ground spatial resolution). All surveys are flown using GPS to ensure accuracy. Surveys are flown with two multi-engined aircraft, to enhance safety when operating over the sea and allow complete coverage of the study area in two days (weather permitting). Surveys are flown under Visual Flight Rule (VFR) conditions and are flown at 2,000 feet, or 609.6 m (minimum of 1500 ft, or 457.2 m) using four high definition video cameras belly-mounted on the aircraft.

In addition to the fourteen surveys described above, HiDef will also fly a flight specifically intended to allow for a comparison of aerial and boat-based data collection. The comparison flight will occur over the northern set of the boat survey transects as detailed in Figure 1. The flight will occur during one of the regularly scheduled boat surveys in the first year of surveys (April 2012-April 2013), during a time period where BRI expects to encounter large numbers of animals (likely during fall migration in 2012). The flight can either be a fifteenth flight, or an extension onto one of the fourteen regular aerial surveys, depending on survey timing. The comparison flight is expected to require a maximum of eight hours of flight time over the survey area.

In addition to the fourteen surveys flown according to the protocol described above, a flight specifically intended to allow for a comparison of aerial and boat-based data collection will occur during one of the regularly scheduled boat surveys in the first year of surveys (likely during fall migration in 2012). The plane will fly at normal survey height and conditions, but instead of following normal transects it will fly a series of routes to overlap with the boat survey transects, to compare birds and other animals seen using each method.

c. Associated environmental data: GPS location

Boat Surveys

- a. **Species of focus:** Birds, sea mammals, sea turtles, ocean sunfish, sharks, other fish.
- b. **Data collection methods:** Boat transects extend perpendicularly to the coastline, from 3 nautical miles (5.6 km) offshore to the 30 m isobath or the eastern extent of the WEAs, whichever is furthest east. Boat-based transects will be spaced 10 km apart to ensure the independence of each transect, and will extend at least one transect north and south of each WEA (Figure 2). Total transect distance is approximately 559 kilometers (excluding boat time to move between transects). Surveys are conducted in all safe sea conditions (as judged by the boat captain and primary investigator Richard Veit) with adequate visibility.

Two to three observers switch off and use combined strip and line transects to record animals. They will count all animals within a 300 m strip to one side of the ship, and also record distance and angle to all birds. Observational data is recorded using Toughbook laptop computers. The seabird and marine mammal observation program, Dlog, is used to record geo-referenced seabird and marine mammal data as well as ship track. The observer acting as recorder also scans the horizon and focuses on spotting cetaceans and sea turtles. Weather permitting, each survey is conducted over a five-day period: two days to cover the northern transects off the coasts of Maryland and Delaware (including one night aboard ship); one transit day between survey areas; and two more days at sea conducting the southern section of transects off the coast of Virginia. Surveys are conducted in “passing mode,” meaning that the boat stays on transect and at survey speed (10 knots) except when complying with National Marine Fisheries Service (NMFS) rules about approaching marine mammals. The boat thus stays on transect and at speed when animals are sighted, rather than breaking transect to approach them and get more accurate counts of group numbers and/or better species identifications or photos.

- c. **Environmental data:** GPS location, sea surface temperature, sea surface salinity, Beaufort sea state, biomass densities measured using Simrad EK60 scientific echosounder employing a 120 khz transducer, passive acoustic detections of nocturnal migrating passerines.

For both aerial and shipboard surveys

Environmental data collected via satellite or other sources will include the following: sea surface temperature, chlorophyll, water depth, distance from shore, and other factors.

7. Data analysis methods

The project team, led by Beth Gardner of North Carolina State University, will conduct abundance or occupancy modeling using boat-based and aerial survey data and a variety of other data sources. Specific tasks include exploring mechanisms to combine data across platforms and also across species when needed; creating hierarchical models of occupancy or abundance based on the collected data; incorporating movement parameters from the telemetry data into our understanding of bias in surveys; and producing results and maps of uncertainty for the study area. Data will be modeled within a hierarchical framework to attempt to separate observational and ecological processes and understand the environmental factors influencing species distributions and densities.

8. Where and how data will be stored (include software/format(s) used for data storage and access)?

Survey data will be stored in MS Access geo-referenced databases, and as ArcGIS geodatabases (v10.0). Variables used in the aerial and boat data tables are listed in Tables 3-4. Survey data will also be compiled and uploaded to the Northwest Atlantic Seabird Compendium. Other project data (satellite telemetry data, acoustic data, NEXRAD data) will be available in summary forms in project reports and related documents (also see entry titled “Determining Offshore Use of Diving Bird Species in Federal Waters of the Mid-Atlantic U.S. Using Satellite Tracking”).

9. How often will data be updated and how will updated data/history of updates be made available?

All data will be submitted annually to the Northwest Atlantic Seabird Compendium, and the history of updates will be available in the project’s annual reports to the Department of Energy (which will be posted on the project webpage).

10. Contact info, including website if applicable

Kate Williams
Wildlife and Renewable Energy Program Director
Biodiversity Research Institute
19 Flaggy Meadow Rd., Gorham, Maine 04038
Kate.williams@briloon.org
207-839-7600 x108
<http://www.briloon.org/research/research-programs/wildlife-renewable-energy-program/mabs>

11. Bibliographic resources for methodology if appropriate

Barrett, RT, G Chapdelaine, T. Anker-Nilssen, A Mosbech, WA Montevecchi, JB Reid & RR Veit. 2006. Seabird numbers and prey consumption in the North Atlantic. ICES Journal of Marine Science, 63:1145-1158.

Farnsworth A, RW Russell. 2005. Evaluation of a method for monitoring audible fall bird migration traffic over platforms. *In: Interactions Between Migrating Birds and Offshore Oil and Gas Platforms in the Northern Gulf of Mexico* (R. W. Russell, Ed.). Minerals Management Service Publication 2005-009 (Chapter 14). Pp. 247–256. Available at: www.oldbird.org. Accessed 21 March 2011.

Fuller MR, WS Seegar, LS Schueck. 2009. Routes and travel rates of migrating Peregrine Falcons *Falco peregrinus* and Swainson's Hawks (*Buteo swainsoni*) in the Western Hemisphere. *Journal of Avian Biology* 29: 433-440.

Gardner B, PJ Sullivan, S Epperly, SJ Morreale. 2008. Hierarchical modeling of bycatch rates of sea turtles in the western North Atlantic. *Endangered Species Research* 5: 279-289.

Mordecai RS, BJ Mattsson, CJ Tzilowski, RJ Cooper. 2011. Addressing challenges when studying mobile or episodic species: hierarchical Bayes estimation of occupancy and use. *Journal of Applied Ecology* 48(1): 56-66.

O'Connell, Jr., AF, B Gardner, AT Gilbert, K Laurent. 2009. Compendium of Avian Occurrence Information for the Continental Shelf Waters along the Atlantic Coast of the United States (Database Section – Seabirds). A final report for the U.S. Department of the Interior, Minerals Management Service, Atlantic OCS Region, Herndon, VA. 50pp. Contract No. M08PG20033.

Sauer JR, WA Link, JA Royle. 2005. Hierarchical models and Bayesian analysis of bird survey information. USDA Forest Service Gen. Tech. Rep. PSW-GTR-191. Available at: http://www.fs.fed.us/psw/publications/documents/psw_gtr191/Asilomar/pdfs/762-770.pdf. Accessed 18 March 2011.

Thaxter CB, NHK Burton. 2009. High Definition Imagery for Surveying Seabirds and Marine Mammals: A Review of Recent Trials and Development of Protocols. British Trust for Ornithology Report Commissioned by Cowrie Ltd. Available at: <http://www.coastalkent.net/data/news/downloads/COWRIE%20High%20Definitive%20Imagery%20Final%20Report%2020091130.pdf>. Accessed 3 June 2011.

Zipkin, EF, B Gardner, AT Gilbert, AF O'Connell, JA Royle & ED Silverman. 2010. Distribution patterns of wintering sea ducks in relation to the North Atlantic Oscillation and local environmental characteristics. *Oecologia*, 163:893-902.

12. Papers published based on this work and associated citation information. If possible, please attach the paper with your response.

Annual reports will be made available on the project website beginning in May of 2013. Interim reports are available upon request. Several publications are

intended to emanate from the project, but the first of these will likely not be submitted to a scientific journal until 2013/2014.

Tables

Table 1: Schedule for aerial surveys.

Survey Period	Ideal Time
Early spring	Late March (into early April if needed)
Late spring	May (pref. early to mid-May)
Early summer	Late June
Late summer	Sept (pref. early Sept.)
Fall	Oct. (pref. mid- to late Oct.)
Early winter	December (pref. mid-Dec.)
Late winter	Late Jan. or early Feb.

Table 2: Schedule for boat surveys.

Survey Period	Timing
Early spring	Late March (into early April if needed)
Late spring	Early to mid-May
Early summer	June (pref. late June)
Late summer	Early August
Early fall	September (pref. early to mid-Sept.)
Late fall	October (pref. mid- to late Oct.)
Early winter	December (pref. mid-Dec.)
Late winter	Late Jan. or early Feb.

Table 3. List of variables for the aerial survey data tables.

Variable	Notes
Location	Geographic zone in which object was located
Latitude	Latitude of object
Longitude	Longitude of object
Date	Date on which footage was filmed
Camera	Camera number (four cameras mounted per plane)
Resolution	Ground spatial resolution of footage
Reel Name	ID number for reel of video footage
Observer	Initials of video reviewer who marked the object
Time	Time frame image was recorded
Frame	Frame number from reel in which object crosses the center of the frame (as assigned by Observer)
Category	General category of object (assigned by Observer)
Marker#	Unique number assigned to object by Observer
Identifier	Name of video reviewer who identified the object to species or species grouping
Identification Date	Date on which Identifier examined the object in footage
ID Category	Species name or other identification category (assigned by Identifier)
Confidence	Confidence of Identifier in the identification of the object (Definite, possible, probable, or blank)
Behaviour	Behavior and/or direction of movement of object (drop-down list of options)
Flying at Sea Level	Y/N
Submerged	Behavioral variable: notes whether object is Submerged or Surfacing
Flight Height	Height of flying birds above sea level (estimating using parallax technology)
Flight Height Confidence	Confidence level in flight height estimate
Approximate Age	Adult or Immature
Plumage	For specific bird species' plumages (when bird ages can be divided into more than two categories)
Molt	For specific molt patterns in birds
Probable Sex	Male or Female
Measurements	Comments field to note object's body length, wingspan, or other measurement (derived using on-screen calipers tool)
Flag	Field to denote need for additional video review
Comments	Comments field

Table 4. List of variables for the boat survey data tables.

Variable	Notes
LatDD	latitude decimal degrees
LongDD	longitude decimal degrees
TimeHour	hour obs
TimeMin	min obs
TimeSec	sec obs
Year_	year obs
Month_	month obs
Day_	day obs
RecNum	record number from dLog
InputType	GPS or obs denoting whether auto position or user entered record
OrigSppCode	spp code entered for obs record
ObsCount	count of obs
Behavior	behavior of animal
Direction	direction traveled
Distance	distance to animal
Angle	angle in degrees to animal
Plumage	plumage characteristics
Age	age of animal
Comment	Comments
Transposition	transect position - start or stop or nothing
Beaufort	beaufort seastate
Transect	transect number
Obs	observer(s)
Visib	visibility code
SurveyID	survey ID
Station	station number
Platform	platform for observation (e.g., bridge wing)
WaterTempC	water temperature recorded at the surface in C
SalinityPPT	salinity of water recorded at the surface in ppt
Edits	any edits made to the data during the QA/QC process
Outzone	outzone animals (beyond 300 m)

I. Figures

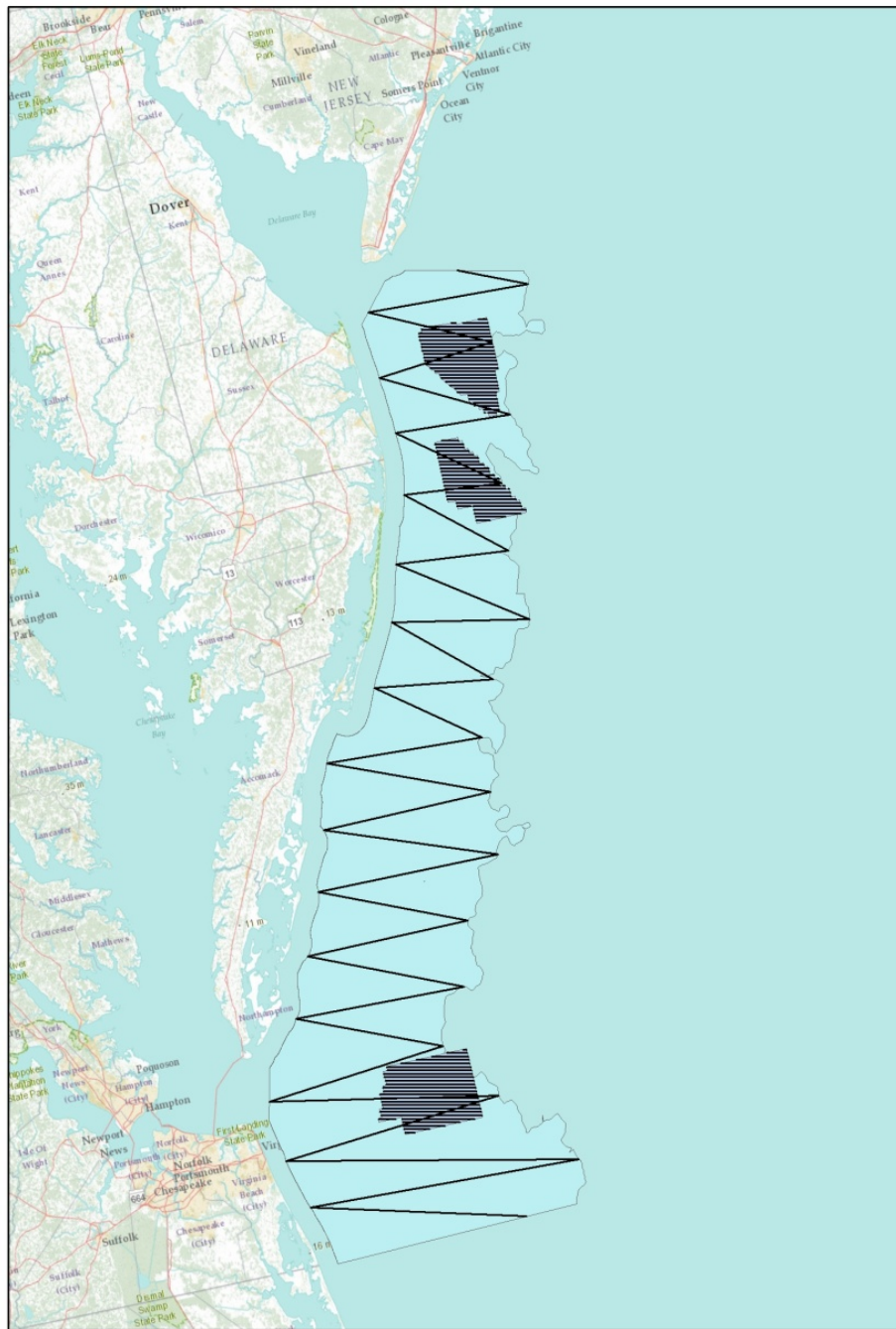

Figure 1: Aerial survey design in the Delaware, Maryland and Virginia WEAs, and “sawtooth” throughout the survey area.

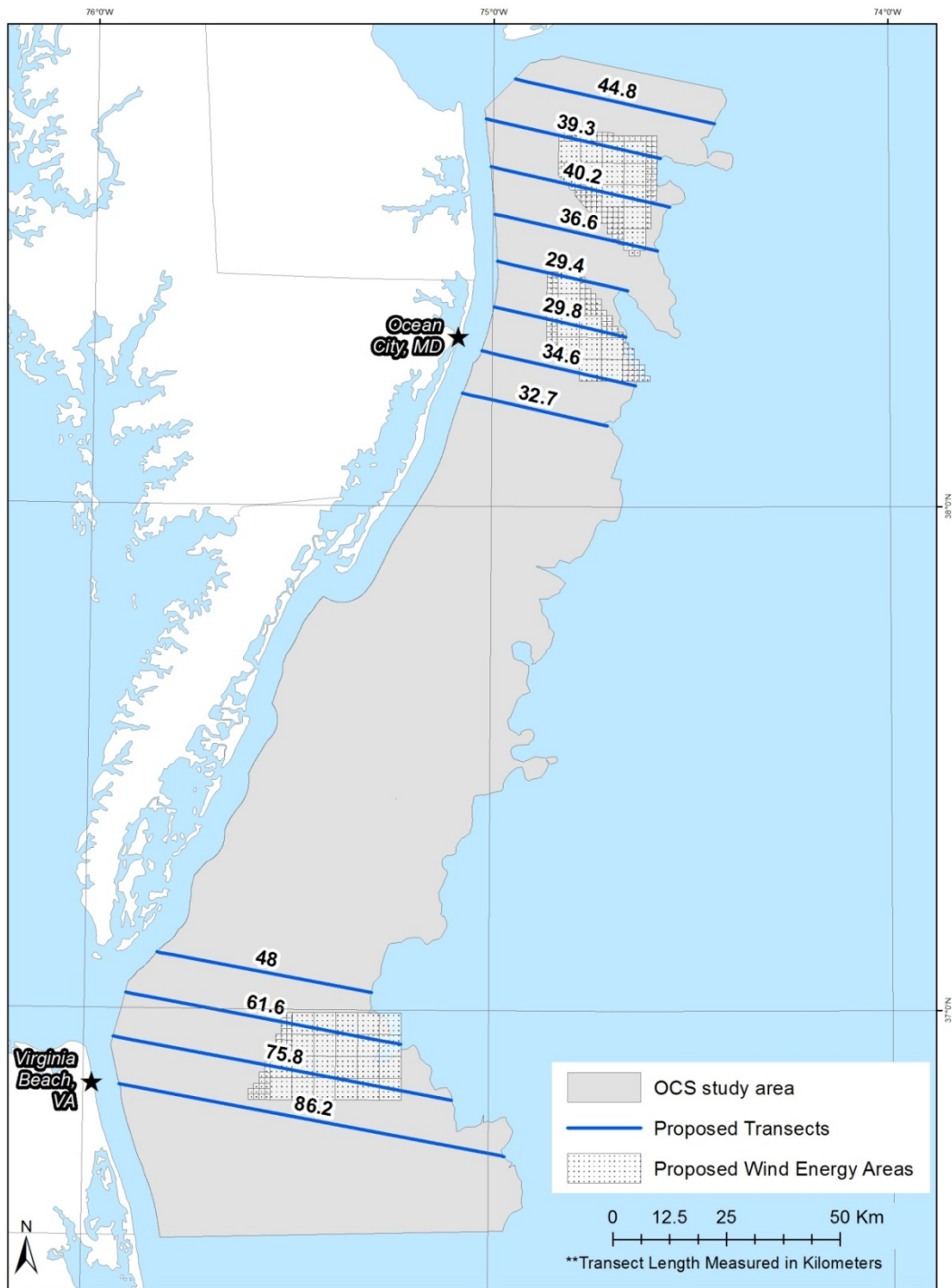

Figure 2: Boat survey design through the Delaware, Maryland and Virginia WEAs and surrounding waters. Transects are from the 3 mile EEZ until the 30 meter isobath or end of the WEA, whichever is furthest east.

New Jersey Ocean/Wind Power Ecological Baseline Studies

1. Project name:

New Jersey Ocean/Wind Power Ecological Baseline Studies

2. Objectives:

The objective of this study was to conduct baseline studies in waters off New Jersey's coast to determine the current distribution and usage of this area by ecological resources. The goal was to provide GIS and digital spatial and temporal data on various species utilizing these offshore waters to assist in determining potential areas for offshore wind power development. The scope of work includes the collection of data on the distribution, abundance and migratory patterns of avian, marine mammal, sea turtle and other species in the study area over a 24-month period. These data, as well as existing (historical) data, were compiled and entered into digital format and geographic information system (GIS)-compatible electronic files. Those portions of the study area that are more or less suitable for wind/alternative energy power facilities were determined based on potential ecological impact using predictive modeling, mapping, and environmental assessment methodologies.

3. Proposed data products:

The OWPEBS was designed to assess the natural and biotic resources present in New Jersey coastal waters. By design, the study's major objective was to fill data gaps existing for a wide range of parameters, including biotic resources (e.g. avian, marine mammal, and sea turtle distributions, fisheries database information, etc.) and abiotic resources (e.g. oceanographic information, wind resources, physiochemical data, etc.). Major products include individual counts and distribution of avian, marine mammal, and sea turtle species utilizing the offshore study area. From these data, avian predictive model and kernel density models were generated to predict habitat usage and densities for numerous species. In addition, the above was also used to generate an Environmental Sensitivity Index and Impacts Analysis models.

In summary, the OWPEBS will be used to inform a number of studies that will draw from this huge database, for example used to list the species that are utilizing the waters offshore New Jersey, including the spatial and temporal extent, and allow appropriate steps to be taken by future developers to avoid or mitigate any impacts upon these species. The State's natural resource

programs will be in a stronger position to devise the best management strategies for a number of species with a better understanding of their range, localized distributions, and abundance. In addition, stakeholders and governments alike will use this data in order to better understand the Outer Continental Shelf of the Mid-Atlantic Bight, and be better informed on how to develop green energy in this area.

The results of the OWPEBS provide vital information on a number of species, including data on the offshore distribution and spatial habitat use of threatened and endangered marine mammal and sea turtle species. Of particular ecologic importance are the sightings/acoustic detections of endangered large whale species, the North Atlantic right whale, fin whale, and humpback whale. Each of these species was detected during all seasons, including those seasons during which North Atlantic right and humpback whales are known to occupy feeding grounds north of the Study Area or breeding/calving grounds farther south of the Study Area. These species may use the waters of the Study Area for short periods of time as they migrate or follow prey movements or they may remain in the Study Area for extended periods of time. High concentrations of these species were not documented in the Study Area at any time during the study period; however, the presence of these endangered large whale species in New Jersey waters indicates that these animals are utilizing the area as habitat. The occurrence of these endangered species provides critical information on the distribution of the species in this region.

4. Dates of past, present and future surveys:

Surveys for the OWPEBS were conducted within the duration of a 24-month study period, commencing in January 2008 and concluded December 2009.

5. Data collection methods (append protocol document):

Field studies were initiated in January 2008 and continued through December 2009. Please see the NJ OWPEBS Final Report and appendices (Volumes II – IV) for SOPs regarding data and survey collection methods: <http://www.nj.gov/dep/dsr/ocean-wind/report.htm>. The Study Area encompasses approximately 4,665 square kilometers (km²; 1,360 square nautical miles [NM²]) and stretches from the area adjacent to Seaside Park in the north to Stone Harbor in the south and extends 37 km (20 NM) perpendicular to the shoreline (i.e., 126 x 37 km [68 x 20 NM] in size). Avian, marine mammal and sea turtle data were collected over a 24-month period to assess the distribution, abundance, and presence of avian, marine mammal

and sea turtle species in the Study Area. Surveys were conducted via the following methods:

- shipboard (e.g. small: 0 – 2 NM, and large vessel: 2 – 20 NM offshore) surveys using a random double-sawtooth pattern
- aerial surveys
- Radar (onshore at three locations and offshore via jack-up barge – horizontal and vertical radar: TracScan and VerCat, respectively)
- Thermal imaging-vertically pointed radar (TI-VPR)
- NEXRAD
- Passive acoustic monitoring (PAM) for marine mammals

Shipboard surveys:

For offshore surveys, tracklines were surveyed at approximately 10 knots (kts; 5 meters per second [m/s]) during daylight hours when Beaufort Sea State (BSS) was ≤ 5 and visibility was ≥ 7 km (4 NM). Between 26 and 28 tracklines, no more than 9 km (5 NM) apart, were scheduled to be surveyed per month. When weather conditions prevented completion of all tracklines in a given survey month, tracklines were spaced at intervals greater than 9 km (5 NM) apart to cover the project area from north to south.

Species observations were made using binoculars, scanning within the designated survey area. Sighting data were recorded for each observation on a hand-held computer that was synchronized to the ship's geographic positioning system (GPS). Data recorded for each observation included: the position of the observer (i.e., bow, port, or starboard), the observation time and location, species (lowest possible taxon; family, genus, or species), count (approximate number for flocks), bearing (to the nearest 5°) and range (m), estimated flight altitude in feet above sea level (ASL); 1 (skimming), 25, 50, 100, 200, 300, 500, 1,000+, and behavior (coded numerically; sitting, following the ship, feeding, piracy, other, unknown, directional flight, aimless flight, circling). Cardinal directions were used to designate flight directions (i.e., the ship's bow was considered north). Steiner® 7 X 50 binoculars equipped with a compass were used to mark bearings (in 10° increments) for each of the observer positions to increase the accuracy of bearing data and range estimation sticks specific for each observer were used to increase the accuracy of range estimates (Heinemann 1981).

- A. Large Vessel - A 'double saw-tooth' trackline was used to maximize coverage of the Study Area. Ship survey line transects (tracklines) were generated monthly with the program DISTANCE. Double saw-tooth lines were plotted perpendicular to the coastline from the 10-m (33-ft) isobath

to the Study Area boundary, roughly 37 kilometers [km] (20 nautical miles [NM]) from the New Jersey coastline. A 300-meter (m) x 300-m (984-foot [ft] x 984-ft) strip transect was selected to estimate avian distribution and abundance at sea.

- B. Small Vessel - Small-boat surveys were conducted to determine bird distribution and abundance in coastal waters that larger vessels could not access. A 300-m strip-transect method with a “single saw-tooth” sample design was implemented to survey the area. The starting location (north end or south end) for each survey was randomly determined. The entire coastal area was surveyed in one day if weather and sea state conditions allowed. The small-boat transects were designed to cover the area between the coast and the 10-m (33-ft) isobath.

Aerial surveys:

A strip transect survey sampling design was selected to collect avian and marine mammal/sea turtle data. Transect lines were spaced 2 NM (2.3 miles [mi]) apart and orientated perpendicular to the coastline. The 34 transect lines were divided (even or odd numbered) and scheduled to be flown during separate morning and afternoon sessions (i.e., half in the morning and half in the afternoon). This design provided comparable spatial and temporal coverage of the entire Study Area. The survey aircraft was a twin-engine Cessna Skymaster 337. Surveys were flown at approximately 76.2 m (250 ft) altitude at a speed of approximately 220 kilometers per hour (kph; 110 kts per hour [hr]). Two biologists/observers conducted the strip transect surveys. A third scientist observer was responsible for ensuring the operational status of computer that was connected to the plane’s GPS to accurately record transect sighting coordinates and transect start and end times. The data acquisition computer was interfaced with the aircraft GPS system. Automated data acquisition included the time, date, latitude, longitude, speed, and heading of the aircraft, and GPS signal strength; data were collected at 10-s intervals.

Radar:

Mobile Avian Radar System (MARS®) was the primary avian radar system used by the contractor (GMI) to monitor airborne targets (i.e., flight activity) in the Study Area. Survey design, methodology, and data analysis procedures are described in detail for each radar system used, including radar validation methods and avian radar survey results are provided for offshore and onshore survey sites in Volume II of the OWPEBS Final Report. Onshore radar sampling was conducted from three sampling locations using the MARS apparatus, equipped with vertically scanning radar (VerCat), horizontally scanning radar (TracScan), and thermal imaging-vertically pointed radar (TI-VPR). Offshore

locations also deployed MARS in randomly selected locations via jack-up barge.

Data (i.e. bird track data) related to cumulative diurnal and nocturnal flux were sorted by time period (weeks, daytime and nighttime) into three altitude bands with reference to the potential rotor swept zone - RSZ: (1) below the RSZ (low altitude band, 1 to 99 ft above mean sea level [AMSL]), (2) within the RSZ (middle altitude band, 100 to 700 ft AMSL), and (3) above the RSZ (high altitude band, 701+ ft AMSL) and by wind category (0-8 miles per hour [mph], 9-16 mph, and above 16 mph). More detail can be found in Volume II of the OWPEBS Final Report.

NEXRAD:

Archived WSR-88D data (i.e. base reflectivity) from the KDIX station were analyzed to characterize the migration patterns of birds over the coastal region of New Jersey during the spring (15 March to 31 May 2005-2009, 390 nights) and fall (15 August to 15 November 2005-2009, 465 nights) migration periods. The data extracted from the base reflectivity files were analyzed with Excel to reveal the year-to-year, season-to-season, night-to-night and hour-to-hour patterns of variation in the amount of migration. More detail can be found in Volume II of the OWPEBS Final Report.

Passive Acoustic Monitoring (PAM):

PAM was used to determine the presence of marine mammal species in the Study Area. Five marine autonomous recording units (i.e., "popups") from the Bioacoustics Research Program, Cornell Laboratory of Ornithology were placed in a cross configuration in the Study Area. There were roughly 72.42 km (45 mi) between the southern and northern popup stations and about 24.14 km (15.00 mi) between the eastern and western popup stations. Popups were placed consistently within 6.10 m (20.00 ft) of the GPS coordinates identified for station deployment. Depths for deployed popups ranged from 17.68 to 27.43 m (58.00 to 90.00 ft). Three of the popups had a 2-kilohertz (kHz) sample rate and a continuous duty cycle for recording while the other two popups had a 32-kHz sample rate with a 5-minute (min) on/25 min off duty cycle. The acoustics data were recorded on the popups. Each popup was retrieved so that the data could be uploaded and analyzed.

In addition, a thorough review of fish and fisheries resources of the Study Area was conducted, which includes an overview of the ichthyofauna (including fish species designated with essential fish habitat [EFH]) of the Mid-Atlantic Bight (MAB) and the ancillary fishes observed during the shipboard and aerial surveys. Physical and chemical parameters within the Study Area were also measured, including wind speeds, water temperature, salinity, depth,

chlorophyll, and dissolved organic matter. Extensive literature searches were also conducted on climate, currents and circulation patterns, and other important physiographic components in effort to characterize the Study Area and gain understanding of the relationships between the physical and biological resources.

6. Data analysis methods:

Numerous methodologies were used to generate the species density models and the Avian Predictive Modeling in the OWPEBS study. These methods generally included kernel density interpolation, spatial regression, and generalized additive models (GAM). Due to the voluminous facets involved with these methods, it is best to defer to the Final Report which illustrates and explains the analytical and modeling methodologies in detail. The executive summary of the OWPEBS Final Report, Volume I gives a brief overview of analytical methods and outcomes, as well as Environmental Sensitivity Index maps and Impacts Analysis (both in more detail in Volume I, chapters 4.0 and 5.0, respectively). Volume II, Chapter 8.0 provides full detail regarding avian density modeling, and Volume III discusses marine mammal and sea turtle distribution. Please see the Final Report: New Jersey Offshore Wind Ecological Baseline Studies (OWPEBS), <http://www.nj.gov/dep/dsr/ocean-wind/report.htm>.

7. Where and how data will be stored (include software/format(s) used for data storage and access)?

The appendices of the OWPEBS Final report, available online at <http://www.nj.gov/dep/dsr/ocean-wind/report.htm> provides access to the data generated from this study. Additional data is stored in the form of external harddrives (acoustic data). GIS data is maintained and accessible via the website: <http://www.nj.gov/dep/gis/windpower.html>.

8. How often will data be updated and how will updated data/history of updates be made available?

Since the OWPEBS was concluded in 2009, the report itself will not be amended. Additional data that builds upon this database can be amended by any entity within the State of New Jersey's numerous natural resource branches, and can be added to the databases maintained by these entities.

9. Contact info, including website if applicable:

Dr. Gary A. Buchanan, Manager
New Jersey Department of Environmental Protection
Office of Science
428 E. State St., 1st Fl., Mail Code: 428-01
Ph: (609) 633-8457
Fax: (609) 777-2852

Final Report: New Jersey Offshore Wind Ecological Baseline Studies (OWPEBS),
<http://www.nj.gov/dep/dsr/ocean-wind/report.htm>.

10. Bibliographic resources for methodology if appropriate:

Please refer to the OWPEBS Final Report for Bibliography and additional resources.

11. Papers published based on this work and associated citation information. If possible, please attach the paper with your response. See above.

Northeast Large Pelagics Survey Collaborative

1. Project name

Northeast Large Pelagics Survey Collaborative (NLPSC) consisting of:

- The New England Aquarium (NEAq) contracted by Massachusetts Clean Energy Center (MassCEC)
- University of Rhode Island (URI) subcontracted by NEAq
- The Bioacoustics Research Program (BRP) at Cornell University's Lab of Ornithology subcontracted by NEAq
- Provincetown Center for Coastal Studies (PCCS) subcontracted by NEAq
- Aerial Imaging Solutions (AIS) subcontracted by NEAq

2. Objectives

- Observer sightings for density and abundance estimates of large whales, with a focus on right whales, and turtles in an area of outer continental shelf federal waters off Massachusetts – an area proposed for offshore wind energy development.
- Opportunistic observer sightings of other cetaceans, seals, sharks, and fish.
- Automated vertical photography to capture smaller, cryptic species likely to be missed by observers scanning out to 2 nm. Distribution and abundance estimates of species sighted.
- Opportunistic vertical photography detection of mammals, sharks, fish and fixed fishing gear.
- Acoustic detections showing hourly presence of right, fin and minke whales
- Acoustic detections showing daily presence of humpback and blue whales opportunistically.

3. Proposed data products

- a. Effort and sightings data for submission to URI and subsequent quality assurance / quality checking (QA/QC) processing procedure for incorporation into the North Atlantic Right Whale Consortium (NARWC) database (Kenney, 2010). Standard QA/QC process involves testing for errors, making corrections, communicating with contributors when questions arise and providing feedback for future improvements. NARWC database is archived as a Statistical Analysis System (SAS) dataset. SAS error-checking routines and subroutines have been designed and modified over the years to ensure as much as possible that the data reliably and accurately represent the survey and sightings. SAS macros are updated and improved continuously. New error types are discovered and error-checking routines have evolved.

- b. Vertical photography database. Property of images: 5 – 20 MB each, ground cover of 424' by 282' (0.011 km²) per frame. Average 2,300 images per flight at 5 sec intervals. Average 6,500 images per flight at 0% overlap. Total images analyzed to date: 59,089. Species that are detected and confirmed are incorporated into the data submission to URI / NARWC described above.
- c. Acoustic recordings from MARU deployment to determine spatial and temporal patterns of mysticete whales.

4. Area covered and proposed (or actual) track lines (append map)

Entire area in which aerial tracklines are flown – **Figure 1.**

There are 18 variations for starting points selected randomly: 9 options that are shifted one minute of longitude between 71°08'W and 69°57'W that can be flown west to east (#1-9) or east to west (#10-18). Example of a randomly selected survey: option # 5 (west to east) or # 14 (east to west) – **Figure 2.**

In order to provide the strongest, most reliable density and distribution data, survey protocols follow contemporary line-transect survey methodology. This involves a randomized start point selection for each survey. The 72 minutes of longitude within the survey area are defined as Line Numbers 1 through 72 from west to east. The eight tracklines flown during a given survey have 7 nm separation to best cover the area of interest. The survey option number is randomly selected with options 1 through 9 being flown west to east, and the same line combinations 10 through 18 flown in an east to west direction. By varying directions of flight and starting lines, transect line coverage is not biased and particular sections of the survey area are not overlooked repeatedly at the same time of day, allowing for an unbiased representation of the study area.

BRP deployed array of 6 Marine Autonomous Recording Units (MARUs) - **Figure 3.**

5. Dates of past, present and future surveys

Surveys will run for one year between October 2011 to October 2012, with the goal to fly two surveys per month with an additional four or five at times of increased activity. See Table 1 for flights flown to date.

First deployment of MARUs occurred 09 November 2011 to 26 April 2012. Final deployment of MARUs occurred 26 April with anticipated retrieval around 07 October 2012

6. Data collection methods (append protocol document)

a. Species of focus

Line-transect aerial surveys used to estimate density and abundance of large whales, turtles and other opportunistic species follow standard methodology (Garner et al., 1999).

Vertical photography will cover a portion of the transect line directly beneath the survey aircraft that is not available in aircraft without bubble windows. Automated vertical photography will additionally collect a record of sightings captured, and allow for a smaller airframe to be used by eliminating the need to have dedicated observers covering the vertical trackline. The camera fits into a forward motion compensated (FMC) mount system that was designed specifically for use on NLPSC aerial surveys by Aerial Imaging Solutions (AIS). The FMC mount reduces blur caused by forward motion of the aircraft while the shutter is open. The mount and camera are connected to the notebook computer, and remotely controlled by a program, d-tracker. Flight and camera parameters entered by the NLPSC team determine the required FMC and camera firing interval. D-tracker is a data acquisition system that interfaces with the camera, GPS and computer to record position, time and altitude readings as each frame is collected. Ground coverage per frame is 424' by 282' (0.011 km²). See **Figure 4**.

Passive acoustic monitoring techniques used to record underwater sounds. MARUs are retrieved after approximately 6 months. The flash drive containing the acoustic data is removed, and the data are extracted as digital binary files and converted into standardized audio files (AIF format). The data for each MARU are individually time-aligned using the GPS start and end times in order to compensate for each MARU's potential clock drift (on the scale of minutes). Finally, the data streams from all 6 MARUs are merged to form a series of 6-channel, time-aligned files. An example of a 6-channel, 2-min spectrogram for data recorded on 16 March 2012 is shown in **Figure 5**.

b. Associated environmental data collected

Observers on aerial surveys collect:

- Visibility (0-5nm)
- Glare left / right (None / Slight / Moderate / Severe)
- Beaufort
- Cloud cover (<10 % >90 %)
- Weather (Haze / Clear / Gray etc.)

MARUs will assess ambient noise conditions.

D-tracker downloads the following variables every time the camera fires as well as when initiated by an observer: Time, Lat, Long, GPS Ground Speed, GPS Quality, GPS Number of Satellites, GPS Altitude, GPS Heading, Ground Covered Sideways, Ground Covered Forward, Picture Interval, and Picture Count.

7. Data analysis methods

- Sightings per unit effort analysis (SPUE)
- Density and abundance estimates using right-angle-distance sighting probability models. Environmental parameters may be considered as covariates to improve precision of estimates if sample size is large enough.
- GIS analysis and mapping. Total effort and SPUE per grid cell for each species with enough records will be mapped for each month, season and compilation of entire year.
- Images of individually photographed right whales are processed and incorporated into the North Atlantic Right Whale Catalog. Individuals will be identified and this dataset will be analyzed for total numbers, habitat use / movements, and demographics.
- A combination of automatic detection and manual verification of right / fin / minke whales.
- Opportunistic detections of humpback and blue whales through manual verification while conducting analysis for the acoustic presence of other whale species.

8. Where and how data will be stored (include software/format(s) used for data storage and access)?

Right whale images are stored by NEAq in DIGITS (digital image gathering, and information tracking system), a software system used to process, match and track digital images and data for individual identification studies. The application was built using the MS .Net framework and MS SQL Server database so that it performs well with large digital images in low bandwidth environments. It is server-based and allows for multiple users to manage images and data remotely using password-protected access; digital images maintain original filenames as referred to by contributor, thereby maintaining the link between field data and electronic data; allows for complex searches of whales with similar attributes and presents them side-by-side; automates the majority of the data entry when whales are matched and confirmed to allow a sophisticated array of data queries to be run in MS Access; provides screens to perform annual scarring and health assessments of whales. Although the data are maintained in SQL, they can be accessed and queried through a MS Access front end. The system can be accessed through the NEAq local area network if on site, through a virtual private network over the internet, or through web page to a Citrix server. The software has five broad sections or consoles. They

are the: Image Capture Console, Matching Console, Confirmation Console, Whale Console, and Health and Scarring Console. These serve as interfaces with the underlying database which is maintained in MS SQL.

Sighting information is stored in a single SAS archived dataset by URI – the NARWC database.

The URI Sightings and Effort database is linked to the DIGITS catalog every year or two. All sightings data are exported from DIGITS and URI creates a link between the sightings and their database. Comments that need to be made or discrepancies that cannot be corrected are recorded.

9. How often will data be updated and how will updated data/history of updates be made available?

Standard practice for governmental and NGO contributors to NARWC is to submit one year's survey data in a single submission, so that it is processed together. However, for NLPSC surveys we modified this to submit initially proofed data within two to three weeks after survey completion. Data are not available prior to this due to the laborious process of photo analysis of vertical images. Once CSV data tables have been submitted to Bob Kenney, URI he performs quality assurance / quality checking (QA/QC) processing (Kenney, 2010) and incorporation into the NARWC database. Once a year a copy of the full database is sent to NMFS, NEFSC in Woods Hole.

Directly following the flight, right whale sightings are reported to NOAA NEFSC's Sighting Advisory System. Right whale images are entered and processed in DIGITS soon after the sighting. An entire year's dataset in the Catalog is considered completely processed following final confirmations, about two years after year of sighting. It is possible to expedite this process for datasets of particular interest, for demographic analyses.

Researchers can access relevant data after submitting a data access request, if it is approved by the Right Whale Consortium.

10. Contact info, including website if applicable

Project Sponsor: Massachusetts Clean Energy Center
Contact: Tyler Studds, Project Manager
TStudds@MassCEC.com

Scott D. Kraus, Ph.D., and Jessica Taylor jktaylor@neaq.org
New England Aquarium
Boston, MA 02110

Charles Mayo, PhD., Laura Ganley, and Pat Hughes
Provincetown Center for Coastal Studies
Provincetown, MA 02657

Robert D. Kenney, Ph.D.
University of Rhode Island
Graduate School of Oceanography
Narragansett, RI 02882-1197

Christopher W. Clark, Ph.D. and Aaron N. Rice, Ph.D.
Bioacoustics Research Program
Cornell Lab of Ornithology
Cornell University
Ithaca, NY, 14850, USA

11. Bibliographic resources for methodology if appropriate

Garner, G. W., S. C. Amstrup, J. L. Laake, B. F. J. Manly, L. L. McDonald, and D. G. Robertson (eds.). 1999. *Marine Mammal Survey and Assessment Methods*. A. A. Balkema, Rotterdam, Netherlands.

Kenney, R. D. 2010. *The North Atlantic Right Whale Consortium Database: A Guide for Users and Contributors*. North Atlantic Right Whale Consortium Reference Document 2010-01. University of Rhode Island, Graduate School of Oceanography, Narragansett, RI.

Figure 1. Entire NLPSC survey area in which tracklines are flown.

Survey Area for NLPSC Team

N9134Q [White with Blue Cessna M337B Military 0-2A]

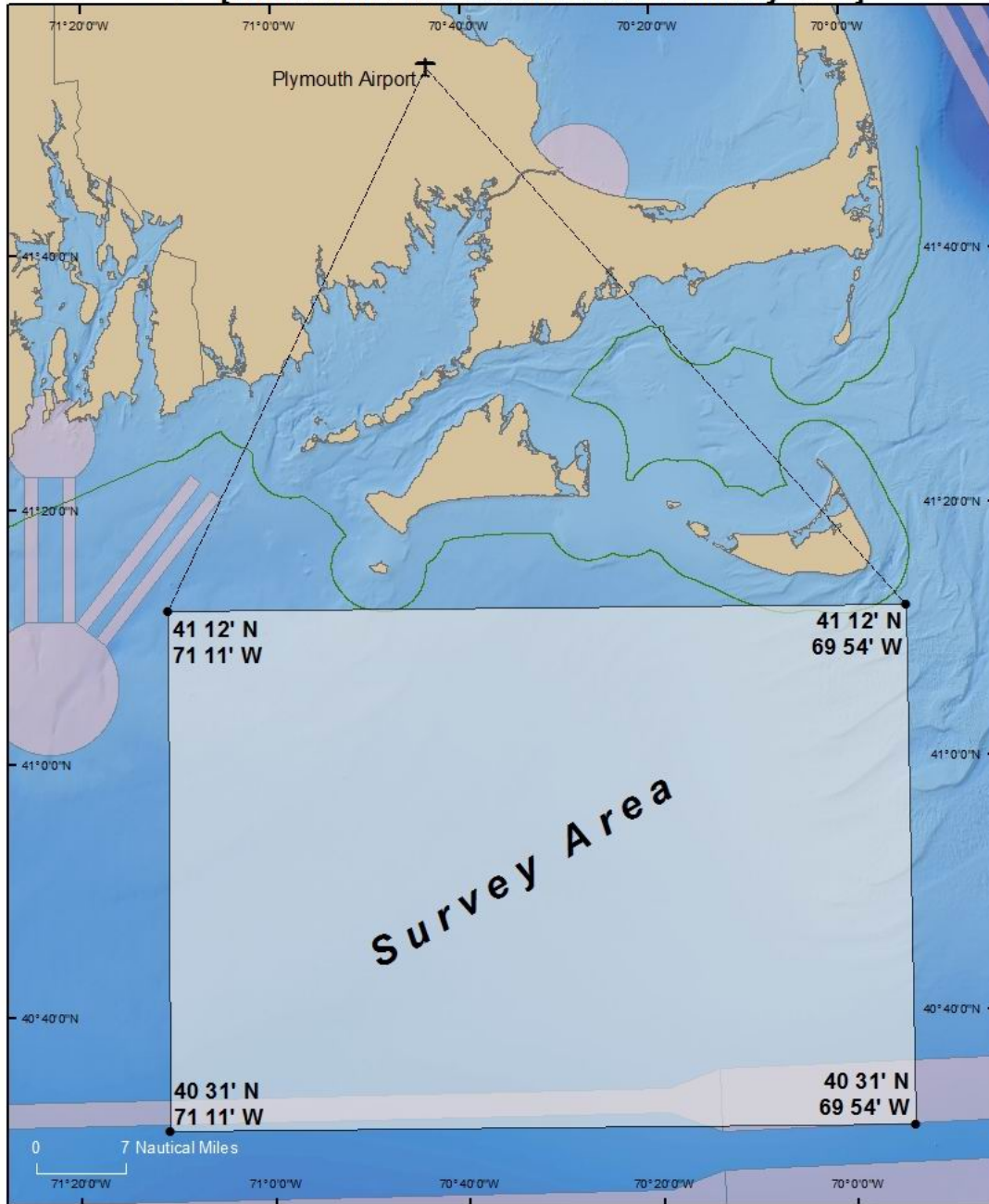

Figure 2. Example of randomly selected survey option # 5 (west to east) or # 14 (east to west).

Start line: W to E - Line #5: 71 4' W
 E to W - Line #68: 70 1' W

Option #5

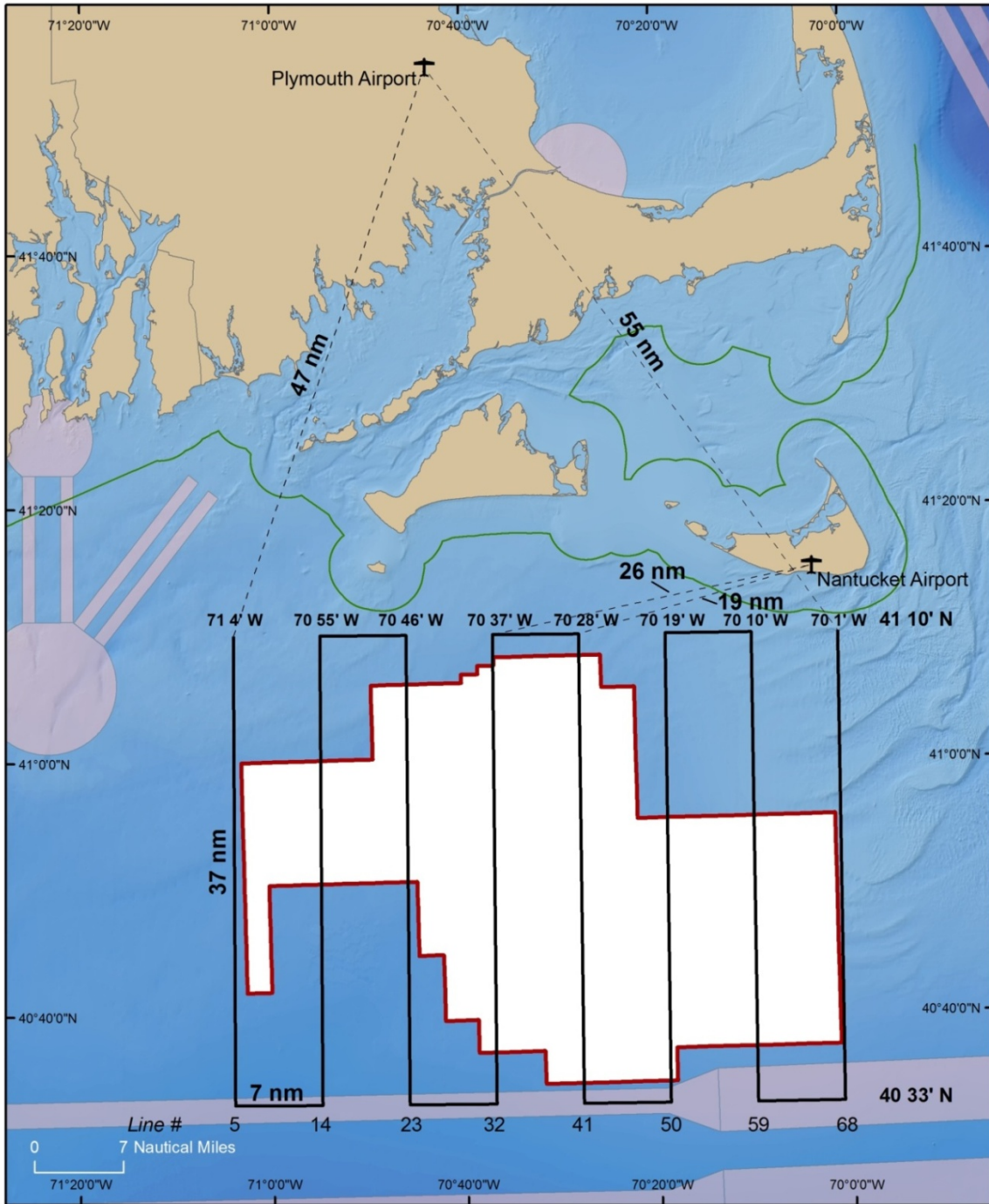

Figure 3. FMC mount system, camera, GPS and notebook set-up with display below.

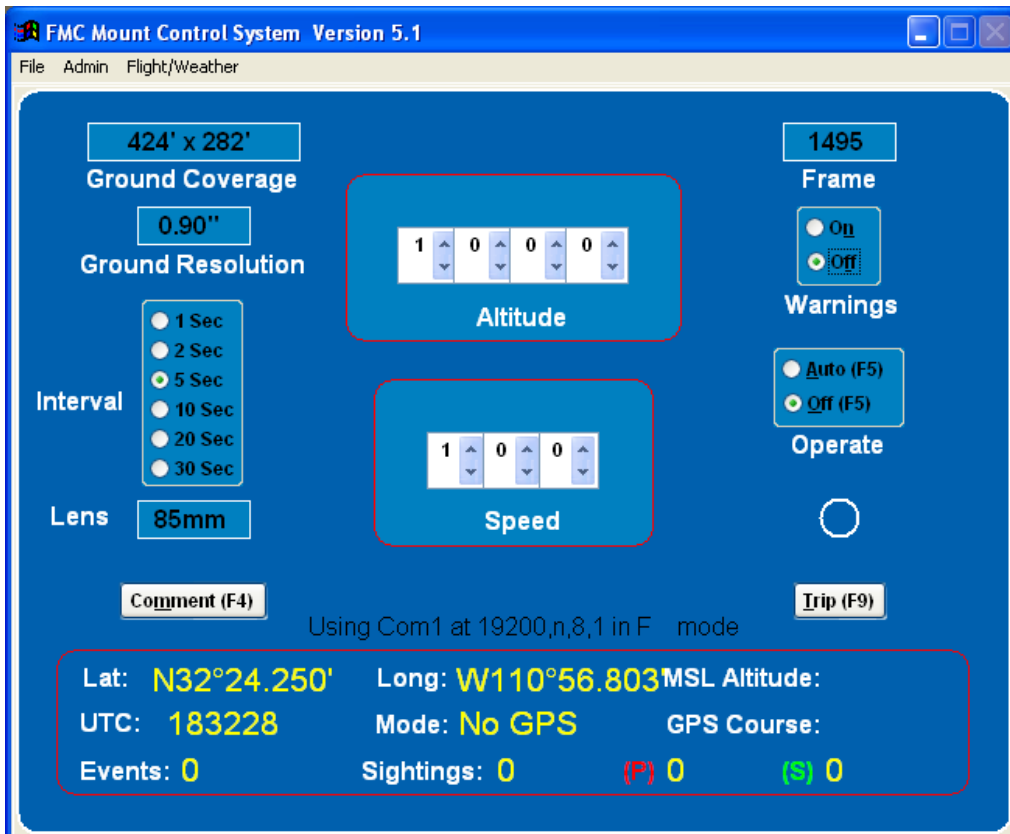
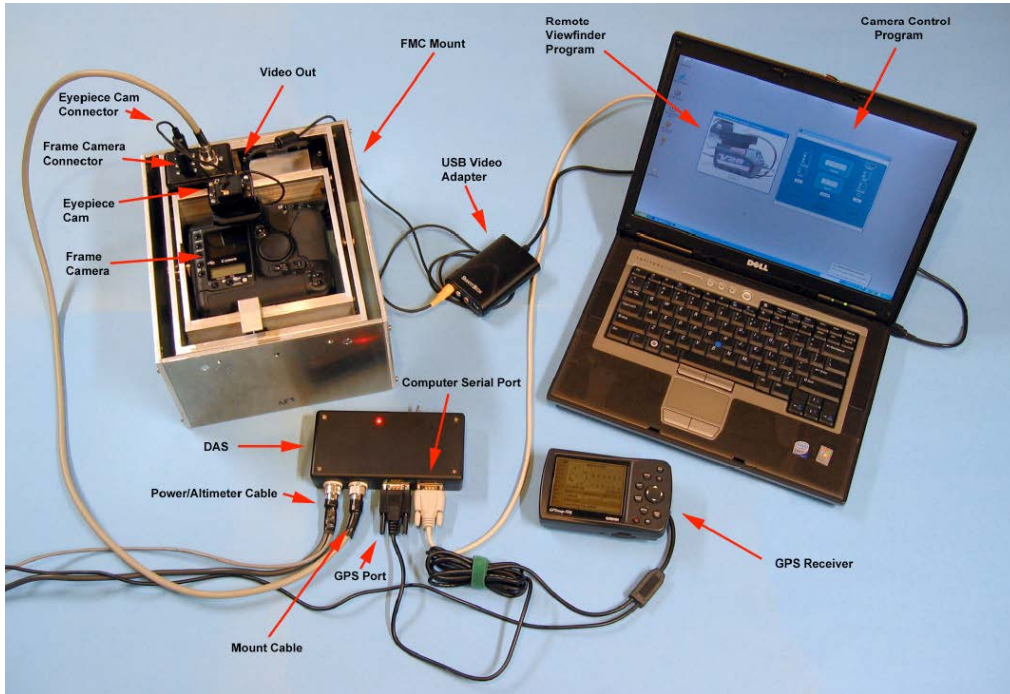

Figure 4. BRP deployed MARUs.

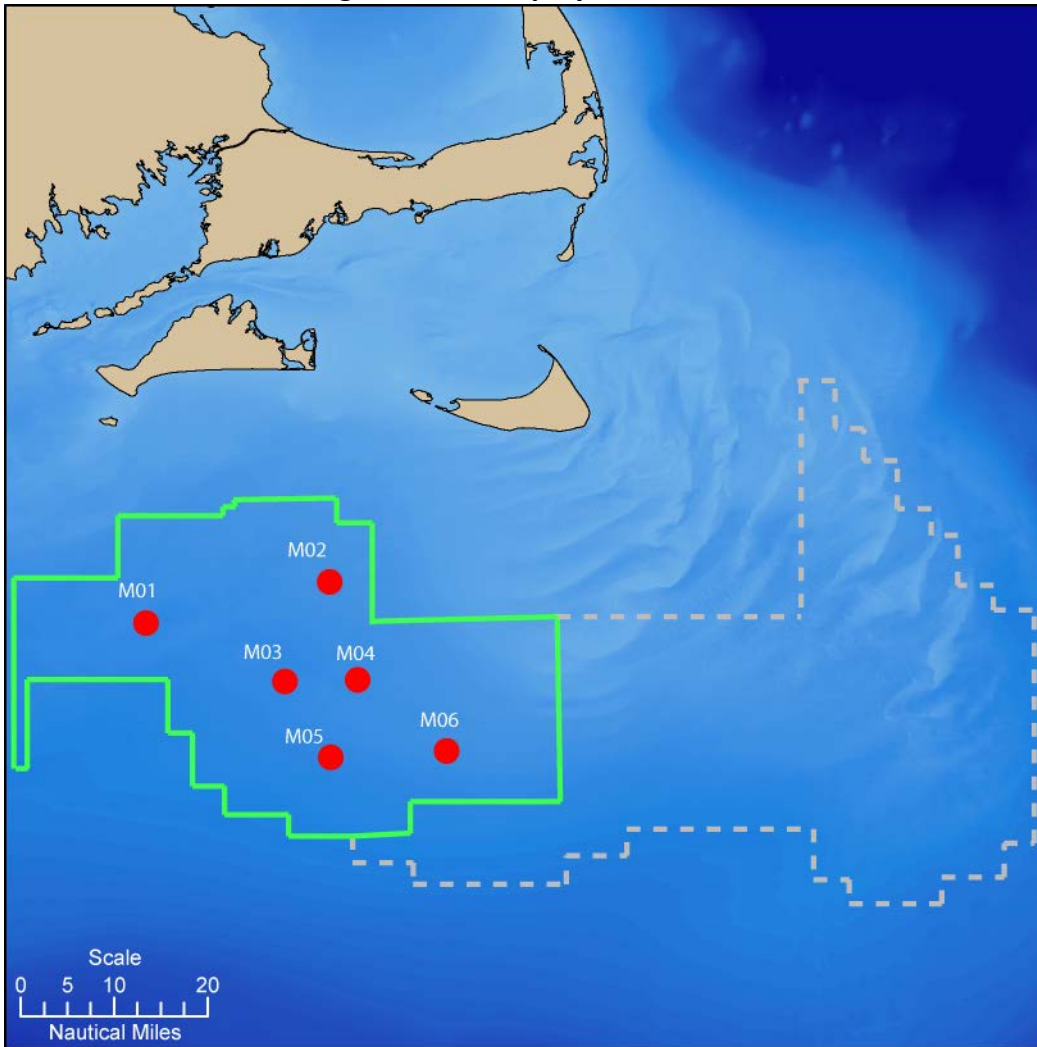

Table 1: NLPSC aerial surveys flown to date

Survey #	Survey Date	Hours
NLPSC001	10/9/2011	5.3
NLPSC002	10/23/2011	5.5
NLPSC003	11/6/2011	5.5
NLPSC004	11/26/2011	5.1
NLPSC005	12/5/2011	1.2
NLPSC006	12/12/2011	7.2
NLPSC007	1/9/2012	4.8
NLPSC008	1/26/2012	4.8
NLPSC009	2/5/2012	5.5
NLPSC010	3/6/2012	4.3
NLPSC011	3/23/2012	7
NLPSC012	3/24/2012	7
NLPSC013	4/1/2012	6.7
NLPSC014	4/6/2012	6.4
NLPSC015	5/7/2012	6.4
NLPSC016	5/18/2012	5.6
NLPSC017	6/10/2012	5.5
NLPSC018	6/24/2012	5.7
NLPSC019	7/3/2012	5.5
NLPSC020	7/20/2012	4.8

Rhode Island Ocean Special Area Management Plan (OSAMP)-Avian Surveys

1. Project name

Rhode Island Ocean Special Area Management Plan (OSAMP)-Avian Surveys.
Our avian surveys were one component of a large marine spatial planning exercise of Block Island and Rhode Island Sound for proposed offshore wind development.

2. Objectives

Assess temporal variation (seasonal and annual) in avian spatial distribution and abundance in the OSAMP study area.
Quantify flight behavior of birds in the OSAMP study area.

3. Proposed data products

Predictive density surfaces of common avian species by season (Density Surface Models; DSMs).

4. Area covered and proposed (or actual) track lines (append map)

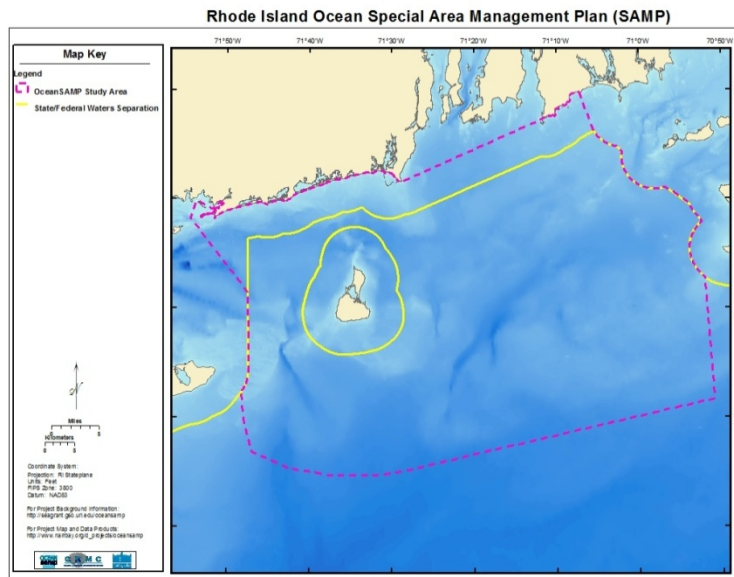

Map of OSAMP study area (ca. 3800 km²)

Rhode Island Ocean Special Area Management Plan (SAMP)

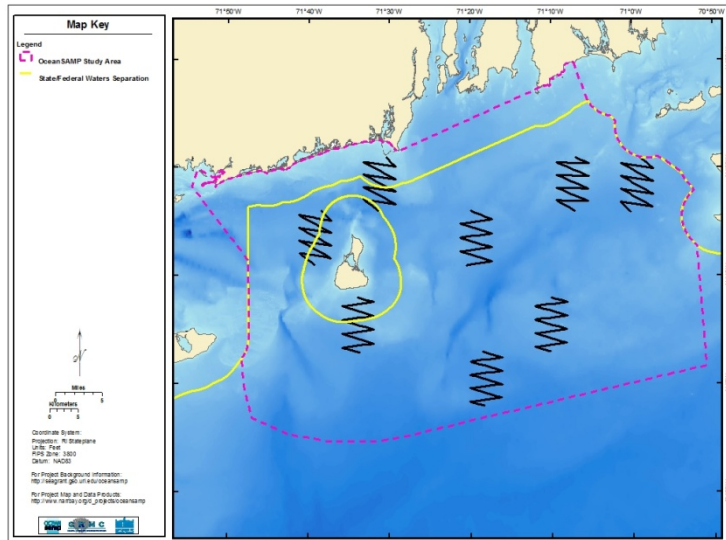

Map of OSAMP study area and 8 ship-based survey grids (black zig zags). We conducted 94 ship-based line transect surveys on 46 survey days. We had 14,833 total detections of 60 species. We used data from these surveys to model the spatial distribution and abundance of common marine bird species by season across our study area (dotted line).

Rhode Island Ocean Special Area Management Plan (SAMP)

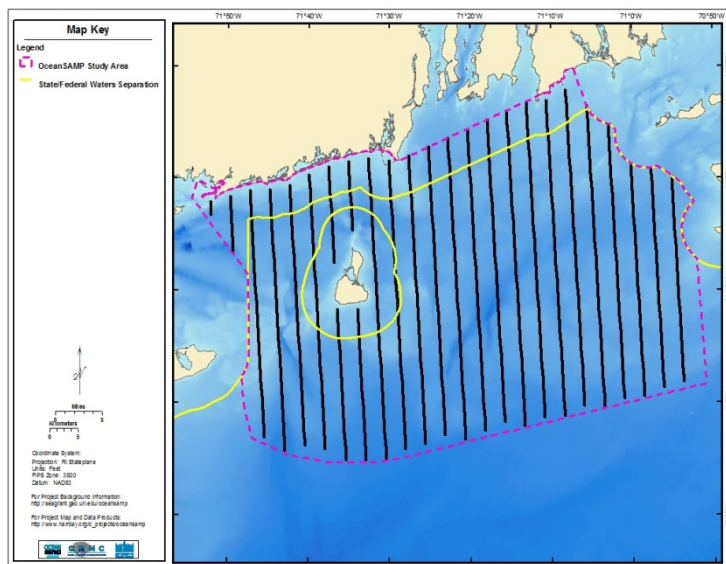

Map of OSAMP study area and 24 aerial-based strip transects (black circles). We conducted 29 total surveys and had a total of 10,587 detections of 23 species. We used data from these surveys to model the spatial distribution and abundance of common marine bird species by season across our study area (dotted line).

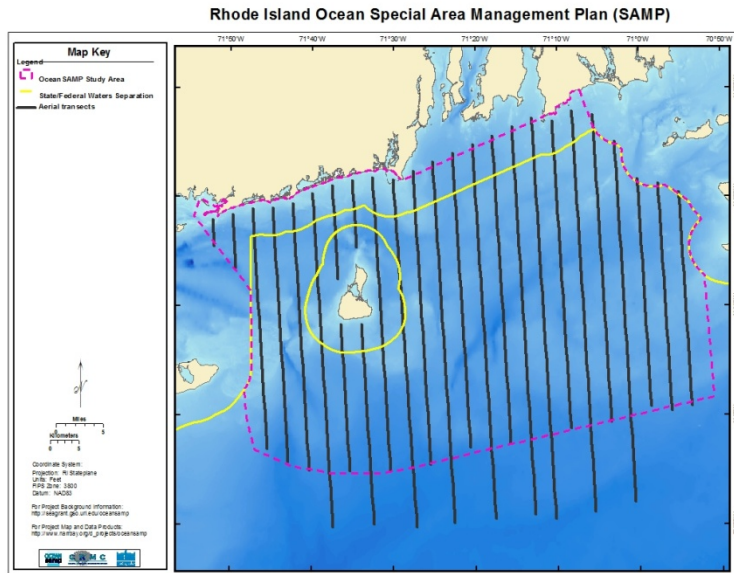

Map of OSAMP study area and 24 aerial-based line transects (black circles). We conducted 44 total surveys from 10 December 2010 to 21 July 2012. We will use the data from these surveys to further model the spatial distribution and abundance of common marine bird species by season across our study area (dotted line).

5. Dates of past, present and future surveys.

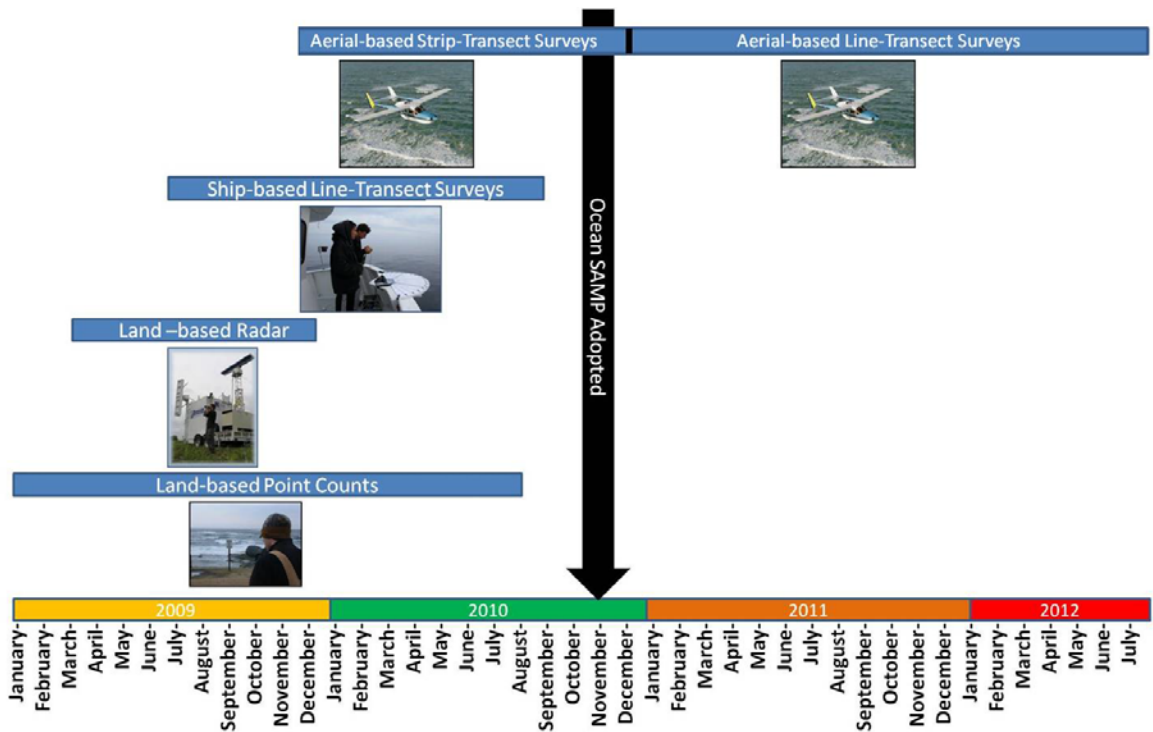

OSAMP Avian Survey Timeline. Note: surveys continue until the end of July 2012.

6. Data collection methods (append protocol document)

Ship-based Line Transect Surveys:

All ship-based surveys used the following line-transect sampling method (modified from Camphuysen et al. 2004) so that we could later estimate the density of each bird species or guild in the study area given their probability of detection. Two sampling grids were sampled per survey day; the order in which the grids were surveyed was reversed from month to month. We began surveys at sunrise when there was enough light to allow observers to identify individuals to species. During surveys, the ship traveled at a constant speed of 10 knots (11.5 mph), which was slow enough to allow for detection of all individuals along the ships trackline. We conducted all observations from the upper level of the vessel at the bow of the ship and from either the port or starboard side of the ship (depending on which side offered optimal viewing conditions). Observers used their unaided eye or a pair of 10 x 42 binoculars to detect birds. We conducted all surveys using an observer and an observer/recorder. We recorded observations in the field using a handheld PDA (Juno Trimble) equipped with Cybertracker data collection software (Cybertracker: www.cybertracker.co.za). Occasionally, when viewing conditions were difficult (e.g., birds were backlit) or birds quickly dove under water upon detection, we identified individuals to a guild (e.g., large shearwater, scoter spp) instead of to species. We visually estimated the distance to each bird detected, both on the water and in flight. From February 2009 to September 2009, we only measured distance to birds on the water and we estimated this distance from the ships trackline as <50m, 50-100m, 101-200m, 201-300m. From September 2009 through August 2010, we estimated the actual distance (m) and the bearing to each detection (an individual bird or a flock of birds) regardless of whether the bird was on the water or in flight. We estimated the bearing by using a large protractor mounted at the bow of the ship. This allowed us to calculate a perpendicular distance to the transect line for all individuals using the formula $x = r * \sin(\text{bearing angle})$, where x is the distance to the transect line from the bird or flock, r is the estimated distance from bird or flock to observer, and bearing angle was estimated by the observer using the large protractor.

We also recorded the behavior of all observed individuals or flocks as feeding, loafing, resting, or milling for bird(s) on the water. For birds in flight, we recorded birds as feeding if so observed. For individuals or flocks in flight, vertical flight elevation was estimated into discrete elevation bins (<10m, 10-25m, 26-125m, >126 m) along with the individual or flock's flight direction (N, NE, E, SE, S, SW, W, NW, variable). Birds following the ship ("ship followers") were ignored and not recorded. Information on anthropogenic influences during the survey that may have been attracting birds to the sampling area was also recorded (e.g., fishing boats or floating debris). We recorded environmental data at the beginning of each line transect including: wind speed, wind direction, sea state, visibility and weather (% cloud cover, precipitation). Surveys did not take place when the Beaufort sea state was 4 or higher. Data were recorded with a handheld GPS-enabled PDA (Trimble Juno) loaded with Cybertracker data collection

software (www.cybertracker.org) from June 2009 to August 2010. A handheld Garmin unit (Garmin Marine GPS 76) recorded a trackline when the ship was on survey (unit recorded a GPS location every 15 seconds).

- a. Species of focus
All marine birds.
- b. Associated environmental data collected
None collected. Only environmental data describing survey conditions.

Aerial-based Strip Transect Surveys:

We performed 29 systematic aerial surveys approximately every one to two weeks from 2 December 2009 to 31 August 2010 to quantify the abundance of all species of waterbirds within the OSAMP study area. Based on our observations of the movement phenology of waterbirds during land-based point counts in nearshore habitats from January to Feb 2009, we conducted the aerial surveys during mid-day (usually 1000-1500 hrs) to accurately detect birds that had completed their post-dawn or not yet begun their pre-sunset movements from roosting to feeding areas. We conducted surveys along 24 transect lines that were spaced 3 km apart, with an average transect length of 46.26 km \pm 12.34 km (SD) (min = 7.77 km, max = 57.97 km). Transects were oriented perpendicular to the coast and equally covered all of the OSAMP study area. We conducted all aerial surveys from a twin engine Cessna Skymaster aircraft that flew at an altitude of 152 m (500ft) above mean sea level at a constant speed of 160 km/hr (100 miles/hr).

We had two observers on each survey flight who were located behind the pilot and co-pilot seats (one on each side of the plane). Observers scanned a fixed-width strip transect (107 m [350ft]) on their side of the plane. To ensure that observers only recorded birds within this fixed distance, we used a clinometer to mark set angles (38 to 58 degrees) with black electrical tape on the aircraft's wing struts to aid observers in determining which individuals were in or out of the strip transect. Observers recorded all individuals and flocks to species when possible or to an avian guild (e.g., Alcid spp., Loon spp.) when necessary. Individuals or flocks were recorded as either on the water or in flight.

We also recorded any anthropogenic influences detected during the survey that were apparently attracting birds to the area (e.g., fishing boats, whales or floating debris). We recorded the following environmental data at the beginning of each transect line or when conditions changed: wind direction, wind speed, wave height, glare (none, minimal, moderate, and heavy), and whitecaps (none, minimal, moderate, and heavy). Observers recorded individual sightings with a time stamp (to the nearest second) on a digital voice recorder. Each observer had a digital stopwatch that was synchronized with a handheld Garmin (Garmin handheld Marine 76) gps unit that recorded the

aircraft's position every 5 seconds. Surveys were not performed when wind speed was greater than 20 knots (23 mph) and/or waves were > 1.2 m (4 ft) tall. Unfortunately, due to the orientation of the transect lines and the orientation of the sun; glare was problematic on sunny days when surveying transect lines from north to south. If glare compromised the detection of birds on one side of the plane, that surveyor went "off" survey.

- a. Species of focus
-All marine birds.
- b. Associated environmental data collected
-None collected. Only environmental data describing survey conditions.

Aerial-based Line Transect Surveys

We conducted 44 aerial-based line transect surveys from 12 December 2010 to 21 July 2012 along 24 transect lines oriented perpendicular to the coast that were spaced 3 km apart, with an average transect length of 46.26 km \pm 12.34 km (SD) (min = 7.77 km, max = 57.97 km) (Fig. 3). We conducted all aerial surveys from a twin engine Cessna Skymaster aircraft that flew at an altitude of 76 m (250 ft) above mean sea level at a constant speed of 160 km/hr (100 miles/hr).

We had two observers on each survey flight who were located behind the pilot and co-pilot seats (one on each side of the plane). We used two observers and surveyed three distance bins out to 1000m (A = 44-163m, B = 164-432m and C = 433-1000m) from both sides of the plane, with boundaries of the observation bins marked on the aircraft's wing struts with black electric tape (Camphuysen et al. 2004). Observers used their unaided eye to detect individual birds or flocks. To ensure that observers only recorded birds within these fixed distances, we used a clinometer to mark set angles with black electrical tape on the aircraft's wing struts. Observers recorded all individuals and flocks to species when possible or to an avian guild (e.g., Alcid spp., Loon spp.) when necessary. Individuals or flocks were recorded as either on the water or in flight.

We also recorded any anthropogenic influences detected during the survey that were apparently attracting birds to the area (e.g., fishing boats, whales or floating debris). We recorded the following environmental data at the beginning of each transect line or when conditions changed: wind direction, wind speed, wave height, glare (none, minimal, moderate, and heavy), whitecaps (none, minimal, moderate, and heavy), and survey conditions (poor, fair, good, excellent). Observers recorded individual sightings with a time stamp (to the nearest second) on a digital voice recorder. Each observer had a digital stopwatch that was synchronized with a Garmin gps unit (Garmin 496) which recorded the aircraft's position every 2 seconds. Surveys were not performed when wind speed was greater than 20 knots (23 mph) and/or waves were > 1.2 m (4 ft) tall. Unfortunately, due to the orientation of the transect lines and the orientation of

the sun; glare was problematic on sunny days when surveying transect lines from north to south. If glare compromised the detection of birds on one side of the plane, that surveyor went “off” survey.

- a. Species of focus
All marine birds.
- b. Associated environmental data collected
None collected. Only environmental data describing survey conditions.

7. Data analysis methods

Density surface models (Thomas et al. 2010; Herr et al. 2009; Hedley and Buckland 2004).

8. Where and how data will be stored (include software/format(s) used for data storage and access)?

URI Environmental Data Center (excel files containing data on survey effort and observations).

Available to public.

Available in Atlantic Seabird Survey Compendium (USGS).

9. How often will data be updated and how will updated data/history of updates be made available?

All data is currently available minus the aerial-based line transect survey data set (Will be available August 2012).

10. Contact info, including website if applicable.

Peter Paton (401) 874-2986 ppaton@uri.edu
<http://seagrant.gso.uri.edu/oceansamp/>

11. Bibliographic resources for methodology if appropriate

Camphuysen, K. J., Fox, A. D., Leopold, M. F. and Petersen, I. K. (2004) *Towards standardised seabirds at sea census techniques in connection with environmental impact assessments for offshore wind farms in the_U.K.: a comparison of ship and aerial sampling methods for marine birds, and their applicability to offshore wind farm assessments* (PDF, 2.7 mb), NIOZ report to COWRIE (BAM – 02-2002), Texel, 37pp.

Winiarski KJ, Paton P, Trocki CL, McWilliams SR. 2011. Spatial distribution, abundance, and flight ecology of birds in nearshore and offshore waters of Rhode Island: January 2009 to August 2010. Rhode Island Ocean Special Area Management Plan Interim Report.

12. Papers published based on this work and associated citation information. If possible, please attach the paper with your response.

Winiarski KJ, Paton P, Trocki CL, McWilliams SR. 2011. Spatial distribution, abundance, and flight ecology of birds in nearshore and offshore waters of Rhode Island: January 2009 to August 2010. Rhode Island Ocean Special Area Management Plan Interim Report.

Paton P, Winiarski KJ, Trocki CT, McWilliams SR. 2010. Spatial distribution, abundance, and flight ecology of birds in nearshore and offshore waters of Rhode Island. Rhode Island Ocean Special Area Management Plan Interim Report.

VA Whale Migration Corridors for Marine Spatial Planning

1) Project name

VA Whale Migration Corridors for Marine Spatial Planning

2) Objectives

To better understand whale presence in and around the VA wind energy area (WEA)

3) Proposed data products

Large whale presence and density data for use by state and federal protected species managers, and data points with associated effort for OBIS and MARCO web portals

4) Area covered and proposed (or actual) track lines

The VA WEA and surrounding waters – see Figure 1

5) Dates of past, present and future surveys

Fall of 2012 through spring 2013

6) Data collection methods (append protocol document)

Data collection methods (append protocol document) – aerial surveys will consist of two days of effort per month using a Cessna 337 Skymaster flying at 1,000 ft and 100 kts using standard distance sampling techniques. Observations from left and right observers are treated separately resulting in two strip-width data sets.

1. Large whales (*Megaptera novaeangliae* – humpback, *Baleanoptera physalus* – fin, *Eubalaena glacialis* – right, and possible *B. borealis* – sei and *B. acutorstata* – minke)
2. Environmental data include sea state, glare, turbidity, cloud cover and overall sighting quality

7) Data analysis methods

VAQF will generate density estimates using Distance software.

8) Where and how data will be stored (include software/format(s) used for data storage and access)?

Data will be stored at the Virginia Aquarium on our VAQF server

9) How often will data be updated and how will updated data/history of updates be made available?

We intend to upload final data to the OBIS and MARCO web portals at the culmination of the project

10) Contact info, including website if applicable

Susan Barco, Research Coordinator & Senior Scientist

Phone: (757) 385-6476

E-mail: sgbarco@virginiaaquarium.com

Virginia Aquarium & Marine Science Center Foundation

717 General Booth Blvd.

Virginia Beach, VA 23451

W. Mark Swingle

Director of Research & Conservation

Phone: (757) 385-0326

E-Mail: MSwingle@VirginiaAquarium.com

Virginia Aquarium & Marine Science Center Foundation

717 General Booth Blvd.

Virginia Beach, VA 23451

11) Bibliographic resources for methodology if appropriate

Buckland S.T., Anderson D.R., Burnham K.P., Laake J.L., Borchers D.L. and Thomas L. (2001) *Introduction to distance sampling: estimating abundance of biological populations*. Oxford University Press, Oxford, UK.

12) Papers published based on this work and associated citation information. If possible, please attach the paper with your response.

Project has not yet started

Figure 1: Survey area for the project.

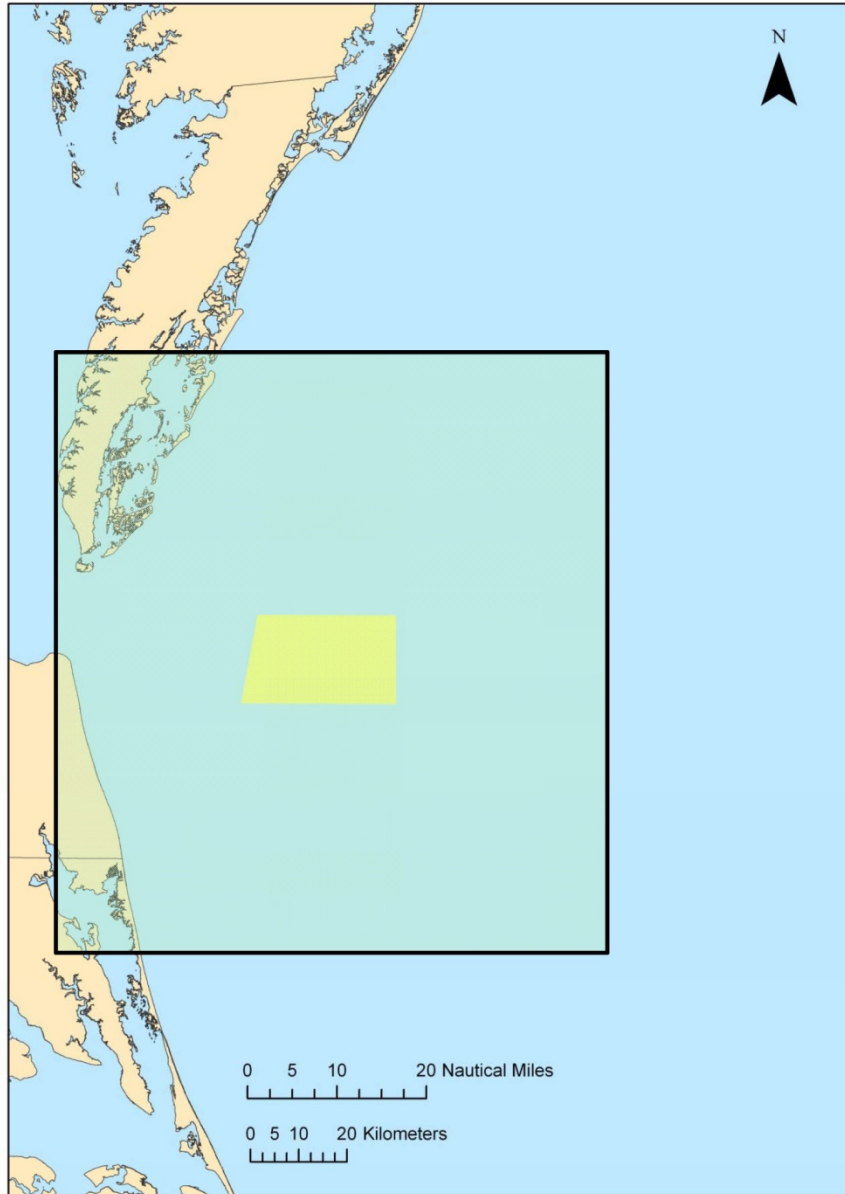

VA/MD Sea Turtle Research & Conservation Initiative

1) Project name

VA/MD Sea Turtle Research & Conservation Initiative

2) Objectives

To develop robust annual abundance estimates for Chesapeake Bay and surrounding ocean waters off VA and MD

3) Proposed data products

Abundance estimates for use by state and federal protected species managers, and data points with associated effort for OBIS and MARCO web portals

4) Area covered and proposed (or actual) track lines

Chesapeake Bay and coastal ocean waters up to 30m off VA and MD – see Figure 1

5) Dates of past, present and future surveys

Spring summer and fall of 2011 and spring and fall of 2012

6) Data collection methods (append protocol document)

Data collection methods (append protocol document) – Attachment 1

1. Sea turtles (primarily *Caretta caretta* – loggerhead, but also *Lepidochelys kempii* – Kemp's ridley, *Chelonia mydas* – green and *Dermochelys coriacea* – leatherback)
2. *Tursiops truncatus* – bottlenose dolphins are also regularly sighted
3. Environmental data include sea state, glare, turbidity, cloud cover and overall sighting quality

7) Data analysis methods

See Attachment 2 for data analysis methods

8) Where and how data will be stored (include software/format(s) used for data storage and access)?

Data will be stored at the Virginia Aquarium on our VAQF server

9) How often will data be updated and how will updated data/history of updates be made available?

We intend to upload final data to the OBIS and MARCO web portals at the culmination of the project

10) Contact info, including website if applicable

Susan Barco, Research Coordinator & Senior Scientist

Phone: (757) 385-6476

E-mail: sgbarco@virginiaaquarium.com

Virginia Aquarium & Marine Science Center Foundation

717 General Booth Blvd.

Virginia Beach, VA 23451

W. Mark Swingle

Director of Research & Conservation

Phone: (757) 385-0326

E-Mail: MSwingle@VirginiaAquarium.com

Virginia Aquarium & Marine Science Center Foundation

717 General Booth Blvd.

Virginia Beach, VA 23451

11) Bibliographic resources for methodology if appropriate

Hiby L. and Lovell P. (1998) Using aircraft in formation to estimate abundance of harbour porpoise. *Biometrics* 54: 1280-1289.

Buckland S.T., Anderson D.R., Burnham K.P., Laake J.L., Borchers D.L. and Thomas L. (2001) *Introduction to distance sampling: estimating abundance of biological populations*. Oxford University Press, Oxford, UK.

12) Papers published based on this work and associated citation information. If possible, please attach the paper with your response.

None to date.

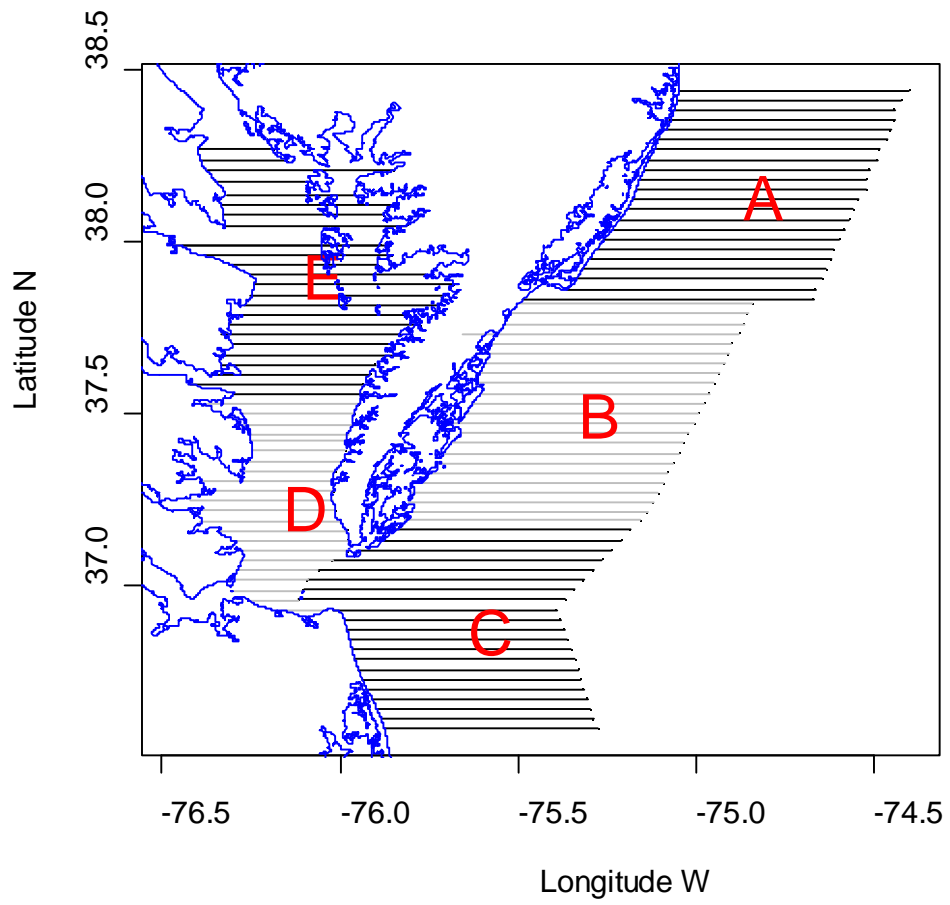

Figure 1: Survey lines and strata (red letters) for the project.

Attachment 1: Survey methods for flights conducted by subcontractor Riverhead Foundation for Marine Research & Preservation

SURVEY METHODS

Aerial surveys were conducted along the coastal waters and bays of Virginia and Maryland. This project was initially broken into three survey periods. The first period is defined as the last week in May to the first week in June, the second period is from the last week in July to first week in August and the third period is from the last week in September to the first week in October. These periods are guidelines established to represent the seasonality of sightings. The survey platform is a De Havilland twin otter DHC-6 modified for observational research. The aircraft is equipped with two bubble observation windows (port and starboard) and a belly observer position. There is a position for two data recorders to document all sightings using a computer program (VOR) for later analysis. The aircraft is configured so as to have two forward observers and a data recorder on their own communication system and have a second team consisting of a belly observer and one additional observer (either port or starboard) along with a data recorder. Communications were configured to enable the two teams to function independently thereby acting as two individual surveys teams. Each observer monitors their area on a track line and reports sightings of marine mammals and sea turtles. Once an animal is sighted the observer will report the sighting to the data recorder when the animal is perpendicular to the aircraft. The observer will report the angle to the animal, species, number of animals and swim direction. In the case of sea turtles the observer reports the relative size of the animal small (less than 40cm), medium (greater than 40cm and less than 80cm) and large (greater than 80 cm). Environmental data, such as sea state, glare, turbidity, cloud cover and overall sighting quality are collected during the survey and updated as changes occur.

After consultation with University of St. Andrews it was agreed to test the feasibility of using two teams and the Hiby (1998) circle back method. With using this method the two independent teams could call for the aircraft to circle back on the track line if they observed a solitary animal within 600 of the track line. Once the circle back was initiated the aircraft would proceed for ten seconds on the track line before breaking track and circling back. If another animal of the same species was seen within those ten seconds the circle back was aborted. Once the circle back was initiated the aircraft would fly parallel to the track line in a reciprocal direction for 90 seconds so as to rejoin the line before the initial sighting. The data recorder would then record that the aircraft rejoined the track line and the survey would record in accordance with previous protocols. If only one team observes the initial animal the second team will proceed with entering the sighting line and the code “zz” as a space holder.

Five survey areas were identified, three along the VA and MD border (NM= northern Maryland, NV= northern Virginia and SV= southern Virginia) and two in the upper and lower Chesapeake Bay (“uc” and “lc” respectively) (Figure 8.0). Within each strata east

west lines were constructed at two mile spacing. The surveys are conducted in the Chesapeake Bay from the MD / VA border and the coastal waters to 48 kilometers offshore between the Delaware border in the north and the Virginia border in the south. Each line is assigned a number followed by a group. At the beginning of each survey a random number is generated and the group represented by that number is flown. Once all lines able to be flown are completed within those strata the survey is considered complete. The proposed spacing regime is 113 lines in all the areas totaling 5,367km. The total distance for each survey group ranged for 960km to 1230km (Table 1.0). To capitalize on good weather days we attempted to fly two missions per day enabling us to survey the entire coast and the Chesapeake Bay in one day. The survey lines were then plotted against aviation charts to identify the warning areas and closures due to military operations. The survey area outlined had five warning areas within the Atlantic (W-386, W-50A, W-50B, W-50C, W-72A) and six restricted areas, three in the Chesapeake (R-4005, R-6609, R-4006) and three in the Atlantic (R-6604A, R-6604B, R-6606). These restricted areas do not include restrictions due to airports or the District of Colombia defense ring.

Attachment 2: Data analysis methods for flights conducted by subcontractor St. Andrews University

ANALYSIS METHODS

Estimating density and abundance

Within each stratum, group density (D_s) and group abundance (N_s) of animals available for detection were estimated as follows:

$$\hat{D}_s = \frac{1}{2wL} \sum_{j=1}^n \frac{1}{\hat{p}_j} \quad \text{and} \quad \hat{N}_s = A\hat{D}_s$$

where A is the size of stratum, w is the truncation distance, L is the total effort achieved in the stratum, n is the total number of detections in the stratum and \hat{p}_j is the estimated probability of detecting group j (see below). Individual animal density (D) and abundance (N) were obtained from

$$\hat{D} = \frac{1}{2wL} \sum_{j=1}^n \frac{s_j}{\hat{p}_j} \quad \text{and} \quad \hat{N} = A\hat{D}$$

where s_j is the recorded group size for group j . The expected group size ($E[s]$) was given by

$$E[s] = \frac{\hat{N}}{\hat{N}_s}$$

The variance of the encounter rate (n/L) was estimated using the method developed by Innes *et al.* (2002) using the R2 form of the estimator as in Fewster *et al.* (2009) - the default estimator in Distance (Thomas *et al.* 2010).

Estimation of detection probabilities

Having two teams of observers allowed a mark-recapture distance sampling approach to be used to estimate the probability of detection (Laake and Borchers 2004). The observing teams acted independently and since there was unlikely to have been responsive movement between detection by one team and the other team, the model used to analyse the data assumed an independent observer (IO) configuration with point independence (detections are assumed to be independent only at the point where perpendicular distance is zero ie. on the trackline). To fit an IO point independence model, two subsidiary models are required: a distance sampling (DS) model fitted to all unique sightings assuming that the intercept at perpendicular distance zero was one (denoted as $g(0)=1$); and a mark-recapture (MR) detection function to estimate the probability of detection by at least one team at distance zero. This probability of detection at perpendicular distance zero is then used to adjust the DS detection function to obtain an overall probability of detection.

For the DS model, both a hazard-rate ($1-\exp(-x/\sigma)^{-b}$) and a half-normal form ($\exp(-x^2/2\sigma^2)$) were considered as suitable forms for the detection function (where σ is a scale parameter, x is perpendicular distance and b is a shape parameter) (Buckland *et al.* 2001). The effects of covariates, other than perpendicular distance, were incorporated into the detection function model by setting the scale parameter in the model to be an exponential function of the covariates (Marques and Buckland 2004). Thus, the covariates could affect the rate at which detection probability decreases as a function of distance, but not the shape of the detection function. The covariates considered for inclusion were season, strata, observer position (left, right or centre), group size and Beaufort sea state. For dolphins, group size was also considered as a factor variable with four levels representing groups of size one, 2-4 animals, 5-9 animals and ≥ 10 animals. Akaike's Information Criterion (AIC) and goodness of fit statistics were used to select the final model and all model selection was performed in the program Distance (Thomas *et al.* 2010; version 6.1 Beta 1 and version 2.0.6 of the mrds R library).

The MR detection function defines the probability that an animal at given perpendicular distance with covariates z , was detected by a team q ($q=1$ or 2) given that it was seen by the other team, and is denoted by $p_{q|3-q}(x, z)$. It was modelled using the logistic form:

$$p_{1|2}(x, z) = p_{2|1}(x, z) = \frac{\exp\left\{\beta_0 + \beta_1 x + \sum_{k=1}^K \beta_{k+1} z_k\right\}}{1 + \exp\left\{\beta_0 + \beta_1 x + \sum_{k=1}^K \beta_{k+1} z_k\right\}}$$

where $\beta_0, \beta_1, \dots, \beta_{K+1}$ represent the parameters to be estimated and K is the number of covariates other than distance. The same variables as before were considered for inclusion as explanatory variables, in addition to observer team. Note that if team is included then $p_{1|2}(0, z)$ will not equal $p_{2|1}(0, z)$. Akaike's Information Criterion (AIC) was again used for model selection. The intercept of the selected model provides an estimate of the probability of detection on the trackline by at least one team.

Wallops Island and Onslow Bay USWTR Aerial Survey

1) Project name

Wallops Island and Onslow Bay USWTR aerial survey

2) Objectives

Estimate the distribution and abundance of cetaceans and sea turtles in this area of interest.

3) Proposed data products

4) Area covered and proposed (or actual) track lines (append map)

Boundaries of survey area are: North: 34.2724, West: 77.1926, East: 76.0252, South: 33.3596

Map is attached

5) Dates of past, present and future surveys

Wallops Island and Onslow Bay initial surveys from September 1998 – October 1999

Onslow Bay June 26, 2007 – April 20, 2011

6) Data collection methods (append protocol document)

Aerial surveys consisted of 2-3 days of effort a month using a Cessna 337 Skymaster flying at 1000ft and 100knts using standard distance sampling techniques. Observations from left and right observers are recorded separately resulting in two strip-width datasets.

- a. Surveys targeted cetacean and sea turtle species inside the survey area.
- b. Also recorded cloud cover and Beaufort Sea State.

7) Data analysis methods

Density and abundance estimates are generated by the University of St. Andrews, Scotland.

8) Where and how data will be stored (include software/format(s) used for data storage and access)?

Data is stored locally on the University of North Carolina Wilmington network. Formats of data include excel spreadsheets, digital images are in standard JPEG format, Maps of sightings are in JPEG and also ArcGIS.mxd files.

9) How often will data be updated and how will updated data/history of updates be made available?

All data from this project is currently loaded to the OBIS SEAMAP website and is available to the public. Data usage requests can be made through this site using the standard agreement supplied through OBIS SEAMAP.

10. Contact info, including website if applicable

Please contact William McLellan at the University of North Carolina Wilmington

OBIS SEAMAP: <http://seamap.env.duke.edu/>

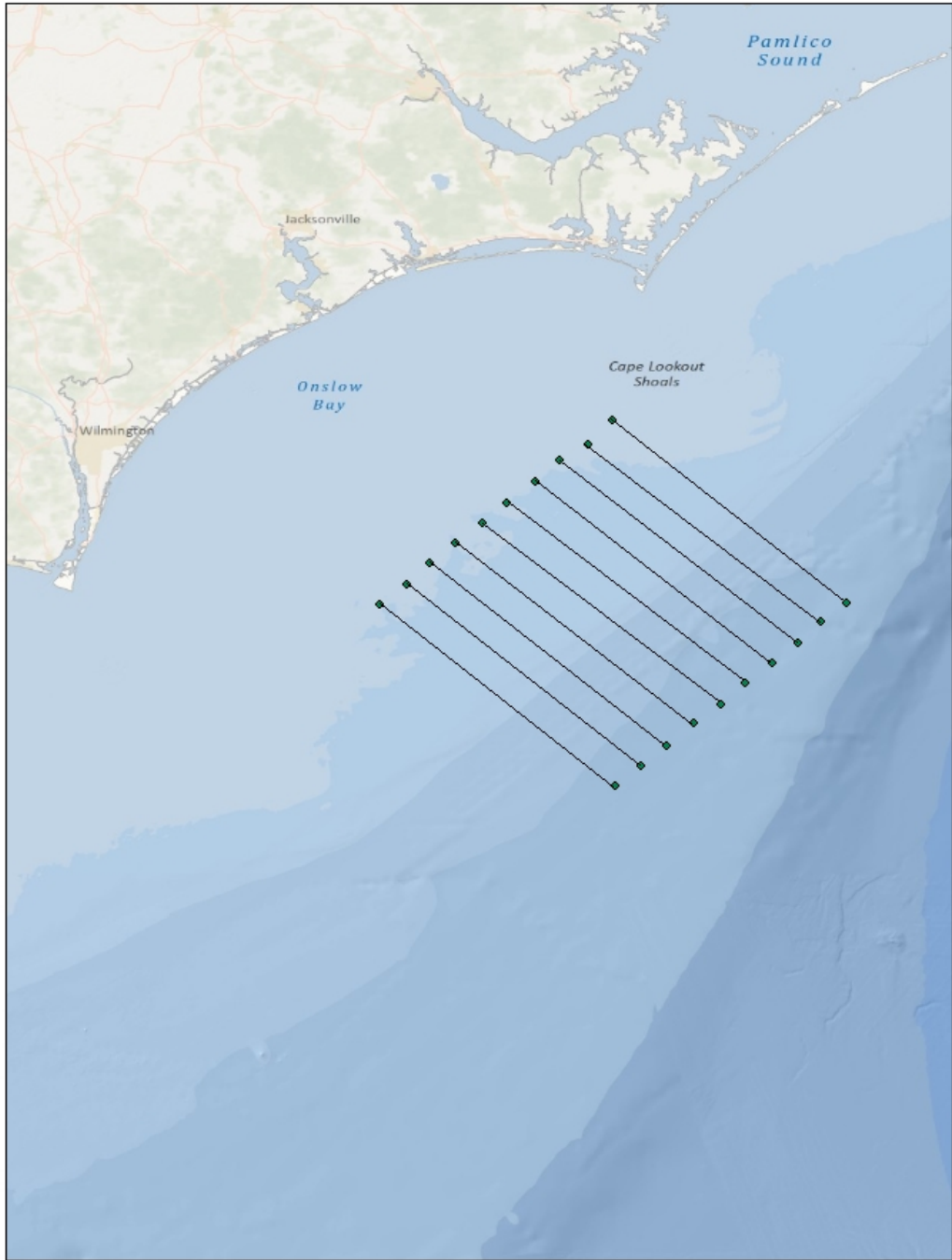

MODELING EFFORTS

AMAPPS

1. Project name:

AMAPPS

2. Directly associated with a survey effort? If so, which one?

The primary data to be modeled are the marine mammal, sea turtle and seabird sightings data collected during the AMAPPS shipboard and aerial surveys (2010 – 2014). The modeling will likely also include sightings data collected during other NMFS aerial and shipboard sighting surveys that were conducted from 1991 to 2009.

3. Objectives:

The objectives of this modeling project are:

1) Develop spatial-temporal fine scale density maps of cetaceans, sea turtles and sea birds within U.S. Atlantic waters that are a function of habitat and detection factors. This ultimately will be available online in a spatial decision support system allowing the user to define the region and species of interest.

2) Improve and/or standardize the abundance estimates to investigate trends, potential climate effects and “hot spots”.

3) Use this framework to investigate trophic ecosystem relationships by incorporating density information from the other species and from other trophic levels (such as plankton) that were collected simultaneously along with the cetacean, sea turtle and sea bird data.

4. Proposed output products:

The primary proposed product is spatial-temporal fine scale density maps of cetaceans, sea turtles, and sea birds that are available online in a spatial decision support system allowing the user to define the region and species of interest.

5. Type of model (brief description of methods/framework including software used):

For as many species (or species groups), we want to produce density maps for seasons (or months) that include the probability of detecting the groups given

appropriate covariates, group size given appropriate covariates, encounter rate given appropriate covariates, $g(0)$ – probability of detecting the group on the track line (to account for perception bias), and average surface and dive times (to account for availability bias).

It is proposed to use a hierarchical modeling framework to estimate density as a function of detection and habitat factors. It is also proposed to investigate model residuals for spatial autocorrelation, and if significant, use spatial eigenvector mapping or similar approaches to remove, or model, the spatial autocorrelation.

Software expected to be used includes DISTANCE (Thomas et al. 2009), the unmarked package (Fiske and Chandler 2011) in program R (R Development Core Team 2011), and the Bayesian MCMC approach in WinBUGS (Spiegelhalter et al. 2007).

6. Species of focus and characteristics of model output (e.g. temporal and spatial resolution, extent):

The extent is the US Atlantic coast out to the US EEZ.

The species that will be focused on are:

- harbor porpoise, white-sided dolphins, pilot whales, common dolphins, bottlenose dolphins, Risso's dolphins, spotted dolphins (Atlantic and pantropical), striped dolphins, sperm whales, Cuvier's beaked whales, other beaked whales, humpback whales, minke whales, fin and sei whales, kogia spp.,
- loggerhead turtles, other sea turtles,
- basking sharks, ocean sunfish,
- Greater shearwaters, Wilson's storm-petrels, Leach's storm-petrels, Cory's shearwater, Leach's storm-petrels, black-capped petrels, sooty shearwaters, Audubon's shearwaters, and other seabirds.

Some of these species will have to be pooled to insure sufficient sample sizes.

Spatial resolution will be 4 km (when possible), if not possible then 10 or 20 km.

Temporal resolution will be at least season (3 months).

7. Species survey data sources (including databases used if applicable), data types used, and data/survey design requirements:

The main survey data sources will be those conducted by the dedicated shipboard and aerial line transect abundance surveys conducted by the NEFSC and SEFSC during 1991 to 2014 (see lists in survey effort description of AMAPPS surveys).

8. Associated predictor and covariate data

- a. **Type**
- b. **Source(s)**
- c. **Spatial and temporal resolution and extent**

Environmental covariates:

Current spatial extent for all of the below is at least the US Atlantic waters from the coast to the EEZ from North Carolina to Maine. Some extents are farther north and south. We will have to expand this extent to cover the entire US Atlantic waters, for those that do not already cover this spatial extent.

Type	Source	Extent / Resolution
Depth	ETOPO5 and coastal relief model	3 arc-minute and 3 arc-second
distance to shore and various depth contours	in-house	variable vector resolution
Sediment type	200m isobath of GEBCO	
sea surface temperature	SST since 1991, available from various sources (MODIS, Pathfinder, GOES) merged, and interpolated by Narragansett lab staff	1991 – 2010; hourly; 1 – 9 km resolution
Chlorophyll	SeaWiFS and MODIS processed by Narragansett lab staff	1997 – 2011; hourly; 1 – 4 km resolution
SST and chlorophyll fronts intensity and distance to	Above processed in-house	1997 – 2010 (or 2011); 5-day averages; 4 km resolution
Mixed layer depth and salinity or density at depth	Ocean Model output	1997 – 2010; daily; 4 – 10 km resolution

Detection covariates:

- Beaufort sea state (estimated to 0.1)
- Glare magnitude (none, slight, moderate, severe)
- Time of day (decimal local time)
- Initial cue (low profile: body and footprint and higher profile: splash and blow)
- Initial behavior (low profile: swimming, feeding, logging and higher profile: porpoising, charging, breaching)
- Percent cloud cover
- Group size

9. Handling of multi-species/community information (will models consider each species independently, jointly model multiple species, or directly model community-level metrics like total abundance and diversity?)

If sample sizes are sufficient, then we will model each species separately. If not sufficient, will pool like species.

10. Do you plan to explicitly identify hot-spots/cold-spots, and if so, how?
a. Single species, multi-species, or both?
b. Abundance, occurrence, species richness, diversity, persistence, other metrics?

No.

11. Contact info, including website if applicable:

Debra Palka, Northeast Fisheries Science Center, 166 Water St., Woods Hole, MA 02543

Lance Garrison, Southeast Fisheries Science Center, 75 Virginia Beach Dr., Miami, FL 33149

12. Bibliographic resources for methodology if appropriate:

Fiske, I. and R. Chandler. 2011. Unmarked: An R package for fitting hierarchical models of wildlife occurrence and abundance. *Journal of Statistical Software* 43(10): 1-23.

Forney, K.A. et al. 2012. Habitat-based spatial models of cetacean density in the eastern Pacific Ocean. *Endang Species Res* 16:113-133.

Goatz, K.T. et al. 2012. Identifying essential summer habitat of the endangered beluga whale *Delphinapterus leucas* in Cook Inlet, Alaska. *Endang Species Res* 16: 135-147.

Moore, J. E., and J. Barlow. 2011. Bayesian state-space models of fin whale abundance trends from a 1991-2008 time series of line-transect surveys in the California Current. *Journal of Applied Ecology* 48: 1195-1205.

Spiegelhalter, D.J., Thomas, A., Best, N. & Lunn, D. (2007) WinBUGS User Manual, Version 1.4.3, 6 August 2007. <http://www.mrc-bsu.cam.ac.uk/bugs>

Thomas L, Laake JL, Rexstad E, Strindberg S, Marques FFC, Buckland ST, Borchers DL, Anderson DR, Burnham KP, Burt ML, Hedley SL, Pollard JH, Bishop JRB, Marques TA. 2009. Distance 6.0. Release 2. [Internet]. University of St. Andrews (UK): Research Unit for Wildlife Population Assessment. Available from: <http://www.ruwpa.st-and.ac.uk/distance/>

13. Papers published based on this work and associated citation information. If possible, please attach the paper with your response.

Hamazaki, T. 2002. Spatiotemporal prediction models of cetacean habitats in the mid-western North Atlantic Ocean (from Cape Hatteras, North Carolina to Nova Scotia). *Marine Mammal Science* 18(4) 920-951.

Best BD, Halpin PN, Read AJ, Fujioka E, Good CP, LaBrecque EA, Schick RS, Roberts JJ, Hazen LJ, Qian SS, Palka DL, Garrison LP, McLellan WA (2012) Online Cetacean Habitat Modeling System for the U.S. East Coast and Gulf of Mexico. *Endangered Species Research*

Atlantic Coast Wintering Sea Duck Survey

1. Project name

Atlantic coast wintering sea duck survey

2. Directly associated with a survey effort? If so, which one?

3. Objectives

Derive accurate coastwide and regional abundance estimates for 5 species of sea ducks; identify regions of high winter densities for improved survey design and coastal habitat management and planning; explore habitat and coastal features affecting sea duck presence and abundance, explain annual variation in distribution.

4. Proposed output products

Abundance models and estimates; boundaries of coastal regions delineating sea duck densities; database of sea duck observations and covariate data; published analyses of habitat associations and interannual variation in distribution.

5. Type of model (brief description of methods/framework including software used)

We are using R and OpenBUGs to develop abundance models. Spatial data manipulation and covariate development using ArcGIS. Most other statistical analyses in R.

6. Species of focus and characteristics of model output (e.g. temporal and spatial resolution, extent)

Primary species of interest are American common eider, long-tailed duck, black, surf, and white-winged scoter. Analyses may also include goldeneye, bufflehead, mergansers, and loons.

7. Species survey data sources (including databases used if applicable), data types used, and data/survey design requirements

USFWS survey data for sea duck data; bathymetry from the National Elevation Dataset; still exploring source for additional covariate information.

8. Associated predictor and covariate data

a. Type

United States Geological Survey digital elevation model (DEM)

U.S. Atlantic coastline Shapefile

b. Source(s)

United States Geological Survey National Elevation Dataset

National Oceanic and Atmospheric Administration's (NOAA) Coastal Geospatial Data Project

c. Spatial and temporal resolution and extent

Spatial extent is the U.S. Atlantic coastline for both datasets. The DEM has a 85 m² cell size and was developed in 2007 and the shapefile of the Atlantic coastline was developed in 2010.

9. Handling of multi-species/community information (will models consider each species independently, jointly model multiple species, or directly model community-level metrics like total abundance and diversity?)

We are mainly focused on species-specific models, but also modeling total sea duck

10. Papers published based on this work and associated citation information. If possible, please attach the paper with your response.

Previous related analysis (Zipkin et al 2010) using more limited survey data is attached.

Duke Cetacean Habitat Models for US Atlantic (SERDP/NASA)

1. Project name:

Duke Cetacean Habitat Models for US Atlantic (SERDP/NASA)

2. Directly associated with a survey effort? If so, which one?

The 2 primary data sources were marine mammal surveys conducted by the Northeast Fisheries Science Center (NEFSC) in Woods Hole, Massachusetts, and the Southeast Fisheries Science Center (SEFSC) in Miami, Florida. The surveys were conducted from 1991 to 2007 and covered the entire Atlantic coast and Gulf of Mexico.

3. Objectives

We developed a comprehensive set of marine mammal habitat models for the US east coast and Gulf of Mexico and their delivery through an online mapping portal.

4. Proposed output products

For each of 16 cetacean species guilds, we predicted the probability of occurrence from static environmental variables (water depth, distance to shore, distance to continental shelf break) and time-varying conditions (monthly sea surface temperature). To generate maps of presence versus absence, receiver operator characteristic (ROC) curves were used to define the optimal threshold that minimizes false positive and false negative error rates. We integrated model outputs, including tables (species in guilds, input surveys) and plots (fit of environmental variables, ROC curve), into an online spatial decision support system (SDSS), allowing for easy navigation of models by taxon, region, season, and data provider. Users can define regions of interest and extract statistical summaries of the model for that region.

5. Type of model (brief description of methods/framework including software used)

We integrated surveys conducted by ship and aircraft, weighting a generalized additive model (GAM) by minutes surveyed within space-time grid cells to harmonize effort between the 2 survey platforms. The Marine Geospatial Ecology Tools (<http://code.env.duke.edu/projects/mget/>) were used for fetching and sampling of environmental data within ArcGIS and generation of GAMs with the R

statistics package mgcv.

6. **Species of focus and characteristics of model output (e.g. temporal and spatial resolution, extent).**

Sample sizes were inadequate to build separate habitat suitability models for each species, so we grouped species at various taxonomic levels to create species 'guilds.' The final cetacean guilds we used in models of habitat suitability include: baleen whale, humpback whale, right whale, beaked whale, sperm whale, *Kogia* spp., killer whale, pilot whale, *Lagenorhynchus* spp., common dolphin, spinner dolphin, striped dolphin, pantropical spotted dolphin, Atlantic spotted dolphin, bottlenose dolphin, and harbor porpoise (see Table 2 in Best et al).

The model covered the US Atlantic coast out to the US EEZ at a seasonal time step. The spatial resolution of the model was 10km.

7. **Species survey data sources (including databases used if applicable), data types used, and data/survey design requirements.**

2 primary data sources were marine mammal surveys conducted by the Northeast Fisheries Science Center (NEFSC) in Woods Hole, Massachusetts, and the Southeast Fisheries Science Center (SEFSC) in Miami, Florida. The surveys were conducted from 1991 to 2007 and covered the entire Atlantic coast and Gulf of Mexico. These are the most extensive marine mammal survey data sets available within the US east coast EEZ. All scientific surveys with standardized effort in the US east coast and Gulf of Mexico were pooled for analysis from OBIS-SEAMAP (<http://seamap.env.duke.edu>) for a total of 11, 006 unique marine mammal sightings between 1991 and 2006 across 52 datasets, of which 36 were by ship and 16 by aircraft (see Table 1 in Best et al).

8. **Associated predictor and covariate data**

Type	Source	Extent / Resolution
depth	General Bathymetric Chart of the Oceans (GEBCO; http://gebco.net)	1 arc minute (now 30 arc sec avail)
distance to shore	Global Self-consistent, Hierarchical, High-resolution Shoreline Database (http://ngdc.noaa.gov/mgg/shorelines/gshhs.html)	variable vector resolution
distance to shelf	200m isobath of GEBCO	
sea surface	SST, available since 1985 with AVHRR Pathfinder	1985 – now,

temperature SST ver. 5 (<http://pathfinder.nodc.noaa.gov>). monthly;
1/23 arc
degree (~
5km at
equator)

9. **Handling of multi-species/community information (will models consider each species independently, jointly model multiple species, or directly model community-level metrics like total abundance and diversity?)**

Sample sizes were inadequate to build separate habitat suitability models for each species, so we grouped species at various taxonomic levels to create species 'guilds.' Each guild was established using information on species distributions, interactions, and other expert knowledge. Each guild was compared to environmental ordination results for validation of its members (see Schick et al. 2011 for full details). The final cetacean guilds we used in models of habitat suitability include: baleen whale, humpback whale, right whale, beaked whale, sperm whale, Kogia spp., killer whale, pilot whale, Lagenorhynchus spp., common dolphin, spinner dolphin, striped dolphin, pantropical spotted dolphin, Atlantic spotted dolphin, bottlenose dolphin, and harbor porpoise (see Table 2 in Best et al).

10. **Do you plan to explicitly identify hotspots/cold-spots, and if so, how?**

No

11. **Contact info, including website if applicable**

Marine Animal Model Mapper
http://seamap.env.duke.edu/serdp/serdp_map.php

12. **Bibliographic resources for methodology if appropriate**

Best BD, Halpin PN, Fujioka E, Read AJ, Qian SS, Hazen LJ, Schick RS (2007) Geospatial web services within a scientific workflow: Predicting marine mammal habitats in a dynamic environment. *Ecological Informatics* 2:210–223

Pittman SJ, Costa B (2010) Linking Cetaceans to Their Environment: Spatial Data Acquisition, Digital Processing and Predictive Modeling for Marine Spatial Planning in the Northwest Atlantic. *Spatial Complexity, Informatics, and Wildlife Conservation*:387–408

Redfern JV, Ferguson MC, Becker EA, Hyrenbach KD, Good C, Barlow J, Kaschner K, Baumgartner MF, Forney KA, Ballance LT, others (2006) Techniques for cetacean-habitat modeling. *Marine Ecology Progress Series* 310:271–295

Roberts JJ, Best BD, Dunn DC, Trembl EA, Halpin PN (2010) *Marine Geospatial Ecology Tools: An integrated framework for ecological geoprocessing with ArcGIS, Python, R, MATLAB, and C++*. Environmental Modelling & Software In Press, Corrected Proof

Schick RS, Halpin PN, Read AJ, Urban DL, Best BD, Good CP, Roberts JJ, LaBrecque EA, Dunn C, Garrison LP, Hyrenbach KD, McLellan WA, Pabst DA, Palka DL, Stevick P (2011) Community structure in pelagic marine mammals at large spatial scales. *Mar Ecol Prog Ser* 434:165–181

Wood SN (2006) *Generalized additive models: an introduction with R*. CRC Press

13. Papers published based on this work and associated citation information. If possible, please attach the paper with your response.

Best BD, Halpin PN, Read AJ, Fujioka E, Good CP, LaBrecque EA, Schick RS, Roberts JJ, Hazen LJ, Qian SS, Palka DL, Garrison LP, McLellan WA (2012) Online Cetacean Habitat Modeling System for the U.S. East Coast and Gulf of Mexico. *Endangered Species Research*

New Jersey Ocean/Wind Power Ecological Baseline Studies (OWPEBS)

1. Project name:

New Jersey Ocean/Wind Power Ecological Baseline Studies (OWPEBS)

2. Directly associated with a survey effort? If so, which one?

Yes, the OWPEBS project contains predictive and distribution modeling based on survey efforts for avian, marine mammal, and sea turtle species.

3. Objectives:

The objective of this study was to conduct baseline studies in waters off New Jersey's coast to determine the current distribution and usage of this area by ecological resources. The goal was to provide GIS and digital spatial and temporal data on various species utilizing these offshore waters to assist in determining potential areas for offshore wind power development. The scope of work includes the collection of data on the distribution, abundance and migratory patterns of avian, marine mammal, sea turtle and other species in the study area over a 24-month period. These data, as well as existing (historical) data, were compiled and entered into digital format and geographic information system (GIS)-compatible electronic files. Those portions of the study area that are more or less suitable for wind/alternative energy power facilities were determined based on potential ecological impact using predictive modeling, mapping, and environmental assessment methodologies.

4. Proposed output products:

The OWPEBS was designed to assess the natural and biotic resources present in New Jersey coastal waters. By design, the study's major objective was to fill data gaps existing for a wide range of parameters, including biotic resources (e.g. avian, marine mammal, and sea turtle distributions, fisheries database information, etc.) and abiotic resources (e.g. oceanographic information, wind resources, physiochemical data, etc.). Major products include individual counts and distribution of avian, marine mammal, and sea turtle species utilizing the offshore study area. From these data, avian predictive model and kernel density models were generated to predict habitat usage and densities for numerous species. In addition, the above was also used to generate an

Environmental Sensitivity Index maps and an analysis of impacts (Impacts Analysis flow charts and tables).

5. Type of model (brief description of methods/framework including software used):

One of the primary project goals of the study is to incorporate the avian, marine mammal, and sea turtle data into interactive models to identify densities, distributions, and potential occurrences of these animals within the study area. The models will allow ID of areas with the highest and lowest avian densities of target species and will allow selection of areas that will potentially have the least impact on avian, marine mammal, or sea turtle species from wind farm development. Avian data was modeled separately from marine mammal and sea turtle data.

Avian: Two different spatial modeling techniques, distance modeling and kriging (i.e. geostatistical/kernel density interpolation), were used to generate a similar product: a spatially continuous density map of a given attribute and an analogous spatial map of standard error (or variance). The distance modeling was applied to ship/aerial line-transect datasets; kriging was applied to the avian radar data (Range-bias-correction was applied to radar data before modeling). Basic input data to the model include bird counts (abundance), flight altitude and direction, heading (angle from observer), range (distance from observer), bird/flock size, and species ID, as well as longitude-latitude location of the sighting. A range bias correction is first applied to the data to account for the general decrease in radar sensitivity or observer detection accuracy with increasing distance. A detection function is formulated by fitting numerous available GAMs (e.g., hazard-rate or half-normal key functions with or without simple polynomial, Hermite polynomial, or cosine series expansion terms) to the detection data via nonlinear regression and identifying the model of best fit. The range-bias-corrected abundance data is then subjected to kriging spatial interpolation (using ArcGIS, ArcMap v. 9.0), whose methodology includes initial tests for spatial autocorrelation/autocovariance, detrending, semivariogram modeling, neighborhood search, and cross-validation. The cross-validation procedure is conducted to assess the ability of kriging to accurately predict avian abundance at each sampled point location. By repeating the kriging interpolation process while removing one sampled data point at a time (such that the total number of runs is equal to the number of sampled data points), the accuracy of the kriging model is assessed at each omitted data point by comparing the model-predicted attribute value with the measured (sampled) attribute value. Data from other sources (e.g. NEXRAD) was also included in the model.

Marine mammals and sea turtles: Density estimates for all species were developed through the use of spatial modeling in the program DISTANCE. All surveys from all platforms were combined (shipboard and aerial) to increase the number of sightings for all species. Density surface models (DSM) for each species sighted were generated using Generalized Additive Modeling (GAM) with covariates. These covariates include dynamic (SST, salinity and chlorophyll a), as well as static (bottom depth, bottom slope, distance of the sighting from the shore, latitude, and longitude) variables.

6. Species of focus and characteristics of model output (e.g. temporal and spatial resolution, extent):

All avian, marine mammal and sea turtle species within the study area observed were recorded. A total of 153 bird species, seven cetacean species, one seal species, and two sea turtle species were observed in the offshore study area during the 24-month study period. For birds, species of greater focus due to their frequency of being found at potential rotor-swept zone height during most seasons include: Northern gannet (*Morus bassanus*), Black scoter (*Melanitta nigra*), Herring gull (*Larus argentatus*), Great black-backed gull (*L. marinus*), Red-throated loon (*Gavia stellata*), Common loon (*G. immer*), and Laughing gull (*Leucophaeus atricillus*). Mammalian modeling focused primarily on the following species: North Atlantic right whale (*Eubalaena glacialis*), Fin whale (*Balaenoptera physalus*), Humpback whale (*Megaptera novaeangliae*), Bottlenose dolphin (*Tursiops truncatus*), Short-beaked common dolphin (*Delphinus delphis*), and Harbor porpoise (*Phocoena phocoena*). Leatherback sea turtle (*Dermochelys coriacea*) and Loggerhead sea turtle (*Caretta caretta*) comprised the sea turtle species.

Predictive modeling was used to determine species density both temporally and spatially, specifically to ascertain differences in seasonal movement and congregation. This was accomplished through the development of an avian predictive model and kernel density interpolation (please see Volumes II and III of the OWPEBS Final Report: <http://www.nj.gov/dep/dsr/ocean-wind/report.htm>). An Environmental Sensitivity Index (i.e. mapping) was developed by overlaying species densities over unique ocean bottom features (e.g. artificial reefs, ridges, holes, shoals, wrecks, utility cables, etc.) to determine where wind farms may be most suitable for siting and avoid adverse impacts to natural resources and wildlife.

7. Species survey data sources (including databases used if applicable), data types used, and data/survey design requirement

Numerous methods and equipment were used to detect avian and marine mammal species. Briefly, these include shipboard (large and small vessel) surveys, passive acoustic monitoring, aerial surveys, VerCat/TracScan radar (birds), TI-VPR (birds and bats), and NEXRAD radar. Fish and fisheries information was compiled from various databases maintained by state and federal agencies. Given the extent of information, please refer to the NJ OWPEBS Final Report: <http://www.nj.gov/dep/dsr/ocean-wind/report.htm>. GIS data and mapping can be found at: <http://www.nj.gov/dep/gis/windpower.html>.

8. Associated predictor and covariate data

Covariates included dynamic (SST, salinity and chlorophyll a), as well as static (bottom depth, bottom slope, distance of the sighting from the shore, latitude, and longitude) variables. The following conclusions were drawn and used for predictor data for bird distribution:

- Nearshore densities are higher than offshore densities, supporting an offshore gradient of decreasing densities with increasing offshore distance.
- Densities of birds were higher in shoal areas.
- All-behavior densities were higher than sitting densities.

Please see the NJ OWPEBS Final Report and appendices: <http://www.nj.gov/dep/dsr/ocean-wind/report.htm>.

9. Handling of multi-species/community information (will models consider each species independently, jointly model multiple species, or directly model community-level metrics like total abundance and diversity?)

With the exception of diversity, all of the above were considered and modeled.

10. Do you plan to explicitly identify hot-spots/cold-spots, and if so, how?

Yes, hot-spots and under-utilized areas were identified and mapped (abundance, occurrence, species richness, diversity, persistence, other metrics included). These are explicitly identified for all species and guilds in the appropriate appendices of the OWPEBS Final report and GIS data set: <http://www.nj.gov/dep/dsr/ocean-wind/report.htm> and <http://www.nj.gov/dep/gis/windpower.html>, respectively.

11. Contact info, including website if applicable

Dr. Gary A. Buchanan, Manager
New Jersey Department of Environmental Protection
Office of Science
428 E. State St., 1st Fl., Mail Code: 428-01
Ph: (609) 633-8457
Fax: (609) 777-2852

12. Bibliographic resources for methodology if appropriate

Please see the OWPEBS Final Report, Volumes I – IV:
<http://www.nj.gov/dep/dsr/ocean-wind/report.htm>.

13. Papers published based on this work and associated citation information. If possible, please attach the paper with your response.

NOAA/NOS/NCCOS Biogeography Branch Mid-Atlantic Seabird Predictive Modeling (BOEM/USGS)

1. Project name: NOAA/NOS/NCCOS Biogeography Branch Mid-Atlantic Seabird Predictive Modeling (BOEM/USGS)

2. Directly associated with a survey effort? If so, which one?

No, but associated with the USGS Atlantic Seabird Survey Compendium project, which incorporates many seabird surveys conducted along the Atlantic coast from the 1970's through the present.

3. Objectives

To produce high-resolution (~1-5km) predictions of the long-term average spatial distribution of important seabird species and species groups for the Mid-Atlantic region, with associated measures of uncertainty, to provide information for regional marine spatial planning efforts with a focus on siting and environmental assessment of offshore wind facilities.

4. Proposed output products

For each seabird species or species group for which sufficient data exist, we will produce maps of predicted seasonal and annual climatological (long-term average) probability of occurrence and relative abundance (sightings per unit effort, SPUE). We will also produce maps of the uncertainty associated with model predictions. Maps will be produced at a high spatial resolution (~1-5km horizontal grid).

Maps will be accompanied by descriptions of the associated models and diagnostic statistics and plots for accuracy assessment.

Maps will be produced and distributed in both digital (ArcGIS and other raster formats) and report form. Digital data will be provided to the Multipurpose Marine Cadastre, MARCO Data Portal, and other relevant portals for wide distribution.

5. Type of model (brief description of methods/framework including software used)

We plan to use a two-stage or hurdle model, in which the probability of presence is modeled in one stage of the model, and the abundance when the species is present is modeled in the second stage. Each stage of the model uses a

'regression-kriging' approach in which generalized linear modeling (GLM) is used to model trends as a function of environmental covariates, and geostatistical modeling (ordinary and indicator kriging) is used to model spatial autocorrelation in GLM residuals. Models are being implemented with custom code written in Matlab and R, and use several toolboxes available for those computing environments (primarily Gstat, mGstat, the Matlab Statistics Toolbox, and glmmulti). The methods and software used are described in detail in Appendix A of Kinlan et al. (2012) [see section 13 below for full reference]. Figure 1 shows a schematic of the modeling process (reprinted from Kinlan et al. 2012).

6. Species of focus and characteristics of model output (e.g. temporal and spatial resolution, extent)

Species of focus include all birds observed over ocean waters with sufficient frequency to support modeling (at least 40 occurrences in at least one season). Where possible, bird species without sufficient data to be modeled individually will be included in 'guilds' based on shared life history, ecological, and taxonomic traits and similar patterns of spatial distribution.

The model will cover the US Mid-Atlantic from the shore to the EEZ, although predictions will only be produced where sufficient nearby data exist. Figure 2 shows a polygon depicting the study area and a bounding box in which environmental covariate data will be acquired.

The temporal resolution of the model will be long-term seasonal averages (seasonal climatologies). The spatial resolution will be ~1-5km, with the final decision on resolution depending on spatial accuracy assessments.

7. Species survey data sources (including databases used if applicable), data types used, and data/survey design requirements.

This project will use all available science-quality at-sea survey data in the USGS Atlantic Seabird Survey Compendium database (O'Connell et al. 2009, Spiegel and Johnston 2011). This database compiles all major at-sea marine bird survey datasets for the Atlantic from 1978-2010, and is continuously being updated to include more recent data. Both ship-based and aerial transect datasets will be used. Data consist of presence/absence and counts of all birds detected on discrete-time and continuous-time transects. Only the subset of data from the Mid-Atlantic study area (Figure 2) will be used. Effort will be standardized by re-segmenting of transects into lengths equivalent to a ship traveling a 10 knots for 15 minutes.

8. Associated predictor and covariate data

The following table lists the environmental covariates to be used in this study. Additional covariates, such as information on surface currents, eddies, upwelling, and front probabilities, may also be incorporated. All datasets were processed to a common spatial resolution of ~1km and a seasonal climatological temporal resolution. Details of the sources and processing of each of these datasets are given in Kinlan et al. (2012) Appendix B.

Type	Source	Original spatial resolution	Time span
Depth	NOAA Coastal Relief Model (CRM) (NGDC 2010) and ETOPO1 (Amante and Eakins 2009)	CRM: 3 arc-second (~93m); ETOPO1: 1 arc-minute	n/a
Slope	Derived from Depth	3 arc-second (~93m)	n/a
Slope-of-slope	Derived from Depth	3 arc-second (~93m)	n/a
Distance to shore	Distance from 1:250,000 World Vector Shoreline (Soluri and Woodson 1990)	n/a (distance from vector)	n/a
Distance from shelf break	Derived from Depth (distance from 200m contour)	n/a (distance from vector)	n/a
Mean surficial sediment grain size	USGS usSEABED bottom sample database for the Atlantic coast of the US (Reid et al. 2005); interpolated with geostatistical model (Kinlan et al. 2012)	Points	n/a
Water-column stratification	Law (2011) and The Nature Conservancy (TNC) Northwest Atlantic Marine Ecoregional Assessment (NAMERA) Phase I Report (Greene et al. 2010; Shumway et al. 2010)	5 arc-minute	1980-2007
Sea surface temperature	NASA Pathfinder AVHRR High-Resolution SST Archive for Northwest Atlantic at University of Rhode Island (Wolfeich, 2011). Available at: http://satdat1.gso.uri.edu/opensap/Pathfinder/Northwest Atlantic/1km/decoupled/contents.html	~1.1km	1985-2001

Sea surface turbidity proxy	SeaWiFS Normalized Rrs-670nm (Level 2 data from http://oceancolor.gsfc.nasa.gov processed by NOAA/NOS/NCCOS COAST Branch)	~1.1km	1998-2006
Sea surface chlorophyll-a	SeaWiFS Chlorophyll-a (Level 2 data from http://oceancolor.gsfc.nasa.gov processed by NOAA/NOS/NCCOS COAST Branch)	~1.1km	1998-2006
Near- surface zooplankton biomass (mean displacement volume)	NOAA NMFS Copepod database (http://www.st.nmfs.noaa.gov/plankton/atlas/data_src/copepod-010__4000000-compilation.txt); interpolated with geostatistical model (Kinlan et al. 2012)	Points	1966-2001

9. Handling of multi-species/community information (will models consider each species independently, jointly model multiple species, or directly model community-level metrics like total abundance and diversity?)

We will consider each species independently where sufficient data are available. When data are insufficient to model species individually, we anticipate grouping species into guilds based on shared taxonomy, ecological traits, and spatial patterns.

Each species or guild will be modeled individually. Cross-correlations among species/guilds will not be considered. Community-level metrics like total abundance and diversity will not be modeled directly, although individual species model results may be combined to estimate patterns of total abundance, species richness, and diversity.

10. Do you plan to explicitly identify hotspots/cold-spots, and if so, how?

Not as part of this modeling effort. We have done this in past work (see Kinlan et al. 2012 [citation below] for example in NY Bight) and are actively developing methods for hotspot/coldspot characterization, detection, and significance testing through other projects.

11. Contact info, including website if applicable

Dr. Brian Kinlan
Biogeography Branch
National Centers for Coastal Ocean Science (NCCOS)
NOAA National Ocean Service
1305 East-West Hwy, SSMC-4, N/SCI-1
Silver Spring, MD 20910-3281
Tel: 301.713.3028 x157
Brian.Kinlan@NOAA.gov

NOAA/NOS/NCCOS Biogeography Branch website:

<http://ccma.nos.noaa.gov/about/biogeography/>

12. Bibliographic resources for methodology if appropriate

Two-stage, Hurdle, or Delta modeling approach:

Stefánsson, G. 1996. Analysis of groundfish survey abundance data: combining the GLM and delta approaches. *ICES Journal of Marine Science*, 53:577–588.

Ver Hoef, J.M. and J.K. Jansen. 2007. Space-time zero-inflated count models of Harbor seals. *Environmetrics* 18:697–712.

Winter, A., Y. Jiao and J.A. Browder. 2011. Modeling Low Rates of Seabird Bycatch in the U.S. Atlantic Longline Fishery. *Waterbirds*, 34(3):289-303. DOI: 10.1675/063.034.0304

Spatial climatological approach:

Santora, J.A. and C.S. Reiss. 2011. Geospatial variability of krill and top predators within an Antarctic submarine canyon system. *Marine Biology* 158:2527–2540. DOI 10.1007/s00227-011-1753-0

Geostatistical modeling:

Hengl, T., G.M.B. Heuvelink, and D.G. Rossiter. 2007. About regression-kriging: from equations to case studies. *Computers and Geosciences*, 33(10):1301-1315.

Pebesma, E.J. and C.G. Wesseling. 1998. Gstat, a program for geostatistical modelling, prediction and simulation. *Computers and Geosciences*, 24(1):17-31.

Chiles, J.P. and P. Delfiner. 1999. *Geostatistics, Modelling Spatial Uncertainty*, Wiley Interscience.

Generalized Linear Models:

Fox, J. 2008. Applied Regression Analysis, Linear Models, and Related Methods. Sage Publishing. 2nd edition. Chapter 15.

Atlantic Seabird Survey Compendium database references

O'Connell, Jr., A.F., B. Gardner, A.T. Gilbert, and K. Laurent. 2009. Compendium of Avian Occurrence Information for the Continental Shelf Waters along the Atlantic Coast of the United States (Database Section: Seabirds). A final report for the U.S. Department of the Interior, Minerals Management Service, Atlantic OCS Region, Herndon, VA. 50 pp. Contract No. M08PG20033.

Spiegel, C. and S. Johnston. 2011. Compendium of Avian Occurrence Information for the Continental Shelf Waters along the Atlantic Coast of the United States (Database Section: Shorebirds). A final report for the U.S. Department of the Interior, Bureau of Energy

Management, Regulation, and Enforcement, Atlantic OCS Region, Herndon, VA. 27 pp. Contract No. M08PG20033//Interagency Agreement between USGS and USFWS, Region 5, Division of Migratory Birds, Hadley, MA.

Environmental covariate references:

Amante, C. and B.W. Eakins. 2009. ETOPO1 1 Arc-Minute Global Relief Model: Procedures, Data Sources and Analysis. NOAA Technical Memorandum NESDIS NGDC-24, 19 pp, March 2009. URL: <http://www.ngdc.noaa.gov/mgg/global/global.html>

Greene, J.K., M.G. Anderson, J. Odell, and N. Steinberg, (eds). 2010. The Northwest Atlantic Marine Ecoregional Assessment: Species, Habitats and Ecosystems. Phase One. The Nature Conservancy, Eastern U.S. Division, Boston, MA. URL: <http://www.nature.org/ourinitiatives/regions/northamerica/areas/easternmarine/explore/index.htm>.

Law, G. 2011. Center for Coastal Margin Observation and Prediction, Oregon Health and Science University. Pers. comm., emails with B. Kinlan, C. Menza, and M. Poti, March 2011 – August 2011.

NOAA National Geophysical Data Center (NGDC). 2010. U.S. Coastal Relief Model. Retrieved 23 June 2010 from URL: <http://www.ngdc.noaa.gov/mgg/coastal/crm.html>

Reid, J.M., J.A. Reid, C.J. Jenkins, M.E. Hastings, S.J. Williams and L.J. Poppe. 2005. usSEABED: Atlantic coast offshore surficial sediment data release: U.S.

Geological Survey Data Series 118, version 1.0. URL:
<http://pubs.usgs.gov/ds/2005/118/>

Shumway, C., K. Ruddock, and M. Clark. 2010. Physical Oceanography. Chapter 4
In: Greene, J.K., M.G. Anderson, J. Odell, and N. Steinberg (eds.). The Northwest
Atlantic Marine Ecoregional Assessment: Species, Habitats and Ecosystems.
Phase One. The Nature Conservancy, Eastern U.S. Division, Boston, MA.

Soluri, E.A. and V.A. Woodson. 1990. World Vector Shoreline. International
Hydrographic Review, LXVII(1).

Wolfteich, C. Web document: URI/NASA AVHRR Pathfinder 1km SST Archive.
Retrieved April 2011 from http://satdat1.gso.uri.edu/opendap/Pathfinder/Pathfinder1km/pathfinder_1km.html

13. Papers published based on this work and associated citation information. If possible, please attach the paper with your response.

Kinlan, B.P., C. Menza, and F. Huettmann. 2012. Predictive Modeling of Seabird
Distribution Patterns in the New York Bight. Chapter 6 in C. Menza, B.P. Kinlan,
D.S. Dorfman, M. Poti and C. Caldwell (eds.). A Biogeographic Assessment of
Seabirds, Deep Sea Corals and Ocean Habitats of the New York Bight: Science to
Support Offshore Spatial Planning. NOAA Technical Memorandum NOS NCCOS
141. Silver Spring, MD. 224 pp.

Available at:

http://ccma.nos.noaa.gov/ecosystems/coastalocean/ny_spatialplanning.aspx#products

North Carolina State University Collaborative Projects

1. Project name

North Carolina State University Collaborative Projects. This is a combination of projects and work with USGS, BRI, URI, WMI/FWS, Tufts. I apologize upfront that my answers are basically non-specific, but there were just too many different projects to answer any question with much specificity and clarity. I'm happy to answer questions that folks may have based on this questionnaire.

2. Specific project titles and thus associated efforts:

USGS - Atlantic Sea Bird Survey Compendium

BRI - Mid-Atlantic Baseline Studies Project (see specific questionnaire for more details)

URI – Rhode Island Ocean Special Area Management Plan (OSAMP)-Avian Surveys (see specific questionnaire for more details)

WMI/FWS – Mapping sea bird distributions in the NW Atlantic

Tufts - Seabird Ecological Assessment Network -- Modeling deposition rates of beach birds

3. Project Background and Objectives

Many studies aim to collect baseline data across some portion of the east coast of the U.S. However, data are often collected through various methods, in spatially reduced areas, and over varying time frames. The overarching objective of our work has been to examine data sets to estimate abundance or species distributions and when possible, trying to estimate detection and combining datasets to improve precision. The examination of covariates as well as determining seasonal patterns is commonly included in the objectives.

4. Proposed output products

Models that describe patterns of sea bird abundance or distribution or predictive models based on dynamic covariates.

5. Type of model

Almost all of the modeling we have carried out thus far is hierarchical in nature and analyzed using a Bayesian mode of inference. The work is done either entirely in R or using a Gibbs sampling software program such as BUGS or JAGS. Generically classifying the models

USGS – spatial Poisson regression
BRI – to be determined, distance sampling methods
URI – community dynamic occupancy models
WMI/FWS – to be determined, combining with risk assessment
Tufts – zero-inflated Poisson regression

6. Species of focus and characteristics of model output (e.g. temporal and spatial resolution, extent)

The spatial resolution varies from a specific study area like in the OSAMP surveys to a large area off the whole Eastern coast such as in the USGS and BRI projects. The temporal resolution is also highly variable ranging from short time periods of just a single season to many years.

7. Species survey data sources (including databases used if applicable), data types used, and data/survey design requirements

8. Associated predictor and covariate data

Covariates vary for the different projects, but generally included SST, chlorophyll a, NAO, bathymetry, spatial location, wind vectors, observer (not for prediction), time of year, time of day, etc.. The spatial and temporal resolutions are relative to the particular study.

9. Handling of multi-species/community information (will models consider each species independently, jointly model multiple species, or directly model community-level metrics like total abundance and diversity?)

It is not always easy to jointly model multiple species, but when possible, we are trying to build community models that link species through a hierarchical process. This can improve estimates for species with fewer observations and provides a model based framework for estimating species richness. Currently, a number of our models are single species or guild based models.

10. Do you plan to explicitly identify hot-spots/cold-spots, and if so, how?

This is a good question. Yes, for particular projects such as the WMI/FWS project, we are really thinking hard about how to do this. At this point, we don't have a good answer – defining what is a "hot spot" is not entirely clear, let alone what spatial and temporal resolution makes the most sense for our question.

11. Contact info, including website if applicable

Beth Gardner, NCSU, beth_gardner@ncsu.edu

12. Bibliographic resources for methodology if appropriate

- Besag, J., J. York, and A. Mollie. 1991. Bayesian image restoration, with two applications in spatial statistics. *Annals of the Institute of Statistical Mathematics*, 43:1-49.
- Borchers, D. L., and M. G. Efford. 2008. Spatially explicit maximum likelihood methods for capture–recapture studies. *Biometrics* 64:377–385.
- Byrd, G. V., J. H. Reynolds and P. L. Flint. 2009. Persistence rates and detection probabilities of bird carcasses on beaches of Unalaska Island, Alaska following the wreck of the M/V Selendang Ayu. *Marine Ornithology* 37:197-204.
- Carlin, B. P., and T. A. Louis. 2000. Bayes and empirical bayes methods for data analysis. Second edition. Chapman and Hall, New York, New York, USA.
- Clarke, ED, Spear, LB, Mccracken, ML, Marques, FFC, Borchers, DL, Buckland, ST, and Ainley, DG. 2003. Validating the use of generalized additive models and at-sea surveys to estimate size and temporal trends of seabird populations. *Journal of Applied Ecology* 40:278-292.
- Cressie, N. A. C. *Statistics for Spatial Data*, Wiley, New York, 1991 (900 pp.).
- Dorazio, R.M., Royle, J.A., Söderström, B., Glimskär, A., 2006. Estimating species richness and accumulation by modeling species occurrence and detectability. *Ecology* 87, 842–854.
- Hall, D. 2000. Zero-Inflated Poisson and Binomial Regression with Random Effects: A Case Study. *Biometrics*, 56(4): 1030-1039.
- Link, W.A. and Sauer, J.R. 2007. A hierarchical analysis of population change with application to cerulean warblers. *Ecology* 83:2832-2840.
- Lunn, D.J., Thomas, A., Best, N., and Spiegelhalter, D. 2000. WinBUGS -- a Bayesian modelling framework: concepts, structure, and extensibility. *Statistics and Computing* 10:325--337.
- MacKenzie, D.I., J.D. Nichols, J.A. Royle, K.H. Pollock, J.E. Hines and L.L. Bailey. 2006. *Occupancy estimation and modeling: inferring patterns and dynamics of species occurrence*. Elsevier, San Diego, USA
- Martin, T. G. Wintle, B. A. Rhodes, J. R. Kuhnert, P. M. Field, S. A. Low-Choy, S. J. Tyre, A. J. Possingham, H. P. 2005. Zero tolerance ecology: improving ecological inference by modelling the source of zero observations, *Ecology Letters*, 8, 1235-1246.
- Royle, J. A., R. M., Dorazio, and W. A. Link. 2007. Analysis of multinomial models with unknown index using data augmentation. *Journal of Computational and Graphical Statistics* 16:67–85.
- Thogmartin, W. E., J. R. Sauer, and M. G. Knutson. 2004. A hierarchical spatial model of avian abundance with application to Cerulean Warblers. *Ecological Applications* 14:1766–1779

13. Papers published based on this work and associated citation information. If possible, please attach the paper with your response.

- O'Connell, Jr., A. F., B. Gardner, A. T. Gilbert, and J. Ellis. 2012. Compendium of Avian Occurrence Information for the Continental Shelf Waters along the Atlantic Coast of the United States (Modeling Section – Seabirds). A final report for the U.S. Department of the Interior, Bureau of Ocean Energy Management (in review).
- O'Connell, Jr., A. F., B. Gardner, A. T. Gilbert, and K. Laurent. 2009. Compendium of Avian Occurrence Information for the Continental Shelf Waters along the Atlantic Coast of the United States (Database Section – Seabirds). A final report for the U.S. Department of the Interior, Minerals Management Service, Atlantic OCS Region, Herndon, VA. 50pp. Contract No. M08PG20033.
- Oppel, S., A. Meirinho, I. Ramírez, B. Gardner, A. F. O'Connell, and M. Louzao. Comparison of five modelling techniques to predict the spatial distribution and abundance of seabirds. *Biological Conservation*.
<http://dx.doi.org/10.1016/j.biocon.2011.11.013>
- Spiegel, C. and S. Johnston. 2011. Compendium of Avian Occurrence Information for the Continental Shelf Waters along the Atlantic Coast of the United States (Database Section – Shorebirds). A final report for the U.S. Department of the Interior, Bureau of Energy Management, Regulation, and Enforcement, Atlantic OCS Region, Herndon, VA. 27pp. Contract No. M08PG20033//Interagency Agreement between USGS and USFWS, Region 5, Division of Migratory Birds, Hadley, MA.
- Zipkin, E.F., Gardner, B., Gilbert, A.T., O'Connell, A.F., Royle, J.A., and Silverman, E.D. 2010. Distribution patterns of wintering sea ducks in relation to the North Atlantic Oscillation and local environmental characteristics. *Oecologia*, 163(4): 893-902.

Rhode Island Ocean Special Area Management Plan (OSAMP)- Avian Surveys

1. Project name

Rhode Island Ocean Special Area Management Plan (OSAMP)-Avian Surveys.
Our avian surveys were one component of a large marine spatial planning exercise of Block Island and Rhode Island Sound for proposed offshore wind development.

2. Directly associated with a survey effort? If so, which one?

Yes, Rhode Island Ocean Special Area Management Plan (OSAMP).

3. Objectives

Assess temporal variation (seasonal and annual) in avian spatial distribution and abundance in the OSAMP study area.

4. Proposed output products.

Density surface models (DSMs) of common species in our study area by season.

5. Type of model (brief description of methods/framework including software used).

We utilized the 'count method' of Hedley and Buckland (2004) and used sighting data collected to model the surface density and to visually depict the foraging area of those marine bird species common to the OSAMP study area. Species were modeled by season: Summer (surveys conducted from June through August), Fall (surveys conducted from September through November) and Winter (surveys conducted from December through February). Creating a surface density model is a multiple step process that first includes modeling a detection function based on the observed distance data collected from line-transect sampling (no detection function modeling with strip transect data). These detection functions are then included in the creation of models that relate observation data with spatial covariates to predict densities across both areas sampled and those not sampled (Herr et al. 2009; Katsanevakis 2007). The detection function, $g(y)$, was estimated using Distance 6.0 software (Thomas et al. 2011) following the method outlined by Buckland et al. (2001). A single parameter half-normal function or a two parameter hazard rate formula were considered as possible detection functions. Akaike Information Criteria was used to select the "best" model and Q-Q plots were used to assess model fit. The highest ranking detection functions were chosen for each avian species and each season that was modeled. We used two physical spatial covariates, depth and distance to land, to model the foraging distribution of species common to the OSAMP study area. Each transect was divided into segments (830 meters ship

surveys, 2,270m aerial surveys) long using ArcMap 9.3 (for a total of 465 segments in eight grids; 453 segments 24 aerial transects). Depth was measured at the midpoint of each segment from the NOAA Coastal Relief Model data set (NOAA 2004). Distance to land was also calculated from the midpoint of the segment, and measured to the nearest point of land using ArcMap 9.3. The total number of birds within each segment, independent of spatial covariates, was calculated using the Horvitz-Thompson-like estimator (Hedley and Buckland 2004). Expected values of abundance in each segment were calculated using Generalized Additive Models (GAMs; Hastie and Tibshirani 1990). Four different GAMs were fitted for each density surface model: two univariate models for depth and distance to land, a model including both depth and distance to land, and a model with a depth and distance to land interaction. Model selection was based on the lowest Generalized Cross Validation score (GCV; Wood 2006). For this analysis we used the *mgcv* package (Wood 2000, 2006) written in R v.2.9.1 (R Development Core Team 2009) within Distance 6.0 (Thomas et al. 2006).

Using ArcMap 9.3 software (ESRI), a prediction grid was created overlaying the map of the study area with 920 square cells, each 4 km² in area. Abundance in the study area for each species and season was estimated as the sum of prediction cells, where abundance predictions for each cell were calculated with the selected GAM model. The abundance estimation was conducted using the DSM analysis engine of the Distance 6.0 software (Thomas et al. 2006). Based on the predictions for each of the 920 grid cells, we produced a distribution map of individual species for the entire Ocean SAMP study area using ArcMap 9.3. A variance component was calculated for each model following Seber (1982) that included both the variance associated with fitting the detection function (line transects only) and that associated with the density surface model (e.g. the two steps in creating a density surface model). To calculate the variability associated with the density surface model estimates, we ran a parameteric bootstrap with 499 reiterations for each model (Efron and Tibshirani 1993). The bootstrap used a moving block of three segments to reduce the effects of spatial autocorrelation.

6. Species of focus and characteristics of model output (e.g. temporal and spatial resolution, extent).

Density Surface Models (number of individuals/km²)

Resolution: 2km²

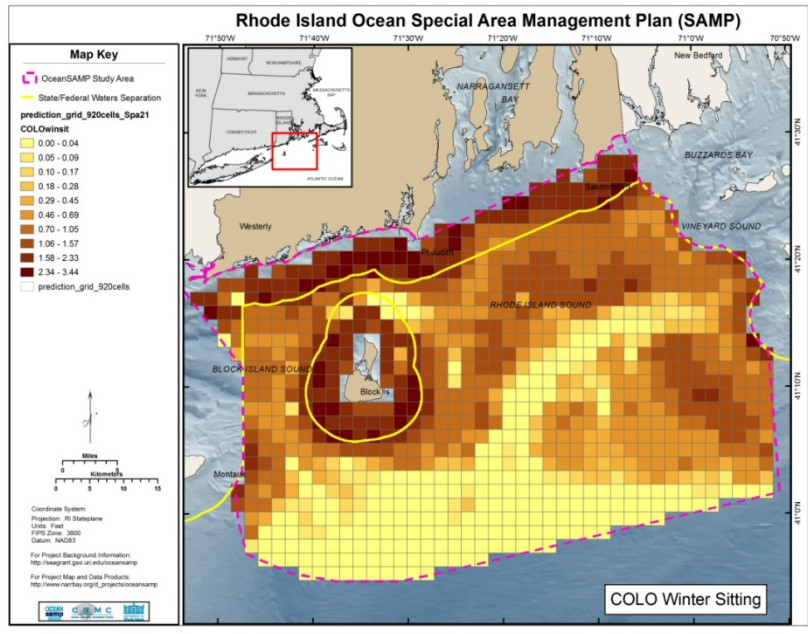

DSM of Common Loons in winter (individuals/km²)

Ship-based Line Transect Surveys (DSMs)

Winter: Common Loon, Northern Gannet, Large Gulls, Alcid species, Dovekie and Common Murre.

Spring: Common Loon, Northern Gannet, Large Gulls and Alcid species.

Summer: Shearwater species, Cory's Shearwater, Great Shearwater, Wilson's Storm-Petrel and Large Gulls.

Fall: Northern Gannet and Large Gulls.

Aerial-based Strip Transect Surveys (DSMs)

Winter: Loon species, Northern Gannet, Seaduck species, Common Eider, Large Gulls, Black-legged Kittiwake and Alcid species.

Spring: Loon species, Northern Gannet, Seaduck species, Common Eider, Large Gulls and Alcid species.

Summer: Shearwater species, Wilson's Storm-Petrels, Large Gulls and Tern species.

7. Species survey data sources (including databases used if applicable), data types used, and data/survey design requirements.

Only modeled those species with >50 detections per season (ship line-transect and aerial strip transect surveys).

8. Associated predictor and covariate data.

- a. Type
Bathymetry.
Distance from shore.
- b. Source (s)
NOAA Coastal Relief Model data set (NOAA 2004).
- c. Spatial and temporal resolution and extent.
50m².

9. Handling of multi-species/community information (will models consider each species independently, jointly model multiple species, or directly model community-level metrics like total abundance and diversity?)

At this time only individual species have been modeled.

10. Do you plan to explicitly identify hot-spots/cold-spots, and if so, how?

- a. Single species, multiple species, or both?
Yes, multiple species.
- b. Abundance, occurrence, species richness, diversity, persistence, other metrics?
Based on abundance.

11. Contact info, including website if applicable.

Kristopher J. Winiarski (401) 692-5326 Withakri@gmail.com

12. Bibliographic resources for methodology if appropriate

Buckland, S.T., D.R. Anderson, K.P. Burnham, J.L. Laake, D.L. Borchers, and L. Thomas. 2001. Introduction to distance sampling: estimating abundance of biological populations. Oxford University Press, London.

Burnham, K.P., S.T. Buckland, J.L. Laake, D.L. Borchers, T.A. Marques, J.R.B. Bishop and L. Thomas. 2004. Further topics in distance sampling. Pages 307-392 in Advanced Distance Sampling: Estimating Abundance of Biological Populations. (S.T. Buckland, D.R. Anderson, K.P. Burnham, J.L. Laake, D.L. Borchers, and L. Thomas, Eds.). Oxford University Press, New York.

Efron, B. and R.J. Tibshirani. 1993. An introduction to the bootstrap. Chapman and Hall, New York.

- Hedley, S.L., and S.T. Buckland. 2004. Spatial models for line transect sampling. *Journal of Agricultural, Biological and Environmental Statistics* 9: 181-199.
- Seber, G.A.F. 1982. *The estimation of animal abundance and related parameters*, Second edition. Griffin, London.
- Thomas, L., S.T. Buckland, E.R. Rexstad, J.L. Laake, S. Strindberg, S.L. Hedley, J.R.B. Bishop, T.A. Marques and K.P. Burnham. 2010. Distance software: design and analysis of distance sampling surveys for estimating population size. *Journal of Applied Ecology* 47: 5-14.
- Wood, S.N. 2006. *Generalized additive models: an introduction with R*. Chapman and Hall/CRC, Boca Raton, FL.

13. Papers published based on this work and associated citation information. If possible please attach the paper with your response.

- Winiarski KJ, Paton P, Trocki CL, McWilliams SR. 2011. Spatial distribution, abundance, and flight ecology of birds in nearshore and offshore waters of Rhode Island: January 2009 to August 2010. Rhode Island Ocean Special Area Management Plan Interim Report.

SUPPLEMENTAL DATA SYSTEMS INFORMATION

OBIS-USA Summary Statistics

Total Records*	7,178,729
Total Unique Taxa	84,220
Participants	39
Datasets	149

** In Process - Several million Records from a variety of data sources*

OBIS-USA, a program of the United States Geological Survey (USGS) Core Science Analytics and Synthesis (CSAS), is the US national node of the Ocean Biogeographic Information System (OBIS). Meant to serve research and natural resource management needs, OBIS-USA brings together marine biological occurrence data in a standard format, with metadata, web-based discovery and download, and web service access for users and applications.

Data sources are US government (including Federal, State and local) agencies, academic, and non-governmental organizations. The data represent species name, location and date, plus additional detail as available. OBIS-USA partners with several federal agencies to play a role in the full life cycle of marine data, from origination, through discovery, dissemination and applications, to archiving at National Ocean Data Center.

OBIS-USA goes beyond the limits traditionally encountered in biodiversity data. It configures the data and web services to enable integration with other data types, such as physical oceanography, water chemistry, climate, and other types. It can integrate application-critical details such as absence, abundance, effort, method, and tracking. Over time, OBIS-USA aims to further identify and innovate yet more categories of important biological observations and details.



Wind and Water Power Technologies Office
Wind Program
wind.energy.gov

DOE/EE-0925 • July 2013

Printed with a renewable-source ink on paper containing at least 50%
wastepaper, including 10% post-consumer waste.