

U.S. Department of Energy

FutureGen 2.0 Project

Final Environmental Impact Statement

DOE/EIS-0460 | October 2013



Volume I

Office of Fossil Energy
National Energy Technology Laboratory



COVER SHEET

Responsible Federal Agency: U.S. Department of Energy (DOE)

Cooperating Agencies: None

Title: Final Environmental Impact Statement for the FutureGen 2.0 Project (DOE/EIS-0460)

Location: Morgan County, Illinois

Contact:

For further information about this Environmental Impact Statement, contact:

Cliff Whyte, NEPA Compliance Officer
U.S. Department of Energy
National Energy Technology Laboratory
3610 Collins Ferry Road
Morgantown, WV 26507-0880
(304) 285-2098
Fax: (304) 285-4403
Email: Cliff.Whyte@netl.doe.gov

For general information on the DOE process for implementing the National Environmental Policy Act, contact:

Carol Borgstrom, Director
Office of NEPA Policy and Compliance (GC-54)
U.S. Department of Energy
1000 Independence Avenue, SW
Washington, DC 20585-0103
(202) 586-4600 or leave message
at (800) 472-2756
Email: AskNEPA@hq.doe.gov

Abstract:

This Environmental Impact Statement (EIS) evaluates the potential impacts associated with DOE's proposed action to provide financial assistance to the FutureGen Industrial Alliance (the Alliance) for the FutureGen 2.0 Project, including the direct and indirect environmental impacts from construction and operation of the proposed project. DOE's proposed action would provide approximately \$1 billion of funding (primarily under the American Recovery and Reinvestment Act) to support construction and operation of the FutureGen 2.0 Project. The funding would be used for project design and development, procurement of capital equipment, construction, and to support a 56-month demonstration period for a coal-fueled electric generation plant integrated with carbon capture and storage.

For the FutureGen 2.0 Project, the Alliance would construct and operate a 168-megawatt electrical (MWe) gross output coal-fueled electric generation plant using advanced oxy-combustion technology. The plant would use existing infrastructure, including the existing steam turbine generator (Unit 4), at Ameren Energy Resources' Meredosia Energy Center on the Illinois River just south of Meredosia, Illinois. The proposed project would include facilities designed to capture at least 90 percent of the carbon dioxide (CO₂) that would otherwise be emitted to the atmosphere **during steady-state operation**, equivalent to approximately 1.2 million tons (1.1 million metric tons) of CO₂ captured per year. The captured CO₂ would be compressed and transported via a new underground pipeline, approximately 30 miles long and **nominally 10 to 12 inches** in diameter, to a geologic storage area in eastern Morgan County, where it would be injected and stored in the Mt. Simon Formation (a saline aquifer) approximately 4,000 feet below the ground surface. The project would also employ systems for the monitoring, verification, and accounting of the CO₂ being geologically stored. Visitor, research, and training facilities would be sited in the vicinity of Jacksonville, Illinois. The proposed project would provide performance and emissions data, as well as establish operating and maintenance experience, that would facilitate future large-scale commercial deployment of oxy-combustion technology and geologic CO₂ storage.

DOE is the lead federal agency responsible for preparation of this EIS. DOE prepared the EIS pursuant to the National Environmental Policy Act (NEPA) and in compliance with the Council on Environmental Quality (CEQ) implementing regulations for NEPA (40 Code of Federal Regulations [CFR] 1500 through 1508) and DOE NEPA implementing procedures (10 CFR 1021). The EIS evaluates the potential environmental impacts of the FutureGen 2.0 Project as part of DOE's decision-making process to

determine whether to provide financial assistance. The EIS also analyzes the no action alternative, under which DOE would not provide financial assistance for the FutureGen 2.0 Project.

Public Participation:

DOE encourages public participation in the NEPA process. The Notice of Availability of the Draft EIS appeared in the *Federal Register* on May 3, 2013, which invited comments on the Draft EIS through the end of the comment period on June 17, 2013. DOE conducted a public hearing for the Draft EIS in Jacksonville, Illinois, on May 21, 2013, which included an informational session for one hour prior to the formal hearing. During the hearing, the public was encouraged to provide oral comments and to submit written comments to DOE through the close of the comment period. DOE also considered late comments. A summary of the public hearing is included in new Appendix I along with all agency and public comments on the Draft EIS and DOE responses.

Changes from the Draft EIS:

In this Final EIS, bold text and vertical lines in the margin indicate where the Draft EIS has been revised or supplemented (as exemplified by this paragraph). Deletions are not demarcated. Additions to the appendices in Volume II are indicated on the appendix cover sheets with vertical lines in the margin and bold text.

TABLE OF CONTENTS – VOLUME I

1	PURPOSE AND NEED	1-1
1.1	Introduction	1-1
1.2	Project Background	1-2
1.2.1	Original FutureGen Project	1-2
1.2.2	FutureGen 2.0 Project	1-3
1.3	Proposed Action	1-4
1.4	Purpose and Need for Agency Action	1-6
1.5	National Environmental Policy Act	1-7
1.5.1	DOE Responsibilities	1-7
1.5.2	NEPA Scoping Process	1-8
1.6	Scope of the Environmental Impact Statement	1-9
1.6.1	Issues Identified Prior to the Scoping Process	1-9
1.6.2	Comments Received and Issues Identified During the Scoping Process	1-10
1.6.3	Comments Received on the Draft EIS	1-13
1.6.3.1	Public Hearing and Comment Period	1-13
1.6.3.2	Summary of Comments on the Draft EIS	1-14
1.6.4	Decision to be Made by DOE	1-15
1.7	Organization and Contents of the EIS	1-15
2	PROPOSED ACTION AND ALTERNATIVES	2-1
2.1	DOE Proposed Action	2-1
2.2	No Action Alternative	2-2
2.3	Alternatives Considered but Dismissed from Further Evaluation	2-2
2.3.1	Alternative Fuel Sources	2-3
2.3.2	Alternative Advanced Coal-based Electric Generating Technologies	2-3
2.3.3	Alternative Retrofitting Technologies	2-4
2.3.4	Alternative Sites for the Oxy-Combustion Large Scale Test	2-4
2.3.5	Alternative CO ₂ Pipeline and Storage Reservoir Locations	2-5
2.4	FutureGen 2.0 Oxy-Combustion Large Scale Test	2-5
2.4.1	The Meredosia Energy Center	2-6
2.4.1.1	Boiler and Turbine Steam and Water Systems	2-11
2.4.1.2	Air and Flue Gas System	2-11
2.4.1.3	Waste Management Systems	2-11
2.4.1.4	Transportation Resources	2-12
2.4.1.5	Suspension of Energy Center Operations	2-13
2.4.2	Oxy-Combustion Large Scale Test	2-14
2.4.2.1	Oxy-Combustion Process and System Features	2-17
2.4.2.2	Additional Equipment and Systems	2-20
2.4.3	Oxy-Combustion Large Scale Test Construction Phase	2-24
2.4.3.1	Oxy-Combustion Facility Construction	2-28
2.4.3.2	Temporary Barge Unloading Facility	2-29
2.4.3.3	Construction Schedule and Workforce	2-30
2.4.3.4	Construction Materials and Waste	2-30
2.4.3.5	Construction Safety Policies and Programs	2-32
2.4.4	Oxy-Combustion Large Scale Test Operation Phase	2-32
2.4.4.1	Resource Requirements and Inputs	2-32
2.4.4.2	Process Wastes, Discharges, and By-Products	2-35

2.4.4.3	Health and Safety Policies and Programs.....	2-39
2.4.4.4	Permit Requirements.....	2-39
2.4.4.5	Power Purchase Agreement.....	2-39
2.4.5	Decommissioning.....	2-40
2.5	FutureGen 2.0 Pipeline and CO ₂ Storage Reservoir.....	2-40
2.5.1	CO ₂ Pipeline.....	2-41
2.5.1.1	Pipeline Corridor and Routes.....	2-42
2.5.1.2	Pipeline Design.....	2-45
2.5.1.3	Pipeline Construction.....	2-47
2.5.1.4	Pipeline Operations.....	2-50
2.5.2	CO ₂ Storage Study Area.....	2-53
2.5.2.1	CO ₂ Storage Area Siting.....	2-53
2.5.2.2	Surface Facilities.....	2-57
2.5.2.3	Injection Wells.....	2-65
2.5.2.4	Monitoring, Verification, and Accounting.....	2-73
2.5.2.5	Interim Actions.....	2-78
2.5.3	Visitor, Research, and Training Facilities.....	2-81
2.5.3.1	Educational Facilities Construction.....	2-82
2.5.3.2	Educational Facilities Operations.....	2-83
2.5.4	Decommissioning.....	2-84
3	AFFECTED ENVIRONMENT AND IMPACTS.....	3.0-1
3.1	Air Quality.....	3.1-1
3.1.1	Introduction.....	3.1-1
3.1.1.1	Region of Influence.....	3.1-1
3.1.1.2	Method of Analysis and Factors Considered.....	3.1-1
3.1.1.3	Regulatory Framework.....	3.1-3
3.1.1.4	Permitting Requirements.....	3.1-6
3.1.2	Affected Environment.....	3.1-9
3.1.2.1	Meredosia Energy Center.....	3.1-9
3.1.2.2	CO ₂ Pipeline, CO ₂ Storage Study Area, and Educational Facilities.....	3.1-13
3.1.3	Impacts of Proposed Action.....	3.1-13
3.1.3.1	Construction Impacts.....	3.1-13
3.1.3.2	Operational Impacts.....	3.1-18
3.1.4	Impacts of the No Action Alternative.....	3.1-28
3.2	Climate and Greenhouse Gases.....	3.2-1
3.2.1	Introduction.....	3.2-1
3.2.1.1	Region of Influence.....	3.2-1
3.2.1.2	Method of Analysis and Factors Considered.....	3.2-1
3.2.1.3	Regulatory Framework.....	3.2-1
3.2.2	Affected Environment.....	3.2-4
3.2.2.1	Regional and Local Climate.....	3.2-4
3.2.2.2	Greenhouse Gases.....	3.2-6
3.2.3	Impacts of Proposed Action.....	3.2-11
3.2.3.1	Construction Impacts.....	3.2-11
3.2.3.2	Operational Impacts.....	3.2-12
3.2.4	Impacts of the No Action Alternative.....	3.2-15
3.3	Physiography and Soils.....	3.3-1
3.3.1	Introduction.....	3.3-1
3.3.1.1	Region of Influence.....	3.3-1
3.3.1.2	Method of Analysis and Factors Considered.....	3.3-1

3.3.1.3	Regulatory Framework.....	3.3-1
3.3.2	Affected Environment	3.3-2
3.3.2.1	Physiography	3.3-2
3.3.2.2	Soils.....	3.3-2
3.3.2.3	Meredosia Energy Center.....	3.3-5
3.3.2.4	CO ₂ Pipeline	3.3-8
3.3.2.5	CO ₂ Storage Study Area	3.3-11
3.3.2.6	Educational Facilities	3.3-13
3.3.3	Impacts of Proposed Action	3.3-13
3.3.3.1	Construction Impacts.....	3.3-13
3.3.3.2	Operational Impacts	3.3-20
3.3.4	Impacts of the No Action Alternative.....	3.3-21
3.4	Geology.....	3.4-1
3.4.1	Introduction	3.4-1
3.4.1.1	Region of Influence.....	3.4-1
3.4.1.2	Method of Analysis and Factors Considered	3.4-1
3.4.1.3	Regulatory Framework.....	3.4-2
3.4.2	Affected Environment	3.4-3
3.4.2.1	Regional Geologic Setting	3.4-3
3.4.2.2	Meredosia Energy Center.....	3.4-10
3.4.2.3	CO ₂ Pipeline	3.4-10
3.4.2.4	CO ₂ Storage Study Area	3.4-11
3.4.2.5	Educational Facilities	3.4-12
3.4.3	Impacts of the Proposed Action.....	3.4-14
3.4.3.1	Construction Impacts.....	3.4-14
3.4.3.2	Operational Impacts	3.4-15
3.4.4	Impacts of the No Action Alternative.....	3.4-23
3.5	Groundwater	3.5-1
3.5.1	Introduction	3.5-1
3.5.1.1	Region of Influence.....	3.5-1
3.5.1.2	Method of Analysis and Factors Considered	3.5-1
3.5.1.3	Regulatory Framework.....	3.5-1
3.5.2	Affected Environment	3.5-2
3.5.2.1	Regional Hydrogeology	3.5-2
3.5.2.2	Meredosia Energy Center.....	3.5-4
3.5.2.3	CO ₂ Pipeline	3.5-5
3.5.2.4	CO ₂ Storage Study Area	3.5-6
3.5.2.5	Educational Facilities	3.5-8
3.5.3	Impacts of the Proposed Action.....	3.5-8
3.5.3.1	Construction Impacts.....	3.5-8
3.5.3.2	Operational Impacts	3.5-10
3.5.4	Impacts of the No Action Alternative.....	3.5-14
3.6	Surface Water.....	3.6-1
3.6.1	Introduction	3.6-1
3.6.1.1	Region of Influence.....	3.6-1
3.6.1.2	Method of Analysis and Factors Considered	3.6-1
3.6.1.3	Regulatory Framework.....	3.6-1
3.6.2	Affected Environment	3.6-2
3.6.2.1	Meredosia Energy Center.....	3.6-3
3.6.2.2	CO ₂ Pipeline	3.6-7
3.6.2.3	CO ₂ Storage Study Area	3.6-8

3.6.2.4	Educational Facilities	3.6-8
3.6.3	Impacts of Proposed Action	3.6-8
3.6.3.1	Construction Impacts.....	3.6-8
3.6.3.2	Operational Impacts	3.6-16
3.6.4	Impacts of the No Action Alternative.....	3.6-22
3.7	Wetlands and Floodplains.....	3.7-1
3.7.1	Introduction	3.7-1
3.7.1.1	Wetlands.....	3.7-1
3.7.1.2	Floodplains	3.7-3
3.7.1.3	Region of Influence	3.7-4
3.7.1.4	Method of Analysis and Factors Considered	3.7-4
3.7.1.5	Regulatory Framework.....	3.7-5
3.7.2	Affected Environment	3.7-5
3.7.2.1	Meredosia Energy Center	3.7-6
3.7.2.2	CO ₂ Pipeline	3.7-9
3.7.2.3	CO ₂ Storage Study Area	3.7-12
3.7.2.4	Educational Facilities	3.7-14
3.7.3	Impacts of Proposed Action	3.7-15
3.7.3.1	Construction Impacts.....	3.7-15
3.7.3.2	Operational Impacts	3.7-24
3.7.4	Impacts of the No Action Alternative.....	3.7-27
3.8	Biological Resources	3.8-1
3.8.1	Introduction	3.8-1
3.8.1.1	Region of Influence	3.8-1
3.8.1.2	Method of Analysis and Factors Considered	3.8-1
3.8.1.3	Regulatory Framework.....	3.8-1
3.8.2	Affected Environment	3.8-3
3.8.2.1	Terrestrial Habitat	3.8-5
3.8.2.2	Aquatic Habitat	3.8-8
3.8.2.3	Protected Species.....	3.8-10
3.8.2.4	Meredosia Energy Center.....	3.8-12
3.8.2.5	CO ₂ Pipeline	3.8-17
3.8.2.6	CO ₂ Storage Study Area	3.8-19
3.8.2.7	Educational Facilities	3.8-19
3.8.3	Impacts of Proposed Action	3.8-19
3.8.3.1	Construction Impacts.....	3.8-24
3.8.3.2	Operational Impacts	3.8-31
3.8.4	Impacts of the No Action Alternative.....	3.8-35
3.9	Cultural Resources	3.9-1
3.9.1	Introduction	3.9-1
3.9.1.1	Region of Influence	3.9-1
3.9.1.2	Method of Analysis and Factors Considered	3.9-1
3.9.1.3	Regulatory Framework.....	3.9-3
3.9.2	Affected Environment	3.9-5
3.9.2.1	Regional Cultural Context.....	3.9-5
3.9.2.2	History of the Meredosia Energy Center and the Central Illinois Public Service Company	3.9-5
3.9.2.3	Meredosia Energy Center.....	3.9-6
3.9.2.4	CO ₂ Pipeline	3.9-7
3.9.2.5	CO ₂ Storage Study Area	3.9-8
3.9.2.6	Educational Facilities	3.9-8

3.9.3	Impacts of Proposed Action	3.9-8
3.9.3.1	Construction Impacts.....	3.9-8
3.9.3.2	Operational Impacts	3.9-11
3.9.4	Impacts of the No Action Alternative.....	3.9-11
3.10	Land Use.....	3.10-1
3.10.1	Introduction	3.10-1
3.10.1.1	Region of Influence.....	3.10-1
3.10.1.2	Method of Analysis and Factors Considered	3.10-1
3.10.1.3	Regulatory Framework.....	3.10-1
3.10.2	Affected Environment	3.10-2
3.10.2.1	Meredosia Energy Center.....	3.10-2
3.10.2.2	CO ₂ Pipeline	3.10-3
3.10.2.3	CO ₂ Storage Study Area	3.10-4
3.10.2.4	Educational Facilities	3.10-4
3.10.3	Impacts of Proposed Action	3.10-5
3.10.3.1	Construction Impacts.....	3.10-5
3.10.3.2	Operational Impacts	3.10-10
3.10.4	Impacts of the No Action Alternative.....	3.10-12
3.11	Aesthetics.....	3.11-1
3.11.1	Introduction	3.11-1
3.11.1.1	Region of Influence.....	3.11-1
3.11.1.2	Method of Analysis and Factors Considered	3.11-2
3.11.1.3	Regulatory Framework.....	3.11-2
3.11.2	Affected Environment	3.11-2
3.11.2.1	Meredosia Energy Center.....	3.11-2
3.11.2.2	CO ₂ Pipeline	3.11-3
3.11.2.3	CO ₂ Storage Study Area	3.11-3
3.11.2.4	Educational Facilities	3.11-3
3.11.3	Impacts of Proposed Action	3.11-4
3.11.3.1	Construction Impacts.....	3.11-4
3.11.3.2	Operational Impacts	3.11-7
3.11.4	Impacts of the No Action Alternative.....	3.11-9
3.12	Materials and Waste Management.....	3.12-1
3.12.1	Introduction	3.12-1
3.12.1.1	Region of Influence.....	3.12-1
3.12.1.2	Method of Analysis and Factors Considered	3.12-1
3.12.1.3	Regulatory Framework.....	3.12-1
3.12.2	Affected Environment	3.12-3
3.12.2.1	Meredosia Energy Center.....	3.12-4
3.12.2.2	CO ₂ Pipeline	3.12-7
3.12.2.3	CO ₂ Storage Study Area	3.12-7
3.12.2.4	Educational Facilities	3.12-7
3.12.3	Impacts of Proposed Action	3.12-7
3.12.3.1	Construction Impacts.....	3.12-7
3.12.3.2	Operational Impacts	3.12-10
3.12.4	Impacts of the No Action Alternative.....	3.12-14
3.13	Traffic and Transportation	3.13-1
3.13.1	Introduction	3.13-1
3.13.1.1	Region of Influence.....	3.13-1
3.13.1.2	Method of Analysis and Factors Considered	3.13-1

3.13.2	Affected Environment	3.13-2
3.13.2.1	Regional and Local Roadway System.....	3.13-2
3.13.2.2	Rail, Air, and Public Transportation	3.13-3
3.13.2.3	Meredosia Energy Center.....	3.13-4
3.13.2.4	CO ₂ Pipeline and CO ₂ Storage Study Area	3.13-4
3.13.2.5	Educational Facilities	3.13-5
3.13.3	Impacts of Proposed Action	3.13-7
3.13.3.1	Construction Impacts.....	3.13-7
3.13.3.2	Operational Impacts	3.13-12
3.13.4	Impacts of the No Action Alternative.....	3.13-15
3.14	Noise and Vibration	3.14-1
3.14.1	Introduction	3.14-1
3.14.1.1	Region of Influence.....	3.14-1
3.14.1.2	Method of Analysis and Factors Considered	3.14-1
3.14.1.3	Regulatory Framework.....	3.14-3
3.14.2	Affected Environment	3.14-6
3.14.2.1	Meredosia Energy Center.....	3.14-6
3.14.2.2	CO ₂ Pipeline	3.14-12
3.14.2.3	CO ₂ Storage Study Area	3.14-12
3.14.2.4	Educational Facilities	3.14-12
3.14.2.5	Existing Traffic Noise (for All Project Components)	3.14-13
3.14.3	Impacts of Proposed Action	3.14-14
3.14.3.1	Construction Impacts.....	3.14-14
3.14.3.2	Operational Impacts	3.14-22
3.14.4	Impacts of the No Action Alternative.....	3.14-23
3.15	Utilities.....	3.15-1
3.15.1	Introduction	3.15-1
3.15.1.1	Region of Influence.....	3.15-1
3.15.1.2	Method of Analysis and Factors Considered	3.15-1
3.15.1.3	Regulatory Framework.....	3.15-1
3.15.2	Affected Environment	3.15-1
3.15.2.1	Meredosia Energy Center.....	3.15-1
3.15.2.2	CO ₂ Pipeline, CO ₂ Storage Study Area, and Educational Facilities.....	3.15-2
3.15.3	Impacts of Proposed Action	3.15-3
3.15.3.1	Construction Impacts.....	3.15-3
3.15.3.2	Operational Impacts	3.15-6
3.15.4	Impacts of the No Action Alternative.....	3.15-9
3.16	Community Services.....	3.16-1
3.16.1	Introduction	3.16-1
3.16.1.1	Region of Influence.....	3.16-1
3.16.1.2	Method of Analysis and Factors Considered	3.16-1
3.16.1.3	Regulatory Framework.....	3.16-1
3.16.2	Affected Environment	3.16-1
3.16.2.1	Meredosia Energy Center, CO ₂ Pipeline, CO ₂ Storage Study Area, and Educational Facilities.....	3.16-1
3.16.3	Impacts of Proposed Action	3.16-5
3.16.3.1	Construction Impacts.....	3.16-5
3.16.3.2	Operational Impacts	3.16-6
3.16.4	Impacts of the No Action Alternative.....	3.16-8

3.17 Human Health and Safety	3.17-1
3.17.1 Introduction	3.17-1
3.17.1.1 Region of Influence	3.17-1
3.17.1.2 Method of Analysis and Factors Considered	3.17-1
3.17.1.3 Risk Analysis.....	3.17-3
3.17.1.4 Potential Health Effects of CO ₂ (and other captured gas constituents)...	3.17-5
3.17.1.5 Relevant Safety Factors and Statistics.....	3.17-7
3.17.2 Affected Environment	3.17-10
3.17.2.1 Meredosia Energy Center.....	3.17-10
3.17.2.2 CO ₂ Pipeline	3.17-10
3.17.2.3 CO ₂ Storage Study Area	3.17-13
3.17.2.4 Educational Facilities	3.17-13
3.17.3 Impacts of Proposed Action	3.17-13
3.17.3.1 Construction Impacts.....	3.17-14
3.17.3.2 Operational Impacts	3.17-14
3.17.3.3 Post-Injection Impacts.....	3.17-29
3.17.4 Intentional Destructive Acts	3.17-37
3.17.5 Impacts of the No Action Alternative.....	3.17-38
3.18 Socioeconomics	3.18-1
3.18.1 Introduction	3.18-1
3.18.1.1 Region of Influence	3.18-1
3.18.1.2 Method of Analysis and Factors Considered	3.18-1
3.18.2 Affected Environment	3.18-1
3.18.2.1 Meredosia Energy Center, CO ₂ Pipeline, CO ₂ Storage Study Area, and Educational Facilities.....	3.18-1
3.18.3 Impacts of Proposed Action	3.18-4
3.18.3.1 Construction Impacts.....	3.18-4
3.18.3.2 Operational Impacts	3.18-8
3.18.4 Impacts of the No Action Alternative.....	3.18-10
3.19 Environmental Justice.....	3.19-1
3.19.1 Introduction	3.19-1
3.19.1.1 Region of Influence	3.19-1
3.19.1.2 Method of Analysis and Factors Considered	3.19-1
3.19.1.3 Regulatory Framework.....	3.19-2
3.19.2 Affected Environment	3.19-2
3.19.2.1 Meredosia Energy Center.....	3.19-2
3.19.2.2 CO ₂ Pipeline, CO ₂ Storage Study Area, and Educational Facilities.....	3.19-4
3.19.3 Impacts of Proposed Action	3.19-6
3.19.3.1 Construction Impacts.....	3.19-6
3.19.3.2 Operational Impacts	3.19-7
3.19.4 Impacts of the No Action Alternative.....	3.19-8
4 SUMMARY OF ENVIRONMENTAL CONSEQUENCES	4.1-1
4.1 Comparative Impacts of Alternatives.....	4.1-1
4.2 Measures to Mitigate Adverse Impacts.....	4.2-1
4.2.1 Introduction	4.2-1
4.2.2 Mitigation Measure Summary by Resource Area	4.2-1

4.3	Potential Cumulative Impacts	4.3-1
4.3.1	Background.....	4.3-1
4.3.2	Analysis Methodology.....	4.3-1
4.3.3	Foreseeable Future Actions Considered	4.3-4
4.3.4	Cumulative Impacts.....	4.3-8
4.3.4.1	Summary of Cumulative Impacts.....	4.3-8
4.3.4.2	Climate and Greenhouse Gases.....	4.3-23
4.3.4.3	Geology	4.3-25
4.4	Incomplete and Unavailable Information.....	4.4-1
4.5	Irreversible and Irretrievable Commitments	4.5-1
4.6	Relationship Between Short-Term Uses of the Environment and Long-Term Productivity ..	4.6-1
5	REGULATORY AND PERMIT REQUIREMENTS	5-1
6	REFERENCES.....	6-1
7	FEDERAL, STATE, LOCAL, AND TRIBAL CONTACTS.....	7-1
8	DISTRIBUTION LIST.....	8-1
9	LIST OF PREPARERS.....	9-1
10	GLOSSARY	10-1

LIST OF TABLES

Table 1-1.	Summary of Scoping Comments	1-12
Table 2-1.	Reported Air Emissions at the Meredosia Energy Center	2-12
Table 2-2.	Overview of Oxy-Combustion Facility Components and Features	2-15
Table 2-3.	Electrical and Thermal Performance Summary for Oxy-Combustion Facility	2-17
Table 2-4.	Estimated Process Material Requirements for the Oxy-Combustion Facility	2-33
Table 2-5.	Estimated Water Requirements and Sources	2-35
Table 2-6.	Estimated Process Waste Generation.....	2-35
Table 2-7.	Estimated Wastewater Generation and Disposal	2-37
Table 2-8.	Oxy-Combustion Facility Emissions under Normal Operating Conditions	2-39
Table 2-9.	Pipeline Crossings.....	2-47
Table 2-10.	Alliance Minimum CO ₂ Pipeline Acceptance Specifications.....	2-51
Table 2-11.	Construction and Operational Area Requirements for Injection and Monitoring Well Sites.....	2-58
Table 2-12.	Construction Personnel Requirements for Injection Well Facilities.....	2-58
Table 2-13.	Operational Personnel Requirements for Injection Well Facilities.....	2-59
Table 2-14.	Surface Area Impacted by Injection and Monitoring Well System for the Single-Site Scenario	2-76
Table 2-15.	Surface Area Impacted by Injection and Monitoring Well System for the Dual-Site Scenario	2-77
Table 2-16.	Construction Requirements for Educational Facilities	2-83
Table 2-17.	Operational Requirements for Educational Facilities	2-84
Table 3.1-1.	National and Illinois Ambient Air Quality Standards.....	3.1-4
Table 3.1-2.	Air Quality Index Descriptor Categories and Health Effects.....	3.1-6
Table 3.1-3.	Thresholds for Determination of Major Modification to Existing Source.....	3.1-7
Table 3.1-4.	Air Pollutant Prevention of Significant Deterioration Increments for Class I, II, and III Areas	3.1-8
Table 3.1-5.	Air Monitoring Stations Used to Characterize Ambient Air for FutureGen 2.0 Project.....	3.1-10
Table 3.1-6.	Air Monitoring Data Used to Characterize Ambient Air for the FutureGen 2.0 Project.....	3.1-11
Table 3.1-7.	Meredosia Energy Center Emissions for Recent Years.....	3.1-12
Table 3.1-8.	Equipment and Vehicle Emissions for Construction at Meredosia Energy Center ...	3.1-14
Table 3.1-9.	Equipment and Vehicle Emissions for Construction of CO ₂ Pipeline	3.1-15
Table 3.1-10.	Equipment and Vehicle Emissions for Construction of Injection Well Site(s)	3.1-16
Table 3.1-11.	Equipment and Vehicle Emissions for Construction of Educational Facilities	3.1-17
Table 3.1-12.	Total Construction Emissions.....	3.1-18
Table 3.1-13.	Meredosia Energy Center Proposed Emissions Units.....	3.1-19
Table 3.1-14.	Project Emissions Summary to Determine PSD Applicability.....	3.1-19
Table 3.1-15.	Oxy-Combustion Facility Emissions under Normal Operating Conditions	3.1-20
Table 3.1-16.	Significant Impact Levels	3.1-21
Table 3.1-17.	FutureGen 2.0 Significant Impact Analysis Results.....	3.1-22
Table 3.1-18.	Cumulative Impact Analysis.....	3.1-24
Table 3.1-19.	FutureGen 2.0 Significant Contribution Analysis Results.....	3.1-24
Table 3.1-20.	Significant Net Emissions from Energy Center Operations	3.1-26
Table 3.1-21.	Comparison of Existing and Proposed Cooling Towers.....	3.1-27
Table 3.1-22.	Generator Emissions at Injection Well Site during Operations	3.1-27
Table 3.1-23.	Vehicle Emissions during Project Operations	3.1-28
Table 3.2-1.	Federal Actions to Address Greenhouse Gas Concerns.....	3.2-2
Table 3.2-2.	Regional and State Actions to Address Greenhouse Gas Concerns	3.2-4

Table 3.2-3.	Seasonal Weather Data for Morgan County	3.2-5
Table 3.2-4.	Severe Weather Events in Morgan County	3.2-6
Table 3.2-5.	United States CO ₂ Emissions from Electric Power Sector Energy Consumption	3.2-10
Table 3.2-6.	Estimated Greenhouse Gas Emissions from Construction Activities	3.2-12
Table 3.2-7.	Estimated Greenhouse Gas Emissions from Operations of Proposed Project	3.2-13
Table 3.2-8.	Estimated Upper-Bound Emissions of each Greenhouse Gas from Operations of the Proposed Project	3.2-13
Table 3.2-9.	Comparison of Greenhouse Gas Emissions by Various Sources	3.2-14
Table 3.2-10.	Significant Net Greenhouse Gas Emissions from Energy Center Operations	3.2-15
Table 3.3-1.	Soil Map Units Found at the Meredosia Energy Center	3.3-6
Table 3.3-2.	Soil Map Units Along the Southern and Northern CO ₂ Pipeline Routes	3.3-8
Table 3.3-3.	Soil Map Units Found in the CO ₂ Storage Study Area	3.3-12
Table 3.3-4.	Soils Disturbed by Construction at the Meredosia Energy Center	3.3-17
Table 3.3-5.	Soils Present within the Construction Right-of-Way for the Southern and Northern CO ₂ Pipeline Routes	3.3-18
Table 3.3-6.	Soils Present within the Proposed Injection Well Site (Single-Site Scenario)	3.3-20
Table 3.4-1.	Coal, Oil, and Gas Wells Located in the UIC Survey Area	3.4-12
Table 3.4-2.	Summary of Possible Testing and Monitoring Activities	3.4-24
Table 3.5-1.	Summary of Past Water Use at the Meredosia Energy Center	3.5-5
Table 3.6-1.	Summary of Impaired Waters Data for Illinois River	3.6-5
Table 3.6-2.	Average Flow Rates of the Illinois River in Morgan County	3.6-6
Table 3.6-3.	Surface Waters within the CO ₂ Pipeline Corridor	3.6-7
Table 3.6-4.	Surface Waters within the CO ₂ Storage Study Area	3.6-8
Table 3.6-5.	Surface Water Crossings for Pipeline Routes (GIS-based)	3.6-13
Table 3.6-6.	Hydrostatic Water Needs for Pipeline Routes	3.6-14
Table 3.6-7.	Estimated Wastewater Discharge to Illinois River	3.6-19
Table 3.6-8.	NPDES Permit No. IL0000116 Effluent Concentration Limits (Daily Maximum) ...	3.6-20
Table 3.6-9.	Operational Scenarios for Pre- and Post-Suspension of Meredosia Energy Center ...	3.6-21
Table 3.7-1.	NWI-Mapped Wetlands within the CO ₂ Pipeline Corridor	3.7-9
Table 3.7-2.	Floodplains within the CO ₂ Pipeline Corridor	3.7-12
Table 3.7-3.	NWI-Mapped Wetlands within the CO ₂ Storage Study Area	3.7-14
Table 3.7-4.	Floodplains within the CO ₂ Storage Study Area	3.7-14
Table 3.7-5.	Wetlands within the Proposed Construction Right-of-Way for CO ₂ Pipeline Routes	3.7-19
Table 3.7-6.	Floodplains within the Proposed Construction Right-of-Way for CO ₂ Pipeline Routes	3.7-21
Table 3.7-7.	Wetlands within the Operational Right-of-Way for CO ₂ Pipeline Routes	3.7-25
Table 3.7-8.	Floodplains within the Operational Right-of-Way for CO ₂ Pipeline Routes	3.7-26
Table 3.8-1.	Federally- and State-Protected Species Potentially Occurring in Morgan County	3.8-11
Table 3.8-2.	Land Cover Types within Potential Areas of Disturbance at the Meredosia Energy Center	3.8-13
Table 3.8-3.	Land Cover Types within the CO ₂ Pipeline Corridor and CO ₂ Storage Study Area	3.8-17
Table 3.8-4.	Potential for Effects to Protected Species Potentially Occurring within the Region of Influence	3.8-20
Table 3.8-5.	Potential Land Cover Lost within the Disturbed Areas of the Energy Center and Pipeline Routes	3.8-25
Table 3.9-1.	Cultural Resources Surveys Completed within the Region of Influence	3.9-2
Table 3.9-2.	Cultural Resources Identified within the Region of Influence	3.9-10
Table 3.10-1.	Land Use Acreage by Type	3.10-2

Table 3.10-2.	Land Use Types within Potential Areas of Disturbance at the Meredosia Energy Center.....	3.10-3
Table 3.10-3.	Land Use within the CO ₂ Pipeline Corridor and Storage Study Area.....	3.10-4
Table 3.10-4.	Potential Pipeline Route Construction Disturbances to Land Use.....	3.10-8
Table 3.12-1.	Illinois Landfills within the Region of Influence and Expected Year of Closure.....	3.12-4
Table 3.12-2.	Historical Material Usage Rates	3.12-5
Table 3.12-3.	Historical Coal Combustion Residuals Generation	3.12-6
Table 3.12-4.	Historical Hazardous Waste Generation.....	3.12-6
Table 3.12-5.	Historical Solid (Non-hazardous) Waste Generation.....	3.12-7
Table 3.12-6.	Estimated Process Material Requirements for the Oxy-Combustion Facility	3.12-10
Table 3.12-7.	Estimated Other Waste Generation Rates.....	3.12-11
Table 3.13-1.	Illinois Department of Transportation Proposed Highway Improvement Near the Region of Influence	3.13-3
Table 3.13-2.	Level of Service on Roadway Segments Near the Meredosia Energy Center– Existing Conditions.....	3.13-5
Table 3.13-3.	Roadways within the Pipeline Corridor and Adjacent to the CO ₂ Storage Study Area.....	3.13-7
Table 3.13-4.	Additional Daily Trips from Construction at the Meredosia Energy Center and CO ₂ Pipeline.....	3.13-8
Table 3.13-5.	Level of Service on Nearby Roadways - During Peak Construction (2015).....	3.13-9
Table 3.13-6.	Comparison of Level of Service on Nearby Roadways.....	3.13-10
Table 3.13-7.	Daily Trips from Operations.....	3.13-12
Table 3.13-8.	Estimated Level of Service on Nearby Roadways during Meredosia Energy Center Operation (2017)	3.13-13
Table 3.14-1.	Perceived Change in Decibel Level.....	3.14-2
Table 3.14-2.	Sound Level and Loudness of Typical Noises.....	3.14-2
Table 3.14-3.	U.S. Department of Housing and Urban Development Guidelines for Evaluating Sound Level Impacts on Residential Properties	3.14-3
Table 3.14-4.	Permissible Sound Levels for Class C Land to Class A Land.....	3.14-4
Table 3.14-5.	Noise Abatement Criteria	3.14-5
Table 3.14-6.	Guidelines for Potential Vibration Annoyance.....	3.14-5
Table 3.14-7.	Thresholds for Potential Vibration Damage	3.14-6
Table 3.14-8.	Summary of Noise Monitoring Sites	3.14-8
Table 3.14-9.	Existing Ambient Sound Levels at the Monitoring Sites.....	3.14-11
Table 3.14-10.	Estimated Sound Levels Adjacent to Nearby Roadways - Existing Conditions.....	3.14-13
Table 3.14-11.	Common Noise Levels Associated with Outdoor Construction	3.14-14
Table 3.14-12.	Number of Sensitive Receptors within 500 and 1,000 Feet of Pipeline Right-of-Way.....	3.14-16
Table 3.14-13.	Ambient Sound Measurements at Nearest Residence to Stratigraphic Well.....	3.14-17
Table 3.14-14.	Sound Measurements at Various Distances and Directions from Stratigraphic Well during Drilling Activities	3.14-19
Table 3.14-15.	Estimated Sound Levels at Various Distances from Injection Well Construction ...	3.14-20
Table 3.14-16.	Estimated Sound Levels Adjacent to Nearby Roadways - Proposed Project	3.14-21
Table 3.16-1.	Fire Department Statistics.....	3.16-2
Table 3.16-2.	Law Enforcement Employee Information.....	3.16-3
Table 3.16-3.	Crime Statistics	3.16-3
Table 3.16-4.	Healthcare Statistics.....	3.16-4
Table 3.16-5.	Public School Statistics.....	3.16-4
Table 3.16-6.	Private School Statistics.....	3.16-5
Table 3.17-1.	Potential Health Effects from Exposure to CO ₂ and Trace Gases.....	3.17-5

Table 3.17-2.	Longer Duration Criteria for CO ₂ and Trace Gases Not Likely to Cause Appreciable Health Risks to Humans	3.17-6
Table 3.17-3.	Occupational Injury Data for Related Industries in United States in 2010.....	3.17-7
Table 3.17-4.	Fatality Data for Related Industries in United States in 2010.....	3.17-8
Table 3.17-5.	Pipeline Safety Record in United States (1992 through 2011)	3.17-8
Table 3.17-6.	Meredosia Energy Center Region of Influence Demographics	3.17-10
Table 3.17-7.	Alliance Minimum CO ₂ Pipeline Acceptance Specifications.....	3.17-16
Table 3.17-8.	Pasquill Meteorological Stability Classes.....	3.17-18
Table 3.17-9.	Meteorological Conditions Used in SLAB Simulations	3.17-18
Table 3.17-10.	Simulated Vapor Plume Transport Distances for Pipeline Releases	3.17-19
Table 3.17-11.	Estimated Number of People Affected by CO ₂ and Trace Gases from the Hypothetical Pipeline Releases.....	3.17-23
Table 3.17-12.	Simulated Vapor Plume Transport Distances for Vertical Injection Well.....	3.17-26
Table 3.17-13.	Simulated Vapor Plume Transport Distances for Horizontal Injection Well	3.17-28
Table 3.17-14.	Potential Types of Releases from CO ₂ Storage Study Area.....	3.17-31
Table 3.17-15.	Potential Subsurface CO ₂ Releases from Wells and Subsurface Storage Formation.....	3.17-34
Table 3.17-16.	Potential Acute Human Health Effects within 300 Feet of Post-injection Releases.	3.17-35
Table 3.17-17.	Potential Chronic Human Health Effects within 300 Feet of Post-injection Releases	3.17-36
Table 3.18-1.	Population Data.....	3.18-2
Table 3.18-2.	Housing within the Region of Influence	3.18-3
Table 3.18-3.	Employment and Income Data.....	3.18-3
Table 3.19-1.	County, State, and National Population and Low-Income Distributions (2010)	3.19-4
Table 4.1-1.	Summary of Environmental Impacts by Alternative for the FutureGen 2.0 Project.....	4.1-2
Table 4.2-1.	Mitigation Measures for the Proposed FutureGen 2.0 Project.....	4.2-2
Table 4.3-1.	Levels of Importance of the Potential for Cumulative Impacts by Resource	4.3-2
Table 4.3-2.	Reasonably Foreseeable Future Actions Considered.....	4.3-5
Table 4.3-3.	Summary of Cumulative Impacts	4.3-9
Table 5-1.	Relevant Regulatory and Permit Requirements for the Proposed Project	5-1

LIST OF FIGURES

Figure 1-1.	Steps in the NEPA Process	1-8
Figure 2-1.	The FutureGen 2.0 Project.....	2-2
Figure 2-2.	Project Location Map.....	2-3
Figure 2-3.	Meredosia Energy Center	2-6
Figure 2-4.	Meredosia Energy Center Features – Aerial Overview	2-8
Figure 2-5.	Meredosia Energy Center – Coal Handling and Nearby Features	2-9
Figure 2-6.	Meredosia Energy Center Features – Coal and Fuel Handling Systems	2-10
Figure 2-7.	Simplified Diagram of Oxy-Combustion Facility	2-14
Figure 2-8.	Conceptual Oxy-Combustion Facility Site Layout.....	2-16
Figure 2-9.	Basic Air Separation Process.....	2-18
Figure 2-10.	Oxy-Combustion Cool Recycle Process Schematic	2-18
Figure 2-11.	Basic Compression and Purification Process.....	2-20
Figure 2-12.	Proposed Access Roads	2-21
Figure 2-13.	Stormwater Management.....	2-25
Figure 2-14.	Temporary and Permanent Impact Areas at Energy Center, as Evaluated in the Draft EIS	2-26
Figure 2-15.	Revised Temporary and Permanent Impact Areas at Energy Center, Reflecting Current Plans.....	2-27
Figure 2-16.	Project Concept.....	2-41
Figure 2-17.	CO ₂ Pipeline Corridor to the CO ₂ Storage Study Area.....	2-43
Figure 2-18.	Southern and Northern CO ₂ Pipeline Route Options to CO ₂ Storage Study Area.....	2-44
Figure 2-19.	Recommended Construction Right-of-Way Cross Section	2-49
Figure 2-20.	Location of Injection Well Site Property for Single-Site Scenario.....	2-56
Figure 2-21.	Single-Site Scenario - Injection Well Site Surface Features Conceptual Layout	2-60
Figure 2-22.	Dual-Site Scenario - Primary Injection Well Site Surface Features Conceptual Layout	2-62
Figure 2-23.	Dual-Site Scenario - Secondary Injection Well Site Surface Features Conceptual Layout	2-63
Figure 2-24.	Proposed Horizontal Injection Well Construction Details.....	2-66
Figure 2-25.	Geological Stratigraphic Column for the CO ₂ Storage Study Area and Vertical Injection Well Construction Details.....	2-67
Figure 2-26.	Predicted Areal Extent of CO ₂ Plume and Monitoring Well Network for Single- Site Scenario with Four Horizontal Wells	2-69
Figure 2-27.	Drill Rig during Daytime Operations	2-70
Figure 2-28.	Drill Rig during Nighttime Operations	2-70
Figure 3.1-1.	Air Quality Control Regions in Illinois	3.1-2
Figure 3.1-2.	Illinois Air Monitoring Sites.....	3.1-5
Figure 3.2-1.	Wind Rose for Region, Springfield, Illinois Airport	3.2-7
Figure 3.2-2.	Historical Trends in Global Atmospheric CO ₂ Concentrations and Emissions.....	3.2-9
Figure 3.2-3.	Economic Sectors and Greenhouse Gases Contributing to Global Anthropogenic Emissions.....	3.2-9
Figure 3.2-4.	United States CO ₂ Emissions by Sector	3.2-11
Figure 3.3-1.	Physiographic Divisions of Illinois.....	3.3-3
Figure 3.3-2.	Soils Map of Meredosia Energy Center.....	3.3-7
Figure 3.4-1.	Cross Section of the Bedrock through Morgan County.....	3.4-5
Figure 3.4-2.	Generalized Stratigraphic Column for the CO ₂ Storage Study Area.....	3.4-6
Figure 3.4-3.	Peak Horizontal Acceleration Values (as %g) with a 2 Percent Probability of Exceedance in 50 years.....	3.4-10

Figure 3.4-4.	Oil, Gas, and Gas Storage Wells in the Underground Injection Control Survey Area.....	3.4-13
Figure 3.4-5.	Effectiveness of Trapping Mechanisms Over Time	3.4-17
Figure 3.5-1.	Shallow Groundwater Aquifers	3.5-3
Figure 3.5-2.	Shallow Groundwater Wells in the Underground Injection Control Survey Area	3.5-7
Figure 3.6-1.	Watershed Boundaries and Surface Water Features in the ROI	3.6-4
Figure 3.6-2.	The Elevation of the Lower Illinois River Watershed and Locations of the U.S. Geological Survey Surface Water Monitoring Stations.....	3.6-5
Figure 3.7-1.	Wetlands at the Meredosia Energy Center.....	3.7-7
Figure 3.7-2.	Floodplains at the Meredosia Energy Center.....	3.7-8
Figure 3.7-3.	Wetlands and Floodplains in CO ₂ Pipeline Corridor (Western Portion).....	3.7-10
Figure 3.7-4.	Wetlands and Floodplains in CO ₂ Pipeline Corridor (Eastern Portion) and CO ₂ Storage Study Area	3.7-11
Figure 3.7-5.	Wetlands and Floodplains at the CO ₂ Storage Study Area.....	3.7-13
Figure 3.8-1.	Illinois Level III and IV Ecoregions	3.8-4
Figure 3.8-2.	Land Cover at the Meredosia Energy Center in Areas of Disturbance (Final EIS)....	3.8-14
Figure 3.8-3.	Land Cover at the Meredosia Energy Center in Areas of Disturbance (Draft EIS)....	3.8-15
Figure 3.11-1.	Typical Regional Landscape.....	3.11-2
Figure 3.11-2.	Surrounding Area with Meredosia Energy Center in Background	3.11-4
Figure 3.11-3.	Morgan County CO ₂ Storage Study Area View from North.....	3.11-4
Figure 3.13-1.	Primary Roadways within 40 Miles of the Meredosia Energy Center.....	3.13-6
Figure 3.14-1.	Noise Class Designations for Properties Adjacent to Meredosia Energy Center	3.14-7
Figure 3.14-2.	Noise Monitoring Sites	3.14-9
Figure 3.14-3.	Sound Measurement Locations at Stratigraphic Well.....	3.14-18
Figure 3.17-1.	2010 Population Density in Vicinity of Meredosia Energy Center and Western Part of Pipeline Route to CO ₂ Storage Study Area	3.17-11
Figure 3.17-2.	2010 Population Density in Vicinity of Eastern Part of Pipeline Route and CO ₂ Storage Study Area in Morgan County.....	3.17-12
Figure 3.17-3.	Population Density in Vicinity of Area of Injection Well Site(s).....	3.17-25
Figure 3.19-1.	Minority Populations within the FutureGen 2.0 Project Area	3.19-3
Figure 3.19-2.	Low-Income Populations within the FutureGen 2.0 Project Area.....	3.19-5

APPENDICES – VOLUME II

APPENDIX A	PUBLIC SCOPING
APPENDIX B	CONSULTATION LETTERS
APPENDIX C	MAP VIEWS OF PIPELINE
APPENDIX D	WETLANDS SURVEYS
APPENDIX E	BIOLOGICAL SURVEYS
APPENDIX F	CULTURAL SURVEYS
APPENDIX G	GEOLOGICAL REPORT
APPENDIX H	AGRICULTURAL MITIGATION
APPENDIX I	PUBLIC COMMENTS ON THE DRAFT EIS

INTENTIONALLY LEFT BLANK

ACRONYMS

Acronym	Definition
7Q10	7-day, 10-year low-flow frequency
ACHP	Advisory Council on Historic Preservation
AEGL	Acute Exposure Guideline Level
AoR	area of review
APE	area of potential effect
AQCR	air quality control region
AQI	air quality index
ASHRAE	American Society of Heating, Refrigerating, and Air-Conditioning Engineers
bgs	below ground surface
BMPs	best management practices
Btu	British thermal unit
CAA	Clean Air Act
CCPI	Clean Coal Power Initiative
CEQ	Council on Environmental Quality
CFR	Code of Federal Regulations
CIPSCO	Central Illinois Public Service Company
CO₂	carbon dioxide
CO₂-eq	CO ₂ equivalents
Co-Op	cooperative
CR	County Road
CWA	Clean Water Act
dB	decibel
dba	A-weighted sound level in decibels
DOE	U.S. Department of Energy
DOT	U.S. Department of Transportation
EO	Executive Order
EIS	Environmental Impact Statement
ERPG	Emergency Response Planning Guidelines
ESA	Endangered Species Act
°F	degrees Fahrenheit
FEMA	Federal Emergency Management Agency

Acronym	Definition
FHWA	Federal Highway Administration
FR	Federal Register
FTA	Federal Transit Administration
FTE	full-time equivalent
GHG	greenhouse gas
GIS	geographic information system
gpd	gallons per day
gpm	gallons per minute
HAPs	hazardous air pollutant
HUD	U.S. Department of Housing and Urban Development
I-#	Interstate Highway
IAC	Illinois Administrative Code
IDNR	Illinois Department of Natural Resources
IDOA	Illinois Department of Agriculture
IDOT	Illinois Department of Transportation
IEMA	Illinois Emergency Management Agency
IEPA	Illinois Environmental Protection Agency
IGCC	integrated gasification combined cycle
IL-#	Illinois Highway
ILCS	Illinois Compiled Statutes
IWI	Illinois Wetland Inventory
kV	kilovolt
kW	kilowatt
kWh	kilowatt-hours
L₅₀	sound levels exceeded 50 percent of the time
L₉₀	sound levels exceeded 90 percent of the time
L_{dn} or DNL	day-night sound level or 24-hour L _{eq}
LED	light emitting diode
LEED	Leadership in Energy and Environmental Design
L_{eq}	equivalent sound level
L_{eq(h)}	equivalent sound level over one hour
LOS	level of service
MACT	maximum achievable control technology

Acronym	Definition
mgd	million gallons per day
MOVES	Motor Vehicle Emission Simulator
MSDS	material safety data sheet
MVA	monitoring, verification, and accounting
MWe	megawatt electrical
MWh	megawatt hour
NAAQS	National Ambient Air Quality Standards
NAC	noise abatement criteria
NEPA	National Environmental Policy Act
NESHAPs	National Emission Standards for Hazardous Air Pollutants
NETL	National Energy Technology Laboratory
NHPA	National Historic Preservation Act
NOA	Notice of Availability
NOAA	National Oceanic and Atmospheric Administration
NOI	Notice of Intent
NPDES	National Pollutant Discharge Elimination System
NRCS	Natural Resources Conservation Service
NRHP	National Register of Historic Places
NSPS	New Source Performance Standards
NWP	Nationwide Permit
OSHA	Occupational Safety and Health Administration
PAC	protective action criteria
PCB	polychlorinated biphenyl
PEL	permissible exposure limit
PM₁₀	particulate matter of diameter of 10 micrometers or less
PM_{2.5}	particulate matter of diameter of 2.5 micrometers or less
PSD	Prevention of Significant Deterioration
psi	pounds per square inch
psig	pounds per square inch gauge
RCRA	Resource Conservation and Recovery Act
RIMS II	Regional Input-Output Modeling System II
ROD	Record of Decision
ROI	region of influence

Acronym	Definition
ROW	right-of-way
SACTI	seasonal/annual cooling tower impact
SCADA	supervisory control and data acquisition
SDWA	Safe Drinking Water Act
SHPO	State Historic Preservation Office
SIL	Significant Impact Level
SPCC	Spill Prevention, Control, and Countermeasures
STOMP	Subsurface Transport Over Multiple Phases Model
SWPPP	Stormwater Pollution Prevention Plan
TEEL	temporary emergency exposure limit
TMDL	total maximum daily load
U.S.	United States
UIC	Underground Injection Control
US-#	U.S. Highway
USACE	U.S. Army Corps of Engineers
USC	United States Code
USDA	U.S. Department of Agriculture
USDW	underground source of drinking water
USEPA	U.S. Environmental Protection Agency
USFWS	U.S. Fish and Wildlife Service
USGS	U.S. Geological Survey
VOC	volatile organic compound

1 PURPOSE AND NEED

1.1 INTRODUCTION

This chapter introduces the proposed FutureGen 2.0 Project and describes the purpose and need for agency action and the scope of this Environmental Impact Statement (EIS). This chapter also summarizes the National Environmental Policy Act (NEPA) of 1969 process, project history and objectives, and the public involvement process undertaken for this EIS.

In 2010, the United States (U.S.) Department of Energy (DOE) proposed to fund the final design, construction, and initial operation of the FutureGen 2.0 Project, subject to the requirements of NEPA. To assess the potential environmental impacts of the project, DOE has prepared this EIS in accordance with NEPA (42 United States Code [USC] 4321 *et seq.*) and in compliance with the Council on Environmental Quality (CEQ) implementing regulations for NEPA (40 Code of Federal Regulations [CFR] 1500 through 1508) and DOE's NEPA implementing procedures (10 CFR 1021). To date, DOE has authorized the expenditure of funds for the purpose of project definition, cost estimating, and preliminary and front-end engineering design activities, and to facilitate environmental review. Such activities do not have an adverse impact on the environment or limit the choice of reasonable alternatives. This EIS will inform DOE's decision of whether to authorize the expenditure of additional funds for final design, construction, and initial operation of the FutureGen 2.0 Project.

FutureGen 2.0 is a public-private partnership formed for the purpose of developing the first large-scale oxy-combustion repowering project in the world that would use carbon capture and storage technology. The FutureGen 2.0 Project consists of two components: the Oxy-Combustion Large Scale Test and the Carbon Dioxide (CO₂) Pipeline and Storage Reservoir. Additionally, visitor, research, and training facilities (also referred to as the educational facilities) would be provided at a suitable location to support public outreach and communication, and to provide training and research opportunities associated with near-zero emissions power generation and CO₂ capture and storage technologies.

DOE has entered into a cooperative agreement with the FutureGen Industrial Alliance (Alliance) under which the Alliance, cooperating with Ameren Energy Resources (Ameren), would upgrade an energy center currently owned by Ameren near Meredosia, Illinois, with oxy-combustion and carbon capture technology provided by the Babcock & Wilcox Power Generation Group (Babcock & Wilcox) and Air Liquide Process and Construction, Inc. (Air Liquide). The plant would capture at least 90 percent of its CO₂ emissions **during steady-state operation** and reduce other emissions to near zero. The captured CO₂ would

Oxy-Combustion Technology

Oxy-combustion is the combustion of coal with a mixture of oxygen and recycled flue gas (instead of air), resulting in a gas by-product that is primarily CO₂. This facilitates the capture of CO₂, which, in the case of the FutureGen 2.0 Project, would be permanently stored underground rather than released to the atmosphere.

be transported through a 30-mile pipeline to injection wells that would be used to inject the CO₂ approximately 4,000 feet below the earth's surface into a geologic formation for permanent storage. The project would be designed to capture, transport, and inject approximately 1.2 million tons (1.1 million metric tons) of CO₂ annually, up to a total of 24 million tons (22 million metric tons) over approximately 20 years. The Alliance would construct and operate a visitor center and research and training facilities related to carbon capture and storage in the local area.

The Alliance is a non-profit membership organization created to benefit the public interest and the interests of science through research, development, and demonstration of near-zero emissions coal technology. It was formed to partner with DOE on the FutureGen Initiative. Members of the Alliance include some of the largest coal producers, coal users, and coal equipment suppliers in the world. The Alliance's current members are: Alpha Natural Resources, Inc.; Anglo American, SA; Joy Global Inc.; Peabody Energy Corporation; and Xstrata, PLC. The active role of industry in this FutureGen Initiative

ensures that the public and private sector share the cost and risk of developing the advanced technologies necessary to commercialize the FutureGen concept.

The Alliance has an open membership policy to encourage the addition of other coal producers, coal users, and coal equipment suppliers, both domestic and international. Consistent with the FutureGen Initiative, DOE encourages participation from international organizations to maximize the global applicability and acceptance of FutureGen 2.0's results, helping to support an international consensus on the role of coal and geologic CO₂ storage in addressing global greenhouse gas (GHG) emissions and energy security.

1.2 PROJECT BACKGROUND

For more than 25 years, DOE has been co-funding large-scale demonstrations of clean coal technologies to hasten their adoption into the commercial marketplace. Developing this technology is critical for reducing conventional air pollutants and CO₂ emissions, maintaining the ability to continue to use abundant domestic coal reserves, and keeping the nation's electricity supplies secure and affordable. Federal financial support is needed to help reduce the risks inherent in these first-of-a-kind projects. One of DOE's clean coal demonstration efforts, the FutureGen Initiative, is designed to demonstrate the commercial feasibility of coal-fueled energy generation with carbon capture and storage at a commercial scale. This section describes the original FutureGen Project and the current FutureGen 2.0 Project.

1.2.1 Original FutureGen Project

On February 27, 2003, President George W. Bush announced the FutureGen Initiative, a \$1 billion, 10-year demonstration project to create the world's first coal-based, zero emissions electricity and hydrogen power plant. The President's announcement emphasized the need for the FutureGen Initiative to support other federal initiatives, including the National Climate Change Technology Initiative (June 11, 2001) and the Hydrogen Fuel Initiative (January 28, 2003). These initiatives aimed to reduce the nation's output of GHG emissions to improve the global environment and provide advanced technologies to meet the world's energy needs.

In response to the President's FutureGen Initiative, DOE developed plans for the FutureGen Project, which was intended to establish the technical and economic feasibility of producing electricity and hydrogen from coal, while capturing and geologically storing the CO₂ generated in the process. On April 21, 2003, DOE issued a Request for Information seeking expressions of interest from prospective consortia of industries most heavily impacted by potential future limitations on carbon emissions. DOE outlined a plan to enter into a cooperative agreement with a consortium led by the coal-fueled electric power industry and the coal production industry.

A consortium of coal-fueled utilities, coal production companies, and coal production equipment suppliers formed the Alliance, and responded to DOE's request. On December 2, 2005, DOE and the Alliance signed a limited-scope cooperative agreement to initiate the FutureGen Project with a project definition phase that yielded a conceptual design report and project plans. This phase led to the signing of a full-scope cooperative agreement on March 23, 2007, that was intended to establish the remainder of the project. DOE and the Alliance were to share the costs of the development, construction, and operation of the FutureGen Project.

The FutureGen Project was to provide a platform to test advanced technologies for producing both electricity and hydrogen from coal, based on the design concept known as integrated gasification combined cycle (IGCC). This technology has the potential for increasing energy conversion efficiency while reducing air pollution emissions rates. Geologic storage of CO₂ was to be a unique component of the project. The CO₂ was to be captured and stored in a deep underground saline formation.

In accordance with the cooperative agreement, the Alliance implemented a competitive siting process to identify the IGCC power plant and CO₂ storage site that could best meet the goals of the FutureGen

Project. This process began with the Alliance's issuance of a Request for Proposals on March 7, 2006, in which it sought proposals from potential site hosts. The Alliance rigorously evaluated the 12 proposals received and identified four candidate sites for full consideration by the Alliance and DOE. The candidate sites, announced by the Alliance on July 21, 2006, were located in Mattoon, Illinois; Tuscola, Illinois; Jewett, Texas; and Odessa, Texas.

On July 28, 2006, and in accordance with NEPA, DOE published a Notice of Intent (NOI) to prepare an EIS to consider whether to provide financial assistance for the FutureGen Project and to evaluate the potential environmental impacts of constructing and operating the FutureGen Project at each of the four candidate sites (71 *Federal Register* [FR] 42840). Subsequently, DOE prepared a Draft and a Final EIS documenting its environmental analyses. In the Final EIS, issued on November 17, 2007, DOE stated its preferred alternative was to provide financial assistance to the FutureGen project and tentatively found all four sites acceptable.

On December 18, 2007, the Alliance announced that, after extensive review and evaluation of the advantages and disadvantages of the four candidate sites, both individually and in comparison to one another, it had selected the site in Mattoon, Illinois, as the host site for the FutureGen Project, pending the outcome of DOE's Record of Decision (ROD) (Alliance 2007).

However, on January 29, 2008, DOE announced that it would terminate its funding for the FutureGen Project, primarily due to higher than expected costs. Instead, DOE stated its intention to implement a new strategy for the FutureGen Initiative that would promote equipping multiple new clean coal power plants with advanced carbon capture and storage technology, instead of one single research-oriented power plant. Despite the Alliance's efforts to modify the design and the proposed cost-share structure of the original FutureGen Project, in June 2008, DOE notified the Alliance that it had decided to withdraw from the FutureGen Project and that it would not renew its cooperative agreement. The Alliance, believing in the merits of the project, continued its development using private sector funds and grant funding provided by the state of Illinois.

In 2009, DOE reassessed its earlier decision and reached an agreement with the Alliance to complete a preliminary design, a revised cost estimate, and a funding plan pursuant to a new limited-scope cooperative agreement. On July 14, 2009, DOE issued a ROD that stated its intention to implement the FutureGen Initiative by proceeding with financial assistance for the FutureGen Project at any one of the four alternative sites analyzed in the EIS. DOE also stated that it anticipated committing \$1 billion in American Recovery and Reinvestment Act funds, with remaining funds to come from the Alliance, revenues from the sale of electricity, and other funding sources.

1.2.2 FutureGen 2.0 Project

As the estimated capital costs of the original FutureGen Project escalated and came to exceed \$2 billion, DOE decided in 2010 that the project as then envisioned was too expensive in a budget-constrained environment. Seeking a fiscally responsible approach to achieving the important technical objectives of advanced clean coal technologies and carbon capture and storage as described in President George W. Bush's FutureGen Initiative, and recognizing that a number of projects involving IGCC technology and the coal-to-hydrogen concept had been announced, DOE elected to shift from the construction and operation of a new IGCC power plant to repowering an existing coal-fueled power plant.

Retrofitting opportunities that would allow for the capture of CO₂ consisted of oxy-combustion projects and post-combustion scrubbing projects. Oxy-combustion burns coal with a mixture of oxygen and CO₂ instead of ambient air to produce a concentrated CO₂ stream, which facilitates CO₂ injection and permanent storage underground. Because DOE already had post-combustion scrubbing projects in its research and demonstration portfolio, it decided to pursue an oxy-combustion retrofitting project with CO₂ storage at the Mattoon, Illinois, site that had been selected for the original FutureGen Project. FutureGen 2.0 would still meet the objective of the FutureGen Initiative to establish the feasibility and

viability of producing electricity from coal with at least 90 percent CO₂ capture **during steady-state operation** and near-zero emissions.

On August 5, 2010, DOE announced the award of \$1 billion in American Recovery and Reinvestment Act funding to the Alliance, Ameren, Babcock & Wilcox, and Air Liquide to build FutureGen 2.0, an oxy-combustion repowering and CO₂ storage project. DOE stated that the project partners would repower Unit 4 at Ameren's Meredosia, Illinois energy center with oxy-combustion technology and would construct a 150-mile pipeline from Meredosia to Mattoon that would transport more than 1.1 million tons (1 million metric tons) of captured CO₂ per year. The Mattoon site would also be used to conduct research pertaining to site characterization, injection and storage, and monitoring and measurement.

The Mattoon sequestration site proponent, however, decided that the pursuit of FutureGen 2.0 was not in its best interest, stating that the restructured project did not provide the highest and best use of the Mattoon site. With Mattoon no longer available as the CO₂ storage site, the Alliance developed and implemented another competitive process to identify a CO₂ storage site in Illinois.

Under the terms of a cooperative agreement signed in 2010 with DOE, the Alliance undertook a siting process as described in Chapter 2, Proposed Action and Alternatives (Section 2.5.2.1). Following the issuance of Guidance to Prospective Offerors on October 6, 2010, the Alliance prepared and released a Request for Proposals on October 25, 2010. The Request for Proposal described the surface and subsurface qualifying, scoring, and best value criteria that the Alliance would use to site the FutureGen 2.0 CO₂ injection wells and the data that site offerors needed to provide. On November 15, 2010, six bidders submitted proposals.

After careful review of the proposals and other available data, including data from the Illinois State Geologic Survey, on February 28, 2011, the Alliance announced its selection of Morgan County as the preferred location for the FutureGen 2.0 CO₂ injection wells, visitor center, and research and training facilities. At that time, the Alliance identified sites in Christian County and Douglas County as alternate locations should concerns arise around the technical, legal, or public acceptability of the preferred Morgan County site.

Throughout 2011 and 2012, the Alliance conducted a detailed geological stratigraphic analysis at the Morgan County storage location to characterize and verify the viability of the proposed CO₂ storage reservoir. The geological findings have proved the location to be favorably suited for CO₂ injection and sequestration as part of the FutureGen 2.0 Project. As a result of this geological analysis combined with a cost analysis of the pipelines to the alternative sites, on June 19, 2012, the Alliance Board of Directors confirmed that the proposed Morgan County site remained its preferred site and voted to direct the Alliance to no longer pursue the sites in Christian County and Douglas County as alternate sites. The Alliance notified the proponents of those sites that the Alliance would no longer be considering them as alternate sites and would not be constructing or operating a CO₂ storage reservoir at those sites, releasing the site proponents to find other reasonable uses for their proposed sites.

Since the initial announcement of the FutureGen 2.0 Project in 2010, Ameren decided, for economic reasons, to suspend operations at the Meredosia Energy Center at the end of 2011 (see Section 2.4.1.5) and to reduce its role in FutureGen 2.0. With DOE's concurrence, the Alliance agreed to acquire those portions and components of the Meredosia Energy Center that are needed for FutureGen 2.0 and to undertake the repowering of Unit 4 with oxy-combustion technology by Babcock & Wilcox and Air Liquide. Thus, the Alliance would be responsible for both the Oxy-Combustion Large Scale Test and the CO₂ Pipeline and Storage Reservoir components of the FutureGen 2.0 Project. Ameren has continued to assist with environmental permitting and maintaining the energy center to be in a retrofit-ready condition.

1.3 PROPOSED ACTION

DOE proposes to fund the final design, construction, and initial operation of the FutureGen 2.0 Project to implement the 2003 FutureGen Initiative. DOE announced \$1 billion in funding under the American

Recovery and Reinvestment Act of 2009 (Public Law No. 111-5) for the project through four cost-share phases:

- *Phase I: Project Definition*
- *Phase II: NEPA, Permitting, and Preliminary/Final Design*
- *Phase III: Construction and Commissioning*
- *Phase IV: Operations*

Although not part of DOE's proposed action, after completion of DOE's participation, there **is expected** to be two commercial phases:

- *Phase C-1: Commercial Operations*
- *Phase C-2: Post-Operations Monitoring*

DOE has authorized the expenditure of funds for Phase I (project definition) and much of Phase II (through front-end engineering design), with cost-sharing by the private partners. DOE proposes to fund the remainder of Phase II (final design) and Phases III (construction and commissioning) and IV (operations) of the FutureGen 2.0 Project through cooperative agreements with the Alliance to support the implementation of project components that, if successful, would advance the goals of the FutureGen Initiative. This EIS addresses the environmental impacts of continuing to fund FutureGen 2.0, also cost-shared by the private partners, and the impacts of continuing commercial operations and post-operations monitoring after DOE's participation ends. The project components, consisting of the Oxy-Combustion Large Scale Test and the CO₂ Pipeline and Storage Reservoir, would provide critical performance and emissions data, as well as establish operating, permitting, maintenance, and other experience needed for future commercial deployment of these technologies.

Objectives of FutureGen 2.0 Phases

Phase I: Project Definition – Select a site for the CO₂ storage facility, obtain site purchase options, complete a conceptual design and cost estimate for the project, initiate the NEPA process, and execute a Cooperation and Technology Agreement between FutureGen Industrial Alliance and Ameren Energy Resources.

Phase II: NEPA, Permitting, and Preliminary/Final Design – Complete environmental permitting and the NEPA process; obtain commitments on properties needed for the pipeline and injection well site(s); complete front-end engineering and design and final design and cost estimates; prepare a monitoring, verification, and accounting plan; and execute the power purchase agreement and other appropriate agreements for facilities operation.

Phase III: Construction and Commissioning – Construct the pipeline, the surface and subsurface facilities at the injection well site(s), and the visitor, research, and training facilities, and commission the system.

Phase IV: Operations – Commence operation of the pipeline and storage facility systems to transport and store CO₂, and to test technologies and protocols for CO₂ monitoring necessary to establish the permanence of storage and provide a full accounting for all captured CO₂.

For the Oxy-Combustion Large Scale Test, the Alliance would acquire portions of the Meredosia Energy Center (formerly named the Meredosia Power Station) in west central Illinois from Ameren and incorporate advanced oxy-combustion technology into the reconstruction of Unit 4 at the existing plant. Ameren originally entered into a cooperative agreement with DOE to implement the Oxy-Combustion Large Scale Test, but the company discontinued operations at the Meredosia Energy Center at the end of 2011 and informed DOE that it would not continue with its cooperative agreement. Subsequently, DOE authorized the Alliance to assume responsibility for Ameren's cooperative agreement. The scope of the Oxy-Combustion Large Scale Test consists of final design, procurement, manufacture, installation, startup, testing and operation of an integrated oxy-combustion coal boiler with CO₂ capture, purification, and compression. The plant would be designed to generate approximately 168 megawatts electrical

(MWe) gross, and it would operate continuously to generate baseload electric power. The CO₂ would be cleaned, compressed for transport, and delivered to a pipeline for transport to the CO₂ injection wells.

For the CO₂ Pipeline and Storage Reservoir, the Alliance would design, construct, and operate a CO₂ transmission pipeline and a geologic injection and storage facility. The pipeline would transport CO₂ from the Meredosia Energy Center to the injection wells in Morgan County where it would be injected through deep wells into the Mt. Simon Formation, which is the major deep saline formation in the Illinois Basin. The injection wells would be located approximately 30 miles east of the Meredosia Energy Center. The pipeline and storage reservoir would be designed to store up to 24 million tons (22 million metric tons) over an approximately 20-year operating period. Research would include site characterization, injection and storage, and CO₂ monitoring and measurement.

The FutureGen 2.0 Project would begin final design in 2013 after completion of the NEPA process. Construction would begin in 2014, with commissioning in 2017. Operations and monitoring would continue until 2022 (56 months after commissioning) with DOE funding. Performance and economic test results would be shared among all participants, industry, non-governmental organizations, and the public. After DOE's involvement ceases, the FutureGen 2.0 Project would be expected to continue commercial operations, including carbon capture and storage, for approximately 20 years, and the Alliance (or its successor) would be financially responsible for post-injection monitoring of the underground CO₂ for up to 50 years.

1.4 PURPOSE AND NEED FOR AGENCY ACTION

According to the Energy Information Administration, coal is an abundant and indigenous energy resource and in 2010 supplied 45 percent of electric power in the U.S. Electricity is vital to the nation's economy and global competitiveness with demand for electricity projected to increase by 22 percent from 2010 to 2035. Based on its analyses, the Energy Information Administration concludes that this power increase can only be achieved if coal use is also increased (EIA 2012).

In addition, nearly half of the nation's electric power generating infrastructure is more than 30 years old, with a significant portion of this infrastructure having been in service for 60 years or more (EIA 2009). These aging facilities are (or soon will be) in need of substantial refurbishment or replacement. Additional capacity must also be put in-service to keep pace with the nation's ever-growing demand for electricity. Therefore, nearly 40 percent of the nation's electricity needs will continue to be served by coal for at least the next several decades (EIA 2012).

However, there is also a need to address the associated environmental and climate change challenges related to the continued use of coal. The Intergovernmental Panel on Climate Change has concluded that global atmospheric concentrations of CO₂ have increased 39 percent since the pre-industrial period, and that the primary source of the increase results from the consumption of fossil fuels (IPCC 2007; IPCC 2011). In addition, in 2009 the U.S. Environmental Protection Agency (USEPA) found that GHGs endanger both the public health and welfare through their contribution to climate change. Subsequently, on **September 20, 2013**, the USEPA announced a proposed rule that would set CO₂ emissions limits on new fossil fuel-fired generating units. Such rulemaking would significantly affect the future development of coal-based power generation systems unless methods to reduce CO₂ emissions, like the approach included in the proposed action, are successfully demonstrated and adopted.

Given the heightened awareness of environmental stewardship, while at the same time meeting the demand for a reliable and cost-effective electric power supply, it is in the public interest for the nation's energy infrastructure to be upgraded with the latest and most advanced commercially viable technologies to achieve improved efficiencies, environmental performance, and cost-competitiveness. To realize acceptance and replication of these advanced technologies into the electric power generation sector, the technologies need to be demonstrated first (i.e., designed and constructed to industrial standards and operated at significant scale under industrial conditions).

Thus, agency action is needed to demonstrate advanced technologies to meet the nation's energy needs with an abundant natural resource and reduce the nation's output of GHG emissions to improve the global environment. Implementation of FutureGen 2.0 would support the objectives of the FutureGen Initiative to establish the feasibility and viability of producing electricity from coal with at least 90 percent CO₂ capture **during steady-state operation** and near-zero emissions of other pollutants.

One of DOE's primary strategic goals is to protect our national and economic security by promoting a diverse supply and delivery of reliable, affordable, and environmentally sound energy. DOE's proposed action contributes to this strategic goal through cutting-edge research and development focused on clean energy production and use of the nation's domestic fossil energy resources. The principal need addressed by DOE's proposed action includes the collection and evaluation of data only available from the experience of actually designing, permitting, operating, and maintaining an industrial-scale oxy-combustion repowering project with CO₂ capture, transport, and geologic storage.

Studies by DOE's National Energy Technology Laboratory (NETL) have identified oxy-combustion technology as a potentially cost-effective approach to implementing carbon capture at existing coal-fueled facilities, including a large cross-section of the world's existing pulverized coal plants (NETL 2008, NETL 2013a, Farzan 2011). It also has the potential for use in new power plants. Because oxy-combustion technology is inherently scalable, it is possible to demonstrate the technology at a relatively small commercial-scale such as the project proposed for the Meredosia Energy Center (168 MWe), and then replicate it at larger-scale (e.g., 500+ MWe) power plants. The ability to demonstrate the technology at a smaller but commercially-relevant scale has substantial cost-saving benefits.

A successful project would generate technical, environmental, and financial data from the design, construction, and operation of the integrated electric generation, pipeline, and injection facilities to confirm that oxy-combustion technology with CO₂ capture and permanent underground storage can be implemented at a commercial scale. The cost-shared financial assistance from DOE would reduce the risk to the Alliance in demonstrating the technology at the level of maturity needed for decisions on commercialization.

1.5 NATIONAL ENVIRONMENTAL POLICY ACT

1.5.1 DOE Responsibilities

NEPA requires all federal agencies to include, in every recommendation or report on proposals for major federal actions that may significantly affect the quality of the human environment, a detailed statement describing: (1) the potential environmental impacts of the proposed project; (2) any adverse environmental effects that cannot be avoided should the proposal be implemented; (3) alternatives to the proposed project, including the alternative of taking no action; (4) the relationship between local short-term uses of the environment and the maintenance and enhancement of long-term productivity; and (5) any irreversible and irretrievable commitments of resources that would be involved in the proposed project should it be implemented. NEPA also requires consultations with agencies that have jurisdiction or special expertise with respect to any environmental impact involved, and that the detailed statement along with the comments and views of consulted governmental agencies be made available to the public (42 USC 4332).

In compliance with NEPA, DOE prepared this EIS for FutureGen 2.0 to inform its decisions regarding whether to provide financial assistance for project activities beyond preliminary design (including detailed design, construction, and operation of the proposed facilities). DOE's policy is to comply fully with the letter and spirit of NEPA, giving early consideration to environmental values and factors in federal planning and decision-making. This EIS evaluates the environmental impacts of alternatives and facilitates public participation. DOE's actions with regard to any proposal, including financial awards, are limited prior to completion of the NEPA process (i.e., in accordance with 40 CFR 1506.1(a)). DOE will

not provide funds for project activities that could either have an adverse impact on the environment or limit the choice of reasonable alternatives before the NEPA process is completed.

DOE determined that providing financial assistance to FutureGen 2.0 would constitute a major federal action that may significantly affect the quality of the human environment. Therefore, DOE has prepared this EIS to assess the potential impacts on the human environment of the proposed project and reasonable alternatives. DOE has used information provided by the Alliance and Ameren, as well as information provided by state and federal agencies, subject matter experts, and others. This EIS has been prepared in accordance with Section 102(2)(C) of NEPA, as implemented under regulations promulgated by CEQ (40 CFR 1500 through 1508) and as provided in DOE regulations for compliance with NEPA (10 CFR 1021).

Figure 1-1 illustrates the steps involved in the EIS process. To formally initiate the NEPA process for FutureGen 2.0, DOE published an NOI to prepare an EIS in the FR on May 23, 2011, under Docket ID No. FR Doc. 2010–12632 (76 FR 29728). After issuing the NOI, DOE conducted a thorough scoping process that included three public scoping meetings and consultation with various interested governmental agencies and stakeholders. Information related to the public scoping meetings is described below in this section and Section 1.6 and included in Appendix A, Public Scoping, and consultation-related correspondence is provided in Appendix B, Consultation Letters. DOE used the results of the scoping efforts to define the scope and areas of emphasis (or focus) of this EIS.

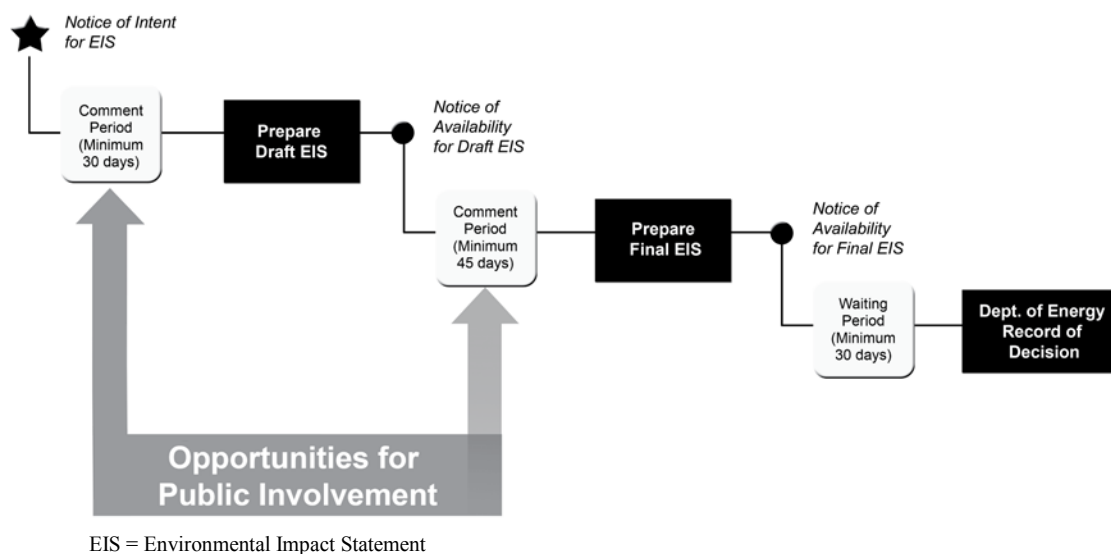

Figure 1-1. Steps in the NEPA Process

1.5.2 NEPA Scoping Process

DOE determined the scope of this EIS based on internal planning and analysis, consultation with federal and state agencies, and involvement of the public. During the public scoping period, DOE solicited public input to ensure that: (1) significant issues were identified early and properly analyzed; (2) issues of minimal significance would not consume excessive time and effort; and (3) the EIS would be in accordance with applicable regulations and guidance.

DOE held public scoping meetings on the dates indicated at the following locations:

- June 7, 2011 at Taylorville High School, Taylorville, Illinois
- June 8, 2011 at Ironhorse Golf Club, Tuscola, Illinois
- June 9, 2011 at Elks Lodge, Jacksonville, Illinois

The meeting locations were selected to provide appropriate geographic coverage and reasonable accessibility for stakeholders affected by actions associated with the Meredosia Energy Center site, potential pipelines, and the initial alternative CO₂ injection and geologic storage areas. DOE announced the meeting locations and times in its NOI published in the FR on May 23, 2011, and also published announcements in the following local newspapers on the dates indicated:

- *Journal-Courier*; Jacksonville; May 22, 29; June 1, 5
- *State Journal-Register*; Springfield; May 22; June 5
- *Breeze-Courier*; Taylorville; May 23; June 3, 5
- *Herald & Review*; Decatur; June 1, 5
- *Daily Union*; Shelbyville; May 31; June 4
- *News-Progress*; Sullivan; May 25; June 1
- *Tri-County Journal*; Tuscola; May 26; June 2
- *Tuscola Journal*; Tuscola; May 25; June 1
- *Record-Herald*; Arcola; May 26; June 2
- *Journal-Gazette / Times-Courier*; Mattoon / Charleston; June 1, 4

Each scoping meeting began with an informal open house from 5:00 p.m. to 7:00 p.m. During this time, attendees were able to view project-related posters, handouts, and a video; and to ask questions of DOE, Alliance, and Ameren representatives. The formal scoping meeting at each location began at 7:00 p.m. and included presentations by DOE, the Alliance, and Ameren, followed by an opportunity for public comments. The presentations and comments were transcribed by a court reporter at each meeting location. The public scoping period ended on June 22, 2011, after a 30-day comment period. During the comment period, DOE accepted comments by telephone, facsimile, U.S. mail, and email. DOE announced in the NOI that it would consider late comments to the extent practicable. Appendix A, Public Scoping, provides additional information on the NEPA public scoping process for this project.

1.6 SCOPE OF THE ENVIRONMENTAL IMPACT STATEMENT

1.6.1 Issues Identified Prior to the Scoping Process

DOE initially identified the environmental resource areas and issues listed below for consideration in the EIS. These resource areas were identified in early planning efforts and listed in the NOI. This list was neither intended to be all-inclusive, nor a predetermined set of resources to be assessed for potential environmental impacts. Resource areas and issues initially identified by DOE include:

- Air quality – potential impacts from emissions during construction and operation of FutureGen 2.0 on local or regional air quality;
- Climate change – potential impacts from emissions of CO₂ and other GHG emissions;
- Geology – potential impacts from the injection and storage of CO₂ on underground resources such as groundwater supplies, mineral resources, and fossil fuel resources, and the fate and stability of CO₂ being stored;
- Water resources – potential impacts from water utilization, consumption, and wastewater discharges, as well as potential impacts during construction, including stream crossings for linear features;

- Floodplains and wetlands – potential wetland and floodplain impacts from construction and operation of project facilities;
- Biological resources – potential impacts to vegetation, wildlife, threatened or endangered species, and ecologically sensitive habitats;
- Historic and cultural resources – potential impacts related to site development and the associated linear facilities (e.g., pipelines);
- Infrastructure and land use – potential impacts associated with delivery of feed materials and distribution of products (e.g., access roads, pipelines), and compatibility with adjacent land uses;
- Visual resources – potential impacts to the viewshed, scenic views (e.g., impacts from the injection wells, pipeline, and support facilities for the injection wells and pipeline), and perception of the community or locality;
- Solid wastes – pollution prevention and waste management issues (e.g., generation, treatment, transport, storage, disposal or reuse), including potential impacts from the generation, treatment, storage, and management of hazardous materials and other solid wastes;
- Traffic – potential impacts from the construction and operation of the facilities, including changes in local traffic patterns, deterioration of roads, traffic hazards, and traffic controls;
- Noise and light – potential disturbance impacts from construction, transportation of materials, and facility operations;
- Health and safety issues – potential impacts associated with use, transport, and storage of hazardous chemicals, as well as CO₂ capture and transport to the injection wells and risks of leakage;
- Socioeconomics – potential impacts to schools, housing, public services, and local revenues, including the creation of jobs;
- Environmental justice – potential for disproportionately high and adverse impacts on minority or low-income populations;
- Connected actions – potential impacts from the integrated operations of the oxy-combustion project and sequestration project, as well as potential development of support facilities or supporting infrastructure;
- Cumulative effects that could result from the incremental impacts of the proposed project when added to other past, present, and reasonably foreseeable future actions; and
- Regulatory and environmental permitting requirements and environmental monitoring plans associated with the carbon capture facility and CO₂ geologic storage activities.

1.6.2 Comments Received and Issues Identified During the Scoping Process

Scoping comments were received with respect to specific natural and human environmental resources. Comments were expressed orally by individuals attending the scoping meeting; others were received on comment forms provided at the meeting, as well as by letter or email.

In general, the majority of respondents expressed various concerns, with a primary emphasis on potential impacts to farmers and farmland (e.g., loss of farmland or impacts to soil). Other concerns not directly related to a specific environmental resource included: issues with the experimental nature of the project; a lack of confidence that economic benefits would occur; concerns about the use of public funds for a private endeavor; belief that DOE funding should go toward renewable and alternative energy technologies aside from coal; and concerns about potential increased electricity costs for consumers. In

terms of environmental resource-specific concerns, the majority of comments were related to socioeconomics and carbon capture and storage, with a general belief that this technology ultimately contaminates the land instead of the air. The majority of natural resource topics were addressed in terms of impacts to farmlands; issues strictly related to natural resources tended to be general in nature (e.g., potential impacts to surface waters should be addressed). Additionally, two petitions in opposition to the project, signed by a total of about 340 residents and landowners in Morgan County, and one petition signed by 55 residents and landowners in Douglas County, were submitted to DOE.

Of the commentors that responded favorably for the project, many commented positively primarily due to economic and job creation benefits for the community, as well as benefits in terms of self-sufficient national energy production.

Following the intent of NEPA, DOE uses the scoping process to focus the analysis of issues and impacts in the EIS. Rather than providing responses to specific comments received during scoping, DOE endeavors to ensure that the EIS addresses and analyzes issues and potential environmental impacts appropriately based on commentor concerns. Table 1-1 provides a summary of the scoping comments received, organized by comment category or applicable resource area, and it identifies the appropriate sections in the EIS where the respective issues are addressed. The subjects and issues raised in specific comments are summarized in more detail in Table 3 of Appendix A, Public Scoping.

DOE has addressed all substantive scoping comments in this EIS. However, some comments received are outside the scope of this EIS. For example, several respondents indicated that the EIS should include alternatives such as the utilization of renewable energy resources (e.g., wind and solar power). Because the particular goal of the FutureGen Initiative is to demonstrate an advanced power generation facility based on fossil fuels, specifically coal, technologies that would not be based on coal use are not within the scope of this EIS. However, DOE oversees numerous programs that are investigating and supporting a wide variety of energy generation technologies, including many based on renewable sources, as well as programs that promote energy conservation.

Several comments were received relating to the environmental and safety impacts of coal mining. Coal is a commercial fuel produced by a regulated industry. The FutureGen 2.0 Project would obtain coal as a commodity fuel source from existing mines. No specific mine has been identified as a source of coal, and no new mines would be developed specifically to support the project. Furthermore, the FutureGen 2.0 Project does not aim to change mining techniques, and DOE has no decisions that would affect coal mining techniques for the proposed project. It is assumed that the coal intended for the project would be used as a feedstock for another facility in the event that the FutureGen 2.0 Project were not constructed, because coal is an abundant fuel source in the United States. The FutureGen 2.0 Project would not change nationwide coal production and, therefore, would not change the environmental impacts of mining, which are generally well known and well described. Hence, DOE considers the environmental impacts of coal mining policies and operations to be outside the scope of this EIS.

A few commentors requested detailed cost information about the project, including a life-cycle cost analysis. Among the purposes for DOE's involvement in the FutureGen 2.0 Project are the demonstration of the technologies involved, the identification of potential efficiencies, and the development of a reference base for the costs associated with oxy-combustion facilities and CO₂ capture and storage. Thus, the life cycle cost of the project relative to other technologies is not currently known with certainty, but it is not relevant in DOE's decision-making process for the proposed action.

Table 1-1. Summary of Scoping Comments

Subject	Representative Issues and Concerns	Number of Comments	Relevant Sections of EIS
Purpose and Need	Federal funding for project; preference for DOE to invest in alternative energy projects other than coal, which would also create jobs; cost-competitiveness of oxy-combustion system.	3	1.4; 1.6.2; 2.3
Alternatives	Number and location of injection wells; preference for alternatives to include energy efficiency and renewable energy projects; preference for use of saline formations in less inhabited areas with less risk to farmland.	5	1.2; 1.6.2; 2.3; 2.5.2
Air Quality	Pollutant emissions; comparison to conventional coal burning plant; effects of unexpected shutdowns or outages and restarts.	2	3.1
Greenhouse Gases	GHG emissions; comparison to conventional coal burning plant.	1	3.2
Physiographic and Soils	Potential loss of productive farmland; impacts to soils due to CO ₂ sequestration.	2	3.3
Geology (Coal Mining)	Coal mining impacts to water resources, biological resources, farming, and farmland subsidence.	6	1.6.2; 3.4
Geology (General)	Extent of required subsurface pore-space; fate and movement of injected CO ₂ ; transport of other subsurface gases or brine water; impact of CO ₂ injection pressures; methods for discovering and remediating CO ₂ leaks; number and extent of monitoring wells; adequacy of the depth of Mt. Simon Formation at Morgan County site; implications on sequestration given proximity to New Madrid Fault; structural impacts to nearby buildings.	18	3.4
Groundwater	Impact of sequestration on groundwater quality.	1	3.5
Surface Water	Concerns for nearby creeks and streams; potential effect on species in and along Indian Creek.	2	3.6
Biological Resources	Impact of transport and sequestration of CO ₂ to subsurface microbes; insects, and molds; potential effect on species in and along Indian Creek.	3	3.8
Land Use	Property values and land use effects to neighboring properties.	1	3.10
Materials and Waste	Impacts of coal ash disposal; value and treatment of plant-generated by-products; impacts to disposal sites for all waste streams.	4	3.12
Transportation and Traffic	Concern that condition of existing road leading to Morgan County injection well site(s) cannot handle additional traffic.	1	3.13
Utilities	Impacts of water usage by project; concerns over increase in energy costs in region.	2	3.15

Table 1-1. Summary of Scoping Comments

Subject	Representative Issues and Concerns	Number of Comments	Relevant Sections of EIS
Socioeconomics and Community Services	Lack of infrastructure and funds in regional area to respond to potential accidents in Morgan County; accuracy of estimated number of employees; questions of whether project would generate investments and employment to Morgan County; concerns about foreign investors; impacts from disruption or displacement of farmers and farming activities; impacts to value of Prime Farmland; compensation to farmers; concerns over increase in energy costs in region.	12	3.16; 3.18
Human Health and Safety	Components and toxicity of sequestered CO ₂ stream; consequences of and precautions taken if accidental CO ₂ release at the injection well site(s); safety concerns for future generations after 20-year life of project.	6	3.17
General Topics	Request for complete energy cost of project (including coal hauling); request for life-cycle cost analysis of project; regulation implications; liability insurance implications.	3	1.6.2

CO₂ = carbon dioxide; DOE = U.S. Department of Energy; EIS = Environmental Impact Statement; GHG = greenhouse gas

1.6.3 Comments Received on the Draft EIS

1.6.3.1 Public Hearing and Comment Period

DOE announced the availability of the FutureGen 2.0 Draft EIS in a Notice of Availability (NOA) published in the *Federal Register* on May 3, 2013 (78 FR 26004), which provided the website to access the Draft EIS online, the location and timing of the public hearing, and the various methods for submitting comments (see Appendix I, Public Comments on the Draft EIS, for a copy of the NOA). On the same date, the USEPA published its NOA for the Draft EIS (78 FR 26027), which initiated the 45-day public comment period (from May 3 to June 17, 2013).

On May 21, 2013, DOE held a public hearing on the Draft EIS for the FutureGen 2.0 Project at the Jacksonville High School, 1211 N. Diamond Street, Jacksonville, Illinois. An informational session was held from 5:00 p.m. to 6:00 p.m., followed by the formal presentations and comment period from 6:00 p.m. to approximately 8:00 p.m. Appendix I, Public Comments on the Draft EIS, provides a summary of the public hearing and commenting period.

DOE posted notices in three area newspapers (Jacksonville *Journal-Courier*, Springfield *State Journal-Register*, and Illinois *Farm Week*) during the three weeks prior to the public hearing that announced the hearing date, time, location, and purpose. The same information was also provided in notification letters sent on April 26, 2013, to interested parties, elected officials, federal and state agencies, and non-governmental organizations using the distribution list in Chapter 8 of the Draft EIS. DOE distributed notifications including 147 letters each with a hardcopy of the Draft EIS, 164 notification letters alone, and 180 notifications by email.

A total of 46 people signed the attendance sheets for the public hearing, and seven individuals signed up to give oral comments. During the informational session, the public was invited to view various displays about the NEPA process and the FutureGen 2.0 Project and to talk with DOE and Alliance representatives. During the formal hearing, presentations were made by the DOE NEPA Document Manager and the Alliance's Chief Executive, and the floor was opened for public comments. A court reporter recorded the formal presentations and oral comments as documented in the transcript included in Appendix I, Public Comments on the Draft EIS.

DOE received comments from two federal agencies, two state agencies, one local elected official, four non-governmental or public-private organizations, and seven members of the public during the official 45-day comment period, including the oral comments at the hearing. The comments are catalogued in Appendix I, Public Comments on the Draft EIS, according to the specific comments by each respective commenter along with DOE's response to each comment. In aggregate, a total of 116 comments were received in 19 separate submissions from 16 individuals (1 member of the public spoke at the hearing and also submitted 3 sets of written comments).

1.6.3.2 Summary of Comments on the Draft EIS

The largest proportion of comments related to the adequacy of information provided about the project and potential impacts. The majority of resource-specific comments focused on socioeconomic issues, geology, and climate and GHG emissions. Another substantial group of comments was distributed relatively evenly among concerns about health and safety, biological resources, NEPA requirements, and air quality. The remaining group of comments was distributed among other subject areas: alternatives, land use, purpose and need, cumulative impacts, environmental justice, regulatory issues, surface water, wetlands, groundwater, physiography and soils, and utilities. The categories and principal issues expressed in the comments are summarized below based on the full text of all comments included in Appendix I, Public Comments on the Draft EIS.

Comments about the adequacy of information in the Draft EIS expressed dissatisfaction with the level of detail provided about the project and engineering features, alleged that the Alliance withheld or provided inconsistent information, questioned the Alliance's qualifications to complete the project, claimed that the Draft EIS did not provide adequate information about financial assurances and monitoring for the geologic CO₂ storage component, or alleged other deficiencies in project information.

Several comments on socioeconomic issues expressed support for the project based on the potential for economic stimulus and other benefits. Other socioeconomic comments expressed concerns about potential cost overruns and the adverse impacts on taxpayers and ratepayers. Additional comments questioned whether the project would be justified by a full cost-benefit analysis, expressed concerns about economic risks, or questioned whether economic benefits would be realized.

Geology-related comments expressed concerns about whether selection of the CO₂ storage area was justified, whether the geologic storage formation could adequately support the project, whether the caprock formation could withstand the chemical effects of CO₂ injection, and similar issues.

Comments on climate and GHGs included some that questioned whether the project would in fact reduce GHG emissions, questioned the validity of climate change, or expressed concerns about other GHG issues. Other comments expressed support for the project based on potential reductions in emissions from fossil fuel combustion.

The balance of comments addressed other subjects, including potential health and safety risks associated with leakage from the CO₂ storage formation or the pipeline, mitigation for potential biological resource impacts, concerns about DOE's implementation of NEPA, claims that the purpose and need or consideration of alternatives were not adequately addressed, or concerns about potential impacts on other resources.

In preparing the Final EIS, DOE fully considered all comments both individually and cumulatively, including comments received after the closing date. DOE also updated the EIS to reflect: (a) project design changes, (b) studies not yet completed in time to be included in the Draft EIS, and (c) recent regulatory developments.

1.6.4 Decision to be Made by DOE

This EIS identifies and analyzes the potential impacts of the FutureGen 2.0 Project at the Meredosia Energy Center, the proposed CO₂ pipeline, the injection wells, and the educational facilities in Morgan County. Evaluations of potential impacts included in this EIS are intended to support the federal decision whether to provide cost-shared funding to the Alliance for final design, construction, and operation of the Oxy-Combustion Large Scale Test and for the CO₂ Pipeline and Storage Reservoir. If DOE decides to fund these subsequent phases of the FutureGen 2.0 Project, DOE would specify measures to mitigate potential adverse impacts. The Alliance would be required to implement the measures identified through the NEPA process in order to continue receiving DOE funds. In the absence of DOE cost-shared funding (the no action alternative), it is unlikely that the FutureGen 2.0 Project would proceed. Thus, for purposes of analysis in this EIS, the no action alternative is defined as a “no-build” scenario.

No sooner than 30 days after the USEPA publication of a NOA of the Final EIS in the FR, DOE will announce in a ROD the selection of either the proposed action or the no action alternative. Should the proposed action be selected in the ROD, the Alliance would make the additional engineering design decisions to ensure compliance with any required conditions contained in the ROD.

1.7 ORGANIZATION AND CONTENTS OF THE EIS

The balance of this EIS is organized into the following chapters with associated contents:

Chapter 2 describes the DOE proposed action and no action alternative, and alternatives that DOE considered but determined not to be reasonable. The chapter also describes the activities, including measures to mitigate potential adverse impacts, to be undertaken by the Alliance for the Oxy-Combustion Large Scale Test and the CO₂ Pipeline and Storage Reservoir. The chapter provides information on the locations of proposed project components; the technologies involved; and resource requirements, process outputs, and construction and operation plans.

Chapter 3, Affected Environment and Impacts, describes the baseline conditions in the region and the potential impacts of the DOE proposed action and the no action alternative for 19 subjects that encompass the full range of resources in the physical, natural, and human environment. Each section describes the region of influence (ROI) of project activities, the method of analysis, and the potential impacts of project construction and operation. Also, as appropriate for each resource, the chapter describes means of reducing impacts.

Chapter 4, Summary of Environmental Consequences, summarizes the potential adverse impacts of the FutureGen 2.0 Project and provides additional information about environmental effects, including measures to mitigate adverse impacts, potential cumulative impacts, and other subjects required by NEPA and CEQ regulations.

The final chapters provide the regulatory and permit requirements (Chapter 5), technical references (Chapter 6), consultations undertaken (Chapter 7), the distribution list for the **Final** EIS (Chapter 8), a list of EIS preparers (Chapter 9), and a glossary (Chapter 10).

INTENTIONALLY LEFT BLANK

2 PROPOSED ACTION AND ALTERNATIVES

This chapter describes DOE’s proposed action and other alternatives considered by the agency. Section 2.1 provides an overview of DOE’s proposed action with details of the FutureGen 2.0 Project components being presented in Sections 2.4 and 2.5. These sections describe the resource requirements; process outputs; and construction, operation, and decommissioning plans associated with the FutureGen 2.0 Project. Section 2.2 describes the no action alternative as required by NEPA and applicable CEQ and DOE regulations. A comparison of potential environmental impacts for each alternative is presented in the Summary (Table S-4) and in Chapter 4, Summary of Environmental Consequences (Table 4.1-1). Section 2.3 discusses other alternatives that were considered but dismissed from further evaluation and the reasons for their dismissal.

DOE developed the range of reasonable alternatives for the FutureGen 2.0 Project based on the following:

- Evaluation of various clean coal technologies reviewed through the Clean Coal Power Initiative (CCPI) Program;
- Data obtained and reviewed through various funding opportunity announcements;
- Analysis of the original FutureGen Project in terms of technology, costs, and suitability for geologic storage; and
- Interest of industries to participate in projects to support FutureGen 2.0.

2.1 DOE PROPOSED ACTION

DOE proposes to provide approximately \$1 billion of financial assistance to the Alliance for the FutureGen 2.0 Project. The financial assistance would support final design (Phase II), construction and commissioning (Phase III), and operations (Phase IV). The FutureGen 2.0 Project consists of two major components: the Oxy-Combustion Large Scale Test and the CO₂ Pipeline and Storage Reservoir (see Figure 2-1). These components are summarized in this section and described in detail in Sections 2.4 and 2.5 respectively.

For the Oxy-Combustion Large Scale Test, the Alliance would acquire portions of the Meredosia Energy Center in west central Illinois from Ameren and incorporate advanced oxy-combustion technology into the reconstruction of an idle electric generating unit (Unit 4). Through the use of the existing Meredosia Energy Center, the oxy-combustion component of the FutureGen 2.0 Project would be constructed on a brownfield site (i.e., a previously developed site), which would enable the project to move forward with less expense and fewer environmental impacts than would occur if the project were to be constructed on a greenfield site (i.e., an undeveloped site). The scope of the Oxy-Combustion Large Scale Test consists of final design, procurement, manufacture, installation, startup, testing, and operation of the proposed integrated oxy-combustion coal boiler. A coal boiler is a vessel that is used to generate heat through the combustion of coal in order to produce steam that can then be put to productive use (i.e., the generation of electricity). The term “oxy-combustion” refers to the use of manufactured oxygen in the coal combustion process. The proposed oxy-combustion technology would include CO₂ capture, purification, and compression equipment. The reconstructed electric generating unit would be designed to generate approximately 168 MWe (gross output). The CO₂ captured from the oxy-combustion facility would be cleaned, compressed for transport, and delivered to a pipeline for transport to the CO₂ Storage Reservoir.

FutureGen 2.0 Project Features

Oxy-Combustion Large Scale Test – Construction and operation of an integrated oxy-combustion coal boiler with CO₂ capture, purification, and compression.

CO₂ Pipeline – Construction and operation of approximately 30 miles of pipeline to transport CO₂ from the Meredosia Energy Center to a storage reservoir in Morgan County.

Storage Reservoir – Construction and operation of surface facilities, and injection and permanent storage of captured CO₂ into a deep geologic formation.

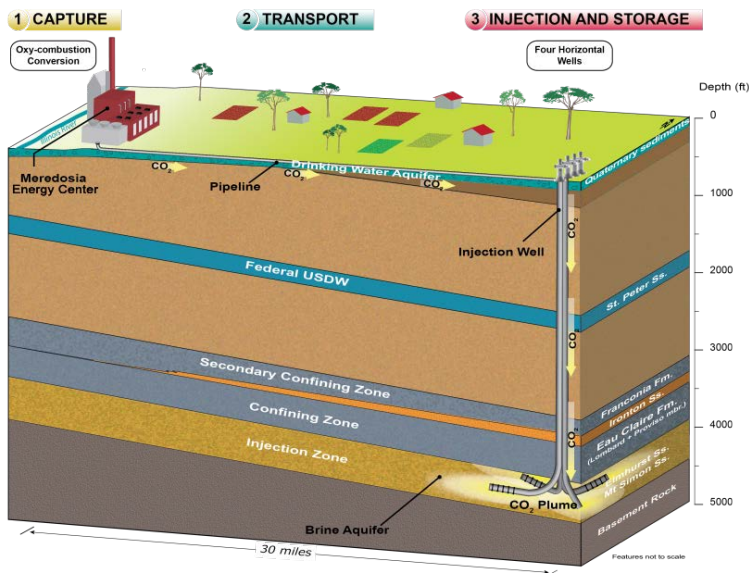

Evolving Project Design

It is important to recognize that the FutureGen 2.0 Project has evolved since it was initially developed in 2011 and will continue to evolve as the Alliance works with local landowners and identifies cost-saving opportunities. However, the preliminary design described in this chapter and analyzed in this EIS is expected to reflect conservative, bounding parameters for critical features, which would not change substantially such that the impacts described in this EIS would be exceeded.

Figure 2-1. The FutureGen 2.0 Project

For the CO₂ Pipeline and Storage Reservoir, the Alliance would design, construct, and operate a CO₂ transmission pipeline and a geologic injection and storage facility. The pipeline would transport CO₂ from the Meredosia Energy Center (Meredosia, Morgan County, Illinois) to the CO₂ storage study area in Morgan County approximately 30 miles east of the Meredosia Energy Center (see Figure 2-2). Deep injection wells would be installed at the CO₂ storage study area and used to inject CO₂ into the storage reservoir (i.e., the Mt. Simon Formation) at a depth of **approximately 4,000 feet** below ground surface (bgs). The Mt. Simon Formation is the major deep saline formation in the Illinois Basin. The pipeline and storage reservoir would be designed to respectively transport and store up to 24 million tons (22 million metric tons) of CO₂ over a 20-year operating period. In addition, the Alliance would construct and operate facilities for research, training, and visitors near Jacksonville, Morgan County, Illinois.

The FutureGen 2.0 Project would begin final design in 2013 after completion of the NEPA process. Construction would begin in 2014, with commissioning in 2017. Operations and monitoring would continue with DOE funding until 2022 (56 months after commissioning). Performance and economic test results would be shared among all participants, industry, non-governmental organizations, and the public. After DOE's involvement ceases, the FutureGen 2.0 Project would be expected to continue commercial operations, including CO₂ capture and storage, for 20 years. After commercial operations cease, post-injection monitoring of the underground CO₂ would continue for up to 50 years.

2.2 NO ACTION ALTERNATIVE

Under the no action alternative, DOE would not continue to fund the FutureGen 2.0 Project into the final design, construction, and operation phases. Without DOE funding, it is unlikely that the Alliance, or industry in general, would undertake the utility-scale integration of CO₂ capture and geologic storage with a coal-fueled power plant using oxy-combustion. Therefore, the no action alternative also represents a "no-build" alternative. Without DOE's investment in a utility-scale facility, the development of oxy-combustion repowered plants integrated with CO₂ capture and geologic storage would occur more slowly or not at all.

2.3 ALTERNATIVES CONSIDERED BUT DISMISSED FROM FURTHER EVALUATION

This section discusses other alternatives that were considered but dismissed from further evaluation and the reasons for their dismissal. Chapter 1 of this EIS, Purpose and Need, describes the background and

history of the FutureGen Initiative culminating in the FutureGen 2.0 Project (see Section 1.2), which explains the alternative technologies considered in the evolving project. DOE’s primary objective to advance the programmatic goal of CO₂ capture and storage through the FutureGen Initiative was addressed in the Final EIS for the original FutureGen Project (DOE 2007a) and associated ROD (74 FR 35174 [2009]).

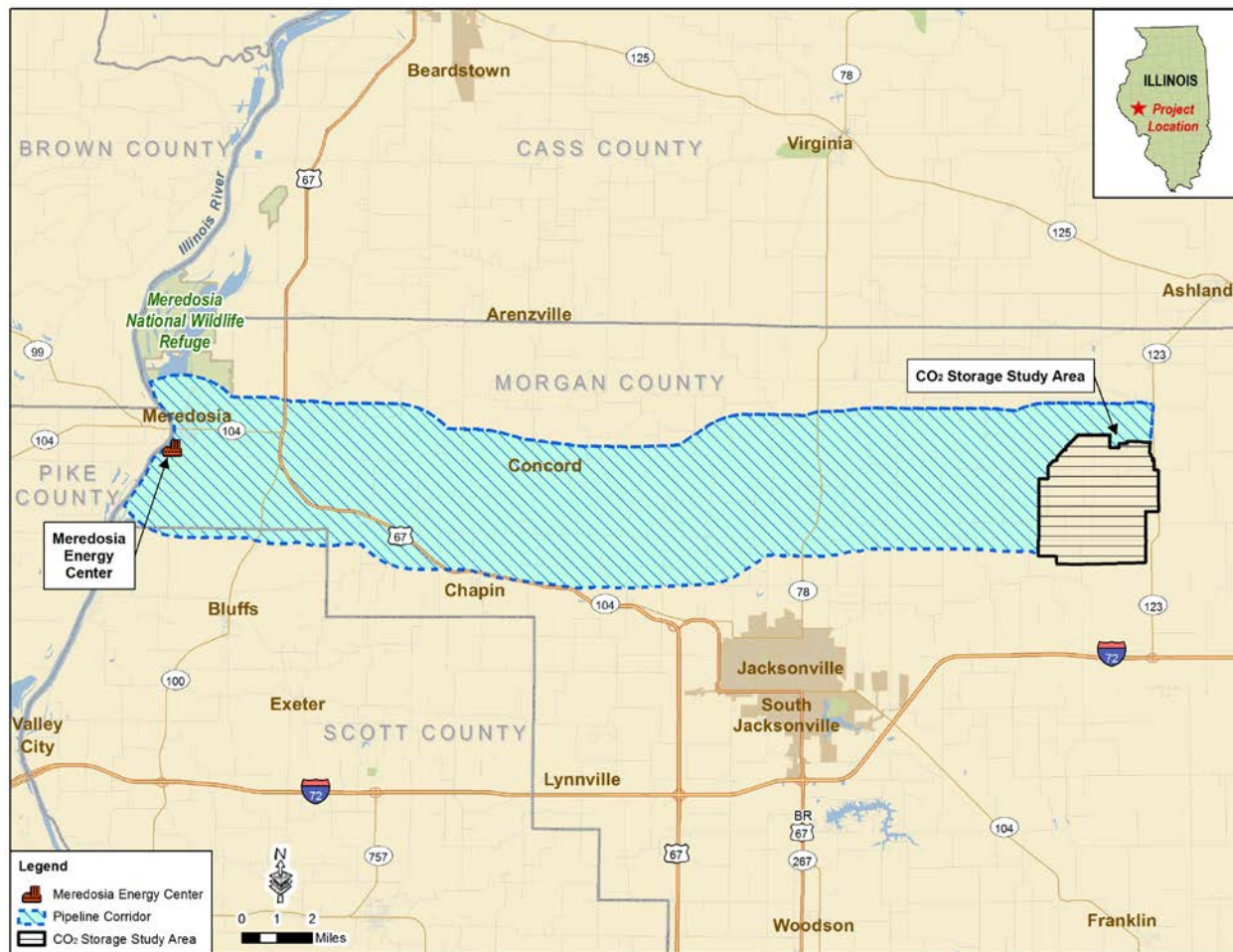

CO₂ = carbon dioxide

Figure 2-2. Project Location Map

2.3.1 Alternative Fuel Sources

Because the FutureGen Initiative was conceived for the purpose of encouraging commercial development of advanced coal-based carbon capture and storage technologies, other technologies that cannot serve to carry out that goal are not reasonable alternatives. Nuclear power, renewable energy sources (e.g., wind and solar power), and energy conservation improvements do not address the specific goal of capturing and storing CO₂ emissions from coal-fueled energy production and therefore are not considered to be reasonable alternatives for the FutureGen 2.0 Project. These fuel sources, as well as many others, are addressed by other programs and projects in DOE’s diverse portfolio of energy research, development, and demonstration efforts.

2.3.2 Alternative Advanced Coal-based Electric Generating Technologies

Technologies for carbon capture at advanced coal-based electric generating facilities fall into two general categories, pre-combustion and post-combustion. Pre-combustion capture technologies remove carbon from the process stream (fuel gas) after the solid coal feed has been converted (i.e., gasified). Post-

combustion capture technologies remove carbon from the process stream (flue gas) after it has been combusted in the boiler. As explained in Section 1.2, the original FutureGen Project considered the demonstration of IGCC technology for the generation of electricity with pre-combustion capture and storage of CO₂ that would otherwise be emitted. Rising costs for the original project delayed DOE's decision and during the intervening time a number of commercial IGCC projects were proposed, many of which would employ pre-combustion carbon capture technology similar to that which was to be proven by the original FutureGen Project. At the time of award of the FutureGen 2.0 Project, DOE had already awarded funding for four other large-scale projects intended to demonstrate the underlying IGCC concept of the original FutureGen Project.

Due to the now-commercial status of IGCC, along with multiple pre-combustion carbon capture projects within DOE's demonstration portfolio, DOE identified the need for a utility-scale demonstration of post-combustion carbon capture technologies. Accordingly, the agency does not consider pre-combustion technologies to be reasonable alternatives for the FutureGen 2.0 Project.

2.3.3 Alternative Retrofitting Technologies

Through review and consideration of the data and analysis associated with the original FutureGen Project, DOE identified the repowering of an existing power plant with oxy-combustion technology as the approach that would best meet cost and technology advancement objectives of the FutureGen Initiative. Instead of funding the construction and operation of a new IGCC plant, DOE considered two options for retrofitting an existing power plant to facilitate carbon capture and storage: repowering with oxy-combustion technology or post-combustion scrubbing. DOE determined that the selection of the oxy-combustion technology for testing and evaluation would complement its CCPI portfolio by providing the opportunity to address a technology option that otherwise would be absent from DOE's slate of projects. Therefore, DOE chose to consider retrofitting an existing power plant with oxy-combustion technology as a lower-cost replacement for the IGCC process originally proposed in the FutureGen Project. Because DOE is already assessing the merits of post-combustion scrubbing in other projects, the agency does not consider that technology to be a reasonable alternative for the FutureGen 2.0 Project.

2.3.4 Alternative Sites for the Oxy-Combustion Large Scale Test

After concluding that there were insufficient funds available for a new IGCC power plant at the site that had been selected by the Alliance for the original FutureGen Project in Mattoon, Illinois, DOE identified the Meredosia Energy Center as an existing power plant that could be repowered with oxy-combustion technology. The Meredosia Energy Center is close enough to the Mattoon site that CO₂ could be readily transported by pipeline to the Mattoon site for injection and permanent storage in the Mt. Simon Formation. An idle electrical generating unit (Unit 4) at the Meredosia Energy Center would provide a reconstructable turbine generator at a scalable size for the commercial demonstration of oxy-combustion repowering technology. The facility would also provide for the capture of CO₂ at a sufficient operating capacity to demonstrate the transport and geologic storage of CO₂ at a commercial scale.

DOE did not identify any other existing, appropriately sized power plants from which captured CO₂ could be transported economically to the Mattoon site for injection and permanent storage. It is difficult for owners of existing power plants to accept the financial and operational risks associated with repowering existing equipment and adding untested CO₂ capture and storage to their plants. Further, commercial ventures generally cannot accept the intensive testing and interruptions of power generation that would be associated with repowering and the startup and testing of carbon capture and storage. Commercial operators are bound by power purchase agreements that are unforgiving of delivery failures, and the power market does not offer much flexibility in negotiating the terms and conditions in these agreements.

Ameren was willing to make the Meredosia Energy Center's Unit 4 available for the FutureGen Initiative in part because the aging unit was not a baseload power generator and operated only sporadically to provide peaking power. Therefore, Unit 4 repowering efforts at Meredosia Energy Center would not pose unacceptable disruptions of power generation or affect existing power purchase agreements. With no

other power plant owners willing to undertake the inherent financial and operational risks, DOE considers the Meredosia Energy Center to be the only viable location for the Oxy-Combustion Large Scale Test component of FutureGen 2.0. DOE does not consider other power plants that are not available to the FutureGen 2.0 Project to be reasonable alternatives.

2.3.5 Alternative CO₂ Pipeline and Storage Reservoir Locations

After DOE and the Alliance identified the Meredosia Energy Center for the FutureGen Initiative, the Mattoon site proponents withdrew their site from further consideration based on a determination that use of the site strictly for CO₂ storage was not in the community's best interest. In response to the Mattoon site being withdrawn as a storage site, DOE asked the Alliance to identify alternative storage sites from which it would be economically viable to transport the CO₂ captured at the Meredosia Energy Center for injection and permanent storage in the same formation as proposed for that Mattoon site (the Mt. Simon Formation). The Alliance then undertook a siting process, similar to the process originally used to select the Mattoon site, to identify possible locations. The Alliance's siting process included screening sites against specific qualifying criteria related to geologic conditions as well as a variety of other factors including land use and environmental considerations (see Section 2.5.2.1). DOE proactively reviewed the qualifying and selection criteria before release to the public and prospective bidders. After proposals were received and scored by the Alliance, the Alliance briefed DOE on the outcome and prepared a summary report, which was submitted to DOE in March 2011. This process culminated in the selection of a site in Morgan County as the Alliance's preferred site, with sites in Christian County and Douglas County being identified as potential alternate sites. DOE reviewed the Alliance's report on the selection process for fairness, technical accuracy, and compliance and determined that the Alliance's preferred site and alternate sites were appropriate for detailed analysis.

Throughout 2011 and 2012, the Alliance conducted a detailed geological analysis at the preferred Morgan County site (i.e., the CO₂ storage study area) to characterize and verify the viability of the proposed CO₂ storage reservoir. The Alliance also conducted pipeline routing studies for the three sites under consideration, as well as desktop and targeted field studies to confirm the absence of any sensitive environmental resources that could be adversely affected by the project. Through these analyses, the Alliance also determined that the costs of siting, constructing, and operating a CO₂ pipeline to either the Christian County or Douglas County sites would be cost-prohibitive. The Alliance estimated that an additional \$50 million to \$100 million would be required to construct pipelines that would be approximately 50 miles (Christian County) and 100 miles (Douglas County) longer than pipelines required for the Morgan County site. Due to the findings of the geological analysis and environmental studies, combined with a cost analysis of the pipelines to the alternate sites, the Alliance confirmed that the proposed Morgan County site remained its preferred site.

On July 17, 2012, the Alliance Board of Directors confirmed that the proposed Morgan County site remained its preferred location and voted to direct the Alliance to no longer pursue the sites in Christian County and Douglas County as alternate sites due to cost considerations. The Alliance notified DOE and the proponents of Christian County and Douglas County that their locations were no longer being considered as alternate sites and that the Alliance would not construct or operate a CO₂ storage reservoir at either site. As a result, the site proponents were released to find other reasonable uses for their proposed sites.

Because of the Alliance's decision to no longer consider the Christian County and Douglas County sites, DOE has determined that these sites are not reasonable alternatives as CO₂ storage reservoirs for FutureGen 2.0. Therefore, these sites have been eliminated from further consideration in this EIS.

2.4 FUTUREGEN 2.0 OXY-COMBUSTION LARGE SCALE TEST

For the FutureGen 2.0 Project, the Alliance would purchase from Ameren portions of the Meredosia Energy Center as described in Section 2.4.1. With support from Babcock & Wilcox and Air Liquide, the

Alliance would design, construct, and operate an advanced oxy-combustion power generation plant. The oxy-combustion facility has a proposed design capacity of 168 MWe (**gross**) and would be integrated into the Meredosia Energy Center in order to make use of existing facilities and infrastructure. The facility would operate continuously to generate baseload electric power. The project would repower the existing Unit 4 steam turbine generator, and capture and compress approximately 1.2 million tons (1.1 million metric tons) of CO₂ per year for subsequent transport and geologic storage. The project would be designed to meet DOE's CO₂ capture target of at least 90 percent **during steady-state operations** (the project **may achieve a 98 percent capture efficiency**), while reducing emissions levels of sulfur oxides, nitrogen oxides, mercury, acid gases, and particulate matter during normal operations.

2.4.1 The Meredosia Energy Center

In October 2011, Ameren announced that the Meredosia Energy Center would suspend operations at the end of 2011 (see Section 2.4.1.5 for further discussion). The facility is currently not operating, but Ameren is complying with applicable permits and associated requirements and will maintain the facilities to be available for the FutureGen 2.0 Project. All equipment remains in operable condition, which would enable Ameren to operate the generating facilities if the resumption of operations were to fit Ameren's requirements. This possibility would remain until final decisions for the FutureGen 2.0 Project would be made and the project implemented. This section describes features and operating conditions at the energy center as they existed during 2011 and in recent history.

The Meredosia Energy Center, shown in Figure 2-3, is located adjacent to the east side of the Illinois River, south of the village of Meredosia, Illinois. Meredosia has a population of approximately 1,044 (USCB 2010a) and is approximately 18 miles west of Jacksonville, Illinois. The 5,300-foot western boundary of the 263-acre Meredosia Energy Center fronts the Illinois River, where the station's oil and coal barge unloading facilities are located. Land use immediately east of the energy center consists of roadways, roadway rights-of-way (ROWs), rail access, and an unused railroad ROW. Beyond these immediate areas, land use is primarily residential to the north and northeast, scattered residential and agricultural to the east, and industrial to the south. Across the river, approximately 700 feet west, are forested lands, a small portion of a levee, and a transmission line ROW.



Figure 2-3. Meredosia Energy Center

The Meredosia Energy Center is a thermal plant designed to produce electricity. In a thermal plant, energy from fuel (e.g., coal) is used to heat water and create steam. The generated steam converts the heat energy captured in the steam into mechanical energy by spinning turbines that in turn spin electric generators that produce electricity. The two main features of a thermal plant are the boiler that generates heat through the combustion of coal or other fuels, and the turbine-generator system that includes the steam turbine and electric generator. Other plant components support these systems. Major boiler support systems are the coal handling and fuel systems, steam and water systems for the boiler and turbine, air and flue gas system, and waste management systems.

Figure 2-4 provides an overall aerial view of the existing Meredosia Energy Center property and surrounding areas. Figures 2-5 and 2-6 show close-up aerial views of the existing coal handling facilities and the main plant area, respectively.

The Meredosia Energy Center includes four electric generating units. An electric generating unit refers to the combination, or unit, of equipment that is used to generate electricity including the boilers that create heat energy through combustion, steam cycle equipment that uses the heat to generate steam, steam turbines that convert the steam to mechanical energy, and electric generators that convert the mechanical energy to electricity. These units also include supporting equipment and facilities. Units 1 and 2 were driven by steam from four coal-fired boilers (Boilers 1, 2, 3, and 4), with each unit having a nominal rated generating capacity (i.e., capacity) of 60 MWe. Unit 3 received steam from one coal-fired boiler (Boiler 5) and has a capacity of 229 MWe. Units 1 and 2 were placed in service in 1948 and 1949, respectively. Unit 3 was placed in service in 1960.

Unit 4 consists of one oil-fired boiler (Boiler 6) and has a capacity of 200 MWe. Unit 4 was placed in service as an interim measure in 1975 to meet anticipated load growth until new generating facilities came online in 1977. During the 1980s and early 1990s, Unit 4 was operated as a peaking unit and has accumulated approximately 20,000 hours of operation, with 900 starts. Peaking units are electric generating units that are only used during periods of high electricity demand. Under the FutureGen 2.0 Project, Unit 4 would be repowered using a new oxy-combustion coal-fired boiler in place of the existing oil-fired boiler.

The main facilities include a building that houses Boilers 1 through 5 as well as the steam turbine generators for Units 1, 2, 3, and 4. Additional structures include the coal breaker building, tractor shed, and several warehouses. Exclusive of the chimneys (stacks), which are the tallest structures at the facility (the tallest stack, at Unit 1, is 526 feet in height), components of the main buildings range in height from 24 to 209 feet. The energy center property covers approximately 263 acres.

The Meredosia Energy Center currently has two main fuel systems: coal for Units 1, 2, and 3 (Boilers 1 through 5) and fuel oil for Unit 4 (Boiler 6). Secondary fuel systems include distillate fuel oil as auxiliary fuel for startup of Boilers 1 through 6 and flame stabilization for Boilers 1 through 5, plus natural gas for the main burner ignition on Boiler 6.

The existing coal handling system at the Meredosia Energy Center serves Units 1 and 2, which typically burned bituminous coal from Illinois sources, and Unit 3, which typically burned 100 percent Powder River Basin sub-bituminous coal from Wyoming. However, Unit 3 has burned both Illinois coal and a blend of Illinois and Powder River Basin coals. During operations, the bituminous coal was delivered by truck, while the Powder River Basin coal was delivered by barge (from St. Louis, Missouri, where it was delivered from Wyoming via rail). Powder River Basin coal was unloaded from the barge via a clamshell bucket into the barge unloading hopper. From there, the coal was transferred via various conveyors and other mechanisms to storage and boiler-usage locations. Particulate emissions associated with the coal handling and storage were controlled by various dust suppression measures, including a water spray, enclosures, and covers. Before 2012, the coal handling system was running about 5 to 6 hours per day, 7 days per week, to supply coal from the barges directly to the Boiler 5 coal bunkers.

Unit 4's Boiler 6 was designed to be run on fuel oil. Fuel oil was delivered by tanker barge and unloaded at the fuel oil unloading facility downstream of the coal barge unloading facility, or by truck near the fuel oil tanks. The fuel oil was piped from the tanker barges to two fuel oil storage tanks located east of the coal storage area, each with a 4.6 million-gallon capacity and located inside bermed areas (see Figure 2-4).



ASU = air separation unit; cy = cubic yard; kV = kilovolt; NPDES = National Pollutant Discharge Elimination System

Figure 2-4. Meredosia Energy Center Features – Aerial Overview

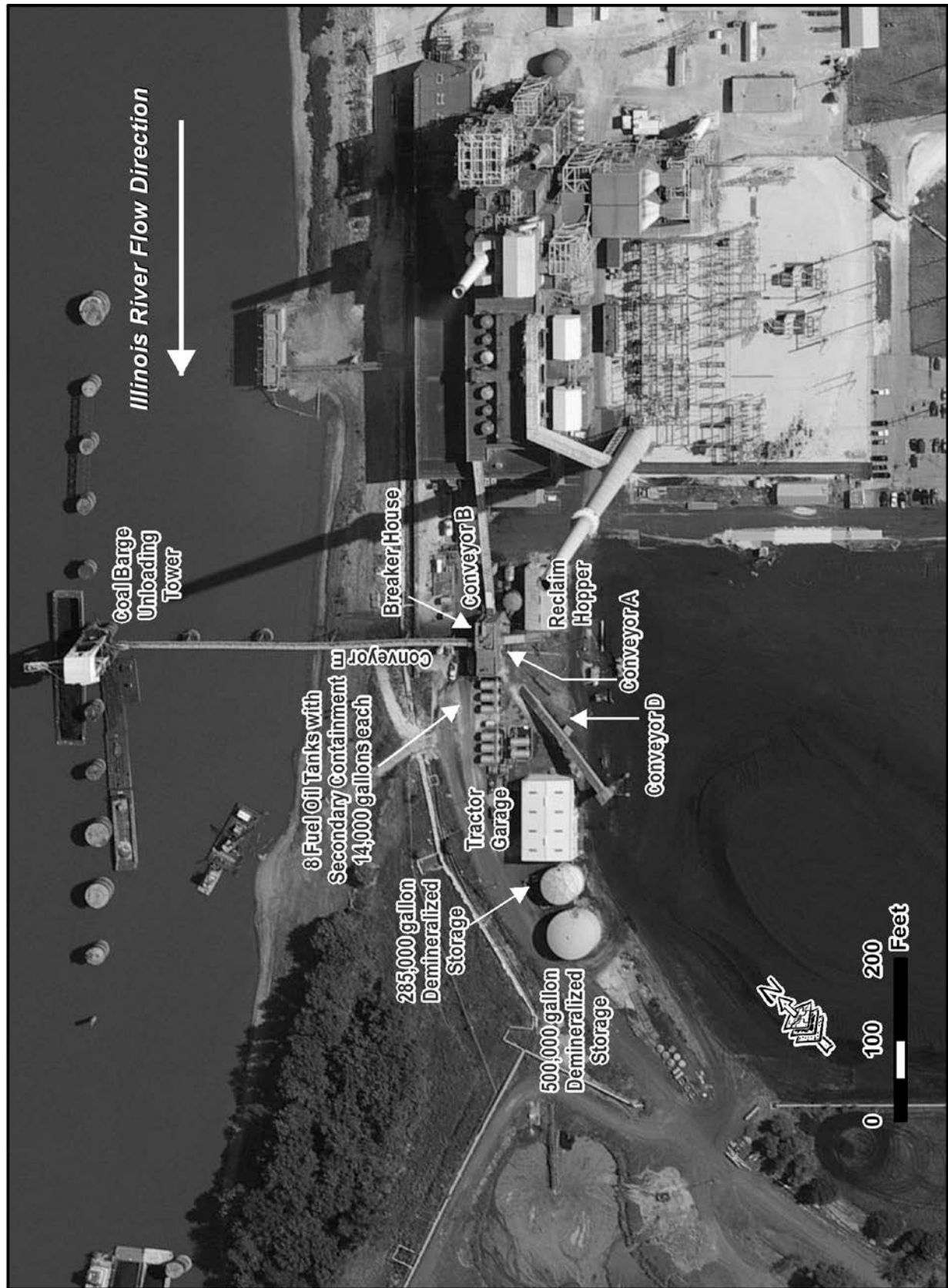

Figure 2-5. Meredosia Energy Center – Coal Handling and Nearby Features

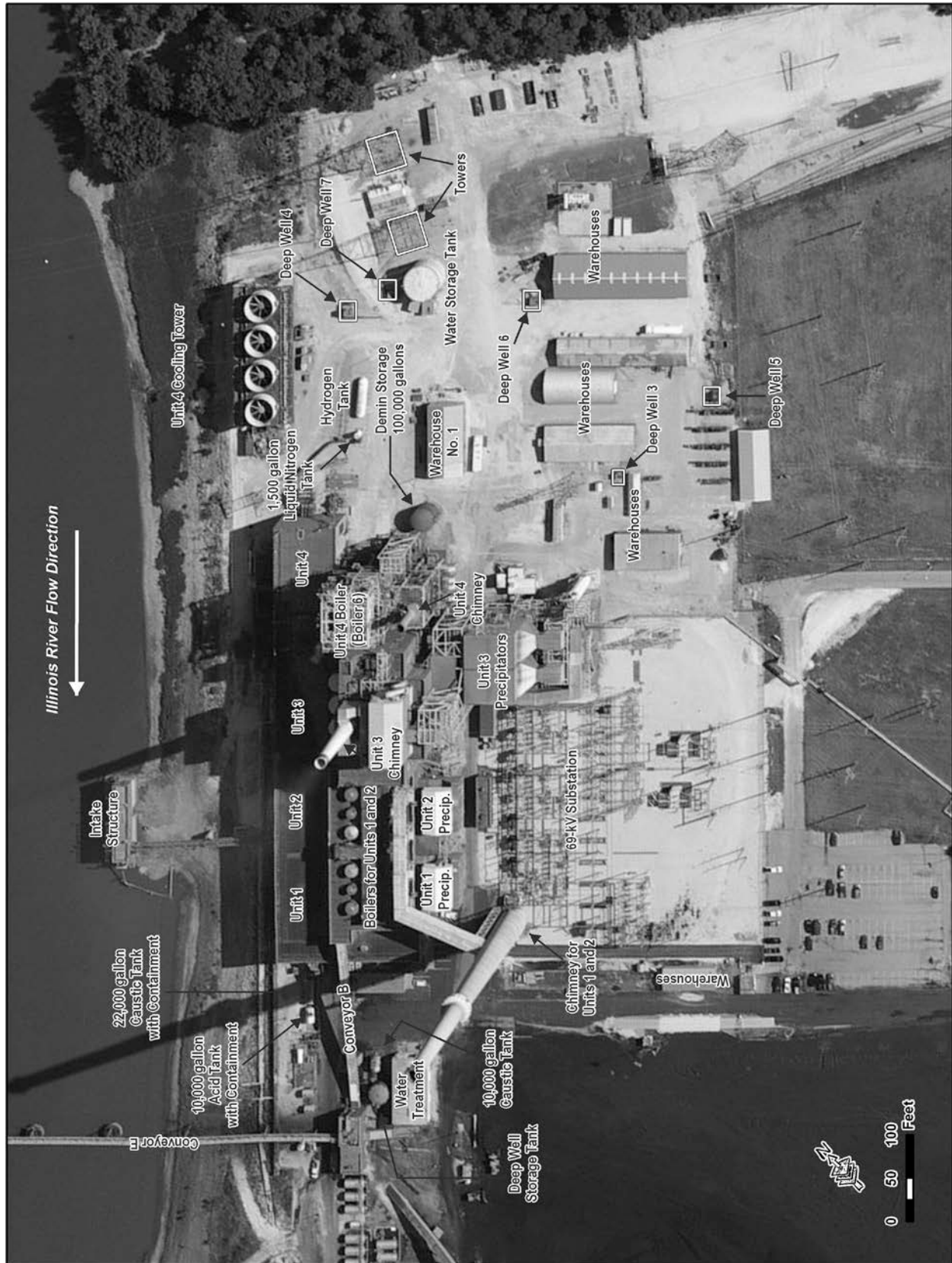

Figure 2-6. Meredosia Energy Center Features – Coal and Fuel Handling Systems

The fuel oil was also used to power onsite mobile equipment (scraper, dozers, etc.) and some stationary equipment. Eight 14,000-gallon distillate fuel oil tanks and a 14,000-gallon diesel tank are located south of the coal breaker house (see Figure 2-5). Boiler 6 also used natural gas for main burner ignition and either distillate fuel oil or natural gas as an auxiliary fuel during startup.

2.4.1.1 Boiler and Turbine Steam and Water Systems

Makeup water for the boiler and turbine steam system was supplied by onsite groundwater production wells shared in common by all units. Wells 5, 6, and 7 were installed in 1974, 1978, and 1994, respectively. Each well has a capacity of 400 to 500 gallons per minute (gpm). Only Wells 5, 6, and 7 are in operation; Wells 3 and 4 are older and no longer used. Well locations are shown in Figure 2-6. All wells are screened near the bottom of the Cahokia formation at a little over 100 feet in depth. Raw well water was treated in a resin demineralizer for use as demineralized water, and also used for other plant functions such as potable water, dust suppression for the coal handling facilities, and freeze protection of the bottom ash pond. The deep well water storage tank is located west of the water treatment building.

The main use of cooling water in a thermal plant is to condense the steam in the steam cycle. Boilers 1 through 5 were designed for once-through cooling, and Boiler 6 has a closed recirculating system with a cooling tower (located at the north end of the energy center, bordering the river). The Illinois River supplied the main condenser and auxiliary cooling water for Units 1 through 3, makeup cooling water for Unit 4 cooling tower, and miscellaneous Unit 4 auxiliary cooling needs. River water was withdrawn through screens in the intake structure shown in Figure 2-4. The intake structure design capacity is approximately 272,000 gpm (or 392 million gallons per day [mgd]). Currently, there is no permit limitation on the amount of river water that can be withdrawn.

The public water supply for the energy center was provided by the Meredosia water distribution system and was used for fire protection water and some maintenance activities. The existing fire protection water storage tank capacity is 325,000 gallons.

2.4.1.2 Air and Flue Gas System

The energy center includes three chimneys that vent flue gas from boiler combustion. The chimney for Boilers 1 through 4 is 32 feet in diameter at the base and 526 feet tall. Boiler 5's chimney is 301 feet tall and Boiler 6's chimney is 184 feet tall.

The Meredosia Energy Center holds several air operating permits, including those for the operation of Units 1 through 4. Reported emissions at the energy center in tons per year for 2007, 2008, 2009, and 2010 are summarized in Table 2-1.

2.4.1.3 Waste Management Systems

Coal Combustion Residual (Ash)

Fly ash (fine particles generated during the combustion of coal that were collected by the electrostatic precipitators prior to discharge to the atmosphere) and bottom ash (coarse particles generated during the combustion of coal that fall by gravity to the bottom of the boiler) were sluiced to separate ponds as shown in Figure 2-4. The bottom ash pond capacity is 300,000 cubic yards (8,100,000 cubic feet) and the fly ash pond capacity is 1,000,000 cubic yards (27,000,000 cubic feet). Prior to 2012, the ash ponds served Units 1, 2, and 3. These ash ponds would not be used for the FutureGen 2.0 Project. See Section 2.4.4.2 for a description of how bottom ash and fly ash would be handled in the proposed project. See Section 2.4.1.5 for a discussion regarding the management of the existing ash ponds.

Table 2-1. Reported Air Emissions at the Meredosia Energy Center

Pollutant	Emissions (tpy)			
	2007	2008	2009	2010
CO	288	224	83	125
NO _x	3,172	2,539	820	786
PM ^a	288	211	65	84
PM ₁₀ ^a	109	78	22	28
PM _{2.5} ^a	16	12	4	5
SO ₂	11,388	8,016	2,146	2,466
VOCs	40	31	12	17

^a. Filterable particulates only.

CO = carbon monoxide; NO_x = nitrogen oxides; PM = particulate matter; PM_{2.5} = particulate matter of diameter 2.5 microns or less; PM₁₀ = particulate matter of diameter 10 microns or less; SO₂ = sulfur dioxide; tpy = tons per year; VOCs = volatile organic compounds

Wastewater

The Meredosia Energy Center discharged wastewater to the Illinois River under National Pollutant Discharge Elimination System (NPDES) Permit IL0000116. The permit lists the following discharges, with the Illinois River as the receiving water for each:

- 001 – Condenser cooling water (Units 1, 2, and 3)
- A01 – Boiler blowdown
- 002 – Cooling tower blowdown
- A02 – Cooling tower emergency overflow
- 003 – Bottom ash pond discharge
- A03 – Chemical metal cleaning wastewater
- 004 – Fly ash pond discharge
- 006 – Intake screen backwash

The locations of these outfalls are shown in Figure 2-4. The discharge characteristics and NPDES permitting limits of the existing outfalls are discussed in greater detail in Section 3.6, Surface Water. The majority of onsite runoff from the developed areas of the property currently drains into the fly ash and bottom ash ponds.

The energy center did not operate a wastewater treatment system. The sanitary wastewater was collected and routed to a single point of discharge to the village of Meredosia’s sewer system.

2.4.1.4 Transportation Resources

Illinois Highway (IL-) 104 is the main regional route into Meredosia and to the energy center site. The closest interstate is Interstate (I-) 72, which is about 10 miles south of Meredosia. From IL-104, Washington Street and Old Naples Road provide direct access to Cips Drive, the main entrance roadway into the energy center site. Truck traffic accessing the site transported fuel oil and coal. These trucks used a bypass road from IL-104 to avoid traveling through the village of Meredosia, accessing the site from the south. An old gravel road that cuts through a patch of wooded area within the northern property provides access into the energy center from an existing boat ramp site, but is not typically used. Another gravel road exists in the southern portion of the property, which provides access into the site, but is also not typically used. The energy center site originally had a rail spur for coal delivery; however, this has been

removed. As noted earlier, barge unloading facilities are located on the Illinois River along the northwestern border of the site for Powder River Basin coal and fuel oil deliveries.

2.4.1.5 Suspension of Energy Center Operations

At the end of 2011, Ameren suspended operations at the Meredosia Energy Center due mainly to the expected costs of complying with recently implemented air regulations, specifically the Cross-State Air Pollution Rule issued in July 2011 by the USEPA. The Cross-State Air Pollution Rule was subsequently vacated and remanded by the U.S. Court of Appeals on August 21, 2012. Since Ameren suspended operations at the end of 2011, only security personnel work at the energy center, with a few Ameren employees onsite from time to time to perform periodic inspections of the facility to comply with ongoing environmental monitoring requirements and to maintain facility integrity for the FutureGen 2.0 Project.

Suspension of operations means that the energy center currently is not operating, but Ameren is complying with applicable permits and their associated requirements. All equipment remains in operable condition, which would allow Ameren to reactivate the facilities in the future if those operations fit into Ameren's requirements. If the FutureGen 2.0 Project were to be implemented, the energy center's boiler operations and auxiliary operations not associated with the FutureGen 2.0 Project would be terminated. Ameren has no current plans to resume operation of the power generation infrastructure at the energy center.

Closure of the ash ponds could occur during the FutureGen 2.0 Project depending upon timing of the submittal and Illinois Environmental Protection Agency (IEPA) approval of the ash pond closure plan and the time required to complete the closure. Ameren and the Alliance have agreed that the ash ponds would not be part of the asset transfer associated with the FutureGen 2.0 Project. Environmental liability associated with the existing ash ponds and compliance with current or future regulations remain with Ameren until such time as the property and environmental liability may be transferred to a third party. The management of the ash ponds (past, current, and future) is the responsibility of Ameren and would not affect the implementation, construction, or operation of the FutureGen 2.0 Project. Therefore, any potential environmental impacts resulting from the ash ponds are not relevant to the evaluation of potential impacts from the construction and operation of the FutureGen 2.0 Project.

Ameren has not undertaken environmental decommissioning activities, as they have been deemed premature at this time. Ameren conducted an asbestos survey at the energy center and labeled thermal piping as either containing or not containing asbestos. Ameren has also conducted evaluations for polychlorinated biphenyl (PCB)-containing equipment. There is minimal electrical equipment containing PCBs, and such equipment is properly labeled. There has been no evaluation of lead-based paint within the energy center; nor has there been a Phase 1 Environmental Site Assessment conducted at the site.

Ameren formally notified the U.S. Coast Guard that operations of the fuel oil unloading river facility and the associated fuel oil storage facility have been suspended. As a result, the security requirements for these facilities under Maritime Security have been suspended. Air and water permits will remain active to maintain current water discharge outfalls and air emissions sources.

In conjunction with the suspension of operations, Ameren shut down equipment associated with Units 1, 2, and 3 in place along with Boiler 6. Ameren retained the availability of the Unit 4 turbine generator and its balance of plant equipment for use by FutureGen 2.0. Project common systems, such as intake structures, service water, well water, demineralizer, condensate storage, fire protection, coal handling, auxiliary power, service and instrument air, and other systems required to support the FutureGen 2.0 Project were also retained.

Ameren would remove chemicals, oils, and fuel not required for FutureGen 2.0 from the site and either use these materials at other Ameren facilities, recycle them where practical, or characterize and properly dispose of them in accordance with applicable regulations. Ameren will oversee periodic monitoring of the facility to ensure its integrity for use by FutureGen 2.0. In addition, the ash ponds will be monitored

with respect to dam safety and NPDES requirements. Ameren will maintain other inspection, monitoring and reporting requirements in accordance with active environmental permits. Site restoration activities would depend upon Ameren’s future decisions with respect to the property.

2.4.2 Oxy-Combustion Large Scale Test

The Oxy-Combustion Large Scale Test component of the FutureGen 2.0 Project would include the design, construction, and operation of an oxy-combustion power generation plant (Alliance 2012). A simplified diagram of an oxy-combustion facility is provided in Figure 2-7. This facility would be integrated into the existing infrastructure of the Meredosia Energy Center and would include the addition of a new oxy-combustion coal boiler with equipment to capture, purify, and compress CO₂ for use in the CO₂ Pipeline and Storage Reservoir component of the project (see Section 2.5 for details on pipeline and storage).

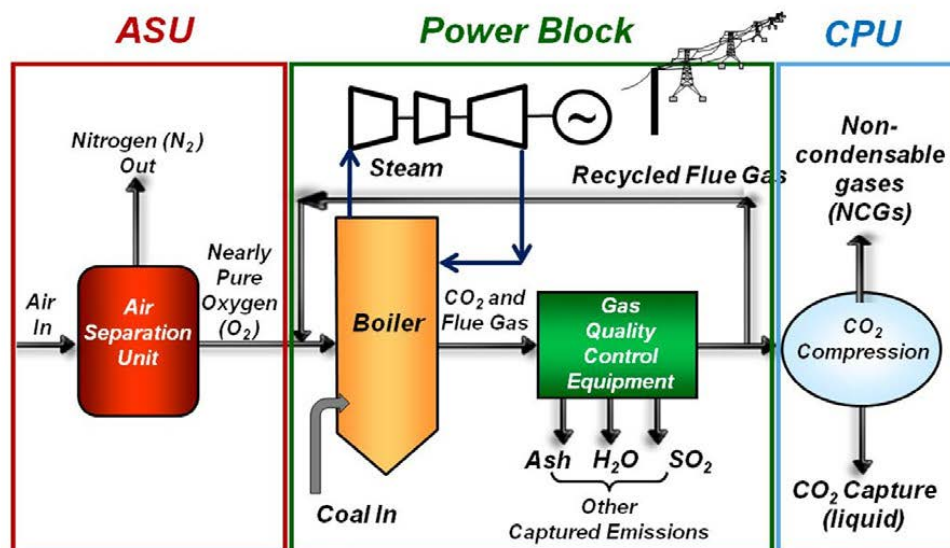

Source: Babcock & Wilcox 2010
 ASU = air separation unit; CO₂ = carbon dioxide; CPU = compression and purification unit; H₂O = water;
 N₂ = nitrogen; NCGs = non-condensable gases; O₂ = oxygen; SO₂ = sulfur dioxide

Figure 2-7. Simplified Diagram of Oxy-Combustion Facility

Major components of the proposed oxy-combustion facility (new and existing) and an overview of their key features are provided in Table 2-2. Existing infrastructure that would be used by the project includes coal handling systems (delivery, storage, and conveyance), water supply systems (intake structures and wells), wastewater discharge outfalls, the main cooling tower (to be rebuilt from the existing Unit 4 cooling tower), substation equipment, the Unit 4 steam generator, the Unit 4 electric generator, and other common plant infrastructure such as roadways. A conceptual layout of the facility that depicts the location of new and existing equipment is presented in Figure 2-8. Details of the oxy-combustion facility and process features are provided in Section 2.4.2.1.

To accommodate the proposed oxy-combustion facility at the Meredosia Energy Center, several existing warehouses, a deaerator, and one of the condensate storage tanks would be relocated. Three existing groundwater supply wells (Wells 3, 4, and 5) would be decommissioned and a new replacement well would be installed. The main cooling tower would be reconstructed and two additional cooling towers would be constructed, one for the direct contact cooler polishing system and one for both the air separation unit and compression and purification unit.

The capacity and configuration of the proposed facility is based on using the Babcock & Wilcox–Air Liquide cool recycle oxy-combustion process and would fire a mix of high-sulfur bituminous coal and

Table 2-2. Overview of Oxy-Combustion Facility Components and Features

Component	Description
<u>Air Separation Unit (new)</u>	Generates oxygen for the oxy-combustion boiler: <ul style="list-style-type: none"> - Compresses and dries ambient air; - Separates oxygen through compression and cryogenic distillation; - Directs manufactured oxygen to the boiler for combustion process; and - Vents separated remaining gases to atmosphere.
<u>Power Block</u>	Generates thermal energy through combustion, converts the thermal energy to steam, and uses steam to create mechanical energy to drive the electric generator that produces electricity.
Boiler (new)	Combusts pulverized coal with a mixture of oxygen and recycled flue gas. Uses heat generated in the combustion process to generate steam.
Gas Quality Control System (new)	Treats flue gas generated during the combustion process to remove pollutants and impurities. Directs treated gas to the CPU and also back to the boiler. Includes the following: <ul style="list-style-type: none"> - CDS to remove sulfur compounds (e.g., sulfur dioxide and sulfur trioxide); - Pulse jet fabric filter to remove particulates; and - DCCPS for reduction of moisture and additional removal of pollutants to meet CPU purity requirements.
Steam Turbines (existing)	Converts thermal energy captured in steam to mechanical energy through the spinning of the turbines.
Electric Generators (existing)	Uses mechanical energy (spinning) from turbines to drive electric generators that produce electricity.
Electrical Control System (existing and new)	Transfers electricity from generators to the transmission grid.
<u>Compression and Purification Unit (new)</u>	Purifies and compresses treated flue gas for delivery to CO ₂ pipeline.
<u>Additional Equipment and Systems</u>	Additional equipment is needed to supply process water, provide cooling to plant processes, supply and handle fuel (coal), and treat waste streams.
Cooling Towers (existing & new)	The cooling towers include two new cooling towers and reconstruction of the existing Unit 4 cooling tower. Cooling towers are used to provide cool water for the condensation of steam in the steam condenser and to remove excess heat from other system processes (e.g., ASU and CPU).
Process Water Systems (existing & new)	Includes use of existing water intake structures and wells (one new well) to supply water to the plant and new water treatment systems to remove water impurities.
Wastewater Treatment Systems (new)	Includes three new wastewater treatment systems that would remove pollutants from wastewater generated in the CPU, the DCCPS, and areas where stormwater could be contaminated by industrial activities.
Coal Storage and Handling (existing)	Includes delivery, storage, and conveyance systems.
Exhaust Stack(new)	A new exhaust stack (chimney) would be approximately 450 feet tall and contain two exhaust vents, one for the oxy-combustion boiler during air firing operations and a second for the CPU. The exhaust stack would discharge treated flue gas during normal operations, discharge monitored volumes of flue gas during unit startup and the transition to oxygen-fired status, and discharge flue gas and CO ₂ during normal shutdown.
Auxiliary Boiler (new)	A new auxiliary boiler would be used to provide steam to the plant that is needed during the startup process. This would most likely be an oil-fired boiler.

ASU = air separation unit; CDS = circulating dry scrubber; CO₂ = carbon dioxide; CPU = compression and purification unit; DCCPS = direct contact cooler polishing system

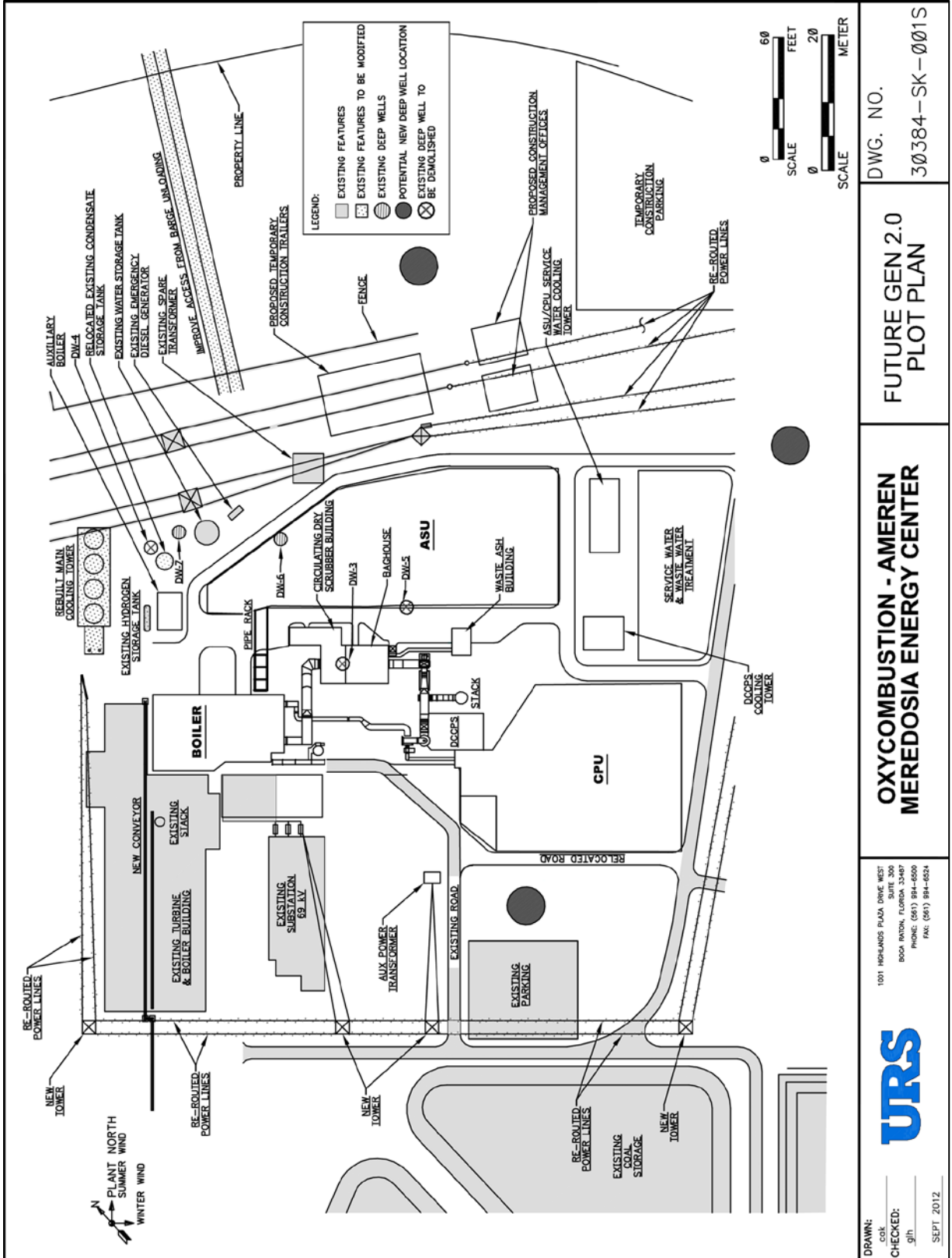

DWG. NO. 30384-SK-001S	FUTURE GEN 2.0 PLOT PLAN	OXYCOMBUSTION - AMEREN MEREDOSIA ENERGY CENTER 1011 HOWLANDS PLAZA DRIVE WEST SUITE 300 BOCA RATON, FLORIDA 33487 PHONE: (561) 984-6500 FAX: (561) 984-6524 URS DRAWN: csk CHECKED: jth SEPT 2012
---------------------------	-----------------------------	---

ASU = air separation unit; CPU = compression and purification unit; DCCPS = direct contact cooler polishing system; DW = deep well; kV = kilovolt

Figure 2-8. Conceptual Oxy-Combustion Facility Site Layout

low-sulfur Powder River Basin coal. The resulting overall thermal and electrical performance is summarized in Table 2-3.

Table 2-3. Electrical and Thermal Performance Summary for Oxy-Combustion Facility

Component	Value
Steam Turbine Gross Generation to 138 kV Grid	167.7 MWe
Total Plant Auxiliary Power	68.7 MWe
Plant Net Generation	99.0 MWe
Plant Net Heat Rate, HHV	16,727 kJ/kWh (15,854 Btu/kWh)
Net Plant Efficiency, HHV	21.5 percent

Note: Values are based on annual average baseload normal operation conditions, as follows:

- Estimated degradation for existing plant equipment;
- Ambient Temperature: 53°F dry bulb, 48°F wet bulb; and
- Oxy-combustion operation of boiler at maximum continuous rating on design fuel (60% Illinois No. 6 bituminous coal and 40% Powder River Basin coal), with 1% boiler drum blowdown.

Btu/kWh = British thermal units per kilowatt hour; °F = degrees Fahrenheit; HHV = higher heating value; kJ/kWh = kilojoules per kilowatt hour; kV = kilovolt; MWe = megawatt electrical; % = percent

2.4.2.1 Oxy-Combustion Process and System Features

To incorporate the oxy-combustion process, Boiler 6 would be demolished and a new oxy-combustion boiler (Boiler 7) would be constructed. This new boiler would repower the existing Unit 4 steam turbine. Oxy-combustion is essentially conventional coal combustion using a mixture of manufactured oxygen and recycled flue gas instead of ambient air in the combustion process. This technology effectively removes nitrogen from the combustion process, which significantly reduces the flue gas mass flow and facilitates the capture of high purity CO₂ flue gas. There are three major components in the oxy-combustion facility including the air separation unit, power block and balance of plant, and compression and purification unit.

Air Separation Unit

The main function of the air separation unit is to generate oxygen from ambient air for use in the boiler combustion process. The first step in the air separation unit is to compress, purify, and dry ambient air by removing water and other minor impurities (see Figure 2-9). Dry (water-free) air consists of approximately 78 percent nitrogen and 21 percent oxygen. Oxygen and nitrogen in the dry air would be separated in the “cold box” through compression and cryogenic (very cold) distillation. Oxygen generated in the air separation unit would then be directed to the boiler for the combustion process, and the nitrogen would be vented to the atmosphere. Cooling water for the air separation unit would be supplied by a new cooling tower that would also service the compression and purification unit.

Power Block and Balance of Plant

The oxy-combustion facility associated with the FutureGen 2.0 Project is shown schematically in Figure 2-10. The combustion process employs the Babcock & Wilcox-Air Liquide cool recycle process, firing a mixture of high sulfur bituminous coal and low sulfur sub-bituminous coal. Because removing the nitrogen from the combustion process significantly reduces flue gas mass flow, the Babcock & Wilcox-Air Liquide cool recycle process recycles treated flue gas back to the boiler to make up for the reduced mass and more closely mimics the heat transfer properties of a conventional air-fired boiler. The entire system would be integrated into the Meredosia Energy Center to maximize **heat optimization given** the existing steam cycle and equipment. Heat from the air separation unit would be incorporated into the condensate cycle, while heat from the steam cycle would be used for flue gas reheating and other process heat loads.

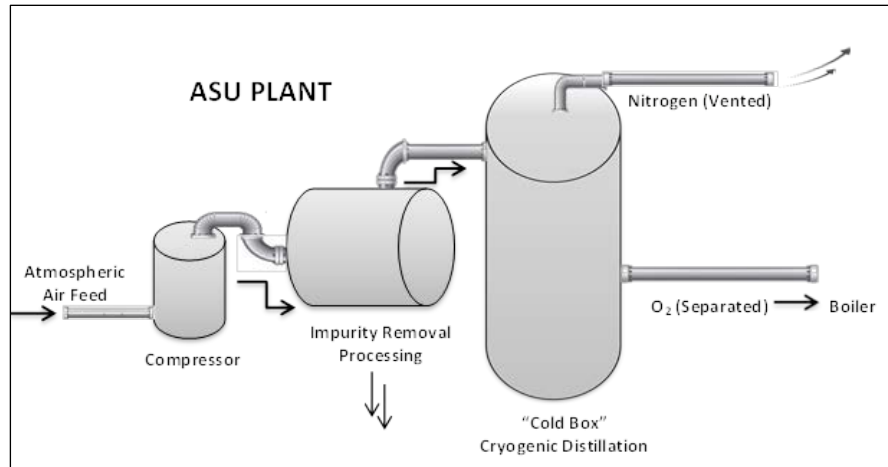

ASU = air separation unit; O₂ = oxygen

Figure 2-9. Basic Air Separation Process

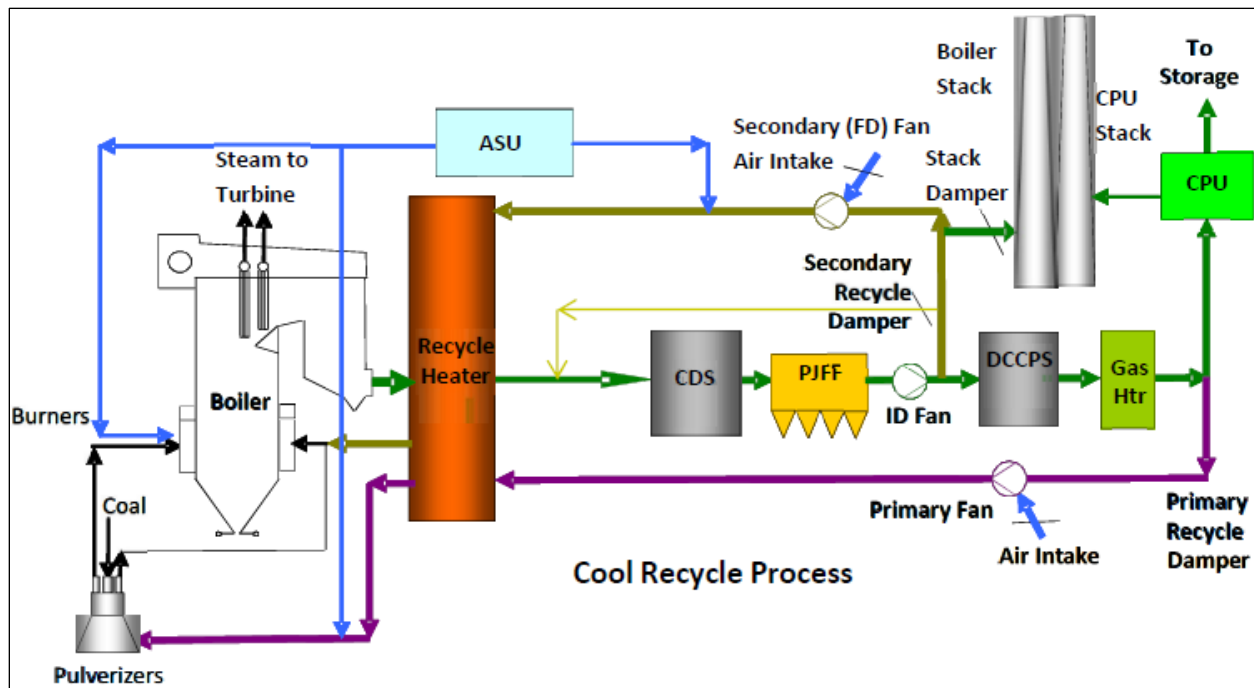

ASU = air separation unit; CDS = circulating dry scrubber; CPU = compression and purification unit; DCCPS = direct contact cooler polishing system; Htr = heater; ID = induction draft; PJFF = pulse jet fabric filter

Figure 2-10. Oxy-Combustion Cool Recycle Process Schematic

In the cool recycle process, hot gas leaves the boiler and passes through a regenerative advanced **quad-sector** secondary and primary recycle heater (similar to a conventional air heater). This recycle heater would be internally arranged to prevent any leakage of the oxygen fed from the air separation unit into the flue gas exiting the boiler.

Following the recycle heater, the flue gas would pass through a circulating dry scrubber¹ where much of the sulfur dioxide and sulfur trioxide would be removed, and then into the pulse jet fabric filter, where particulate matter would be removed. From the pulse jet fabric filter, the flue gas pressure would be boosted by the induced draft fan and the flue gas flow would be split into three streams. A continuous recirculation stream of flue gas would be sent back to the inlet of the circulating dry scrubber to ensure a minimum allowable gas velocity through the absorber for all boiler loads. A second stream from this split would **be boosted by the secondary recycle fan and then** passed through a gas reheater to avoid downstream moisture condensation at low loads. Oxygen would be introduced into the secondary recycle flow before the secondary recycle fan before re-entering the recycle heater for heating prior to the boiler windbox. The secondary recycle fan would control the secondary flow to the boiler. The remaining flue gas stream **exiting the pulse jet fabric filter** would pass through the direct contact cooler polishing system where moisture would be reduced.

The saturated gas leaving the direct contact cooler polishing system would be reheated to avoid downstream moisture condensation and again split with one stream flowing to the compression and purification unit, and the other supplying the primary recycle fan. The primary recycle fan would provide the flow required to dry and convey the pulverized coal to the burners. Oxygen **from the air separation unit** would be introduced into the primary recycle flow after the recycle heater. The oxygen concentration in this stream would be controlled to mitigate risk of combustion in the pulverizers or coal pipes. Oxygen would also be injected directly into the burners to control combustion and the remaining oxygen mixed into the secondary recycle as previously described.

The new exhaust stack (chimney) would be comprised of two separate exhaust vents, one for the oxy-combustion boiler during air firing operations and a second for the compression and purification unit. The **first vent (air-firing) in the new exhaust stack** would be designed to discharge monitored volumes of flue gas during unit startup **when the boiler is air firing.** The **second vent (compression and purification unit) would be designed to discharge flue gas during** the transition to oxygen-fired status, and to discharge flue gas during normal shutdown **when the boiler is in oxy-combustion mode.** In addition, the **second vent** would discharge non-condensable gases during normal operation **and non-condensable gases and CO₂ during times when the produced CO₂ does not meet quality standards or when the pipeline or injection wells are not available for storage operations.**

The steam cycle and balance of plant includes the steam turbines, condensers, and cooling towers. The major components of the existing Unit 4 steam cycle and **portions of the** balance of plant would be incorporated into the project. The steam cycle and balance of plant look much like those found in a conventional air-fired plant, where steam is used to drive the turbines to generate electricity. Main steam from the new boiler would flow through the existing steam-turbine generator. The existing condensate and feedwater systems would be integrated with the gas quality control system, air separation unit, and compression and purification unit islands to provide heating and cooling requirements for those islands. Condensate and feedwater would be deaerated, and cooling water would be used to condense the steam. The proposed system would have three separate cooling water loops and associated cooling towers: the main cooling tower, the cooling tower for the air separation unit and compression and purification unit, and the direct contact cooler polishing **system** cooling tower.

Any coal-fired **power plant** takes some time to start, and the startup sequence for the air separation and compression and purification units increases that time. For cold starts, a new auxiliary boiler would operate to provide steam needed for startup until the main boiler can supply the steam. The auxiliary boiler would most likely be oil-fired. The auxiliary boiler would generate steam for the main boiler

¹ Circulating dry scrubber – flue gas desulfurization technology that uses hydrated lime (dry calcium hydroxide) as the absorbent to remove sulfur dioxide, sulfur trioxide, hydrochloric acid, and hydrofluoric acid.

condensate system, balance of plant, and air separation unit functions. Once the oxy-combustion boiler is started, enough steam would be available within a few hours to allow shutdown of the auxiliary boiler.

The project would reuse the Unit 3 electrical service in the existing 138 kilovolt (kV) substation to supply electricity to the new Unit 4 transformer. Potential modifications may be required within the existing substation to make the connection for the oxy-combustion facility, but no expansion of the substation would be required for the FutureGen 2.0 Project. Therefore, any substation modifications and the new aboveground feed to the Unit 4 transformer would occur entirely within the existing developed areas of the energy center and are addressed as part of the overall construction activities for the FutureGen 2.0 Project.

Compression and Purification Unit

In the compression and purification unit, the flue gas (mostly CO₂) from the boiler would be compressed, additional contaminants removed, and the compressed and liquefied CO₂ pumped to the pipeline. The pipeline would transport liquefied CO₂ to the underground CO₂ storage area. As shown in Figure 2-11, remaining gases that are not easily condensed (i.e., “noncondensibles”) would be vented through the stack; this stream would consist primarily of argon, CO₂, nitrogen, and oxygen. **At certain times, such as during startup of the compression and purification unit or as a result of unavailability of the pipeline or injection well operations, the CO₂ stream exiting the compression and purification unit could bypass the CO₂ pipeline and vent to the ambient air through the exhaust stack, along with the noncondensable gases (see further discussion in Section 2.4.4.2).**

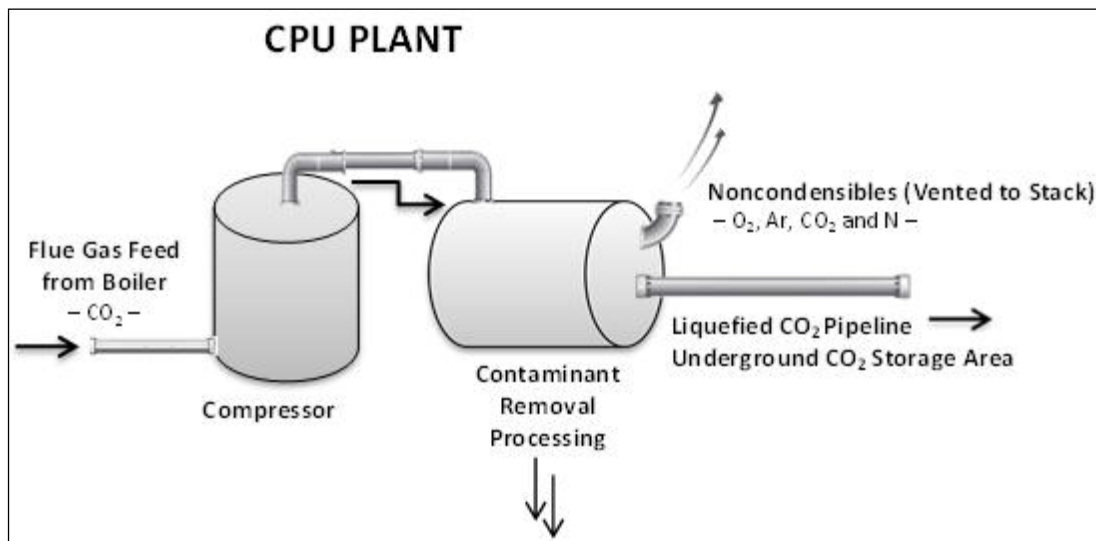

Ar = argon; CO₂ = carbon dioxide; CPU = compression and purification unit; N = nitrogen; O₂ = oxygen

Figure 2-11. Basic Compression and Purification Process

2.4.2.2 Additional Equipment and Systems

Access Roads

The project would require new access roads and improvements to existing roads to the energy center site, as shown in Figure 2-12. The existing access road from the barge unloading area would be improved and widened. Roads within the energy center property currently not within a roadbed would be paved with asphalt. The remaining roads on the outer perimeter of the property would be gravel-based. The roads would be designed to handle maximum loads during construction and operation.



Figure 2-12. Proposed Access Roads

Cooling Tower Systems

The FutureGen 2.0 Project would have three separate cooling water loops and associated cooling towers: the main cooling tower, the cooling tower for the air separation unit and compression and purification unit, and the direct contact cooler polishing system cooling tower. Cooling towers are devices that remove heat captured by the cooling water by transferring the heat from the water to the atmosphere through evaporation.

The main circulating water system would provide a continuous supply of cooling water from the main steam condenser and the closed cooling water system. Water chemistry within the circulating water system would be maintained through chemical injection and system blowdown rates. Blowdown is water that is removed from the cooling water loop to prevent excessive concentration of minerals or other pollutants in the water. The main cooling tower would reject cycle heat from the main condenser and closed cooling water system to the atmosphere; main tower blowdown would be directly discharged to the Illinois River. The existing main cooling tower would be replaced with a new superstructure constructed on the existing **Unit 4 cooling tower basin**.

The cooling tower for the air separation unit and compression and purification unit would reject cycle heat from the air separation unit and compression and purification unit island closed cooling water systems to the atmosphere. Blowdown from this cooling tower would be directly discharged to the Illinois River, **and would be dechlorinated when necessary using sodium bisulfate when necessary to meet the NPDES permit limits for chlorine residual**. This cooling tower would be built over a **new** concrete cold-water basin, with a pump pit and **pumps**. Water chemistry within the circulating water system would be maintained through chemical injection and system blowdown rates.

The direct contact cooler polishing system's cooling tower would reject cycle heat to the atmosphere. Blowdown from this tower would be directed to the new onsite wastewater treatment system for the **direct contact cooler polishing system**. This cooling tower would be built over a common concrete cold-water basin, with a pump pit and pumps. Water chemistry within the circulating water system would primarily be a function of the direct contact cooler polishing system and the circulating dry scrubber operating conditions, but could be controlled when necessary through additional chemical injection and blowdown.

Groundwater Wells

Groundwater would be used for steam cycle demineralizer influent, coal-handling dust suppression, fire protection (in addition to the public water supply), and potable water. Wells 3, 4, and 5 would be removed and one new well would be constructed. Figure 2-8 shows three possible locations for the new well. There would be three wells operating during the project: existing Wells 6 and 7 and the new well.

Process Water Treatment System

The Illinois River would be the primary source of makeup water for the proposed project. Depending upon the final use of the makeup water, water withdrawn from the river **would be screened and passed through strainers to remove debris, and** could be **further** treated through new process water treatment systems that employ clarification, ultrafiltration, and reverse osmosis.

In the clarification process, solids would be removed from the water through chemical treatment and physical settling of particles in a series of tanks. Clarification equipment would include a reaction tank, solids contact clarifier, and filter presses for sludge dewatering. Ferric chloride and polymer would be used for the purposes of coagulating and flocculating solids in order to facilitate settling in the clarifier. By-products of the clarification process would include sludge, which would be processed into filter cake (a chemically fixed sludge that is approximately 50 percent solids). It is expected that the filter cake sludge would be non-hazardous (i.e., pass the USEPA's toxicity characteristics leaching procedure test) and disposed of in a commercial landfill.

Ultrafiltration and reverse osmosis could be employed to treat certain water streams. These technologies are able to provide high quality finish water through the removal of solids and ions that can cause undesirable effects. Chemical reagents may also be used in these processes including sodium hydroxide, acid, caustic, antiscalant, sodium **bisulfite**, and detergents. By-products would include wastewater from backwashing filters, reverse osmosis rejection water (i.e., raw water that does not pass through the treatment unit), and rinses from **periodic** chemical cleaning of reverse osmosis units. It is anticipated that waste from chemical cleaning of these units would be **collected and** processed at offsite commercial facilities.

Process Wastewater Treatment Systems

The proposed project would include **three** separate wastewater treatment systems. The first wastewater treatment plant would treat condensate from the compression and purification unit, which would be **neutralized** using sodium hydroxide **or another caustic agent** for pH adjustment. **A portion of the neutralized effluent would be used to condition fly ash, which would be disposed of offsite. The remaining effluent would be pumped to the wastewater system for the direct contact cooler polishing system effluent where it would receive further treatment.**

The second wastewater treatment system would treat cooling tower blowdown from the direct contact cooler polishing system and effluent from the compression and purification unit wastewater treatment plant. This treatment system would use physical and chemical treatment to remove suspended solids and metals and would use biological treatment to remove mercury, selenium, and nitrates from the wastewater. Metal precipitation would be accomplished using a two-stage process, using hydroxide precipitation and then sulfide precipitation. The precipitated solids would be removed from the wastewater in a clarification process followed by filtration. The solids contained in the clarifier blowdown would be thickened and dewatered for offsite disposal. The treated effluent would be discharged to the Illinois River at Outfall 002 (see Section 2.4.1.3) in compliance with an NPDES permit.

The third treatment system would treat wastewater and stormwater runoff from the coal pile area including coal handling equipment wash-down water, coal handling dust suppression wastewater, and coal pile runoff. The coal handling and contact runoff treatment system would also treat stormwater potentially impacted by industrial activities in other areas of the energy center. The treatment system would consist of three components: a lined detention basin, a clarifier, and a neutralization tank. The main purpose of the detention basin would be to store wastewater so that it could be pumped at a metered rate to the clarifier. Chemical reagents including flocculants and polymers may be used in the clarifier to increase settling, while hydrated lime would be used for pH adjustment in the neutralization tank. Solids from the clarifier would be combined with solids recovered from the wastewater treatment system for the direct contact cooler polishing system, dewatered, and disposed at a licensed commercial waste facility. Effluent from the coal handling and contact runoff treatment system would be discharged to the Illinois River at Outfall 002.

Stormwater Management

Stormwater from the energy center would be directed to either **the coal handling and contact runoff treatment system** or **an existing stormwater detention area**, depending upon where the stormwater originates. Runoff would be conveyed **to each of these facilities** using surface drainage; however, it is likely that some newly constructed stormwater inlets and underground storm sewers would be required.

Stormwater runoff exposed to coal storage (including coal pile runoff, coal handling dust suppression water, coal handling equipment wash-down water, and stormwater from the coal yard) and stormwater potentially exposed to industrial activities would be diverted to the coal handling and contact runoff treatment system. The treated effluent would be discharged from the wastewater treatment system to the Illinois River. The detention basin for the coal handling and contact runoff treatment system has not yet been designed, so the required size, depth, and retention

time have not yet been determined for this feature. The Alliance designated the area where the detention basin is expected to be sited. The basin would be constructed on a portion of this site and would not encompass the entire area. The site where the detention basin would be constructed and the location of the existing stormwater detention area are shown on Figure 2-13.

Stormwater runoff not exposed to industrial pollutants would be directed to **the existing stormwater detention area** that would be managed by Ameren. **This detention area would store noncontact, non-industrial stormwater runoff (i.e., stormwater runoff not exposed to industrial pollutants).** The collected water would naturally evaporate and infiltrate into the groundwater system. **The location of the existing stormwater detention area is depicted on Figure 2-13.**

2.4.3 Oxy-Combustion Large Scale Test Construction Phase

Construction activities at the Meredosia Energy Center property would begin in 2014 and conclude in 2017 when the project would become operational. Proposed site preparation and construction activities would implement conventional construction methods, and would utilize best management practices (BMPs) to mitigate potential environmental impacts. Construction-related environmental concerns would be typical of those associated with a large industrial construction project and would primarily be related to air emissions, construction traffic, fugitive dust emissions from site disturbance, and stormwater runoff from construction areas. The Alliance would obtain all necessary permits and comply with all regulatory requirements during construction, which are intended to minimize potential concerns about health, safety, and environmental protection.

Figure 2-14 shows temporary and permanent impact areas at the Meredosia Energy Center property, as well as the potential impact area for a barge unloading facility **as presented in the Draft EIS**. Temporary impact areas refer to those areas that would be restored to their original state with some potential modifications (e.g., planted trees instead of mature trees) at the end of the construction phase, which could be years after the areas are initially impacted. Permanent impact areas are those that would be changed permanently from their prior uses. Existing habitat in permanent impact areas would be lost, and replanting as practicable would be consistent with the permanent uses designated for those areas. Up to 68 acres of land would be temporarily disturbed during project construction (which includes the barge impact area) and up to 96 acres of land would be permanently altered, **much of which has already been disturbed by prior activities at the energy center. As described in the Draft EIS, the original siting plans and layouts would have required the clearing of approximately 33 acres of forested land.**

Through ongoing refinements in siting plans by the Alliance, and in response to concerns of the U.S. Department of Interior, Fish and Wildlife Service (USFWS), about the loss of forested acreage (see Comment USDOI-02 in Appendix I, Public Comments on the Draft EIS [I2]), the Alliance took steps to reduce the amount of forested land that would be cleared for the project. Based on current plans, it is estimated that impacts could range from less than 1 acre to as many as 9 acres of forested lands depending on the availability of construction areas at the Meredosia Energy Center. Figure 2-15 illustrates the revisions to the temporary and permanent impact areas at the Meredosia Energy Center property that would result given the Alliance's refined plans. If future design modifications would cause additional impacts to forested land beyond those presented in Figure 2-15, DOE and the Alliance would consult further with the USFWS. In any case, the acreage of impacted forest land would not exceed that analyzed in the Draft EIS and presented in Figure 2-14.

The designated barge impact area is the area that would potentially be disturbed during offloading of heavy and large equipment from barges during the construction phase. The existing boat ramp area just north of the property boundary would be used to facilitate the movement of large equipment that would be shipped to the project area. The use of this boat ramp area may require the construction of a temporary barge unloading facility on the Illinois River as discussed in Section 2.4.3.2. For the purposes of this EIS, it has been assumed that a temporary barge unloading facility would be constructed. An existing gravel

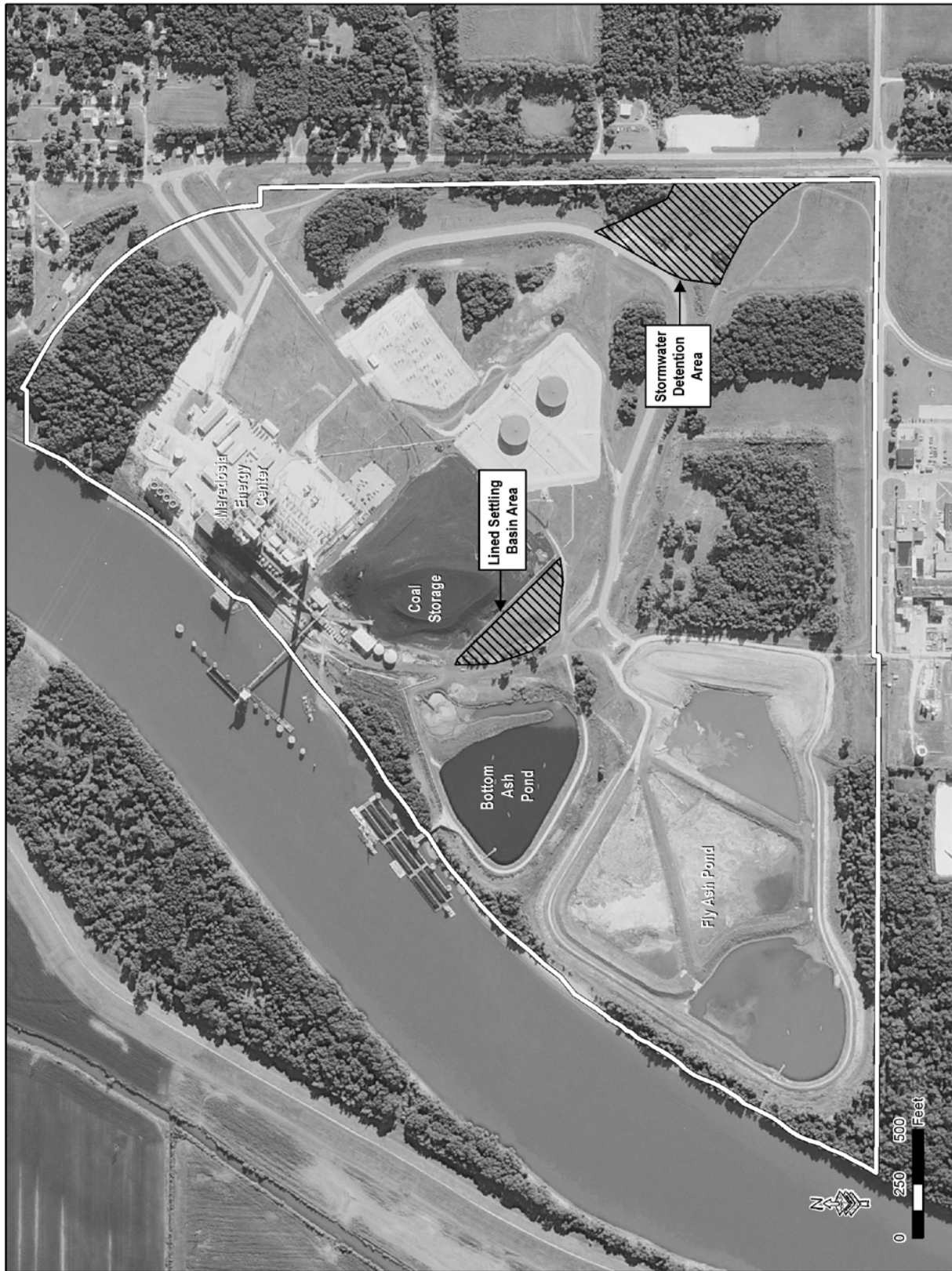

Figure 2-13. Stormwater Management



Figure 2-14. Temporary and Permanent Impact Areas at Energy Center, as Evaluated in the Draft EIS



Figure 2-15. Revised Temporary and Permanent Impact Areas at Energy Center, Reflecting Current Plans

road that connects the boat ramp area to the main facilities at the energy center would be improved to handle the transport of heavy and large equipment or modules for the project. There may be two or more scheduled timeframes of barge unloading events, each resulting in short-term impacts lasting for approximately 1 to 3 months. After the construction phase, the area would be restored to its original state.

Electricity needs during construction would be provided by the public electrical grid to be spot-supplemented by portable generators. Construction water needs would be met by the existing Meredosia Energy Center water supply. During the construction phase, the Alliance would provide potable water, portable toilets, and hand-wash stations for construction workers.

2.4.3.1 Oxy-Combustion Facility Construction

Initial site preparation activities at the energy center site before construction would include demolition activities, such as the demolition of Boiler 6, groundwater wells, and some warehouses. Additionally, the superstructure of the main cooling tower would be replaced. Following the demolition activities, the Alliance would conduct site clearing, grading, and excavation, and prepare foundation work for erecting the new structures. New roads would be constructed to handle the transport of materials and waste (see Figure 2-12). The new structural features at the energy center site are shown in Figure 2-8.

The following list summarizes the major construction components of the proposed project:

Oxy-Combustion Facility

- Relocate several existing warehouses, a deaerator, and one of the condensate storage tanks, to make room for new oxy-combustion facility components.
- Demolish the existing Unit 4 boiler (Boiler 6).
- Construct a new oxy-combustion boiler (Boiler 7). The height of the new oxy-combustion boiler building, which would be built at the general location of the existing Boiler 6, would be approximately 180 feet. It would be 29 feet shorter than the height of the existing adjacent building.
- Construct the air separation unit. The tallest structure in the air separation unit, the cold box, would be approximately **120** feet tall.
- Construct the compression and purification unit.
- Construct a new approximately 450-foot tall concrete exhaust stack. The stack would have an outer reinforced concrete shell with a fiberglass reinforced plastic inner shell liner. The stack would have aviation lighting, including two levels of three medium intensity strobe lights.

Coal Handling System

- **Construct an extension of existing unloading system to discharge coal to the drag chain conveyor, which discharges coal into the boiler's coal silos.**

Electrical and Control Systems

- The project would require a number of existing overhead transmission and distribution lines to be re-routed to free up space for the new project equipment. New electrical equipment and connections would be installed to provide power to the various components of the new oxy-combustion facility.
- Demolish existing onsite transmission towers and construct new towers to re-route existing lines. The new towers would be comparable in size and height to the existing towers.

Access Roads

- Construct new access roads to the energy center property, and improve and widen the existing barge unloading roadway. Figure 2-12 shows these new roadways and indicates where they would tie into existing roadways. All roads would typically be 20 feet wide, except for the barge unloading road, which would be 40 feet wide. None of the areas for roadway construction would require major vegetation removal. Roads within the energy center property would be paved with asphalt, and roads on the outer perimeter would be gravel. Roads would be designed to handle maximum loads.

Water and Wastewater Systems

- Decommission three existing water supply wells (Wells 3, 4, and 5) and install a new replacement well for groundwater supply to the project. The potential locations of the new replacement well are shown in Figure 2-8.
- Replace existing main cooling tower with a new tower at the same location. The new tower would be constructed on the existing **cooling tower** basin.
- Construct two additional cooling towers, one for the direct contact cooler polishing **system**, and one for the air separation unit and compression and purification unit. Each tower would be built over a concrete cold-water basin, with a pump pit and pumps **provided on one side**. The direct contact cooler polishing system cooling tower would be **approximately** 30 feet high, while the **cooling tower for the air** separation unit and compression and purification unit would be **approximately** 32 feet.
- Construct new process water and wastewater treatment systems.

2.4.3.2 Temporary Barge Unloading Facility

The Alliance plans to use the area between the existing boat ramp area to the north of the energy center (see Figure 2-4 labeled 'Public Boat Ramp Area,' and Figures 2-14 and 2-15 labeled 'Barge Impact Area') to unload a number of large equipment modules for the oxy-combustion facility. These modules would be constructed offsite and sent by barge on the Illinois River. The boat ramp area is owned by the village of Meredosia and has two boat ramps. Only one of the boat ramps would be needed to offload the modules. There are two exits from the boat ramp area to the village, only one of which would be obstructed during barge unloading. Additional phases of project engineering and coordination with the village of Meredosia would be required to determine further accessibility arrangements, but the Alliance expects to ensure that at least one of the boat ramps remains open for public access during project construction. There is a possibility that the movement of equipment from the boat ramp to the energy center would take place the day after delivery, but the parking lot associated with the boat ramp area is large enough to enable temporary staging of equipment overnight without affecting public use of the boat ramp area. A former campground near the boat ramp area is no longer in use. There are no plans to stage or place construction material, debris, or waste at or near the boat ramp area from any FutureGen 2.0 Project construction activity. It is anticipated that impacts to the boat ramp area would be short term, lasting between 1 to 3 months during each of several construction unloading timeframes. It is expected that unloading activities related to construction of the oxy-combustion facility would begin in **2015** and conclude **by 2017**.

The Draft EIS evaluated two options for the barge unloading operations: (1) using mooring dolphins (freestanding structures above the water line used to secure vessels with ropes) to temporarily anchor the barge or (2) grounding the barge on the river bottom. Both of these options would involve some level of disturbance to the river bottom; however, no dredging activities are expected for either option. The first option would require the installation of three to five mooring dolphins in the river channel. The mooring dolphins would be placed at regular intervals such that the group would extend 100 feet out into the river.

These dolphins might include individual timber pilings or metal pilings driven into the river bottom. It is expected that these pilings would be less than 48 inches in diameter, but the piling size, and therefore the pile driving hammer size, is unknown at this time.

The second option would require that areas of the river bottom where the barge would be grounded be prepared by removing any large objects that may puncture the barge. If necessary, rip-rap or other suitable material would be placed on the river bottom to provide a foundation for the barge and prevent damage and continuing streambed impacts. If the Alliance elects to implement one of these two options, they would be installed by the first quarter of 2014 and removed after the last module is unloaded.

The Alliance is also evaluating options for unloading equipment that would avoid potential impacts by using a combination of on-shore equipment, tugs, and temporary ramps so that there would be no disturbance to the bank or bottom of the Illinois River. However, these plans are still under development and being reviewed for their feasibility. Under this scenario, a portion of the temporary ramp may extend into the river to form a usable platform between the edge of the barge and the existing boat ramp. This temporary ramp might extend 20 feet from the shoreline although it has not yet been defined. **Because the Alliance has not thoroughly determined the feasibility of this alternative scenario or developed a preliminary design, the Final EIS considers the impacts presented in the Draft EIS as representing appropriate, upper bounds for the barge unloading operations during construction of the oxy-combustion facility.**

Although the actual dimensions of the barge have not been finalized, it is estimated that the barge would be 255 feet long and 72 feet wide with a 4-foot draft. Once the barge is moored, the module would be unloaded using a roll-off heavy hauler and a series of dollies. The dollies would move the modules to temporary cribbing and then to the boat ramp itself via a temporary ramp. The heavy hauler would then proceed south to the energy center via the barge unloading access road, an existing gravel road that would require some improvements. Barges would not be moored for an extended period. It is anticipated that each module would take up to 24 hours to unload, though this is only an approximation as the barge unloading activities have not yet been planned in detail.

2.4.3.3 Construction Schedule and Workforce

The construction phase for the oxy-combustion facility at the Meredosia Energy Center, including initial demolition, is estimated to occur over a period of approximately 42 months beginning in 2014 and extending through 2017. However, construction would be substantially completed within 30 months, and the last 12 months of construction would overlap with a 1-year commissioning and startup effort. The number of construction and craft workers onsite would range from 100 to 200 for the first 7 months, 300 to 400 for the next 8 months, and 450 to 500 at peak for the next 8 months. Beginning with the 24th month, the onsite construction staff would reduce to approximately 300 for 8 months, then decline to between 50 and 200 for the final 11 months. The numbers of additional construction workers associated with the pipeline, CO₂ injection wells, and educational facilities are discussed in Section 2.5.

2.4.3.4 Construction Materials and Waste

Raw Materials and Delivery

Box trucks would carry various equipment and consumables, including welding supplies, crane rigging, control valves, small pumps and instruments, and control cable. In addition, many other miscellaneous items would be transported to the site via box truck. Approximately 40 box truck deliveries would be required and would originate from numerous locations.

Flat-bed trailers hauled by semi-tractors would transport major equipment and supplies, including the chemical feed systems, supplies for site preparation, pre-cast sewer sections, transformers, motor control centers, switchgear, large pumps and supports, duct bank sections, pre-fabricated tanks, air compressors, grating and handrails, miscellaneous support steel, cooling tower structural components and fans, and all cast iron and high density propylene piping sections. Additional equipment and supplies may also be

delivered by flat-bed trailer. Approximately 270 flat-bed tractor-trailer deliveries would be required and would originate from numerous locations.

The Alliance anticipates that pre-mixed concrete would be delivered from a local source via concrete trucks; however, the use of an onsite batch plant would also be evaluated. The batch plant would be temporary and would be located in one of the laydown yards close to the energy center. In this case, concrete would be delivered via concrete mixer truck from the batch plant. Approximately 360 truckloads would be required to deliver concrete to the site.

Dump trucks would be required for the site preparation effort during the early construction phase. Fill material would be procured locally whenever possible. Approximately 600 dump truckloads may be required to import gravel, road base, and other fill material to the site.

Equipment for the boiler and gas quality control system would be delivered from a variety of sources. Babcock & Wilcox estimates that equipment delivery would require approximately 12 barges, 350 full truckloads, and 200 to 400 shipments of less than a full truckload.

Equipment for the air separation unit and compression and purification unit would be fabricated and pre-assembled offsite to reduce trucking requirements. Air Liquide estimates that modules would be transported by two river barges to Meredosia. Seven transporters would be required to move the modules from the barge unloading area to the construction site. Approximately 30 additional truck deliveries would be required to bring associated materials to the Meredosia site.

A summary of power consumption ranges for the construction and startup of the project is provided below. These estimates were developed based on previous projects or historical information provided by the project proponents:

- Balance of plant: 2,555 to 7,665 megawatt hours (MWh)
- Boiler: 5,291 to 15,873 MWh
- Gas quality control system: 3,108 to 9,323 MWh
- Air separation unit: 5,705 to 17,115 MWh
- Compression and purification unit: 4,314 to 12,942 MWh
- Total: 20,973 to 62,918 MWh

Material Wastes and Wastewater

Construction of the proposed project would generate typical construction wastes. The predominant waste streams would include industrial equipment and associated components from the demolition of Boiler 6; clearing vegetation, soils, and debris; used lube oils; surplus materials; and empty containers. Solid wastes (i.e., garbage and rubbish) would be collected for disposal in a licensed offsite solid waste facility (i.e., a public landfill). Scrap and surplus materials and used lube oils would be recycled or reused to the maximum practicable extent. Temporary sanitary facilities (i.e., portable toilets and hand-wash stations) would be placed in appropriate locations at the construction sites for use by construction workers. These self-contained portable units would be serviced regularly and the wastes would be collected and hauled to permitted sewage treatment facilities by licensed waste transporters.

Stormwater in areas that currently drain to the bottom ash pond or fly ash pond at the Meredosia Energy Center would continue to be directed to these treatment basins, assuming that the NPDES operating permit authorizes such discharges. In areas where stormwater cannot be routed to the bottom ash pond or fly ash pond, the Alliance would obtain a general NPDES permit (ILR10) from the IEPA to authorize discharges of stormwater during construction. BMPs would be utilized to reduce sediment discharged via stormwater runoff. These BMPs would be described in a Stormwater Pollution Prevention Plan (SWPPP)

required by the general NPDES permit. These BMPs may include measures such as silt fencing, inlet drain protection, ditch checks, designated concrete washout areas, vegetated buffer strips, and other measures.

The Alliance would ultimately be responsible for the proper handling and disposal of construction wastes. However, construction contractors and their employees would be responsible for minimizing the amount of waste produced by construction activities. These contractors would be expected to fully cooperate with project procedures and regulatory requirements for waste minimization and the proper handling, storage, and disposal of hazardous and non-hazardous wastes. Each construction contractor would be required to include waste management in their overall project health, safety, and environmental site plans. Typical construction waste management activities may include the following:

- Dedicated areas and a system for waste management and segregation of incompatible waste at time of generation;
- A waste control plan detailing waste collection and removal from the site, as well as identification of where waste of different categories would be collected in separate stockpiles, bins, or other containers;
- Hazardous waste storage (separately from non-hazardous waste and other, non-compatible hazardous waste) in accordance with applicable regulations, project-specific requirements, and good waste management practices;
- Periodic inspections to verify that wastes are properly stored and covered to prevent accidental spills and to prevent waste from being dispersed by wind;
- Appropriately labeled waste disposal containers; and
- Good housekeeping procedures to ensure that work areas would be left in a clean and orderly condition at the end of each working day, with surplus materials and wastes transferred to the waste management area.

2.4.3.5 Construction Safety Policies and Programs

Emergency services during construction would be coordinated with the local fire departments, police departments, paramedics, and hospitals. A first aid office would be provided onsite for minor incidents. Trained and certified health, safety, and environmental personnel would be onsite to respond to and coordinate emergencies. All temporary facilities would have fire extinguishers; fire protection would be provided in work areas where welding work would be performed. In addition, existing Ameren plans and policies applicable to the Meredosia Energy Center regarding environmental safety and health would be updated as necessary by the Alliance to accommodate the proposed project.

2.4.4 Oxy-Combustion Large Scale Test Operation Phase

A variety of factors could affect the possible long-term operation of the oxy-combustion facility, including potential future GHG legislation and regulations, process performance, and economics. For purposes of this EIS, DOE assumed the project would continue to operate for 20 years.

2.4.4.1 Resource Requirements and Inputs

Operational Labor

All operations at the Meredosia Energy Center were suspended in 2011. During its final year of operation, the energy center employed approximately 57 personnel. The proposed project would employ 87 to 115 people and operate 24 hours per day, 7 days per week, with employees working in shifts. Staff would include 25 operational personnel, 4 to 8 gas quality control system personnel, 4 to 16 air separation unit personnel, 4 to 16 compression and purification unit personnel, 7 coal handling personnel,

24 maintenance personnel, 11 administration and support personnel, and 8 laborers and store clerks. All new staff would be based at the Meredosia Energy Center.

Process Inputs

During operation of the project, process-related chemicals would be transported to the Meredosia Energy Center mainly by truck. The new boiler would be able to accommodate a coal blend of 60 percent Illinois coal and 40 percent Powder River Basin coal. Illinois coal would be transported to the energy center by truck and Powder River Basin coal would be transported by barge. The oxy-combustion facility would require the input of two reagents: trona and lime. Table 2-4 presents the estimated usage and delivery requirements for the process inputs to the oxy-combustion facility. **These values have been updated to reflect the most current design, which involves slightly increased quantities of process-related materials. See additional discussion of a potential offsite coal blending and delivery option in the following subsection (Coal) as added to the Final EIS.**

Table 2-4. Estimated Process Material Requirements for the Oxy-Combustion Facility

Material ^{a,b}	Tons/Day ^a	Tons/Year ^a	Daily Deliveries ^a	Annual Deliveries ^a
Bituminous Coal (IL No. 6) (60 percent)	1,224	446,760	49	17,870
Sub-bituminous Coal ^b (Powder River Basin) (40 percent)	816	297,840	<1 ^c	180
Hydrated Lime	187	68,219	7	2,729
Trona	8.9	3,241	<1 ^c	130

^a. Estimated values in this table have been updated to reflect project design changes since publication of the Draft EIS.

^b. All materials delivered by 40-ton truck (25-ton load) except sub-bituminous Powder River Basin coal, which would be delivered by barge (1,650-ton load).

^c. Trips would not be made daily.

The major process chemicals that may be used for the new process water and wastewater treatment systems include ferric chloride, polymer, salt solution, sodium hydroxide, acid, caustic, antiscalant, sodium bisulfate, detergent, and sodium hydroxide. Process water would primarily be supplied by the Illinois River. The amounts of materials stored at the facility would be determined by the rates of consumption, customary delivery volumes available from suppliers, and the reliability of supply. In addition to regulatory requirements, the Alliance would follow the chemical suppliers' recommendations and procedures in storing and handling all chemicals.

Coal

During operation of the project, Boiler 7 would burn a blend of 60 percent Illinois No. 6 bituminous coal and 40 percent Powder River Basin sub-bituminous coal. Coal mine sources that may provide bituminous coal for the proposed project include the Viper Mine, Crown 3 Mine, and Shay Mine in Illinois, which are all located approximately 75 to 85 miles from Meredosia. Yard machines (dozers, scrapers) would form the bituminous coal into a pile and would also be used to transfer coal from this pile to the existing reclaim hopper, which would feed into existing Conveyor A (see Figure 2-5). Conveyor A would direct the reclaimed coal to the breaker building for processing and sizing.

Powder River Basin coal originates from the Powder River Basin in Wyoming and would be transported by rail to St. Louis, Missouri. The coal would be transported from St. Louis to the energy center via barge. The existing barge unloading system would be used for maintaining the Powder River Basin coal pile inventory for Unit 4. The coal would be unloaded from the barge via a clamshell bucket into the barge unloading hopper. After the coal is unloaded from the barge, it would be transported via Conveyor E to the coal breaker building for further processing.

As a result of the ongoing refinements in the design for the FutureGen 2.0 Project, the Alliance is considering the option of having the Illinois No. 6 bituminous and the Powder River Basin sub-bituminous coal types blended (60 percent and 40 percent, respectively) by an existing commercial coal handling facility in St. Louis. This alternate approach could replace the plan for onsite blending of coal, as described in the Draft EIS. In the event that this approach is taken, the blended coal would be delivered by barge from St. Louis, like the Powder River Basin coal deliveries. In comparison to the estimated deliveries for coal summarized in Table 2-4, the delivery of blended coal by barge could result in an increase of approximately 451 annual deliveries; one or two barge deliveries per day. This approach would correspondingly reduce the number of daily truck deliveries for Illinois No. 6 bituminous coal to a potential minimum of no coal truck deliveries to the energy center. The Alliance has not yet identified a specific commercial coal handling facility to support this delivery option.

Trona

Trona is a naturally-occurring hydrated sodium carbonate mineral (sodium sesquicarbonate) that is used in the gas quality control system (injected upstream of the baghouse) to reduce sulfur trioxide concentrations in the flue gas. It is also used in the direct contact cooler polishing system to reduce sulfur dioxide. The proposed system would consume trona at rates shown in Table 2-4. Dry trona would be delivered to the site by trucks that would be equipped with blowers for offloading. The trona would be stored in a shop-fabricated, skirted-design storage silo that would be 14 feet nominal diameter by 77 feet overall height.

Hydrated Lime

Dry calcium hydroxide, also known as hydrated lime, would be used as the absorbent in the circulating dry scrubber for removal of acid gases (sulfur dioxide, sulfur trioxide, hydrogen fluoride, hydrochloric acid, etc.). The proposed system would consume hydrated lime at the rates shown in Table 2-4.

Material Deliveries

Table 2-4 summarizes the delivery requirements for all major process materials. With the exception of Powder River Basin coal, all materials would be delivered by 40-ton trucks with capacity to transport 25 tons of material. Each barge delivery would transport 1,650 tons of Powder River Basin coal. Truck deliveries would generally take the “south bypass road,” which is signed as the Meredosia Energy Center entrance on IL-104.

Water Consumption

Water sources for the project’s makeup water would include well water, public water supply, and the Illinois River. There would be three wells used during operations (existing Wells 6 and 7 and a new well). Well water would be used for steam cycle demineralizer influent, coal handling dust suppression, fire protection (in addition to the public water supply), and potable water. The public water supply would be used for fire protection makeup water and Unit 4 floor wash; the existing fire protection water storage tank capacity is 325,000 gallons and is not expected to increase for this project. The use of the public water supply as potable water may be evaluated in the future.

The Illinois River would be the primary source of makeup process water and would require additional treatment at the new process water treatment system as discussed in Section 2.4.2.2, depending on its final use. River water would provide for the following uses:

- Screen and strainer backwash;
- Makeup water for the Unit 4 main cooling tower;
- Makeup water for the direct contact cooler polishing system cooling tower;
- Makeup water for the air separation unit and compression and purification unit cooling tower;

- Gas quality control system makeup water;
- Process water for the air separation unit and the compression and purification unit;
- Equipment cooling; and
- Equipment washdown.

Table 2-5 summarizes the water sources and uses for operation of the oxy-combustion facility. **These values have been updated from the Draft EIS to reflect the most current design, which involves slight increases in water use from the Illinois River and the public water supply.**

Table 2-5. Estimated Water Requirements and Sources

Source	Flow Rate (gpm)	Flow Rate (gpd)	Purpose
Illinois River Intake	9,410	13,551,000	Process water, coal handling, other
Groundwater Wells	86 ^a	124,000 ^a	Potable water, fire protection ^b , other
Public Water Distribution System	3	5,000	Fire protection ^b , maintenance, potable water

^a This groundwater flow rate reflects the design presented in the Draft EIS to serve as an upper bound; however, current design indicates that groundwater withdrawal would be reduced from this value.

^b Water for fire protection would be supplied by both the public water system and onsite groundwater wells.

gpd = gallons per day; gpm = gallons per minute

Fuel Consumption and Auxiliary Power

The auxiliary electric power demand to operate the oxy-combustion facility would total 68,721 kilowatts (kW). This includes auxiliary power for the boiler, gas quality control system, air separation unit, compression and purification unit, and balance of plant (new equipment, existing reused equipment, and auxiliary transformer losses).

2.4.4.2 Process Wastes, Discharges, and By-Products

Material Wastes and By-Products

The operation of the project would generate various wastes. These would include fly ash, bottom ash, circulating dry scrubber wastes, process water and wastewater treatment solids, and waste petroleum-based lubricants. Fly ash and bottom ash would be the predominant wastes generated by the project. Waste generation rates for fly ash and bottom ash are provided in Table 2-6. **These values have been updated to reflect the most current design, which involves slightly increased quantities of certain wastes.** Water and wastewater treatment solids would be generated at a rate of approximately 0.28 tons per day (see Section 2.4.2.2 for identification of waste solids generated by the proposed process water treatment system and wastewater treatment system), and waste lubricants would be generated at a rate of approximately 1,000 gallons per day (gpd). These waste types would be transported offsite for disposal.

Table 2-6. Estimated Process Waste Generation

Material	Tons/Day	Tons/Year	Daily Removals ^a	Annual Removals ^a
Fly Ash ^b	538	196,334	22	7,853
Bottom Ash ^c	37	13,578	1	543

^a All wastes removed by 40-ton trucks (25-ton waste capacity).

^b Fly ash includes circulating dry scrubber waste. **Note that refinements in the oxy-combustion design since publication of the Draft EIS incorporate reuse of the fly ash in the system processes, thereby resulting in a reduction in fly ash waste from 538 (in the Draft EIS) to 480 tons per day, and an associated reduction in daily truck trips from 22 to 19. However, this Final EIS maintains the original fly ash production quantity as an upper bound for impact analysis.**

^c Estimated values for bottom ash have been updated to reflect project design changes since publication of the Draft EIS.

Bottom Ash

Bottom ash would be generated at rates shown in Table 2-6. The bottom ash removal system would consist of a transition chute, submerged chain conveyor with water recirculation pumps, sludge pumps, and heat exchangers. Bottom ash would be removed from the combustor and would be stored in the ash bunker until being transferred to trucks that would transport it to an offsite landfill (see below, Ash Disposal).

Fly Ash

The ash handling system transfers the fly ash collected by the pulse jet fabric filter (baghouse, located east of Boiler 7) to the waste ash storage silo for disposal. The fly ash would be generated at rates shown in Table 2-6. Fly ash would be stored in the waste ash storage silo complete with bin vent and filter collector before transfer to trucks for transport to an offsite landfill (see below, Ash Disposal). The waste ash silo, which would be equipped with a baghouse, has capacity for 72 hours of operation at the design condition.

Ash Disposal

Ash waste that could not be beneficially re-used would be trucked offsite and disposed of at an existing commercial facility permitted to receive coal combustion residuals. In June 2010, the USEPA proposed to regulate for the first time the coal combustion residuals, or coal ash, generated by electric utilities. Coal combustion residuals are currently considered exempt wastes under an amendment to the Resource Conservation and Recovery Act (RCRA). Two possible options for the management of coal combustion residuals are being proposed under the new rule. Under the first option, USEPA would list these residuals as special wastes subject to regulation under subtitle C of RCRA, when destined for disposal in landfills or surface impoundments. Under the second option, the USEPA would regulate coal ash under subtitle D of RCRA, the section for non-hazardous wastes.² As discussed in Section 2.4.1.5, the existing ash ponds at the energy center would not be part of the asset transfer for the FutureGen 2.0 Project. Environmental liability associated with the existing ash ponds and compliance with current or future regulations remain with Ameren until such time as the property and environmental liability may be transferred to a third party.

General Solid Waste

Routine maintenance of process components (e.g., pumps, valves, etc.) for the oxy-combustion facility is not expected to generate significant amounts of waste. The material removed and waste generated as part of this required maintenance is not expected to be hazardous. Any waste generated would be properly managed and disposed of at a suitable waste disposal facility.

In the event of a process malfunction, more significant maintenance may be required. These events could produce a waste product not considered in the maintenance scenarios above; such wastes may or may not be hazardous. These events would be rare, treated on a case-by-case basis, and not expected during normal operation. The wastes generated as a result of these activities would be handled according to applicable laws and regulations, plant operations and maintenance standards, risk management plans, material safety data sheets (MSDS) recommendations, and other industry or agency standards for proper handling and disposal. These types of emergency events would be addressed in a hazards and operability study prior to operations, such that potential problems and risks are identified, employee awareness is raised, mitigations of risks are implemented, and emergency procedures are effective.

² The comment period for the proposed coal combustion residuals rule closed on November 14, 2011. The rule is still pending, and as such, the resulting regulations issued by USEPA could impact the Alliance's decision on options for its ash disposal (75 FR 35128).

Wastewater Generation

Wastewater generated by the project would include sanitary wastewater, process wastewater, noncontact cooling water, backwash from the intake screen, and oily effluent from floor and equipment drains. Table 2-7 summarizes wastewater generation and disposal during operation of the oxy-combustion facility as described in Section 2.4.2.2.

The Meredosia Energy Center is currently covered under existing NPDES Permit IL0000116. This permit was renewed by Ameren in November 2011 and is currently valid until October 31, 2016. This existing permit would be modified as needed for the FutureGen 2.0 Project; however, no new outfalls would be proposed. Expected effluent pollutants and discharge standards are discussed in Section 3.6, Surface Water. **As a result of changes that have occurred in the project design since the Draft EIS was published, a modified NPDES permit application was prepared and submitted by the Alliance to the IEPA on June 20, 2013. The modified permit application contained revised estimates regarding water withdrawal volumes from the Illinois River, water discharge volumes to the Illinois River, and constituent loads within discharges from several outfalls at the energy center. Table 2-7 has been updated to reflect these refinements.**

All of the river water would continue to pass through the existing intake screens, which are backwashed using a portion of the inlet water. Backwash water would be discharged directly back to the Illinois River through Outfall 006 (see Figure 2-4). The backwash water source is the Illinois River. Under the NPDES permit, the outfall would continue to be monitored for residual chlorine when chlorine is utilized for biofouling control.

Table 2-7. Estimated Wastewater Generation and Disposal

Source	Average Flow Rate (gpm)	Average Daily Discharge (gpd)	Discharge Point
Sanitary Sewage	3.5	5,000	City Sanitary Sewer System
Process Wastewater Treated Effluent	270	388,170	Illinois River
Cooling Water (including blowdown)	6,869	9,892,000	Illinois River
Intake Screen Backwash	208	300,000	Illinois River

gpd = gallons per day; gpm = gallons per minute

Most of the Unit 4 gas quality control system and associated direct contact cooler polishing system liquid waste would be recycled for fly ash wetting or re-evaporated in the flue gas to the maximum possible extent to minimize high chloride waste streams requiring external treatment. Some Unit 4 discharges, such as the main cooling tower blowdown and the air separation unit and compression and purification unit cooling tower blowdown, would be directed without further treatment to the Illinois River. These discharges would consist primarily of river water that has been concentrated due to evaporation in the cooling towers, with some small amounts of various circulating water feed chemicals (e.g. antiscalant, biocide, sulfuric acid, etc.) present. The makeup water portion from the air separation unit and compression and purification unit cooling tower would also have been softened, thereby exchanging sodium for calcium and magnesium ions.

The other Unit 4 wastewater discharges would be treated at **one of** the new wastewater treatment systems prior to release to the river. The collection method, main equipment components, chemical reagents, and by-products for the wastewater treatment systems are described in Section 2.4.2.2; minor quantities of solid wastes would be collected and disposed of offsite. Although water quality data of the new effluent are not known at this time, it is conservatively estimated that the effluent levels would be at the current operating permit limits; however, it is expected that effluent concentrations for most regulated constituents would be significantly lower than permit limits. The discharge permit limits and impacts to water quality are discussed in Section 3.6, Surface Water.

The wastewater streams that have the potential to be contaminated with oil would be routed to oil-water separators for processing. Such streams primarily include floor and equipment drains. **Up to three new oil-water separators would be installed.** The oil-water separators would likely be coalescing plate-type units installed **above** grade level. Clean water effluent from the separators would be pumped to **Outfall 002 (see Figure 2-4) and discharged into the Illinois River.** Separated oil would be contained in the oil-water separators and would be periodically pumped out for offsite disposal.

CO₂ Stream

The project would be designed to recover greater than 90 percent of the CO₂ during steady-state operation that would otherwise be emitted from the combustion process. The compression and purification unit is expected to have a CO₂ capture rate totaling 1.2 million tons per year (1.1 million metric tons per year). Although the exact composition of the CO₂ stream that would be received from the proposed oxy-combustion facility is not known at this time, the pipeline design requires that at a minimum it must meet the specifications discussed in Section 2.5.1.4. The gas would be vented through the stack in the event that the quality requirements could not be met. “Noncondensable” gases that consist primarily of argon, nitrogen, and oxygen would also be vented through the stack. The captured CO₂ stream to be transported for geologic sequestration would include CO₂, inert gases (argon and nitrogen), water vapor, and trace amounts of oxygen, sulfur, and mercury.

Dense phase CO₂ would be delivered from the oxy-combustion facility to a pipeline interface point located near the eastern boundary of the Meredosia Energy Center. An isolation valve would be installed downstream of the compression and purification unit to initiate or shutoff flow to the pipeline, as required. CO₂ flow, pressure, temperature, and quality would be monitored at the compression and purification unit discharge, upstream of the pipeline isolation valve. Monitoring at the pipeline interface point, along with automated control of the isolation valve, would be developed during final design. Remote monitoring capability would also be implemented to allow the Alliance to directly monitor CO₂ conditions at the compression and purification unit discharge.

During operation, if CO₂ conditions do not meet the required specifications, the pipeline isolation valve would automatically close and flow to the pipeline would be stopped. During compression and purification unit startup, shutdown, or other operating condition, when the pipeline isolation valve is shut and no CO₂ delivery to the pipeline is occurring, CO₂ must be discharged elsewhere until pipeline deliveries can resume. While the startup stack and normal compression and purification unit vent would accommodate many such conditions, additional backup discharge points may be required to facilitate practical compression and purification unit operation during upsets. Details regarding such backup discharge points would be finalized when design details become available and could include onsite CO₂ storage or additional CO₂ venting capability downstream of the compression and purification unit. Venting of CO₂ would only occur within the constraints of the air permit.

Air Emissions

During normal operations, the flue gas, upon exiting the boiler, would enter the gas quality control system, which comprises numerous steps designed to remove pollutants, recover heat, and prepare the flue gas before entering the compression and purification unit. The gas quality control system would incorporate state-of-the-art processes to reduce criteria pollutants to low levels. Table 2-8 presents estimated pollutant emissions during normal operating conditions based on **expected annual operating conditions for the 168 MWe design and hourly emissions rates from the July 2013 air permit application.** These emissions differ from those presented in the Draft EIS due to updates that have occurred to the design for the project, from the original 200 MWe design to the current 168 MWe design. **Expected annual operating conditions assume that the compression and purification unit (processing flue gas from the oxy-combustion boiler) would operate for 7,446 hours per year; the oxy-combustion boiler would operate in air-fire mode without the compression and purification unit for 240 hours per year; and 240 hours in oxy-combustion transition.** These estimates include

emissions from the oxy-combustion boiler, the compression and purification unit, the auxiliary boiler, and the various material-handling units that support these operations. Emissions would be higher during startup, in the case of a compression and purification unit or pipeline shutdown, and during shutdown. However, these conditions are expected to be rare. Designers anticipate minimal hazardous air pollutants (HAPs) emissions during normal operations. See Section 3.1, Air Quality, and Section 3.2, Climate and Greenhouse Gases, for further discussion on air emissions from the proposed project.

Table 2-8. Oxy-Combustion Facility Emissions under Normal Operating Conditions

Emissions Constituent	Tons per year ^a
CO	86.5
NO _x	214.6
VOCs	7.3
PM (filterable)	36.2
PM _{2.5}	32.6
SO ₂	21.5
Hg	0.0073
CO ₂ -eq	169,701 ^b

^a Emissions listed in the table are based on expected annual operating conditions for the current 168 MWe design and hourly emissions rates from the July 2013 air permit application. Expected annual operating conditions assume that the CPU (processing flue gas from the oxy-combustion boiler) would operate for 7,446 hours per year; the oxy-combustion boiler would operate in air-fire mode without the CPU for 240 hours per year; and 240 hours in oxy-combustion transition. Estimates include emissions from the oxy-combustion boiler, the CPU, the auxiliary boiler, and the various material-handling units that support these operations.

^b Net emissions of CO₂ from oxy-combustion boiler stack, assuming at least 90 percent of the CO₂ is captured by the CPU during steady-state operation. See Section 3.2, Climate and Greenhouse Gases, for further discussion of CO₂-eq emissions.

CO = carbon monoxide; CO₂ = carbon dioxide; CO₂-eq = carbon dioxide equivalent; CPU = compression and purification unit; Hg = mercury; MWe = megawatt electrical; NO_x = nitrogen oxides; PM_{2.5} = particulate matter of diameter 2.5 microns or less; PM = particulate matter; SO₂ = sulfur dioxide; VOCs = volatile organic compounds

2.4.4.3 Health and Safety Policies and Programs

Ameren’s existing Environmental Policy directs all persons and entities operating and maintaining company facilities on its behalf, including the Meredosia Energy Center, to act in a manner protective of human health, the environment, and property while complying with all applicable environmental laws and regulations. The Alliance intends to develop and implement a similar policy that would apply to the facilities and personnel associated with the project.

The storage and handling of toxic or flammable materials would be conducted in compliance with USEPA and Occupational Safety and Health Administration (OSHA) regulations and the National Fire Protection Association’s “Guide on Hazardous Materials” (NFPA 2010). The Alliance would develop and maintain a Spill Prevention, Control, and Countermeasures (SPCC) plan for the project in compliance with federal and state regulations. The worker safety programs developed and implemented by the Alliance and its partners would ensure that workers are aware and knowledgeable about spill containment procedures and related health and environmental protection policies.

2.4.4.4 Permit Requirements

Chapter 5, Regulatory and Permit Requirements, includes Table 5-1 that summarizes the permits and activities that could be required for construction and operation of the proposed oxy-combustion facility, such as an Air Pollution Control Construction Permit, NPDES Construction Permit, and required modifications to the existing NPDES Operating Permit.

2.4.4.5 Power Purchase Agreement

Information in this section has been updated since the Draft EIS was published. The Illinois Power Agency, in fulfillment of its duties under the Illinois Power Agency Act, facilitates procurement of

electricity for the state's **two regulated** utilities (i.e., Commonwealth Edison and Ameren Illinois) and in some cases the Alternative Retail Electric Suppliers. **Each year, as required by statute, the Illinois Power Agency submits an annual power procurement plan to the Illinois Commerce Commission for approval. In addition to ensuring the adequate procurement of electricity for Illinois' ratepayers, the Illinois Power Agency is responsible for administering the state's Renewable Portfolio Standard and Clean Coal Portfolio Standard. Under the "retrofit provision" of the Clean Coal Portfolio Standard, owners of coal-fired power plants that were previously owned by Illinois utilities that have been or will be converted to clean coal facilities are entitled to submit proposed power purchase agreements to the Illinois Power Agency and request that they be included in annual procurement plans.**

In accordance with the retrofit provision, **during the spring of 2012**, the Alliance submitted to the Illinois Power Agency a draft power purchase agreement for the electricity to be produced by the FutureGen 2.0 Project. Following its review, the Illinois Power Agency included the power purchase agreement in its annual electricity procurement plan for 2013. **After a docketed regulatory proceeding, the Illinois Commerce Commission entered an order approving the procurement plan and power purchase agreement in December 2012. After a second-phase docketed regulatory proceeding designed to resolve implementation issues associated with the power purchase agreement, the Illinois Commerce Commission approved a revised, final version of the power purchase agreement for the FutureGen 2.0 Project in June 2013 and directed Commonwealth Edison and Ameren Illinois to sign the agreement within 60 days. The Illinois Commerce Commission also found that the costs associated with the power purchase agreement fall below statutory benchmarks. Moreover, the estimated rate impact on applicable Illinois electric customers would be less than the 2.015 percent statutory limit designed to protect the Illinois taxpayer and imposed by the Clean Coal Portfolio Standard.** The FutureGen 2.0 Project would have no rate impact on electricity customers receiving power from rural electric cooperatives.

2.4.5 Decommissioning

The planned life of the oxy-combustion facility at the Meredosia Energy Center is expected to be 20 years. However, if the energy center remains economically viable, it could be operated for additional years into the future. A closure plan would be developed prior to the time that the energy center would be permanently closed. The removal of the energy center from service, or decommissioning, may range from "mothballing" to the removal of all equipment and facilities, depending on conditions at the time. The closure plan would be provided to state and local authorities as required.

2.5 FUTUREGEN 2.0 PIPELINE AND CO₂ STORAGE RESERVOIR

The Alliance would transport the captured CO₂ from the Meredosia Energy Center in an underground pipeline to a permanent geologic storage reservoir in Morgan County (see Figure 2-16). At this site (i.e., the CO₂ storage study area), the CO₂ would be injected **approximately** 4,000 feet below the earth's surface into the Mt. Simon Formation. The Mt. Simon Formation, a deep saline formation, would be used as the permanent storage reservoir for the CO₂. This technology, including the capture of CO₂ from the oxy-combustion facility, is known as CO₂ capture and storage. Once the CO₂ would be injected, it would be extensively and continuously monitored to ensure it is being safely and permanently stored. In addition, visitor, research, and training facilities (also referred to as the 'educational facilities') are planned for the Jacksonville area. The following sections describe the siting, design, construction, and operation of these activities (Alliance 2013a).

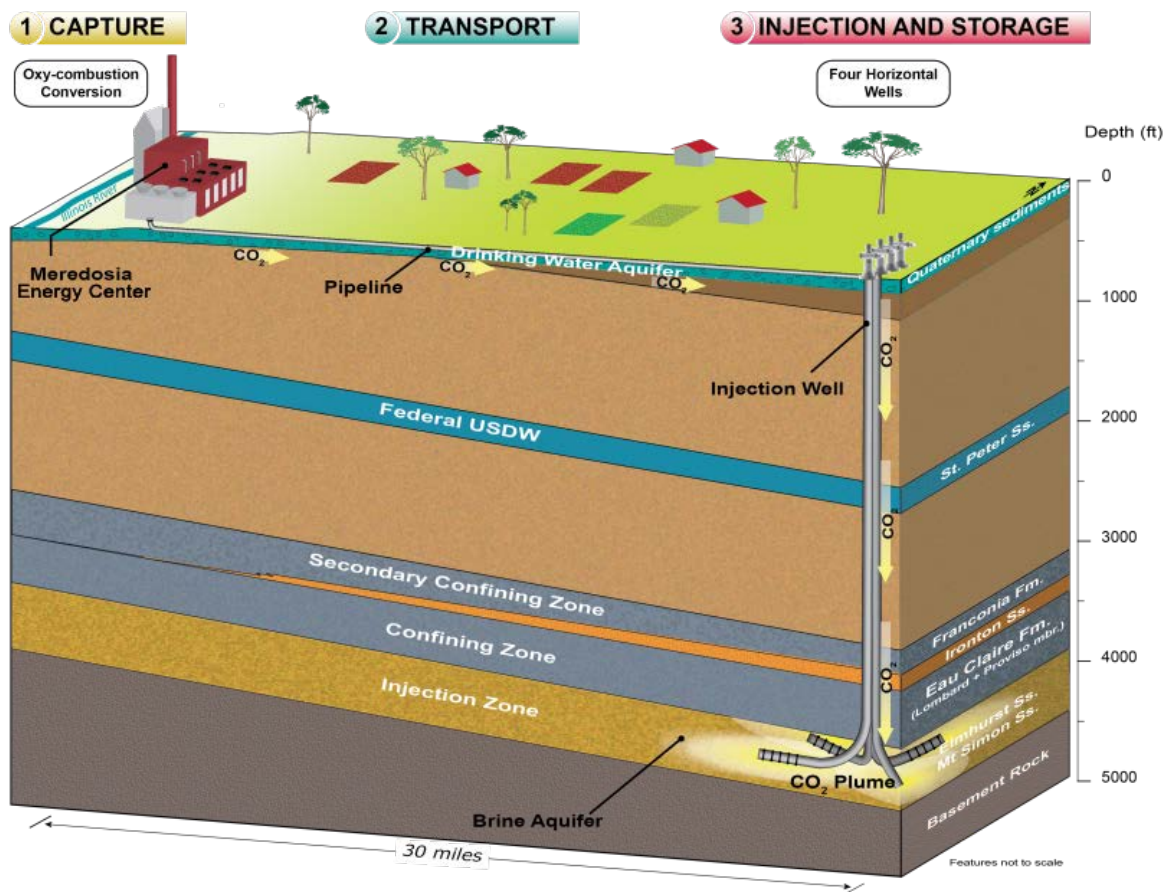

CO₂ = carbon dioxide; Fm. = Formation; ft = feet; Ss. = sandstone; USDW = underground source of drinking water

Figure 2-16. Project Concept

2.5.1 CO₂ Pipeline

The Alliance plans to site, design, construct, and operate a CO₂ pipeline from the Meredosia Energy Center to the CO₂ storage study area. The CO₂ would be received from the capture facilities at the energy center and transported through a new pipeline for injection and permanent storage in the Mt. Simon Formation. The CO₂ pipeline from the Meredosia Energy Center to the CO₂ injection well site would be approximately 30 miles long.

The CO₂ stream from the Meredosia Energy Center would be at least 97 percent pure CO₂. The remaining gas would include inert compounds, water vapor, and other trace constituents that meet regulatory standards. CO₂ can exist in a gaseous, liquid, or solid state. At its critical point, which occurs at 1,070 pounds per square inch pressure (psig) and 87.8 degrees Fahrenheit (°F) temperature, CO₂ gas goes into a liquid-like dense phase. CO₂ transport in a dense phase is the method of choice adopted by all major CO₂ pipeline companies. In this dense phase, the CO₂ is non-corrosive and is safe to transport in the pipeline.

The transport of CO₂ gas in dense phase is regulated by the U.S. Department of Transportation (DOT) regulation entitled "Transportation of Hazardous Liquids in Pipelines" (49 CFR 195). The regulation provides all pertinent design requirements including safe distance from other structures, depth of cover, separation from other lateral assets, construction material selection, design calculation factors, pressure testing, and pipeline safety, among many other requirements that ensure long-term safe operation of the pipeline. The Alliance's design for the CO₂ pipeline would meet or exceed all of the requirements in 49 CFR 195.

CO₂ gas is heavier than air. When released it stays close to the ground, and if released in sufficient volumes can fill up low lying areas causing a potential safety hazard. The pipeline design provides safeguards to mitigate such risk. These safeguards include mainline block valves to isolate pipeline sections, a leak detection system to alert the operator, and a supervisory control and data acquisition (SCADA) telecommunication system to communicate information and data about pipeline performance. In addition, pipeline monitoring and surveillance procedures would be implemented in the field on a daily basis.

2.5.1.1 Pipeline Corridor and Routes

Information in this subsection has been updated since publication of the Draft EIS to reflect the Alliance's preference for the southern CO₂ pipeline route as the proposed route to the CO₂ storage study area, and to incorporate updates to its proposed alignment. The Alliance designated a 4-mile wide corridor extending from the Meredosia Energy Center to the CO₂ storage study area through which the pipeline route would pass. Because the exact pipeline alignment was not known during the analysis for the Draft EIS, DOE used the corridor to set the boundaries and general existing conditions of where the pipeline would be located. Figure 2-17 illustrates the location of the pipeline corridor and the CO₂ storage study area. The pipeline corridor extends 26 miles from the eastern edge of the Illinois River to the western border of the CO₂ storage study area.

Within the pipeline corridor, the Alliance originally identified two possible pipeline routes from the energy center to the western border of the CO₂ storage study area in which the injection wells would be located. These are referred to as the southern route and northern route, as shown in Figure 2-18. Appendix C, Map Views of Pipeline, contains detailed aerial maps of the potential routes.

In the early stages of the FutureGen 2.0 Project, the Alliance identified the northern route for initial cost-estimating purposes. Based on subsequent investigations and field work, the Alliance identified the southern route as the preferable and proposed pipeline route, based on constructability, access to existing ROWs, and the desire to avoid, to the extent possible, sensitive environmental resources such as wetlands, cultural resources, forest land, and threatened or endangered species and their habitats. The southern route was developed in coordination with the Illinois State Historic Preservation Office (SHPO), the Illinois Department of Natural Resources (IDNR), and the U.S. Army Corps of Engineers (USACE). The southern route is the subject of the Alliance's application for a Certificate of Authority from the Illinois Commerce Commission to construct and operate the pipeline, filed in March 2013 (Illinois Commerce Commission 2013). The Alliance is working with affected landowners along the southern route regarding specific alignment and compensation for the required pipeline ROWs. Although the northern pipeline route is included in this Final EIS for comparison purposes, the Alliance is no longer considering the northern route for the FutureGen 2.0 Project.

FutureGen 2.0 Pipeline Siting

Pipeline Corridor - The 4-mile wide corridor initially identified by the Alliance as the area within which a CO₂ pipeline would be sited. The corridor extends from the Meredosia Energy Center to the boundary of the CO₂ storage study area.

Pipeline Route - A specific pipeline route identified within the pipeline corridor. The pipeline route consists of the pipeline within a 50-foot wide operational right-of-way. Two pipeline routes, the southern route (proposed) and the northern route, are being analyzed by DOE. The Alliance is working with affected landowners along the southern route regarding specific alignment and compensation for the required pipeline rights-of-way.

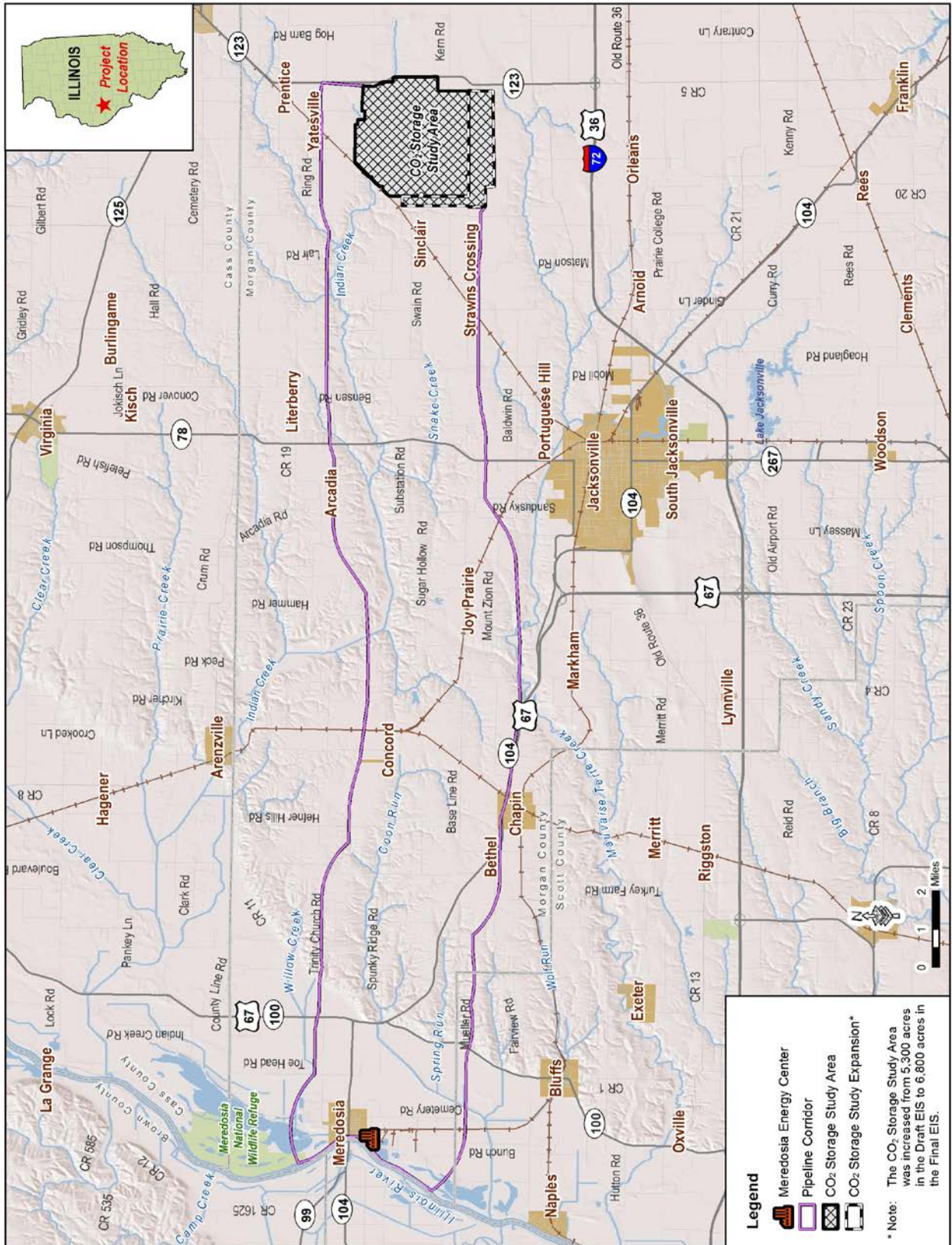

CO₂ = carbon dioxide

Figure 2-17. CO₂ Pipeline Corridor to the CO₂ Storage Study Area

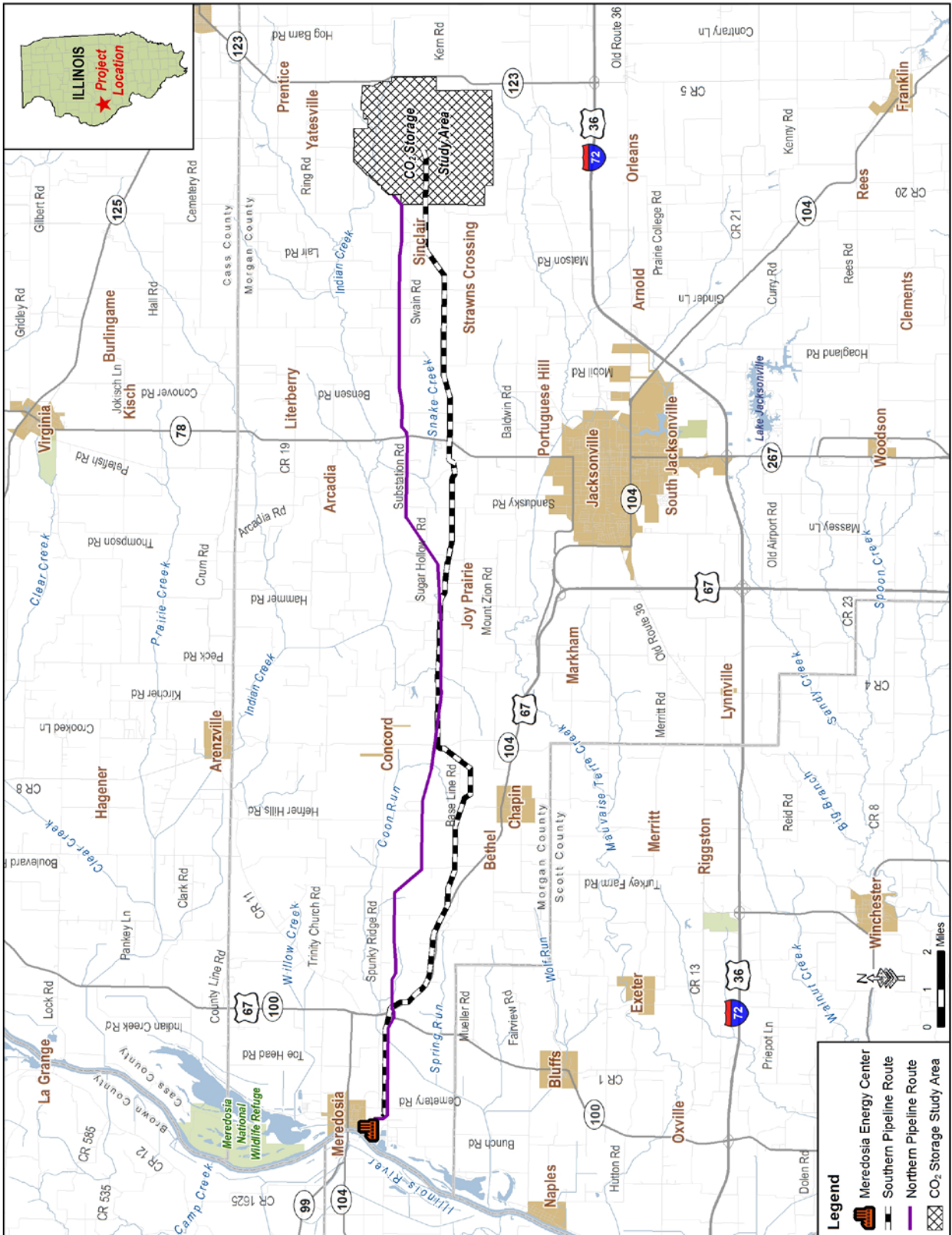

CO₂ = carbon dioxide

Figure 2-18. Southern and Northern CO₂ Pipeline Route Options to CO₂ Storage Study Area

Preliminary route selections, as shown in Figure 2-18 were based on the following siting criteria, which represent good engineering practices generally accepted in the industry. In the event that the final pipeline route deviates from the route options specified in this EIS, the Alliance would similarly use these siting criteria:

- Maintain a minimum safe distance from residential, commercial, and industrial buildings and structures in accordance with governing codes. Federal regulations (49 CFR 195) require a minimum distance of 50 feet from occupied dwellings; **to the extent practicable**, the Alliance committed to maintaining a minimum distance of 150 feet to provide an additional buffer.³
- Co-locate with existing features where acceptable.
- Utilize existing timberland clearings where practical.
- Cross roads, railroads, and waterbodies at a near right angle but no more than 10 degrees from right angle where possible for permitting approval. Exceptions would be reviewed on a case-by-case basis.
- Perform constructability reviews. Avoid or minimize side hill slopes as much as possible. Identify water source and disposal sites for pipeline pressure testing due to the large quantity of water required for pressure testing.
- Review ROW accessibility and logistics for construction materials and equipment.
- Review environmental features and permitting requirements.

At the time of the initial DOE pipeline impact analysis for the Draft EIS, the Alliance **had** not yet identified potential routes for the last few miles of the pipeline within the CO₂ storage study area (i.e., the end-of-pipeline spurs) because the location of injection wells **had** not yet been determined. **Since then, the Alliance selected a location for the injection wells and a proposed route for the end-of-pipeline spur for the southern pipeline route. Since the Alliance selected the southern route as the proposed option, it has not identified routing for the end-of-pipeline spur for the northern pipeline route, which is no longer under consideration.** See Chapter 3, and specifically Section 3.0, for information on how DOE assessed potential impacts related to the injection wells and **pipeline routes**, and Section 4.4, Incomplete and Unavailable Information, for additional discussion relating to incomplete and unavailable information.

2.5.1.2 Pipeline Design

Information in this section has been updated since publication of the Draft EIS, particularly with respect to the minimum distance between mainline block valves along the CO₂ pipeline. The CO₂ pipeline would be constructed of carbon steel that conforms to the American Petroleum Institute Specification 5L, Specification for Line Pipe. It would consist of high-frequency electric resistance welded pipe that is coated with a three-layer fusion-bonded epoxy to an average thickness of 16 thousandths of an inch. An abrasion-resistant coating of a minimum of 40 thousandths of an inch would be used for bored road and rail crossings and for horizontal directional drills. The pipe would be subject to charpy v-notch impact testing (a standardized high strain rate test that determines the amount of energy absorbed by a material during fracture) and drop weight tear testing during the manufacturing process. The objective is to use a material that displays high strength at low temperatures. All field welds would be radiographed. A **nominal** 12-inch diameter pipeline was **originally** selected based on hydraulic models,

³ Note: It is possible that a shorter distance would be deemed necessary in order to avoid a sensitive environmental resource or at the request of an affected landowner, but the distance would not be less than the 50 feet required by federal regulations.

such that it would eliminate the need for an intermediate pump station and reduce associated capital and operating costs. **The Alliance is also exploring the potential of using a nominal 10-inch diameter pipeline. A final determination for the size of the pipeline has not been made; therefore, the Final EIS evaluates impacts related to both pipe sizes.**

Although the pipeline itself would be buried, aboveground features would include meter stations and launcher/receivers (start and end of the pipeline). Other visual features of the pipeline system would include the following:

- Pipeline markers at all crossings;
- Mainline block valve shelters;
- Cathodic protection station markers; and
- Temporary zinc anode site markers.

The American Society of Mechanical Engineers (ASME) Standard B31.4 provides industry standards for the location and number of mainline block valves; however, the standard only provides specific distances for mainline block valves on piping systems that are used to transport liquefied petroleum gases or liquid anhydrous ammonia. For those types of pipelines, the standard requires that mainline block valves be installed at 7.5-mile maximum spacing in industrial, commercial, and residential areas (Section 434.15.2(e)). In addition, in accordance with ASME B31.4, as well as 49 CFR 195, mainline block valves must be placed on either side of major river crossings, at other waterbody crossings more than 100 feet wide and optionally at major road crossings. These criteria were originally referenced in the Alliance's development of a conceptual design for the CO₂ pipeline, which considered mainline block valve spacing of between 7.5 and 10 miles. As a result, the impact analysis in the Draft EIS evaluated both spacing intervals.

The 7.5-mile maximum spacing standard is not directly applicable to the transportation of liquefied CO₂. Moreover, there are no industrial, commercial, or residential areas along the proposed CO₂ pipeline corridor, which is located in a rural area. Similarly, there are no major river crossings or other waterbody crossings more than 100 feet wide for the proposed CO₂ pipeline route. As a result, the Alliance's current conceptual design assumes that there would be one mainline block valve at the beginning of the pipeline, one at the end of the pipeline, and two in between (i.e., 10 miles apart). While the exact number and location of the mainline block valves would be determined after additional hydraulic analysis, the Alliance committed to a maximum distance of 10 miles between mainline block valves; therefore, the impact analysis in the Final EIS addresses the 10-mile maximum spacing.

Mainline block valves would be equipped for remote operation. Based on electric power availability, valves would be operated by electric motor or gas-over-oil hydraulic actuators. The valves would also have a removable wheel to allow manual operation and would be specified with special trim suitable for CO₂ dense phase service. **Bypass arrangements would be provided at each valve such that vent piping could be installed in the unlikely event that a segment of pipeline needed to be slowly vented under controlled conditions to conduct pipeline repairs.** The mainline block valves would be located on high ground, as practicable, to prevent hazard from valve leaks. **Pressure safety (relief) valves would also be installed at the pipeline inlet (at the energy center) and between the block valves that could be used to vent CO₂ in the event of an unanticipated upset condition. The valves could be routed to a central vent system at the injection site and would be routed to the blowdown system at the energy center.**

The pipeline would be designed to assure passage of intelligent internal inspection devices (pigging operations) and have launch and receive facilities for the in-line inspection tools **located at the beginning (at the energy center) and end (at the CO₂ injection site) of the pipeline, respectively.** Crack arrestors

would be provided on the pipeline at appropriate spacing. The pipeline would be cathodically protected by means of impressed current system with deep anode ground beds.

2.5.1.3 Pipeline Construction

All construction work would be executed in accordance with the conditions and stipulations of applicable federal, state, and local permits, authorizations, and clearances. All necessary approvals would be obtained before the activity in question is undertaken. In addition, the Alliance signed an Agricultural Impact Mitigation Agreement with the Illinois Department of Agriculture (IDOA) that sets forth the activities the Alliance would undertake to mitigate any adverse impacts to farmland associated with the construction of the CO₂ pipeline (see Appendix H, Agricultural Mitigation). The Illinois Farm Bureau also participated in the development of the agreement by reviewing and providing comments that were incorporated into the agreement.

Agricultural Impact Mitigation Agreement

The Alliance signed an Agricultural Impact Mitigation Agreement with the Illinois Department of Agriculture that sets forth the activities the Alliance would undertake to mitigate any adverse impacts to farmland associated with the construction of the CO₂ pipeline (see Appendix H, Agricultural Mitigation).

Construction techniques for the pipeline may include excavated trenching, boring, tunneling, and horizontal directional drilling. DOE would use one of three primary methods to construct crossings of sensitive resources, roads, and railroads. Table 2-9 shows the **approximate number of major features that would be crossed by each pipeline route**. The method used to construct pipeline crossings is primarily dependent upon the size of the feature being crossed. For stream crossings, the method used is also dependent upon the presence or absence of water within the feature (e.g., seasonally dry ephemeral and intermittent stream channels).

Table 2-9. Pipeline Crossings

Description	Southern Route	Northern Route
Roadways	26	26
Railroads	3	3
Waterbodies ^a	86 ^b	95 ^c
Total^c	115^d	124

^a The number of waterbody crossings is based solely on GIS data from the National Hydrologic Dataset. This provides a conservative estimation of the number of features crossed by each pipeline route.

^b The Alliance conducted a survey of waterbodies and wetlands along the southern pipeline route in spring 2013, which confirmed the presence of 2 perennial streams and 13 intermittent streams (significantly fewer than the number identified via GIS mapping), as well as many ephemeral streams, ditches, and swales. The Alliance also identified 14 wetland areas (total of approximately 0.5 acre) along the southern route. The Alliance plans to trench through 0.03 acre of wetland, as authorized by the USACE, and use pipe-boring techniques to avoid disturbance of all other wetlands along the route. See Section 3.7, Wetlands and Floodplains for further information.

^c The number of crossings for the northern route is based on the initial northern route alignment from the Meredosia Energy Center to the western border of the storage study area, and the hypothetical end-of-pipeline routes (spurs) as presented in the Draft EIS.

^d The Alliance intends to use pipe-boring techniques in 37 locations along the southern route (some borings cross multiple surface features).

The three methods that would be used include horizontal directional drilling, jack and bore tunneling, and dry trenching. Horizontal directional drilling would be used to cross major waterbodies (i.e., crossings of perennial streams and ponds or lakes greater than 100 feet in width) and large roads (e.g., highways). Additional horizontal directional drilling may be required due to environmental, land, or constructability requirements. As necessary, geotechnical investigations would be performed prior to the construction of pipeline crossings using horizontal directional drilling to ensure that subsurface conditions can safely support drilling operations. Primary factors in selecting the pipeline crossing profile would include the type of soil and rock to be drilled and the depth of cover material. The minimum depth of cover for

waterbodies requiring horizontal directional drilling would be 4 feet as required under 49 CFR 195.248(a). Contingency plans would be developed, as required, for completing waterbody crossings in the event of an unsuccessful horizontal directional drilling.

Jack and bore tunneling (also known as pipe ramming) would be used for crossings of railways, roadways, and perennial streams and wetlands, as well as intermittent and ephemeral streams that contained water at the time of construction. The jack and bore tunneling method involves the use of a horizontal bore machine or auger to drill a hole, and a hydraulic jack to push a casing through the hole under the crossing. As the bore proceeds, a steel casing pipe would be jacked into the hole; then the pipeline installed in the casing. The casing would be jacked using a large hydraulic jack in a pit located at one end of the crossing. The jack pit would be excavated and shored.

Dry trenching would only be employed for crossing narrow intermittent and ephemeral stream channels that were devoid of water at the time of construction, such as when a stream feature is seasonally dry or is frozen to the bottom. A field assessment would be made prior to construction at each crossing to determine the presence of water, and weather forecasts would be monitored to evaluate the potential for precipitation events that could lead to temporary water flow within the stream channel. Dry trenching would consist of excavating a trench through the stream channel, laying the pipe down, then burying the pipe with the spoils removed during trench excavation. The pipeline crossing would be as nearly perpendicular to the stream channel as possible to minimize overall linear disturbance to the stream channel. After pipeline installation, the surface would be regraded to match pre-construction contours.

The CO₂ pipeline would be buried at least 4 feet underground, which is more than **the minimum depth** required by 49 CFR 195. Additional depth of cover would be provided for crossings, drainage ditches, and irrigation tiles. For agricultural land, the pipeline would be buried at least 5 feet deep in accordance with IDOA pipeline construction standards and policies **and the Alliance's Agricultural Impact Mitigation Agreement (see Appendix H, Agricultural Mitigation)**. Topsoil would be removed first and stored separately along the pipeline trench segregated from other subsoil.

Crossings of other types of pipelines and other underground utilities would require a minimum of 12 inches of separation. However, the minimum separation may be increased to 24 inches where considered prudent based on professional judgment. Existing pipelines would be under-crossed unless over-crossing is specifically permitted by the pipeline owner. All road and railroad crossings would be bored under the road or railroad (i.e., without casings) using heavy wall pipe with abrasion resistant coating.

The construction ROW for the pipeline includes the area required to enable movement of construction equipment, staging of materials, and laydown of equipment during the construction period. Figure 2-19 shows recommended pipeline construction ROW cross sections. The construction ROW would be 80 feet wide, although a 100-foot construction ROW may be needed for special requirements such as pipe transportation in wooded hilly terrain or where side slope construction may be unavoidable. **Additionally, the wider construction ROW sections would be necessary to support the maneuvering of equipment at locations where horizontal directional drilling or jack and bore tunneling would be performed (see Appendix C, Map Views of Pipeline)**. Access to the construction ROW would be provided (as much as possible) from existing roads crossing the pipeline route. The operational ROW is the area that would permanently be maintained throughout the life of the project, which would be 50 feet in width and centered over the pipeline.

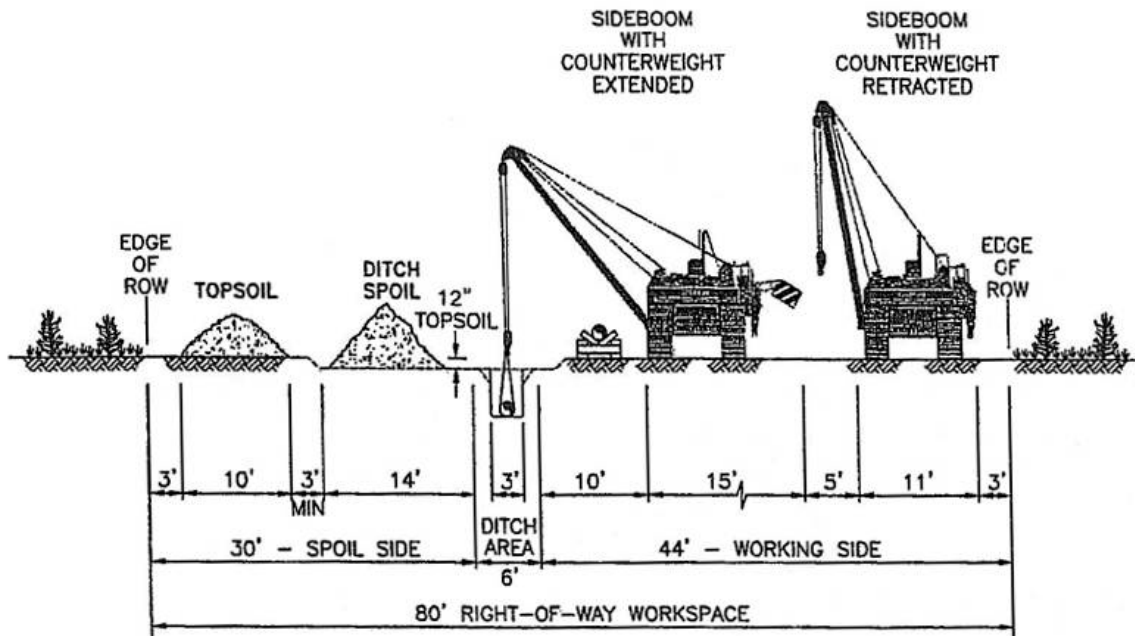

Figure 2-19. Recommended Construction Right-of-Way Cross Section

Tree clearing for ROW preparation would generate cut trunks, limbs, and brush (the amount would depend on width of ROW and extent of wooded areas). As part of the Agricultural Impact Mitigation Agreement with the IDOA (see **Appendix H, Agricultural Mitigation**), the following mitigation measures **related to land clearing** would be implemented during construction:

- If trees are to be removed from the ROW, the Alliance would consult with the landowner to determine if there are trees of commercial or other value to the landowner.
- If there are trees of commercial or other value to the landowner, the Alliance would allow the landowner the right to retain ownership of the trees with the disposition of the trees to be negotiated prior to the commencement of land clearing.
- Unless otherwise restricted by federal, state, or local regulations, the Alliance would follow the landowner's desires regarding the removal and disposal of trees, brush, and stumps of no value to the landowner by burial, etc., or complete removal from any affected property.

All construction-related debris and material that are not an integral part of the pipeline would be removed from the landowner's property. Such material to be removed would include litter generated by the construction crews.

The estimated number of daily truckloads during construction for material and equipment deliveries, for waste removals, and for workers would be the following:

- Material and Equipment Deliveries - 40 to 50 trips per day
- Waste Disposal - 2 to 3 trips per day
- Worker Traffic - 100 to 150 trips per day

The construction of the CO₂ pipeline would require hydrostatic testing to certify the integrity of the pipeline before it can be put into operation. Hydrostatic testing would be performed in accordance with DOT pipeline safety regulations. Hydrostatic testing would be conducted continuously for a minimum of

8 hours, and include a leak test. Fabricated assemblies would be pre-tested for a minimum of 4 hours. These would be included in the overall pipeline hydrostatic test. If water is used, the pipeline would be filled with water and pressurized to check for any pressure loss that may indicate a leak. Approximately 31,000 gallons of water would be needed for each mile of **the nominal** 12-inch diameter pipe; water may be reused for multiple pipeline sections. Specific water sources for hydrostatic testing have not yet been selected, but the Alliance assumes that adequate sources are available regionally. Hydrostatic testing water would be discharged to local waterways in accordance with an NPDES permit obtained from the IEPA. The NPDES permit from IEPA would be applied for and received prior to the start of construction activities. The tested line would be dried using dry air to a dew point of -50°F, which would prevent any residual water in the pipeline from initiating localized corrosion in the pipe.

An environmental compliance plan would be developed prior to construction, identifying on a mile-by-mile and feature-by-feature basis how all applicable permits and their requirements would be implemented. Environmental inspectors would be deployed on a spread-by-spread basis to ensure adherence to all permit conditions by identifying and rectifying any non-compliance or potential non-compliance concerns as soon as they materialize.

The Alliance estimates that construction of a pipeline from the Meredosia Energy Center to the CO₂ **injection site** would take approximately 4 to 5 months with 1 to 2 months of **peak activity**. The Alliance estimates that 150 to 300 workers would be needed for the duration of pipeline construction, working 10 hours per day, 6 days per week. Pipeline contractors would hire from local county labor pools for services and maximize the use of local providers of materials as practicable.

2.5.1.4 Pipeline Operations

The CO₂ pipeline would transport dense phase CO₂ from the Meredosia Energy Center to the injection wells for permanent geologic storage in the Mt. Simon Sandstone. Although the exact composition of CO₂ that would be received from the energy center is not completely defined at this time, **the Alliance is designing the pipeline to meet the CO₂ specifications that are standard in the commercial CO₂ pipeline transport industry. The Alliance's minimum CO₂ pipeline acceptance** specifications provided in Table 2-10. The Alliance would oversee the operation of the oxy-combustion and CO₂ capture processes to ensure that these specifications would be met on a consistent basis other than during startup and shutdown conditions for maintenance. As previously mentioned in Section 2.4.4.2, if CO₂ conditions do not meet the required specifications, the Alliance would determine whether the process upset can be accommodated or whether flow to the pipeline should be stopped. The gas would be vented through the stack in the event that the quality requirements could not be met. Venting of CO₂ would only occur within the constraints of the air permit.

The design flow rate would be 1.2 million tons (1.1 million metric tons) of CO₂ per year (**66.9** million standard cubic feet per day, **assuming 85 percent energy center capacity**). The CO₂ would be processed for removal of contaminants and compressed at the Meredosia Energy Center before entering the pipeline.

The pipeline design includes the following assumptions:

- The Meredosia Energy Center would supply 1.2 million tons (1.1 million metric tons) per year of CO₂ (equivalent to **66.9** million standard cubic feet per day flow rate) for transport.
- The CO₂ would be compressed to 2,100 psig before entering the pipeline, **although delivery pressure could be reduced to accommodate the final subsurface design. System controls would ensure that the pipeline pressure would not drop below the critical point pressure (1,070 psig) at any point along the route to prevent multiphase flow in the pipeline.**

Table 2-10. Alliance Minimum CO₂ Pipeline Acceptance Specifications

Component	Quantity
Carbon Dioxide (CO ₂)	97 percent dry basis
Inert constituents	1 percent
Trace constituents	2 percent
Oxygen (O ₂)	≤ 20 ppm
Total sulfur	≤ 25 ppm
Mercury (Hg)	≤ 2 ppb
Hydrogen sulfide (H ₂ S)	< 20 ppm ^a
Water vapor	≤ 30 lb/mmscf

^a Standard specification for pipeline quality CO₂. However, no detectible amounts of H₂S are expected in the CO₂ stream from the Meredosia Energy Center.

Note: The CO₂ stream could contain other trace metals, which would not be known until additional design work is completed.

CO₂ = carbon dioxide; H₂S = hydrogen sulfide; Hg = mercury; lb/mmscf = pounds per million standard cubic feet; O₂ = oxygen; ppb = parts per billion; ppm = parts per million

- SCADA remote control system would be installed. There would be one metering station at the energy center and one at each injection well. Meter station data would be transmitted to the site control **and maintenance** building through the SCADA network. Consistent with standard industry practice, the metering stations would be automated (not staffed). Two Coriolis flow meters would be provided in parallel at each metering station, one working and the other on stand-by. Meter testing would be conducted on a monthly basis to verify the accuracy and performance of each liquid meter. Meter stations would be designed for open air service with an overhead shelter for protection against direct exposure to the elements.
- The system would be designed in accordance with American National Standards Institute 900 for valves, flanges, and fittings.
- A pipeline leak detection system conforming to American Petroleum Institute standards (API 1130) would be installed.
- **Entry temperature at the Meredosia Energy Center is assumed to be 90°F, and would be no higher than 110°F.**
- Gas analysis would be conducted at the pipeline inlet using a moisture meter and gas chromatograph. Online analysis would be provided for quality monitoring purposes.
- A 6-hour uninterruptible power supply would be provided for critical instrumentation. **Backup power generation would also be provided in case of long duration outages.**
- A programmable logic controller, remote terminal units, analyzers, gas chromatograph, and other sensitive instrumentation would be housed in appropriately insulated climate-controlled structures, fenced and accessible by all-weather roads.
- The booster pump building would be totally enclosed with overhead crane and appropriate detectors.
- Redundancy would be provided for electrical installations (such as transformers, etc.).

Pipeline operations would be monitored on a continuous basis. The control and monitoring of pipeline operations would occur from a central control room located in the site control **and maintenance** building.

The central control room would send command and control signals remotely using the SCADA network to all **valves**, metering stations, and the launcher/receivers in the system. It is assumed that all metering stations would be unmanned.

If the CO₂ analyses conducted at the energy center or receiving meter station indicate that the specifications shown in Table 2-10 have been or are about to be exceeded, the Alliance would cease pipeline operations until the CO₂ stream can be brought back into specification. The system would include subsystems for CO₂ gas detection, hazardous gas detection, fire detection, flame detection, and smoke detection. In the event of detecting emergency conditions, the system would:

- Initiate ventilation system in the local control building, where applicable;
- Shutdown running units;
- Operate yard and unit valves as required by the level of the emergency;
- Activate audible and visual alarms in the pump and control buildings; and
- Activate alarms in central control room using the SCADA system.

A surveillance and security system would be provided for remote monitoring of the pipeline and the surface facilities from the central control room. The system would include the following:

- Proximity alarms installed at the main vehicle entrance gate as well as individual building doors;
- Security surveillance cameras; and
- Microwave intrusion link sensors.

Pigging operations may be required to clean, inspect, or repair a pipeline from the inside of the pipe. Routine pigging of the pipeline is not planned because the CO₂ stream would be clean and dry. However, if a pigging operation were to be needed (such as if there were a corrosion or damage concern), a small amount of CO₂ may need to be vented under planned and carefully controlled conditions. At the energy center site, the pig launcher would be purged with CO₂ to remove air from the launcher. Venting would be stopped when CO₂ began to be released. The purged gas would be routed to the blowdown system at the energy center. Once the pig was received at the injection well site, it would be isolated in a receiving barrel that required venting before the door could be opened to remove the pig. This would require slowly venting the CO₂ from the barrel. Although volume would be dependent on the final design of the system, the net volume of the CO₂ venting at the energy center and injection well site combined would be equivalent to approximately 20 cubic feet of dense phase CO₂.

A pipeline puncture or rupture resulting in a leak is unlikely based on historic CO₂ pipeline data from the DOT's Office of Pipeline Safety. To minimize this risk, the FutureGen 2.0 CO₂ pipeline design includes a leak detection sensitivity system. If a leak is detected, the mainline block valves would shut automatically, isolating the damaged pipeline segment and preventing the flow of CO₂ from the energy center and backflow from the injection wells. The maximum amount of CO₂ that could escape before the leak could be stopped would be limited to the amount of CO₂ contained within the pipeline between the valves. Based on the conceptual design, the maximum distance between mainline block valves would be 10 miles; a 10-mile pipeline segment would contain 18 million standard cubic feet of CO₂. Depending on the leak scenario, the volume released could be significantly lower.

Pipeline operations would be managed **from the site control and maintenance building** (see Section 2.5.2.2). Operation of the pipeline would be performed in full compliance with applicable DOT rules and regulations and would require regular visual and in-line inspections to ensure safety and integrity. Pipeline patrolling would be by road, by foot, and **potentially** by helicopter, contracted to specialist

companies. These visual surveys would be conducted every two weeks and would look for signs of leaks (e.g., discolored vegetation, disturbed soil) and potential infrastructure concerns (e.g., exposed pipe at stream crossings). Post-construction monitoring would be conducted (potentially for several years) to ensure that restoration of wetlands and agricultural lands would be undertaken in accordance with all permit and Agricultural Impact Mitigation Agreement requirements.

2.5.2 CO₂ Storage Study Area

This section has been updated from the Draft EIS based on the Alliance's proposed expansion of the land area included in the CO₂ storage study area, as well as the identification of a proposed site for the injection well facilities within the storage study area. As noted previously, the Alliance identified a location in Morgan County as the proposed CO₂ storage study area. The storage study area would encompass all of the surface facilities required for the injection and monitoring of the CO₂ as well as the underground CO₂ plume. Since the Draft EIS was completed, the Alliance has been working with local landowners to acquire additional subsurface pore space rights to maximize flexibility for CO₂ injection and to ensure that the CO₂ plume would not affect subsurface rights of non-participating landowners. (Non-participating landowners are those who have declined the Alliance's offer to purchase options for subsurface rights needed for CO₂ storage.) As a result of these efforts, the size of the CO₂ storage study area has been expanded to 6,800 acres. The additional 1,500 acres is located south and west of the original study area. While the location of the CO₂ plume has shifted south slightly as a result of availability of additional pore space and the Alliance's plan to construct and operate four horizontal injection wells of varying lengths, the plume size itself remains as estimated in the Draft EIS; approximately 4,000 acres.

The Alliance evaluated several injection well configurations using both vertical and horizontal injection wells at one or two sites. After consideration of site-specific data from the stratigraphic well, the Alliance is currently proposing to construct and operate four horizontal injection wells at one injection well site for the annual injection of 1.2 million tons (1.1 million metric tons) of CO₂ over a 20-year period.

The **conceptual** design of the CO₂ injection wells is based on the results of data gathered from a stratigraphic well that was drilled at the CO₂ storage study area, other characterization activities, and the results of modeling. The siting, design, construction, and operation of the injection wells and associated infrastructure are addressed below, along with the results of the CO₂ plume modeling. Although the Alliance plans to move forward with a single injection well site consisting of four horizontal wells (**the single-site scenario**) and is no longer considering the option of two sites with vertical injection wells (**the dual-site scenario**), the impact analysis in the Final EIS considers both scenarios (as analyzed in the Draft EIS) for comparative impact purposes. Since the completion of the Draft EIS, the Alliance progressed with the design of the injection wells and selected an injection well site; however, the Alliance cannot construct or operate the injection wells until Underground Injection Control (UIC) permits are issued by the USEPA. As a result, the Final EIS has been updated to incorporate the current design data, which has been compared with the bounding data already presented in the Draft EIS.

2.5.2.1 CO₂ Storage Area Siting

In its Request for Site Proposal issued on October 25, 2010 (amended November 10, 2010), the Alliance stated that offered sites must be able to meet several geologic storage criteria in order to be considered as a host for the CO₂ injection wells (Alliance 2010). These qualifying criteria included the following:

- The site must be located above the Mt. Simon Formation in Illinois with no foreseeable risk of subsurface migration of CO₂ outside the state of Illinois.
- Depth to the Mt. Simon Formation must be at least 3,500 feet below the surface.

- There must be at least one primary seal (caprock) greater than 200 feet in thickness, and the primary seal must not be intersected by any known or seismically resolvable faults above the expected plume diameter from up to 43 million tons (39 million metric tons) of injected CO₂.⁴
- The site must have the capacity to store up to 43 million tons (39 million metric tons) of CO₂ injected over 30 years.
- There must be no natural gas storage facilities in the Mt. Simon Formation (or other injection formation) within 20 miles of the proposed site.

The Alliance's Request for Site Proposal also required that sites offered for the geologic storage location meet the following criteria:

- Size – The surface area of the site must not be less than 25 contiguous acres based on the need to support one injection well and associated infrastructure, along with the area needed for the visitors, research, and training facilities.
- Control – The proposed surface site must be available for use by the Alliance.
- Seismic Stability – The proposed surface site must have low risk from significant seismic events.
- Floodplains – The entire proposed surface site must be above the 500-year floodplain to ensure low potential for flood damage to the injection well infrastructure.
- Existing Site Hazards – The proposed surface site, whether a greenfield or brownfield site, must be free of hazardous or radioactive chemicals and materials and free of wastes requiring special handling, treatment, or disposal.
- Zoning – The proposed surface site must be consistent with current zoning requirements or be capable of being rezoned to meet such requirements in a timeframe consistent with the FutureGen 2.0 schedule.
- Environmental Conditions – At least 25 contiguous acres of the proposed surface site must be free of the following:
 - Wetlands;
 - Structures that are listed on, or eligible for listing on, the National Register of Historic Places (NRHP), and be free of known cultural or archeological resources, including Traditional Cultural Properties; and
 - Known federally-protected species and critical habitat for protected species (excluding migratory birds).
- Proximity to Public Access Areas – The proposed surface site must be located outside of and not adjacent to the boundaries of any such area, unless the state or federal owner provides unequivocal permission for such use.
- Proximity to Tribal Lands – A proposed surface site located on or adjacent to tribal lands must be supported by the affected Native American tribe(s).
- Access – The Alliance must have sufficient physical access to the land above the plume to implement a rigorous monitoring program. At least 60 percent of the land area above the

⁴ At the time of the Request for Proposal, the project design specified 43 million tons (39 million metric tons) of CO₂; however, the current project design proposes injection of 24 million tons (22 million metric tons) over a 20-year lifetime.

anticipated CO₂ plume must be physically accessible for installation and operation of surface and subsurface monitoring equipment. Access restrictions include, but are not limited to, lakes, rivers, or other bodies of water, public access areas, and infrastructure including roads, buildings, or other developed property.

- Public Access Areas – The land area above the anticipated CO₂ plume must not be on a public access area, unless the federal or state owner provides unequivocal permission for such use.
- Major Bodies of Water – The land area above the anticipated CO₂ plume must not intersect major surface bodies of water.
- Sensitive Features – The land area above the anticipated CO₂ plume must not intersect any sensitive feature.

In addition, the Request for Site Proposal described other characteristics that would improve the ability to meet or lower the cost of meeting the objectives of the FutureGen 2.0 Project and explained that sites that had these characteristics would receive higher scores in the site evaluation. These scoring criteria included characteristics relating to orientation, permeability, and capacity of the injection formation; hydrogeological conditions that would decrease the lateral CO₂ plume size; ability to meet injectivity targets with the fewest injection wells; penetrations of the primary seals; availability of secondary seals; and subsurface access for monitoring wells.

Using these qualifying and scoring criteria, and taking into account other criteria, such as availability of data, stakeholder support, and the results of additional seismic testing, the CO₂ storage study area in Morgan County was selected as the preferred location for the CO₂ injection wells and the visitor, research, and training facilities. The Alliance initially identified sites in Christian and Douglas counties as alternative locations, though the confirmation of geologic suitability at the Morgan County CO₂ storage study area based on stratigraphic well data made it impractical and cost-ineffective to continue to study the Christian County and Douglas County locations (see Section 2.3.5). The Alliance's Request for Site Proposal and *Siting Guidance to Prospective Offerors* is provided on their website, which includes siting and scoring criteria (<http://www.futuregenalliance.org/>).

In addition to meeting the qualifying criteria, the proposed CO₂ storage study area in Morgan County was primarily selected based on: geologic suitability, surface and subsurface access, pipeline distance from the CO₂ source, and stakeholder support. Geologic suitability was determined after performing surface seismic surveys and examining the geology of the site based on existing data. Access was determined by identifying what land was available for the injection wells and where subsurface rights to inject CO₂ could be obtained. Stakeholder support was evaluated through a series of stakeholder meetings sponsored and held by the site proponents and the Alliance. The Alliance is currently entering into agreements with property owners regarding the use of and appropriate compensation for surface land and subsurface pore space.

Since publication of the Draft EIS, the Alliance identified a proposed property for the injection well site based on the results of data obtained from the stratigraphic well, other characterization activities, and the results of modeling of reservoir and seal performance. Drilling of the stratigraphic well took place from October 2011 to December 2011 at the site to characterize the geological profile and conditions, and to confirm the design parameters. Discussion of the stratigraphic well is provided in Section 2.5.2.5.

The injection well facilities would be constructed within a site to be acquired by the Alliance consisting of approximately 9.5 acres as shown in Figure 2-20. The Alliance would lease an additional 5.5 acres of adjoining property to the north for staging and laydown during the



Figure 2-20. Location of Injection Well Site Property for Single-Site Scenario

construction phase. The construction would be undertaken in a manner that would avoid areas of jurisdictional wetlands along the western edge of the properties, and the Alliance intends to leave as many trees intact on the properties as practicable.

2.5.2.2 Surface Facilities

The CO₂ surface facilities are expected to be visited by scientists, engineers, tourists, and dignitaries from across the country and the world. The CO₂ injection well site(s) would consist of surface facilities; the injection and monitoring wells; and monitoring, verification, and accounting (MVA) facilities.

This section has been updated from the Draft EIS to present new design details of the currently proposed single-site scenario and to compare the planned single-site scenario to the dual-site scenario that was presented in the Draft EIS. As already stated, the Alliance is no longer considering the dual-site scenario. The primary difference between the two configurations is that only one building would be required under the single-site scenario, while the dual-site scenario would require as many as four buildings distributed between the two sites. In addition, the Alliance would be able to reduce the length of access roads for the single-site scenario by locating facilities within close proximity to existing roads.

Similar to the dual-site configuration, the site control and maintenance building in the planned single-site configuration would be one-story tall to minimize visual impacts and, along with all other surface components, be designed to blend in with the rural surroundings. Green building design concepts would be incorporated into the site and building designs. The Alliance intends to seek Leadership in Energy and Environmental Design (LEED) certification for the surface facilities, which DOE intends to support to the extent that the costs would be fair, reasonable, and within the scope of the Alliance-DOE Cooperative Agreement. The materials required for construction of the surface facilities are anticipated to be typical of building construction (i.e., concrete, rebar, steel, wood, dry wall, insulation, glass, and roofing material). Materials would be delivered by construction trucks, such as concrete trucks, semi-trucks for steel and building materials, and tandem trucks for asphalt.

All structures would be built to withstand inclement weather conditions to assure worker and operational security. The entrance gate would be controlled through the use of a pass key system for employees and a site operator controller for guests. Cameras would identify and record gate entries. Yard lighting would be provided by 158-watt light emitting diode (LED) fixtures equipped with motion sensors. Lighting would be mounted on 25-foot poles that would be hinged to permit the fixtures to be lowered for maintenance. **Luminaries would be selected to minimize offsite glare and illumination.** The yard lighting and building exterior lights would be turned on and off by photocell-controlled contactors.

Safeguards would minimize the risk of CO₂ accumulation from small fugitive leaks (for example, at valve seals) and detect any levels of constituents that pose a risk to human health, safety, and welfare. For instance, all enclosed buildings at the CO₂ injection well site(s) would be equipped with high CO₂ concentration monitors, oxygen detectors, and fire detection and suppression systems, which can be automatically actuated by local programmable logic controllers or manually activated from a local or central location.

In the following tables, the features of the planned single-site scenario are compared to the respective features of the dual-site scenario as it was described in the Draft EIS. Table 2-11 compares the construction and operational footprints for both scenarios. Table 2-12 compares the estimated labor needs anticipated for the design and construction of the surface facilities for both scenarios. The anticipated management and operational personnel requirements to support the injection well facilities are summarized in Table 2-13 for both the dual-site and single site scenarios for comparison purposes. These tables are referred to in the comparisons that follow for the respective injection well site scenarios.

Table 2-11. Construction and Operational Area Requirements for Injection and Monitoring Well Sites

Area	Dual-Site Scenario		Single-Site Scenario	
	Construction (acres)	Operations (acres)	Construction (acres)	Operations (acres)
CO ₂ Injection Well Site ^a	10.5	4.4	15 ^b	9.5 ^b
Monitoring Well Sites	17.3	5.5	23.9	0.9
Access Roads	63.6 ^c	13.6 ^{c, d}	3.4	3.4
Total Impact Area	91.4	23.6^d	42.3	13.8

^a The CO₂ injection well site includes injection well(s) and well pad, building(s), parking, sidewalks, and other infrastructure (stormwater retention/infiltration basin, a packaged wastewater treatment system, screening berms, and fencing).

^b For the single-site scenario, the estimated acreage for the CO₂ injection site incorporates 1 acre for an access road to the injection wells.

^c For the dual-site scenario, the estimated acreage for access roads includes roads to the injection well sites as well as to the monitoring wells.

^d The Draft EIS was based on the assumption that operations would occupy less than 25 acres in total for the injection and monitoring well sites component of the project, of which, less than 15 acres would be required for access roads. These estimates are maintained throughout the analysis of the Final EIS.

Table 2-12. Construction Personnel Requirements for Injection Well Facilities

Component	Dual-Site Scenario	Single-Site Scenario
Site Control and Maintenance Building	NA ^a	10 employees for 25 weeks
Site Control Building	10 employees for 38 weeks	NA ^b
Booster Pump Building	10 employees for 15 weeks	NA ^b
Well Maintenance and Monitoring Building	5 employees for 4 weeks (each)	NA ^b
Parking Lot, Sidewalks, Grading, and Landscaping ^c	8 employees for 5 weeks	
Wastewater Treatment (packaged system) ^c	3 employees for 2 weeks	

^a The dual-site scenario does not include the site control and maintenance building.

^b The single-site scenario does not include the site control building, booster pump building, nor the well maintenance and monitoring buildings.

^c Labor requirements are the same for both scenarios.

NA = not applicable

Surface Facilities Construction

Single-Site Scenario

Under the single-site scenario currently proposed by the Alliance, only one building would be constructed at the injection well site. This building, known as the site control and maintenance building, would house the well annulus maintenance and monitoring system equipment. Other features of the surface facilities would include meters, surface piping, and piping-related equipment. Tables 2-11 and 2-12, above, summarize the site requirements and construction labor, respectively, for the single-site scenario in comparison to the dual-site scenario.

Table 2-13. Operational Personnel Requirements for Injection Well Facilities

Staff	Dual-Site Scenario		Single-Site Scenario	
	Shifts Per Day	Days Per Week	Shifts Per Day	Days Per Week
Management and Administrative Staff ^a	3	5	1	5
Engineering Staff ^b	2	5	2	5
Operations Staff ^c	6	5-7 ^c	-	-
Meter and Cathodic Protection Technician	2	5	1	5
Floater/Back-up Technician	1	5	1	5
“Inside” Control Room Operator	3	7	3	7
“Inside/Outside” Control Room Operator	3	7	3	7
“Floater/Back-up” Control Room Operator	1	5	1	5
Total Employees	21		12	

^a Management and administrative staff for the dual-site scenario would include an Area Manager, Office Manager, and Administrative Assistant. The single-site scenario would require a Site Manager/Safety Officer.

^b The engineering staff for the dual-site scenario would require an Engineer and Field Engineer. The single-site scenario would require a Pipeline Engineer/Backup Safety Officer and a Field Engineer.

^c The operations staff for the dual-site scenario would require the following: Safety and Public Awareness Specialist, On Call Center Operators, On Call Pipeliner, Injection Pump Station Technician. Staff would be onsite 5 days per week except the On Call Center Operators would be required 7 days per week.

The conceptual layout for the injection well site, as shown in Figure 2-21, includes a gravel well pad, the site control and maintenance building and a parking lot connected to Beilschmidt Road by two access roads. As summarized in Table 2-11, the single-site scenario would have a permanent overall land area requirement of less than 14 acres. Construction of the injection wells, monitoring wells, associated surface facilities, and access roads for the single-site scenario would collectively disturb approximately 42 acres.

The current design includes an entrance road and an exit road to accommodate construction activities safely. The roads would be designed to occasionally carry a heavy service truck of up to 80,000 pounds. After construction is complete, the entrance and exit roads would be upgraded to an asphalt surface.

Site access to the injection wells would be restricted by a 6-foot high, security fence around the permanent well pad, enclosing 0.72 acre. In addition, there would be an architectural fence (similar to fences found in agricultural and rural areas) surrounding the site control and maintenance building, parking lot, and access roads, enclosing approximately 2 acres. Approximately five monitoring well sites would also be fenced, enclosing between 0.15 and 0.23 acre. The monitoring wells would be covered.

The site control and maintenance building would house the major operational components of the pipeline and injection well site. The current design assumes that the facility would be located in such a way as to allow for visitor observation of the injection wells. A maintenance area would be included to house the equipment needed for routine maintenance of equipment, repair parts, and at

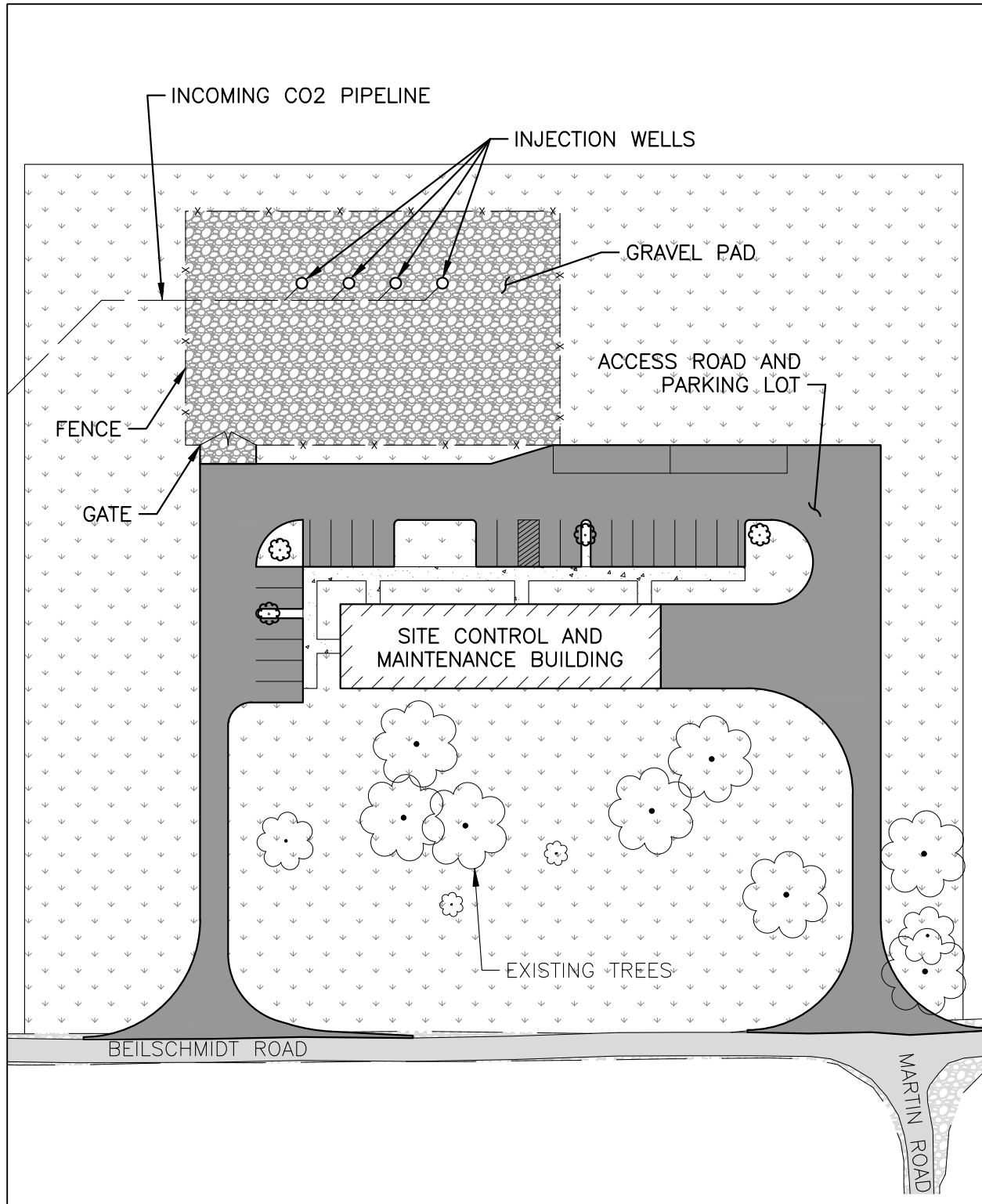

Figure 2-21. Single-Site Scenario - Injection Well Site Surface Features Conceptual Layout

least one site and pipeline monitoring vehicle. The facility would also include a conference room, restrooms (handicapped accessible), and office areas for visiting scientists and Alliance or operations personnel. The total building footprint is expected to be approximately 5,000 square feet.

Dual-Site Scenario

Information about the dual-site scenario, as analyzed in the Draft EIS, is included in the following discussion for purposes of comparison with the single-site scenario; however, the dual-site scenario is no longer under consideration by the Alliance.

The dual-site scenario would require as many as four buildings, including three buildings at the primary injection well site and one at the secondary injection well site. Figures 2-22 and 2-23 present the original conceptual site plans for the injection well surface facilities. The layout shown in Figure 2-22 represents the primary injection well site, and Figure 2-23 represents the layout for a secondary injection well site. Tables 2-11 and 2-12 summarize the site requirements and construction labor, respectively, for the original dual-site scenario in comparison to the planned single-site scenario.

As summarized in Table 2-11, the dual-site scenario would have a permanent overall land area requirement for surface facilities of less than 25 acres. Construction of the injection wells, monitoring wells, associated surface facilities, and access roads for the single-site scenario would collectively disturb approximately 91 acres. Aside from these structures, the area affected during construction of the surface facilities would involve the construction of a stormwater retention and infiltration basin, a packaged wastewater treatment system, screening berms, and fencing.

The entrance road would be a 24-foot wide asphalt surface that would allow two cars to pass safely. The road would support an occasional heavy service truck of up to 80,000 pounds. The parking lot would be asphalt and sized for 15 employees with the potential for additional parking for up to 20 visitors plus bus parking with adequate turning radius.

Site access would be restricted with a 6-foot high security fence enclosing roughly 5 acres. Depending on the monitoring layout, the Alliance may elect to fence the primary injection well site and use 10-foot by 10-foot fenced areas for the other monitoring points. If a secondary injection well site were required, it would be accessed by a gravel road and protected with a 6-foot fence around the wellhead pad.

Site Control Building

The site control building would be located at the primary injection well site approximately 150 feet from one injection well to allow for visitor observation of the well and the booster pump building. Because there is no technical requirement for this distance, local landowner preferences regarding location would be taken into account during final design. The total building footprint would be approximately 5,500 square feet.

Booster Pump Building

If additional pressure were required to facilitate the injection of the CO₂ into the storage formation, a booster pump building **would be included**. If required, the booster pump building would be approximately 3,120 square feet (78 feet by 40 feet). Although the conceptual design assumed that the booster pump building would be located at the primary injection well site adjacent to the injection well pad, the building could be located elsewhere along the pipeline as it approached the injection well sites. The final location of the building would be determined in consultation with local landowners.

Well Maintenance and Monitoring System Building

A well maintenance and monitoring building would be required at each injection well site to supply the well with fluid for annulus pressure. The total area for the building would be 1,000 square feet. For the primary injection well site, the building would be attached to the site control building with a common wall. The well maintenance and monitoring building would be enclosed to minimize noise and visual impacts to surrounding property.

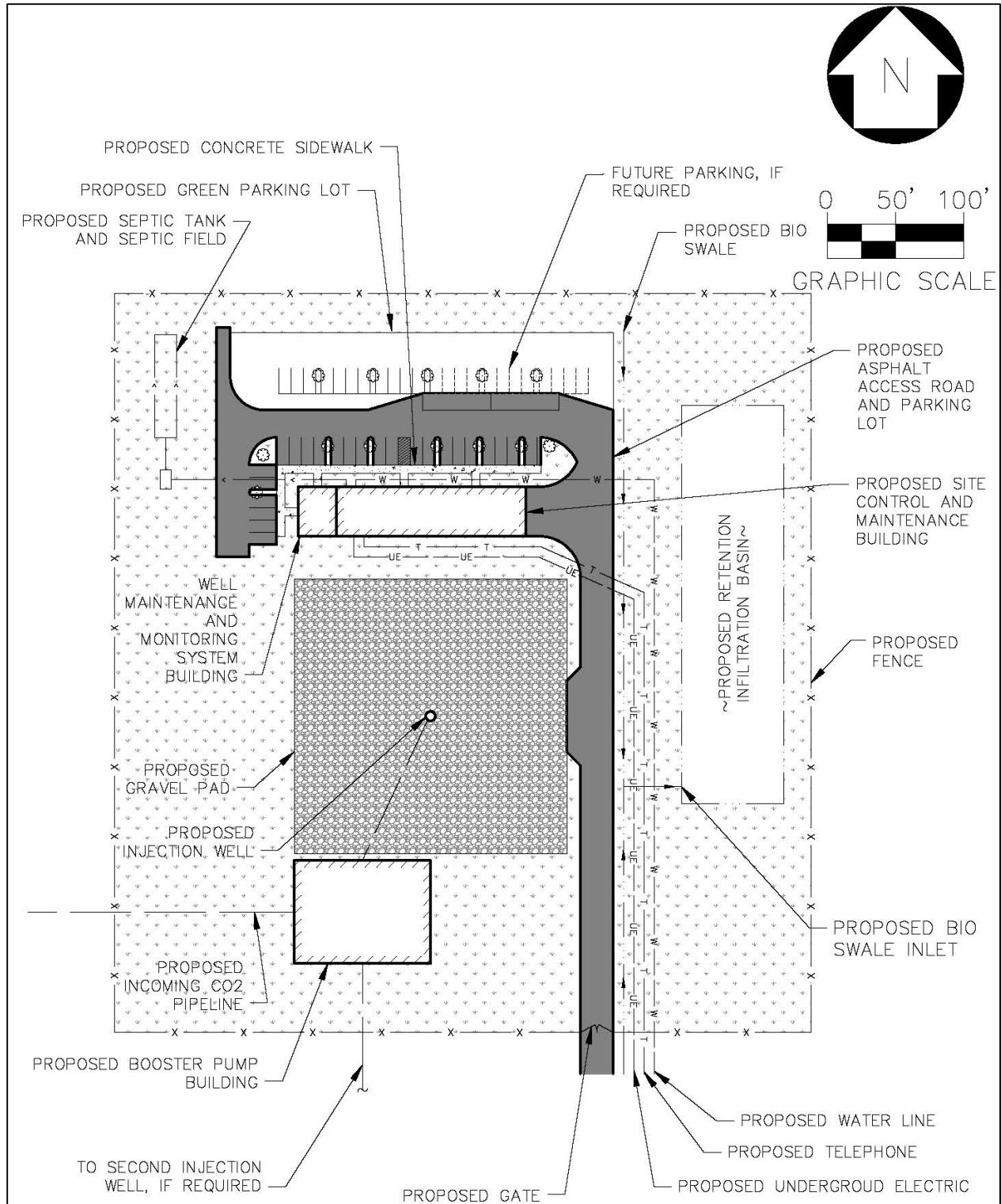

Figure 2-22. Dual-Site Scenario - Primary Injection Well Site Surface Features Conceptual Layout

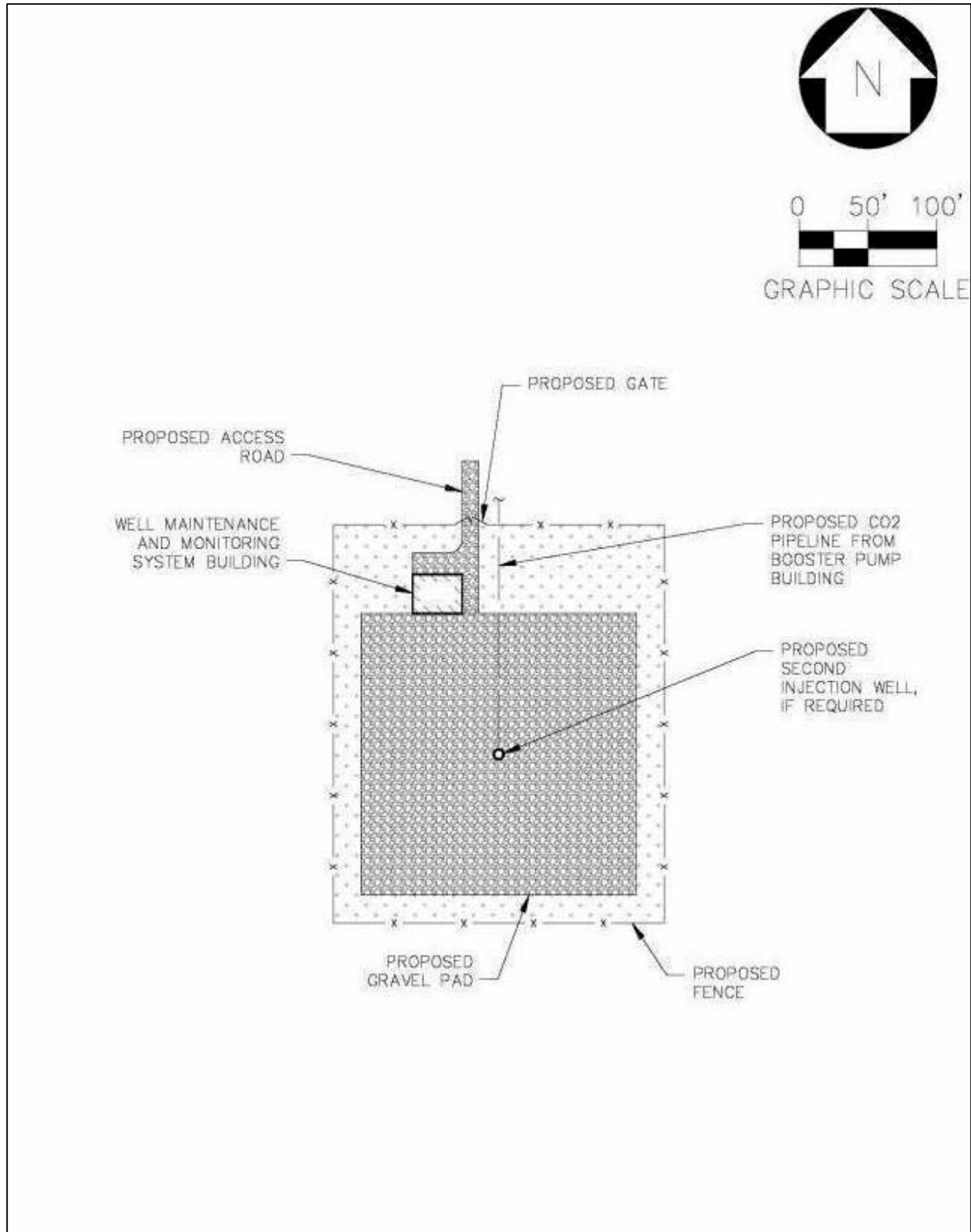

Figure 2-23. Dual-Site Scenario - Secondary Injection Well Site Surface Features Conceptual Layout

Surface Facilities Operation

Single-Site Scenario

The area required for the CO₂ injection wells and supporting facilities under the single-site scenario would occupy less than 10 acres for the permanent operational footprint of the injection and monitoring wells and associated infrastructure and approximately 4 acres for access roads as listed in Table 2-11 above. Approximately 10 to 15 people would be employed to manage and operate the CO₂ pipeline and storage facility as summarized in Table 2-13 above.

All relevant parameters would be monitored and controlled from the site control and maintenance building, including the injection wells, pipeline operations, and site access. The building would contain well annulus maintenance and monitoring system equipment to supply the wells with fluid to maintain annulus pressurization. Maintaining the annulus of the well at a higher pressure than the injection pressure insures that there is no leakage from the injection wells. The well annulus maintenance and monitoring system equipment room would have a programmable logic controller cabinet and an uninterruptible power supply cabinet. The room would be enclosed to minimize noise and visual impacts on surrounding property. The Alliance would conduct a noise analysis of the site and ensure that the facilities would meet the Illinois' noise regulatory standard at all property boundary lines.

Dual-Site Scenario

Information about the dual-site scenario as analyzed in the Draft EIS is included in the following discussion for purposes of comparison with the single-site scenario; however, the dual-site scenario is no longer under consideration by the Alliance.

As listed in Table 2-11, up to 10 acres would be needed for the permanent operational footprint of the injection and monitoring wells and associated infrastructure and buildings, and up to 15 acres for access roads to the wells and supporting facilities. Table 2-13 summarizes the anticipated management and operational personnel requirements to support the injection well facilities.

Site Control Building

The site control building would house the major operational components of the pipeline and injection wells, including the instruments for monitoring and controlling the injection wells, pipeline operations, and site access. A maintenance area would house the equipment needed for routine maintenance of pump equipment, repair parts, and at least one site and pipeline monitoring vehicle. The maintenance area would be approximately 1,600 square feet (40 feet by 40 feet). The facility would also include a conference room, restrooms (handicapped accessible), and an office area for visiting scientists and personnel.

Booster Pump Building

The CO₂ pipeline would enter the site underground and, if additional injection pressure is needed, would emerge at the booster pump building. From there, it would remain aboveground to the injection wells for easy access and visual observation. The building would house the well injection pumps and associated flow meters, flow control valves, and variable speed drive cabinets. It would include an overhead crane for pump maintenance. The injection pump stations would include the following:

- The facility would house three 710 horsepower booster pumps that would boost the CO₂ to the required injection pressure.
- Two of the pumps would be for normal operations and one for backup. Each of the two normal operations pumps would provide the total pumping power required for the injection wells and would be designed to operate continuously under full load. The third pump would be sized to replace one of the normal operations pumps.

- The pump controls and the remote terminal unit metering output would be housed inside the site control building. The pump operation would be designed for remote operation but with local override capability. This would include normal operation, shutdown, and re-start.
- A variable frequency drive would be provided for each pump.
- An emergency generator would be sized to power the pump station and the injection wells. The estimated power requirement for two 710 horsepower booster pumps is 1,111 kW, with continuous operation requiring approximately 799,920 kilowatt-hours (kWh) per month.

The booster pump building would have constant, redundant CO₂ monitoring, which would interface with a lockout security system and a high volume ventilation system. The lockout security system would not allow entrance into the building if high levels of CO₂ are present.

Well Maintenance and Monitoring System Building

A well maintenance and monitoring building would be required at each injection well site and would have a programmable logic controller cabinet and an uninterruptible power supply cabinet. The well maintenance and monitoring building would contain facilities to supply the injection well(s) at that site with fluid to maintain annulus pressurization. Maintaining the annulus of the well at a higher pressure than the injection pressure ensures that there would be no leakage from the injection well.

2.5.2.3 Injection Wells

The Alliance evaluated several different injection well configurations using both horizontal and vertical wells at one or two injection well sites. After consideration of site-specific data from the stratigraphic well and computer modeling, the Alliance is proposing to construct four horizontal injection wells at a single injection well site. Figure 2-24 and Figure 2-25 show the conceptual design for a horizontal and vertical injection well, respectively. All four injection wells would originate from one drilling pad and would operate independently of each other. **The Alliance proposed this configuration in the UIC permit applications (one permit application for each injection well) it filed with the USEPA in March 2013 (revised May 2013).**

Pursuant to an Illinois Commerce Commission ruling on the FutureGen 2.0 Project, the Alliance is proposing a 20-year injection period. The injection wells would be designed to inject 1.2 million tons (1.1 million metric tons) of CO₂ per year over the 20-year injection period for a total of up to 24 million tons (22 million metric tons).⁵ Under normal operating conditions for the currently proposed injection well configuration of four horizontal wells, **two wells would receive approximately 32 percent of total flow (each) and the other two would receive approximately 17 and 19 percent of the flow. Each injection well would be designed to accept up to one-third of the projected flow in order** to provide operational flexibility and backup capability, such that one well could be taken off line while the remaining injection well(s) receive 100 percent of the flow.

Vertical Injection Well – An injection well drilled from the ground surface to a specified depth in a straight (vertical) line.

Horizontal Injection Well – An injection well drilled from the ground surface to a specified depth and then curved to proceed in a horizontal direction.

⁵ On December 10, 2010, the USEPA published a final rule, “Federal Requirements under the Underground Injection Control Program for Carbon Dioxide Geologic Sequestration Wells” (75 FR 77230) (the “Class VI rule”). Under this rule, the USEPA created a new category of injection wells (Class VI wells) with new federal requirements to allow for injection of CO₂ for geologic sequestration to ensure the protection of underground sources of drinking water. In accordance with the Class VI rule, the Alliance would be required to obtain Class VI UIC permits from the USEPA for the FutureGen 2.0 injection wells. In accordance with the Class VI rule, the Alliance would implement a MVA program to monitor the injection and storage of CO₂ within the storage reservoir to verify that it stays within the target formation (see Section 2.5.2.4).

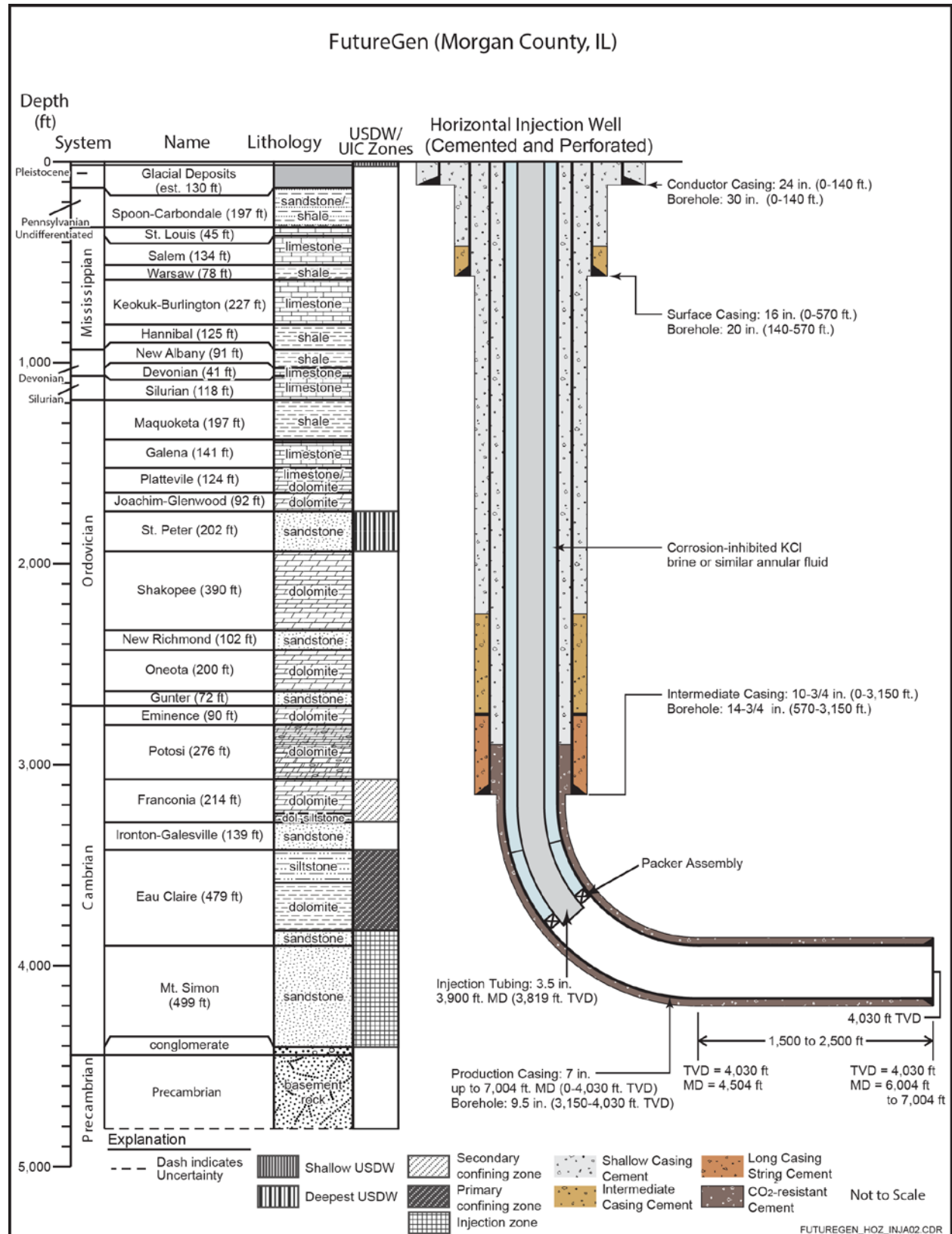

CO₂ = carbon dioxide; ft = feet; in = inch; KCl = potassium chloride; MD = measured depth; TVD = true vertical depth; UIC = Underground Injection Control; USDW = underground source of drinking water

Figure 2-24. Proposed Horizontal Injection Well Construction Details

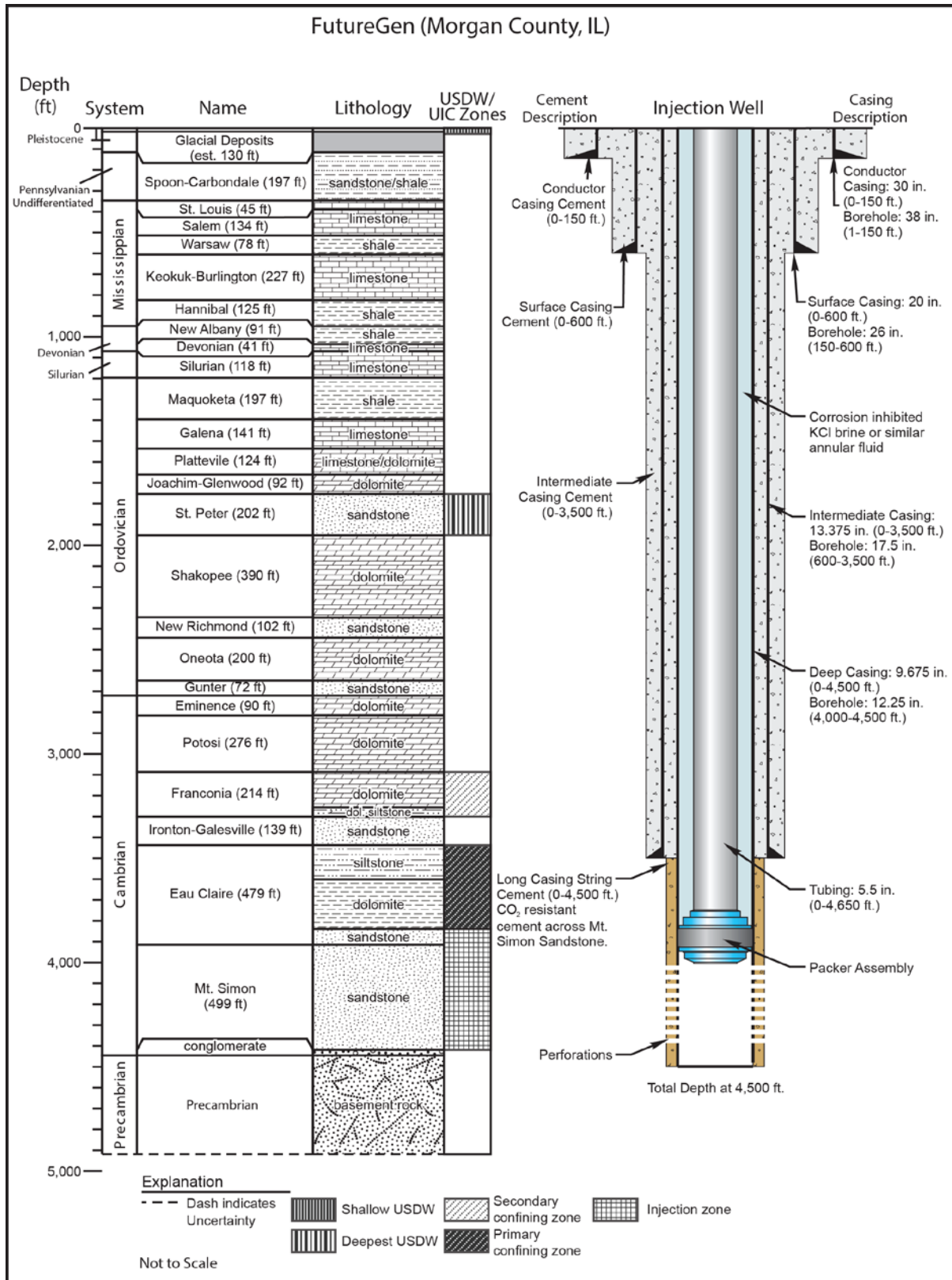

CO₂ = carbon dioxide; ft = feet; in = inch; UIC = Underground Injection Control; USDW = underground source of drinking water

Figure 2-25. Geological Stratigraphic Column for the CO₂ Storage Study Area and Vertical Injection Well Construction Details

The storage reservoir for CO₂ injection and storage is the Mt. Simon Formation, a sandstone formation that is one of the Illinois Basin's major deep saline formations. Figure 2-24 and Figure 2-25 also present the geological stratigraphic column for the CO₂ storage study area, showing the depth and thickness of the Mt. Simon Formation. The bottom of the Mt. Simon Formation at the CO₂ storage study area has been measured to be **approximately 4,400 feet deep**. The injection wells would be drilled to **approximately 4,000 feet bgs**. **Under the Alliance's original vertical well design**, the vertical injection wells would have been over-drilled by approximately 150 feet to allow the casings to be cemented into the Precambrian granite below the Mt. Simon Formation. **Under the Alliance's revised horizontal well design**, the horizontal wells would include a vertical section that extends through the Potosi Formation to an approximate depth of 3,150 feet and a 1,500- to 2,000-foot long horizontal section in the Upper Mt. Simon Formation at an approximate depth of 4,030 feet bgs. Under the Alliance's proposed injection well configuration of four horizontal wells, each well would be oriented along a different azimuth to facilitate efficient distribution of the CO₂ and pore space use.

The Mt. Simon Formation's positive characteristics for CO₂ storage include its isolation from other strata, as well as its depth, lateral continuity, and relative permeability. The Mt. Simon Formation is bounded below by a Precambrian igneous rock and above by the Eau Claire Formation, which is a mixture of dense dolomite and siltstone layers with low permeability. The lower portion of the Eau Claire Formation (i.e., the Elmhurst Member) is comprised of sandstone and would be considered part of the storage reservoir, while the remainder would be considered caprock. The Franconia Dolomite would act as a secondary seal above the Eau Claire Formation.

The Mt. Simon Formation contains a **highly saline** aquifer with estimated total dissolved solids of approximately 48,000 parts per million **at the CO₂ storage study area**. This high level of total dissolved solids exceeds safe drinking water **standards, which are set per federal law at 10,000 parts per million**; thus, this formation is not suitable to serve as a future drinking water source in Morgan County. The Mt. Simon Formation has several characteristics that are beneficial for CO₂ storage; it is consistently deep (over 3,900 feet), laterally continuous, and a relatively permeable formation that is bounded by several impermeable layers. The total thickness of the injection zone (including both the Mt. Simon Formation and the Elmhurst Member) at the CO₂ storage study area is 565 feet thick. The injection would likely focus on the upper third portion of the approximately 500-foot thick reservoir, which is thought to be the most permeable interval and may result in a more effective use of reservoir pore space. However, the perforated interval might also be extended over multiple permeable zones, or even the entire formation, to maximize the injection efficiency of the wells.

Ongoing efforts to characterize the geology at the CO₂ storage study area, including drilling of a stratigraphic well, hydrologic testing, wireline logging, and vertical seismic profiling, have been used to provide an improved geologic understanding of the site. The Alliance conducted computer modeling using data from these efforts to simulate the currently proposed configuration of four horizontal injection wells to predict the areal extent and distribution of the CO₂ plume within the storage reservoir. The results of this analysis are summarized in Appendix G, Geological Report. This report concludes that the CO₂ plume would expand to encompass an area of nearly 4,000 acres over the 20-year injection period, as shown in Figure 2-26. **Figure 2-26 depicts the predicted CO₂ injection plumes after 5, 10, 20, 22, and 70 years. The 22-year plume is the predicted maximum extent of the plume.** The impact analysis in this EIS conservatively assumes that the plume would be **approximately 4,000 acres in size and contained within the 6,800-acre CO₂ storage study area**.

Injection Well Construction

During construction, up to 14 construction workers would work in two 12-hour shifts. Staff would include a **driller and six crew members of the drill staff**. **The drill staff would consist of** a mud logger, a geologist, **four Alliance representatives** (including a drilling engineer and a site coordination

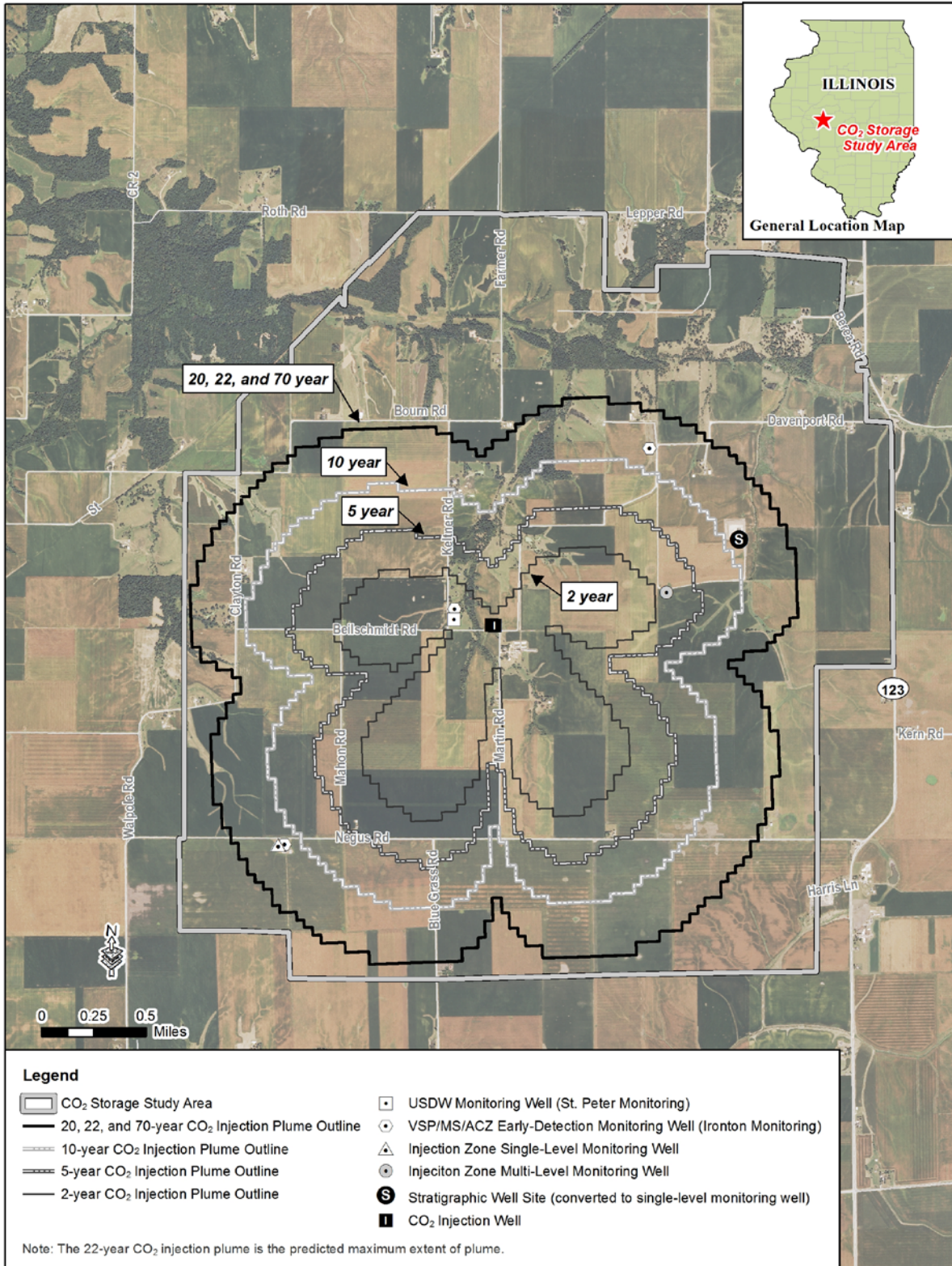

ACZ = above confining zone; CO₂ = carbon dioxide; MS = microseismic; USDW = underground source of drinking water; VSP = vertical seismic profile; yr = year

Figure 2-26. Predicted Areal Extent of CO₂ Plume and Monitoring Well Network for Single-Site Scenario with Four Horizontal Wells

superintendent), and a safety person. Construction duration is estimated to be 100 to 120 days of drilling per well. Once drilling is initiated, drilling would generally occur 24 hours per day, 7 days per week. Figures 2-27 and 2-28 are pictures of typical drill rigs during daylight and nighttime hours.

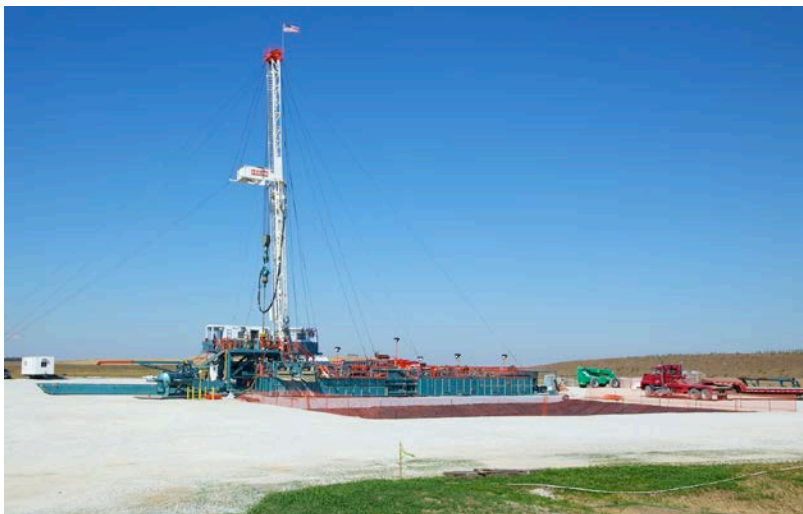

Figure 2-27. Drill Rig during Daytime Operations



Figure 2-28. Drill Rig during Nighttime Operations

As described in the Draft EIS for the dual-site injection well configuration, each drill pad would initially measure approximately 350 feet by 350 feet and would be reduced to a final 200-foot by 200-foot pad after drilling is completed. For the single-site configuration, as currently proposed by the Alliance, a larger well pad would be used, up to 688 feet by 950 feet that would accommodate all four horizontal injection wells. Larger gravel on a geotextile fabric would act as an underlayment with smaller gravel making up the top portion of the drilling pad. The removed gravel would be reused for the construction of access roads to groundwater and other monitoring points. The drill pad would be surrounded by a berm on up to three sides and would be designed with drainage and erosion controls to ensure that stormwater is properly managed. These controls would include covering the berms with topsoil and planting grass seed; placing erosion control blankets on slopes, berms, and ditches around the drilling pad; and seeding stockpiled soil. Lined earthen pits would contain any excess fluids generated during drilling, discarded water used in the cementing process, and spent drilling mud from mud change-outs. The pits, which would measure approximately 100 feet by 60 feet by 10 feet, would be constructed after the drilling pads

are constructed. The earthen pits would be lined with 30-mil high-density polyethylene plastic sheeting with welded seams to prevent infiltration of fluids into the subsurface.

After the drilling pad is constructed, drilling equipment and support facilities would be installed at the well site. Major drilling equipment components would include the drilling rig, a fuel tank, water tanks, pumps for circulating drilling mud, steel pits (tanks) for mud cleaning (i.e., solids settling) and mixing the drilling mud, pipe racks for holding drilling pipe, an electrical generator, and lights. In addition to the drilling rig equipment, the injection well site would include two temporary office trailers and two house trailers.

The injection wells would likely be drilled with a conventional drilling rig and mud system using the same methods and principles as those commonly used in the oil and gas well-drilling industry. Drilling would involve using a drilling fluid (mud) system. Mud lubricates the bit and drill string, removes drill cuttings from the wellbore, and assists with pressure control. A mudlogging trailer equipped with gas-monitoring instrumentation would be used while drilling all sections below the conductor casing to monitor for natural gas and oil, plot drilling penetration rates, and describe the cuttings in the drilling returns.

During the drilling of the injection wells, the Alliance anticipates that the equipment onsite (in addition to the drill rig) would include generators, compressors, backhoes, forklifts, and bulldozers. Approximately 22 semi-trucks would be required to move the drill rig to the site. The largest load would be approximately 87 feet long. The average load would be 100,000 pounds, and the heaviest load would be approximately 160,000 pounds. Trucks would visit the site to deliver fuel, cement, and casing. Trucks would also visit the site during wireline logging, hydrogeologic testing, and coring activities. These activities would occur infrequently and an average of a single truck per day to support these activities is anticipated. Vehicles would also visit the site to service the portable toilets. At completion of the drilling operation, trucks would be used to dispose of cuttings.

The temporary office trailers would be powered by a field generator and would have temporary sanitary services. Water would be provided to the trailers from an onsite water tank. **Based on the drilling of the stratigraphic well (see Section 2.5.2.5), the Alliance estimates that drilling and cementing of each injection well would require approximately 1.33 million gallons of water, with the potential for an additional 840,000 gallons if zones of lost circulation are encountered. Thus, up to a total of 8.68 million gallons of water could be required to drill and cement all four horizontal wells.** The fresh water for the injection wells would be obtained from the North Morgan County Water Cooperative (Co-Op), as it was for the stratigraphic well drilling.

Construction of the injection wells would generate up to **1,100** cubic yards of cuttings. In addition, the drilling fluids and fluid removed from the formation during development and testing would need disposal as a non-hazardous waste. These would be fluids with salinities in excess of 150,000 parts per million.

The Alliance would implement BMPs during construction of the injection wells. These practices would include spill prevention and stormwater runoff management. For spill prevention, the drilling contractor would be required to use secondary containment for all fuel storage tanks to prevent leaked fuel from entering the environment. The preferred method for achieving secondary containment is to use double-walled tanks. If double-walled fuel tanks are not available, lined dikes with a capacity of 1.5 times the volume of the storage tank(s) would be used. Synthetic (plastic) sheeting (30 mil thick) would be laid down beneath all mud pits (steel tanks) and associated circulation equipment, including mud pumps to prevent releases of drilling fluids to the ground surface. The drilling contractor would also install a synthetic liner beneath the rig (rig underliner). The drilling contractor would maintain an inventory of absorbent materials (e.g., pads and booms) in order to respond to any release of engine oil, hydraulic oil, diesel fuel, gasoline, antifreeze, drilling fluids, or any other contaminants as a result of the driller's activities. Any spills involving fuel or other liquid or dry chemicals would be cleaned up immediately,

including any affected soil. All used spill cleanup materials, as well as any affected soil, would be contained and disposed of properly.

In order to properly manage stormwater runoff during injection well installation, the Alliance would obtain a General NPDES Permit for Construction Site Activities from the IEPA. As noted above, the drilling pads would be constructed using stormwater and erosion control measures, including earthen berms around the drilling pads covered with topsoil and seeded with grass; erosion control blankets on slopes, berms, and ditches around the drilling pad; and seeding of stockpiled soil. Surface runoff originating upslope of the drilling pad would be routed beneath the pad through a standpipe with an inlet riser located upslope of the drilling pad connected to a 12-inch pipe buried beneath the drilling pad.

The Alliance examined the potential for encountering drilling hazards. The closest wells that penetrate the Mt. Simon Sandstone are in the Morgan County Waverly Field, approximately **16 miles south-southeast** of the CO₂ storage study area. However, there are several shallow oil and gas producing zones in the Morgan County area, as well as several zones of potential lost circulation. Small volumes of gas or oil are likely to be encountered in the Pennsylvanian section (see Figures 2-24 and 2-25) to a depth of about 350 feet. Hydrocarbons are expected to exist to a depth of about 1,200 feet. There are no records of over-pressured oil and natural gas reservoirs near the proposed site, but all proper safeguards would be used while drilling the well. A mud logging unit equipped with a gas detector and a gas chromatograph would be used to monitor the drill cuttings retrieved from below the conductor casing. Blowout preventers and choke manifolds would be used at all times when drilling below the conductor casing for well control in the event excessive gas is encountered.

Pennsylvanian-aged coals and Mississippian-aged formations at the CO₂ storage study area may contain traces of hydrogen sulfide. A hydrogen sulfide emergency action plan would be reviewed with all onsite workers and a written copy would be maintained in the mud logger's trailer and in the field office trailer. When drilling through potential hydrogen sulfide-bearing zones, all drilling hands would be equipped with a personal monitor and would be instructed in proper safety response by a hydrogen sulfide safety consulting company representative. In the unlikely event hydrogen sulfide is encountered, the safety consulting company would determine the appropriate actions to be taken by the drilling crew and other onsite workers. Windscreens would be set up by the drilling contractor.

Lost mud circulation, which occurs when the drilling fluid flows into a geological formation instead of returning up the annulus, may be encountered **in the area planned for the wells. The stratigraphic well encountered lost circulation in the Potosi Dolomite but did not have an issue in the Ironton Sandstone and Borden Formation, which have been identified as potential zones of lost circulation in Illinois. Those geologic formations are** shown in Figures 2-24 and 2-25. If circulation is lost in one of these or other zones, **lost circulation** material would be added to thicken the drilling fluid. If circulation cannot be restored with such material alone, the zone(s) would be squeezed with a sodium silicate solution and/or cement until circulation is restored and drilling can resume.

Injection Well Operations

The demonstration period, with active injection and monitoring, would begin in 2017 and end in 2022; **however, commercial operations could continue beyond the demonstration period. The CO₂ injection would operate for a total of 20 years.** The Alliance would be financially responsible for post-injection monitoring of the underground CO₂ for up to 50 years after injection ceases in accordance with the UIC permits. In addition to the onsite staff managing and monitoring pipeline and injection well operations, the Alliance expects that two of the staff personnel (3 shifts per day, 7 days per week) would be onsite to continually monitor injection operations. Alternatively, the Alliance could acquire the services of a vendor that would remotely and continuously monitor the injection operations.

Maintenance operations for CO₂ injection wells may include swabbing; sand removal; replacing and repairing tubing, the packer, valves, and sensors; repairing corroded casing; and remedial cementing (USEPA 2011a). The typical wastes generated from such maintenance are brine fluids and sand. Acid

may be employed to remove scaling, if scaling is present in the well hole, in which case acid and scaling residue would be generated. The rigs used for well maintenance are mobile units, which generate wastes such as hydraulic fluids, rig wash water, spent solvents, used lubricating oil, and filters. The frequency of maintenance operations would depend on data from well monitoring, but external mechanical integrity tests are planned at not less than 5-year intervals and maintenance activity would likely coincide with those activities. The truck traffic from the well maintenance would consist of approximately 20 vehicles associated with the maintenance rig.

The solid waste generated from maintenance activities would be transported in dump trucks and would be properly disposed in landfills. The liquid waste from maintenance would be collected and transported in vacuum tanker trucks and hauled to a wastewater treatment plant. The volume of waste material generated during well maintenance would depend on pipe and equipment degradation. While the volume would vary greatly from well to well, it is expected that up to **20** tanker trucks with a capacity of 3,000 gallons each would be required for transporting liquid wastes and up to **10**, 20-yard roll-off dumpsters would be required for transporting solid wastes for each maintenance operation.

2.5.2.4 Monitoring, Verification, and Accounting

An extensive MVA program, including monitoring activities required by the Class VI UIC regulations, would be established in accordance with the Class VI UIC regulations to monitor the injection and storage of CO₂ to verify that it stays within the storage reservoir. The MVA monitoring program would assess the potential for any migration that could adversely affect the shallow underground sources of drinking water (USDWs) or surface or near-surface ecological conditions. Early detection of any storage performance issues would allow for early action to address them through engineering or operational adjustments. The primary objectives of the monitoring program would be the following:

- Track the lateral extent of dense phase CO₂ within the storage reservoir.
- Characterize any geochemical or geomechanical changes that occur within the reservoir and **confirm a lack of migration through the** overlying caprock.
- Verify that there are no negative environmental impacts.

The MVA program would meet injection control permitting requirements and requirements that DOE may impose. Prior to the initiation of injection operations, the Alliance would design and implement the monitoring program to address all requirements of the Class VI UIC regulations and the Greenhouse Gas Reporting Rule. Under subpart RR of the UIC Class VI rule, facilities conducting geologic sequestration are required to report the amount of CO₂ received, develop and implement a USEPA-approved MVA plan, and report the amount of CO₂ sequestered using a mass balance approach. In addition, the Class VI rule requires operators of Class VI wells to develop, gain approval for, and implement five project-specific plans, including: an Area of Review (AoR) and Corrective Action Plan, a Testing and Monitoring Plan, an Injection Well Plugging Plan, a Post-Injection Site Care and Site Closure Plan, and an Emergency and Remedial Response Plan. These plans would outline the monitoring techniques that would be implemented in support of the project. Monitoring procedures may be added or removed, or the duration of monitoring activities may be changed depending on the characteristics of the CO₂ plume.

The Post-Injection Site Care and Site Closure Plan are implemented to ensure that the well owner/operator has approval from the UIC Program Director for the procedures to be followed after injection operations cease. The Post-Injection Site Care and Site Closure Plan would also help identify the appropriate types and amounts of data needed to verify that the CO₂ plume and pressure front do not endanger USDWs, and it would support a determination of whether conditions warrant site closure and therefore an end to post-injection site care (i.e., there is no longer a risk of endangerment to USDWs). The plan would identify the types and duration of monitoring that would occur; the minimum post-injection site care duration is 50 years unless otherwise approved by the UIC Program Director. The Emergency

and Remedial Response Plan would identify the actions that would be necessary in the unlikely event of an emergency at the site. The plan would ensure that site operators know which entities are to be notified and what actions would need to be taken to expeditiously mitigate any emergency situation and protect human health and safety and the environment. The specific actions that would need to be taken would depend on the initiating event and any resulting effects.

The Class VI UIC regulations also require the well owner/operator to demonstrate and maintain financial responsibility as determined by the UIC Program Director (under 40 CFR 146.85). Financial responsibility extends to the costs that may be associated with: (1) corrective action, (2) injection well plugging, (3) post injection site care and site closure, and (4) emergency and remedial response. The financial responsibility must be sufficient to address endangerment of USDWs. The Alliance's Supporting Documentation for its Class VI UIC permit applications was submitted to the USEPA in March 2013 and revised in May 2013 in accordance with the USEPA's completeness review. The documentation is posted at the USEPA UIC website for public access (<http://www.epa.gov/r5water/uic/futuregen/index.htm>). The Supporting Documentation for the Class VI UIC permit applications addresses respective information in Sections 7.0, Post-Injection Site Care and Site Closure Plan; 8.0, Class VI Emergency and Remedial Response Plan; and 9.0, Financial Responsibility. As explained in Section 9.0 of the Supporting Documentation, the Alliance would obtain insurance and would establish a trust fund to ensure that sufficient funds are available to meet its financial responsibility in accordance with the UIC regulations.

As documented in the plans addressed above, the MVA program would include monitoring that starts before injection activities are initiated and continues throughout the project and after closure of the injection wells. As part of the MVA program, the Alliance would establish baseline measurements of natural CO₂ at the site of the injection wells and in the soil, groundwater, and atmosphere. Soil gas monitoring would be used to evaluate baseline CO₂ concentrations and would provide a means of assessing potential increases in CO₂ concentration at the surface during operations. The Alliance identified preliminary locations for soil gas monitoring within the CO₂ storage study area and screened these areas for the presence of cultural and biological resources. No cultural resources or threatened or endangered species were found at these locations (see Appendix B, Consultation Letters, and Appendix F, Cultural Surveys). Soil gas monitoring would involve the installation of a shallow probe up to 5 feet in depth, which would be used to conduct long-term monitoring of soil gas. **Other geophysical monitoring techniques, such as seismic and electrical resistivity methods (see Section 2.5.2.5 Interim Actions), would be evaluated for tracking the CO₂ in the subsurface. The most effective method would be selected for long-term monitoring.**

The Alliance characterized the injection and confining zones and designed the injection wells to minimize the potential of a CO₂ release. If, however, an adverse event were to occur during construction or operation, the Alliance would deploy a variety of emergency or remedial responses, depending on the characteristics of the event (e.g., the location, type, and volume of a release). The immediate response would be to stop drilling or injection, in order to assess the situation. The Alliance would then conduct an investigation to determine the cause of the event by reviewing the monitoring records, checking the well casing, annulus seals and down-hole pressure, or performing geophysical surveys. Depending on the cause of the event, several remediation solutions could be implemented, including repairing the well casing, lowering the reservoir pressure by removing brine or CO₂, increasing the upstream reservoir pressure (e.g., creating a hydraulic barrier), diverting the CO₂ stream, or modifying the injection flow rate or quantity. In certain situations, an injection well could be sealed with cement, or USDW groundwater remediation could be implemented if necessary. The individual procedures, based on the event, **are described in the MVA plan included in the Supporting Documentation for the Class VI UIC permit applications under Section 5.0, Testing and Monitoring Plan.**

In addition, the data collected from the MVA program would allow the Alliance to proactively manage the CO₂ plume so that it remains beneath the CO₂ storage study area. In the unlikely event that

monitoring indicates that the plume has the potential to migrate off the study area, the Alliance could make adjustments to the injection rate or the duration of the injection period to prevent this from happening.

Monitoring Wells

The MVA monitoring program would require a network of monitoring wells that would be used for containment monitoring and CO₂ plume tracking. The wells would be designed to confirm the ongoing integrity of the primary caprock seal and assess the potential for any identified migration that could adversely affect the quality of the shallow underground drinking water aquifers or surface or near-surface ecological conditions. The monitoring wells would be used to track the lateral extent of liquefied CO₂ within the targeted reservoir, characterize any geochemical or geomechanical changes that occur within the reservoir and overlying caprock that may affect containment, and determine whether the injected CO₂ is effectively contained within the reservoir. The monitoring wells would be located in accordance with the requirements of the USEPA's Class VI UIC permits. **Table 2-14** lists the injection and monitoring wells that the Alliance expects to construct and operate **in its proposed single-site scenario** and describes the land area that could be affected. **For comparison, Table 2-15** lists the injection and monitoring wells **and potential land area affected for the dual-site scenario described in the Draft EIS**. Any monitoring wells extending into the storage reservoir would be designed with an effective, long-term seal through the overlying caprock. **Figure 2-26 illustrates the Alliance's currently planned monitoring configuration as presented in the UIC permit applications. The monitoring well locations shown on the figure are representative but approximate and subject to landowner agreement and UIC permit approval.** It is anticipated that the monitoring well network would consist of the following wells, at a minimum:

- Two single-level wells would be located near the predicted lateral extent of the **5- to 25-year** CO₂ plume.
- One multi-level deep well would be located within the predicted lateral extent of the **2- to 5-year** CO₂ plume. This well would be designed to measure pressures and geochemistry at several different **depth intervals within the injection zone**.
- **Three** above-confining-zone early detection monitoring wells would be installed within the first permeable interval above the Eau Claire Siltstone/Shale Unit (**most** likely in the Ironton Sandstone). The wells would be located **in the vicinity of the injection well drill pad, within the region of highest pressure buildup**. These wells could also be used for vertical seismic profiling or microseismic monitoring.
- A single regulatory compliance well would be installed within the St. Peter Sandstone, the lowermost USDW aquifer, although the aquifer is not used for drinking water in Morgan County due to its high salinity levels. The compliance well would be near the above-confining-zone, early detection monitoring well and within the region of highest pressure buildup.
- Up to five microseismic, shallow wells (up to 200 feet deep) may also be drilled.
- Up to 10 nearby farm or residential wells would also be monitored.⁶

⁶ The Alliance would monitor for major cations (aluminum, barium, calcium, iron, potassium, magnesium, manganese, sodium, silicon); RCRA trace metals (antimony, arsenic, barium, cadmium, chromium, copper, lead, mercury, selenium, thallium); anions (chloride, bromide, fluoride, sulfate, nitrate, carbonate); gravimetric total dissolved solids; alkalinity; dissolved inorganic carbon; total organic carbon; stable isotopes ratios of deuterium/hydrogen, carbon 13/carbon 12, and oxygen 18/oxygen 16; perfluorocarbon, sulfonate tracers; pH; specific conductance; and temperature.

Table 2-14. Surface Area Impacted by Injection and Monitoring Well System for the Single-Site Scenario

Well Type	Number of Pads	Number of Wells	Construction Area			Permanent Area		
			Dimensions (feet)	Unit Area (acres)	Total Area (acres)	Dimensions (feet)	Unit Area (acres)	Total Area (acres)
Injection Wells and Well Pad	1	4	688 x 950	14.52	14.52 ^a	150 x 210	0.72	0.72
USDW Monitoring Well and Early Detection Monitoring Well^b	1	2	450 x 450	4.65	4.65	100 x 100	0.23	0.23
Mt. Simon Formation Multi-Level Monitoring Well	1	1	450 x 450	4.65	4.65	80 x 80	0.15	0.15
Early Detection Monitoring Well^b	1	1	450 x 450	4.65	4.65	80 x 80	0.15	0.15
Injection Zone Single-Level Monitoring Well^c	1	1	450 x 450	4.65	4.65	80 x 80	0.15	0.15
Injection Zone, Single-Level Monitoring Well and Early Detection Monitoring Well^b	1	2	450 x 450	4.65	4.65	100 x 100	0.23	0.23
Microseismic Wells (Shallow)	5	5	75 x 75	0.13	0.65	10 x 10	0.002	0.01
Total (Wells)^d	11	16						
Road Type								
Asphalt Surface, Injection Site Access Road	-	-	600 x 75	-	1.0	- ^e	-	1.0
Gravel Surface, Monitoring Well Access Roads (upgraded and new)	-	-	6,000 x 25	-	3.4	6,000 x 25	-	3.4

^a This number reflects the total construction area at the injection well site. Construction of the injection wells and well pad would occur simultaneously with all other facilities associated with the CO₂ injection well site including building, sidewalk, parking, and infrastructure.

^b Would also be used for vertical seismic profiling, microseismic monitoring, and as above-confining zone early detection monitoring well.

^c This assumes that the stratigraphic well would be converted to a single-level monitoring well for the injection zone. The land was already disturbed during construction of the stratigraphic well and already includes an access road.

^d See Table 2-11 for total acreage of construction and permanent areas.

^e Varies.

Note: This table reflects estimates for a single injection well site with four injection wells.

Table 2-15. Surface Area Impacted by Injection and Monitoring Well System for the Dual-Site Scenario

Well Type	Number of Pads	Number of Wells	Construction Area			Permanent Area		
			Dimensions (feet)	Unit Area (acres)	Total Area (acres)	Dimensions (feet)	Unit Area (acres)	Total Area (acres)
Primary Injection Well Site and Monitoring Well	1	2 ^a	350 × 350	2.81	2.81	200 × 200	0.92	0.92
Secondary Injection Well Site	1	1	350 × 350	2.81	2.81	200 × 200	0.92	0.92
Mt. Simon Formation Single-Level Monitoring Wells ^b	2	2	350 × 350	2.81	5.62	200 × 200	0.92	1.84
Mt. Simon Formation Multi-Level Monitoring Well	1	1	350 × 350	2.81	2.81	200 × 200	0.92	0.92
Vertical Seismic Profiling Wells	3	3	350 × 350	2.81	8.43	200 × 200	0.92	2.76
Microseismic Wells (shallow)	3	3	75 × 75	0.13	0.39	10 × 10	0.001	0.003
Total (Wells)	11	12						
Road Type								
24-foot Asphalt Surface Site Road	-	-	1 mi × 75 ft	-	9.08	1 mi × 40 ft	-	4.85
12 foot Gravel Access Roads (upgraded and new)	-	-	6 mi × 75 ft	-	54.50	6 mi × 12 ft	-	8.73

^a Two wells denote an injection and monitoring well co-located within one pad. The monitoring well would be an above-confining zone early detection monitoring well.

^b This assumes that the stratigraphic well would act as a Mt. Simon Formation multi-level monitoring well for the **primary** injection well.

Note: This table reflects estimates for two injection well sites, since it represents a more conservative scenario (i.e. larger surface area) for the purposes of impact analysis. Under the single well site scenario, a larger well pad (up to 640 feet by 500 feet) would be required.

ft = feet; mi = miles

Monitoring Well Construction

Construction of the monitoring wells required for MVA activities would be conducted in a similar manner to that described for the injection wells. The footprint areas of disturbance are presented in Tables 2-14 and 2-15 for the single-site and dual-site scenarios, respectively. The water required and waste generated would also be similar to the injection wells, but in amounts proportional to their diameters and depths.

Communications are intended to be wireless; however, new electrical lines may be constructed to reach each monitoring well site, in which case approximately 2 miles of new line would be installed. For **single-phase** low voltage rural lines, pole spacing of 320 feet can be assumed. With 320-foot pole spacing, 33 wooden single poles would be placed. Pole placement would be along existing roads or new access roads. An alternative for supplying electricity to monitoring wells would be photovoltaic solar panels with batteries at each monitoring well location. This would decrease the total construction impact, although it would entail higher maintenance cost and activity over the life of the project.

The current conceptual design would require less than 1 mile of new electrical lines, which would only require 17 wooden electrical poles. The Alliance is also exploring the potential for supplying electricity to the monitoring wells using photovoltaic solar panels with battery storage at each

monitoring well location. The use of solar panels would decrease the total construction impact, although it would entail higher maintenance costs and activity over the life of the project.

Monitoring Well Operations

Monitoring operations would be performed at the monitoring wells in accordance with the Class VI UIC permits. Monitoring would be performed throughout the project and during the post-injection monitoring period. **Monitoring operations would be finalized once the UIC permits have been issued for the project.**

2.5.2.5 Interim Actions

Stratigraphic Well

Under its cooperative agreement with DOE, the Alliance proposed to drill a stratigraphic well at the CO₂ storage study area to obtain subsurface data regarding, among other things, the porosity and permeability of the Mt. Simon Formation at that specific location. DOE determined that the activities **related to the stratigraphic well** were needed for the purposes of data collection and would be allowable under NEPA as interim actions, because they would not have an adverse environmental impact or limit the choices of reasonable alternatives for the project. **The Alliance completed construction of the stratigraphic well in December 2011.**

The Alliance constructed the stratigraphic well on **2.2 acres** of privately owned land at the CO₂ storage study area in Alexander, Illinois. In conjunction with the construction, the Alliance also proposed to make road improvements at the intersection of Beilschmidt Road and County Road 123, as well as along Beilschmidt Road, west of County Road 123, and on a privately owned farm road to allow access of heavy equipment to the stratigraphic well site on the property. All affected property owners agreed to allow the Alliance the use their properties for these purposes.

DOE's approval was based on the following factors considered in its environmental review:

- The stratigraphic well site is not within a floodplain.
- Results from a field study confirmed that the site is not located in a wetland (see Appendix D, Wetland Surveys [D3]). A non-jurisdictional strip of grassy vegetation is present along the west side of a stream more than 200 feet from the stratigraphic well pad area. The stream is a tributary of Indian Creek and is a jurisdictional wetland by definition. The grassy strip ranges in width from approximately 5 feet at its narrowest point to more than 10 feet at its widest points, and it serves as a buffer between agriculturally-disturbed soils on its west side and the stream on its east side.
- Results from a survey confirmed that there are no federally-listed or state-listed plant or animal species or critical habitat located on or adjacent to the site (see Appendix E, Biological Surveys [E4]).
- Although the site and surrounding acreage were assumed to be prime or unique farmland, topsoil would be stockpiled, and the area would be restored following the removal of the drilling equipment, except for a portion of the gravel pad and an access road needed for long-term monitoring.
- There are no state or national parks, forests, conservation areas, or other areas of recreational, ecological, scenic, or aesthetic importance on or adjacent to the proposed site.
- There are no wild and scenic rivers or other potentially sensitive resources (e.g., timber, range, minerals, fish, wildlife, waterbodies, or aquifers) on, below, or adjacent to the proposed site.

- Based on the results of a field survey of the proposed site, the Illinois SHPO agreed that the property does not include any sites having historic, archaeological, or architectural significance (including sites on or eligible for the NRHP and the National Registry of Natural Landmarks).
- There are no Native American tribes or traditional cultural properties located on or adjacent to the proposed well site.

In accordance with the proposed activities approved by DOE, the Alliance initiated drilling of the stratigraphic well in October 2011 and completed the stratigraphic well in December 2011. The drilling of the stratigraphic well involved the following specific activities:

- Minor improvements to approximately 1.2 miles of Beilschmidt Road, west of County Road 123. These improvements consisted of improvements to the intersection of County Road 123 and Beilschmidt Road, including construction of pullouts along Beilschmidt Road, and widening of 90-degree turns to accommodate truck traffic. At the landowners' request, these improvements remained in place following completion of drilling.
- Minor improvements to approximately 1 mile of a farm road to allow access to the property. The existing dirt road was compacted and surfaced with gravel for 12 feet in width.
- Construction of approximately 1 mile of a water supply line from a connection on Beilschmidt Road to the stratigraphic well drill pad. This temporary, aboveground water line was located partially within the non-jurisdictional grassy strip. Impacts to this grassy strip were minimized by hand-delivering supplies during construction and using low-pressure single-seat all-terrain vehicles as needed. All aboveground temporary piping was removed after drilling operations were completed.
- Site preparation such as grading and construction of an in-ground reserve pit measuring approximately 100 feet long, 50 feet wide, and 12 feet deep. Topsoil was stockpiled in a berm for later site restoration and to provide a noise barrier for the benefit of nearby residents.
- Removal of a disused and deteriorating shed at the request of the landowner. Debris material, such as steel, was recycled to the fullest extent possible; any remaining debris was trucked to a nearby landfill.
- Construction of a compacted gravel drill pad approximately 350 feet by 350 feet in size. In addition to the well, the drill pad accommodated associated equipment and several trailers.
- Transportation of equipment, materials, and workers to and from the proposed site. Truck traffic occurred during construction of road improvements, site preparation, construction of the drilling rig, removal of the drilling rig, and site restoration. During the construction of the road improvements and site preparation, truck traffic was limited to the hours between 8 a.m. and 5 p.m. and occurred 6 days per week. The increase in truck traffic was temporary.
- Drilling of the stratigraphic well approximately 4,800 feet deep. The Alliance obtained a well-drilling permit from the IDNR, Division of Oil and Gas. A drill rig was onsite for approximately 150 days (a large rig was onsite for approximately 90 days and a smaller rig was onsite for an additional approximately 60 days). During that time, noise and vibrations were generated 24 hours per day, 7 days per week, for a total of approximately 90 days. Site layouts were adjusted to mitigate potential noise impacts; this included placement of the stockpiled topsoil in a berm and placement of trailers to form noise barriers between the site and local residents. Affected landowners and residences were informed of the potential for temporary noise and vibration disturbances prior to the start of construction. The stratigraphic well was lined with steel pipe, which is readily available. All wastes generated were non-hazardous and were disposed of

at local disposal facilities. There are at least two solid waste disposal facilities within 50 miles of the stratigraphic well site.

- Removal of equipment and restoration of construction area after completion of the drilling. A small portion of the gravel pad surrounding the stratigraphic well and an access road remains for long-term access to the well for monitoring purposes. The remainder of the site would be restored to its original condition.

Data from the stratigraphic well confirmed that the local geology is suitable for CO₂ storage. **This data was included as part of the Class VI UIC permit applications the Alliance submitted to the USEPA.**

Electrical Resistivity Tomography Monitoring

The Alliance proposed to initiate an electrical resistivity tomography monitoring program to evaluate the feasibility of this monitoring technique to support the MVA system for the project (Alliance 2013b). Electrical resistivity tomography is a geophysical method capable of producing a three dimensional image of the subsurface that may be used for monitoring the lateral extent of injected CO₂. DOE determined that the proposed monitoring activities would be allowable under NEPA as an interim action, because they would not have an adverse environmental impact or limit the range of reasonable alternatives for the project. DOE's approval of the monitoring program was based on the following facts:

- The Alliance would conduct cultural and biological surveys at each electrical resistivity tomography location to ensure that no sensitive resources are located that cannot be avoided.
- The Alliance would provide DOE with the cultural and biological surveys when complete.

Under this monitoring program, a temporary array of 18 electrodes would be placed along the side of Beilschmidt Road for a period of approximately 1 week. At each sample location, a 4-foot by 4-foot shallow excavation would be completed that is 6 inches deep. Electrode rods would be driven into the center of each excavation to a depth of approximately 3 feet. The electrodes would be removed and any surface disturbance would be backfilled and returned to its original condition after the monitoring has been completed. In preparation for this monitoring program, the Alliance met with the Morgan County road supervisor and received approval to use the ROW. The Alliance also established a process to contact the Illinois Joint Utility Location Information Exchange to ensure no interference would occur with buried utility lines.

The Alliance completed environmental and cultural surveys in some parts of this area in support of the soil gas monitoring stations. Additional environmental and cultural surveys would be conducted to ensure complete coverage of the areas that would be used to support the electrical resistivity tomography monitoring program. Since the electrodes would be placed along roadways in already disturbed ROWs, sensitive resources are not anticipated to be found. In the event that sensitive resources are found at a planned sample location, the sample site would be moved to a nearby location that is free of any sensitive resources. In addition, electrodes would not be installed in areas that would interfere with agricultural production.

Additional Surface Monitoring Activities

The Alliance has undertaken or intends to undertake several site characterization activities prior to the issuance of a Record of Decision. The Alliance sought and received interim action authority from DOE in accordance with 40 CFR 1506.1 and 10 CFR 1021.211 to conduct these activities. Although they generally involve some minor ground disturbance, the Alliance conducted field studies to confirm the absence of any sensitive resources that could be adversely affected. Because they are site characterization activities only—most in support of permit applications—DOE has

authorized these activities because they do not adversely affect the environment and do not affect the choice of reasonable alternatives. These activities would include the following:

- **Hyperspectral remote sensing data ground-truthing.** Access would be required during peak growing season to survey crop vigor across the study area. Sensitive areas would be avoided. Staff would walk into fields where access is permitted and visually inspect crop cover. Ground-truth survey locations would not be identified until hyperspectral flyover data have been evaluated, but this would be a low impact activity with no permanent monitoring equipment installation.
- **Surface water monitoring.** A water quality parameter monitoring station would be installed in an existing farm pond northeast of the injection site. Access, with landowner permission, would be required during installation and periodically during the 2- to 3-year monitoring period for operations and maintenance activities.
- **Shallow USDW monitoring.** Groundwater samples would be collected from the same network of landowner wells that the Illinois State Geological Survey sampled in 2012.
- **Leak detection field test.** This test would be conducted in late summer or early fall and would involve releasing a tracer (i.e., naturally occurring isotopes) at the injection well site and performing mobile atmospheric monitoring to demonstrate detection capability. Air monitoring would occur along county roads, so access onto private property would not be required.

2.5.3 Visitor, Research, and Training Facilities

The Alliance would construct and operate visitor, research, and training facilities (also referred to as the educational facilities) at suitable locations in the Jacksonville area to support public outreach and communication, and to provide training and research opportunities associated with near-zero emissions power and CO₂ capture and storage technologies. These facilities would:

- Familiarize visitors with the inner workings of the oxy-combustion facility, the CO₂ pipeline, and the CO₂ storage project area, as well as other local points of interest. **It is anticipated that visitors and researchers from across the country and the world would visit the CO₂ injection well site and the oxy-combustion system in Meredosia.**
- Provide research opportunities focused on monitoring processes and results, including improvements to monitoring system designs.
- Educate and train trade workers, technicians, engineers, and scientists to manage and monitor CO₂ sequestration operations and about near zero emission power generation technologies.

The Alliance originally assumed that one building would house the visitor center and research functions and that a second building (possibly at a separate location) would house the training function. Since the completion of the Draft EIS, the Alliance modified its plans such that the current conceptual design assumes that the visitor, research, and training facilities would be housed in a single building, rather than two separate buildings. The remainder of this section summarizes the original conceptual plans for multiple educational buildings in comparison with the Alliance's current plans for a single building. The intended general location for the educational facilities is the vicinity of Jacksonville, Illinois, which is the largest community in Morgan County **and the analysis of impacts in the Final EIS remains generally focused on the Jacksonville vicinity.**

The Alliance has been working with local stakeholders to identify the location or locations that would be advantageous to the FutureGen 2.0 Project and to the local community. Discussions between the Alliance and Jacksonville authorities have recently focused on the prospect of locating the educational facilities within a 5-acre parcel in the northeast portion of Jacksonville Community

Park. The location is adjacent to West Morton Avenue and South Main Street on the south side of the Jacksonville downtown area, and it is currently occupied by offices of the Jacksonville Area Chamber of Commerce, which would be demolished if the site were used. Construction of the educational facilities would disturb a maximum of 3.5 acres but would not affect the existing Ferris wheel near the corner of West Morton Avenue and South Main Street. The Community Park is a landscaped urban park that includes public structures, the Jacksonville Area Senior Center, playgrounds, soccer fields, internal roadways, and parking areas. South Main Street and Morton Avenue both provide access to Jacksonville from I-72, and the parcel is adjacent to all necessary utility infrastructure. No decision has been reached with respect to the use of this potential location.

2.5.3.1 Educational Facilities Construction

The proposed site or sites for the educational facilities would be areas that have been previously disturbed, with utilities (e.g., electricity, telecommunications, water, and sewer) located on or immediately adjacent to the site or sites. These educational facilities could involve new construction, rehabilitation of existing structures, or a combination of new construction and rehabilitation. However, for purposes of impact analyses in this EIS, DOE assumes a worst-case scenario involving all new building construction.

The Alliance intends that the educational facilities would have green building design elements. DOE intends to support LEED certification to the extent that the costs would be fair, reasonable, and within the scope of the Alliance-DOE Cooperative Agreement. Design, construction, and maintenance would strive to integrate the principles of universal and sustainable design and advanced energy technology as appropriate and feasible. The materials would be typical for new building construction; concrete, steel, wood, dry wall, insulation, glass, and roofing material.

Under the current single-building conceptual design, the Alliance is planning to pursue the following design concepts, which DOE intends to support to the extent that the costs would be fair, reasonable, and within the scope of the Alliance-DOE Cooperative Agreement:

- **The visitor, research, and training facility site would be located in Jacksonville, Illinois. It would be accessible to the community's higher education complexes and located near traveler amenities such as hotels and restaurants.**
- **The distinct functions of the visitor, research, and training facility would be physically separated where necessary, although the facility would have common areas.**
- **Entrances, interior spaces and restrooms would be handicapped accessible.**
- **A multi-function auditorium to serve all three aspects of the facility is under consideration. The Alliance assumes this would have a multi-media capability and seating designed for presentations or community events.**
- **The visitor component would include an open group gathering space, information desk, media displays, auditorium, static and interactive displays illustrating the process steps.**
- **The research component would include office areas and meeting space for visiting scientists and FutureGen personnel. The research component could also include data links to monitoring functions at the energy center and CO₂ injection well site and potentially provide laboratory space for testing and analysis of geologic materials, gases, and groundwater.**
- **The building is assumed to have a large open-space training area for equipment and site control simulation and additional classroom and lecture hall space.**
- **The visitor, research, and training building footprint is assumed to be between 40,000 and 45,000 square feet. The building structure is assumed to meet and exceed the American**

Society of Heating, Refrigerating and Air-Conditioning Engineers, Inc. (ASHRAE), Illuminating Engineering Society of North America Standard 90.1 for building envelope requirements.

- The building would be built using green building design elements and would strive to integrate the principles of universal and sustainable design and advanced energy technology as appropriate and feasible. The exterior landscaping vegetation would be local prairie species that are drought resistant. Deciduous trees would be provided primarily within the parking lot area to reduce heat islanding. Backup power would be provided by a natural gas generator.

DOE based the impact analysis on the Alliance’s conservative scenario whereby the building or buildings that would house the educational facilities would be single story (for a scenario with the largest surface area disturbance); and further, that the Alliance would construct a new building or buildings, as opposed to renovating existing buildings. Table 2-16 presents the construction requirements for the educational facilities for a configuration of two buildings (as analyzed in the Draft EIS) and for the current conceptual design that consolidates all the facilities into one building. The one-building configuration would result in a smaller operational footprint than the original two-building design, and thus less of an impact on the physical environment. The one-building configuration would require a shorter construction duration and less of a construction workforce.

Table 2-16. Construction Requirements for Educational Facilities

Component	Two Buildings			One Building
	Visitor and Research Center	Training Facility	Total for Both Buildings	Visitor, Research, and Training Facilities
Area Requirements (sq.ft.):				
Building	22,000	20,000	42,000	42,000
Sidewalks	5,000	5,000	10,000	6,000
Parking Lot	30,000	20,000	50,000	35,000
Total Area	57,000	45,000	102,000	83,000
Construction Disturbance	85,000	67,000	152,000	152,000
Labor Requirements:				
Total Labor Hours	95,000	79,000	174,000	95,000
Design Duration (months)	9	7.5	16.5	9
Design Workforce (people)	5	5	10	5
Construction Duration (months)	13	13	26	12
Construction Workforce (people)	42	35	77	42
Material Deliveries (truck trips)	400	400	800	800
Debris Generated (tons)	43	39	82	82

sq.ft. = square feet

2.5.3.2 Educational Facilities Operations

The Alliance assumes that collectively the visitor, research, and training facilities would employ 22 full-time employees as follows: a facility director, an operations director, administrative assistants, information desk staff, information technology staff, and maintenance staff. Approximately 10 outside researchers could be accommodated onsite at any one time. The visitor and research center would be open

6 days per week for 9 hours per day. The training facility would be open 12 hours per day for six days per week. An estimate of 10,000 to 20,000 annual visitors would be anticipated with a significant percentage of that number being from local students arriving in buses. **Table 2-17 presents the operational requirements for the educational facilities for a configuration of two buildings and for the current conceptual design that consolidates all the facilities into one building.**

Table 2-17. Operational Requirements for Educational Facilities

	Two Buildings			One Building
	Visitor and Research Center	Training Facility	Total for Both Buildings	Visitor, Research, and Training Facilities
Full-time Employees	7	15	22	22
Energy Use (Btu/yr)	1,480,000	1,350,000	2,830,000	2,831,000
Natural Gas Usage (therms/yr)^a	8,000	2,000	10,000	15,300^b
Water Usage (gal/yr)^c	270,000	215,000	485,000	485,000
Wastewater Generation (gal/yr)	270,000	215,000	485,000	485,000

^a. The facilities would use natural gas for space and water heating, where no geothermal heating was employed. The estimate for the two-building scenario is based on different therms/square foot for each of the two buildings to reflect the two different uses; the estimate for the one-building scenario is based on the higher of the two rates for the entire combined building area.

^b. Backup power to the facility would be provided by a natural gas generator.

^c. The annual water use is projected assuming 15 gallons per day for each employee and researcher and 10 gallons per visitor.

Btu/yr = British thermal units per year; therms/yr = therms per year; gal/yr = gallons per year

2.5.4 Decommissioning

The project would be designed for 20 years of operation. The removal of the project facilities from service, or decommissioning, may range from “mothballing” to the removal of all equipment and facilities, depending on the conditions at the time. The process would involve decommissioning all surface facilities, including connections between the energy center and the injection wells. All exposed pipes, along with other surface facilities, would be decommissioned and may be removed during site closure. The UIC Class VI regulations require the Alliance to notify the UIC Program Director in writing at least 120 days prior to site closure and cessation of site core activities and provide any proposed changes to the Post-Injection Site Care and Site Closure Plan. The regulations also require the Alliance to submit a Site Closure Report within 90 days of authorization of site closure by the UIC Program Director. The purpose of the report is to document appropriate closure procedures, as well as information concerning injection well operation, which may be of interest to future land owners and planners.

The Alliance would plug and abandon all injection wells in accordance with the Injection Well Plugging Plan approved by the UIC Program Director during the permitting process and updated as appropriate. In accordance with the UIC Class VI regulations, the Alliance would submit to the UIC Program Director an NOI to Plug 60 days prior to commencement of plugging. The Alliance would also submit a Plugging Report to the UIC Program Director 60 days after completion of plugging.

The Alliance would conduct post-injection monitoring activities in accordance with the Post-Injection Site Care and Site Closure Plan approved by the UIC Program Director as discussed above under Injection Well Operations.

3 AFFECTED ENVIRONMENT AND IMPACTS

This chapter describes the existing physical, biological, cultural, social, and economic conditions within the ROI for the FutureGen 2.0 Project. For each resource area, the chapter describes the ROI, the method of analysis and factors considered, and the potential direct and indirect impacts of the proposed action and the no action alternative in relation to the existing conditions (the baseline). The chapter addresses the potential environmental consequences of actions at the Meredosia Energy

The Region of Influence (ROI) defines the extent of the areas where direct effects from construction and operation may be experienced, and it encompasses the areas where indirect effects from the proposed project would most likely occur.

Center, the CO₂ pipeline corridor, the CO₂ storage study area, and the educational facilities, based on the project features described in Chapter 2, Proposed Action and Alternatives. The extent of the ROI varies by resource depending upon the scope of potential impacts on respective resources. For example, Air Quality would have a broader ROI, because air emissions travel many miles, while Physiography and Soils would have a more restrictive ROI, because impacts are more localized to the areas of physical disturbance.

This chapter is organized into subsections for 19 resource areas, as listed below:

- Air Quality (Section 3.1)
- Climate and Greenhouse Gases (Section 3.2)
- Physiography and Soils (Section 3.3)
- Geology (Section 3.4)
- Groundwater (Section 3.5)
- Surface Water (Section 3.6)
- Wetlands and Floodplains (Section 3.7)
- Biological Resources (Section 3.8)
- Cultural Resources (Section 3.9)
- Land Use (Section 3.10)
- Aesthetics (Section 3.11)
- Materials and Waste Management (Section 3.12)
- Traffic and Transportation (Section 3.13)
- Noise and Vibration (Section 3.14)
- Utilities (Section 3.15)
- Community Services (Section 3.16)
- Human Health and Safety (Section 3.17)
- Socioeconomics (Section 3.18)
- Environmental Justice (Section 3.19)

Effects of Evolving Project Design

As noted at the beginning of Chapter 2, it is important to recognize that the FutureGen 2.0 Project has evolved since it was initially developed in 2011 and will continue to evolve as the Alliance works with local landowners and identifies cost-saving opportunities. Refinements in the final design are expected to affect assumptions relating to the analysis of impacts in this chapter. Examples of potential changes resulting from future refinements include:

- The surface footprint for injection well facilities is expected to be smaller than analyzed in the EIS.
- The construction of horizontal wells would enable the Alliance to use a single injection well site (although the size of the subsurface CO₂ plume is not expected to increase).
- The final pipeline route may change slightly; however, the same siting criteria would be employed and it would be sited within the pipeline corridor.

Therefore, the preliminary design described in Chapter 2 and analyzed in this EIS is expected to reflect conservative, bounding parameters for critical features, which would not change substantially such that the impacts described in this chapter would be exceeded.

Characterization of Potential Impacts

Wherever possible, potential impacts associated with the proposed action and the no action alternative are quantified. Where it is not possible to quantify impacts, a qualitative assessment of potential impacts is

presented. The following descriptors are used qualitatively to characterize impacts on respective resources:

- **Beneficial** – Impacts would improve or enhance the resource.
- **Negligible** – No apparent or measurable impacts would be expected; may also be described as “none” if appropriate.
- **Minor** – The action would have a barely noticeable or measurable adverse impact on the resource.
- **Moderate** – The action would have a noticeable or measurable adverse impact on the resource. This category could include potentially significant impacts that would be reduced to a lesser degree by the implementation of mitigation measures.
- **Substantial** – The action would have obvious and extensive adverse effects that could result in potentially significant impacts on a resource despite mitigation measures.

Additionally, impacts may consist of direct or indirect effects:

- **Direct impacts** are defined as those caused by the action and occurring at the same time and place. Examples include habitat destruction, soil disturbance, air emissions, and water use.
- **Indirect impacts** are defined as those caused by the action, but occurring later in time or farther removed in distance from the action. Examples include changes in surface water quality resulting from soil erosion, and alteration of wetlands resulting from changes in surface water quantity.

Context and Intensity of Impacts

Context and intensity are taken into consideration in determining a potential impact’s significance as defined in 40 CFR 1508.27. The context of an impact takes into account the ROI, the affected interests, and the locality. For example, a site-specific action is more likely to have a significant effect on the immediate environment or population within the ROI than on a wider geographic region. However, some aspects, such as GHG emissions, may have implications for a broader geographic area (e.g., global). The intensity of a potential impact refers to the severity of the impact and should consider:

- Beneficial and adverse impacts;
- Degree of effects on human health and safety;
- Proximity of, and degree to which actions may adversely impact, protected features or unique characteristics of the geographic area (e.g., protected species and their habitats, cultural resources, wetlands, prime farmland, park lands, wild and scenic rivers);
- Levels of public and scientific controversy associated with a project’s impacts;
- The degree of uncertainty about project impacts or risks;
- Whether the action establishes a precedent for future actions with significant effects;
- Whether related or connected actions have been appropriately considered in the analysis of impacts; and
- Whether the action threatens to violate federal, state, or local law, or requirements imposed for protection of the environment.

Impact Area Definitions

Impact areas in this chapter are generally described as either “permanent” or “temporary.” In addition, a subset of the temporary impact areas would include areas that would be disturbed intermittently for shorter periods of time during the construction phase. These impact areas are described as follows:

- ***Permanent impact areas*** include the areas that would be permanently converted from their prior uses by the FutureGen 2.0 Project. Existing habitat in permanent impact areas would be lost, and replanting as practicable would be consistent with the permanent uses designated for those areas. This would include areas upon which structures or access roads would be built, areas that would be fenced to restrict access, or areas that would be maintained with permanently altered vegetation (e.g., conversion from forest to grassland) after removal of natural vegetation. Locations on the Meredosia Energy Center property that would be altered for the construction of facilities associated with, or supporting, the oxy-combustion process would be permanent impact areas, as would the fenced areas, surface facilities, and access roads for the CO₂ injection well site(s). The 50-foot wide operational ROW for the maintenance of the CO₂ pipeline would include permanent impact areas where permanent conversion of vegetation and habitat (e.g., forest to grassland) would be necessary; but, agricultural uses could be restored with minimal restrictions.
- ***Temporary impact areas*** include the areas that would be disturbed throughout the construction phase of the proposed project but subsequently restored to their original state with some potential modifications (e.g., planted trees instead of mature trees) at the end of the construction phase, which could be years after the areas are initially impacted. Uses for the temporary impact areas would include construction laydown areas, construction trailers, parking, and the barge unloading access road at the Meredosia Energy Center. The 80- to 100-foot wide construction ROW for the CO₂ pipeline would encompass the 50-foot operational ROW and also include an additional 30- to 50-foot wide temporary impact area to facilitate movement of construction equipment and staging of supplies. Structures associated with temporary impact areas would include fences and construction trailers. Construction parking areas and equipment staging and laydown areas would be cleared, overlaid with a geosynthetic barrier, and surfaced with gravel. Any temporary impact area currently unfenced would be fenced. Temporary impact areas would be restored following completion of construction activities. Restoration would include removal of fencing, gravel, and geosynthetic barriers, as well as re-establishment of vegetation to the extent practicable.
- ***Barge impact areas*** include the areas that are expected to be in operation only on the days that a barge would be unloaded. Impacts would be limited to the times when these areas would be utilized during the extended construction phase.

Principal Changes Between the Draft and Final EIS

Since publication of the Draft EIS, the Alliance continued to develop its conceptual and preliminary design for the oxy-combustion facility, CO₂ pipeline, injection wells, and educational facilities. To the extent that updated design information became available after publication of the Draft EIS, DOE updated and refined the analysis of impacts presented in this chapter for each resource area, as appropriate. In cases in which uncertainties remain about project details, DOE considers that the bounding conditions analyzed in the Draft EIS appropriately reflect the upper limits of anticipated impacts. The major changes to DOE’s analysis of impacts are discussed below and tabulated in Table S-1 of the Summary.

Oxy-Combustion Large Scale Test

Initial design plans and air permitting documents for the FutureGen 2.0 Project were based on a 200 MWe system. The Alliance subsequently determined that a 168-MWe capacity system would be more appropriate and revised the design during preparation of the Draft EIS. DOE based its

analyses in the Draft EIS on updated project design characteristics reflecting the 168 MWe system for all the project components with the exception of the air quality and GHG analyses. Because the construction air permit application for the 168 MWe system had not yet been prepared, DOE based its air quality and GHG analyses for the Draft EIS on the prior construction air permit application for the 200 MWe system. Those evaluations provided conservative, upper-bound estimates for potential impacts. Since publication of the Draft EIS, the Alliance prepared and submitted a revised construction permit application in June 2013 for the updated design of the energy center. Accordingly, DOE updated Section 3.1, Air Quality, and Section 3.2, Climate and Greenhouse Gases, in the Final EIS to discuss estimated air emissions based on the 168 MWe design.

Further, details related to site grading and site drainage for the FutureGen 2.0 Project at the Meredosia Energy Center were still under development when the Draft EIS was prepared. To assess the potential for physical impacts at the energy center, DOE used a generalized disturbance area map provided by the Alliance and Ameren (see Figure 2-14). That map, presented and analyzed in the Draft EIS, depicts boundaries within which development could occur and thus provides a conservative, upper-bound estimate of potential impacts.

Since publication of the Draft EIS, the Alliance refined the energy center site plans in response to ongoing design efforts, and to address concerns from USFWS regarding the amount of forested land that could be cleared for the project. As a result, according to the Alliance's current plans (see Figure 2-15), the amount of forested acreage that could be lost would likely be substantially lower than the upper bound identified in the Draft EIS (as discussed in Section 2.4.3 and Section 3.8, Biological Resources). Also, the stormwater detention area has been modified to a smaller, more-defined location (as discussed in Section 3.6, Surface Water; and Section 3.7, Wetlands and Floodplains). The following sections in this Chapter maintain the impact analysis presented in the Draft EIS as an upper bound, while also discussing applicable reductions in those impacts based on the Alliance's current site plans, with substantially lower impacts to soils, wetlands and floodplains, biological resources, and land use.

CO₂ Pipeline Routing Options

The Alliance originally identified two options for the CO₂ pipeline route (southern and northern pipeline alignments) using the criteria listed in Section 2.5.1.1 and best available data. Although the Alliance identified the southern pipeline route as the proposed route, both pipeline routes were carried through the impact analysis in the Draft EIS because together they represented a conservative upper bound for analyzing potential impacts resulting from the construction and operation of the pipeline. Both pipeline routes have been included in the Final EIS for comparative purposes, but the Alliance is no longer considering the northern pipeline route.

As the Alliance proceeds with the design of the pipeline along the southern pipeline route, the final pipeline alignment is still subject to change as the Alliance continues to conduct field studies and work with landowners regarding the specific alignment and compensation for the required pipeline rights-of-way. However, the final southern pipeline route is not expected to deviate significantly from the route as identified in this Final EIS and would not be sited outside of the 4-mile wide corridor for the CO₂ pipeline. In the event that the Alliance were to find it necessary for the pipeline route to deviate from the southern alignment analyzed in this EIS, it is expected that impacts would be consistent with those addressed in this chapter, because the same siting criteria would be followed in the adjustment of the route.

Since the location of the injection wells had not been identified prior to the completion of the Draft EIS, impacts related to the portion of the pipeline traversing through the CO₂ storage study area (called end-of-pipeline routes [spurs]) were assessed in the Draft EIS by evaluating a range of reasonable alignment scenarios. In each of the scenarios, the spurs would pass from the western edge of the CO₂ storage study area to hypothetical injection well site(s) within the CO₂ storage

study area. DOE used these hypothetical siting scenarios to evaluate a range of potential impacts, whereby some hypothetical routes would have lesser impacts to physical resources, and others would have greater impacts while still representing reasonable paths.

The Alliance subsequently identified the location of the injection well site (as discussed in Section 2.5.2.1) and established pipeline routing from the southern pipeline route to the injection well site. Since the Alliance does not plan to move forward with the northern pipeline route, final routing was not identified from the end of the northern pipeline route to the injection well site. As a result, the impact analysis in the Final EIS compares the impacts of the entire southern pipeline route (from the energy center to the injection well site) to the impacts of the northern pipeline, which was conducted by including the hypothetical spurs that were analyzed in the Draft EIS.

Injection Well Siting Options

The Alliance evaluated several different injection well siting options using both horizontal and vertical wells at one or two injection well sites. After consideration of site-specific data from the stratigraphic well and computer modeling, the Alliance is currently pursuing the option of constructing four horizontal injection wells at a single injection well site. Under this **single-site scenario**, all four injection wells would originate from one **shared well** pad and would operate independently of each other. **The Alliance proposed this configuration in its Class VI UIC permit applications submitted to the USEPA in March 2013 and subsequently revised in May 2013. The Alliance is no longer considering the dual-site scenario for injection wells; however, the configuration of the injection wells will not be considered final until the UIC permits have been issued.**

The subsection for each resource addressing the CO₂ storage study area details potential impacts from the construction and operation of the injection wells. The resource areas that examine impacts related to land disturbance **maintain the analysis from the Draft EIS that** analyzes impacts for the **dual-site** scenario with two injection well sites, since this configuration would have required more land disturbance and is considered the upper bound for land-based impacts analysis. These resource areas include soils, surface water, wetlands and floodplains, biological resources, and land use. Impacts for the other resources are analyzed based on which injection well configuration (one well site or two) represents the upper bound for the given resource area.

Educational Facilities

The Alliance originally assumed that one building would house the visitor center and research functions and that a second building (possibly at a separate location) would house the training function. Since the completion of the Draft EIS, the Alliance modified its plans such that the current conceptual design assumes that the visitor, research, and training facilities would be housed in a single building, rather than two separate buildings. However, since design concepts are still in development, the Final EIS evaluates impacts associated with the educational facilities based on the original and more conservative conceptual design for multiple educational buildings.

Also, as explained in Section 2.5.3, the Alliance has been working with local stakeholders to identify a location or locations for the educational facilities that would be advantageous to the FutureGen 2.0 Project and to the local community. Discussions between the Alliance and Jacksonville civic authorities, after publication of the Draft EIS, have focused on the prospect of locating the educational facilities within a 5-acre parcel in the northeast portion of Jacksonville Community Park. The location is adjacent to West Morton Avenue near the corner of South Main Street on the south side of the Jacksonville downtown area. This location is currently occupied by offices of the Jacksonville Area Chamber of Commerce, which would be demolished and relocated if the site were used. Construction of the educational facilities could disturb a maximum of 3.5 acres but would not affect the existing Ferris wheel near the corner of West Morton Avenue and South Main Street.

The Community Park is a landscaped urban park that includes public structures, the Jacksonville Area Senior Center, playgrounds, soccer fields, internal roadways, and parking areas. South Main Street and Morton Avenue both provide access to Jacksonville from I-72, and the parcel is adjacent to all necessary utility infrastructure. The use of this location for the FutureGen 2.0 educational facilities would be subject to review and approval by the Jacksonville City Council. The Jacksonville Community Development Department would be responsible for assessing compatibility and authorizing the use of the site within a Public Activity District as defined by the city's zoning ordinance. As no decision has been reached with respect to the use of this potential location, the analysis of impacts in the Final EIS remains generally focused on the Jacksonville vicinity.

3.1 AIR QUALITY

3.1.1 Introduction

This section provides an overview of the federal and regional air quality regulations, describes existing air quality and air emissions in the region, and presents potential direct and indirect air quality impacts from construction and operation of the FutureGen 2.0 Project.

3.1.1.1 Region of Influence

The ROI for air quality includes the Meredosia Energy Center footprint and the West Central Illinois Intrastate Air Quality Control Region (AQCR) 75 as shown in Figure 3.1-1 (i.e., the airshed containing the FutureGen 2.0 Project and adjacent areas). **AQCR 75 contains the following counties: Adams, Brown, Calhoun, Cass, Christian, Greene, Jersey, Logan, Macon, Macoupin, Menard, Montgomery, Morgan, Pike, Sangamon, Schuyler, and Scott.** The Meredosia Energy Center is located near Meredosia, in Morgan County, Illinois, which is located in west central Illinois along the east side of the Illinois River. The ROI beyond the energy center's footprint consists mainly of agricultural land used for growing row crops, scattered small communities, and the larger cities of Jacksonville, Springfield, Decatur, and Taylorville.

3.1.1.2 Method of Analysis and Factors Considered

DOE analyzed the potential for air quality impacts associated with the proposed construction and operation at the Meredosia Energy Center, CO₂ pipeline, injection wells, and educational facilities. DOE based its analysis of construction air quality impacts on calculations of pollutant emissions from construction equipment, trucks and passenger vehicles, and fugitive dust generated at the construction sites. DOE based its analysis of air quality impacts during operation of the project on estimated pollutant emissions, primarily from the combustion process at the oxy-combustion facility, with additional analysis of vehicular emissions, as well as fugitive dust generation related to the cooling towers and the conveyance and transfer of coal, ash, lime, and trona.

The air quality analysis included modeling of emitted criteria air pollutants to determine potential changes to ambient air quality in relation to the National Ambient Air Quality Standards (NAAQS) (USEPA 2012a). Available ambient air quality data were obtained from monitoring stations in the region and analyzed to derive average regional baseline air concentrations for pollutants of interest. DOE considered the following factors when characterizing existing air quality:

- Proximity of monitoring stations to the project site;
- Representativeness of monitoring locations relative to the project site;
- Availability of specific pollutant data; and
- Availability of the most recent data.

DOE evaluated potential air quality impacts using current baseline conditions where the energy center is no longer in operation, as well as using historical baseline conditions prior to the 2011 suspension of operations at the energy center. DOE modeled estimated emissions using regional current data to determine whether projected emissions from operation of the FutureGen 2.0 Project would be significant (e.g., cause or contribute to any regional modeled NAAQS exceedances). DOE also evaluated air quality impacts in comparison to historical data to demonstrate that the FutureGen 2.0 Project would not trigger Prevention of Significant Deterioration (PSD) applicability for significant net emissions increases (see Section 3.1.3.2). DOE assessed the potential for impacts to air quality based on whether the proposed project would:

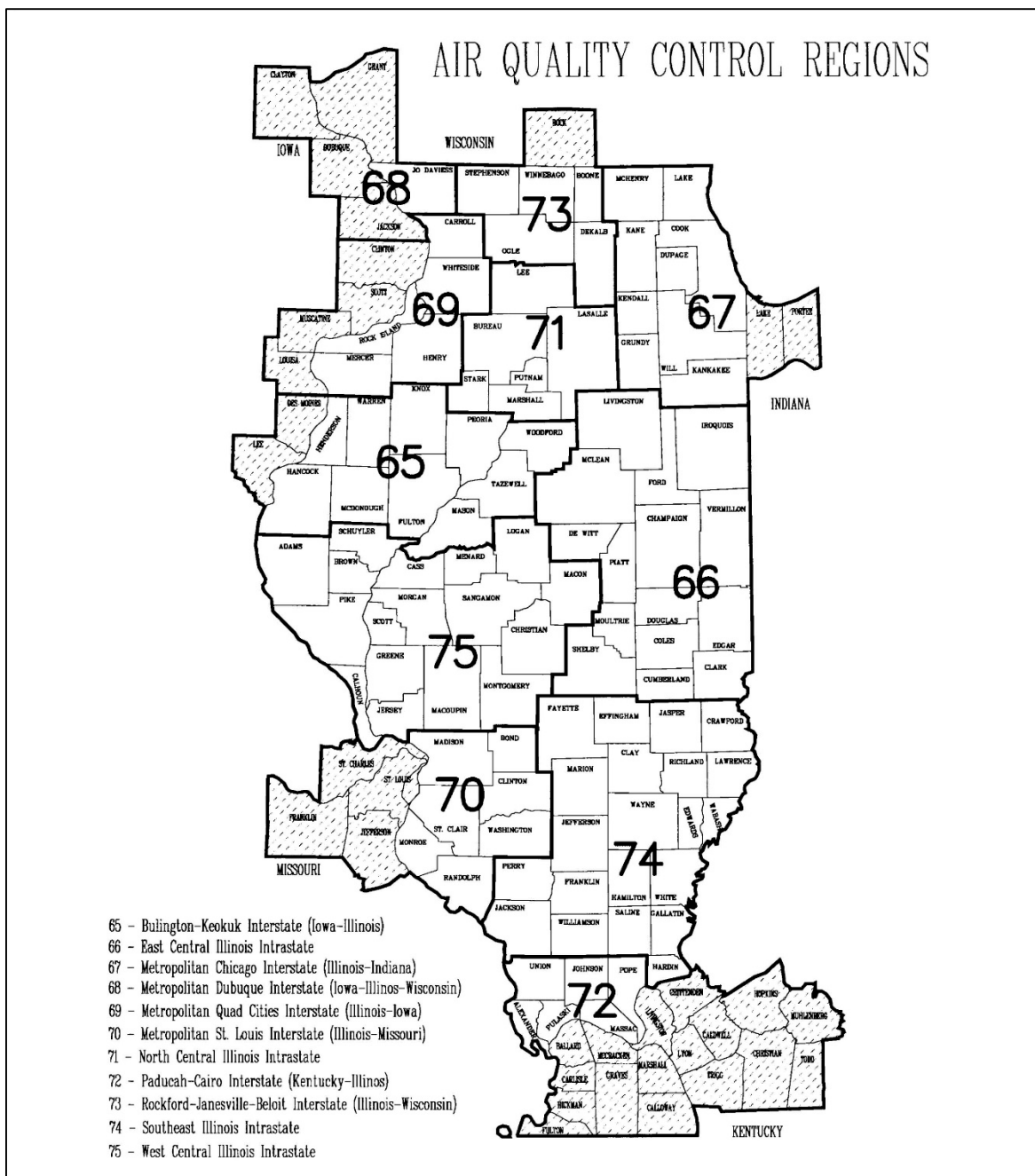

Source: IEPA 2011a

Figure 3.1-1. Air Quality Control Regions in Illinois

- Result in emissions of criteria pollutants or HAPs that would exceed relevant air quality or health standards;
- Cause an adverse change in air quality related to the NAAQS or Illinois standards;
- Violate any federal or state permits;
- Affect visibility and regional haze in Class I areas; or

- Conflict with local or regional air quality management plans to attain or maintain compliance with the federal and state air quality regulations.

3.1.1.3 Regulatory Framework

The federal Clean Air Act (CAA) requires the USEPA to establish NAAQS to protect public health and the public welfare (42 USC 7409). Accordingly, USEPA developed primary and secondary ambient air quality standards for six criteria pollutants: sulfur dioxide, carbon monoxide, ozone, nitrogen dioxide, lead, and particulate matter. Two current standards for particulate matter have been promulgated: one standard covers particulates with aerodynamic diameters of 10 micrometers or less (PM₁₀), and the other standard covers particulates with aerodynamic diameters of 2.5 micrometers or less (PM_{2.5}). The NAAQS [40 CFR 50] are expressed as concentrations of the criteria pollutants in the ambient air; that is, in the outdoor air to which the public has access. Primary standards are set to protect the public health, including the health of sensitive populations such as asthmatics, children, and the elderly. Secondary standards are set to protect public welfare, including protection against decreased visibility and damage to animals, crops, vegetation, and buildings. Both short- and long-term air quality standards (i.e., 1-, 8-, and 24-hour, and annual averages) have been established for pollutants that can contribute to both acute and chronic health effects. Table 3.1-1 lists the NAAQS.

Section 110 of the CAA requires states to develop federally-approved regulatory programs, called State Implementation Plans, which provide for the implementation, maintenance, and enforcement of the NAAQS throughout the state. Each state has the authority to adopt standards stricter than those established under the federal program. The intent of the CAA is for states to submit State Implementation Plans that, upon approval by the USEPA, allow the states to regulate air pollution within their borders. These plans must include enforceable emissions limitations, provide for monitoring, and prohibit emissions that would contribute to the nonattainment of a standard. The IEPA Bureau of Air is responsible for implementing the State Implementation Plan (USEPA 2011a), for improving and monitoring air quality in Illinois for each of the criteria pollutants, and for assessing compliance. Additionally, the IEPA Bureau of Air proposes appropriate regulations to the Illinois Pollution Control Board, which promulgates the rules governing ambient air quality in Illinois, under Title 35 Illinois Administrative Code (IAC), Subtitle B, 201 - 291.

Federal regulations designate four categories for AQCRs or portions of AQCRs (generally by county):

- Attainment: Attainment areas meet the NAAQS for a criteria pollutant. These areas are also referred to as being “in attainment” for that pollutant.
- Nonattainment: Nonattainment areas are areas in which a criteria pollutant concentration exceeds the NAAQS.
- Unclassifiable: Unclassifiable areas are areas in which insufficient data exist to determine attainment status. Typically these are areas that would not likely have air quality problems.
- Maintenance: Maintenance areas were once designated as nonattainment areas but are now in attainment and are under a monitoring plan to maintain their attainment status.

Morgan County, Illinois, the county within which the proposed project activities would occur, has been designated by the USEPA as in attainment or unclassifiable for all criteria pollutants (USEPA 2011b; 40 CFR 81).

Clean Air Act Conformity

The 1990 Amendments to the CAA require federal actions to show conformance with the State Implementation Plan. This requirement is known as the General Conformity Rule. Conformance with the State Implementation Plan means conformity to the approved plan’s purpose of eliminating or reducing the severity and number of violations of the NAAQS, and achieving expeditious attainment of such

standards (40 CFR 93). The need to demonstrate conformity is applicable only to actions within nonattainment and maintenance areas. Because all components of the FutureGen 2.0 Project would occur in areas designated in attainment or unclassifiable for the NAAQS, the general conformity rules do not apply.

Table 3.1-1. National and Illinois Ambient Air Quality Standards

Pollutant	National Ambient Air Quality Standards			Illinois Ambient Air Quality Standards		
	Primary Standards	Averaging Times	Secondary Standards	Primary Standards	Secondary Standards	Secondary Standards
CO	9 ppm	8-hour ^a	none	Same as NAAQS		
	35 ppm	1-hour ^a	none			
Pb	0.15 µg/m ³	rolling 3-month average ^b	same as primary	Same as NAAQS		
NO ₂	100 ppb	1-hour ^c	none	0.05 ppm	annual (arithmetic average)	none
	0.053 ppm	annual (arithmetic average)	same as primary			
O ₃	0.075 ppm (2008)	8-hour ^d	same as primary	Same as NAAQS		
PM _{2.5}	12.0 µg/m ³	annual ^e (arithmetic average)	15.0 µg/m ³	15.0 µg/m ³	Annual (arithmetic average)	same as primary
	35 µg/m ³	24-hour ^f	same as primary	35 µg/m ³	24-hour ^a	same as primary
PM ₁₀	150 µg/m ³	24-hour ^g	same as primary	Same as NAAQS		
SO ₂	0.075 ppm	1-hour ^h	0.5 ppm / 3-hour ^a	0.14 ppm	24-hour ^a	0.5 ppm / 3-hour
				0.03 ppm	annual (arithmetic average)	

Sources: 40 CFR 50; USEPA 2012a; IEPA 2011a; 35 IAC 243

^a. Not to be exceeded more than once per year.

^b. Not to be exceeded.

^c. On February 9, 2010, the Federal Register (Volume 75, Number 6474) published a new primary, 1-hour standard for NO₂. To attain this standard, the 3-year average of the 98th percentile of the daily maximum 1-hour average at each monitor within an area must not exceed 100 ppb.

^d. The 3-year average of the fourth-highest daily maximum 8-hour average O₃ concentrations measured at each monitor within an area over each year must not exceed 0.075 ppm.

^e. On January 15, 2013, the Federal Register (Volume 78, Number 10) published the final rule reducing the NAAQS primary standard for PM_{2.5} from 15.0 µg/m³ to 12.0 µg/m³ and maintained the secondary standard at 15.0 µg/m³. To attain this standard, the 3-year average of the weighted annual mean PM_{2.5} concentrations from single or multiple community-oriented monitors must not exceed the standard.

^f. The 3-year average of the 98th percentile of 24-hour concentrations at each population-oriented monitor within an area must not exceed 35 µg/m³.

^g. Not to be exceeded more than once per year on average over 3 years.

^h. Final rule signed June 2, 2010. To attain this standard, the 3-year average of the 99th percentile of the daily maximum 1-hour average at each monitor within an area must not exceed 0.075 ppm. The 1971 annual and 24-hour SO₂ standards were revoked in the same rulemaking. These standards, however, remain in effect until one year after an area is designated for the 2010 standard, except in areas designated nonattainment for the 1971 standards, where the 1971 standards remain in effect until implementation plans to attain or maintain the 2010 standard are approved.

CO = carbon monoxide; mg/m³ = milligram per cubic meter; NAAQS = National Ambient Air Quality Standards; NO₂ = nitrogen dioxide; O₃ = ozone; Pb = lead; PM_{2.5} = particulate matter of diameter 2.5 microns or less; PM₁₀ = particulate matter of diameter 10 microns or less; ppm = parts per million; SO₂ = sulfur dioxide; µg/m³ = microgram per cubic meter

Illinois Air Monitoring Network

Illinois has a network of air monitoring stations strategically placed throughout the state, composed of instrumentation owned and operated by both the IEPA and by cooperating local agencies. This network is designed to measure ambient air quality levels in the various Illinois AQCRs, using both continuous and intermittent instruments. Figure 3.1-2 shows the location of the air monitoring stations in Illinois with respect to the location of the Meredosia Energy Center and the potential CO₂ injection wells.

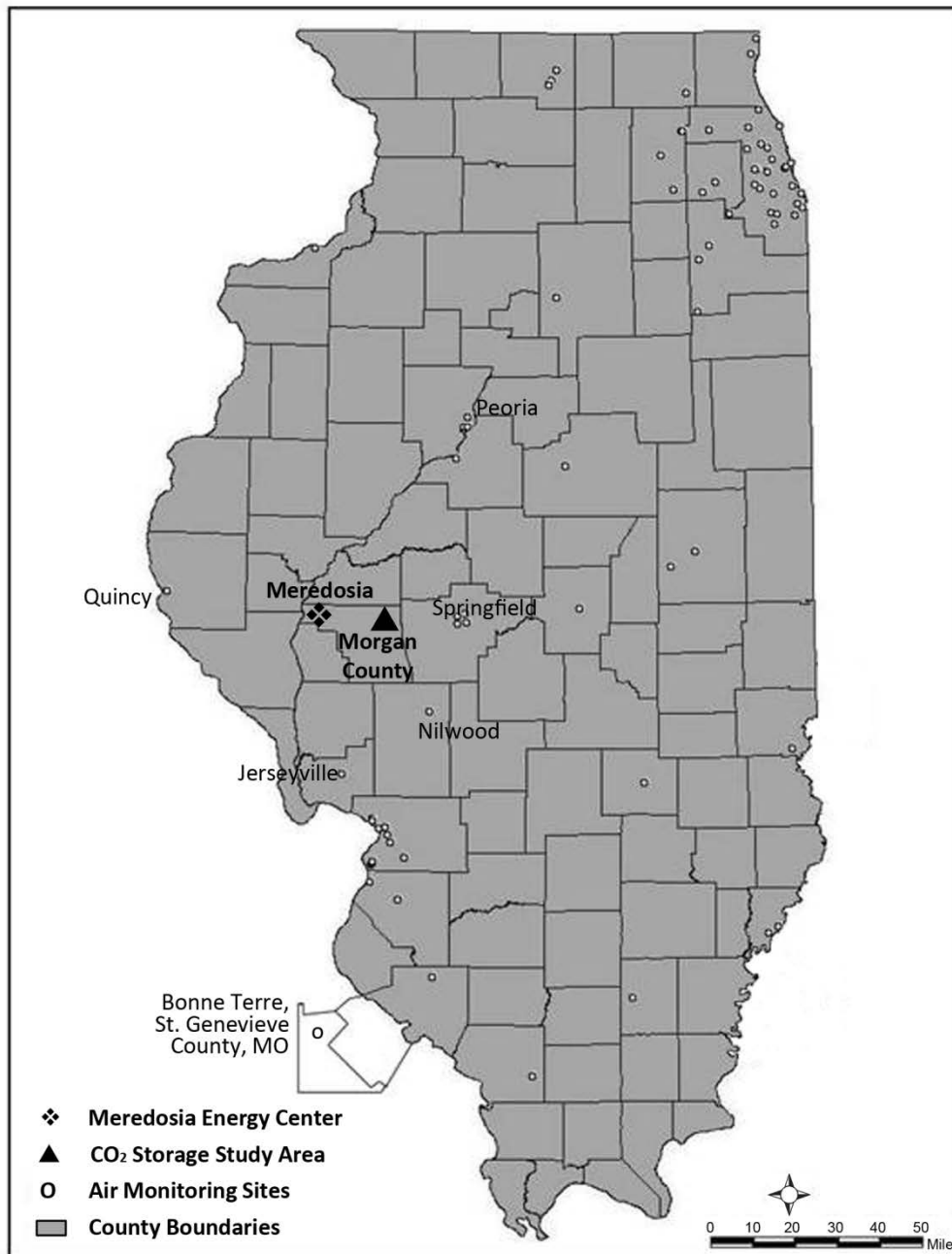

Sources: IEPA 2010a; IEPA 2011a

Figure 3.1-2. Illinois Air Monitoring Sites

Air Quality Index

Another measure of air quality utilized by the USEPA and the IEPA is the Air Quality Index (AQI), which is a human health-based measure of overall air quality that takes into account all of the criteria

pollutants measured within an area. As shown in Table 3.1-2, an AQI value of 50 or less is considered “good” air quality; 51-100 is considered “moderate”; 101-150 is considered unhealthy for sensitive groups; and values of 151 or higher range from “unhealthy” to “very unhealthy” to “hazardous” (IEPA 2011a).

Table 3.1-2. Air Quality Index Descriptor Categories and Health Effects

AQI Range	Descriptor Category	Health Effects	Cautionary Statements
0-50	Good	No health impacts are expected when air quality is in this range.	Air pollution poses little to no risk.
51-100	Moderate	Air quality is acceptable.	For some pollutants there may be a moderate health concern for a very small number of people. For example, people who are unusually sensitive to ozone may experience respiratory symptoms.
101-150	Unhealthy for Sensitive Groups	Increased likelihood of respiratory symptoms and breathing discomfort in sensitive groups.	Active children and adults, and people with respiratory disease, such as asthma, should limit prolonged outdoor activity.
151-200	Unhealthy	Greater likelihood of respiratory symptoms and breathing difficulty in sensitive groups.	Active children and adults, and people with respiratory disease, such as asthma, should avoid heavy outdoor exertion; everyone else, especially children, should limit heavy outdoor exertion.
201-300	Very Unhealthy	Increasingly severe symptoms and impaired breathing likely in sensitive groups.	Active children and adults, and people with respiratory disease, such as asthma, should avoid all outdoor exertion; everyone else, especially children, should limit outdoor exertion.
301 and above	Hazardous	Severe respiratory effects and impaired breathing likely in sensitive groups.	Everyone should avoid all outdoor exertion.

Sources: IEPA 2011a; Airnow 2011
 AQI = Air Quality Index

3.1.1.4 Permitting Requirements

Air permitting is required for industries and facilities that emit regulated pollutants, although certain exemptions are established by statute. Based on the size of the emissions units and type of pollutants emitted (criteria pollutants or HAPs), the Illinois Pollution Control Board sets permit rules and standards for emissions sources.

Construction Permits

The air quality permitting process begins with the application for a construction permit. For attainment areas, there are two types of construction permits available through the IEPA for the construction and temporary operation of new emissions sources, including the following:

- PSD new source review permits, which are required for major new sources or major sources making major modifications; and
- Minor new source review construction permits, which are required for new minor sources or existing major sources making minor modifications.

Sources subject to PSD are typically required to complete best available control technology review for criteria pollutants, predictive modeling of emissions from proposed and existing sources, and public involvement activities.

PSD preconstruction review and permitting applies on a pollutant by pollutant basis to construction of new “major sources” and to modifications at existing major sources. Major sources are defined under PSD as sources listed in any of 28 named source categories whose potential to emit is greater than 100 tons per year of any regulated pollutant; or if not in a listed source category, a source whose potential to emit any regulated pollutant is greater than 250 tons per year. Fossil fuel-fired steam electric plants with greater than 250 million Btu per hour of heat input are a named source category under PSD. Modifications at existing major sources are subject to PSD if the increase in air emissions from the modification exceeds any of the significant increase thresholds in Table 3.1-3 and the “net emissions increase” also exceeds any of the significant increase thresholds. Net emissions increases are determined by summing all increases and decreases resulting from a project with all contemporaneous emissions increases and decreases at the source.

Minor source permitting applies to any construction of a new source or modification at an existing source where PSD permitting does not apply. Minor source permitting is required under state regulation and does not require sources to determine and implement best available control technologies or other PSD requirements.

Table 3.1-3. Thresholds for Determination of Major Modification to Existing Source

Pollutant	Threshold for Major Modification to an Existing Source (tpy)^{a, b}
CO	100
NO _x ^c	40
PM	25
PM ₁₀	15
PM _{2.5}	10
Lead	0.6
Fluorides	3
Sulfuric Acid Mist	7
SO ₂	40
VOCs ^c	40
CO₂-eq^d	75,000

Source: 40 CFR 52.21(b)(23)

^a. PSD review and permitting is required for sources emitting 100 tpy of any regulated pollutant for fossil fuel-fired steam electric plants of more than 250 MMBtu/hr heat input.

^b. Additional thresholds exist for pollutants not expected to be emitted from this project (e.g. hydrogen sulfide).

^c. Major modification threshold for ozone is 40 tpy of VOCs or NO_x.

^d. See Section 3.2, Climate and Greenhouse Gases, for discussion of CO₂-eq.

CO = carbon monoxide; CO₂-eq = carbon dioxide equivalent; MMBtu/hr = million British thermal units per hour; NO_x = nitrogen oxides; PM = particulate matter; PM_{2.5} = particulate matter of diameter 2.5 microns or less; PM₁₀ = particulate matter of diameter 10 microns or less; PSD = Prevention of Significant Deterioration; SO₂ = sulfur dioxide; tpy = tons per year; VOCs = volatile organic compounds

The goal of the PSD program (40 CFR 52) is to prevent the degradation of air quality in attainment or unclassified areas, while at the same time allowing for economic growth. Deterioration of existing air quality levels is limited by the amount of additional pollutant concentration that is allowed to increase above a baseline concentration. The allowable increased concentration for each pollutant and the averaging period are referred to as the allowable PSD increments. The allowable air emissions increment

limits are dependent on the land-use classification of the area. There are three area classifications. Each classification differs in terms of the amount of growth it would permit before significant air quality deterioration would be deemed to occur. Class I areas have the smallest increments and thus allow only a small degree of air quality deterioration. Class II areas can accommodate normal well-managed industrial growth. Class III areas have the largest increments and thereby provide for a larger amount of development than either Class I or Class II areas. Congress established certain areas (e.g., wilderness areas and national parks) as mandatory Class I areas (40 CFR 51.166(e); NPS 2011). Table 3.1-4 presents the maximum allowable increase in pollutant concentration above a baseline concentration for each of the Class area designations.

Table 3.1-4. Air Pollutant Prevention of Significant Deterioration Increments for Class I, II, and III Areas

Pollutant	Averaging Period	Maximum Allowable Increase ($\mu\text{g}/\text{m}^3$)		
		Class I Area	Class II Area	Class III Area
SO ₂	3-hour	25	512	700
	24-hour	5	91	182
	Annual	2	20	40
NO ₂	Annual	2.5	25	50
PM ₁₀	24-hour	8	30	60
	Annual	4	17	34
PM _{2.5}	24-hour	2	9	18
	Annual	1	4	8

Source: 40 CFR 51.166

NO₂ = nitrogen dioxide; PM_{2.5} = particulate matter of diameter 2.5 microns or less; PM₁₀ = particulate matter of diameter 10 microns or less; SO₂ = sulfur dioxide; $\mu\text{g}/\text{m}^3$ = micrograms per cubic meter

The closest PSD Class I areas to the energy center are the Mingo Wilderness Area in Missouri and the Mammoth Cave National Park in Kentucky. Both are located more than 180 miles from the Meredosia Energy Center, which exceeds the distance within which USEPA typically requires Class I area protection provisions (i.e., a distance of 62 miles [100 kilometers]). Because of this distance, air quality impacts to Class I areas are not expected from the FutureGen 2.0 Project; therefore, effects to Class I areas are not discussed further in this air quality analysis. All air regions within the ROI of the FutureGen 2.0 Project are designated Class II areas, with moderate pollution increases allowed.

Operating Permits

Under state and federal Title V (CAA Permit Program) regulations, a Title V Significant Permit Modification is required for facilities whose increase in emissions exceeds the thresholds outlined in Table 3.1-3. In addition, a Significant Permit Modification would be required if it became necessary to establish federally-enforceable limitations to reduce potential emissions below the thresholds. A minor permit modification would be required if emissions were below the thresholds and a federally-enforceable limit was not necessary. Submission of an application for these permit modifications would be required within one year of the first operation of a new emissions source.

The Title V permit ensures that a plant’s emissions are in compliance with all federal CAA and state regulations. When the state issues a Title V permit, it assures that the permit includes sufficient monitoring, recordkeeping, and reporting requirements such that compliance with all relevant air quality standards and regulations can be determined, and thus satisfies the Illinois State Implementation Plan.

The Meredosia Energy Center Title V Operating Permit (called a CAA Permit Program permit in Illinois) was originally issued in September 2005 but was appealed to the Illinois Pollution Control Board by

Ameren. As a result of the appeal, Ameren was granted a stay of the permit and the permit never took effect. Ameren is currently in negotiation with the IEPA to resolve the issues identified in the appeal of the permit so that a Title V Operating Permit can be put into effect. Until the appeal is resolved and the stay is lifted by the Illinois Pollution Control Board, IEPA cannot modify the Title V Operating Permit.

Also under the CAA Permit Program, the facility would be required to meet the requirements of Title IV, the Acid Rain Permit Program (40 CFR 72) that establishes limitations on sulfur dioxide and nitrogen oxides emissions, and requirements for permitting, monitoring, reporting, and compliance.

Other Requirements

In addition to the permitting requirements to construct and operate new or modified emissions sources, New Source Performance Standards (NSPS) (40 CFR 60) and National Emission Standards for Hazardous Air Pollutants (NESHAPs) (40 CFR 63) set emissions and control standards for categories of stationary emissions sources of both criteria pollutants (i.e., NSPS) and HAPs (i.e., NESHAPS). The NSPS are promulgated by USEPA for criteria pollutant emissions from new, modified, and reconstructed sources in certain source categories. NESHAPs are emissions standards for HAPs from both existing and new sources from certain source categories. This program sets uniform emissions limitations for many industrial sources such as boilers and stand-by generators. On February 16, 2012, USEPA issued a NESHAP and NSPS applicable to coal-fired electric utility steam generating units. Parts of these rules related to startup and shutdown, and monitoring provisions were stayed until USEPA completes a reconsideration review of these rules.¹ Other relevant requirements of the CAA include the Chemical Accident Prevention Act (40 CFR 68) that requires development of a risk management plan for stationary sources having more than threshold quantities of regulated toxic and flammable chemicals; and the Compliance Assurance Monitoring Rule (40 CFR 64) that requires monitoring and reporting of operation and maintenance of emissions control devices to assure compliance with emissions standards. See Chapter 5, Regulatory and Permit Requirements, for further descriptions of these provisions.

3.1.2 Affected Environment

3.1.2.1 Meredosia Energy Center

Existing Air Quality for Morgan County

The Meredosia Energy Center is located in Morgan County, Illinois, in the west central part of the state, approximately 48 miles west of Springfield. The majority of Morgan County consists of agricultural land used for growing row crops, scattered small communities such as Meredosia, and the larger town of Jacksonville. There are a total of seven major or synthetic minor sources permitted in Morgan County, including: Ach Food Company Inc., AGI North America LLC, Ameren Energy Generating Company, Celanese, Jacksonville Developmental Center, Panhandle Easter Pipeline Company, and United Gilsonite Laboratories (USEPA 2011c). Other potential sources of air pollution would include sources in neighboring counties as well as activities, including vehicular traffic, in nearby towns of Jacksonville and Springfield.

The IEPA Bureau of Air operates monitoring sites throughout the state that are used to monitor ambient air quality and determine whether areas or regions comply with all of the NAAQS. No ambient air monitoring stations are maintained by USEPA or IEPA in Morgan County. The ambient air quality monitoring stations within an approximate 50-mile radius are located in Adams, Jersey, Macoupin, and Sangamon counties, all within the West Central Illinois Intrastate AQCR 75. The pollutants measured by these monitoring stations include ozone, carbon monoxide, sulfur dioxide, lead, PM₁₀, and PM_{2.5}. No ambient monitoring stations for nitrogen dioxide exist within AQCR 75.

DOE performed a review of monitoring stations for each pollutant to determine average existing air quality data for the project region. Based on their location within the same AQCR and their relative

¹ This rule is also known as the Utility Maximum Achievable Control Technology (MACT) rule.

proximity to the energy center, the Quincy (Adams County), Jerseyville (Jersey County), Nilwood (Macoupin County), and Springfield (Sangamon County) monitors were determined to be most appropriate for use in setting the background concentrations for all pollutants except nitrogen dioxide. For nitrogen dioxide, the St. Genevieve County, Missouri, location was chosen based upon its representativeness to the site as compared to the nitrogen dioxide monitoring locations in Illinois, which are located in the major metropolitan areas of Cook County (metropolitan Chicago) and East St. Louis.

Table 3.1-5 presents a listing of these stations and Figure 3.1-2 shows their locations. Table 3.1-6 presents average regional monitoring data for each criteria pollutant. Concentrations are presented for the closest monitoring station(s) that measures that particular pollutant. If multiple monitoring stations are nearly equidistant from the Meredosia Energy Center, the concentrations from these monitoring stations are averaged. Because localized ambient air quality depends on many factors, such as location and types of source emissions and air mixing patterns, these average regional data shown in Table 3.1-6 may not be truly reflective of actual air quality in and around the Meredosia Energy Center. These estimates serve to represent general regional air quality and were not used in the emissions modeling discussed in Section 3.1.3.2. Ameren obtained background concentrations from IEPA for emissions modeling. All measured pollutant levels for the Morgan County region are currently (2010) below the NAAQS primary standards.

Table 3.1-5. Air Monitoring Stations Used to Characterize Ambient Air for FutureGen 2.0 Project

Pollutant	Site ID	City	County	Downwind Direction to Monitor	Distance to the Energy Center (miles)
CO	171670008	Springfield	Sangamon	East	49
NO ₂	291860005	Bonne Terre (Missouri)	St. Genevieve (Missouri)	South	133
O ₃	171670010	Springfield	Sangamon	East	51
O ₃ , PM _{2.5}	170010007	Quincy	Adams	West	41
O ₃ , PM _{2.5}	170831001	Jerseyville	Jersey	South	51
O ₃ , PM ₁₀ , SO ₂	171170002	Nilwood	Macoupin	Southeast	50
Pb	171430037	Peoria	Peoria	Northeast	78
PM _{2.5}	171570012	Springfield	Sangamon	East	49
SO ₂	171670006	Springfield	Sangamon	East	52

Sources: IEPA 2011a; MDNR 2012

CO = carbon monoxide; NO₂ = nitrogen dioxide; O₃ = ozone; Pb = lead; PM_{2.5} = particulate matter of diameter 2.5 microns or less; PM₁₀ = particulate matter of diameter 10 microns or less; SO₂ = sulfur dioxide

Air Quality Index

The closest location to the Meredosia Energy Center, and to Morgan County, for which the AQI was measured is the Springfield metropolitan area, located approximately 49 miles to the east of Meredosia. In 2010, Springfield recorded 75.3 percent of the days with a good AQI and 24.7 percent of the days with a moderate AQI (see Table 3.1-2). There were no recorded days with an unhealthy AQI (IEPA 2011a). However, it must be noted that this AQI for metropolitan Springfield is not necessarily representative for the ROI around the rural region of Meredosia.

Table 3.1-6. Air Monitoring Data Used to Characterize Ambient Air for the FutureGen 2.0 Project

Pollutant	Averaging Period	Station ^a	Average Concentrations for Year ^b		
			2008	2009	2010
CO	1-hour	Springfield	2.3 ppm	2.7 ppm	1.7 ppm
	8-hour	Springfield	1.4 ppm	1.2 ppm	1.3 ppm
NO ₂ ^c	1-hour	Bonne Terre (Missouri)	0.024 ppm	0.031 ppm	0.034 ppm
	Annual	Bonne Terre (Missouri)	0.0030 ppm	0.0024 ppm	0.0025 ppm
O ₃ ^d	8-hour	Regional average ^e	0.070 ppm	0.067 ppm	0.066 ppm
Pb	Rolling 3-month	Peoria	0.01 µg/m ³	0.01 µg/m ³	0.01 µg/m ³
PM ₁₀	24-hour	Nilwood	33 µg/m ³	28 µg/m ³	32 µg/m ³
PM _{2.5}	24-hour ^f	Regional average ^g	26.7 µg/m ³	24.2 µg/m ³	21.3 µg/m ³
	Annual	Regional average ^g	11.4 µg/m ³	10.8 µg/m ³	10.2 µg/m ³
SO ₂	1-hour	Regional average ^h	0.074 ppm	0.059 ppm	0.040 ppm
	3-hour	Regional average ^h	0.103 ppm	0.020 ppm	0.041 ppm

Sources: IEPA 2011a; IEPA 2010a; IEPA 2009; MDNR 2012; USEPA 2011d

^a. Concentrations are presented for the closest monitoring station(s) that measures that particular pollutant. If multiple monitoring stations are nearly equidistant from the Meredosia Energy Center, the concentrations from these monitoring stations are averaged.

^b. Reported values in this table represent averages of highest sample concentrations measured for the year. These concentrations do not necessarily correspond directly to the values used as representative background in modeling analysis **for this EIS, as provided by IEPA.**

^c. The only monitoring stations in Illinois for NO₂ are located in metropolitan areas around Chicago and St. Louis; therefore, the St. Genevieve County, Missouri, location was chosen. Additionally, the 2010 NO₂ data is through the third quarter since the instrument shutdown in September 2010.

^d. **Air quality modeling for ozone (O₃) was not conducted; therefore, this information is presented for informational purposes only.**

^e. For a representative concentration, O₃ (3-year average of the fourth-highest daily maximum 8-hour average concentration) is reported as an average of measurements from Quincy, Jerseyville, Nilwood, and Springfield monitoring stations. The 1-hour O₃ standard was revoked effective June 15, 2005, for all areas in Illinois (40 CFR 81.314).

^f. USEPA determines compliance with the NAAQS for PM_{2.5} by the 3-year average of the annual 98th percentile concentrations. The 98th percentile 24-hour concentrations are shown.

^g. For a representative concentration, 24-hour PM_{2.5} (98th percentile values of highest samples) and annual mean are reported as averages from Quincy, Jerseyville, and Springfield monitoring stations.

^h. For a representative concentration, 1-hour SO₂ (3-year average of the 99th percentile of the daily maximum 1-hour average) and 3-hour SO₂ (highest sample) are reported as an average of measurements from Nilwood and Springfield monitoring stations.

CO = carbon monoxide; IEPA = Illinois Environmental Protection Agency; NAAQS = National Ambient Air Quality Standards; NO₂ = nitrogen dioxide; O₃ = ozone; Pb = lead; PM_{2.5} = particulate matter of diameter 2.5 microns or less; PM₁₀ = particulate matter of diameter 10 microns or less; ppm = parts per million; SO₂ = sulfur dioxide; µg/m³ = micrograms per cubic meter; USEPA = U.S. Environmental Protection Agency

Existing Operations, Emissions, and Air Permits for Meredosia Energy Center

The Meredosia Energy Center began operation in 1948, with equipment and configuration changes in the succeeding years. As discussed in Section 2.4.1, energy center operations were suspended at the end of 2011; therefore, the information and data presented in this section are based on configuration and operations before the energy center suspended operation. The energy center includes four generating units (Units 1 through 4), which were supplied with steam from six boilers. Boilers 1 through 5 were coal-fired; Boiler 6 was oil-fired. Boiler 6 was the only boiler located outside and not enclosed within a building. Units 1 and 2 (Boilers 1, 2, 3, and 4) operations were suspended on November 9, 2009. Unit 3 (Boiler 5) and Unit 4 (Boiler 6) operations were suspended on January 1, 2012. The environmental permits for all these sources are currently active. Unit 3 has a nominal-rated generating capacity of 229 MWe (203 MWe net). Unit 4 was placed in service in 1975 and has a generating capacity of 210 MWe (166 MWe net). The

six boilers are served by three emissions stacks. A combined stack serving Boilers 1, 2, 3 and 4 (Units 1 and 2) is the tallest at 526 feet; the stack serving Unit 3 is 301 feet tall; and the stack serving Unit 4 is 184 feet tall.

Table 3.1-7 presents the reported stack emissions for 4 years of operation (2007 through 2010) prior to the suspension of operations at the energy center at the end of 2011. The energy center also generated indirect emissions due to mobile sources, including onsite coal and ash handling equipment; trucks, train locomotives, and tugboats used to deliver and remove materials and waste from the property; as well as privately-owned vehicles used by workers.

Table 3.1-7. Meredosia Energy Center Emissions for Recent Years

Pollutant	Source Emissions Reported by Year (tpy)			
	2007	2008	2009	2010
CO	287.83	223.88	82.99	124.84
NO _x	3,171.60	2,538.90	819.90	786.40
PM	288.20	211.32	64.92	83.86
PM ₁₀	109.23	78.38	22.44	28.17
PM _{2.5}	15.95	11.56	3.59	4.64
SO ₂	11,388.40	8,016.40	2,145.80	2,465.80
VOCs	40.19	31.24	11.58	17.41

CO = carbon monoxide; NO_x = nitrogen oxides; PM = particulate matter; PM_{2.5} = particulate matter of diameter 2.5 microns or less; PM₁₀ = particulate matter of diameter 10 microns or less; SO₂ = sulfur dioxide; tpy = tons per year; VOCs = volatile organic compounds

Existing Cooling Tower Emissions

Cooling towers are heat exchangers used to cool liquids in industrial processes by evaporating water and thereby transferring the heat to the air passing through the cooling tower and releasing the heat to the atmosphere. Some of the liquid water evaporates, and some becomes entrained in the air stream and is carried out of the tower as “drift” droplets. Since water droplets generally contain the same dissolved solids as the water circulating in the tower, these solids can be carried out of the tower in the drift. When the drift droplets evaporate before being deposited, they produce particulate matter emissions (USEPA 1995a).

Historical operations of the Meredosia Energy Center used a cooling tower to cool the water used in the electrical generation process in Unit 4. Mechanical draft cooling towers can produce some adverse environmental effects due to the liquid water plume coming directly from the tower (drift), as well as from the secondary liquid water formation caused by the condensation of water vapor (“fogging”). These adverse effects include: fogging at ground level and ice build-up, deposition of dissolved salt particles, and local shading of the sun due to a visible plume (Holzman 2010).

In 2010, the Illinois Department of Transportation (IDOT) evaluated proposed alternative alignments for IL-104 over the Illinois River in the vicinity of the Meredosia Energy Center. As part of their Environmental Assessment, IDOT analyzed the impacts of cooling tower emissions from the Meredosia Energy Center. One of the alternatives (Alternative #9) in this study involved constructing a new bridge across the Illinois River landing approximately 700 feet north of the Unit 4 cooling tower at the Meredosia Energy Center (IDOT 2011). As part of the impact analysis, IDOT evaluated the potential for fogging, icing, and other impacts to the proposed bridge resulting from operations of the existing cooling tower. IDOT conducted dispersion modeling analysis using the Seasonal/Annual Cooling Tower Impact (SACTI) model (Version 11-01-90) to evaluate the following impacts (Holzman 2010):

- Frequency of occurrence of cooling tower plume heights, plume lengths, and plume radii;
- Frequency of occurrence and special distribution of ground-level fogging and rime ice deposition;
- Special distribution and rate of salt deposition; and
- Frequency and extent of plume shadowing effects.

Although the cooling tower at the Meredosia Energy Center did not operate during winter months (since Unit 4 was only used as a summer peaking unit), the SACTI model analysis assumed the cooling tower operated 24 hours per day, 7 days per week, 365 days per year. The IDOT assessment concluded that continuous operation of the cooling tower at the Meredosia Energy Center would have generated fog and rime icing impacts predominantly downwind to the southeast of the tower. The maximum hours of fogging in any one location were estimated by SACTI to be 15.4 hours per year on average, with the maximum occurring at 200 meters, extending to a maximum distance of approximately 900 meters to the southeast. SACTI predicted less than 1 hour of fogging per year to the northwest. The maximum hours of rime icing were estimated to be 6 hours per year on average, with the maximum occurring 200 meters downwind to the southeast of the tower. At 700 feet north of the Unit 4 cooling tower (proposed bridge location), fog and rime ice were projected to occur only 1 hour over a 5-year period, and salt and water deposition could occur when the cooling tower was operating. Plume shadowing and related solar energy loss were not shown to be significant (Holzman 2010).

3.1.2.2 CO₂ Pipeline, CO₂ Storage Study Area, and Educational Facilities

The existing ambient air quality for Morgan County is discussed under Section 3.1.2.1. The region around and within the pipeline corridor from the energy center to the CO₂ storage study area consists mainly of agricultural land used for growing row crops, scattered small communities, and the larger town of Jacksonville. The area within the CO₂ storage study area is also predominantly agricultural. The croplands in these regions are not highly susceptible to wind erosion and, most of the time, would not present a source of wind-blown particulates or dust. However, cultivation and tilling of the soil may cause some dust suspension or render the soil more susceptible to wind erosion for short periods of time. The educational facilities are expected to be located in or near Jacksonville.

3.1.3 Impacts of Proposed Action

3.1.3.1 Construction Impacts

DOE estimated potential emissions associated with construction of the oxy-combustion facility, the CO₂ pipeline, the injection wells, and the educational facilities by considering the likely construction equipment and operating schedules, estimated area and duration of land disturbance, estimated number of construction worker vehicle trips, and truck trips for material deliveries and waste removal. DOE estimated the construction emissions using USEPA models and methods:

- Construction Equipment Emissions: estimated tailpipe emissions from the variety of internal combustion equipment using USEPA's NONROAD model (USEPA 2008a, USEPA 2010a) based on the equipment type (horsepower) and hours of operation.
- Vehicle Emissions: estimated tailpipe emissions from worker vehicles and delivery trucks traveling to and from the sites using USEPA's Motor Vehicle Emission Simulator (MOVES) model (USEPA 2012b) based on the vehicle types and miles traveled.
- Fugitive Dust Emissions: estimated fugitive dust emissions resulting from excavation, soil storage and handling, traffic over unpaved onsite roads, and earthwork, using standard USEPA methods (USEPA 1995a; USEPA 2005a; USEPA 2005b).

The construction emissions for each of the various project components (energy center, pipeline, injection wells, and educational facilities) are presented separately below, followed by a collective tabulation and

discussion of total construction emissions and their impacts. Emissions of CO₂ during construction are presented and discussed in Section 3.2, Climate and Greenhouse Gases.

Meredosia Energy Center

The FutureGen 2.0 Project would involve the construction of an advanced oxy-combustion facility at the Meredosia Energy Center. The construction would include installation of new FutureGen 2.0 components, new access roads, as well as improvements to the existing coal handling, process water and wastewater, and electrical and control systems, as described in Section 2.4.

Conventional construction methods would be used. The construction of the oxy-combustion facility would take place over approximately 42 months beginning in 2014 and extending through the middle of 2017, with the peak in number of construction workers occurring between June through December of 2015. The last 12 months of construction would overlap with a 1-year commissioning and startup effort. The Alliance developed a list of estimated construction equipment required, and hours of operation of each, along with the anticipated amount of gasoline or diesel that each piece would consume. Based on these assumptions, DOE calculated the total criteria pollutant emissions resulting from construction activities at the Meredosia Energy Center. DOE also calculated the tailpipe emissions from the worker vehicles and delivery and waste trucks that would be associated with project construction (see Section 3.13, Traffic and Transportation, for discussion of vehicle traffic). Table 3.1-8 presents these estimated emissions resulting from construction of the oxy-combustion facility at the Meredosia Energy Center.

Table 3.1-8. Equipment and Vehicle Emissions for Construction at Meredosia Energy Center

	Emissions (tons)					
	CO	NO _x	PM ₁₀	PM _{2.5}	SO ₂	VOCs
Equipment Tailpipe Emissions ^{a, b, c}	51	92	9	8	3	9
Fugitive Dust Emissions ^{d, e}	NA	NA	531	40	NA	NA
Vehicle Tailpipe Emissions ^f	53	16	1	0	0	2
Total	104	108	541	48	3	11

^{a.} Based on estimated construction equipment list, hours of use, and amount of gasoline and diesel used per type of equipment.
^{b.} Emissions factors derived for construction equipment using NONROAD USEPA emissions model, assuming average values across Morgan County (USEPA 2008a) and load factors (USEPA 2010a).
^{c.} PM_{2.5} is assumed to be 97 percent of PM₁₀ for exhaust (USEPA 2010b).
^{d.} Total suspended particles = 1.2 tons/acre/month (USEPA 2012c AP-42, 13.2.3.3). PM₁₀ is 45 percent of total suspended particles (USAF 2003, USEPA 2012c AP-42 13.2.2.2). PM_{2.5} = PM₁₀*0.15(1 - capture fraction) (USEPA 2005b). Capture fraction for agricultural areas is 0.25 (USEPA 2005a).
^{e.} **The values presented in this table for fugitive dust emissions are based on the upper bound assumptions assumed in the Draft EIS reflecting a total impact area of 164 acres (as presented in Figure 2-14), during an average disturbance of 6 months. The Alliance’s current plan assumes a reduced impact area of 114 acres, as shown in Figure 2-15, which could result in fugitive dust emissions of PM₁₀ = 369 tons and PM_{2.5} = 28 tons.** It is not expected that land disturbance would cover the entire impact area, and the 6-month duration of disturbance at any one location is a conservative estimate, as most areas would be intermittently disturbed for shorter durations.
^{f.} Vehicle emissions calculated using the USEPA MOVES model, version 2010b (USEPA 2012b). Assumed that energy center workers would travel primarily on local roads while trucks would travel primarily on highways. Note that vehicle tire wear and brake wear emissions are also included under PM₁₀ and PM_{2.5}. See Total Construction Emissions for further discussion of impacts from diesel exhaust.
 CO = carbon monoxide; NA = not applicable; MOVES = Motor Vehicle Emission Simulator; NO_x = nitrogen oxides; PM_{2.5} = particulate matter of diameter 2.5 microns or less; PM₁₀ = particulate matter of diameter 10 microns or less; SO₂ = sulfur dioxide; USEPA = U.S. Environmental Protection Agency; VOCs = volatile organic compounds

CO₂ Pipeline

The CO₂ pipeline route would begin at the Meredosia Energy Center and extend to the CO₂ injection wells. Construction of the pipeline and ROW would be accomplished with typical construction methods, within a construction easement of 80 to 100 feet wide depending on the terrain. Construction would

involve clearing and grading, trenching, pipe stringing, welding and coating the pipe, lowering the pipe into trench and backfilling, testing, and land restoration. Some of the pipeline corridor would be within existing utility or highway ROWs, such that clearing and grading would not be necessary. However, for the purposes of impact analysis, DOE took a conservative approach in estimating construction emissions by assuming that any particular section of the ROW would be disturbed for approximately 2 months total, as the construction progressed along the pipeline length. Additionally, DOE assumed that all portions of pipeline construction would involve clearing and grading.

DOE estimates that construction of the pipeline from the Meredosia Energy Center to the injection wells would take approximately 4 to 5 months. Pipeline construction would require up to approximately 300 workers throughout the whole construction project, with varying schedules and locations.

DOE calculated tailpipe emissions originating from the construction equipment, as well as fugitive dust emissions generated from mechanical disturbance of the surface and excavated material. DOE also calculated the tailpipe emissions from the worker vehicles and the delivery and waste trucks that would be associated with the project construction (see Section 3.13, Traffic and Transportation, for discussion of vehicle traffic). Table 3.1-9 summarizes the calculated estimated emissions for construction of the CO₂ pipeline to the injection wells.

Table 3.1-9. Equipment and Vehicle Emissions for Construction of CO₂ Pipeline

	Emissions (tons)					
	CO	NO _x	PM ₁₀	PM _{2.5} ^d	SO ₂	VOCs
Equipment Tailpipe Emissions ^{a, b, c}	13	27	3	2	1	3
Fugitive Dust Emissions ^d	NA	NA	281	32	NA	NA
Vehicle Tailpipe Emissions ^e	7	18	1	1	0	1
Total	20	45	285	35	1	4

^a Based on estimated construction equipment list and durations of use. Assumes equipment would be operated 6 days per week for 4 months.
^b Emissions factors derived for construction equipment using NONROAD USEPA emissions model, assuming average values across Morgan County (USEPA 2008a) and load factors (USEPA 2010a).
^c NONROAD total PM calculation is PM₁₀ value. PM_{2.5} is assumed to be 97 percent of PM₁₀ for exhaust (USEPA 2010b).
^d Fugitive dust emissions estimates based on an approximate 260 acres of land disturbance occurring **along the updated southern pipeline route within** an 80-foot construction ROW, during an average disturbance of 2 months per portion of pipeline. Total suspended particles = 1.2 tons/acre/month (USEPA 2012c AP-42, 13.2.3.3). PM₁₀ is 45 percent of total suspended particles (USAF 2003; USEPA 1995a). PM_{2.5} = PM₁₀*0.15(1 - capture fraction) (USEPA 2005b). Capture fraction for agricultural areas is 0.25 (USEPA 2005a).
^e Vehicle emissions calculated using the USEPA MOVES model, version 2010b (USEPA 2012b). Assumed that energy center workers would travel primarily on local roads while trucks would travel primarily on highways. Note that vehicle tire wear and brake wear emissions are also included under PM₁₀ and PM_{2.5}. See Total Construction Emissions for further discussion of impacts from diesel exhaust.
 CO = carbon monoxide; MOVES = Motor Vehicle Emission Simulator; NA = not applicable; NO_x = nitrogen oxides; PM_{2.5} = particulate matter of diameter 2.5 microns or less; PM₁₀ = particulate matter of diameter 10 microns or less; SO₂ = sulfur dioxide; USEPA = U.S. Environmental Protection Agency; VOCs = volatile organic compounds

CO₂ Storage Study Area

The CO₂ injection well site(s) would consist of the wells, associated buildings, roads, and other components as described in Section 2.5.2. DOE calculated exhaust emissions originating from the construction and drilling equipment, as well as the fugitive dust emissions generated in the construction area. DOE calculated the potential emissions assuming deep injection (and monitoring) wells would require drilling operations 24 hours per day, 7 days per week for 100 days; and shallow monitoring wells would require drilling operations 9 hours per day for 3 days. Other equipment used in construction of the injection well site(s) would include tractors, excavators, bulldozers, pumps, diesel generators, service vehicles, and delivery vehicles.

DOE calculated tailpipe emissions originating from the construction equipment, as well as fugitive dust emissions generated from mechanical disturbance of the surface and excavated material. DOE also calculated the tailpipe emissions from the worker vehicles and the delivery and waste trucks that would be associated with the project construction (see Section 3.13, Traffic and Transportation, for discussion of vehicle traffic). Table 3.1-10 summarizes the calculated emissions for construction of the injection wells and associated site buildings and access roads **based on the most conservative injection-site scenario**.

Table 3.1-10. Equipment and Vehicle Emissions for Construction of Injection Well Site(s)

	Emissions (tons)					
	CO	NO _x	PM ₁₀	PM _{2.5}	SO ₂	VOCs
CO ₂ Injection and Monitoring Well Sites Construction ^{a, b}	77	326	22	22	18	25
Fugitive Dust Emissions ^c	NA	NA	160	18	NA	NA
Vehicle Tailpipe Emissions ^d	8	17	1	1	0	1
Total	85	344	184	41	18	26

^a. Construction equipment estimates include type and hours of operation used during construction of all injection and monitoring wells and also construction of **surface facilities**, access roads, and drilling pads. **Assumptions are based on the single-site scenario currently proposed by the Alliance, which would be the most conservative scenario regarding number of wells and drilling durations. The single-site scenario would include four deep injection wells, five deep monitoring wells (drilling 24 hours per day for 100 days), and three shallow wells (drilling for 9 hours per day for 3 days).**

^b. Emissions factors are derived for construction equipment using NONROAD 2008a, USEPA emissions model, assuming average values for Morgan County (USEPA 2008a), and load factors (fraction of available power) from USEPA 2010a. NONROAD total PM calculation is PM₁₀ value. PM_{2.5} is assumed to be 97 percent of PM₁₀ for exhaust (USEPA 2010b).

^c. **Fugitive dust emissions estimates are calculated using the dual-site scenario described in the Draft EIS and no longer under consideration by the Alliance, which would be the most conservative scenario regarding land disturbance.** Estimates are based on total approximate land disturbance of 90 acres for injection and monitoring wells and associated facilities including access roads, during an average disturbance of 3.3 months (100 days). Total suspended particles = 1.2 tons/acre/month (USEPA 2012c AP-42, 13.2.3.3). PM₁₀ is 45 percent of total suspended particles (USAF 2003; USEPA 1995a). PM_{2.5} = PM₁₀*0.15(1 - capture fraction) (USEPA 2005b). Capture fraction for agricultural areas is 0.25 (USEPA 2005a).

^d. Vehicle emissions calculated using the USEPA MOVES model, version 2010b (USEPA 2012b). Assumed that energy center workers would travel primarily on local roads while trucks would travel primarily on highways. Note that vehicle tire wear and brake wear emissions are also included under PM₁₀ and PM_{2.5}. See Total Construction Emissions for further discussion of impacts from diesel exhaust.

CO = carbon monoxide; CO₂ = carbon dioxide; MOVES = Motor Vehicle Emission Simulator; NA = not applicable; NO_x = nitrogen oxides; PM_{2.5} = particulate matter of diameter 2.5 microns or less; PM₁₀ = particulate matter of diameter 10 microns or less; SO₂ = sulfur dioxide; USEPA = U.S. Environmental Protection Agency; VOCs = volatile organic compounds

Educational Facilities

The project would include construction of visitor, research, and training facilities that are proposed to be located near Jacksonville. These facilities could involve new construction, rehabilitation of existing structures, or a combination. Because the location and configuration of these buildings are currently undecided, DOE estimated emissions based on the most conservative scenario, which would be construction of new facilities.

DOE calculated tailpipe emissions originating from the construction equipment, emissions from worker and delivery vehicles, as well as fugitive dust emissions generated from mechanical disturbance of the surface and excavated material. Table 3.1-11 summarizes the calculated emissions for construction of the educational facilities.

Table 3.1-11. Equipment and Vehicle Emissions for Construction of Educational Facilities

	Emissions (tons)					
	CO	NO _x	PM ₁₀	PM _{2.5}	SO ₂	VOCs
Equipment Tailpipe Emissions ^{a, b, c}	1	2	0	0	0	0
Fugitive Dust Emissions ^d	NA	NA	6	1	NA	NA
Vehicle Tailpipe Emissions ^e	4	3	0	0	0	0
Total	5	5	6	1	0	0

^{a.} Tailpipe emissions based on 52 weeks to construct.

^{b.} Emissions factors derived for construction equipment using NONROAD 2008a, USEPA emissions model, assuming average values for Morgan County (USEPA 2008a), and load factors (fraction of available power) from USEPA 2010a.

^{c.} NONROAD total PM calculation is PM₁₀ value. PM_{2.5} is assumed to be 97 percent of PM₁₀ for exhaust (USEPA 2010b).

^{d.} Fugitive dust emissions estimates based on 3.5 acres of land disturbance, during an average disturbance of 3 months. Total suspended particles = 1.2 tons/acre/month (USEPA 2012c AP-42, 13.2.3.3). PM₁₀ is 45 percent of total suspended particles (USAF 2003; USEPA 1995a). PM_{2.5} = PM₁₀*0.15(1 - capture fraction) (USEPA 2005b). Capture fraction for agricultural areas is 0.25 (USEPA 2005a).

^{e.} Vehicle emissions calculated using the USEPA MOVES model, version 2010b (USEPA 2012b). Assumed that energy center workers would travel primarily on local roads while trucks would travel primarily on highways. Note that vehicle tire wear and brake wear emissions are also included under PM₁₀ and PM_{2.5}.

CO = carbon monoxide; MOVES = Motor Vehicle Emission Simulator; NA = not applicable; NO_x = nitrogen oxides; PM_{2.5} = particulate matter of diameter 2.5 microns or less; PM₁₀ = particulate matter of diameter 10 microns or less; SO₂ = sulfur dioxide; USEPA = U.S. Environmental Protection Agency; VOCs = volatile organic compounds

Total Construction Emissions

Table 3.1-12 presents the total estimated construction emissions for the proposed project based on the preliminary project design and conservative assumptions regarding activity levels and duration. DOE believes that these calculated total emissions overestimate actual potential emissions. Because Morgan County is in attainment for all criteria pollutants, CAA conformity requirements are not applicable, and thus there are no construction emissions thresholds that pertain to the construction phase of this project. Emissions from construction activities would be short term in nature, and would be expected to have only a minor impact on local air quality. These emissions would be concentrated at the construction sites and would steadily decrease with distance. Fugitive dust emissions consisting of larger particulates would be greatest during land-disturbance activities and would generally deposit within several hundred feet of the construction areas.

Construction equipment and vehicles that operate on diesel fuel produce exhaust that has been associated with several health-related concerns, particularly from emissions of particulate matter, nitrogen oxides, sulfur oxides, and HAPs. Diesel exhaust is a complex mixture of hundreds of constituents in either a gas or particle form resulting from the complete and incomplete combustion of fuel and small amounts of engine oil. Pollutant concentrations from diesel emissions during construction of the FutureGen 2.0 Project would be concentrated at the construction sites and would decrease with distance. DOE anticipates the resultant adverse impacts would be minor, as the construction duration is short term, and the sites are not in direct proximity to sensitive populations or at locations with severe existing pollutant concentrations such that the project would contribute to a cumulative impact.

Construction-related emissions would be further reduced with the implementation of industry standard BMPs, including control of vehicle speeds, minimizing or stabilizing exposed areas to reduce wind erosion, wetting of exposed areas and roads with water or appropriate surfactants, reducing or eliminating equipment idling time, and using properly maintained equipment.

Table 3.1-12. Total Construction Emissions

	Emissions (tons) ^{a, b}					
	CO	NO _x	PM ₁₀	PM _{2.5}	SO ₂	VOCs
Oxy-Combustion Facility	104	108	541	48	3	11
CO ₂ Pipeline	20	45	306	37	1	4
Injection Well Site(s)	85	344	184	41	18	26
Educational Facilities	5	5	6	1	0	0
Total	214	502	1,037	127	22	41

^a. Total emissions include equipment tailpipe, fugitive dust, and vehicle tailpipe emissions (see Tables 3.1-8, 3.1-9, 3.1-10, and 3.1-11).

^b. See Section 3.2, Climate and Greenhouse Gases, for discussion of CO₂-eq.

CO = carbon monoxide; CO₂ = carbon dioxide ; CO₂-eq = carbon dioxide equivalent; NO_x = nitrogen oxides; PM_{2.5} = particulate matter of diameter 2.5 microns or less; PM₁₀ = particulate matter of diameter 10 microns or less; SO₂ = sulfur dioxide; VOCs = volatile organic compounds

3.1.3.2 Operational Impacts

Meredosia Energy Center

As described in Section 2.4, the FutureGen 2.0 Project intends to repower the energy center utilizing and modifying various existing equipment as well as constructing and using new equipment and processes. The purpose of the proposed project would be to establish a coal-fired electrical generating facility that uses oxy-combustion technology and state-of-the-art flue gas scrubbing technology to minimize criteria pollutants, as well as capture at least 90 percent of the GHGs that would otherwise be emitted **during normal steady-state operations.**

Emissions Analysis

This section describes the FutureGen 2.0 Project’s environmental impacts using emissions calculations and analysis for both the current baseline conditions with the energy center no longer in operation, as well as using historical baseline conditions prior to the 2011 suspension of operations of the energy center. In addition to emissions from the oxy-combustion boiler and compression and purification unit, emissions would also be generated by the auxiliary boiler, the emergency diesel generator, as well as fugitive emissions from conveyance and transfer of the process materials and waste (coal, ash, lime, and trona), cooling towers, and truck traffic on the haul roads. Table 3.1-13 lists the units associated with the project and whether these units are new or existing.

Initial design plans and air permitting documents for the FutureGen 2.0 Project were based on a 200 MWe system. The Alliance subsequently determined that a 168-MWe capacity system would be more appropriate and revised the design during preparation of the Draft EIS. Because the construction air permit application for the 168 MWe system had not yet been prepared, DOE based its air quality analysis for the Draft EIS on the prior construction air permit application for the 200 MWe system (Ameren 2012). That evaluation provided a conservative, upper-bound estimate for potential impacts. Since publication of the Draft EIS, the Alliance prepared and submitted a revised construction permit application in June 2013 for the updated design of the energy center (Ameren 2013). Accordingly, DOE updated this Air Quality section in the Final EIS to discuss estimated air emissions based on the 168 MWe design.

Table 3.1-14 presents a summary of the estimated (upper-bound) project emissions for the oxy-combustion facility, operating at 168 MWe as presented in the construction permit application to the IEPA in June 2013 (Ameren 2013). These estimated emissions were reported in the construction permit application to demonstrate that FutureGen 2.0 would not trigger PSD applicability for significant net emissions increases (as shown in Table 3.1-20). The estimated emissions were based

on the conservative assumption that the energy center would operate 8,760 hours per year and with worst-case emissions rates for the three representative operating conditions evaluated (air firing, oxy-combustion with storage, oxy-combustion without CO₂ storage).

Table 3.1-13. Meredosia Energy Center Proposed Emissions Units

Emissions Unit	New or Existing
Oxy-Combustion Boiler	New
Auxiliary Boiler	New
Ash Transfer	New
Compression and Purification Unit (CPU)	New
Lime Transfer	New
Trona Transfer	New
Cooling Towers	New
Coal Transfer and Conveying	Existing
Haul Roads	Existing

Table 3.1-14. Project Emissions Summary to Determine PSD Applicability

Emissions Unit	Emissions (tpy)							Sulfuric Acid Mist ^a	VOCs
	SO ₂	NO _x	CO	PM ₁₀	PM _{2.5}	Lead	Fluorides		
Worst Case EGU emissions	322.4	1,690.7	481.8	64.5	64.5	0.2	2.8	10.5	11.6
Auxiliary Boiler	0.6	41.6	15.4	16.6	4.9	0.004	---	---	1.7
Coal Transfer and Conveying	---	---	---	3.5	0.3	---	---	---	---
Ash Transfer	---	---	---	2.6	2.6	---	---	---	---
Lime Transfer	---	---	---	3.0	3.0	---	---	---	---
Trona Transfer	---	---	---	0.0	0.0	---	---	---	---
Cooling Towers	---	---	---	4.4	4.4	---	---	---	---
Haul Roads ^b	---	---	---	1.9	0.5	---	---	---	---
Total Operational Project Emissions^{c, d, e}	323	1,732.3	497.2	96.5	80.2	0.2	2.8	10.5	13.3

Source: Ameren 2013

^a. Sulfuric acid mist calculation assumes oxy-combustion boiler operates 4,800 hours in air fire with the remaining time in oxy-combustion, which is the worst case scenario.

^b. The PM_{2.5} and PM₁₀ emissions from haul roads reflect a worst case scenario where 100 percent of the coal would be delivered by truck. This worst-case scenario is analyzed for permitting purposes only, and does not reflect the Alliance's anticipated project plans (see Section 2.4.4.1 for discussion on the delivery of coal).

^c. The data in this table reflect a generating capacity of 168 MWe as presented in the June 2013 construction permit application (Ameren 2013).

^d. The emissions data presented in this table represent scenarios presented in the construction permit application (Ameren 2013). Project emissions are based on continuous operation (8,760 hours per year) and conservatively high hourly emissions rates.

^e. These emissions are for stationary source emissions.

Note: This table was replaced in its entirety (from the Draft EIS version) to reflect the updated design of 168 MWe and revised construction permit application (Ameren 2013).

CO = carbon monoxide; EGU = electrical generating unit; NO_x = nitrogen oxides; PM_{2.5} = particulate matter of diameter 2.5 microns or less; PM₁₀ = particulate matter of diameter 10 microns or less; PSD = Prevention of Significant Deterioration; SO₂ = sulfur dioxide; tpy = tons per year; VOCs = volatile organic compounds

It is important to note that the emissions levels presented in Table 3.1-14 are part of the PSD applicability analysis presented in the construction permit application, and are not normal or allowable emissions levels. These estimates are considerably greater than actual emissions during normal operations, because the oxy-combustion facility would also be subject to NSPS and NESHAP regulatory limits. Further, the data is based on the auxiliary boiler operating 8,760 hours per year during startup, when in reality, the operations design assumes only 240 hours of auxiliary boiler operation annually after the first year of operation.

During normal operations (as described in Section 2.4.2.1), the flue-gas, upon exiting the boiler, would enter the gas quality control system, which comprises numerous steps designed to remove pollutants, recover heat, and prepare the flue gas before entering the compression and purification unit. The gas quality control system would incorporate processes to reduce criteria pollutants to low levels. Table 3.1-15 presents select pollutant emissions during normal operating conditions based on the 168 MWe design assuming an 85 percent operating capacity. Emissions would be higher during startup, in the case of a compression and purification unit or pipeline malfunction, and during shutdown. **However, these conditions are expected to be rare as NSPS and NESHAP requirements would not allow for the FutureGen 2.0 Project to operate under these conditions for extended periods.** Designers anticipate minimal HAPs emissions during normal operations. See Section 3.2, Climate and Greenhouse Gases, for further discussion on CO₂ and other GHG air emissions from the proposed project.

Table 3.1-15. Oxy-Combustion Facility Emissions under Normal Operating Conditions

Emissions Constituent	Tons per year ^{a, b}
CO	86.5
NO _x	214.6
PM ₁₀ (filterable)	36.2
PM _{2.5}	32.6
SO ₂	21.5
VOCs	7.3
Hg	0.0073

^a. Emissions listed in the table are based on expected annual operating conditions for the 168 MWe design and hourly emissions rates from the **June 2013** air permit application. Expected annual operating conditions assumes the CPU (processing flue gas from the oxy-combustion boiler) operating at a maximum capacity for 7,446 hours per year; the oxy-combustion boiler operating in air-fire mode without the CPU for **240 hours per year; and 240 hours in oxy-combustion transition annually.** Estimates include emissions from the oxy-combustion boiler, the CPU, the auxiliary boiler, and the various material-handling units that support these operations.

^b. See Section 3.2, Climate and Greenhouse Gases, for discussion of CO₂-eq.
 CO = carbon monoxide; CO₂-eq = carbon dioxide equivalent; CPU = compression and purification unit; Hg = mercury; MWe = megawatt electrical; NO_x = nitrogen oxides; PM = particulate matter; SO₂ = sulfur dioxide; VOCs = volatile organic compounds

Emissions Impact Summary in Relation to Current Baseline Conditions

The new boiler for the oxy-combustion facility, Boiler 7, would have its own emissions stack, and thus not use any of the existing stacks at the energy center. Emissions from the new stack would have different plume velocity and buoyancy characteristics and thus its resultant air pollution dispersion characteristics would be different from those generated by the Meredosia Energy Center prior to suspension of operations at the end of 2011. Air dispersion modeling, using USEPA’s model AERMOD, was performed

to assess the potential air quality impacts of the proposed project and demonstrate compliance with the NAAQS (Ameren 2013).

The emissions modeling was based on the 168 MWe design of the oxy-combustion boiler, and assumed that all existing boilers would be decommissioned, and that the new auxiliary boiler could be fully utilized. Modeling included four distinct operating conditions:

- **Model Condition 1: The boiler operates using ambient air for combustion, and the energy center requires the use of an auxiliary boiler for steam.**
- **Model Condition 2: Normal full-load oxy-combustion operation of the new boiler and CPU. The CO₂ stream is transported through pipeline and sequestered. The noncondensable CPU stream is vented to the atmosphere. The auxiliary boiler is not operational.**
- **Model Condition 3: Normal full-load oxy-combustion operation of the new boiler, including normal CPU processing flue gas, but the CO₂ stream is vented to the atmosphere along with the noncondensable stream. The auxiliary boiler is not operational.**
- **Model Condition 4: An intermediate operation in which the new boiler has transitioned from air combustion to oxy-combustion, but it has not reached full load, nor is the CPU fully operational. The auxiliary boiler is not operational.**

The first step in the modeling exercise was to determine if the proposed project components could generate ambient air quality impacts that would exceed the significant impact levels (SILs) established by the USEPA, as shown in Table 3.1-16. Air quality impacts at or below the SIL are considered *de minimis* in nature. Table 3.1-17 lists the highest modeled concentrations for these model conditions, and whether they cause a significant impact. If the ambient air quality impacts associated with the project emissions were found to be greater than the SILs for any pollutant, a cumulative impacts assessment was performed for those pollutants and model conditions.

Table 3.1-16. Significant Impact Levels

Pollutant	Averaging Period	SIL (µg/m ³)
NO ₂	1-hour	7.5
	annual	1.0
SO ₂	1-hour	7.9
	3-hour	25
	24-hour	5.0
	annual	1.0
CO	1-hour	2,000
	8-hour	500
PM ₁₀	24-hour	5.0
PM _{2.5}	24-hour	1.2^a
	annual	0.3^a

^a. On January 22, 2013, the United States Court of Appeals for the District of Columbia Circuit vacated and remanded the portions of two PSD PM_{2.5} rules (40 CFR 51.166 and 40 CFR 52.21) addressing the SIL for PM_{2.5}. For this EIS, that SIL is used to determine if significant impacts would occur.

CO = carbon monoxide; NO₂ = nitrogen dioxide; PM_{2.5} = particulate matter of diameter 2.5 microns or less; PM₁₀ = particulate matter of diameter 10 microns or less; PSD = Prevention of Significant Deterioration; SIL = significant impact level; SO₂ = sulfur dioxide; µg/m³ = micrograms per cubic meter

Table 3.1-17. FutureGen 2.0 Significant Impact Analysis Results

Model Condition	Pollutant	Averaging Period	Highest Concentration (µg/m ³)	Significant Impact?
Model Condition 1 (air fired)	NO ₂	1-hour	141.06	Yes
		annual	4.62	Yes
	SO ₂	1-hour	9.91	Yes
		3-hour	7.19	No
		24-hour	2.29	No
		annual	0.14	No
	CO	1-hour	88.78	No
		8-hour	28.04	No
PM ₁₀	24-hour	17.03	Yes	
PM _{2.5}	24-hour	4.52	Yes	
	annual	0.54	Yes	
Model Condition 2 (normal operation)	NO ₂	1-hour	22.82	Yes
		annual	0.24	No
	SO ₂	1-hour	0.80	No
		3-hour	0.66	No
		24-hour	0.12	No
		annual	0.0059	No
	CO	1-hour	12.11	No
		8-hour	2.64	No
	PM ₁₀	24-hour	0.65	No
	PM _{2.5}	24-hour	0.59	No
annual		0.036	No	
Model Condition 3 (pipeline bypass)	NO ₂	1-hour	506.91	Yes
		annual	1.84	Yes
	SO ₂	1-hour	16.42	Yes
		3-hour	17.17	No
		24-hour	2.33	No
		annual	0.043	No
	CO	1-hour	32.66	No
		8-hour	4.92	No
PM ₁₀	24-hour	1.17	No	
PM _{2.5}	24-hour	0.81	No	
	annual	0.024	No	

Table 3.1-17. FutureGen 2.0 Significant Impact Analysis Results

Model Condition	Pollutant	Averaging Period	Highest Concentration (µg/m ³)	Significant Impact?
Model Condition 4 (oxy-combustion transition)	NO ₂	1-hour	13.15	Yes
		annual	0.14	No
	SO ₂	1-hour	0.44	No
		3-hour	0.33	No
		24-hour	0.064	No
		annual	0.0033	No
	CO	1-hour	7.55	No
		8-hour	1.46	No
	PM ₁₀	24-hour	2.04	No
	PM _{2.5}	24-hour	1.87	Yes
annual		0.12	No	

CO = carbon monoxide; NO₂ = nitrogen dioxide; PM_{2.5} = particulate matter of diameter 2.5 microns or less; PM₁₀ = particulate matter of diameter 10 microns or less; SO₂ = sulfur dioxide; µg/m³ = micrograms per cubic meter

A cumulative impact assessment was performed for only the specific model conditions, pollutants, and averaging periods that resulted in significant impacts as shown in the last column of Table 3.1-17. Table 3.1-18 lists the highest cumulative impacts and NAAQS for each modeled pollutant. This cumulative assessment included modeling emissions from the proposed project combined with other significant sources and background concentrations provided by IEPA (Ameren 2013) to provide a cumulative ambient air impact concentration. The analysis showed that modeled cumulative concentrations of certain pollutants exceeded the NAAQS.

To determine if the FutureGen 2.0 Project would contribute to the NAAQS exceedances, DOE performed a significant contribution analysis. **If the cumulative concentration exceeds the NAAQS at a receptor, then the project’s contribution at that receptor, at the time of the modeled exceedance, is compared to the SIL. Contributions below the SIL are considered *de minimis*, and indicate that the proposed project would not significantly contribute to a violation of the NAAQS.**

Table 3.1-19 shows the FutureGen 2.0 Project’s maximum contribution to any modeled exceedances for each model condition and pollutant. The analysis shows that the FutureGen 2.0 Project would not significantly contribute to any of the modeled exceedances because none of the FutureGen 2.0 Project contributions were above the SILs when a NAAQS exceedance occurred, **with the exception of 24-hour PM_{2.5} in model condition 1. There are nine receptors for which the contribution of the auxiliary boiler exceeds this threshold. The oxy-combustion boiler’s contribution is less than 1 percent of the total. Based upon alternative evaluation modeling, the Alliance has determined that this contribution would be lowered below the threshold through the use of a more specific and accurate emissions factor based on the actual equipment chosen for the project and adjustment of the stack height, if required.** Therefore, operations of the FutureGen 2.0 Project would be unlikely to significantly contribute to any modeled NAAQS exceedance (Ameren 2013).

Table 3.1-18. Cumulative Impact Analysis

Model Condition	Pollutant	Averaging Period	Maximum Cumulative Impact ($\mu\text{g}/\text{m}^3$) ^a	NAAQS ($\mu\text{g}/\text{m}^3$)
Model Condition 1	NO ₂	1-hour	249.8	188.1
		Annual	35.9	100
	SO ₂	1-hour	2,771	196.3
	PM ₁₀	24-hour	1,351	150
		Annual	20.87	12
Model Condition 2	NO ₂	1-hour	249.8	188.1
		Annual	35.9	100
Model Condition 3	NO ₂	1-hour	249.8	188.1
		Annual	35.9	100
Model Condition 4	NO ₂	1-hour	249.8	188.1
		PM _{2.5}	24-hour	1,606

^a Maximum cumulative impacts include background concentrations.

NAAQS = National Ambient Air Quality Standards; NO₂ = nitrogen dioxide; PM_{2.5} = particulate matter of diameter 2.5 microns or less; PM₁₀ = particulate matter of diameter 10 microns or less; SO₂ = sulfur dioxide; $\mu\text{g}/\text{m}^3$ = micrograms per cubic meter

Table 3.1-19. FutureGen 2.0 Significant Contribution Analysis Results

Model Condition	Pollutant	Averaging Period	Maximum Contribution ($\mu\text{g}/\text{m}^3$)	SIL ($\mu\text{g}/\text{m}^3$)
Model Condition 1	NO ₂	1-hour	4.3	7.5
		Annual	0.1	0.3
	SO ₂	1-hour	0.02	7.9
	PM ₁₀	24-hour	1.0	5.0
		Annual	0.1	0.3
Model Condition 2	NO ₂	1-hour	0.9	7.5
		Annual	0.1	0.3
Model Condition 3	NO ₂	1-hour	4.5	7.5
		Annual	0.1	0.3
Model Condition 4	NO ₂	1-hour	0.7	7.5
		PM _{2.5}	24-hour	0.7

NO₂ = nitrogen dioxide; PM_{2.5} = particulate matter of diameter 2.5 microns or less; PM₁₀ = particulate matter of diameter 10 microns or less; SIL = significant impact level; SO₂ = sulfur dioxide; $\mu\text{g}/\text{m}^3$ = micrograms per cubic meter

Emissions Impact Summary in Relation to Historical Baseline Conditions

Air permitting requirements allow for consideration of historical emissions levels. In its air permit application with the state of Illinois, the Meredosia Energy Center would be taking credit for contemporaneous emissions decreases resulting from the **permanent shutdown of all boilers at the energy center that would take place once FutureGen 2.0 becomes operational**. Overall, the net emissions of the Meredosia Energy Center would decrease in comparison to historical emissions rates.

PSD permits are required if net emissions from a project exceed the threshold limits. Net emissions increase is defined in 40 CFR 52.21(b)(3)(i) as

“... the amount by which the sum of the following exceeds zero:

- (a) *The increase in emissions from a particular physical change or change in the method of operation at a stationary source ... and*
- (b) *Any other increases and decreases in actual emissions at the major stationary source that are contemporaneous with the particular change and are otherwise creditable...*”

Net emissions were calculated in comparison to “contemporaneous” operations of the energy center, which used two years of emissions levels within a five-year period prior to the start of construction for the proposed project. Based on the projected start of construction for the FutureGen 2.0 Project, the emissions sources at the Meredosia Energy Center that would

Contemporaneous emissions are used to determine if a PSD permit is required. Contemporaneous changes in emissions are any increases or decreases in emissions that occur during any 2-year (24-month) period within the 5 years prior to the start of construction.

have contemporaneous emissions changes include the installation of an emergency diesel generator in November 2008 under IEPA Permit No. 08100029, the shutdown of the six existing boilers, and the proposed demolition of the existing Unit 4 cooling tower. Boilers 1 through 4 suspended service on November 9, 2009. Boilers 5 and 6 were suspended on January 1, 2012. **Operating permits for the existing boilers held by Ameren remain in effect, but were suspended by the Illinois Pollution Control Board pending resolution of an Ameren appeal. Under the Illinois Pollution Control Board rules, the facility may continue to operate under its previous operating permit until such time as the appeal process is resolved.**

Table 3.1-20 presents the total projected energy center emissions, the decrease in emissions due to the 2011 suspension of operations at the energy center, and the net change in emissions from pre-suspension historical conditions. As shown, the project would not result in net emissions greater than the PSD significance threshold (per 40 CFR 52.21(b)(23)(i)) and, therefore, the project would not be subject to the PSD regulations. However, because the project would include the construction of new emissions units, a state construction permit would be required.

As discussed above, these emissions changes are based on the conservative assumptions used in the construction permit application, whereby normal operations would only occur approximately 50 percent of the time (with the remaining periods consisting of startup, compression and purification unit or pipeline malfunctions, or shutdown scenarios, when the oxy-combustion and optimal flue-gas scrubbing would not be occurring). During normal operations, the system is designed for near-zero emissions levels as shown in Table 3.1-15.

Cooling Tower Impacts

The oxy-combustion facility would have three separate cooling water loops and associated cooling towers. These are the main cooling tower, the cooling tower for both the air separation unit and compression and purification unit, and the cooling tower for the direct contact cooler polishing system. In order to assess the potential for impacts of vapor plumes from the proposed cooling towers, DOE used the 2010 IDOT Environmental Assessment of the Alternative #9 bridge location (see Section 3.1.2.1) as an analog for the analysis. This IDOT study reflects potential impacts of the historical cooling tower operations at the Meredosia Energy Center (assuming the cooling tower operated continuously year-round) on a potential bridge location approximately 700 feet upstream of the energy center (IDOT 2011).

Table 3.1-20. Significant Net Emissions from Energy Center Operations

	Emissions (tpy)								
	SO ₂	NO _x	CO	PM ₁₀	PM _{2.5}	Lead	Fluorides	Sulfuric Acid Mist	VOCs
Proposed Project Emissions ^{a, b, c, d}	323	1,732	497	97	80	0.2	2.7	10.5	13
Decrease in Emissions due to Shutdown of Boilers 1-6 ^e	(-9,541)	(-2,813)	(-1,369)	(-313)	(-189)	0	0	(-3.6)	(-374)
Net Emissions for Energy Center ^f	(-9,218)	(-1,081)	(-872)	(-216)	(-109)	0.2	2.7	6.9	(-361)
PSD Significance Increase Threshold ^g	40	40	100	15	10	0.6	3	7	40
Is PSD Permit Required? ^{h, i}	No	No	No	No	No	No	No	No	No

Source: Ameren 2013

^a. Refer to Table 3.1-14 for a detailed breakdown of emissions units during energy center operations.

^b. **The data in this table reflect a generating capacity of 168 MWe as presented in the June 2013 construction permit application (Ameren 2013).**

^c. Emissions data presented in this table assumes worst-case scenarios as presented in the construction permit application (Ameren 2013). This data reflects the conservative assumption that normal operations occur at a minimum of 50 percent of the time. **Further, the data assumes the auxiliary boiler operates 8,760 hours per year during startup, when in contrast, the design document assumes 240 hours annually after the first year.**

^d. Project emissions only include stationary source emissions.

^e. These values reflect the contemporaneous decrease in emissions due to cessation of Boilers 1-6 operations **as presented and discussed in Section 3.3.1 of the construction air permit application (Ameren 2013)**. For emissions of pollutants that are not monitored (CO, PM, and VOCs), emissions factors were developed based on stack test data when available or USEPA emissions factor data (AP-42) (Ameren 2013).

^f. Project emissions minus contemporaneous emissions decreases.

^g. Significance threshold for PSD regulations per 40 CFR 52.21(a)(2)(iv)(b).

^h. A PSD permit is required if net emissions exceed the threshold limits.

ⁱ. **See Section 3.2, Climate and Greenhouse Gases, for discussion of CO₂-eq.**

CO = carbon monoxide; NO_x = nitrogen oxides; PM_{2.5} = particulate matter of diameter 2.5 microns or less; PM₁₀ = particulate matter of diameter 10 microns or less; PSD = Prevention of Significant Deterioration; SO₂ = sulfur dioxide; tpy = tons per year; VOCs = volatile organic compounds

Table 3.1-21 presents the comparison between the existing cooling tower under historical design levels and the new cooling towers proposed for the oxy-combustion facility. As shown in the table, the new Unit 4 main cooling tower would be similar in size and water flow rate (85,000 gpm) to the historical main cooling tower (85,500 gpm). **The combined water flow rate of all three proposed cooling towers would be an estimated 119,250 gpm, or approximately 39 percent higher than the historical cooling tower flow rate.** However, the two smaller cooling towers would be physically separated from the new main cooling tower by more than 700 feet to the southeast. Vapor plumes generated from these towers would be expected to be substantially smaller than the plume generated by the main cooling tower, and would not be expected to contribute to any offsite impacts. DOE expects that the vapor plume generated by the proposed new main cooling tower would be similar to the historical plume estimated by the SACTI model in the IDOT study (described in Section 3.1.2.1), whereby there may be fog and ice impacts for approximately 15.4 hours and 6 hours per year, respectively, to the southeast of the energy center (Holzman 2010). The IDOT study concluded that potential impacts from the historical vapor plume to the Alternative #9 bridge alignment would not be significant, and would be even less significant on the Alternative #3 bridge location that IDOT ultimately chose (located one third of a mile farther north from

the Meredosia Energy Center). Thus, since the new main cooling tower is similar in size to the historical cooling tower, potential vapor plume impacts to the proposed bridge are not expected to occur as a result of the proposed project.

Table 3.1-21. Comparison of Existing and Proposed Cooling Towers

	Historical ^a		Proposed ^b	
	Main Cooling Tower	Unit 4 Main Cooling Tower	ASU/CPU Cooling Tower	DCCPS Cooling Tower
Water Flow Rate (circulating)	85,500 gpm	85,500 gpm	18,500 gpm	15,750 gpm

Source: Holzman 2010

^a The historical scenario reflects operations prior to the suspension of the Meredosia Energy Center at the end of 2011.

^b The proposed scenario reflects the water flow-through rates for the new cooling towers proposed for the oxy-combustion facility.

ASU/CPU = air separation unit/compression and purification unit; DCCPS = direct contact cooler polishing system; gpm = gallons per minute

CO₂ Pipeline, CO₂ Storage Study Area, and Educational Facilities

The Alliance expects that there would be no new stationary emissions during operations of the pipeline or the educational facilities. During operations at the injection well site(s), the CO₂ would be pumped down the injection wells via **pipeline operating pressure imparted at the energy center** (see Section 3.15, Utilities). The injection well site would, however, have an emergency diesel generator if the electricity were to fail. **The generator would only be used during its monthly maintenance and upon emergency situations**, and would therefore have only a minor impact on regional air quality. There would be no other stationary emissions sources during operations of the injection well site. Table 3.1-22 shows the estimated emissions associated with the emergency generator, which are well below the PSD significance thresholds (shown in Tables 3.1-3 and 3.1-16).

Table 3.1-22. Generator Emissions at Injection Well Site during Operations

Emissions (tpy) ^{a, b}					
SO ₂	NO _x	CO	PM ₁₀	PM _{2.5}	VOCs
0.0002	0.507	0.063	0.01	0.01	0.095

^a Emergency diesel generator emissions are based on the current design of a 1 KW generator reflected in the revised construction permit application, using the assumption of 500 hours as an appropriate estimate of the number of operational hours for an emergency generator during worst-case conditions (Ameren 2013). The size of the emergency generator has been reduced since publication of the Draft EIS, due to the elimination of the booster pumps from the current design of the injection well site.

^b These emissions do not include mobile source emissions.

CO = carbon monoxide; KW = kilowatt; NO_x = nitrogen oxides; PM_{2.5} = particulate matter of diameter 2.5 microns or less; PM₁₀ = particulate matter of diameter 10 microns or less; SO₂ = sulfur dioxide; tpy = tons per year; USEPA = U.S. Environmental Protection Agency; VOCs = volatile organic compounds

Diesel Exhaust Emissions during Operations

Diesel exhaust from equipment and vehicles that run on diesel fuel (including the auxiliary boiler and emergency generators) has been associated with several health-related concerns, particularly from emissions of particulate matter, nitrogen oxides, sulfur oxides, and HAPs. Diesel exhaust is a complex mixture of hundreds of constituents in either a gas or particle form resulting from the complete and incomplete combustion of fuel and, depending on the type of equipment, sometimes small amounts of engine oil. Pollutant concentrations from diesel emissions during operation of the FutureGen 2.0 Project would be concentrated at the project sites and would decrease with distance. DOE anticipates the resultant adverse impacts would be minor, as the sites are not in direct proximity to sensitive populations or at

locations with severe existing pollutant concentrations such that the project would contribute to a cumulative impact. The emergency generators would be located over 1,000 feet away from any receptor, and are for emergency usage only and would not be permitted for continual usage.

Mobile Source Emissions during Operations

During operations, the project would indirectly generate exhaust emissions from worker vehicles and delivery and waste trucks associated with operations of the energy center, injection wells, educational facilities, and from periodic inspections of the pipeline (see Section 3.13, Traffic and Transportation, for discussion of vehicle traffic). Table 3.1-23 presents these estimated mobile source emissions. Mobile source emissions would be reduced by limiting speeds on roads, reducing vehicle idle time, and maintaining engines according to manufacturer’s specifications. See Section 3.2, Climate and Greenhouse Gases, for discussion of mobile source emissions of CO₂ and other GHGs.

Table 3.1-23. Vehicle Emissions during Project Operations

Project Location	Emissions (tpy) ^a					
	CO	NO _x	PM ₁₀	PM _{2.5}	SO ₂	VOCs
Meredosia Energy Center	18	67	3	2	0	3
CO ₂ Pipeline	0	0	0	0	0	0
Injection Well Site(s)	1	0	0	0	0	0
Educational Facilities	1	0	0	0	0	0

^a Vehicle emissions calculated using the USEPA MOVES model, version 2010b (USEPA 2012b). Assumed that energy center workers would travel primarily on local roads while trucks would travel primarily on highways. Note that vehicle tire wear and brake wear emissions are also included under PM₁₀ and PM_{2.5}.

CO = carbon monoxide; CO₂ = carbon dioxide; MOVES = Motor Vehicle Emission Simulator; NO_x = nitrogen oxides; PM_{2.5} = particulate matter of diameter 2.5 microns or less; PM₁₀ = particulate matter of diameter 10 microns or less; SO₂ = sulfur dioxide; tpy = tons per year; USEPA = U.S. Environmental Protection Agency; VOCs = volatile organic compounds

Total Operations Emissions

In summary, criteria pollutant or HAP emissions generated by operations of the proposed project would not exceed relevant air quality or health standards when analyzed as an isolated project or when cumulatively combined with applicable regional sources. The project would not jeopardize the attainment status of the region for any criteria pollutant; nor would the project impact the air quality or visibility at any Class I areas.

3.1.4 Impacts of the No Action Alternative

Under the no action alternative, DOE would not provide cost-shared funding for the FutureGen 2.0 Project. Although the Alliance may still elect to construct and operate the project in the absence of DOE cost-shared funding, for the purposes of the analysis in this EIS, DOE assumed that the no action alternative is equivalent to a no-build alternative. Therefore, the project would not be constructed and there would be further reduction in air emissions with the suspension of all air emissions sources at the Meredosia Energy Center.

3.2 CLIMATE AND GREENHOUSE GASES

3.2.1 Introduction

This section provides information on the climate in the region of the Meredosia Energy Center and the proposed CO₂ pipeline, injection wells, and educational facilities. In addition, this section provides background information on GHGs including what they are, how they are produced, and why they are of concern and discusses regional and federal regulations and initiatives to limit GHG emissions. Current emissions levels are then presented, along with estimates of GHG emissions that could potentially occur as a result of the construction and operation of this project. The contributions of these emissions to regional and national levels are discussed, including potential direct and indirect project benefits from reductions in GHG emissions. A further discussion of GHG emissions from the project, as they relate to the potential for global climate change, is provided in Section 4.3, Potential Cumulative Impacts.

3.2.1.1 Region of Influence

The ROI for climate is the regional area of the project location in Morgan County, Illinois. The ROI for GHG emissions is broadly discussed in regional (the state of Illinois), national (the United States), and global terms. Potential impacts of GHGs on climate change are generally viewed from a global cumulative perspective.

3.2.1.2 Method of Analysis and Factors Considered

Meteorology and climate data were obtained primarily from National Oceanic and Atmospheric Administration (NOAA) data sources, as well as monitoring stations within Central Illinois. Weather data for Morgan County was obtained from a weather station in Jacksonville, Illinois, which has the most extensive and readily available information for the area. The Jacksonville weather station is approximately 20 miles southeast of the Meredosia Energy Center and approximately 8 miles southwest of the center of the CO₂ storage study area. GHG data were obtained from a variety of sources including the USEPA, the Energy Information Administration, the Intergovernmental Panel on Climate Change, the World Resources Institute, and the U.S. Global Change Research Program, formerly the U.S. Climate Change Science Program. DOE assessed the potential for impacts based on whether the project would:

- Cause an increase or decrease in GHG emissions of at least 75,000 tons per year (68,250 metric tons per year) CO₂-eq; or
- Threaten to violate federal, state, or local laws or requirements regarding GHG emissions.

Consistent with CEQ's draft guidance on climate change and NEPA analysis (CEQ 2010a), DOE used emissions rates as a surrogate for impact severity. Although there is currently no consensus on NEPA significance thresholds for GHG emissions, USEPA's GHG Tailoring Rule (see discussion under Table 3.2-1 below) limits applicability of GHG emissions standards under the CAA to new and modified stationary facilities emitting greater than 75,000 tons per year (68,250 metric tons per year) CO₂-eq of GHGs. DOE considered this to be a reasonable significance threshold for the purposes of analysis under this EIS.

3.2.1.3 Regulatory Framework

Concerns regarding the relationship between GHG emissions from anthropogenic (related to human activities) sources and changes to climate have led to a variety of federal, regional, and state initiatives and programs aimed at reducing or controlling GHG emissions from human activities. In addition to federal actions, regional organizations and numerous states have also taken action to address GHG concerns.

In 2007, the U.S. Supreme Court ruled in *Massachusetts v. EPA* that CO₂ and other GHGs met the definition of an air pollutant under the CAA and therefore, the USEPA had a duty to regulate GHGs if it

was determined that GHGs posed a threat to public welfare. The court also ruled that USEPA could choose not to regulate GHGs, but that decision would have to be grounded in the requirements of the CAA; the USEPA could no longer take the position that GHG regulation was best left to Congress as a national policy decision. This ruling became the impetus for the federal government to initiate various actions to address GHG-related concerns. Table 3.2-1 summarizes the key federal actions to date.

In recent years, Illinois and various Midwestern regional organizations have initiated actions to address GHG concerns. Table 3.2-2 summarizes these actions.

Table 3.2-1. Federal Actions to Address Greenhouse Gas Concerns

Federal Legislation	
Consolidated Appropriations Act of 2008/Public Law 110-161/GHG Reporting Program; Final Mandatory Reporting of GHG Rule	<p>Consolidated Appropriations Act of 2008 directed the USEPA to develop a mandatory reporting rule for GHGs. The Final Rule was published in October 2009 (effective January 1, 2010). The GHG Reporting Rule requires annual reporting of GHG emissions to USEPA from large sources and suppliers in the United States, including suppliers of fossil fuels or industrial GHGs; manufacturers of vehicles and engines; and facilities that emit more than 27,500 tons per year (25,000 metric tons per year) of CO₂-eq GHGs. GHG emissions reports are due annually to USEPA (USEPA 2011e; 40 CFR 98).</p> <p>In December 2010, USEPA finalized amendments that require reporting emissions from additional sources, including facilities that inject and store CO₂ underground for geologic sequestration or EOR (subpart RR and subpart UU) (75 FR 75060).</p>
Court Decisions	
U.S. Supreme Court Decision	U.S. Supreme Court decision (<i>Massachusetts v. EPA</i> , April 2007) that CO ₂ and other GHGs met the CAA definition of an air pollutant. The decision concluded that USEPA has authority to regulate GHGs (<i>Massachusetts v. EPA</i>).
Other Federal Actions	
Executive Order 13432	Executive Order issued (May 2007) to reduce the federal government's GHG emissions from motor vehicles, non-road vehicles, and non-road engines (Executive Order [EO] 13432).
Executive Order 13514, Federal Leadership in Environmental, Energy and Economic Performance	<p>Executive Order (issued October 2009) to make reduction of GHG emissions a priority for federal agencies (EO 13514).</p> <p>In October 2010, the CEQ finalized guidance establishing government-wide requirements for federal agencies in calculating and reporting GHG emissions associated with agency operations as required by EO 13514 (CEQ 2010b).</p>
USEPA GHG Endangerment Finding	GHG Endangerment Finding determination and issuance by USEPA (December 2009). USEPA found that six key GHGs pose threat to public health and welfare for current and future generations, and emissions of these GHGs from new motor vehicles contribute to GHG pollution (USEPA 2009a).
USEPA and DOT GHG Emissions and CAFE Standards	USEPA and DOT's National Highway Traffic and Safety Administration promulgated (April 2010) standards for model year 2012 to 2016 light-duty vehicles to reduce GHG emissions under the CAA, and new CAFE standards to improve fuel economy. Rulemaking (August 2012) was also completed to set standards for light-duty vehicles of model years 2017-2025 and to draft efficiency rules for medium- and heavy-duty engines and vehicles (EIA 2011; USEPA 2011f).

Table 3.2-1. Federal Actions to Address Greenhouse Gas Concerns

Other Federal Actions (Continued)	
Prevention of Significant Deterioration/Title V GHG Tailoring Rule	<p>USEPA issued a final rule (May 2010) to set thresholds for GHG emissions that define when permits under the New Source Review PSD and Title V Operating Permit programs are required for new and existing industrial facilities. This rule “tailored” the requirements of these CAA permitting programs to limit the requirement to obtain PSD and Title V permits to the nation’s largest GHG emitters, including power plants, refineries, and cement production facilities. Implementation of this rule will take place in a phased manner. Step 1 (January 2011-June 2011) focused on GHG emissions from facilities already covered under PSD or Title V permitting requirements. Step 2 of the GHG Tailoring Rule (July 2011-June 2013) expands CAA permitting requirements to cover new or existing facilities that are not otherwise subject to PSD or Title V requirements. PSD requirements will apply to new projects that emit at least 100,000 tons per year (91,000 metric tons per year) (CO₂-eq) of GHGs and existing facilities that increase their GHG emissions by at least 75,000 tons per year (68,250 metric tons per year) (CO₂-eq). Title V permitting requirements will apply to existing facilities that emit at least 100,000 tons per year (91,000 metric tons per year) (CO₂-eq) of GHGs (USEPA 2011g; USEPA 2011h; USEPA 2010e; EIA 2011).</p>
Proposed Carbon Pollution Standard for Future Power Plants	<p>On March 27, 2012, the USEPA proposed the first CAA standard for CO₂ emissions from future power plants. The proposed rule would have required new power plants to emit no more than 1,000 pounds of CO₂ per megawatt hour of electricity produced.</p> <p>In response to public comments and after considering recent trends in the power sector, on September 20, 2013, the USEPA announced a new proposed rule; in a separate action, it withdrew the 2012 proposed rule. The new proposed rule sets separate standards for coal- and natural gas-fired power plants. Coal-powered plants could choose from one of two alternate standards: 1,100 pounds CO₂/MWh gross over a 1-year operating period; or 1,000-1,050 pounds CO₂/MWh gross over a 7-year operating period (USEPA 2013a). The longer operating period offers operators flexibility by allowing them additional time to phase in the use of carbon capture technologies.</p>
FutureGen Initiative	<p>The FutureGen Initiative was conceived in the early part of the last decade and announced by President George W. Bush on February 27, 2003. FutureGen was an initiative to design and construct a first-of-its-kind IGCC, coal-to-hydrogen electric power plant. The initiative would have created the world’s first coal-based, zero emissions electricity and hydrogen power plant to support other federal initiatives, including the National Climate Change Technology Initiative (2001) and the Hydrogen Fuel Initiative (2003). However, in 2008 DOE announced that it would terminate funding for the original FutureGen project, primarily due to higher than expected costs.</p>
FutureGen 2.0	<p>FutureGen 2.0 is the successor to the original FutureGen Initiative. It is a public-private partnership formed by DOE for the purpose of developing the first large-scale oxy-combustion repowering project in the world that would use carbon capture and storage technology. The coal-powered, oxy-combustion facility would capture at least 90 percent of its CO₂ emissions during steady-state operation and reduce other pollutant emissions to near zero. The captured CO₂ would be transported through a 30-mile pipeline to injection wells where it would be injected into a deep geologic formation for permanent storage. The project would be designed to capture, transport, and inject approximately 1.2 million tons (1.1 million metric tons) of CO₂ annually, up to a total of 24 million tons (22 million metric tons) over approximately 20 years.</p>

CAA = Clean Air Act; CAFE = Corporate Average Fuel Economy; CEQ = Council on Environmental Quality; CFR = Code of Federal Regulations; CO₂ = carbon dioxide; CO₂-eq = carbon dioxide equivalent; DOE = U.S. Department of Energy; DOT = U.S. Department of Transportation; EO = Executive Order; EOR = enhanced oil recovery; FR = *Federal Register*; GHGs = greenhouse gases; IGCC = integrated gasification combined cycle; MWh = megawatt hour; PSD = Prevention of Significant Deterioration; U.S. = United States; USEPA = U.S. Environmental Protection Agency

Table 3.2-2. Regional and State Actions to Address Greenhouse Gas Concerns

Action or Initiative	Description
Midwest Geological Sequestration Consortium	The MGSC includes geological surveys of Illinois, Indiana, and Kentucky, along with private corporations, professional business associations, the Interstate Oil and Gas Compact Commission, three Illinois state agencies, and university researchers. The MGSC, which focuses on the Illinois Basin region, is one of seven regional partnerships established with support from DOE's National Energy Technology Laboratory to assess carbon capture, transportation, and geologic storage processes, as well as economic viability and public acceptability of carbon sequestration as one option for mitigating climate change in the United States and Canada (NETL 2010a; MGSC 2012). The MGSC is also supported by the Illinois Department of Commerce and Economic Opportunity's Office of Coal Development and the Illinois Clean Coal Institute.
Clean Coal Portfolio Standard Law (20 ILCS 3855/1-5)	<p>Illinois' Clean Coal Portfolio Standard Law (January 2009) established carbon sequestration targets for new coal-fueled power plants. New coal-fueled power plants that begin operations (1) before or during 2015 must capture and store 50 percent, (2) between 2016-2017 must capture and store 70 percent, and (3) after 2017 must capture and store 90 percent of the carbon emissions the facility would otherwise emit (ILGA 2009; Pew Center 2011).</p> <p>The law also requires large utilities serving Illinois to enter into long-term, cost-based contracts to purchase up to 5 percent of their electricity from clean coal facilities that capture at least 50 percent of their GHG emissions (ILGA 2009; Pew Center 2011).</p>
Midwestern Governors Association	In October 2009, the MGA governors agreed to the Midwestern Energy Infrastructure Accord committing to develop energy infrastructure to foster energy security, reduce GHG emissions, and spur jobs and investment in low-carbon energy development and technology manufacturing. In 2010, the MGA formed the CCS Task Force to help the Midwest meet its goals for commercial deployment of advanced coal technologies with CCS (MGA 2012).
Illinois Executive Order 2006-11	Illinois State Executive Order issued (October 2006) to initiate a long-term strategy by the state to combat global climate change, and build on the steps the state has already taken to reduce GHG emissions (Illinois EO 2006-11). The order created the ICCAG to consider a full range of policies and strategies to reduce GHG emissions in Illinois and make recommendations to the Governor (IEPA 2011b).

CCS = Carbon Capture and Storage; DOE = U.S. Department of Energy; GHGs = greenhouse gases; ICCAG = Illinois Climate Change Advisory Group; ILCS = Illinois Compiled Statutes; MGA = Midwestern Governors Association; MGSC = Midwest Geological Sequestration Consortium

3.2.2 Affected Environment

3.2.2.1 Regional and Local Climate

General Conditions

The FutureGen 2.0 Project would be located in a region of Illinois with a humid, continental climate consistent with Köppen Climate Classification "Dfa." The Köppen Climate Classification System recognizes five major climate types based on annual and monthly temperature and precipitation averages. Each major type is designated by a capital letter A through E. The letter "D" refers to continental climates found in the interior regions of large land masses. Further subgroups are designated by a second, lowercase letter that distinguishes seasonal temperature and precipitation characteristics. The letter "f" refers to moist climates with adequate precipitation in all months and no dry season. A third letter is used to further denote climate variations. The letter "a" refers to hot summers where the warmest month is over 72°F (Kottek et al. 2011; Blueplanet 2011).

Central Illinois has cold winters with average daily temperatures around 29°F and warm summers with average daily temperatures around 73°F. Atmospheric relative humidity varies diurnally and seasonally, with annual averages ranging from 83 percent in the mornings and 64 percent in the afternoons (NCDC 2011a). Maximum precipitation occurs in the spring and minimum precipitation occurs in the winter (NCDC 2013).

The central plains region of Illinois historically experiences a full spectrum of weather phenomena, including extreme heat and cold, ice storms and blizzards, high winds, heavy rainfall, thunderstorms, tornadoes, and localized floods. The proposed project site is located hundreds of miles inland from the Atlantic Coast and the Gulf Coast, such that coastal hurricanes do not occur within the region.

Meredosia Energy Center and Morgan County

The proposed oxy-combustion facility at the Meredosia Energy Center would be located in Morgan County in the west central region of Illinois. The CO₂ pipeline would travel approximately 30 miles east from the Meredosia Energy Center to the injection wells.

In Morgan County, average high and low temperatures in January range from approximately 35°F to 17°F, respectively. On average, temperatures fall below 0°F on 7 days per year. In mid-summer, temperatures range from average highs of 86°F to average lows of 63°F. Summer high temperatures frequently reach 90°F or above. Average annual precipitation is approximately 39 inches and measurable precipitation occurs approximately 109 days per year. Peak monthly precipitation occurs in May, with an average of 4.8 inches. Average winter snowfall totals 17 inches with maximum average monthly snowfall of 5.2 inches in January (NCDC 2013). Table 3.2-3 presents additional seasonal weather data for Morgan County.

Relevant severe weather events in Morgan County, Illinois, include frozen precipitation (hail, snow, and ice), tornadoes, floods, and drought (NCDC 2011b). Table 3.2-4 characterizes and quantifies historical severe weather events in Morgan County.

Table 3.2-3. Seasonal Weather Data for Morgan County

Weather Parameter ^a	Season ^b			
	Spring	Summer	Fall	Winter
Average Temperature, °F (1981-2010)	51.7	73.0	54.2	28.9
Average Temperature, °F (2010)	55.7	76.8	56.6	25.5 ^c
Average Precipitation Monthly, inches (1981-2010)	3.9	4.0	3.4	1.9
Average Precipitation Monthly, inches (2010)	5.1	7.4	2.4	2.4 ^c
Average Snowfall Monthly, inches (1981-2010)	0.9	0	0.2	4.8
Average Snowfall Monthly, inches (2010)	0	0	0	6.9 ^c

Sources: 1981-2010 data (NCDC 2013); 2010 data (ISWS 2013)

^a. DOE used temperature and precipitation data from the Jacksonville weather station because of its proximity to the proposed project, in order to reflect the general climate of the area; however, air modeling data (see Section 3.1, Air Quality) was assessed independently from this EIS and was not based on the Jacksonville weather station because it is not a first order National Weather Service meteorological station.

^b. Spring = March, April, May; Summer = June, July, August; Fall = September, October, November; Winter = December, January, February.

^c. 2010 winter data was calculated using monthly totals for December 2009, January 2010, and February 2010.

DOE = U.S. Department of Energy; °F = degrees Fahrenheit

Table 3.2-4. Severe Weather Events in Morgan County

Event Type	Event Frequency and Severity ^a
Hail, Snow, Ice	Morgan County had 76 hail events, of which 6 were recorded in Meredosia; 31 snow storms with 11 classified as heavy snow storms; and 3 ice storms that formed a glaze on road surfaces, trees, and power lines.
Thunderstorms	Morgan County had 70 severe thunderstorm events with winds over 55 mph, which included 20 in Jacksonville and 3 in Meredosia.
Tornadoes ^b	There were 25 tornadoes reported in Morgan County. This included 8 F0 tornadoes (40–72 mph), 10 F1 tornadoes (73–112 mph), 6 F2 tornadoes (113–157 mph), and 1 F3 tornado (158–207 mph). The single F3 tornado occurred in 1961, with a path approximately 19 miles long.
Floods ^c	There were 23 flood events in Morgan County, of which 19 were classified as flash floods. Five of the flood events occurred in Jacksonville and 3 in Meredosia when heavy rains caused temporary flooding across roadways.
Droughts ^d	There were 63 drought events reported in Illinois, ranging from mild to extreme.

Source: NCDC 2011b

^a. The National Climatic Data Center database provides historical storm events from 1950 through 2012. Availability of data for each severe weather event varies as follows: hail, snow, ice (1963–2012); thunderstorms (1955–2011); tornadoes (1957–2009); floods (1995–2011); and droughts (1996–2012).

^b. The Fujita Scale is a standard qualitative metric to characterize tornado intensity based on the wind speed and the damage caused. This scale ranges from F0 (weak) to F5 (violent).

^c. Heavy rains can cause localized flash flooding of waterways, and flooding of low-lying areas, particularly of roads. As discussed in Section 3.7, Wetlands and Floodplains, the energy center and CO₂ injection well site(s) would not be in the 100-year or 500-year floodplains; however, certain portions of the pipeline corridor would traverse floodplains.

^d. Droughts are typically defined as extended periods of time, usually over 3 months, when a region receives consistently below average precipitation and notes a deficiency in its water supply.

mph = miles per hour

Typical surface wind speed and direction for the project area are illustrated by a wind rose that displays the percentage of time over a given period that the wind blows from a particular direction. The nearest available wind rose was generated using data from the Springfield, Illinois Airport, located approximately 48 miles to the east from the Meredosia Energy Center. Figure 3.2-1 presents this wind rose displaying annual average wind characteristics generated using meteorological data from 2005 to 2009. The predominant surface wind direction for the region is from the south. The average wind speed is 9.4 miles per hour (4.23 meters per second). The region has calm winds 2.1 percent of the time.

3.2.2.2 Greenhouse Gases

Background Information

GHGs in the earth’s atmosphere help regulate the temperature of the planet. A part of the incoming solar radiation (sunlight) that reaches the earth’s surface is absorbed and then re-emitted as infrared radiation. GHGs in the atmosphere, in turn, absorb some of that infrared radiation and cause the atmosphere’s temperature to rise. This process, known as the greenhouse effect, essentially traps some of the sun’s heat in the atmosphere. Without atmospheric GHGs, the earth’s temperature would be approximately 60°F colder than at present and would not support life as we know it (USEPA 2009b). Since the Industrial Revolution (onset circa 1750), anthropogenic emissions of GHGs have increased, resulting in current concerns about the potential for global climate change.

GHGs include water vapor, CO₂, ozone, methane, nitrous oxide, and several classes of halogenated substances that contain fluorine, chlorine, or bromine (including chlorofluorocarbons). After water vapor, CO₂ is the most abundant GHG but, unlike water vapor, CO₂ remains in the atmosphere for long periods of time and tends to mix quickly and evenly throughout the lower levels of the global atmosphere. There are also several gases that do not have a direct global warming effect, but indirectly affect terrestrial or

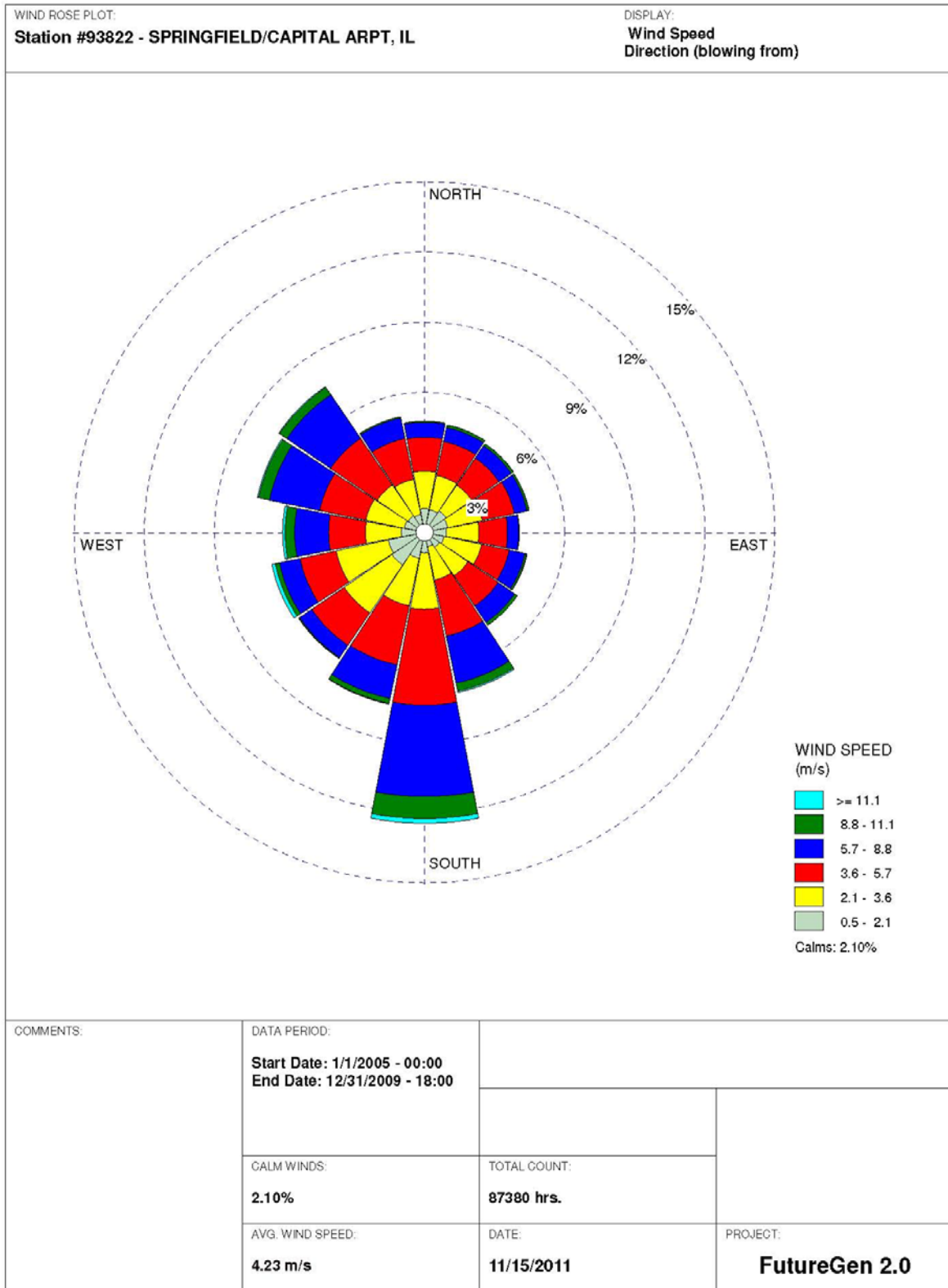

WRPLOT View - Lakes Environmental Software

m/s = meters per second; % = percent

Figure 3.2-1. Wind Rose for Region, Springfield, Illinois Airport

solar radiation absorption by influencing the destruction or formation of GHGs like ozone. These gases include carbon monoxide, nitrogen oxides, and non-methane volatile organic compounds (VOCs). Extremely small particles, such as sulfur dioxide or elemental carbon emissions, can also affect the absorptive characteristics of the atmosphere and therefore influence the greenhouse effect.

Although several GHGs occur naturally in the atmosphere, human activities from all sectors of the economy also release these gases into the atmosphere. Notably, industrial and agricultural activities release GHGs including CO₂, methane, nitrous oxide, ozone, and chlorofluorocarbons to the atmosphere, where they can remain for long periods of time. Since GHG impacts are often assessed on a global (international) scale, GHGs are typically measured in metric units, specifically, metric tons. GHGs are often reported as CO₂-eq, which is a measurement that puts all GHGs in terms relative to CO₂ (the predominant GHG), based on their global warming potential. For a given mixture of GHGs, the CO₂-eq is the amount of CO₂ that would have the same global warming effect as the mixture of GHGs. Global warming potential is a measure of how much a given mass of a GHG is estimated to contribute to global warming in comparison to an equivalent mass of CO₂. To calculate CO₂-eq quantities, the mass of each GHG is multiplied by its global warming potential and summed (IPCC 2007). A list of global warming potential values can be found at 40 CFR 98 (Subpart A, Table A-1).

CO₂-equivalent is a measure used to compare GHGs based on their global warming potential, using the functionally equivalent amount or concentration of CO₂ as the reference. The CO₂-equivalent for a gas is derived by multiplying the amount of the gas by its global warming potential; this potential is a function of the gas's ability to absorb infrared radiation and its persistence in the atmosphere after it is released.

In the pre-industrial era (before 1750 AD), the concentration of CO₂ in the atmosphere appears to have been approximately 280 parts per million (IPCC 2007). Data indicates that from the 1700s to the present day, global atmospheric concentrations of CO₂ have risen approximately 36 percent (USEPA 2009b). In 1958, C.D. Keeling and others began measuring the concentration of atmospheric CO₂ at Mauna Loa in Hawaii. Measurements by Keeling's team and others document that the amount of CO₂ in the atmosphere has been steadily increasing from approximately 316 parts per million in 1959 to 391.76 parts per million in February 2011 (NOAA 2011).

The average annual CO₂ concentration growth rate during the last decade as measured at Mauna Loa (2001–2010 average: 2.04 parts per million per year) has been significantly higher than the average CO₂ growth rate during the previous decade (1991–2000 average: 1.55 parts per million per year) or the last 50 years (1961–2010 average: 1.47 parts per million per year) (NOAA 2011). Much of the increase in global concentrations of CO₂ can be attributed to GHG emissions resulting from human activities such as the use of fossil fuels and changes in land use. Figure 3.2-2 depicts the changes in global CO₂ concentrations and CO₂ emissions from fossil fuel use over the past 250 years.

Current Emissions

Global anthropogenic emissions of CO₂ (and other GHGs) have been rising since the 1800s, but the rate of emissions has increased sharply since the middle of the 20th century. Much of this rise in emissions is due to the use of fossil fuels in electricity generation, transportation, and industry. In 2004, emissions of CO₂ from fossil fuel combustion (30,000 million tons; 27,264 million metric tons) accounted for approximately 57 percent of global anthropogenic GHG emissions from all sources; by 2008, annual CO₂ emissions from the combustion of fossil fuels equaled 34,000 million tons (30,421 million metric tons), an increase of approximately 12 percent (Boden et al. 2012; IPCC 2007). CO₂ is also released as a result of deforestation and other changes in land use. Other important GHGs include:

- Methane, released from waste management and agricultural activities; and
- Nitrous oxide, released from agricultural soil and animal manure management, sewage treatment, combustion of fossil fuels, and industrial activities.

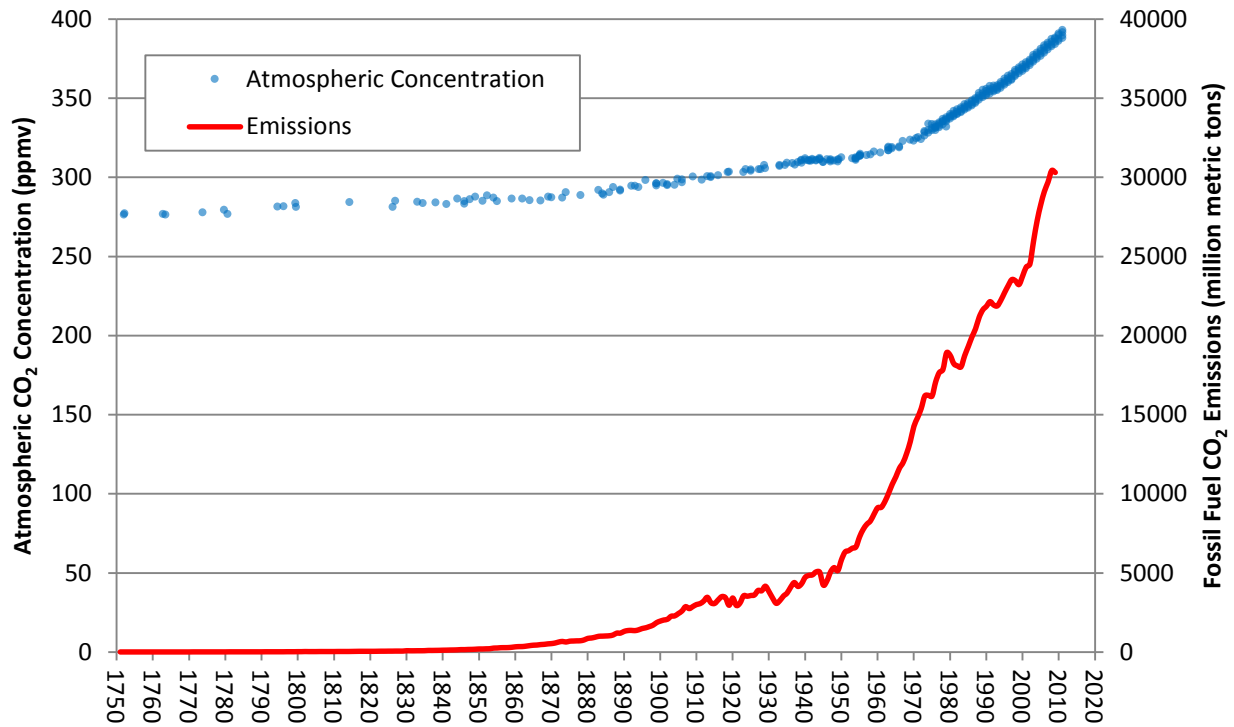

Sources: Developed from Boden et al. 2012; Etheridge et al. 1996, 2006; NOAA 2012.
 CO₂ = carbon dioxide; ppmv = parts per million by volume

Figure 3.2-2. Historical Trends in Global Atmospheric CO₂ Concentrations and Emissions

Figure 3.2-3 shows the contribution to global emissions by different economic sectors and by type of GHGs.

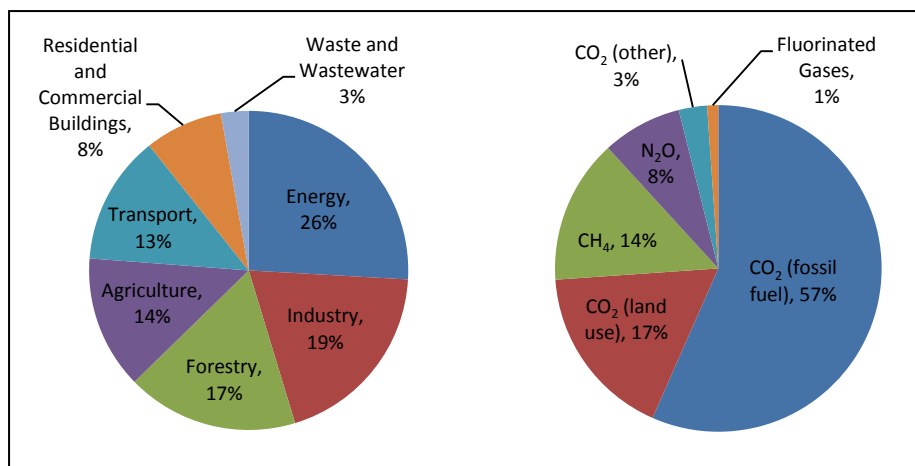

Source: IPCC 2007

Note: All ratios are expressed in terms of CO₂-eq.

CO₂ = carbon dioxide; CO₂-eq = CO₂ equivalents; CH₄ = methane; N₂O = nitrous oxide; % = percent

Figure 3.2-3. Economic Sectors and Greenhouse Gases Contributing to Global Anthropogenic Emissions

Within the United States, overall anthropogenic GHG emissions in 2010 totaled approximately 7,504 million tons CO₂-eq (6,822 million metric tons CO₂-eq), of which approximately 79 percent was composed of CO₂ (USEPA 2012d). There was a 3.2 percent increase in anthropogenic GHG emissions from 2009 (7,234 million tons CO₂-eq; 6,576 million metric tons CO₂-eq) to 2010. Table 3.2-5 shows that as of 2010, CO₂ emissions from United States electricity generation had increased by 24 percent since 1990, while total GHG emissions (from all reported sources) grew by 10.5 percent over the same period. In 2010, electric power generation contributed 40 percent of all CO₂ emissions in the United States (and 33 percent of all GHG emissions), of which 81 percent was attributable to the use of coal.

Table 3.2-5. United States CO₂ Emissions from Electric Power Sector Energy Consumption

Fuel	CO ₂ Emissions, million tons (million metric tons)						
	1990	2005	2006	2007	2008	2009	2010
Coal	1,703 (1,548)	2,182 (1,984)	2,149 (1,954)	2,186 (1,987)	2,155 (1,959)	1,915 (1,741)	2,010 (1,827)
Natural Gas	193 (175)	351 (319)	372 (338)	408 (371)	398 (362)	409 (372)	439 (399)
Petroleum	108 (98)	109 (99)	59 (54)	59 (54)	43 (39)	36 (33)	34 (31)
Municipal Solid Waste ^a	9 (8)	13 (12)	13 (12)	14 (13)	13 (12)	13 (12)	13 (12)
Geothermal	<1 (<1)	<1 (<1)	<1 (<1)	<1 (<1)	<1 (<1)	<1 (<1)	<1 (<1)
Limestone and Dolomite Use ^b	3 (3)	3 (3)	4 (4)	4 (4)	3 (3)	3 (4)	6 (5)
Total CO ₂ from Electric Power Sector	2,014 (1,831)	2,660 (2,418)	2,599 (2,363)	2,672 (2,429)	2,614 (2,376)	2,378 (2,162)	2,503 (2,275)
Total CO₂ Emissions from All Energy-Related Sectors^c	5,394 (4,904)	6,526 (5,933)	6,424 (5,840)	6,531 (5,937)	6,331 (5,755)	5,908 (5,371)	6,114 (5,558)

Source: USEPA 2012d

^a Emissions from non-biogenic sources, including fuels derived from recycled tires.

^b From pollution control equipment installed at electricity generation facilities.

^c Includes residential, commercial, industrial, and transportation end-use sectors.

Note: Totals may not equal sum of components due to independent rounding.

CO₂ = carbon dioxide

Figure 3.2-4 shows long-term projections in United States CO₂ emissions (in million metric tons CO₂-eq) by sector and source for the year 2030 compared to current rates, after considering higher but uncertain world oil prices, growing concern about GHG emissions, increasing use of renewable fuels, increasing shift to use of more efficient vehicles, improved end-use appliance efficiency, and general trends in production and usage of various fuel types (EIA 2009). Over the next two decades, the largest share of United States CO₂ emissions will continue to come from electricity generation, followed closely by transportation. However, while electricity generation is projected to increase by 0.9 percent per year, CO₂ emissions from electricity generation would increase by only 0.5 percent per year. This projected slower rate of increase in emissions is in part due to an expected increase in renewable energy sources from 8 percent in 2007 to 14 percent in 2030, as well as efficiency improvements in technologies that emit less CO₂ and the commercial availability of CO₂ mitigation techniques. More rapid improvements in technologies, mitigation techniques, and more rapid adoption of voluntary and mandatory CO₂ emissions reduction programs could result in even lower CO₂ emissions levels than those projected (EIA 2009).

Within the state of Illinois, GHG emissions from all sources equaled 317 million tons CO₂-eq (288 million metric tons CO₂-eq) in 2007, or approximately 4.3 percent of total U.S GHG emissions in that year (WRI 2012). Emissions of CO₂ from all energy-related activities in Illinois totaled 267 million tons CO₂-eq (243 million metric tons CO₂-eq), with 104 million tons CO₂-eq (95 million metric tons CO₂-eq) resulting from electric power generation. Total GHG emissions for the state of Illinois are

projected to increase to approximately 358 million tons CO₂-eq (325 million metric tons CO₂-eq) by 2020. Note that these are conservative projections, based only on increases in energy-related GHG emissions, and assume that emissions from industrial activity, agriculture, and waste management will remain constant at 2003 levels (WRI 2007).

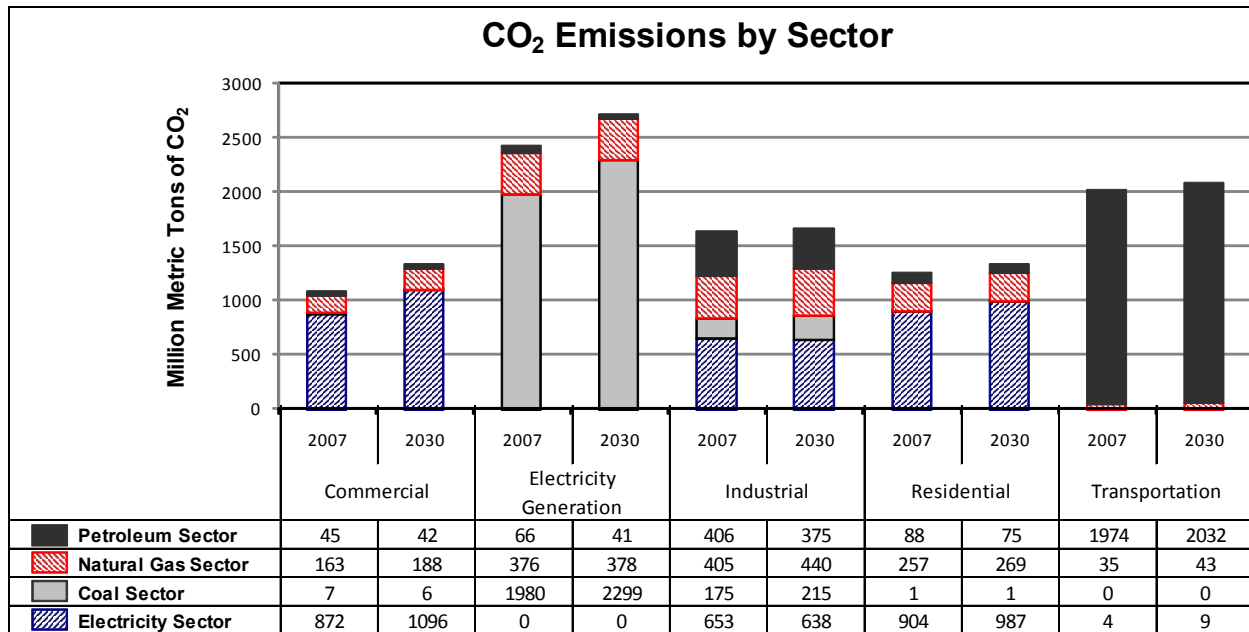

Source: Developed from 2007 and projected 2030 data presented in EIA 2009 (Report No. DOE/EIA-0383 [2009])

Figure 3.2-4. United States CO₂ Emissions by Sector

3.2.3 Impacts of Proposed Action

3.2.3.1 Construction Impacts

Meredosia Energy Center, CO₂ Pipeline, CO₂ Storage Study Area, and Educational Facilities

Construction of the project would generate GHG emissions from the use of construction equipment, delivery trucks, and construction worker vehicles. DOE calculated GHG emissions using the NONROAD and the MOVES models described in Section 3.1, Air Quality, based on estimates of the types and numbers of construction equipment and vehicles needed for construction of the project and the duration of their use. Table 3.2-6 presents the estimated GHG emissions that would be generated by the construction of the oxy-combustion facility at the Meredosia Energy Center, the CO₂ pipeline, the injection well site(s), and the educational facilities. The total calculated emissions are based on the preliminary project design and conservative assumptions regarding activity levels and duration and are expected to be overestimates of actual emissions. **Note that these values have been updated since publication of the Draft EIS to reflect the most current injection well design, which resulted in slightly increased emissions. DOE has revisited the impact analysis presented in the Draft EIS and concluded that the impacts remain consistent with those reported in the Draft EIS.**

DOE estimates that GHG emissions from construction of the project would equal approximately **48,009** tons CO₂-eq (**43,688** metric tons CO₂-eq). Over the three-year construction period for the project (assumed to be mid-2014 through mid-2017 for this analysis), GHG emissions for the state of Illinois are projected to be approximately 1,024 million tons CO₂-eq (931 million metric tons CO₂-eq) (WRI 2007). Construction-related impacts resulting from tailpipe emissions of GHGs would be minimized by the use of appropriate BMPs, such as maintaining engines according to manufacturers' specifications, minimizing idling of equipment while not in use, and using electricity from the grid if available to reduce the use of diesel or gasoline generators for operating construction equipment.

Table 3.2-6. Estimated Greenhouse Gas Emissions from Construction Activities

Project Area	tons CO ₂ -eq (metric tons CO ₂ -eq)		
	Direct Emissions ^a	Indirect Emissions ^b	Total Emissions
Meredosia Energy Center	13,435 (12,225)	5,696 (5,183)	19,131 (17,409)
CO ₂ Pipeline	4,315 (3,926)	2,984 (2,715)	7,299 (6,642)
Injection Well Site(s)	17,845 (16,239)	2,893 (2,633)	20,738 (18,871)
Educational Facilities	194 (176)	648 (590)	842 (766)
Total	35,788 (32,567)	12,221 (11,121)	48,009 (43,688)

^a Direct emissions of methane (CH₄), nitrous oxide (N₂O), and other greenhouse gases would be negligible and are not included in these estimates.

^b Vehicle tailpipe emissions from worker, materials, and waste transport. Calculated using MOVES 2010b; results include methane (CH₄) and nitrous oxide (N₂O) emissions.

CO₂ = carbon dioxide; CO₂-eq = carbon dioxide equivalent; MOVES = Motor Vehicle Emission Simulator

3.2.3.2 Operational Impacts

Meredosia Energy Center, CO₂ Pipeline, CO₂ Storage Study Area, and Educational Facilities

The FutureGen 2.0 Project comprises two major components—the operation of a 168 MWe steam turbine generator at the Meredosia Energy Center with oxy-combustion and carbon capture technologies, and the subsequent transport of the captured CO₂ from the energy center via pipeline to the CO₂ injection well site(s) where it would be injected and stored in a deep geologic formation. At the energy center, operation of the proposed plant would generate direct GHG emissions from the oxy-combustion boiler and the compression and purification unit, the auxiliary boiler, and the diesel emergency generator, as well as indirect emissions of GHGs as a result of transportation-related exhaust from employee vehicles and truck transport of materials and wastes. At the injection well site(s), operations would generate direct GHG emissions from operation of the diesel emergency generator (which is expected to be infrequent), and indirect GHG emissions from transportation-related exhaust.

GHG emissions estimates have been updated to reflect project design changes that have occurred since publication of the Draft EIS. The FutureGen 2.0 Project would be designed to capture 90 percent of the CO₂ generated during steady-state operation, or approximately 1.2 million tons (1.1 million metric tons) of CO₂ annually. However, in order to accurately describe impacts from GHG emissions, DOE considered a range of operational scenarios with steady-state CO₂ capture efficiency varying from 90 to 98 percent. Accordingly, this section presents a range of GHG emissions estimates. While these changes resulted in slightly increased upper bounds for GHG emissions, DOE has revisited the impact analysis presented in the Draft EIS and concluded that the impacts remain consistent with those reported in the Draft EIS. Annual GHG emissions would be **up to approximately 157,144 tons CO₂-eq (142,858 metric tons CO₂-eq)** from the oxy-combustion boiler alone; after taking all project components into account, annual emissions would be **up to 169,701 tons CO₂-eq (154,283 metric tons CO₂-eq)**. Operational impacts resulting from tailpipe emissions of GHGs would be minimized by the use of appropriate BMPs such as maintaining engines according to manufacturers' specifications, minimizing idling of equipment while not in use.

Table 3.2-7 presents the direct and indirect GHG emissions generated by the proposed project. Table 3.2-8 presents the estimated emissions of individual GHGs from project operations, and illustrates the calculation of CO₂-eq emissions using global warming potentials. As discussed under Section 3.2.2.2,

CO₂-eq quantities are derived by multiplying each GHG's emissions by its global warming potential. These CO₂-eq quantities can then be summed to obtain total CO₂-eq emissions.

Table 3.2-7. Estimated Greenhouse Gas Emissions from Operations of Proposed Project

Project Area	Emissions Source	Emissions, CO ₂ -eq tpy (mtpy)
Direct Emissions		
Meredosia Energy Center ^a	Oxy-combustion boiler stack, net	58,887–157,144 (53,533–142,858)
	GHG emissions from oxy-combustion boiler	1,263,167 (1,148,333)
	Amount captured by CPU ^b	[1,106,023–1,204,280] ([1,005,475–1,094,800])
	Auxiliary boiler	1,860 (1,691)
	Diesel emergency generator	132 (120)
Injection Well Site(s)	Diesel emergency generator	10 (9)
Total Direct Emissions		60,883–159,209 (55,348–144,735)
Indirect Emissions^c		
Meredosia Energy Center	Materials, waste, and employee transport	10,338 (9,407)
CO ₂ Pipeline	Pipeline maintenance vehicles	1 (1)
Injection Well Site(s)	Well maintenance vehicles and employee transport	84 (76)
Educational Facilities	Materials, waste, and employee transport	70 (64)
Total Indirect Emissions		10,492 (9,548)
Total		71,375–169,701 (64,896–154,283)

^a The data in this table reflect oxy-combustion boiler design with a generating capacity of 168 MWe using 60 percent Illinois coal and 40 percent Power River Basin coal. The calculations assume the following hours of operation per year: **7,446 hours for the oxy-combustion boiler in GHG capture mode, 240 hours for the oxy-combustion boiler in air-firing mode, and 280 hours for the oxy-combustion boiler in transition mode**, 240 hours for the fuel-oil fired auxiliary boiler (typically during startup); and 100 hours for each of the diesel emergency generators (energy center and injection wells).

^b Assuming that **90 percent of flue gas CO₂** is captured by the CPU **during steady-state operation**; other GHGs (including methane and nitrous oxide) are vented through the oxy-combustion boiler stack.

^c Vehicle tailpipe emissions from worker, materials, and waste transport. Calculated using MOVES 2010b.

CO₂ = carbon dioxide; CO₂-eq = carbon dioxide equivalent; CPU = compression and purification unit; GHG = greenhouse gas; mtpy = metric tons per year; MWe = megawatt electrical; tpy = tons per year

Table 3.2-8. Estimated Upper-Bound Emissions of each Greenhouse Gas from Operations of the Proposed Project

GHG	Emissions tpy (mtpy)	Global Warming Potential ^a	Emissions, CO ₂ -eq tpy (mtpy)
Carbon dioxide	159,776 (145,261)	1	159,776 (145,261)
Methane	148 (134)	21	3,105 (2,822) ^b
Nitrous oxide	22 (20)	310	6,820 (6,200) ^b
Total			169,701 (154,283)

^a Source: 40 CFR 98 Subpart A, Table A-1.

^b Totals reflect rounding in calculations.

CO₂-eq = carbon dioxide equivalent; GHG = greenhouse gas; mtpy = metric tons per year; tpy = tons per year

The project is expected to begin operations in 2017. In that year, GHG emissions for the state of Illinois are projected to be approximately 345 million tons CO₂-eq (315 million metric tons CO₂-eq) (WRI 2007).

By utilizing advanced oxy-combustion technology and capturing and storing CO₂, the project would reduce GHG emissions from the generation of 168 MWe (**gross**) of electricity by **approximately 90 percent** compared to a conventional coal-fueled plant, or by **approximately 70 percent** compared to a natural gas-fueled plant (see Table 3.2-9), and would thus have a beneficial impact on regional GHG emissions during operations. On a broader scale, successful implementation of the project may lead to widespread acceptance and deployment of oxy-combustion technology with geologic storage of CO₂, thus fostering a long-term reduction in the rate of CO₂ emissions from power plants across the United States.

Table 3.2-9. Comparison of Greenhouse Gas Emissions by Various Sources

Emissions Source	Emissions, CO ₂ -eq tpy (mtpy)
Proposed Project	71,375–169,701 (64,896–152,844)
Conventional Coal-fired Power Plant ^a	1,600,498 (1,454,998)
Natural Gas-fired Power Plant ^b	527,184 (479,258)

Source: 40 CFR 98 Subpart A, Table A-1.

^a. Fuel use quantities given in Table 2-4. Powder River Basin coal is sub-bituminous; Illinois No. 6 coal is bituminous.

^b. Estimated based on 8,000 hours of operation per year at 100 percent capacity and a heat rate of 6,719 Btu/kWh, assuming the power plant would utilize advanced natural gas combined cycle technology. Fuel use during startup or shutdown not included.

Btu/kWh = British thermal units per kilowatt hour; CO₂-eq = carbon dioxide equivalent; mtpy = metric tons per year; tpy = tons per year

During operation, the project would comply with all GHG-related federal and state rules. The FutureGen 2.0 Project would comply with all GHG-related requirements in the proposed plant’s CAA operating (Title V) permit. As an emitter of more than 27,500 tons (CO₂-eq) per year (25,000 metric tons CO₂-eq per year) of GHGs, the project would also be required to comply with the federal Mandatory Reporting Rule, and would submit annual GHG inventories to USEPA. Finally, Illinois’ Clean Coal Portfolio Standard Law requires that any new coal-fired power plants that begin operations in 2016-2017 capture and store 70 percent of their GHG emissions, and plants beginning operations after 2017 capture and store 90 percent of their emissions. **The FutureGen 2.0 Project is expected to begin operations in 2017 and would capture between 88 to 96 percent of its total GHG emissions (at least 90 percent during steady-state operation), and would therefore be in compliance with the Illinois law.**

On September 20, 2013, USEPA proposed a new rule that would require new coal-fired power plants with a capacity greater than 25 MWe to emit no more than 1,100 pounds CO₂/MWh gross within any 1-year operating period, or 1,000–1,050 pounds CO₂/MWh gross within any 7-year operating period (USEPA 2013a). The proposed oxy-combustion facility would emit up to approximately 295 pounds CO₂/MWh gross during normal operations, and would therefore meet USEPA’s requirement if it were to be finalized.

Current scientific methods do not enable an evaluation of the relationship of reductions or increases in GHG emissions from a specific source to a particular change in either local or global climate. Therefore, the potential contribution or removal of anthropogenic GHGs attributable to this project, and its impact on global climate change, is discussed within the context of cumulative impacts. Section 4.3, Potential Cumulative Impacts, presents a discussion of the potential cumulative impacts related to GHG emissions in this context. This project’s reduction in potential CO₂ emissions, compared to the emissions from a conventional coal- or natural gas-fueled power plant generating the same amount of electricity, would potentially generate beneficial impacts in terms of cumulative effects on climate change.

GHG Emissions Impact Summary in Relation to Historical Baseline Conditions at the Meredosia Energy Center

The PSD and Title V GHG Tailoring Rule requires an existing source that increases GHG emissions by more than 75,000 tons (CO₂-eq) per year (68,250 metric tons CO₂-eq per year) to comply with PSD permitting requirements. It also requires existing sources that emit more than 100,000 tons (CO₂-eq) per year (91,000 metric tons CO₂-eq per year) of GHGs to comply with Title V operating permit requirements. However, as discussed in Section 3.1, Air Quality, historical emissions levels may be taken into consideration when determining PSD applicability. In its air permit application with the state of Illinois, the Meredosia Energy Center would be taking credit for contemporaneous emissions decreases resulting from the shutdown of all boilers at the energy center that were historically operational prior to 2012. Overall, the net emissions of the Meredosia Energy Center would decrease in comparison to historical emissions rates.

Table 3.2-10 presents total projected GHG emissions from the energy center, the decrease in GHG emissions due to the 2011 suspension of operations at the energy center, and the net change in GHG emissions from pre-suspension historical conditions, as shown in the 2013 construction permit application submitted by the Alliance to IEPA (Ameren 2013). The project would not result in net emissions greater than the PSD significance threshold (per 40 CFR 52.21(b)(23)(i)) and, therefore, the project would not be subject to the PSD regulations. Note that these emissions calculations are based on conservative assumptions used in the construction permit application, as discussed in Section 3.1, Air Quality, and are not reflective of normal operating conditions. During normal operations, the project would generate significantly lower GHG emissions as shown in Table 3.2-7.

Table 3.2-10. Significant Net Greenhouse Gas Emissions from Energy Center Operations

	Emissions, CO ₂ -eq tpy (mtpy)
Proposed Project Emissions ^a	1,524,327 (1,387,138)
Decrease in Emissions due to Shutdown of Boilers 1-6 ^b	1,937,858 (1,763,451)
Net Emissions for Energy Center ^c	[413,532] ([376,314])
PSD Significance Increase Threshold ^d	75,000 (68,250)
Is PSD Permit Required? ^e	No

Source: Ameren 2013

^a Project emissions presented in this table are based on conservative assumptions used in the construction permit application; they only include stationary source emissions; and they do not account for CO₂ capture by the CPU.

^b These values reflect the contemporaneous decrease in emissions due to cessation of operations of Boilers 1–6, as presented and discussed in Section 3.3.1 of the construction air permit application (Ameren 2013). GHG emissions were calculated using USEPA emissions factor data (AP-42 and 40 CFR 98 Table C-2).

^c Project emissions minus contemporaneous emissions decreases.

^d Significance threshold for PSD regulations per 40 CFR 52.21(a)(2)(iv)(b).

^e A PSD permit is required if net emissions exceed the threshold limits.

CO₂-eq = carbon dioxide equivalent; GHG = Greenhouse Gas; mtpy = metric tons per year; PSD = Prevention of Significant Deterioration; tpy = tons per year

3.2.4 Impacts of the No Action Alternative

Under the no action alternative, DOE would not provide cost-shared funding for the FutureGen 2.0 Project. Although the Alliance may still elect to construct and operate the project in the absence of DOE cost-shared funding, for the purposes of the analysis in this EIS, DOE assumed that the no action alternative is equivalent to a no-build alternative. Therefore, the project would not be constructed and there would be no demonstration of technologies that could change GHG emissions.

Under the no action alternative, equivalent electrical generation by a conventional coal-fueled or natural gas-fired power plant in the absence of the proposed project could result in higher emissions of GHGs

with an associated greater contribution to global climate change (see Table 3.2-9). Furthermore, the potential future benefits to GHG emissions reduction that may be achieved nationally and internationally through the retrofit of existing coal-fueled power plants using oxy-combustion technology plus CO₂ capture and geologic storage might not be realized without successful commercial demonstration of these technologies.

3.3 PHYSIOGRAPHY AND SOILS

3.3.1 Introduction

This section describes the physiography (i.e., the earth's surface and exterior physical features) and soils that could be directly or indirectly affected by the construction and operation of the FutureGen 2.0 Project. This section also analyzes the potential effects of this project on these resources.

3.3.1.1 Region of Influence

The ROI for physiography and soils includes the areas potentially affected by the construction and operation of the FutureGen 2.0 Project, which consists of the oxy-combustion facility at the Meredosia Energy Center, the CO₂ pipeline, the injection wells, and the educational facilities. The ROI defines the extent of the areas where direct effects from construction and operation may be experienced, and encompasses the areas where indirect effects from the proposed project would most likely occur.

3.3.1.2 Method of Analysis and Factors Considered

DOE evaluated the potential effects of the construction and operation of the proposed project on soils within the ROI, primarily focused on their ability to support agriculture and their potential for erosion hazards. DOE used several data sources to support this analysis, including U.S. Geological Survey (USGS) topographic maps, U.S. Department of Agriculture (USDA) Natural Resources Conservation Service (NRCS) soil surveys, and consultation with the IDOA. DOE analyzed the potential impacts to physiography and soils by overlaying the areas of proposed construction on soil survey maps. DOE calculated quantitative estimates of the potential for loss of soil resources using geographic information systems (GIS) and existing land cover data. DOE made qualitative assessments for the potential effects on physiography and soils based on properties of soils that could be impacted and the expected attributes of the project.

DOE assessed the potential for impacts based on whether the proposed project components would:

- Result in permanent or temporary soil removal;
- Cause the permanent loss of prime farmland soil or farmland of statewide importance (through conversion to nonagricultural uses);
- Result in significant soil erosion;
- Cause soil contamination due to spills of hazardous materials; or
- Change soil characteristics and composition.

3.3.1.3 Regulatory Framework

The Federal Farmland Protection Policy Act (Public Law 97-98; 7 USC 4201 *et seq.*) seeks to minimize the extent to which federal programs contribute to the unnecessary and irreversible conversion of farmland soils (prime farmland) to nonagricultural uses. The supply of high quality farmlands is limited; therefore, the USDA encourages the preservation of soils classified as “prime farmland,” “prime farmland if drained,” or “farmland of statewide importance.” The definition of prime farmland, as per NRCS Handbook, part 622.04 (USDA 2011), is included below.

Prime farmland is land that has the best combination of physical and chemical characteristics for producing food, feed, forage, fiber, and oilseed crops and that is available for these uses. It has the combination of soil properties, growing season, and moisture supply needed to produce sustained high yields of crops in an economic manner if it is treated and managed according to acceptable farming methods. In general, prime farmland has an adequate and dependable water supply from precipitation or irrigation, a favorable temperature and growing season, an acceptable level of acidity or alkalinity, an

acceptable content of salt or sodium, and few or no rocks. Its soils are permeable to water and air. Prime farmland is not excessively eroded or saturated with water for long periods of time, and it either does not flood frequently during the growing season or is protected from flooding.

Most of the native soils in Illinois are considered prime farmland. Prime farmland soils in Illinois are identified in NRCS soil surveys by soil association. The IDOA is tasked with reviewing all federal and state projects for their potential impact to prime farmland by considering project data, soil surveys, and land use by completing Form AD-1006, the Farmland Conversion Impact Rating.

Soil erosion prevention and control, particularly during construction activities, associated with stormwater discharges are regulated by the IEPA under Sections 401 and 402 of the Clean Water Act (CWA) (permitting requirements) through the NPDES permit program (see Chapter 5, Regulatory and Permit Requirements). The state's NPDES program is modeled on the federal NPDES program, which requires soil erosion control measures during construction. The CWA also regulates the handling and storage of petroleum products, which could contaminate soils from an unintended release.

3.3.2 Affected Environment

3.3.2.1 Physiography

The project study area is located within the Lower Illinois River Basin. The majority of the basin is extremely flat with less than 20 feet of relief, although the Illinois River dissects the flat topography of the basin in central Illinois. The area of greatest topographic relief occurs along the Illinois River valley, where elevations can vary by as much as 200 to 400 feet (USGS 2000a). Lands within the basin range from 600 to 800 feet above sea level.

The Lower Illinois River Basin is located within the Central Lowland physiographic province (USGS 2011a). The Central Lowland province is characterized by low relief and gently rolling hills. The major landforms for the province are glacial in origin. Much of this lowland is a glacial till plain that is presently covered by loess (wind-driven), lacustrine (lake-related), and alluvial (river-related) deposits.

More specifically, 99.5 percent of the basin is in the Till Plains Section of the Central Lowland physiographic province (see Figure 3.3-1). The Till Plains Section is further divided into four subsections: the Bloomington Ridged Plain (38 percent), the Galesburg Plain (26 percent), the Springfield Plain (35 percent), and the Kankakee Plain (1 percent) (USGS 2000b). The FutureGen 2.0 Project lies entirely within the Springfield Plain subsection. The Springfield Plain is covered by glacial drift deposits from the Illinoian stage and is mostly flat, with very localized variations in topography. Section 3.4, Geology, discusses the sequence of glacial deposition in the Lower Illinois River Basin.

3.3.2.2 Soils

The evaluation of soils potentially impacted by the proposed project is based on the mapped NRCS soil units. A mapped soil unit is a collection of areas defined and named the same in terms of their soil components. The NRCS uses the chemical and physical characteristics of the soil to organize similar soils into groups. Soil map units are defined by a series of properties that are important to soil use, such as surface texture and slope, and are typically used in displaying localized changes. Each map unit differs in some respect from all others in a survey area and is uniquely identified on a soil map. Soil map units made up of two or more major soil types in a complex pattern or in a very small area (where each soil type cannot be identified separately) are considered soil complexes.

The soils in the Lower Illinois River Basin formed mostly in thick loess. Loess consists of fine-grained material, typically silt-sized particles, deposited by wind. Loess represents one of the dominant mechanisms for soil formation across the region. Historically, some loess deposits have been observed in thicknesses greater than 60 inches (USGS 2011a).

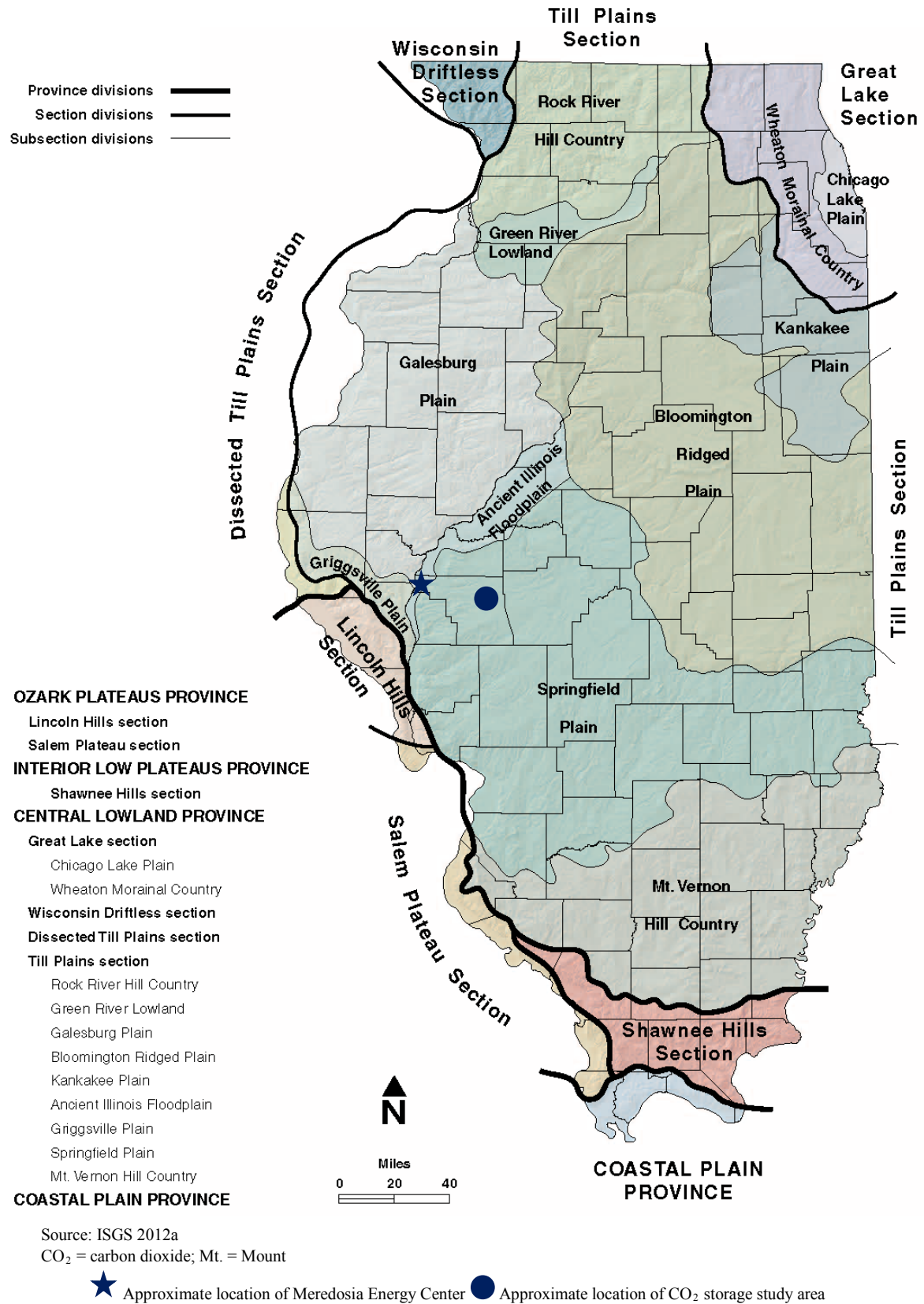

Figure 3.3-1. Physiographic Divisions of Illinois

Soils formed in sandy to clayey alluvial sediments are found near major streams. Several soil properties are relevant to characterizing the environment or determining the potential for adverse effects to soils:

- **Soil erodibility** is a characteristic based on the potential for soil detachment by runoff and raindrop impact. Sedimentation in lakes and the Illinois River is one of the most important water-quality problems in the Lower Illinois River Basin (USGS 2011a) (see Section 3.6, Surface Water). Soil erosion also reduces the amount of vertical buffer soil between pipelines and deep tillage implements (see **Appendix H, Agricultural Mitigation**). The basin is particularly susceptible to erosion and sedimentation for three reasons: (1) the soils' parent materials (loess) tend to erode easily; (2) under conventional tillage practices for corn and soybeans, bare earth is present for the majority of the year; and (3) Illinois experiences higher rainfall during the spring, a period which tends to have lower vegetative cover on cropland (USGS 2011a). The NRCS soil erosion factor for water is based on physical tests and calculations of the grain size, amount of organic material, structure classes, and permeability of the soil (Römken et al. 1996). Each of these factors contributes to a soil being more susceptible to erosion when disturbed.

The NRCS soil survey designates the hazard associated with soil erosion for each map unit, when disturbed, as either slight (low), moderate, or severe, as described below (Soil Survey Division Staff 1993):

- Slight. Presents, at most, minor problems associated with erosion. The soil gives satisfactory performance with little or no modification required. Modifications or operations dictated by the use are simple and relatively inexpensive. With normal maintenance, performance should be satisfactory for a period of time generally considered acceptable with respect to erosion.
 - Moderate. Does not require exceptional risk or cost associated with erosion, but the soil does have certain undesirable properties or features. Some modification of the soil itself, special design, or maintenance is required for satisfactory performance over an acceptable period of time. The needed measures usually increase the cost of establishing or maintaining the use, but the added cost is generally not prohibitive.
 - Severe. Requires unacceptable risk to use the soil if not appreciably modified. Special design, a significant increase in construction cost, or an appreciably higher maintenance cost is required for satisfactory performance over an acceptable period of time. A limitation that requires removal and replacement of the soil would be rated severe. The rating does not imply that the soil cannot be adapted to a particular use, but rather that the cost of overcoming the limitation would be high.
- **Slope gradient** influences the retention and movement of water, the potential for increased soil erosion, the amount and ease of construction machinery movement, and engineering uses of the soil (USDA 2012). Construction on larger or steeper slopes may require additional cut and fill, and steeper slopes can increase the potential for soil erosion. Typically, soils with the steepest gradient are rated as severe erosion hazard but are usually well drained.
 - **Prime farmland or farmland of statewide importance** is a NRCS designation of a soil series based on the characteristics described in Section 3.3.1.3. Prime farmland soils may occur in a variety of parent materials, geomorphic locations, and climates. Most of the native soils in Illinois are considered prime farmland. Soils that contain water near or at the surface may also be considered “prime farmland, if drained.” Drain tiles and man-made ditches are often used by farmers to drain the excess water in these soils. Some soils that are not considered prime farmland, but may have properties that are recognized by the state as highly productive, are classified as “farmland of statewide importance.”

The presence of hydric soils within the ROI was also examined. Hydric is a USDA/NRCS classification that is primarily based on the wetness of the soil, which can produce anaerobic conditions in the upper layers (USDA 2011). Not all poorly drained soils are considered hydric, as other factors, such as the depth and duration of the water table, and iron oxidation in the soil column are also taken into consideration. Hydric soils are used, in addition to vegetation types present and other attributes, to delineate wetlands. Impacts to hydric soils, specifically those located in state- or federally-regulated wetlands, were not analyzed within this section. Refer to Section 3.7, Wetlands and Floodplains, for a discussion of wetlands and impacts to wetlands within the ROI.

Tables 3.3-1 through 3.3-3 identify the soil map units coincident with the project components. The tables include the soil map unit code, texture, the potential for erosion, drainage class, range of slopes, and the farmland status for each of the soil types. Most of the soils are considered prime farmland, although some retain enough water to require draining to support crops. **Since the Draft EIS was published, the USDA/NRCS has issued updated soils data for Illinois. The new data include revised soil descriptions, soil unit symbols, drainage classes, and/or slope percentages. These new data have been incorporated into the Final EIS. Although many of the soil names remain the same or are very similar, some have changed more significantly while others may have been eliminated altogether. Therefore, it is possible that some soil data may have changed when compared to the Draft EIS even though no changes have occurred to a particular project design component. None of the changes, however, has significantly altered the project impacts, conclusions, or recommendations with respect to physiography and soils.**

The entire project is located within Morgan County, Illinois. Agricultural land use has increased in Morgan County during the last decade. In 1997, Morgan County contained a total area of 305,585 acres of farmland, representing approximately 83 percent of the county land area (USDA 1999). In 2007, Morgan County had increased the total farmland to 320,512 acres, with an average farm size of 433 acres (USDA 2009). The primary crops in Morgan County are corn, soybeans, and wheat.

3.3.2.3 Meredosia Energy Center

The area around the existing Meredosia Energy Center is relatively flat, with an average elevation of approximately 446 feet above sea level. Natural and man-made variations in the topography cause an average relief of up to 6 feet. The elevation at the proposed location for the oxy-combustion facility is approximately 450 feet above sea level, which is the highest elevation onsite and where all of the existing structures associated with the Meredosia Energy Center are located.

As discussed in Section 3.3.2.1, the Meredosia Energy Center is located within the Lower Illinois River Basin. The Meredosia Energy Center is located in an area with high soil permeability. Therefore, the aquifer is vulnerable to contamination (Berg et al. 1984) (see Section 3.5, Groundwater).

Most of the soils in the Meredosia area have characteristics that are well suited for agriculture and farmland use. On the Meredosia Energy Center property, the soil survey of Morgan and Scott counties identified soils with beneficial agricultural production properties (Soil Survey Staff 2011a).

The Meredosia Energy Center property encompasses approximately 263 acres. The majority of the soils at the Meredosia Energy Center are identified as Plainfield soils, which are characterized as farmland soils of statewide importance. Urban soils are also located on portions of the energy center property. Urban soils are formed from previously disturbed soil series and typically are covered by impervious structures and pavement; in this case, by the existing Meredosia Energy Center facilities. Since the last soil survey review at the Meredosia Energy Center, additional structures and facilities have been built (e.g., coal piles, detention basins, roads), which have disturbed the Plainfield soils and modified the positive soil characteristics for farmland. In addition, the soils onsite have not been farmed in at least several decades, and the majority of land surrounding the energy center has been developed for industrial use, both of which are factors which decrease the overall farmland value of the soils at the Meredosia Energy Center.

Since the publication of the Draft EIS, changes in project design have occurred. As described in the Draft EIS, the Alliance originally anticipated the need to disturb 164 acres of the property for construction of the proposed oxy-combustion facility (see Figure 2-14). Through ongoing refinements in site plans in response to the aforementioned comments, the Alliance reduced the anticipated area of disturbance to 114 acres as described in this Final EIS (see Figure 2-15).

Table 3.3-1 identifies and describes the soil map units present within the proposed construction footprint at the Meredosia Energy Center as addressed in the Draft EIS; these same soil types are also included in the revised construction footprint currently proposed by the Alliance. Similarly, Figure 3.3-2 depicts the extent of the construction footprint with respect to onsite soil types based on the design presented in the Draft EIS. Since the design presented in the Draft EIS results in larger impact areas, that design is analyzed herein to represent the conservative upper limit of potential soil impacts.

The soil types present onsite have a slight or moderate potential for erosion. Slopes at the site range from nearly flat to 15 percent. Plainfield soils, the predominant onsite soil type, form in sandy drift and are typically found on outwash plains, glacial lake basins, stream terraces, moraines, and other upland places. Plainfield soils are further identified as being excessively drained, having rapid to very rapid permeability, and having a negligible to medium potential for surface runoff (National Cooperative Soil Survey 2006). Although the Plainfield sand is described as excessively drained, it contains a component that may be identified as hydric (i.e., those soils typically found in wetlands) when found along depressions and stream terraces. Although the FutureGen 2.0 Project as currently proposed would not affect these areas, there are two small areas of jurisdictional wetlands onsite, which are discussed in Section 3.7, Wetlands and Floodplains.

As stated earlier, a majority of the mapped soil types at the Meredosia Energy Center are generally classified as farmland of statewide importance and account for up to 86 percent of the project area. However, the Meredosia Energy Center property has been extensively developed for decades and some of the underlying surface soils have been significantly disturbed. The site is currently used solely for industrial purposes and does not contain any agricultural production. Therefore, although the soil types onsite are associated with farmlands of statewide importance, today these soils would likely not meet the necessary criteria to support this classification.

Table 3.3-1. Soil Map Units Found at the Meredosia Energy Center

Map Unit Symbol	Map Unit Name	Erosion Hazard	Drainage Class	Prime Farmland	Farmland of Statewide Importance	Slope (percent)
1070L	Beaucoup silty clay loam	Slight	Very poorly drained	No	No	0-2
54B	Plainfield sand	Slight	Excessively drained	No	Yes ^a	1-7
54D	Plainfield sand	Moderate	Excessively drained	No	Yes ^a	7-15
533	Urban land	Not rated	Not applicable	No	No	0

Sources: USDA/NRCS 2012; Soil Survey Staff 2011a; Soil Survey Staff 2011b

^a The Meredosia Energy Center site is an industrial site, and many of the underlying soils have been disturbed since the soil survey was initially performed. Therefore, although soil types on the property can be categorized as farmland of statewide importance, today these soils would likely not meet the necessary criteria to support this classification.

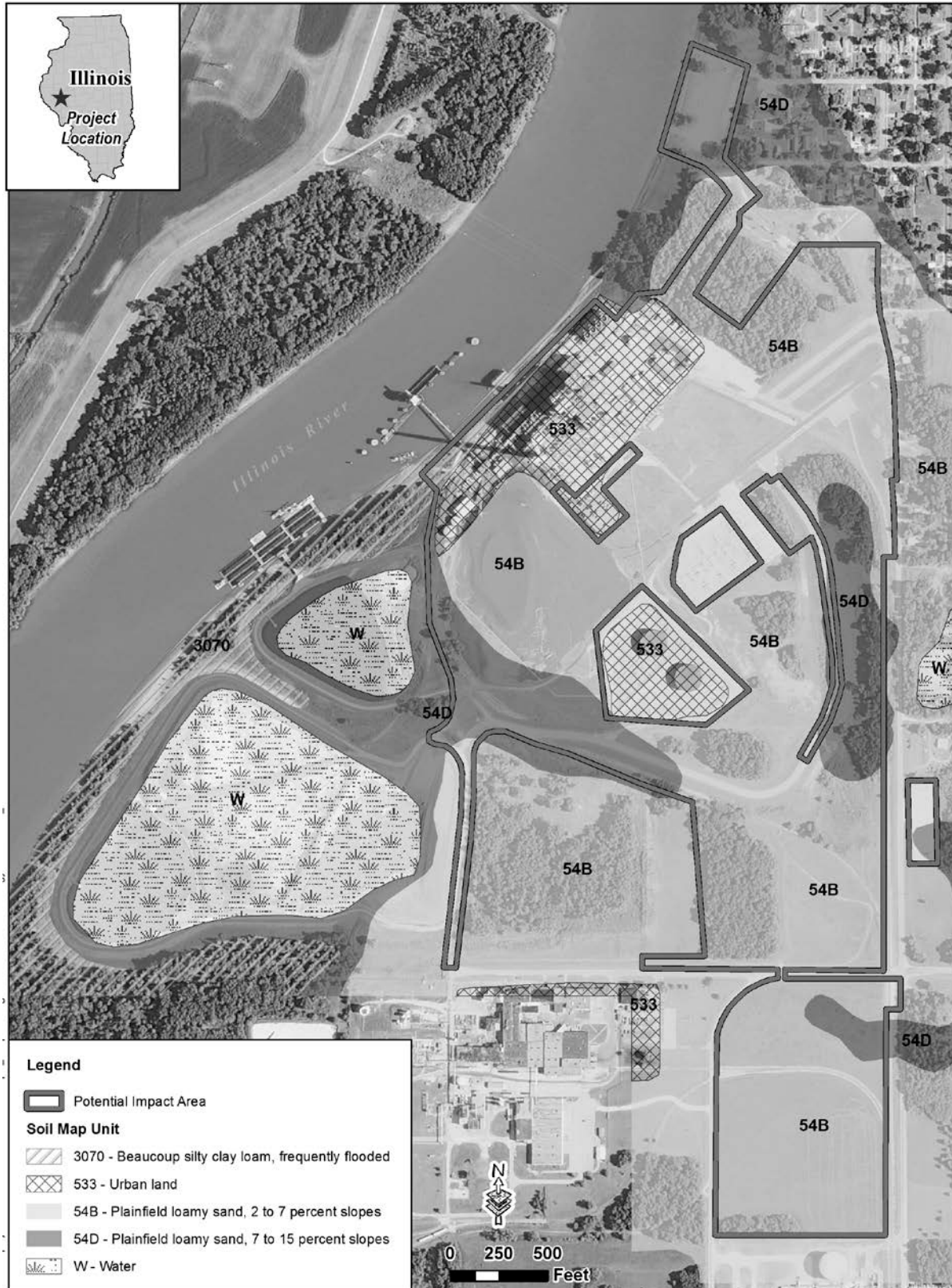

Source: USDA/NRCS 2012

Figure 3.3-2. Soils Map of Meredosia Energy Center

3.3.2.4 CO₂ Pipeline

The CO₂ pipeline would be located entirely within the Springfield Plain, a physiographic subsection of the Till Plains Section (see Figure 3.3-1). Table 3.3-2 identifies the soil types that are located within the ROI for the southern and northern CO₂ pipeline routes. Table 3.3-2 also describes the primary properties of these soils, their potential for erosion, and their status as prime farmland soils.

Most of the soils are identified as Rozetta silt loam, Ipava silt loam, Sable silty clay loam, and Osco silt loam. A majority of the soils are considered prime farmland, although some retain enough water to require draining to support crops. Farmers use drain tiles beneath their fields and man-made ditches to remove water from those soils classified as “prime farmland, if drained.” As shown in Table 3.3-2, a variety of soil map units are located along the CO₂ pipeline corridor, although many are found in patches that are 1 acre or less in area.

Table 3.3-2. Soil Map Units Along the Southern and Northern CO₂ Pipeline Routes

Map Unit Symbol	Map Unit Name	Erosion Hazard	Drainage Class	Prime Farmland	Farmland of Statewide Importance	Slope (percent)
Southern Route						
131B	Alvin fine sandy loam	Moderate	Well drained	Yes	Yes	2-7
131D	Alvin fine sandy loam	Severe	Well drained	No	Yes	7-15
7302A	Ambraw clay loam	Slight	Poorly drained	Yes ^a	Yes	0-2
962E3	Bold-Sylvan complex	Severe	Well drained	No	No	15-35
257A	Clarksdale silt loam	Slight	Somewhat poorly drained	Yes	Yes	0-2
8071A	Darwin silty clay	Slight	Poorly drained	Yes ^a	Yes	0-2
7180A	Dupo silt loam	Slight	Somewhat poorly drained	Yes	Yes	0-2
119D2	Elco silt loam	Severe	Moderately well drained	No	Yes	10-18
119E2	Elco silt loam	Severe	Moderately well drained	No	No	18-25
915D2	Elco-Ursa silt loams	Severe	Moderately well drained	No	Yes	10-18
567C2	Elkhart silt loam	Moderate	Well drained	No	Yes	5-10
280D2	Fayette silt loam	Severe	Well drained	No	Yes	10-18
30F	Hamburg silt loam	Severe	Somewhat excessively drained	No	No	18-35
30G	Hamburg silt loam	Severe	Somewhat excessively drained	No	No	35-60
244A	Hartsburg silty clay loam	Slight	Poorly drained	No	Yes	0-2
8E2	Hickory loam	Severe	Well drained	No	No	18-25
43A	Ipava silt loam	Slight	Somewhat poorly drained	Yes	Yes	0-2

Table 3.3-2. Soil Map Units Along the Southern and Northern CO₂ Pipeline Routes

Map Unit Symbol	Map Unit Name	Erosion Hazard	Drainage Class	Prime Farmland	Farmland of Statewide Importance	Slope (percent)
17A	Keomah silt loam	Slight	Somewhat poorly drained	Yes ^a	Yes	0-2
3451A	Lawson silt loam	Slight	Somewhat poorly drained	Yes	Yes	0-2
7081A	Littleton silt loam	Slight	Somewhat poorly drained	Yes	Yes	0-2
7682A	Medway loam	Slight	Moderately well drained	Yes	Yes	0-2
8682A	Medway loam	Slight	Moderately well drained	Yes	Yes	0-2
51B	Muscataune silt loam	Slight	Somewhat poorly drained	Yes	Yes	2-5
7200A	Orio sandy loam	Slight	Poorly drained	Yes ^a	Yes	0-2
3415A	Orion silt loam	Slight	Somewhat poorly drained	Yes ^b	Yes	0-2
86B	Oscos silt loam	Slight	Well drained	Yes	Yes	2-5
54B	Plainfield loamy sand	Slight	Excessively drained	No	Yes	1-7
54D	Plainfield loamy sand	Slight	Excessively drained	No	Yes	7-15
279B	Rozetta silt loam	Slight	Well drained	Yes	Yes	2-5
279C2	Rozetta silt loam	Slight	Well drained	No	Yes	5-10
279C3	Rozetta silty clay loam	Slight	Well drained	No	Yes	5-10
68A	Sable silty clay loam	Slight	Poorly drained	Yes ^a	Yes	0-2
588A	Sparta loamy sand	Slight	Excessively drained	No	Yes	0-2
19D2	Sylvan silt loam	Severe	Well drained	No	Yes	10-18
19C3	Sylvan silty clay loam	Moderate	Well drained	No	Yes	5-10
19D3	Sylvan silty clay loam	Severe	Well drained	No	Yes	10-18
19E3	Sylvan silty clay loam	Severe	Well drained	No	No	18-25
50A	Viriden silty clay loam	Slight	Poorly drained	Yes ^a	Yes	0-2
3333L	Wakeland silt loam	Slight	Somewhat poorly drained	Yes ^c	Yes	0-2
7037A	Worthern silt loam	Slight	Well drained	Yes	Yes	0-2

Table 3.3-2. Soil Map Units Along the Southern and Northern CO₂ Pipeline Routes

Map Unit Symbol	Map Unit Name	Erosion Hazard	Drainage Class	Prime Farmland	Farmland of Statewide Importance	Slope (percent)
Northern Route						
131D	Alvin fine sandy loam	Severe	Well drained	No	Yes	7-15
3078A	Arenzville silt loam	Slight	Well drained	Yes ^b	Yes	0-2
7302A	Ambraw clay loam	Slight	Poorly drained	Yes ^a	Yes	0-2
257A	Clarksdale silt loam	Slight	Somewhat poorly drained	Yes	Yes	0-2
8071A	Darwin silty clay	Slight	Poorly drained	Yes ^a	Yes	0-2
7180A	Dupo silt loam	Slight	Somewhat poorly drained	Yes	Yes	0-2
119D2	Elco silt loam	Severe	Moderately well drained	No	Yes	10-18
119E2	Elco silt loam	Severe	Moderately well drained	No	No	18-25
567C2	Elkhart silt loam	Moderate	Well drained	No	Yes	5-10
280B	Fayette silt loam	Moderate	Well drained	Yes	Yes	2-5
280D2	Fayette silt loam	Severe	Well drained	No	Yes	10-18
280E2	Fayette silt loam	Severe	Well drained	No	No	18-25
30F	Hamburg silt loam	Severe	Somewhat excessively drained	No	No	18-35
30G	Hamburg silt loam	Severe	Somewhat excessively drained	No	No	35-60
8E2	Hickory loam	Severe	Well drained	No	No	18-25
8F	Hickory silt loam	Severe	Well drained	No	No	18-35
43A	Ipava silt loam	Slight	Somewhat poorly drained	Yes	Yes	0-2
17A	Keomah silt loam	Slight	Somewhat poorly drained	Yes ^a	Yes	0-2
3451A	Lawson silt loam	Slight	Somewhat poorly drained	Yes	Yes	0-2
7081A	Littleton silt loam	Slight	Somewhat poorly drained	Yes	Yes	0-2
7682A	Medway loam	Slight	Moderately well drained	Yes	Yes	0-2
8682A	Medway loam	Slight	Moderately well drained	Yes	Yes	0-2
51B	Muscataune silt loam	Moderate	Somewhat poorly drained	Yes	Yes	2-5
7200A	Orio sandy loam	Slight	Poorly drained	Yes ^a	Yes	0-2
3415A	Orion silt loam	Slight	Somewhat poorly drained	Yes ^b	Yes	0-2

Table 3.3-2. Soil Map Units Along the Southern and Northern CO₂ Pipeline Routes

Map Unit Symbol	Map Unit Name	Erosion Hazard	Drainage Class	Prime Farmland	Farmland of Statewide Importance	Slope (percent)
86B	Oscosilt loam	Moderate	Well drained	Yes	Yes	2-5
54B	Plainfield sand	Slight	Excessively drained	No	Yes	1-7
54D	Plainfield sand	Moderate	Excessively drained	No	Yes	7-15
279B	Rozetta silt loam	Moderate	Well drained	Yes	Yes	2-5
279C2	Rozetta silt loam	Moderate	Well drained	No	Yes	5-10
68A	Sable silty clay loam	Slight	Poorly drained	Yes ^a	Yes	0-2
962D3	Sylvan-Bold complex	Severe	Well drained	No	Yes	10-18
962E3	Sylvan-Bold complex	Severe	Well drained	No	No	18-25
962E2	Sylvan-Bold silt loams	Severe	Well drained	No	No	18-25
19D2	Sylvan silt loam	Severe	Well drained	No	Yes	10-18
19E2	Sylvan silt loam	Severe	Well drained	No	No	18-25
588A	Sparta loamy sand	Slight	Excessively drained	No	Yes	0-2
19C3	Sylvan silty clay loam	Moderate	Well drained	No	Yes	5-10
19D3	Sylvan silt loam	Severe	Well drained	No	Yes	10-18
50A	Viriden silty clay loam	Slight	Poorly drained	Yes ^a	Yes	0-2
3333L	Wakeland silt loam	Slight	Somewhat poorly drained	Yes ^c	Yes	0-2
7037A	Worthern silt loam	Slight	Well drained	Yes	Yes	0-2

Source: USDA/NRCS 2012

^a. If drained.

^b. If protected from flooding or not frequently flooded during the growing season.

^c. If drained and either protected from flooding or not frequently flooded during the growing season.

CO₂ = carbon dioxide

3.3.2.5 CO₂ Storage Study Area

The CO₂ storage study area is located within the Lower Illinois River Basin in the Springfield Plain subsection of the Till Plains Section of the Central Lowland physiographic province (see Figure 3.3-1). Table 3.3-3 identifies the soil types that are located within the **approximately 6,800-acre** CO₂ storage study area. Table 3.3-3 also describes the primary properties of these soils, their potential for erosion, and their status as prime farmland soils.

Almost all of the soils within the CO₂ storage study area are considered well suited for agriculture and farmland use. Within the CO₂ storage study area, most of the soils are identified as Rozetta silt loam, Ipava silt loam, and Elco silt loam. A majority of the soils are considered prime farmland, although some retain enough water to require draining to support crops.

Table 3.3-3. Soil Map Units Found in the CO₂ Storage Study Area

Map Unit Symbol	Map Unit Name	Erosion Hazard	Drainage Class	Prime Farmland	Farmland of Statewide Importance	Slope (percent)
259C2	Assumption silt loam	Moderate	Moderately well drained	No	Yes	5-10
259D2	Assumption silt loam	Severe	Moderately well drained	No	Yes	10-15
705B	Buckhart silt loam	Moderate	Moderately well drained	Yes	Yes	2 to 5
257A	Clarksdale silt loam	Slight	Somewhat poorly drained	Yes	Yes	0-3
45A	Denny silt loam	Slight	Poorly drained	Yes ^a	Yes	0-2
119D3	Elco silty clay loam	Severe	Moderately well drained	No	Yes	10-15
119D2	Elco silt loam	Severe	Moderately well drained	No	Yes	10-15
119E2	Elco silt loam	Severe	Moderately well drained	No	No	15-20
567C2	Elkhart silt loam	Moderate	Well drained	No	Yes	5-10
280C2	Fayette silt loam	Moderate	Well drained	No	Yes	5-10
244A	Hartsburg silty clay loam	Slight	Poorly drained	No	Yes	0-2
8E2	Hickory loam	Severe	Well drained	No	No	15-30
43A	Ipava silt loam	Slight	Somewhat poorly drained	Yes	Yes	0-2
451	Lawson silt loam	Slight	Somewhat poorly drained	Yes	Yes	0-2
451A	Lawson silt loam	Slight	Somewhat poorly drained	Yes	Yes	0-2
51B	Muscatune silt loam	Moderate	Somewhat poorly drained	Yes	Yes	2-5
86B	Oscos silt loam	Moderate	Well drained	Yes	Yes	2-5
86C2	Oscos silt loam	Moderate	Well drained	No	Yes	5-10
279B	Rozetta silt loam	Moderate	Moderately well drained	Yes	Yes	2-5
279C2	Rozetta silt loam	Moderate	Moderately well drained	No	Yes	5-10
279C3	Rozetta silty clay loam	Moderate	Moderately well drained	No	Yes	5-10
68A	Sable silty clay loam	Slight	Poorly drained	Yes ^a	Yes	0-2

Table 3.3-3. Soil Map Units Found in the CO₂ Storage Study Area

Map Unit Symbol	Map Unit Name	Erosion Hazard	Drainage Class	Prime Farmland	Farmland of Statewide Importance	Slope (percent)
19C3	Sylvan silty clay loam	Moderate	Well drained	No	Yes	5-10
19D2	Sylvan silt loam	Severe	Well drained	No	Yes	10-15
19D3	Sylvan silty clay loam	Severe	Well drained	No	Yes	10-15
333A	Wakeland silt loam	Slight	Somewhat poorly drained	Yes ^b	Yes	0-2

Source: USDA/NRCS 2012

^a. If drained.

^b. If drained and either protected from flooding or not frequently flooded during the growing season.

CO₂ = carbon dioxide

3.3.2.6 Educational Facilities

The proposed educational facilities would be located in or near Jacksonville, which is the closest urban area to the CO₂ storage study area. Although a specific site has not yet been identified, the proposed site or sites for the educational facilities would be areas that have been previously disturbed, with utilities (e.g., electricity, telecommunications, water, and sewer) located on or immediately adjacent to the site or sites. These educational facilities could involve new construction, rehabilitation of existing structures, or a combination of new construction and rehabilitation. The Alliance is working with local stakeholders to identify the locations that would best serve these functions.

Whether in or near Jacksonville, the educational facilities would be located within the Lower Illinois River Basin in the Springfield Plain subsection of the Till Plains Section of the Central Lowland physiographic province (see Figure 3.3-1).

The majority of the soils in Jacksonville are classified as Tama urban land complex, found on 2 to 5 percent slopes, and Ipava urban land complex, found on 0 to 3 percent slopes. The Tama urban land complex is a gently sloping, moderately well drained soil intermingled with areas of Urban land. Water and air move through the Tama soil at a moderate rate. Surface runoff is medium on the Tama soil and rapid on the Urban land. The Ipava urban land complex is a somewhat poorly drained soil intermingled with areas of Urban land. Water and air move through the Ipava soil at a moderately slow rate. Surface runoff is slow on the Ipava soil and rapid on the Urban land. Ipava and Tama soils are both considered prime farmland; however, when they are intermingled with Urban land, as with the complexes found around Jacksonville, the soil complex is not classified as prime farmland.

3.3.3 Impacts of Proposed Action

This section describes the potential impacts on physiography and soils from the construction and operation of the proposed project.

3.3.3.1 Construction Impacts

Direct impacts to soils would occur from the construction of the oxy-combustion facility at the Meredosia Energy Center, CO₂ pipeline, injection wells, and the educational facilities. Construction activities that could affect soils for each of these project components include clearing vegetation, grading, and basic earthmoving. The CO₂ pipeline would also require trenching. Brush clearing would be required at and around the Meredosia Energy Center, although most construction would occur on already developed portions of the property. These construction activities for the FutureGen 2.0 Project would increase the potential for soil erosion, as well as permanent topsoil loss. Conversion of prime farmland could occur at

the injection well site(s). Potential soil contamination due to spills of hazardous materials during construction could also occur.

As stated earlier, since the Draft EIS was issued, several project design changes have occurred, resulting in fewer potential impacts. The most significant project design changes with respect to physiography and soils have occurred at the Meredosia Energy Center, while additional changes have also occurred along the proposed southern pipeline route and at the CO₂ storage study area. The analyses below focus on the maximum potential impacts which could occur based on a comparison between the project design presented in the Draft EIS and the current proposed project design, while also including a discussion of the potential for reduced impacts based on the various design changes that have been proposed.

Soil Erosion

The Meredosia Energy Center has an existing NPDES permit, which would be updated to include the oxy-combustion facility; **a modified permit application request was submitted on June 20, 2013**. For construction along the CO₂ pipeline and injection well site(s), the Alliance would develop and implement a project-specific SWPPP to address erosion prevention measures, sediment control measures, permanent stormwater management, dewatering, environmental inspection and maintenance, and final stabilization, in accordance with the NPDES stormwater construction permit requirements. The SWPPP would include erosion and sedimentation control measures recommended by the IEPA, and include suggestions by IDOA and the Illinois Urban Manual such as the following:

- Silt fences, sand bags, straw bales, trench plugs, and interceptor dikes during construction to minimize soil erosion; and
- Stabilization of soils through post-construction revegetation and mulching of temporarily disturbed areas.

Soil erosion BMPs implemented as part of the project-specific SWPPP, including stockpiling and covering topsoil for replacement after construction, installing silt and wind fences, and reseeded temporarily disturbed areas, would minimize soil erosion impacts from construction. The SWPPP would ensure proper treatment of highly erodible soils during construction.

The Alliance would also use topsoil conservation procedures to minimize topsoil loss in areas disturbed by construction. These would include identifying, stripping, and storing the topsoil away from subsoil materials and replacing the topsoil in temporarily disturbed areas following construction for reseeded. The topsoil displaced by construction would be stockpiled separately and re-used for revegetation of disturbed areas. The Alliance would either quickly revegetate exposed soils after construction, in compliance with the SWPPP, or return farmland to the landowner's preference (e.g., bare soil vs. vegetation) within the IDOA guidelines. As such, erosion impacts and loss of topsoil in disturbed areas during construction would be short term and minor.

Prime Farmland

Construction of the project components, **based upon the maximum potential impacts of the various project scenarios**, would disturb up to 364 acres of soils classified as prime farmland, farmland of statewide importance, and soils that could be prime farmland if they were protected from flooding or if they were adequately drained. Of these soils, all but **a maximum of approximately 25 acres** would be returned to their native state or agricultural production. The permanent soil conversions (**up to 25 acres**) would only occur at the injection well site(s) and access roads to the injection well site(s), as these soils would be removed from agricultural production for the duration of the project. Although **up to 79 acres** of soils at the Meredosia Energy Center have been classified as soils of statewide importance within the **potential permanent impact areas analyzed in the Draft EIS**, these soils were already disturbed by

industrial construction, have not been used for agricultural production for decades, and have not been included in the overall calculation.

Soils identified as prime farmland require special consideration during construction. DOE is working with IDOA and the Illinois NRCS state office to complete the Farmland Conversion Impact Rating Form AD-1006. Form AD-1006¹ compares the amount of farmland soils that would be permanently converted to nonagricultural use to those present in a region to determine the significance of the conversion. Once additional site-specific (location) data for all of the proposed project components is known, the Illinois NRCS office would finalize the form and produce a farmland impact rating. The farmland impact rating would indicate the value of the affected soils for agricultural production, and may guide mitigation measures if high value soils are converted.

Based on the nature of the proposed project and the mitigation that would be taken to reduce impacts, impacts to prime farmland are not expected to be significant. During construction of the proposed CO₂ pipeline, topsoil would be segregated and returned to mirror the pre-construction soil profile. The proposed CO₂ pipeline ROW would also be returned to agricultural use following construction. **All construction work would be performed in accordance with the conditions and stipulations of applicable federal, state, and local permits, authorizations, and clearances. In particular, the Alliance signed an Agricultural Impact Mitigation Agreement (see Appendix H, Agricultural Mitigation) with the Illinois Department of Agriculture; the Illinois Farm Bureau also participated in the development of the agreement by reviewing and providing comments that were then incorporated. The agreement sets forth the activities the Alliance would undertake to mitigate any adverse impacts to farmland associated with the construction of the CO₂ pipeline.**

Through the Agricultural Impact Mitigation Agreement, the Alliance would adopt the IDOA-developed construction procedures that are designed to conserve topsoil and farmland during the construction of pipelines and ensure that no permanent damage occurs to the drainage patterns of the adjacent fields (see **Appendix H, Agricultural Mitigation**). The Alliance would use these standards to guide construction practices so that the impacts to soils and farmland are minimized. For example, surface disturbance impacts from construction of the CO₂ pipeline would be limited to the CO₂ pipeline ROW and minimized through the implementation of standard BMPs, including efforts to minimize rutting and compaction of soils from vehicle and heavy equipment use. The pipeline installation process would involve clearing the vegetation from the surface, stripping and stockpiling the topsoil, segregating the topsoil from the subsoil materials, digging and preparing pipeline trenches, and laying the pipeline. During the process, workers would document the location of irrigation systems, drainage tiles, sensitive soils, and the groundwater table. The pipeline would be placed deep enough so that it is below drain tiles to ensure that the pipeline would not be encountered or exposed by farming methods or excessive erosion.

The CO₂ pipeline would be buried at least 4 feet underground, which is deeper than required by 49 CFR 195. An additional depth of cover would be provided at stream and road crossings, beneath drainage ditches, and beneath irrigation tiles. In agricultural lands, the CO₂ pipeline would be buried at least 5 feet deep in accordance with IDOA pipeline construction standards and policies in the Agricultural Impact Mitigation Agreement. Drain tile BMPs, including marking where tiles are connected, keeping a 1-foot buffer between the drain tiles and pipeline, and conducting timely repairs would ensure that the drain tiles would not be permanently impacted by construction. Following pipeline installation, the subsoil would be

¹ For the Site Assessment Criteria Form AD-1006, IDOA uses a statewide process to determine the construction that would cause the least harm to agriculture and its environment. The Land Evaluation and Site Assessment System is used by IDOA for the Site Assessment Criteria to assist the NRCS with making land use decisions in Illinois. The Land Evaluation and Site Assessment form uses soil surveys to assess the quality of the soils that would be disturbed by the project, and then compares the property location to the surrounding area. Projects that disturb high-quality soils in agricultural areas would need to use more stringent erosion control and mitigation measures to ensure that the project would not significantly reduce the overall quality of farmland in those areas.

placed on top of the pipeline, then capped by the reserved topsoil, and re-contoured and revegetated with vegetation appropriate to the area in order to restore the lands to their previous conditions. Construction debris and large rocks would be removed from the trenches prior to topsoil replacement. To minimize soil erosion, workers would implement BMPs, including covering the soil stockpiles, installing silt and wind fences, and revegetating the exposed soil (see **Appendix H, Agricultural Mitigation**).

The Alliance would implement a monitoring and remediation period of no less than 2 years immediately following initial operation of the pipeline or the completion of initial ROW restoration, whichever occurs last. The 2-year period would allow for the effects of climate cycles, trench settling, crop growth, drainage, soil erosion, etc. to be identified through monitoring and addressed through restoration activities. Essentially, this period would be used to identify any remaining impacts associated with the pipeline construction that would require correction and follow-up restoration, and would allow time for the Alliance to conduct necessary restoration (see **Appendix H, Agricultural Mitigation**).

Spills and Potential Soil Contamination

To minimize the potential for soil contamination during construction, the Alliance would update the existing SPCC plan at the Meredosia Energy Center to accommodate the additional elements of the project. The implementation of the revised plan would help to prevent, control, and respond to releases of petroleum products that could potentially contaminate soils per the Oil Pollution Prevention regulations under the CWA.

Meredosia Energy Center

The construction laydown areas, oxy-combustion facility, coal-handling system, electrical and control systems, access roads, and water and wastewater systems would be included within the Meredosia Energy Center property, which encompasses 263 acres. A temporary barge unloading facility would be constructed at an existing boat ramp area just north of the Meredosia Energy Center property boundary. An existing gravel road that connects the boat ramps to the main facilities at the site would be improved to handle the transport of the large equipment from the unloading area to the Meredosia Energy Center.

Direct impacts that could be caused during construction of the oxy-combustion facility and its associated elements include removal of soil; soil erosion from wind, water, or construction equipment action; soil compaction; and change in soil composition. Soil removal disrupts soil properties such as permeability and horizon structure, and removes stabilizing vegetation. Soil blowing could cause the movement of topsoil, making it unstable as well as unsuitable for vegetation growth. Soil compaction could cause changes in soil characteristics such as permeability, surface runoff, root penetration, and water capacity. Impacts to soils could result in soil erosion due to runoff and wind, potential decline in nearby surface water quality due to increased sedimentation (see Section 3.6, Surface Water), potential soil contamination due to spills, and a decrease in biodiversity due to changing soil characteristics (see Section 3.8, Biological Resources).

Initial project design as presented in the Draft EIS estimated that the construction of the oxy-combustion facility and its associated elements at the Meredosia Energy Center could directly disturb up to 164 acres of soil. Of this amount, approximately 146 acres of soils are classified by the NRCS as farmland of statewide importance. However, the current design at the energy center could reduce the area of disturbance to approximately 114 total acres during construction, of which approximately 95 acres are classified as farmland of statewide importance (see Section 2.4.3 for further discussion on estimated impact areas). As stated earlier, soils at the energy center have not been in agricultural use for decades. Most of these soils have been disturbed by previous construction and operational activities at the energy center and have not retained the characteristics of prime farmland soils. As a result, these soils would most likely not be classified as farmland of statewide importance if they were assessed today.

Of the **18 or 19 acres of soil** that are not classified as prime farmland (**depending on the final project design**), approximately 2 acres are classified as hydric, and the remainder are considered Urban soils.

Urban soils are likely covered by impermeable surfaces or existing structures at the energy center (see Figure 3.3-2). All of the soils at the energy center are classified as having erosion hazards of slight or moderate; none are characterized as severe erosion hazards.

Table 3.3-4 lists the **maximum acreages of soils that could be disturbed during construction at the Meredosia Energy Center based upon the initial design presented in the Draft EIS, and analyzed as an upper bound of potential impacts. Of the approximate maximum of 164 acres of soil that could be disturbed during construction (based upon the initial design presented in the Draft EIS), 68 acres could be temporarily disturbed and up to 96 acres could be permanently disturbed. However, based on the current design, 114 acres of soil would be disturbed during construction, which includes 73 acres of permanent disturbance and 41 acres of temporary disturbance.** At the energy center, temporary impact areas are those that would be disturbed during the construction effort resulting in a temporary change in use before being restored to their original state. The permanent impact areas are those that would be either covered with impermeable surfaces (e.g., lined **detention** basin, roads, new structures), or permanently changed from their prior use (e.g., forest to field) but remain permeable. Because the exact location of the impermeable structures within the permanent impact areas are not known, the total permanent impact area is used for the soils impact analysis. The total amount of soils that are permanently affected could be smaller once construction is complete, but it would not be larger. Figure 2-14 and Figure 2-15 summarize the temporary and permanent impact areas at the Meredosia Energy Center based on the project design presented in the Draft EIS and the current proposed project design, respectively.

Table 3.3-4. Soils Disturbed by Construction at the Meredosia Energy Center

Impacts	Total Area (acres)	Non-Urban, Non-Prime Farmland (acres)	Urban Soils^a (acres)	Prime Farmland (acres)^b	Severe Erosion Hazard (acres)
Temporary impact areas	68	<0.1	1	67	0
Permanent impact areas	96	2	15	79	0
Total^c	164	2	16	146	0

Source: USDA/NRCS 2012

^a Impervious areas and previously disturbed soils. Not prime farmland.

^b The Meredosia Energy Center site is an industrial site, and many of the underlying soils have been disturbed since the soil survey was initially performed. Therefore, although soils on the property are categorized as farmland of statewide importance, today these soils would likely not meet the necessary criteria to support this classification.

^c The acreages presented in this table reflect the upper bound of potential impacts, based on the Alliance's initial design presented in the Draft EIS. Since publication of the Draft EIS, the Alliance reduced the acreage of the potential impact areas as shown in Figure 2-15.

Because the temporary and permanent impact areas on the property would be cleared at the beginning of the construction process, there would be increased potential for topsoil erosion. As described above, implementation of a project-specific SWPPP would further ensure this impact is minor. Topsoil erosion would be prevented by using geosynthetic barriers, silt fencing, and layers of gravel. Potential impacts from spills during construction would also be minor because the existing SPCC plan would be updated to address spill prevention and response procedures for all oils that are stored onsite. The construction employees would be trained in spill prevention and cleanup to prevent any potential soil contamination.

The Meredosia Energy Center property is an industrial site, and soils within the existing site boundary have been previously disturbed from construction and operations of the facility. Of the approximate 96 acres of **maximum potential** permanent soil disturbance, 79 acres of soils are classified as farmland of

statewide importance, although most of these soils no longer exhibit the characteristics of prime farmland soils. As such, impacts to prime farmland soils at the Meredosia Energy Center would be negligible.

CO₂ Pipeline

The construction of the CO₂ pipeline would disturb the area within the construction ROW for the pipeline. The construction ROW would be up to 80 feet in width in most areas, but could be expanded to 100 feet in wooded or hilly terrain to accommodate construction equipment. During construction, temporary impacts to soils from surface disturbance caused by moving equipment, topsoil storage, and other activities would occur within the construction ROW (see Figure 2-19). Pipeline installation would require trenching and trenchless drilling that would occur near the center of the construction ROW. Table 3.3-5 provides the number of acres of prime farmland soils and soils characterized as having a severe erosion hazard within the construction ROW for the southern and northern CO₂ pipeline routes based on the criteria in Section 3.3.1.2.

Table 3.3-5. Soils Present within the Construction Right-of-Way for the Southern and Northern CO₂ Pipeline Routes

CO ₂ Pipeline Route	Total Area ^a (acres)	Non-Urban, Non-Prime Farmland (acres)	Urban Soils ^b (acres)	Prime Farmland ^c (acres)	Severe Erosion Hazard (acres)
Southern ^d	293	21	0	272	44
Northern ^e	279	31	0	248	48

Source: USDA/NRCS 2012

^a. Consists of an 80-foot wide construction ROW. Total values are approximations due to rounding.

^b. Impervious areas and previously disturbed soils. Not prime farmland.

^c. Includes prime farmland, if drained, or not frequently flooded, and farmland of statewide importance.

^d. Includes additional easement areas outside of the primary construction ROW which would be required to facilitate construction activities in areas of trenchless drilling or boring.

^e. The portion of the northern route within the storage study area is analyzed using a range of reasonable hypothetical end-of-pipeline routes as presented in the Draft EIS (see Section 3.0 for further discussion). This table presents the most conservative acreages from that analysis for each resource.

CO₂ = carbon dioxide

Since the release of the Draft EIS, the Alliance identified a location for the proposed injection well site (see Section 2.5.2.1). DOE has updated the acreages of soil impacts shown in Table 3.3-5 to account for the Alliance’s currently proposed pipeline routing for the southern pipeline, which extends from the Meredosia Energy Center to the proposed injection well site. Table 3.3-5 also includes additional easement areas (approximately 26 acres) that would be required along the southern route, primarily to facilitate additional construction equipment and activities that would be needed at the locations of trenchless boring activities (i.e., where the pipeline route crosses roads, railroad tracks, waterbodies, and similar features). The Alliance has not defined any additional routing for the northern route to the proposed injection well site, since it is no longer under consideration. In order to facilitate a representative comparison of the two routes, Table 3.3-5 presents the amount of soil impacts for the northern route including the portion of the pipeline that would traverse the CO₂ storage study area based on hypothetical routing scenarios analyzed in the Draft EIS. As explained in Section 3.0, DOE used these hypothetical siting scenarios to evaluate a range of potential impacts, whereby some hypothetical routes would have less impact to physical resources and others would have greater impact, while still representing reasonable routes.

The majority of the soils within the southern (272 acres) and northern (248 acres) pipeline routes are considered to be either prime farmland or farmland of statewide importance, which represents 93 percent and 89 percent, respectively, of the total construction ROW for each pipeline route (assuming an 80-foot wide ROW along the entire length). The proposed southern route traverses 13 soil map units that are classified as having a severe soil erosion hazard, totaling 44 acres of the construction ROW. The northern

route **crosses a maximum of 17** soil map units that have a soil erosion hazard rating of severe, amounting to **48** acres of the construction ROW.

In the event that the Alliance finds it necessary for the pipeline route to deviate from either the southern or northern pipeline routes analyzed in this EIS, it is expected that impacts would be consistent with those addressed in this section, since the same siting criteria would be followed. Any impacts resulting from surface disturbance to soil resources which occur during pipeline installation would be reduced by implementing the erosion BMPs described in this section. In addition, impacts to prime farmland soils and agricultural uses would be minimized through compliance with the Agricultural Impact Mitigation Agreement (see **Appendix H, Agricultural Mitigation**), the NPDES permitting requirements, and implementing the SPCC plan, as described above, resulting in a minor impact.

As identified above, the Alliance and IDOA have established an Agricultural Impact Mitigation Agreement (see **Appendix H, Agricultural Mitigation**) that identifies mitigation measures that would be implemented during pipeline construction to preserve prime farmland soils, including the following:

- Topsoil would be identified, stripped and stored along the pipeline route, and kept separate from the subsoil.
- Stockpiled subsoil would be used to backfill the trench prior to replacing the topsoil.
- Topsoil would be replaced so that after settling occurs, the topsoil's original depth and contour would be restored.

CO₂ Storage Study Area

The proposed injection wells and associated surface facilities would be located within the **approximately 6,800-acre** CO₂ storage study area in the northeastern portion of Morgan County (see Figure 2-17). The majority of soils (**96** percent) within the CO₂ storage study area are considered either prime farmland or farmland of statewide importance. In addition, seven soil types, totaling approximately **605** acres (**9** percent) of the CO₂ storage study area are characterized as presenting a severe hazard for soil erosion. Because of the high percentage of prime farmland soils within the CO₂ storage study area, it is likely that most or all of the soils disturbed during construction of the injection wells, supporting facilities, and roads would be classified as prime farmland soils **regardless of the final location selected**.

For the dual-site scenario analyzed in the Draft EIS and no longer under consideration by the Alliance, construction activities would affect up to 28 acres for the injection and monitoring wells and associated facilities; and up to 64 acres for the staging and construction of access roads. The updated design for the single-site scenario would affect up to approximately 15 acres for construction of the injection wells and associated facilities, and up to 4 acres for the access roads. An additional 24 acres would be affected during staging and construction of the monitoring well network, which would include monitoring wells located at the injection wells and within the plume radius (see Figure 2-26). The land not required for the permanent access roads would be returned to agricultural production once construction is complete. Some of the area would be regraded and revegetated once construction was complete, while the fenced areas around the injection well site(s) and the facilities would be removed from agricultural production for the duration of the project. **Table 3.3-6 provides the number of acres of prime farmland soils and soils characterized as having a severe erosion hazard within the proposed injection well site under the single-site scenario (see Figure 2-20).**

The amount of soils permanently withdrawn is described in Section 3.3.3.2. The Alliance, to the extent practicable, would avoid net reductions in agricultural land by potentially replacing lands taken out of agricultural use with local land that could be placed into agricultural use. However, the total amount of prime farmland soil would still be reduced by 25 acres as a result of this project.

Table 3.3-6. Soils Present within the Proposed Injection Well Site (Single-Site Scenario)

Tract	Total Soil Area (acres)	Non-Urban, Non-Prime Farmland (acres)	Urban Soils ^a (acres)	Prime Farmland ^b (acres)	Severe Erosion Hazard (acres)
Injection Site Property	9.46	0	0	9.46	3.80
Leased Property	5.54	0	0	5.54	1.83

Source: USDA/NRCS 2012

^a. Impervious areas and previously disturbed soils. Not prime farmland.

^b. Includes prime farmland, if drained, or not frequently flooded, and farmland of statewide importance.

CO₂ = carbon dioxide

Impacts to prime farmland soils and agricultural uses would be minimized through compliance with the Agricultural Impact Mitigation Agreement, the NPDES permitting requirements, and implementation of the SPCC plan. As a result, there would be minor, temporary impacts to soils from construction within the CO₂ storage study area.

At the injection well site(s), the Alliance would use drilling BMPs, including using secondary containment for all fuel storage tanks, and placing synthetic sheeting in all mud pits and associated circulation equipment. A synthetic liner would be placed beneath the drilling rig, and the drilling contractor would maintain an inventory of absorbent materials (e.g., pads and booms) in order to respond to any release of engine oil, hydraulic oil, diesel fuel, gasoline, antifreeze, drilling fluids or any other contaminants as a result of the driller’s activities. Any spills involving fuel or other liquid or dry chemicals would be cleaned up immediately, including any affected soil. All spill cleanup materials as well as any affected soil would be contained and disposed of properly. Section 2.5.2.3 provides additional detail on the drilling techniques that would be used to construct the injection wells, including spill prevention methods. As a result, impacts to soils from the construction of the injection and monitoring wells are expected to be short term and minor.

Educational Facilities

As described in Sections 2.5.3 and 3.0, since the release of the Draft EIS, discussions between the Alliance and Jacksonville civic authorities have focused on a potential site in Jacksonville for the educational facilities, but the specific locations currently remain unknown. The educational facilities could involve new construction, rehabilitation of existing structures, or a combination of new construction and rehabilitation. Although a specific site has not yet been identified, the proposed site or sites for the educational facilities would be areas that have been previously disturbed, with utilities (e.g., electricity, telecommunications, water, and sewer) located on or immediately adjacent to the site or sites. Considering that the selected site(s) would be located on previously disturbed land with utility connections, it is unlikely that additional, new soil disturbance would result from the construction of the educational facilities. No farmland soil impacts would be anticipated. Compliance with NPDES permitting requirements and spill prevention and soil contamination minimization measures as outlined above would ensure effects to soil remain negligible to minor.

3.3.3.2 Operational Impacts

Direct impacts to soils during operation could include soil contamination from hazardous or non-hazardous material spills or soil disturbance during routine maintenance and repairs. These impacts are discussed in more detail below. Overall, impacts to soils from operation of FutureGen 2.0 Project would be minor.

Meredosia Energy Center

Impacts to soils during operation would be minimal. There would be a minor potential for soil contamination from hazardous and non-hazardous material spills due to storage and transport of process chemicals and wastes at the Meredosia Energy Center. Soils could also be contaminated from fuels, oils, and other fluids used to power onsite vehicles and operational equipment. With effective BMPs and compliance with all federal and state regulations, including a facility SPCC plan for storage and handling of oils, spills would be infrequent and minimized. Personnel would be trained and equipped to respond to spills, so the spills would be cleaned and remediated. Implementation of these measures would ensure that impacts to soils during operations would be minor.

CO₂ Pipeline

After construction, the soils above the CO₂ pipeline that previously supported agricultural production, including the operational ROW, would be returned to agricultural production. Pipeline patrolling would be conducted by road, by foot, and **potentially** by helicopter, and contracted to specialist companies. Access to the pipeline would be through existing access roads or at access points for the new pipeline. These visual surveys would be conducted every 2 weeks and would look for signs of leaks (e.g., discolored vegetation, disturbed soil) and potential infrastructure concerns (e.g., exposed pipe at stream crossings), as required by the DOT. If major repairs or maintenance activities (i.e., periodic hydrotesting) were needed along the pipeline, impacts would be similar to those described for pipeline construction in Section 3.3.3.1. Impacts to prime farmland soils and agricultural uses would be minimized through compliance with the Agricultural Impact Mitigation Agreement (**see Appendix H, Agricultural Mitigation**) and other measures, as described above, resulting in minor impacts during operation.

CO₂ Storage Study Area

Under the dual-site scenario that was analyzed in the Draft EIS but is no longer under consideration by the Alliance, operation of the CO₂ injection wells and supporting facilities would require up to 25 acres (including access roads). However, under the single-site scenario now proposed by the Alliance, operation of the CO₂ injection wells and supporting facilities would require approximately 14 acres (including access roads). Based upon the current proposed location of the injection well site under the single-site scenario (proposed option) as depicted in Figure 2-20, approximately 9.5 acres of prime farmland soils or soils of statewide importance would be permanently changed to nonagricultural use, resulting in a long-term, minor impact.

No additional impacts, beyond those addressed in Section 3.3.3.1, would be anticipated during the operation of the pipeline across the CO₂ storage study area to the injection wells. Between 7 and 14 acres of prime farmland would be disturbed within the proposed operational ROW; however, agricultural production would be allowed within the ROW up to the fence line of the injection well site(s).

Although highly unlikely, near-surface leaks during injection could cause an increase in CO₂ in the soil horizon. Because supercritical CO₂ readily vaporizes at atmospheric pressure, an increase of CO₂ concentration in the soil could lower the pH of the soil, which could affect plant growth (DOE 2007a). CO₂ dissolved in groundwater could also increase the mobility of heavy metals through the soil column. However, periodic integrity testing of each well would eliminate the risk of such a near-surface leakage. As discussed in Section 3.4, Geology, there would be a very low risk that the CO₂ would travel up from the Mt. Simon Formation and through the caprock formation; therefore, these types of impacts are not anticipated.

Educational Facilities

No additional impacts to soils would occur during operation of the educational facilities.

3.3.4 Impacts of the No Action Alternative

Under the no action alternative, DOE would not provide cost-shared funding for the FutureGen 2.0 Project. Although the Alliance may still elect to construct and operate the project in the absence of DOE

cost-shared funding, for the purposes of the analysis in this EIS, DOE assumed that the no action alternative is equivalent to the no-build alternative. Therefore, there would be no changes to physiography and soils under this alternative.

3.4 GEOLOGY

3.4.1 Introduction

This section describes the geologic resources potentially affected by the construction and operation of the FutureGen 2.0 Project and its related components. This section also analyzes the potential direct and indirect effects of this proposed project on these resources.

3.4.1.1 Region of Influence

DOE identified three different ROIs for the analysis of potential impacts to geologic resources. The first ROI addresses potential impacts to geologic formations and landforms resulting from the planned construction and presence of surface facilities at the Meredosia Energy Center property, within the CO₂ pipeline corridor, at the CO₂ storage study area, and at the site for the proposed educational facilities. This ROI would include any geologic resources underlying or near the proposed project features, and would be restricted to the construction footprint.

The second ROI addresses potential impacts to geologic resources resulting from the injection of CO₂ into deep geologic formations. This ROI is specific to the formations that would be used for the injection and storage of CO₂ (the injection zone) and the lateral extent of the CO₂ plume within those formations. **Since the Draft EIS was released, the Alliance submitted the UIC permit applications to the USEPA, which identified the proposed locations for the injection wells and the location of the AoR. The permit applications also identified the 25-square mile UIC survey area, which matches the area analyzed in the Draft EIS.** The UIC survey area is centered around, and encompasses the CO₂ storage study area and is used as the injection ROI. This ROI would include all potential locations of the CO₂ plume.

The third ROI addresses potential impacts from seismic (i.e., earthquake) effects on the FutureGen 2.0 Project. The ROI includes the area within a 30-mile **radius around the proposed injection well site(s)**, which covers the area that could be impacted by earthquakes, based on damage reports from past seismic events in the region (USGS 2013).

3.4.1.2 Method of Analysis and Factors Considered

The geologic setting for the proposed project includes the glacial deposits, bedrock, and any minerals within the ROIs that have been defined for the project. DOE evaluated the potential effects of the construction and operation of the project on these geologic resources. Several data sources were used to support this analysis, including USGS topographic maps, geologic reports and GIS data from the Illinois State Geological Survey, and USGS earthquake maps.

In addition, DOE used data provided by the Alliance from geologic characterization activities conducted in the CO₂ storage study area, **including a two-dimensional seismic survey and stratigraphic well data.** Under its cooperative agreement with DOE, the Alliance completed a stratigraphic well in the CO₂ storage study area in December 2011. This well was constructed to allow the Alliance to collect the comprehensive data needed to characterize the geology and hydrogeology of the area. This data will be used to support the design and permitting of the project as well as the analysis of impacts in this EIS. **DOE incorporated into the Final EIS the latest project design information and data from the UIC permit applications, which include updates to the CO₂ pipeline routes, the CO₂ storage study area, the location of the injection wells, and the plume modeling.**

CO₂ Storage Study Area – 6,800-acre area that would contain the injection and monitoring wells and the CO₂ plume.

Area of Review (AoR) – an area of approximately 4,000 acres around the injection wells, and determined by computer modeling of the CO₂ plume. The dimensions and location are presented in the UIC permit applications.

UIC Survey Area – a 5-mile by 5-mile square (25 square miles) area, centered on the CO₂ storage study area, used to analyze the USDW and well locations within and around the AoR to support UIC permitting.

DOE, the Midwest Geological Sequestration Consortium, and other private entities are researching the possibility for large-scale geologic sequestration throughout the Illinois Basin (NETL 2012a). Three other sequestration projects have been planned or are in operation in Illinois, and are discussed in further detail in Section 4.3, Potential Cumulative Impacts. Two projects are located outside of Decatur, IL, and one is in the planning stage near Taylorville, IL. The information and data gathered from these projects have been used to support the impact analysis in this EIS.

DOE assessed the potential for impacts based on whether the proposed FutureGen 2.0 Project would:

- Cause or be damaged by geologic-related events (e.g., earthquakes, landslides, sinkholes);
- Reduce the value of mineral or petroleum resources or unique geologic formations, or render them inaccessible;
- Alter unique geologic formations resulting in the migration of geologically stored CO₂ through faults, compromised caprock, or other pathways such as abandoned or unplugged wells;
- Cause visible ground heave or upward vertical displacement of the ground surface; or
- Affect human exposure to radon gas.

3.4.1.3 Regulatory Framework

The injection of CO₂ for geologic sequestration is regulated under the authority of the Safe Drinking Water Act's UIC Program. On December 10, 2010, the USEPA published a final rule, "Federal Requirements Under the Underground Injection Control Program for Carbon Dioxide Geologic Sequestration Wells" (75 FR 77230) (the "Class VI rule"). Under this rule, the USEPA created a new category of injection wells (Class VI wells) with new federal requirements to allow for injection of CO₂ for geologic sequestration and to ensure the protection of USDWs. In accordance with the Class VI rule, the Alliance **submitted** permit applications to the USEPA to obtain UIC Class VI permits for each injection well. **Since the state of Illinois does not have the authority to issue Class VI permits at this time, the USEPA would need to issue the permits** before injection could commence.

The Class VI rule requires operators of Class VI wells to develop, gain approval for, and implement five project-specific plans, including an AoR and Corrective Action Plan, a Testing and Monitoring Plan, an Injection Well Plugging Plan, a Post-Injection Site Care and Site Closure Plan, and an Emergency and Remedial Response Plan. The AoR and Corrective Action Plan describes how an operator intends to delineate the AoR for the Class VI injection well and ensure that all identified deficient artificial penetrations (i.e., wells that are improperly plugged or completed) would be addressed by corrective action techniques so that they would not become conduits for fluid movement into USDWs. The AoR is defined as the region surrounding the geologic sequestration project where USDWs may be endangered by the injection activity. The AoR is delineated using computational modeling that accounts for the physical and chemical properties of all phases of the injected CO₂ stream and displaced fluids, and is based on available regional and site characterization, monitoring, and operational data as set forth in 40 CFR 146.84.

The Alliance submitted the UIC permit applications for the four proposed Class VI wells in March 2013, and revised the applications in response to USEPA comments in May 2013. The permit applications describe the computer modeling used to predict the lateral extent of the CO₂ plume within the injection zone. Appendix G, Geological Report, provides the plume modeling methodology, data, and results that were submitted in the UIC permit applications. Computer modeling was used to simulate the currently proposed injection well configuration of four horizontal injection wells at one injection well site, whereby 1.2 million tons (1.1 million metric tons) of CO₂ would be injected per year for 20 years into a horizon within the Mt. Simon Formation. Section 2.5.2.3 has a description of the wells that the Alliance used for the model analysis.

The computer modeling results indicated that the CO₂ plume would encompass an area of approximately 4,000 acres, roughly centered on the injection wells. **In the UIC permit applications, this area was designated as the AoR.** In addition, the Alliance collected data within the 25-square mile (16,000-acre) UIC survey area, centered on the **6,800-acre CO₂ storage study area, to identify any existing deep wells that have the potential to be confining zone pathways.** The analysis in this section uses the 25-square mile UIC survey area when characterizing potential impacts resulting from the injection of CO₂ into the injection zone. The Class VI rule also requires the identification of the USDWs within the AoR that could be affected by injection activity (40 CFR 146.81(d)). Section 3.5, Groundwater, describes the USDWs in the CO₂ storage study area in more detail, along with potential impacts to these aquifers.

The UIC Class VI permit applications **present** the location of the injection wells and the delineated AoR. The Alliance would reevaluate the AoR at least every 5 years after the issuance of the UIC Class VI permits, which would consider the volume of CO₂ injected, the resulting subsurface CO₂ plume, and any other results from the MVA program. **The Alliance may also be required to update the injection procedures, AoR, or MVA program.**

3.4.2 Affected Environment

3.4.2.1 Regional Geologic Setting

The FutureGen 2.0 Project would be located in the Central Lowland Province, which is further subdivided into till plain areas based on glacial topography. The delineation of the till plain areas is based on the change of sedimentary deposits from the glaciations of the Illinois and Wisconsin episodes (USGS 2011a). In the Central Lowland Province, the topography is generally flat, although scarps and moraines are present in the region. The FutureGen 2.0 Project is located within the Springfield Plain, which is also flat with very localized variations in topography from the glacial deposits from the Illinois episode. Beneath the glacial deposits is a deep sequence of sedimentary bedrock that formed over a period of millions of years. The ages of the bedrock units range from the Pennsylvanian (300 million years) Spoon-Carbondale formation to the Precambrian metarhyolite basement (540 million years). Metarhyolite is a volcanic rock that has been altered by heat and pressure over time. The remainder of this section provides additional details on the geologic formations that underlie the project area.

Surficial Geology

The topography of Morgan County has low relief, which is incised by small streams that flow to the Illinois River. The elevation ranges from 400 feet in the west, near the Illinois River, to 700 feet above sea level in the east. The northwestern and southern portions of Morgan County tend to have deep valleys and narrow upland ridges, while the eastern portion is nearly level to slightly undulating. The Illinois River forms the western border of Morgan County. Adjacent to the river is a flat floodplain with alluvial sediments deposited over the remnants of an ancient glacial channel. The floodplain extends eastward for approximately 2 miles until it reaches a series of sand outwash hills that stretch from north to south (Hajic and Leigh 1985). These hills rise 100 to 120 feet above the river valley. The Illinois episode drift deposits in Morgan County are also covered by fine, wind-blown sediment (loess) from the Wisconsin episode.

The most common glacial formations in Morgan County include the Cahokia, Glasford, and Peoria Formations (ISGS 2011a). The Cahokia Formation is present in the floodplain area between the Illinois River and the glacial bluffs. The formation consists of stratified silt, clay, loess, and sand deposits that were deposited after the last glacial event (Wisconsin episode) and reworked by the Illinois River. The Cahokia Formation is approximately 100 to 200 feet thick around the Illinois River (Piskin and Bergstrom 1975). Loess deposits are not usually found immediately around the Illinois River because the soils have been extensively reworked by the flow of the river.

Starting at the bluffs, and extending eastward, is the glacial till plain of the Glasford Formation, which was deposited during the Illinois episode, and then covered by loess of the Peoria Formation during Wisconsin episode (ISGS 2011a). The Cahokia Formation is also found in the bottom of stream valleys,

such as Snake Creek, where the glacial tills have been reworked by stream action. The Glasford Formation is comprised of glacial tills interbedded with sandy outwash deposits. The thickness of the glacial till generally increases from west to east; however, the thickness is extremely variable, ranging between 25 and 100 feet from Meredosia to Jacksonville (Piskin and Bergstrom 1975). Soils in eastern Morgan County are formed from the Peoria Loess, which was draped over the deeper till and drift deposits at the end of the Wisconsin glacial event. The Peoria Loess decreases in thickness from west to east, from over 20 feet outside of Meredosia to 10 feet in the CO₂ storage study area (ISGS 2011b).

Bedrock Geology

The FutureGen 2.0 Project components would be located in the western shelf of the Illinois Basin, which covers an area of about 110,000 square miles in parts of Illinois, Indiana, and Kentucky. The bedrock sequence within the basin consists of thousands of feet of sandstone, shale, and carbonate layers over a basement of ancient granite and rhyolite. The sediments that formed the bedrock were deposited in alluvial fans and shallow water in a variable coastal environment during the Paleozoic era, starting 570 million years ago. There are no bedrock formations younger than the Pennsylvanian epoch (300 million years ago) in the Illinois Basin, which indicates that the basin ceased to grow and the dominant sedimentary processes changed from deposition to erosion. The presence of an erosion contact between formations in the bedrock sequence also represents a period of halting deposition and subsequent erosion.

A primary characteristic of the Illinois Basin's western shelf is the presence of broad, parallel sedimentary layers that do not display any major faults (Alliance 2013a). The major structural feature in the bedrock at Morgan County is the Sangamon Arch, a broad, gently curving anticline, whose "ridge" runs roughly east-northeast from Jacksonville to Champaign (ISGS 1995a). The arch causes the bedrock in Morgan County to gently dip about 1 to 2 degrees to the southeast. Figure 3.4-1 shows a representative cross section of the bedrock formations in Morgan County. The bedrock is shown dipping to the east; therefore, the bedrock closest to the surface tends to become younger from west to east.

Figure 3.4-2 presents a detailed stratigraphic column for the formations present at the CO₂ storage study area. The figure details the formation depths based on measurements taken from the stratigraphic well that was completed by the Alliance in fall 2011. The well was drilled through the Mt. Simon Formation and into the Precambrian metarhyolite basement to a depth of 4,826 feet bgs. Descriptions of the formations are provided in the text below.

Mississippian and Pennsylvanian Formations

The shallowest bedrock formations are located in the eastern portion of Morgan County. The youngest formation in the FutureGen 2.0 Project area is the Spoon-Carbondale Formation, which was deposited in the middle Pennsylvanian epoch, and consists of shale deposits with sandstone lenses. The Spoon-Carbondale presents a small section of a larger sequence of alternating marine and non-marine sediments that have been identified in other areas of the Illinois Basin (Willman et al. 1975). The upper and lower contacts of the formation are erosional surfaces.

The next sequence of formations was formed in the Mississippian epoch, when much of Illinois was beneath a large inland sea. As such, the individual formations and members tend to taper out from east to west, as the deposits were controlled by the depth of the water and location in relation to the coastline and rivers (Willman et al. 1975). These formations are characterized by alternating sequences of dolomitic limestone, calcareous shales, and light grey limestones that slowly change in composition from one formation into the one above. The Mississippian formations in eastern Morgan County are the St. Louis Limestone, Salem Limestone, Warsaw Shale, Keokuk-Burlington Limestone, and Hannibal Shale.

The St. Louis and Salem Formations are fine-grained, cherty limestone formations. The St. Louis is laterally extensive, and is truncated at the top by an erosion unconformity (Willman et al. 1975). The Warsaw Shale is comprised of gray shale and silty limestone with numerous invertebrate fossils. The Keokuk-Burlington Limestone is a fine-grained, cherty limestone, with numerous microfossils. It

gradually becomes siltier as it grades upwards to the Warsaw Shale. The Hannibal Shale is a green to gray, clay-rich shale with abundant microfossils.

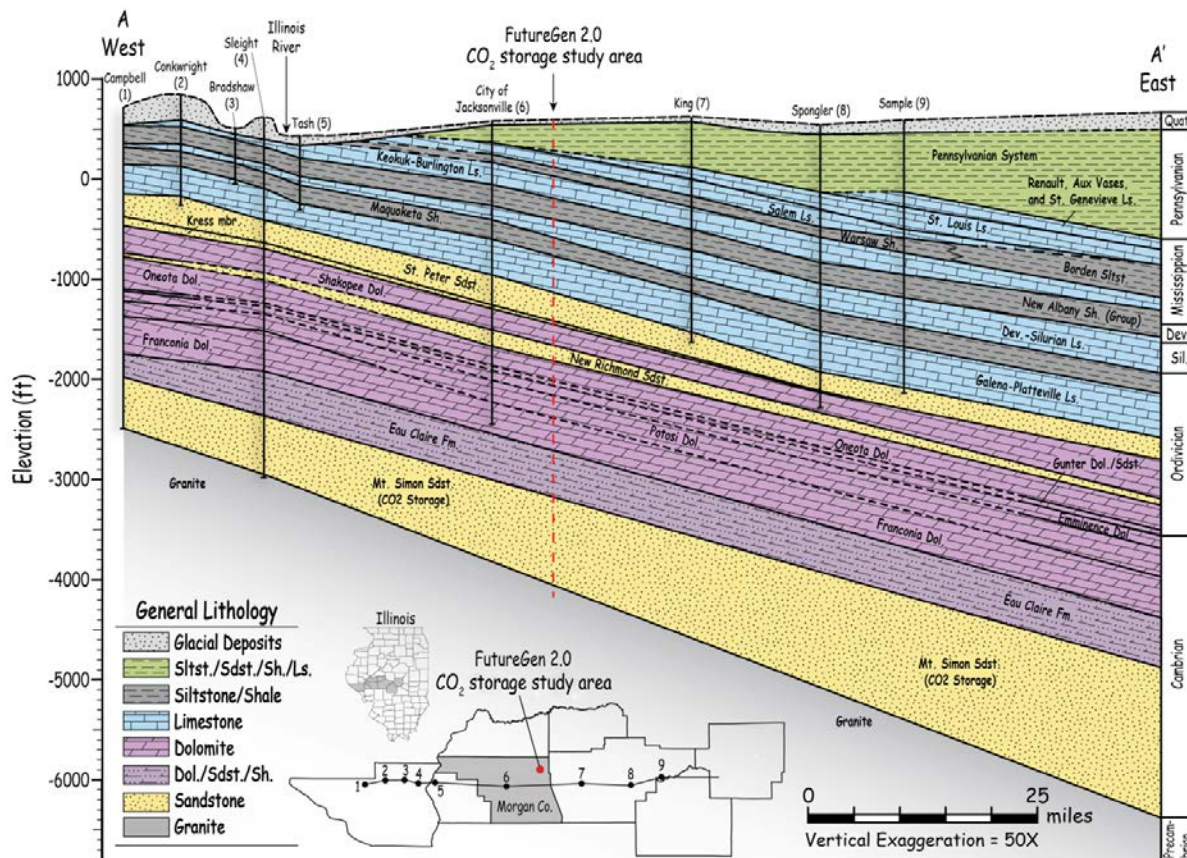

Source: Alliance 2013a
 Dev = Devonian; Dol = Dolomite; Fm = Formation; Ls = Limestone; Quat = Quaternary; Sdst = Sandstone; Sh = Shale; Sil = Silurian; Siltst = Siltstone

Figure 3.4-1. Cross Section of the Bedrock through Morgan County

In western Morgan County, near the Meredosia Energy Center the sequence of Mississippian formations is the Burlington-Keokuk Limestone, Fern Glen Formation, and Meppen Limestone (ISGS 2005). The Fern Glen consists of red and green calcareous shale, shaly limestone, and a base of large, yellowish gray limestone, with abundant invertebrate fossils. The Meppen Limestone is a tan dolomitic limestone with small calcite geodes.

Silurian and Devonian Formations

The New Albany Shale is an Upper Devonian-Lower Mississippian formation that is comprised of black, organically rich marine shales. The New Albany has an erosion contact with the Devonian Limestone with thin beds of sandy material near the base and carbonates near the top of the formation. The New Albany Shale is the primary source of oil and gas in Illinois, although its presence at a location does not guarantee the existence of economically recoverable oil or gas deposits (Cluff and Dickerson 1982).

Beneath the New Albany Formation are two undifferentiated formations, which are part of the Hunton Limestone Megagroup. These Silurian and Devonian formations are very thin because tectonic activity at the time changed the area’s sediment deposition patterns and increased erosion. The Silurian and Devonian formations are local deposits of fine-grained limestone, with numerous microfossils. These formations have erosion contacts at the base and top.

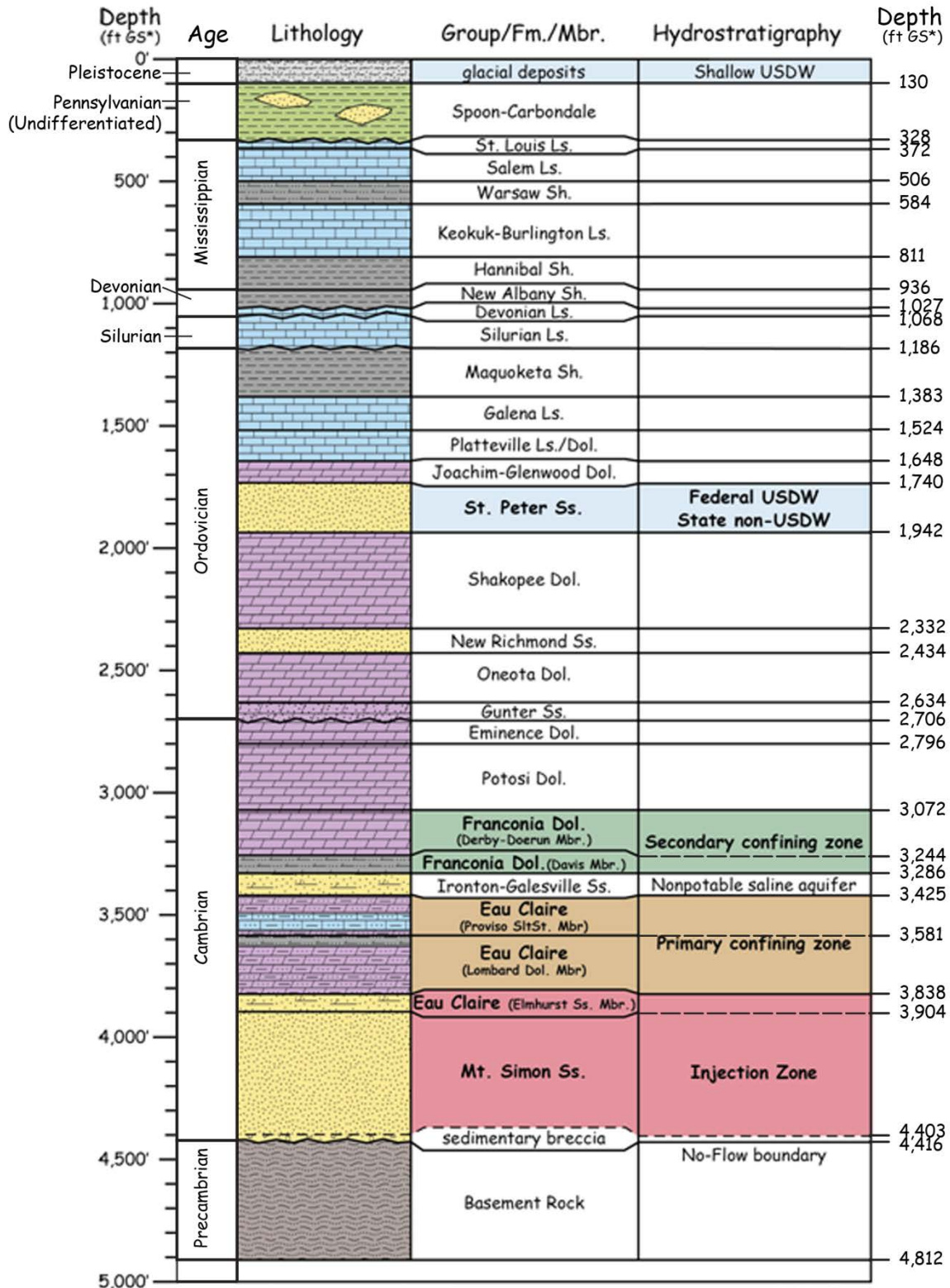

Source: Alliance 2013a

Dol = Dolomite; ft GS* = feet below ground surface; Fm = Formation; Mbr = member; Sh = Shale; Siltst = Siltstone; Ss = Sandstone; USDW = underground source of drinking water

Figure 3.4-2. Generalized Stratigraphic Column for the CO₂ Storage Study Area

Upper Ordovician Formations

The Upper Ordovician formations include the Maquoketa Shale, Galena Limestone, Platteville Limestone and Dolomite, and the Joachim Glenwood Dolomite. Each of these formations has upper and lower erosion contacts, which represent multiple episodes of deposition and erosion of the unconsolidated sediments. The formations tend to be fine grained and low porosity.

The Maquoketa Shale contains gray to dark brown shale, while the Galena Limestone has fine limestone, which contains numerous fossils, and is occasionally capped by dolomite. The Platteville Limestone/Dolomite consists of brown, slightly shaley limestone and impure dolomite. The Joachim-Glenwood Dolomite are two formations that cannot be differentiated within the stratigraphic well, and are characterized by light gray, clay-rich, silty and sandy dolomite, with beds of brownish gray, and relatively pure dolomite. Sandy beds and other inclusions may also be present (Willman et al. 1975).

St. Peter Formation

The St. Peter Formation is an Ordovician-age, well-sorted, poorly-cemented, quartz sand with little clay or carbonate inclusions. The formation was deposited in a beach environment in a period of increasing water depth (Willman et al. 1975). An erosion contact occurs between the Shakopee Dolomite and the St. Peter. In Illinois, the St. Peter is a well-known bedrock aquifer with salinity that varies from northwest to southeast. Maps of the aquifer salinity show that the St. Peter aquifer contains water with total dissolved solids between 2,500 and 10,000 milligrams per liter at the storage area (ISGS 2004). Samples taken from the stratigraphic well confirm that the salinity concentration is less than 10,000 milligrams per liter. Section 3.5, Groundwater, contains additional hydrogeologic information about the St. Peter Formation.

The St. Peter is also a well-documented natural gas storage formation with 38 gas reservoirs throughout Illinois. In the early 1950's, the Panhandle Eastern Pipeline company acquired gas storage rights to inject natural gas in the Waverly dome of the St. Peter Formation, about 15 miles south of the CO₂ storage study area. After injecting approximately 5,500,000 million cubic feet of natural gas over 5 years, injection was discontinued **through 1960** (Bell 1961).

Lower Ordovician and Upper Cambrian Knox Group

The formations between the St. Peter and the Eau Claire, which were deposited in the Ordovician and Cambrian, are correlated to the Knox Group, which is found throughout the Illinois Basin (Swezey 2009). Regionally, the Knox Group consists of impermeable, dense dolomites, and few thin sandstone formations. At the stratigraphic well, the Knox group consists of about 1,500 feet of bedrock. From top to bottom, the Ordovician formations within the sequence are the Sakopee Dolomite, New Richmond Sandstone, Oneota Dolomite, and Gunter Sandstone. The Shakopee Dolomite is a thick, clay-rich to pure fine-grained dolomite with some thin beds of sandstone, siltstone, and shale. Beneath the Shakopee is the New Richmond Sandstone, a fine- to medium-grained sandstone with some interbedded sandy dolomite. The Oneota Dolomite is a fine- to coarse-grained cherty dolomite with minor amounts of sand and thin shaley beds at the base. The Gunter Sandstone consists of medium- to fine-grained quartz sand and is generally thin throughout the basin. The Oneota Dolomite/Gunter Sandstone sequence is bounded in the top and bottom by erosional contacts with the surrounding formations.

The rest of the formations (Eminence Dolomite, Potosi Dolomite, Franconia Dolomite, and the Ironton-Galesville Sandstone) were deposited in the Cambrian. The Eminence Dolomite is a medium-grained dolomite with some chert and thin beds of sandstone, while the Potosi Dolomite is a relatively pure dolomite. The Franconia Dolomite is a clay-rich dolomite sequence that is separated into two members: the Derby-Doerun and the Davis. The Davis is a widespread, low-permeability shale that grades upwards into the silty and sandy dolomite of the Derby-Doerun Member. The Ironton-Galesville Sandstone is a calcareous coarse sandstone, and contains a deep subsurface aquifer. The formation has been used for natural-gas storage in the Waverly field in southeast Morgan County.

Eau Claire Formation (Confining Zone)

The Eau Claire Formation consists of dolomite, dolomitic sandstone, limestone, siltstone, and shale, with no erosion contact between its base and the top of the Mt. Simon Formation, (Willman et al. 1975). The Eau Claire has been identified throughout Illinois, with thicknesses that range from less than 200 feet in western Illinois to greater than 1,000 feet in the southeast (Willman et al. 1975). The Eau Claire is composed of three members, which reflect the increasing water depth in the depositional environment. The upper layer is the Proviso siltstone member, which consists of dolomite and sandy siltstone with beds of greenish gray, pink, or red shale. Below the Proviso is the Lombard dolomite member, which consists of glauconitic and sandy dolomite interbedded with greenish gray shale (Willman et al. 1975). The underlying Elmhurst member consists of sandstone with thin, irregular gray shales, which gradually contains more carbonate and fine-grained material as it grades into the Lombard member. **The Proviso and Lombard members make up the confining zone, while the Elmhurst member is included in the injection zone with the Mt. Simon Formation.**

Mt. Simon Formation (Injection Zone)

The Cambrian-age Mt. Simon contains one of the Illinois Basin's major deep saline aquifers and is considered the best formation for carbon sequestration in the region. The DOE estimated that the CO₂ storage capacity for the Mt. Simon Formation is approximately **12 to 165 billion tons (11 to 150 billion metric tons)** (NETL 2012a). The Mt. Simon is comprised of fine- to coarse-grained quartzose-cemented sandstone that is partially conglomeratic, with some lenses of micaceous shale toward the top of the formation. In the southern Illinois Basin, the Mt. Simon Formation formed from distal alluvial fan deposits from the granitic highlands and likely included extensive braided river deposits, barrier islands and deltaic environments (Bowen et al. 2011; Leetaru and McBride 2009). Over time, accumulating sediment and tectonic movement shifted the depositional environment to more extensive braided fluvial systems, with a gradual transition to a marginal marine environment that formed the shales of the Eau Claire (Bowen et al. 2011). The Mt. Simon is present throughout Illinois, with thicknesses that range from over 2,000 feet in the northeast to 500 feet or less in the south-southwest. For years, natural gas has been successfully stored in the Mt. Simon in 50 wells throughout north-central Illinois. This suggests that the formation exhibits characteristics, such as sufficient permeability and porosity, which make it suitable for long-term gas storage. The total dissolved solids concentration in the brine that was sampled at the stratigraphic well (at a depth of 4,050 feet bgs) was 48,000 milligrams per liter.

Precambrian Metarhyolite and Sedimentary Breccia

At the base of the Mt. Simon is a thin layer of fractured and weathered rhyolite wash deposits (sedimentary breccia), which are weathered remnants of the Precambrian metarhyolites and granites that form the base of the Illinois Basin. The basement metarhyolite is medium to coarse-grained, silica-rich, volcanic rock, with an age of approximately 1.47 billion years. After it was formed, the Precambrian basement was subjected to long periods of heat and pressure, which reorganized the mineral structure of the bedrock.

Seismic Activity

The presence or absence of faults and seismic activity is particularly relevant to carbon sequestration projects because faults, if present, could provide preferential pathways for injected or displaced fluids to migrate from the injection zone. The proposed project area is located in a relatively low risk zone for earthquakes, with no major mapped faults within or near the proposed project areas. In addition, no known large, structural faults occur in Morgan County (ISGS 1995b). The nearest major fault zone to the project area is the Wabash Valley Seismic Zone, which is located along the Illinois and Indiana border, approximately 150 miles southeast of the energy center and 180 miles southeast of the CO₂ storage study area. The New Madrid Fault Zone, which has been the source of magnitude 7.0 or greater earthquakes in the central United States, is located approximately 210 miles south of the energy center and the CO₂

storage study area. Historically, earthquakes from either of these two fault zones have not caused damage in central Illinois.

To identify past earthquakes that could have been felt at the project sites, USGS earthquake records were searched in a 30-mile radius around the FutureGen 2.0 Project areas. Since 1973, when the USGS and other government agencies started monitoring seismic activity in the United States, no earthquakes have been recorded within 30 miles. However, historical documents show that at least two earthquakes occurred within the seismic ROI before the start of seismic monitoring. One earthquake occurred approximately 15 miles northeast of the CO₂ storage study area and 37 miles northeast of the energy center, just outside of Petersburg, Illinois. The earthquake occurred on November 10, 1923, with an estimated magnitude of 3.3 (Stover et al. 1984). Another earthquake occurred on July 19, 1909, with an estimated magnitude of 4.5. This earthquake occurred approximately 26 miles directly north of the CO₂ storage study area, and 40 miles northeast of the energy center (Stover et al. 1984). These earthquakes were also the closest reported earthquakes to the Meredosia Energy Center.

Through the National Earthquake Hazard Reduction Program, the USGS has generated a geologic seismic hazard probability database to estimate the potential for earthquakes in the United States. The database is built from data on known fault sequences and historical earthquake data. Models generated from the database show the probability of a damage-inducing earthquake at a location. According to this data, there is less than a 1 percent chance that a magnitude 5.0 or greater earthquake would occur within 30 miles of the FutureGen 2.0 Project in the next 50 years (USGS 2012a) for any of the areas proposed for the construction and operation of the proposed project. This is the lowest probability rating for the model. For shaking hazard potential in the next 50 years, there is a 2 percent probability of exceeding a peak horizontal acceleration of 8 to 10 percent of the gravity coefficient (USGS 2012b). Peak horizontal acceleration of 10 percent of the gravity coefficient is considered capable of minor structural damage in normal buildings. These model results show that the Morgan County area is considered part of the tectonically stable section of North America (see Figure 3.4-3).

Economic Mineral Resources

In Illinois, oil and gas deposits were initially discovered in the early 1860s. The most productive oil and gas formations, deposited in the Mississippian to lower Pennsylvanian epochs, are generally absent in Morgan County. Three gas fields are located along the eastern edge of the county. The Prentice field is located south of Ashland and has 25 oil and gas wells that were drilled in the 1950s and 1980s. Oil and gas from the Prentice field has been produced from small stratigraphic traps in the shallow Pennsylvanian formations (e.g., Spoon-Carbondale), at depths of 250 to 350 feet bgs. As of 2009, there were no producing wells, and many of the wells in the field have been plugged, although at least one well was drilled to 279-foot horizon in 2012 (ISGS 2012b). The Jacksonville field is located directly east of the city of Jacksonville, and contains more than 75 wells drilled between 1900 and 1984. The wells were drilled between 350 and 500 feet deep, primarily to the Pennsylvanian bedrock. The field was first discovered in 1910 and had produced a total 10,400 barrels by the end of 2009. As of 2009, there were three producing wells (ISGS 2012b).

The Waverly field natural-gas storage site in the southeast corner of Morgan County originally produced oil from a structural trap in Silurian carbonates called the Waverly Dome. The field no longer produces oil, but the field has been used for natural gas storage since around 1954 (Alliance 2013a).

The Herrin, Springfield, and Colchester coal-bearing formations are present in the southern portions of Morgan County; however, they are very thin or absent in the project area. Movable subsurface coal deposits are found to the southeast of the CO₂ storage study area, with the closest active mine located 10 miles away.

Three closed sand pits are located on either side of Interstate (I-) 104, on the west bank of the Illinois River. The farthest sand pit is located about 625 feet north of the highway, while the other two pits are

located 160 and 380 feet south of the road. Aerial photos show that excavation likely started around 1939, but by 1956, the pits were overgrown and no longer used (ISGS 2011c).

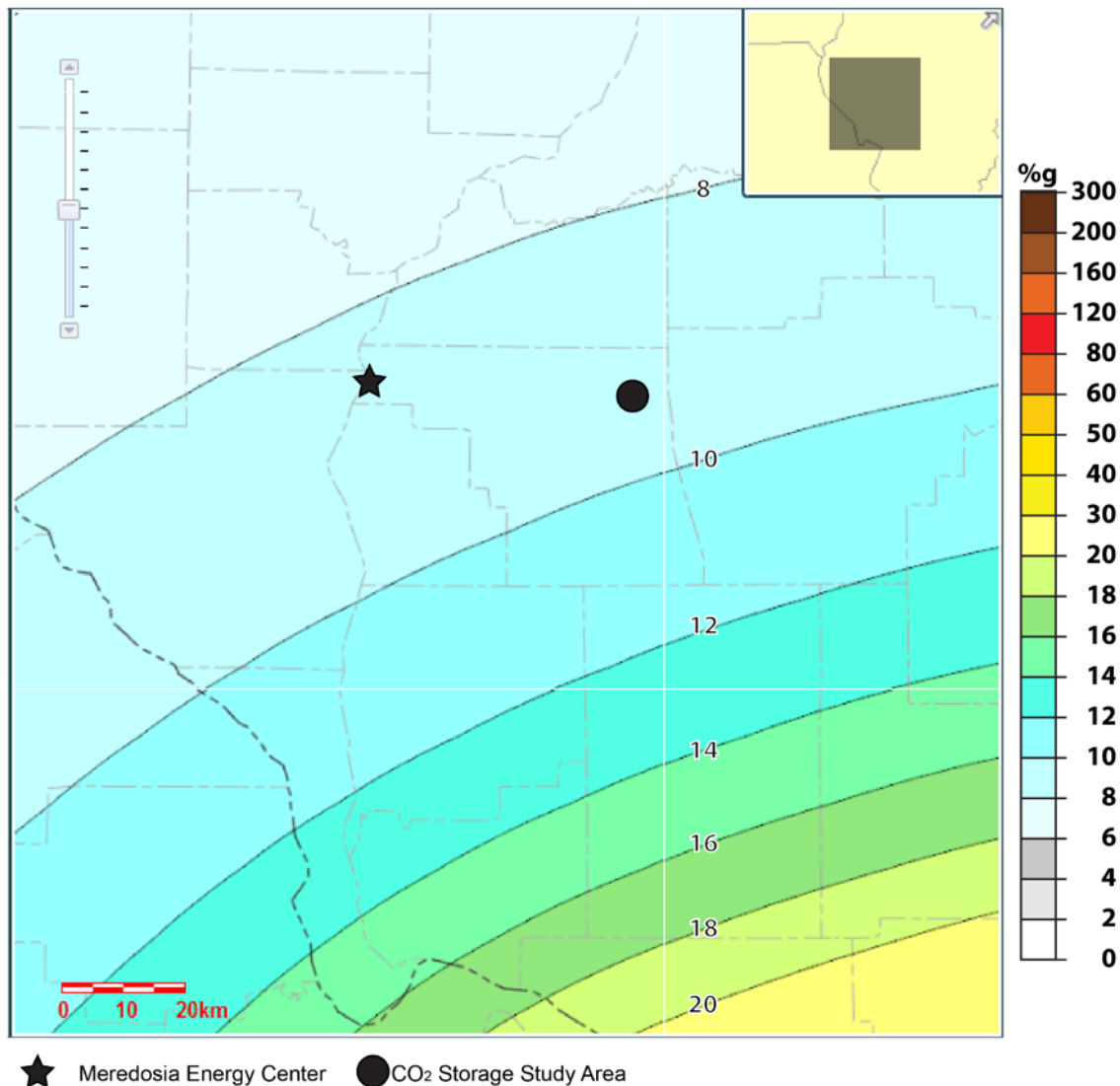

Source: USGS 2012b

%g = peak horizontal acceleration as a percent of the gravity coefficient

Figure 3.4-3. Peak Horizontal Acceleration Values (as %g) with a 2 Percent Probability of Exceedance in 50 years

3.4.2.2 Meredosia Energy Center

The Meredosia Energy Center is located within the Illinois River valley. The topography at the energy center is very flat up to the riverbank, which then drops about 20 feet to the Illinois River. The Cahokia Formation is the primary surficial deposit at the Meredosia Energy Center. The bedrock at Meredosia is buried beneath the glacial and river sediments. The shallowest formations at the energy center are the Meppen Limestone, the Fern Glen Formation, and the Burlington-Keokuk Limestone.

3.4.2.3 CO₂ Pipeline

The CO₂ pipeline to the CO₂ storage study area would initially cross deposits of the Cahokia Formation, then the Glasford Formation, which is covered by the Peoria Loess. The CO₂ pipeline would also cross

several bedrock formations. Starting at the Meredosia Energy Center, the proposed CO₂ pipeline would initially cross the older Mississippian formations (e.g., Burlington-Keokuk Limestone), then the Warsaw-Chouteau limestone, in the central section of the corridor. The final approach of the CO₂ pipeline corridor to the CO₂ storage study area crosses the Spoon-Carbondale Formation and undifferentiated Middle Pennsylvanian bedrock.

3.4.2.4 CO₂ Storage Study Area

The surficial geology for the CO₂ storage study area consists of the Glasford Formation, which is approximately 75 to 100 feet thick and covered with 10 to 15 feet of loess deposits. The topography at the CO₂ storage study area gradually slopes towards stream channels that drain to the Illinois River to the west. The Spoon-Carbondale Formation is the bedrock formation that occurs beneath the glacial deposits.

CO₂ would be injected into the Mt Simon Formation; however, the injection zone for the FutureGen 2.0 Project is comprised of both the Mt. Simon Formation and the Elmhurst Member of the Eau Claire Formation (see Figure 3.4-2). The Mt. Simon has several characteristics that are beneficial for CO₂ storage; it is consistently deep (over 3,900 feet), laterally continuous, and a relatively permeable formation that is bounded by several impermeable layers. At the CO₂ storage study area, the Mt. Simon is approximately 500 feet thick, located at approximately **3,900** feet bgs to **4,400** feet bgs. The formation thickness gradually increases towards the east and can be found in outcrops throughout the midwestern and eastern states (Bowen et al. 2011). The Elmhurst Member is 66 feet thick. The total thickness of the injection zone (including both the Mt. Simon Formation and the Elmhurst Member) at the CO₂ storage study area is 565 feet.

In January 2011, the Alliance performed a two-dimensional seismic survey on public roads throughout the CO₂ storage study area. The profiles show a thick sequence of the Mt. Simon Sandstone with no visible faulting (Alliance 2013a). In addition, the Alliance measured the permeability and porosity of the formations in the stratigraphic well. The measurements confirm that the confining zone has much lower permeability and porosity levels than the injection zone, as measured at other sites (Griffith et al. 2011; O'Connor and Rush 2005).

The **horizontal** permeability for the injection zone ranges from **less than 0.1 millidarcies** to **300 millidarcies**, with lower values at the contact with the metarhyolite basement, then gradually increasing in the center of the Mt. Simon, then starting to decrease again as it grades to the Elmhurst member (Alliance 2013a). **The vertical permeability in the injection zone ranges from less than 0.1 millidarcies to 400 millidarcies and varies between each of the depositional layers of the injection zone.** The porosity in the injection zone ranges from 5 to 20 percent, with the greater porosity in the middle of the Mt. Simon (Alliance 2013a). The permeability and porosity ranges measured in the stratigraphic well were similar to those used in the early plume modeling analysis of the Mt. Simon Formation, which used a horizontal permeability of 37 to 417 millidarcies and porosity of 9.6 to 17.1 percent.

The Mt. Simon Formation is confined between metarhyolite at its base and the Proviso and Lombard Members of the Eau Claire Formation. These two upper members of the Eau Claire Formation make up the primary confining zone (caprock formation) and are located between **3,838** and **3,425** feet bgs. Together the Proviso and Lombard Members comprise 413 feet of low porosity and permeability caprock. The members have been correlated to layers in Pike County, and have been successfully used as confining layers for 38 natural gas storage reservoirs across Illinois (Alliance 2013a). The permeability values decrease from the base of the Lombard upwards through the Proviso, which mirrors the decreasing amount of silt found in the Eau Claire Formation (Alliance 2013a). The Proviso **horizontal** permeability ranges from 0.0001 millidarcies to **0.1 millidarcies**. Permeabilities of the Lombard member range from **0.0001** millidarcies to **9** millidarcies. The porosity for the Lombard member is between 5 and 10 percent, with greater porosity at the base of the formation. The Franconia Dolomite is located from **3,286** and **3,072** feet bgs, and forms a secondary confining zone. The formation is comprised of low-permeability shale and silty dolomite.

The deepest USDW at the CO₂ storage study area is the St. Peter Formation, which is about 200 feet thick and occurs at approximately 1,740 feet bgs. It is located approximately 1,480 feet above the Proviso Member of the Eau Claire. A USDW is an aquifer that is used or could be used to supply drinking water. Section 3.5, Groundwater, provides additional detail on the presence of USDWs in the CO₂ storage study area.

There are several wells located within the UIC survey area, including 24 water wells, which are typically drilled within the first hundred feet of the surface. The use and location of these wells are described in Section 3.5, Groundwater. The discovery of three oil and gas fields in Morgan County surrounding the CO₂ storage study area in the early 20th century resulted in exploratory wells being drilled in the area, including the UIC survey area. None of the oil and gas fields is located within the survey area, although the Prentice gas field and Jacksonville field are located within a mile of the survey area boundary (2,500 feet east and 3,000 feet south, respectively). The Waverly field is located about 13 miles south of the UIC survey area boundary. There are 22 oil, gas, gas storage, and research wells within the survey area (see Figure 3.4-4). Table 3.4-1 presents the well types, range of depths, their purpose, and the status as logged with the Illinois State Geological Survey. Most of these wells were drilled to investigate the presence of coal, gas, or oil and were plugged or abandoned afterwards. At the CO₂ storage study area, the top of the Eau Claire Shale (the primary confining formation) is 3,425 feet bgs, which is well below the deepest oil and gas well.

Table 3.4-1. Coal, Oil, and Gas Wells Located in the UIC Survey Area

Well Type	Number	Depths (feet bgs)	Purpose	Status
Coal Test	6	130-318	Exploration	Abandoned
Oil and Gas	2	334-342	Gas production	Gas producer
Oil and Gas	5	200-402	Exploration	Dry and Abandoned
Oil and Gas	4	324-420	Exploration	Dry, No Shows, Plugged
Oil and Gas	2	1,205-1,530	Exploration	Dry and Abandoned
Oil and Gas	1	1,400	Exploration	Junked and Abandoned, No Shows, Plugged
Stratigraphic	1	814	Structure Test	Plugged
Unknown/other	1	347	Unknown	Plugged

Source: ISGS 2012b
 bgs = below ground surface; UIC = Underground Injection Control

3.4.2.5 Educational Facilities

The educational facilities are expected to be located in or near Jacksonville, Illinois, in Morgan County. The geology of this general area is similar to that described for the CO₂ pipeline corridor and CO₂ storage study area in Morgan County, as discussed above.

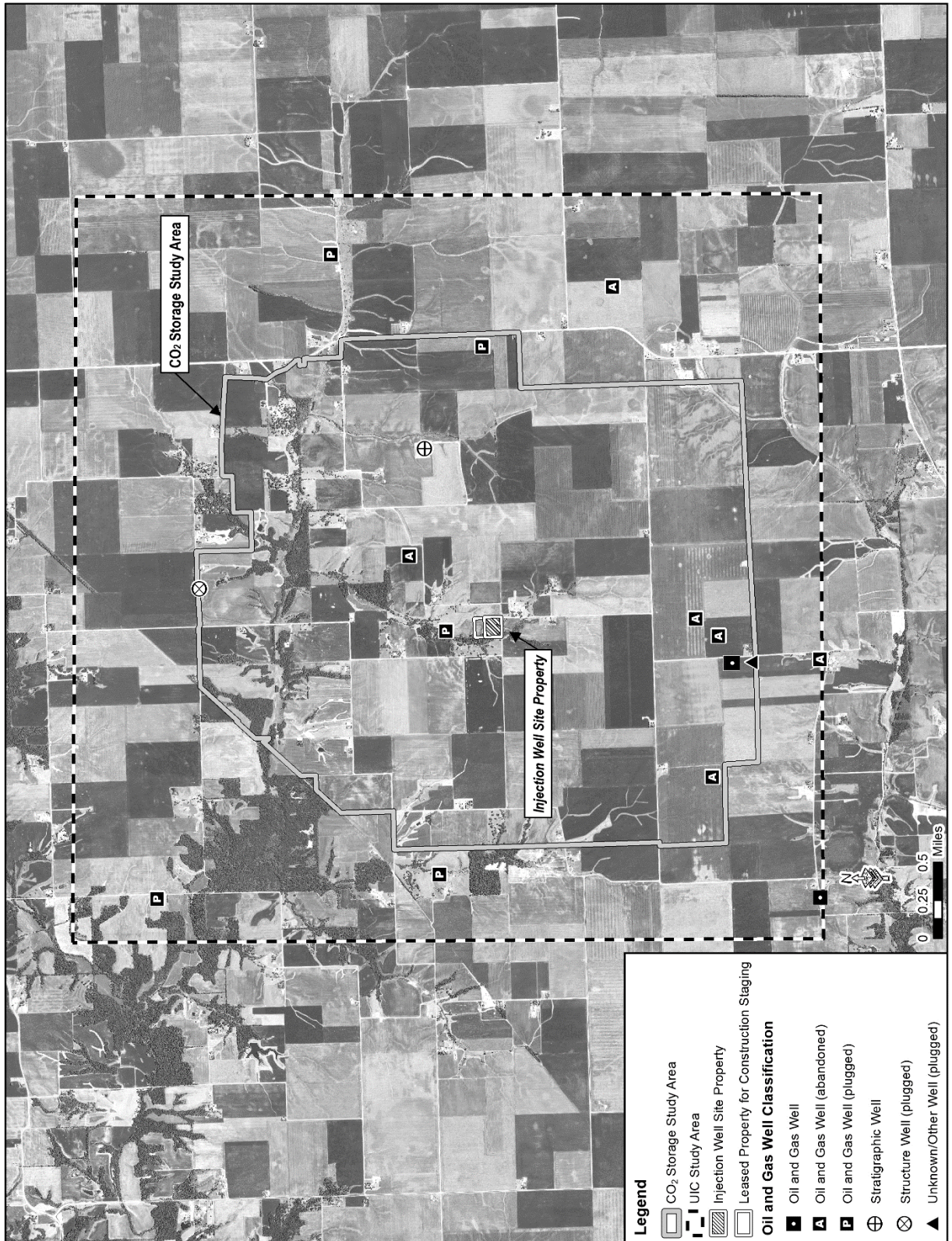

Source: ISGS 2012b

CO₂ = carbon dioxide; UIC = Underground Injection Control

Figure 3.4-4. Oil, Gas, and Gas Storage Wells in the Underground Injection Control Survey Area

3.4.3 Impacts of the Proposed Action

This section analyzes the potential for impacts based on the criteria listed in Section 3.4.1.2 and the affected environment information found in Section 3.4.2. Impacts resulting from increased soil erosion or groundwater contamination (including potential contamination of USDWs) are discussed in Section 3.3, Physiography and Soils, and Section 3.5, Groundwater, respectively.

3.4.3.1 Construction Impacts

Meredosia Energy Center

Construction of proposed project components at the energy center would have negligible impacts on the local geology. The major equipment at the Meredosia Energy Center would be constructed on deep foundations, which would provide additional stability for the structures. Construction would primarily occur on previously disturbed land at the Meredosia Energy Center site, so construction would not affect geologic resources unique to the region. Activity during construction would not induce seismicity in the area, and the flat topography would preclude impacts from landslides or subsidence. There are no coal beds or oil and gas deposits in the area, so no economic minerals would be affected by the construction at the Meredosia Energy Center.

CO₂ Pipeline

Construction of the CO₂ pipeline would occur at a depth of at least 4 feet in loess and glacial till. The Alliance does not anticipate that any blasting would be required for the pipeline installation. Due to the overall low topographic relief of the terrain that would be crossed by the pipeline corridor, construction of the pipeline is not expected to require any stabilization efforts to ensure that landslides or ground instability would not be induced as a result of construction. As needed, standard construction practices and BMPs used in the pipeline construction industry, as described in Section 3.3, Physiography and Soils, would be implemented to minimize the potential for construction to result in locally induced ground instability. Pipeline construction procedures would also follow IDOA guidance, which would ensure safe storage of topsoil and proper restoration of the surface topography (**Appendix H, Agricultural Mitigation**). There would be no impact to the local geologic resources from construction of the pipeline, because the construction would only temporarily disturb the glacial deposits, which would be replaced once construction is completed.

For the portion of the pipeline that would extend into the CO₂ storage study area, the impact analysis in the Draft EIS used hypothetical end-of-pipeline spurs to evaluate a range of reasonable siting scenarios (see Section 3.0). **Since the release of the Draft EIS, the Alliance identified the proposed location for the injection well site (see Section 2.5.2.3) and established pipeline routing within the CO₂ storage study area for the southern route to the proposed injection well site. Since the Alliance does not plan to move forward with the northern pipeline route, final routing within the storage study area was not identified for the northern route to the injection well site. The pipeline route could ultimately deviate as a result of final project design and coordination with landowners; however, the same siting criteria would be followed and impacts would be consistent with those addressed in this section.** The impacts to the geology from construction of the pipeline within the CO₂ storage study area would be negligible, similar to the impacts for the rest of the CO₂ pipeline, as described above.

The project is located in a relatively low risk zone for earthquakes, with no major or mapped faults within or near the proposed CO₂ pipeline. Based on these conditions, there is minimal potential for geologically related impacts to occur either to the proposed pipeline or to geologic resources during pipeline construction.

CO₂ Storage Study Area

Construction of the injection wells in the CO₂ storage study area would have a negligible impact on the local geology. Up to 4 injection wells and 12 deep and shallow monitoring wells would be constructed at the CO₂ storage study area. **The existing stratigraphic well would be converted for use as a single-**

level monitoring well for the injection zone. Construction of the wells would remove some bedrock, although the amount would be negligible and not unique to the region. Drilling and installation of the injection wells would not induce seismicity, nor would it cause landslides or subsidence. **The Alliance submitted the UIC Class VI permit applications to the USEPA in March 2013 and is working with the USEPA to complete the permitting process.**

Under the dual-site scenario analyzed in the Draft EIS and no longer under consideration by the Alliance, the injection and monitoring wells and associated infrastructure and buildings would be constructed on a maximum of **28** acres within the CO₂ storage study area. An additional 64 acres would be utilized to support construction of access roads. Under the Alliance's currently proposed single-site scenario, 42 acres would be required to support construction activities. Local fill may be required during the grading process; however, the use of materials would not reduce the overall availability of the gravel and other fill. As a result, the construction of the facilities would have a negligible impact to the local geologic resources.

Educational Facilities

The educational facilities would be located in or near Jacksonville, Illinois. The Alliance would either renovate existing structures or build new facilities. In either case, the construction activities would have a negligible impact on geologic resources.

3.4.3.2 Operational Impacts

Meredosia Energy Center

Impacts to geologic resources from the operation of the oxy-combustion facility at the Meredosia Energy Center would be negligible and limited to areas of soil-related impacts, as discussed in Section 3.3, Physiography and Soils. No onsite or nearby geologic resources (e.g., valuable gravel or clay or other deposits) are known to exist that could be impacted by operation of the facility. Operation of the oxy-combustion facility would not be expected to result in seismic effects that could lead to damage of structures or facilities; result in impacts to, or render inaccessible, any unique geologic resources; or result in displacement of the ground surface.

CO₂ Pipeline

There would be negligible impacts to geologic resources from the operation of the proposed CO₂ pipeline. Pipeline repairs or maintenance may be required during operation; however, these activities would only disturb surficial and near-surface soils that were previously disturbed during construction of the pipeline. Operation of the pipeline would not be likely to result in any seismic effects that could damage structures; result in destruction of high-value or unique geologic resources; render any such resources inaccessible; or cause displacement of the ground surface.

CO₂ Storage Study Area

During operations, CO₂ would be injected into the Mt. Simon Formation through up to four injection wells located in the CO₂ storage study area. **Since the release of the Draft EIS, the Alliance identified the proposed location for the injection well site using the results of plume modeling, the characterization activities, and the siting criteria detailed in Section 2.5.2.1.** The Alliance would operate the injection wells under the UIC Class VI permits issued by the USEPA, which would include the procedures and practices for CO₂ injection and monitoring.

The Alliance evaluated several injection well configurations using both vertical and horizontal injection wells at one or two injection well sites. After consideration of site-specific data from the stratigraphic well, the Alliance is currently proposing to operate up to four horizontal injection wells at one injection well site for the annual injection of 1.2 million tons (1.1 million metric tons) of CO₂ over a 20-year period. Under normal operating conditions, **64** percent of the CO₂ flow would be split equally between two of the wells while the remaining two wells **would receive 17 and 19 percent of the flow.** The injection wells would be constructed to provide operational flexibility and backup capability, such that

one well could be taken off line while the remaining three injection wells receive 100 percent of the flow. The horizontal injection would occur along the final 1,500 to **2,500** foot section of each injection well, allowing the CO₂ to infiltrate through a single horizon within the Mt. Simon Formation at about 4,030 feet bgs. Over the course of the injection period, the individual CO₂ streams from each of the four wells would merge to form a combined plume.

The Alliance conducted modeling using the Subsurface Transport Over Multiple Phases (STOMP)-CO₂ computer program to predict the areal extent and distribution of the CO₂ plume for the proposed injection well configuration. Data from the stratigraphic well, as well as data collected from hydrologic testing, wireline logging, and vertical seismic profiling, was used to support the modeling effort. **The formations within the injection zone and confining zones were modeled as horizontal layers that simulated the hydrogeologic characteristics of each formation.** The Alliance used multiple variables to model the formation (e.g., vertical and horizontal permeability and porosity, rock and grain density, capillary pressure) and the reservoir (e.g., temperature, fluid pressure, salinity), combined with the injection stream values (pressure, saturation) to determine the lateral extent of the plume after 20 and 70 years. The Alliance ran the model to determine the maximum extent of the plume, the time period of pressure buildup and drop off, and a sensitivity analysis to determine the most significant parameters for determining plume size (i.e., fracture gradient and porosity). Appendix G, Geological Report, contains the technical report detailing the model's inputs, assumptions, and outputs. As shown in Figure 2-26, the plume model predicted that the CO₂ plume would occupy a subsurface area of approximately 4,000 acres within the CO₂ storage study area.

The first step to safely manage the injection and storage of CO₂ is the selection of a site with characteristics that make it suitable for the long-term storage of CO₂. The USEPA has outlined a set of siting requirements to ensure that site proponents demonstrate that there is a viable injection zone and a separate, competent confining zone (caprock formation) at the project site (USEPA 2013b; 75 FR 77230). The Mt. Simon Formation is an ideal target for sequestration, as research has shown that it contains the characteristics that support long-term storage of CO₂ (Zhou and Birkholzer 2011; DOE 2011a; Griffith et al. 2011; NETL 2012a). At the CO₂ storage study area, the Mt. Simon Formation is located over 3,900 feet bgs and is laterally continuous and about 500 feet thick, as described in Section 3.4.2 and shown in Figure 3.4-2. It is capped by members of the Eau Claire Formation, which consists of 400 feet of siltstone and shale layers. Brine aquifers in sandstone formations that formed in braided fluvial environments, such as the Mt. Simon Formation, are believed to be ideally suited for fluid storage, because the shale lenses in the sandstone allow the plume to spread and react with the brine before reaching the caprock formation (Berger et al. 2009). These characteristics are particularly evident in the transition between the Mt. Simon Formation and the Elmhurst member of the Eau Claire.

There are several geologic resource impacts that could occur as a result of the injection and storage of CO₂. These impacts could include:

- CO₂ migration out of the injection zone and into a USDW;
- Earthquake generation;
- Ground surface displacement; and
- Increased human exposure to radon gas.

DOE expects adverse impacts to geologic resources to be unlikely and negligible to minor for a variety of reasons that are addressed in the remainder of this section. Although CO₂ sequestration technology is still evolving, injection regulations, site selection methods, industry BMPs, and additional mitigation procedures would minimize the potential for impacts.

CO₂ Migration

As supercritical CO₂ is injected into a deep saline formation, the brine (saline groundwater) is displaced and flows away from the injection wells through the interconnected pore space. Because the injected CO₂ is less dense than the surrounding groundwater, buoyancy causes the CO₂ to rise within the injection formation to lower-pressure zones until it is stopped by laterally extensive impermeable layers (e.g., the caprock layer or confining zone). Generally, as CO₂ filters through the formation, it starts to slowly mix and dissolve with the brine, creating a denser, mildly acidic solution. However, if a pathway exists between the injection zone and the shallower formations that overlie the confining zone, CO₂ could migrate vertically from the injection zone into shallower bedrock formations. This can occur if there are faults or fractures in the caprock seal or if the CO₂ pressure exceeds the capillary pressure of the caprock. In addition, a leak could occur if the injected CO₂ finds a pathway through a more permeable zone within the caprock (Griffith et al. 2011). CO₂ could also migrate upward along improperly sealed injection well casings, or improperly abandoned wells that penetrate the caprock. Given the site investigation and characterization undertaken by the Alliance and studies that have been conducted by the Illinois State Geologic Survey over many years, the existence of unknown faults, fractures, or wells within the CO₂ storage area is highly unlikely.

CO₂ is trapped in the injection zone by four primary mechanisms: (1) structural trapping, (2) residual CO₂ trapping, (3) solubility trapping, and (4) mineral trapping. These trapping mechanisms are dependent upon the physical and chemical properties of the CO₂ and the injection zone. Figure 3.4-5 shows the comparative effectiveness and time delay for the different types of trapping mechanisms. Mechanisms that take longer to occur (solubility trapping, mineralization) are also more effective for long-term trapping (Liu and Maroto-Valer 2011). Structural trapping is the retention of the injected CO₂ by a physical barrier (the impermeable caprock). Residual CO₂ trapping (or hydraulic trapping) occurs as the formation acts like a sponge, capturing CO₂ in the pore spaces. The effectiveness of residual trapping is dependent upon the permeability and porosity of the injection zone. Solubility trapping occurs when CO₂ dissolves in the brine, forming a liquid that is denser than the host brine. The dissolved CO₂ and brine may sink in relation to the surrounding brine. Mineral trapping occurs when the injected CO₂ reacts with minerals in the brine or the formation to form carbonate minerals. In the Mt. Simon Formation, carbonate minerals that could be formed through mineralization would include iron carbonate precipitates. The presence of feldspar in the Mt. Simon Formation may enhance mineral trapping (Alliance 2013a).

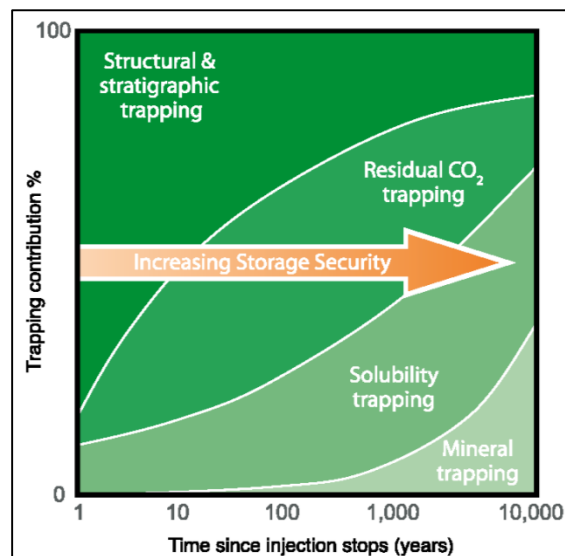

Source: IPCC 2005

Figure 3.4-5. Effectiveness of Trapping Mechanisms Over Time

The Mt. Simon Formation contains lenses of shale within the sandstone layers, which would likely increase the storage capacity of the formation by forcing the CO₂ to move laterally as its buoyancy causes it to migrate upward (Ambrose et al. 2008; Bowen et al. 2011; Zhou et al. 2010). This would provide additional exposure to brine and pore space, which would improve the potential for long-term trapping of CO₂.

As part of the site selection and UIC permitting process, the Alliance performed seismic studies and modeling to determine how the Mt. Simon, Eau Claire, and overlying formations are draped over the

metarhyolite basement and whether any local fracture or fault systems intersect the confining zone. The studies found no indications of faults or tectonic fracture zones in the bedrock layers and it is unlikely that any undetected faults or fracture zones are critically stressed (Alliance 2013a). While there is no evidence of vertical fractures or fissures in the shallow subsurface in the CO₂ storage study area, some of the well logs indicated that karst zones may be present in some of the dolomite formations around 1,600 feet bgs. These zones are encased within carbonate units with low permeability, located over 1,500 feet above the primary confining layer (caprock) (Alliance 2013a). It is very unlikely that CO₂ could reach these dolomite formations because the primary confining zone would inhibit the upward migration of CO₂. The secondary confining zone and several layers of dense, low permeability dolomite would also impede upward migration.

A review of the drilling records of existing water, oil, and gas wells in the UIC survey area determined that the only well penetrating the injection zone is the stratigraphic well drilled by the Alliance in 2011. This well, which would be used as a deep monitoring well, was specifically designed to be resistant to brine acidification by CO₂, and has been cemented with CO₂-resistant cement to prevent upward CO₂ migration. The next deepest well was drilled to 1,530 feet bgs, well above the injection zone. Therefore, it is very unlikely that CO₂ would migrate up through existing well bores or abandoned wells, because it would first have to escape from the primary and secondary confining zones to reach the next deepest well.

CO₂ migration up the injection well bores is a potential threat to containing CO₂ in the Mt. Simon Formation. The Alliance would design and construct the injection wells by following CO₂ injection well BMPs, using CO₂-resistant cement to construct the injection wells within the injection zone, and cementing each string casing up to the surface (see Figure 2-24 and Figure 2-25) (NETL 2013b). A CO₂-resistant cement that is specifically designed to prevent casing degradation from contact with the acidic brine would be used in the production casing where it crosses the injection and primary confining zones. A corrosion inhibited potassium chloride brine, or similar fluid, would be used in the space between the pipe (tubing) that delivers the CO₂ into the well and the well casing (annular space) (see Figure 2-24 and Figure 2-25). To prevent the CO₂ from infiltrating the annular space, the packer assembly, which secures the well tubing and separates the annular space from the perforated section of the well, would be maintained at a pressure sufficient to contain the injected CO₂. The packer assembly would be designed for an estimated pressure differential of 500 pounds per square inch (psi), including a factor of safety. Prior to injection, extensive testing would be conducted on the injection wells to ensure the integrity of the tubing, annular fluid and cemented casings. For example, pressure testing, wireline logging, and mechanical integrity testing, would be performed to ensure that the casing can withstand the injection pressures and that the cement has cured properly.

Acidic brine solution can also dissolve minerals, which could increase the salt and heavy metal concentration in the brine. However, models have shown that the quartz-rich Mt. Simon Formation would tend to be resistant to acid dissolution (DOE 2007a). As a result of the BMPs and design elements that the Alliance would execute in the design and construction of the injection wells, the leakage of brine from the injection zone up through the well casing is considered unlikely, and as a result, impacts to geologic resources from vertical brine leakage would be considered negligible to minor.

In general, brine from the injection zone that is displaced by the injected CO₂ can migrate from the point of injection either vertically (potentially up through the confining zone) or laterally (Zhou et al. 2010). The injection of CO₂ would displace brine and increase the pressure within a portion of the injection zone, gradually decreasing with distance from the injection wells. For UIC permitting purposes, the pressure front is defined as a zone of elevated pressure, where the pressure differential is sufficient to cause movement of CO₂ or brine into a USDW (USEPA 2013c). Models that simulate the increased pressure from CO₂ injection have been used to investigate the potential for brine migration and have shown that while the confining zone does prevent vertical CO₂ migration (provides structural trapping), the pressure front can be strong enough to force small amounts of brine from the injection zone into shallower formations (Birkholzer et al. 2009; Lemieux 2011). This process would occur over tens of

years, as the displaced brine is first forced into the Mt. Simon pore space before it can migrate vertically (Zhou et al. 2010). If the brine does pass through the caprock and reaches a shallower (less than 3,500 feet bgs), permeable formation, it would likely also spread laterally within the formation, slowing its vertical migration. The temperature and density differential between the injection zone brine and the shallower formation would cause the dense brine to stay within the lower-most region of the formation. Birkholzer et al. (2009) determined that vertical brine migration through a sequence of layers into shallow aquifer bodies (e.g., USDW), would be extremely unlikely. Brine could migrate with CO₂ through permeable pathways through the caprock; however, as mentioned above, the project site selection would minimize this potential effect. Overall, the impact from brine migration would be minor because it would be extremely unlikely that it would reach the deepest USDW.

Brine in the injection zone can also be displaced laterally, although the models show that the lateral movement would be slow and not much faster than the natural groundwater flows in deep saline aquifers, on the scale of inches over hundreds of years (Birkholzer et al. 2009; Zhou et al. 2010). For the Mt. Simon, this means there is no potential for displaced brine to migrate up-dip (i.e., towards the northeast) to the potable Mt. Simon aquifers in the northern Illinois Basin. The closest potable Mt. Simon aquifer is over 50 miles away (Zhou et al. 2010; Brower et al. 1989). Because the displaced brine would remain within the vicinity of the CO₂ storage study area, the impacts from up-dip brine migration would be negligible.

Ongoing monitoring and modeling would serve as an important means of reducing the potential for impacts to geological resources from the proposed project. The plume modeling conducted by the Alliance, as discussed earlier, projects that injected CO₂ would remain within the CO₂ storage study area and remain stable after 70 years (see Figure 2-26). The Alliance ran the plume model for over 300 years to determine the greatest extent of the aerial plume and the peak pressure differential within the formation. Although the plume does change slightly throughout the modeling period, the variation from the maximum plume extent becomes insignificant after the injection period. The pressure differential also peaks at the end of the injection period, but slowly dissipates to 90 percent of the peak within the first 100 years of injection (Appendix G, Geological Report).

As part of the proposed CO₂ MVA program, the Alliance would conduct monitoring to detect migration of injected or displaced fluids, should migration occur, so that potential long-term impacts to geologic resources may be minimized or avoided (e.g., by correcting deficiencies in well construction, adjusting injection and production rates or locations, or other appropriate mitigation strategies). While some of the monitoring would be required by the Class VI injection regulations, the Alliance is also planning to use additional monitoring techniques for research purposes. A preliminary CO₂ monitoring program is summarized at the end of this section and **has been** described in the MVA plan that **was** submitted with the UIC permit applications. Considering the proposed mitigation measures (i.e., the well integrity testing program and the CO₂ monitoring and verification program) and the low probability of CO₂ leakage from the injection zone, potential impacts related to migration of injected and displaced fluids through improperly sealed wells or unknown faults or fracture pathways are expected to be negligible to minor.

Induced Seismicity

The expanding use of pressurized fluids in hydraulic fracturing and wastewater injection has increased the visibility of human-induced seismic effects in energy projects (NRC 2012; Ellsworth et al. 2012; Suckale 2010). DOE recognizes the public's interest in human-induced seismicity from geologic sequestration, as CO₂ would be injected into a saline aquifer within a sandstone formation deep within the earth's crust. The remainder of this section addresses the potential for the project to induce seismicity based on currently available information.

A report produced in 2012 by the National Research Council (NRC 2012) summarized the latest research into induced and triggered earthquakes as a by-product of energy production, which includes carbon sequestration. Currently running projects, such as the Sleipner field in Norway, the In Salah gas field in

Algeria, and the Illinois Basin-Decatur Project (by the Midwest Geological Sequestration Consortium) in Decatur, Illinois were used to characterize the potential risk of seismic events from the injection of CO₂. The report notes that no harmful seismic events have been connected with any of these projects, although their injected volumes are still considered small-scale (NRC 2012). From the review of seismic events from other injection-related energy technologies (e.g., geothermal, enhanced oil recovery, wastewater injection), the National Research Council identified an apparent correlation between the net fluid balance (difference between the amount of fluid injected and withdrawn) and the maximum magnitude of seismic events at an injection well. However, this analysis is extremely site-specific, and the report notes that it cannot be used to predict earthquake magnitudes for an entire region or industry. In areas that are already predisposed for faulting and earthquakes, the combination of increased pore pressure and potential hydrochemical-mechanical effects of liquid CO₂ in saline formations could increase the potential for seismic risk on induced or triggered earthquakes. This risk could be mitigated through lowering the fluid viscosity, using lower injection pressures, and implementing site-specific limits to permanent pressure change within the injection zone. Ultimately, the National Research Council determined that there is not enough large-scale data to accurately analyze the seismic risks from geologic sequestration, and that additional test projects would be needed to expand the knowledge base. Data gathered from operating the FutureGen 2.0 injection wells would be used to help further the overall research in this area.

There are three types of seismic events that could be caused by subsurface fluid injection: microseismic, induced, and triggered seismicity. Microseismic events are low-intensity (too small to be felt by humans, magnitude less than 2) seismic occurrences that occur when the host formation is fractured by injecting large quantities of fluid under high injection pressures (NRC 2012; IPCC 2005). Hydraulic fracturing uses this method to increase formation permeability when extracting natural gas. An induced seismic event occurs when the increase in pore pressure introduces large changes to the local stress field and reactivates an existing fault. A triggered seismic event would occur if the CO₂ or migrating brine reduced the friction along a fault line, which reduced the amount of stress needed to generate an earthquake. In theory, a triggered seismic event could happen without being influenced by the injection pressures, while microseismic or induced events are unlikely to occur naturally (Oldenburg 2012).

As discussed above, an increase in pore pressure as a result of injection has been identified as a major factor in microseismic and induced seismicity. The pressure field would change three times during injection: (1) the early stage with little pressure interference, (2) an intermediate stage with transient changes between injection wells, and (3) a final stage in which the fields have intermingled and there was a continuous pressure buildup from the injection wells (Zhou et al. 2010). The pressure field could extend laterally for tens of miles, gradually decreasing with distance from the injection wells (Zhou et al. 2010). Pressure can be reduced over time as brine is displaced from its original location. Modeled studies of large-scale injection in the Mt. Simon Formation have projected that the formation can safely accommodate the pressure changes within the fractional pressure buildup thresholds deemed safe by natural gas entities in the region (Zhou and Birkholzer 2011).

Although there are no known faults or seismic-related structures at the CO₂ storage study area, the large CO₂ volumes that would be injected at the site could increase the potential for seismic activity, especially if they are not monitored and managed correctly. Excess pressurization at the injection wells could cause microseismic events (bedrock fracturing). The pressure response would depend on the boundary conditions of the injection zone. Each formation has a fracturing pressure threshold, where additional stress applied would cause the formation to fracture and cause microseismic events. Excessive injection pressure can also limit the storage capacity of a formation, as it represents the inability of the host brine and earlier injected CO₂ to move out of the way of the newly injected CO₂. The potential for microseismic events to occur can be limited during injection operations by maintaining the injection pressure below the fracturing pressure threshold for both the injection zone and confining zone formations. In the modeling that the Alliance conducted, a pressure gradient of 0.65 psi per foot was used. The injection zone would be between 4,000 and **4,400** feet bgs, for a calculated fracture pressure of 2,600

psi at 4,000 feet bgs and increasing to **2,860** psi at **4,400** feet bgs. Pursuant to the USEPA UIC Class VI regulations, the injection pressures must not exceed 90 percent of the fracture pressure in order to protect the confining zone and to prevent fractures from forming. The pressure constraint is required to maintain the CO₂ in a supercritical state during injection, while preventing fractures from forming in the injection and confining zone formations. As part of the MVA plan, the Alliance would monitor the injection pressure at the surface and within the formation to ensure that the fracture threshold is not exceeded, which would substantially reduce the risk for induced seismicity. By actively monitoring the injection and formation pressures, the Alliance would be able to adjust the injection rate to ensure that the injection pressures remain within the limits of the UIC permits, and therefore remain below the fracture threshold.

The primary method to prevent seismic events is through careful site selection during the planning process, and monitoring the CO₂ and formation pressures during injection. In cases where fluid injection has been positively attributed to small, triggered earthquakes, the earthquake foci were connected to mapped faults that were miles long (Frohlich et al. 2011). There are no mapped faults in the UIC survey area, and the Sangamon Arch is the only structural feature in Morgan County, which indicates that the stresses strong enough to cause visible faults and deform bedrock have not been present for hundreds of millions of years. In the subsurface seismic study of the CO₂ storage study area, no faults were found in the injection and confining zones. This suggests that induced or triggered seismic events would be very unlikely, as the seismic stability of the location and lack of faults would minimize the potential that the CO₂ or increased injection pressure could mobilize an existing fault. The impacts due to the increased potential for injection-induced events would be minor because the Alliance would follow the procedures in the injection plan to ensure that the maximum fracture pressure threshold is not exceeded in the injection or confining zone formations. The Alliance would also construct a multi-level monitoring well that would be designed to measure the pressures at several different layers above the caprock, and use it to help regulate the formation pressure during injection.

Surface Deformation

Injection of large quantities of fluid, such as supercritical CO₂, can cause small changes to the ground surface that can be measured by sensitive equipment, as seen in some oil and gas fields (McColphin 2009). Research at the In Salah CO₂ injection site in Algeria has shown that the ground surface around the injection site tends to rise when injection starts, and then starts to settle as injection tapers off (Onuma and Ohkawa 2009). At the In Salah gas field, the surface deformation occurred at a rate of up to 7 millimeters (0.3 inches) per year and was measured using radar technology from satellites. The rate also varied based on the well location, which may be related to the underlying bedrock structure (Onuma and Ohkawa 2009). Other technologies, including tiltmeters and differential global positioning system receivers can also be used to measure the changes, since the deformation is too small to be visually perceived (McColphin 2009). Measuring subtle surface changes can also be a cost-effective way to estimate the location of the CO₂ plume (NETL 2012b). As surface deformation is related to the plume size, any changes would occur close to the injection wells, and remain within the CO₂ storage study area. While surface deformation monitoring is not required under the UIC regulations, the Alliance is considering using a variety of technologies (e.g., tiltmeters or satellite surveys) in addition to the monitoring techniques outlined in the proposed MVA plan. The monitoring program that the Alliance would implement would ensure that any surface deformation is measured and monitored; therefore, impacts due to surface deformation are expected to be localized to the injection well site(s) and minor.

Radon

The USEPA has labeled Morgan County as an area that has a high potential for radon gas, which indicates a predicted average indoor radon level over 4 picocuries per liter (USEPA 1993). In Morgan County, the Illinois Emergency Management Agency (IEMA) has recorded 40 homes that were tested for radon, of which 28 (70 percent) recorded over 4 picocuries per liter of radon (IEMA 2012a). As a result, nine mitigation systems have been installed (IEMA 2012b).

If CO₂ were to escape the injection zone and increase pore pressures in the shallow unsaturated soil zone, it could potentially displace radon. As stated above, the potential for a leak from the injection zone is considered unlikely. As a result, the chance that CO₂ could leak from the injection zone and reach the shallow soil is considered to be highly unlikely, and any increase of CO₂ in the soil would not have a pressure great enough to displace radon gas. The monitoring procedures described below would identify any CO₂ migration before it reaches shallow soils and affects radon concentration at the surface; therefore, impacts resulting from the potential for increased exposure to radon gas are considered to be negligible.

Monitoring and Verification

Overall, the potential impacts from CO₂ leaving the injection zone would be minor, as the injection well site(s) have the characteristics needed for long-term carbon sequestration. The potential for impacts would be further reduced by implementing various monitoring and verification techniques to identify the CO₂ plume, detect CO₂ leaks, and monitor brine movement and formation pressure. This section addresses the monitoring technologies that could be implemented as part of the project to further reduce the likelihood of the impacts discussed above.

The UIC Class VI rule regulates CO₂ injection for sequestration, including the monitoring procedures that would be implemented in support of the proposed FutureGen 2.0 Project. The UIC Class VI rule requires the establishment and implementation of a monitoring program to demonstrate the integrity of the injection wells and monitor the location of injected CO₂. In addition, the program must be able to detect leaks and identify procedures for quickly implementing remediation activities in the event that an issue is identified. As part of the monitoring program, and at regular intervals, the Alliance would identify the CO₂ plume location during the operation and post injection periods to determine the movement of the plume boundary. Both the USEPA and NETL have provided guidance for designing and implementing a monitoring program that complies with the UIC Class VI requirements (USEPA 2013c; NETL 2013b; NETL 2012b).

The Alliance proposes to undertake five major types of monitoring: (1) mechanical integrity testing, (2) operational testing, (3) groundwater quality monitoring, (4) plume and pressure front monitoring, and (5) near-surface gas (soil and surface air) monitoring. Each of these types of monitoring would have its own timeline based on the status of the injection wells. Mechanical integrity testing would assess the reliability of the injection wells and would occur prior to injection, during the injection phase, and prior to well plugging. Injection monitoring would occur during injection and include analyzing the CO₂ stream; monitoring the rate, pressure, and volume of injection; and monitoring the well for corrosion. Groundwater monitoring would occur at set intervals before, during, and after the injection period by using a monitoring well network to assess groundwater quality and groundwater pressure at various depths. Pressure front monitoring would be used to track the pressure front and the CO₂ plume during and after injection and would be used to update the AoR after injection had ceased and the injection wells had been closed. Soil and air monitoring would involve the collection of air samples from the ambient area and from shallow soils above the injection zone to monitor for changes in concentrations of CO₂ that could indicate a leak.

The USEPA has suggested, but not required, that a suite of monitoring activities be implemented (USEPA 2013c) based on the characteristics of each site. Soil and gas monitoring may be required at the UIC Program Director's discretion, based upon site-specific characteristics and the potential that CO₂ could reach a USDW. The *Underground Injection Control (UIC) Program Class VI Well Testing and Monitoring Guidance* (USEPA 2013c) describes each monitoring requirement, the reason why it is included, and the applicable regulatory citation in greater detail. These monitoring technologies can also be used to support monitoring that would satisfy the GHG reporting requirements of CAA Subpart RR.

The Alliance **designed** a monitoring program to address all requirements of the UIC Class VI regulations and the Greenhouse Gas Reporting Rule. Monitoring would be conducted through each stage of the

project, including construction, operations, and post injection to identify and address any instance of well breakdown, CO₂ leak, or other adverse impacts. As part of the UIC Class VI permit applications, the Alliance **provided** an injection plan and post-injection MVA plan, which outlines the monitoring techniques that would be implemented to protect USDWs. The Alliance would reevaluate the AoR and MVA plan every 5 years (at a minimum) after the issuance of the UIC Class VI permits. This reevaluation would consider the volume of CO₂ injected during the previous 5 years, the pressure at which it has been injected, and the resulting CO₂ plume. Injection and monitoring procedures would be revised, added, or removed, or the duration of monitoring activities would be changed depending on the actions of the CO₂ plume. **Monitoring techniques that the Alliance proposed as part of the MVA plan are** summarized in Table 3.4-2. Additional monitoring activities may also be considered, but have not been included in the table. The Alliance would also report injection amounts to the USEPA annually, as required by the Greenhouse Gas Reporting Rule, by calculating the amount of CO₂ retained within the injection zone using a mass balance approach (USEPA 2010f).

The Alliance characterized the injection and confining zones and designed the injection wells to minimize the potential of a CO₂ release. If, however, an adverse event were to occur during construction or operation, the Alliance would deploy a variety of emergency or remedial responses, depending on the characteristics of the event (e.g., the location, type and volume of a release). The immediate response would be to stop drilling or injection, in order to assess the situation. The Alliance would then conduct an investigation to determine the cause of the event by reviewing monitoring records, checking the well casing, annulus seals and down-hole pressure. The Alliance could also perform geophysical surveys to support the investigation. Depending on the cause of the event, several solutions could be implemented, including repairing the well casing, lowering the reservoir pressure by removing brine or CO₂, increasing the upstream reservoir pressure (e.g., creating a hydraulic barrier), diverting the CO₂ stream, or modifying the injection flow rate or quantity. In certain situations, an injection well could be sealed with cement or USDW groundwater remediation could be implemented if necessary. All emergency and remedial response procedures **are** described in detail in the MVA, which **was** included with the UIC permit applications.

Section 2.5.4 describes the closure procedures for the injection wells at the end of the 20-year injection period. During the injection period, the Alliance would work with the UIC Program Director to refine and finalize the Post-Injection Site Care and Closure Plan, which would detail the plugging and abandonment of the wells and future monitoring activities.

Educational Facilities

There would be no direct or indirect impacts to local geology from the operation of the educational facilities. Use of the facilities by employees and visitors would not affect the geologic resources or regional economic mineral resources.

3.4.4 Impacts of the No Action Alternative

Under the no action alternative, DOE would not provide cost-shared funding for the proposed FutureGen 2.0 Project. Although the Alliance may still elect to construct and operate the project in the absence of DOE cost-shared funding, for the purposes of the analysis in this EIS, DOE assumed the no action alternative is equivalent to the no-build alternative. Therefore, the project would not be constructed and there would be no change to the local geologic resources. In addition, CO₂ injection would not occur under the no-build alternative, so there would be no change to the subsurface within the CO₂ storage study area.

Table 3.4-2. Summary of Possible Testing and Monitoring Activities

Monitoring Category	Monitoring Method	Description
Operational Testing (CO ₂ Injection Stream Monitoring)	Sampling and Analysis	Monitoring of the chemical and physical characteristics of the CO ₂ injection stream.
Operational Testing (CO ₂ Injection Process Monitoring)	Continuous Monitoring of Injection Process	Continuous monitoring of injection mass flow rate, pressure, and temperature, annular pressure and fluid volume, and injection stream sensors (CO ₂ , O ₂ , H ₂ O)
Mechanical Integrity Testing	Continuous Annular Pressure Monitoring	Annular pressure is continuously monitored to identify failure of internal mechanical integrity (e.g., tubing or packer leak).
	Oxygen-Activation Tracer Logging	Geophysical tracer logging technique that uses a pulsed neutron tool to quantify flow of water in or around a borehole.
	Radioactive Tracer (RAT) Logging	A RAT survey that uses a wireline tool to detect the location(s) (e.g., perforations, leaks through casing) where the injected RAT exits from or migrates along the well bore.
	Temperature Logging	Identifies injection-related fluids that have moved along channels adjacent to the well bore
	Cement Bond Logging (Ultrasonic Logging)	Verifies the integrity of the cement bond to the well casing and formation in the presence of CO ₂ and injection zone brine, as well as casing corrosion.
Operational Testing (Corrosion Monitoring of Well Materials)	Corrosion Coupon Method	Coupons consisting of the same material as the casing and tubing would be placed in the CO ₂ injection line and periodically removed for corrosion inspection.
	Wireline Monitoring of Casing and/or Tubular Corrosion	Ultrasonic, electromagnetic, and mechanical logging tools used to evaluate the condition of the well-casing and the CO ₂ injection tubing.
	Pressure Fall-Off Testing	A pressure transient test that involves shutting in the injection well after a period of prolonged injection and measuring pressure falloff.
Groundwater Monitoring	Early Leak-Detection Monitoring	Fluid sampling and pressure and temperature monitoring for early leak-detection within the deepest permeable zone located directly above the primary confining zone.
	USDW Aquifer Monitoring	Fluid sampling and pressure and temperature monitoring for leak detection and assessment of water-quality impacts to the lowermost USDW aquifer.
	Shallow groundwater monitoring	Three shallow groundwater wells would be drilled to 100 feet and regularly sampled for leak detection.
Groundwater Monitoring (Injection Zone)	Single-Level Monitoring Wells	Fluid sampling and pressure and temperature monitoring for assessment of CO ₂ fate and transport and leak detection.
	Multi-Level Monitoring Wells	Fluid sampling and pressure and temperature monitoring for assessment of CO ₂ fate and transport and leak detection, injection zone heterogeneity, and anisotropy.
Plume and Pressure Front Monitoring (Indirect Geophysical Monitoring Techniques)	Varies	Multiple technologies tested for efficacy and cost effectiveness.

Source: Alliance 2013a

CO₂ = carbon dioxide; H₂O = water; O₂ = oxygen; RAT = radioactive tracer; USDW = Underground Source of Drinking Water

3.5 GROUNDWATER

3.5.1 Introduction

This section describes the groundwater resources that could be impacted by the construction and operation of the FutureGen 2.0 Project and its related components. This section also analyzes the potential direct and indirect effects of this proposed project on these resources.

3.5.1.1 Region of Influence

The ROI for groundwater resources includes the drinking water aquifers that underlie the Meredosia Energy Center, CO₂ pipeline corridor, CO₂ storage study area, and the educational facilities, which have the potential to be contaminated from spills during construction and operations. The ROI includes the aquifers that would be used as a source of water to support construction and operations.

The ROI also includes the drinking water aquifers within the UIC survey area, **as identified in the UIC permit applications**, which overlie the anticipated CO₂ plume. This ROI encompasses a 25-square mile survey area, centered on the CO₂ storage study area (see Section 3.4, Geology). Computer modeling of the CO₂ plume suggests that the plume would encompass an area of approximately 4,000 acres around the injection wells within the CO₂ storage study area.

3.5.1.2 Method of Analysis and Factors Considered

The affected environment for the FutureGen 2.0 Project was characterized using GIS data from the Illinois Natural Resources Geospatial Data Clearinghouse, drinking water aquifer reports produced by the IDNR, USEPA water quality reports, and water source data from the Meredosia Water Department and the Meredosia Energy Center. DOE determined potential impacts to groundwater resources based on anticipated project water requirements, spill prevention and mitigation BMPs, and the results of computer modeling of the CO₂ plume. **DOE also incorporated into the Final EIS the latest project design information and data from the UIC permit applications, including updates to the CO₂ pipeline route, the CO₂ storage study area, the location of the injection wells, and results of the plume modeling.**

DOE assessed the potential for impacts based on whether the proposed FutureGen 2.0 Project would:

- Deplete groundwater supplies on a scale that would affect available capacity of a groundwater source for use by existing water rights holders, or interfere with groundwater recharge;
- Conflict with established water rights, allocations, or regulations protecting groundwater for future beneficial uses;
- Potentially contaminate shallow drinking water aquifers due to chemical spills, well drilling or well completion failures;
- Conflict with regional or local aquifer management plans or goals of governmental water authorities; or
- Potentially contaminate a drinking water aquifer (i.e., USDW) due to migration of CO₂ or brine (saline groundwater) into the aquifer from CO₂ injection, or through contamination by chemical spills, well drilling, well development, or well failures.

3.5.1.3 Regulatory Framework

The injection of CO₂ for geologic sequestration is regulated under the USEPA's UIC Program (see Section 3.4, Geology, for additional details), which protects underground drinking water resources from contamination by waste injection. In 2010, the USEPA designated a new UIC classification (Class VI) specifically for geologic sequestration of CO₂. This new class of regulations includes minimum technical criteria for the permitting, geologic site characterization, injection well construction and operation,

monitoring requirements, and post-injection requirements. Identification of the deepest source of drinking water in relation to the injection zone is a critical part of the permitting process. The USEPA defines a USDW as an aquifer, or part of an aquifer, with the following characteristics:

- Supplies any public water system or contains a sufficient quantity of groundwater to supply a public water system and currently supplies drinking water for human consumption or contains fewer than 10,000 milligrams per liter of total dissolved solids; and
- Is not an exempted aquifer.

The UIC Program works with state and local governments to oversee underground injection in an effort to prevent contamination of drinking water resources. The program requires that the permit applicant demonstrate the integrity of the confining zone between the injection zone and the deepest USDW. All injection wells require authorization under general rules or specific permits. The Alliance would apply for Class VI Geologic Sequestration Well Permits from the USEPA, which would cover the injection activities for the proposed FutureGen 2.0 Project.

3.5.2 Affected Environment

3.5.2.1 Regional Hydrogeology

In Illinois, potable groundwater is usually obtained from near-surface aquifers composed of deposits of sand and gravel, or from deeper limestone or sandstone formations. Some sand and gravel aquifers can produce large quantities of water from relatively shallow depths and are used to provide water for many municipalities and industrial users. The deeper limestone and sandstone formations that exist below the sand and gravel aquifers are used to supply groundwater in the northern third of Illinois, but as the formations dip to the southeast in the Illinois Basin, they become more saline (briny) and unsuitable for most purposes.

In Morgan County, shallow sand and gravel aquifers are the primary USDW. Drinking water is also obtained from the Illinois River. Figure 3.5-1 presents the areas where sand and gravel aquifers are present within the ROI. The map shows major sand and gravel aquifers, which are defined as aquifers capable of yielding at least 70 gpm of potable water, and shallow sand and gravel aquifers that are located less than 50 feet bgs (ISGS 2004). In western Morgan County, the primary sand and gravel aquifer is directly influenced by the Illinois River, which follows an ancient lake and riverbed formed and then buried during the Wisconsin Episode of glaciation. The major sand and gravel aquifers have a greater potential to support municipal and industrial users, while individual users may still be able to withdraw water from small, localized aquifers. In areas without a major aquifer, groundwater is likely present between thin layers of sand and gravel and confined in layers of clay, which restricts groundwater flow and preclude large withdrawals.

Shallow bedrock formations (less than 500 feet bgs) do not typically exhibit the yields and water quality required to support commercial and industrial users in the area. Shallow Pennsylvanian formations consist principally of shale in Morgan County. They are not considered a potential source of potable groundwater except for thin beds of sandstone or fractured limestone that may yield small domestic supplies. The Mississippian formations in Morgan County dip to the southeast at about 10 to 40 feet per mile (Woller and Sanderson 1979). The Burlington-Keokuk Limestone and the Salem Limestone units of the Mississippian System contain the principal bedrock aquifers, but their yield greatly depends on the fracture sequences within the bedrock. The Salem Limestone has the potential to support domestic and farm supplies, although yields are marginally adequate. Formation depths range from 175 feet in the northwest part of Morgan County to about 650 feet in the southeast (Woller and Sanderson 1979). The salinity and mineral concentration increases with depth in the Salem Limestone groundwater. In the east and the south, the Salem Limestone is as much as 200 feet thick and is overlain by the St. Louis Limestone. These two units have limited potential for water supply uses and may contain mineral concentrations too high for most uses.

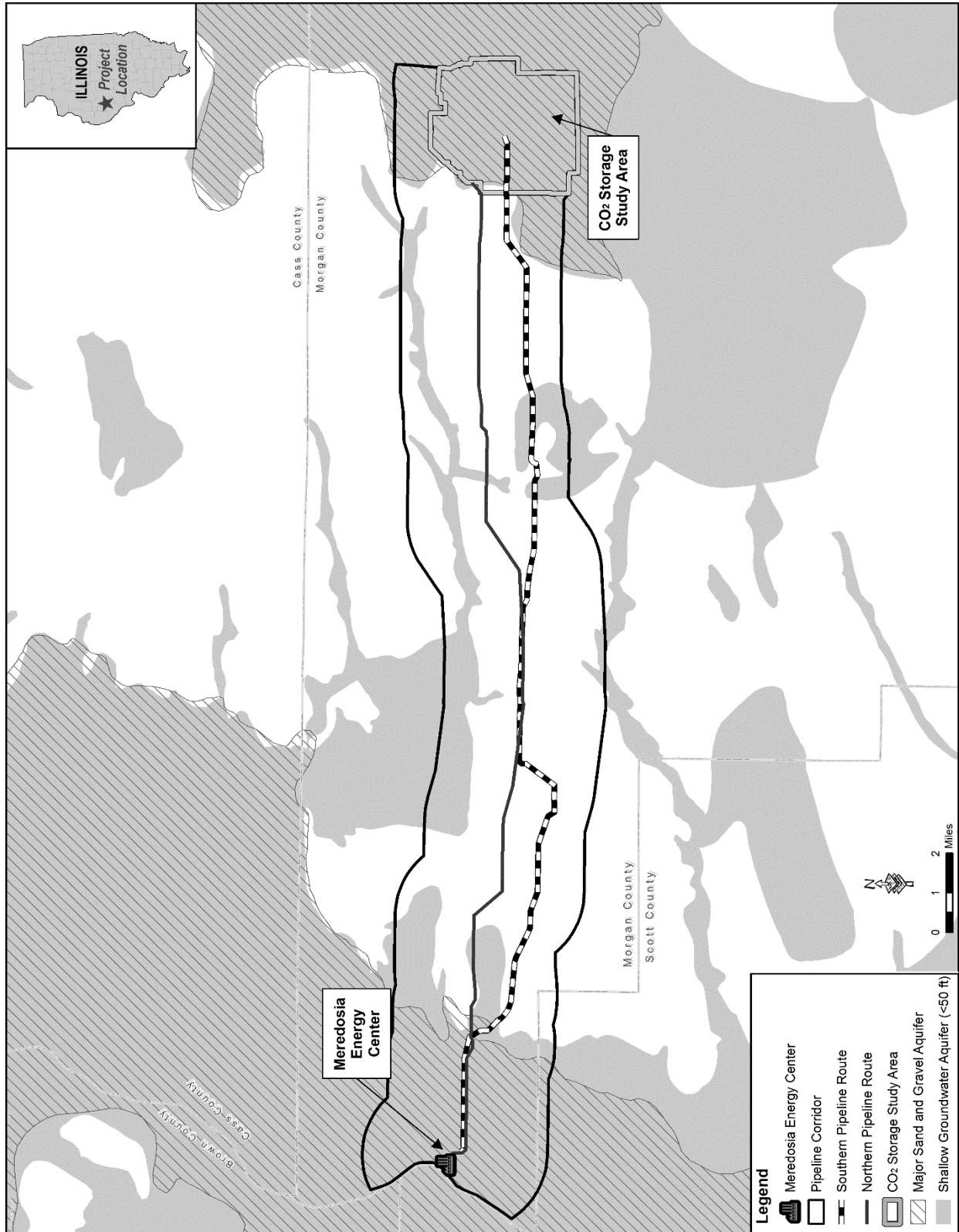

Source: ISGS 2004

< = less than; CO₂ = carbon dioxide; ft = feet

Figure 3.5-1. Shallow Groundwater Aquifers

Major deep bedrock aquifers (greater than 500 feet bgs) are also located in Morgan County. These include the Mt. Simon, St. Peter, and Ironton/Galesville Formations. However, these aquifers are not used as sources of public drinking water in Morgan County because of their depth and salinity (Woller and Sanderson 1979). Of the three major deep bedrock aquifers, only the St. Peter Sandstone has a mineral concentration within USEPA drinking water standards (ISGS, 2004; Alliance 2013a). However, the St. Peter Sandstone lies at a depth of about 1,750 to 1,950 feet, and its salinity is high enough that it is unusable as drinking water (without treatment) and the state of Illinois does not consider it a source of drinking water.

There are no sole source aquifers in the state of Illinois. A sole source aquifer is one that supplies at least 50 percent of the drinking water consumed in an area where no alternative drinking water sources can supply those who depend upon the aquifer for drinking water.

3.5.2.2 Meredosia Energy Center

The Meredosia Water Department withdraws water from the Illinois River and a shallow sand and gravel aquifer to produce drinking water. The water department serves a population of approximately 1,040 people (USEPA 2011i) and provides potable water that meets USEPA water quality standards, with no health-based violations in the past 10 years. While there were incidences of monitoring and reporting violations in 2007 and 2009, compliance was achieved within three months of the end of testing (USEPA 2011i).

The Meredosia Water Department pumps groundwater from production wells that were first installed in 1950 (Woller and Sanderson 1979) into a sand and gravel aquifer. Currently, the utility withdraws water from two wells that were drilled in 1980 at depths of 90 and 92 feet (ISGS 2012c). The wells are located approximately one mile south of Main Street and have an approximate capacity of 300 gpm (Midwest Technology Assistance Center 2009). The sand and gravel aquifer system from which these wells withdraw water is hydraulically connected to the Illinois River, so it has a good withdrawal capacity and is considered an unconfined aquifer (Midwest Technology Assistance Center 2009; Anliker and Woller 1998). In 1995, the village of Meredosia and the Meredosia Energy Center each withdrew approximately 0.06 mgd from the sand and gravel aquifer (Anliker and Woller 1998).

In addition to the Meredosia Water Department, several industrial and other private users operate their own well systems in the area. Most groundwater wells around the Illinois River extend 50 to 130 feet bgs (Gibb et al. 1979). Farms and residences not connected to the Meredosia public water supply use their own wells to extract water from sand and gravel aquifers. The majority of the groundwater withdrawn through private wells is used for crop irrigation along a 6-mile strip of farmland between the bluffs and the Illinois River (Gibb et al. 1979). In 1995, manufacturing plants south of Meredosia and the Meredosia Energy Center withdrew a combined 3.13 mgd of groundwater from large capacity shallow wells (Anliker and Woller 1998). There is no regional groundwater plan for Morgan County or the local aquifer.

Although regional groundwater levels vary based on the Illinois River level, the local ground surface elevation, and season, the average groundwater levels for the Meredosia Energy Center wells are approximately 23 to 25 feet bgs. The Illinois State Water Survey conducted pumping tests on one of the groundwater wells at the Meredosia Energy Center (Ameren well 6) to evaluate the characteristics of the sand and gravel aquifer in this area. From these tests, it was determined that the transmissivity of the aquifer is 100,000 gpd per foot and the hydraulic conductivity is 1,200 gpd per square foot (Gibb et al. 1979). Transmissivity is a parameter used to characterize the amount of water that can be transmitted horizontally through an aquifer, while hydraulic conductivity is a parameter used to characterize the ease with which water can flow through an aquifer. These values of hydraulic conductivity and transmissivity can be attributed to the high permeability of the sand and gravel aquifer and the fact that the Illinois River is hydraulically connected to the aquifer system.

At the end of 2011, Ameren suspended operations at the Meredosia Energy Center. While it was operating, the Meredosia Energy Center withdrew makeup water and potable water from the major sand

and gravel aquifer using three production wells (Wells 5, 6, and 7). The Ameren wells are screened in sand deposits near the base of the Cahokia Formation, at approximately 103 to 106 feet bgs. Each well has a capacity of approximately 500 gpm. Two older wells (Wells 3 and 4) are still present on the energy center site but have not been used since before the energy center suspended operations. The energy center also supplemented the process water supply with an intake in the Illinois River (Anliker and Woller 1998).

Table 3.5-1 presents an estimate of the amount of groundwater withdrawn from the three Ameren wells, as reported by Ameren to the Illinois State Water Survey under the Illinois Water Inventory Program. The general decrease in annual water use in 2008-2009 is attributable to Ameren reducing the use of boilers for energy production.

Table 3.5-1. Summary of Past Water Use at the Meredosia Energy Center

	1999	2000	2001	2002	2003	2004	2005	2006	2007	2008	2009
Daily Maximum (thousand gallons)											
Well 5	720	720	720	475	–	–	–	261	264	238	–
Well 6	720	720	720	842	–	–	–	265	289	212	–
Well 7	860	860	860	982	–	–	–	266	294	284	–
Total Annual (million gallons)											
Well 5	7	7	7	4.6	7	7	21	24	16	9	2
Well 6	7	7	7	8.2	7	7	21	24	16	11	4
Well 7	7	7	7	8.2	7	7	21	24	31	31	16

Note: Dash ‘–’ indicates no data is available.

In 2010, in response to the coal ash spill at a Tennessee Valley Authority facility, the IEPA initiated a management strategy for ash impoundments located at coal-fired power plants within the state of Illinois. The IEPA assessed the vulnerability of groundwater to contamination from ash ponds throughout the state and categorized facilities with ash ponds into two priority groups according to their potential to cause groundwater contamination. Priority 1 facilities were identified in areas where there is a high potential for aquifer recharge and an existing or future population that depends on the groundwater as a source of drinking water. Priority 2 facilities have a low potential for aquifer recharge and existing or future potable uses in the area.

Because the ash ponds at the Meredosia Energy Center are located above a potable aquifer with a high potential for recharge, the facility was categorized as Priority 1 (IEPA 2011c). As a result, Ameren submitted a hydrogeologic assessment plan, which was accepted by the IEPA, and is conducting groundwater monitoring on a quarterly basis. The IEPA analyzed the groundwater flow direction at the Meredosia Energy Center and determined that groundwater flows toward the river. Therefore, potential contamination from the ash ponds would not impact the drinking water wells near the facility. Ameren is continuing to maintain the ash ponds and is working with the IEPA on its management strategy.

3.5.2.3 CO₂ Pipeline

As the proposed CO₂ pipeline corridor leaves the Meredosia area, it crosses the major sand and gravel aquifer that is described in Section 3.5.2.1. The majority of the CO₂ pipeline corridor overlies groundwater aquifers that are shallower than 50 feet and consist of glacial sand and gravel deposits that are limited in extent (see Figure 3.5-1). These aquifers are present in layers too thin for municipal or large industrial use, although households and farms may use them for individual water wells.

3.5.2.4 CO₂ Storage Study Area

There is a major sand and gravel aquifer beneath the CO₂ storage study area located in the northeastern corner of Morgan County (Figure 3.5-1). This aquifer could be connected to the sand and gravel aquifer system at the Meredosia Energy Center by a bedrock valley buried by glacial deposits. The other groundwater resources in the area are typically found in glacial till, mostly confined to thin layers of sand and gravel between clay.

A shallow monitoring well drilled and installed at the CO₂ storage study area found thin glacial sediment consisting of silts and clays, which resulted in a poor yield of groundwater. The Alliance conducted groundwater sampling from this monitoring well in the fall of 2011. The groundwater pH values ranged from 7.08 to 7.66. Most of the constituent concentrations were below applicable drinking water standards, although a few exceeded the USEPA primary or secondary standards. The concentrations of iron, manganese, nitrate and total dissolved solids exceeded the USEPA primary or secondary standards in some of the groundwater samples.

The aquifers located in the sand and gravel deposits and the shallowest bedrock (less than 500 feet bgs) are considered USDWs because they are used as potable water and have a total dissolved solids concentration well below the USEPA's threshold (10,000 milligrams per liter). The deeper bedrock aquifers are typically characterized by increased levels of total dissolved solids, which increase with depth. Around Chicago and in northern Illinois, the St. Peter and Mt. Simon Formations have total dissolved solids concentrations that are low enough to be used as freshwater aquifers. The formations depths and salinities increase to the southeast.

At the CO₂ storage study area, the St. Peter Formation contains a deep aquifer at approximately **1,740** feet bgs, with a total dissolved solids concentration of 2,500 to 10,000 milligrams per liter (ISGS 2004). The Alliance sampled water from the St. Peter aquifer at the stratigraphic well (see Figure 3.5-2) and determined that the total dissolved solids concentration was about 3,700 milligrams per liter. Although the aquifer could likely support the volume of pumping required by a public utility, none of the communities in and around Morgan County withdraw water from the St. Peter aquifer and the state of Illinois does not consider it to be a source of potable water at this location. For the UIC permit applications, the St. Peter Formation is classified as a federal USDW, and as an Illinois non-USDW (Alliance 2013a). There are about 1,900 feet of bedrock between the top of the injection zone and the base of the St. Peter Formation, of which 570 feet are composed of the primary and secondary caprock formations (Figure 3.4-2). At the CO₂ storage study area, the Mt. Simon Formation has a reported total dissolved solids concentration of over 48,000 milligrams per liter and is not considered a USDW in Morgan County (Alliance 2013a).

In the 25-square mile UIC survey area, there are 24 water wells present (ISGS 2012c). Figure 3.5-2 shows the location of the groundwater wells within the UIC survey area. Seventeen wells are screened to depths of 50 feet or less. These wells are drilled for domestic use and for livestock watering. One well is drilled to 54 feet bgs and is used as a livestock watering well. Five groundwater wells have been drilled deeper than 100 feet bgs. The deepest of these was drilled to 1,056 feet bgs by the Linden Oil Company; the other four wells were drilled to a depth of 100 to 400 feet bgs (ISGS 2012c). The deep well was likely drilled for hydrocarbon production, proved unsuccessful (as a "dry hole"), and was transferred to a private user to support agricultural needs. The stratigraphic well drilled by the Alliance is also included in the water well database. The stratigraphic well was drilled to 4,820 feet bgs and penetrates the Mt. Simon and Eau Claire Formations (Alliance 2013a). It was designed and constructed using carbon sequestration well standards to prevent the upward migration of CO₂, with the intention for it to be used as a deep monitoring well.

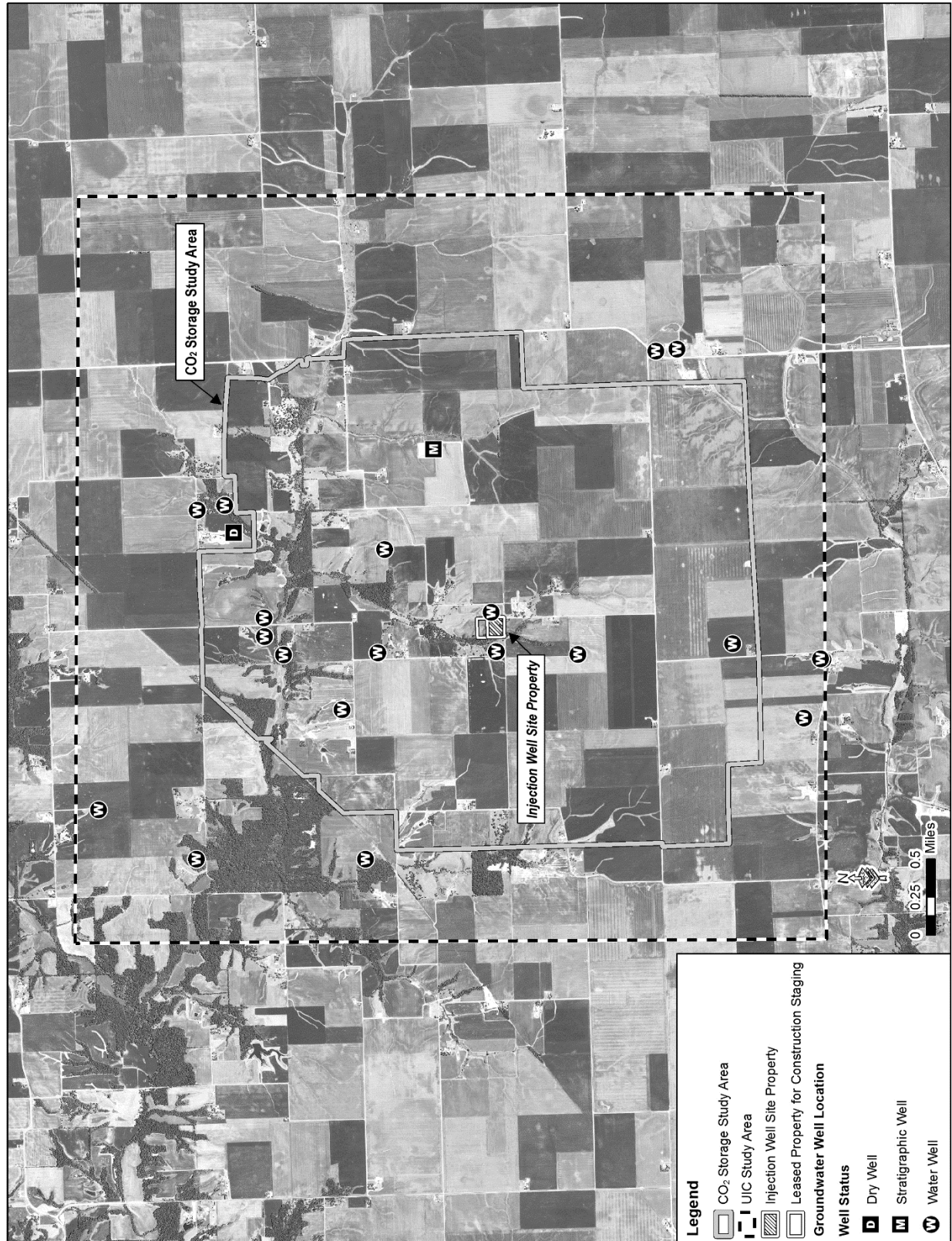

Source: ISGS 2012c
 CO₂ = carbon dioxide; ROI = region of influence; UIC = underground injection control

Figure 3.5-2. Shallow Groundwater Wells in the Underground Injection Control Survey Area

The village of Ashland, the closest community to the CO₂ storage study area, is located approximately 5 miles to the northeast and outside of the study area. The municipal water sources for the community are between 12 and 26 miles from the CO₂ storage study area. Although the village of Ashland had drilled municipal water wells in 1936, Ashland's current water supply comes from the city of Jacksonville water system and the water plant at Virginia, Illinois via rural water cooperatives (Journal Courier 2011; Journal Courier 2010). The Virginia water plant is located about 12 miles northwest of the CO₂ storage study area and withdraws groundwater from five wells drilled between 50-70 feet bgs in the Mahomet aquifer. The city of Jacksonville withdraws most of its water from a radial well drilled on the banks of the Illinois River, about 26 miles west of Jacksonville (City of Jacksonville 2012a). When the main well is undergoing maintenance, two local, gravel pack wells are used. The water is piped to a local water treatment plant before being distributed to the public.

3.5.2.5 Educational Facilities

The educational facilities are expected to be located in or near Jacksonville, Illinois. The groundwater in this area is restricted to thin, individual pockets in sand deposits. The Alliance expects that the public water utility would provide for the water needs of the educational facilities (see Section 3.15, Utilities).

3.5.3 Impacts of the Proposed Action

3.5.3.1 Construction Impacts

During construction, accidental spills of fuel, fuel constituents, and other materials onto the ground surface may occur and could potentially impact shallow groundwater resources. The potential for spills to impact groundwater is considered low as the BMPs described in Section 3.3, Physiography and Soils, would be applied to prevent spills and unintentional releases to groundwater from wastes or petroleum-based materials generated during construction. If oil spills were to occur, response actions and control measures specified in the SPCC plan for the project would be employed to address the spill. As a result, DOE expects that impacts to groundwater resources from spills during construction would be short term and minor.

Meredosia Energy Center

The Alliance would remove Wells 3, 4, and 5 and construct one new production well at the Meredosia Energy Center to replace them. The new well would be completed in the same shallow sand and gravel aquifer in which the other wells at the energy center are installed. Three potential locations have been identified for the new well, although a final location has not been selected. The construction of the well would comply with Title 77 IAC 920, Illinois Water Well Construction Code. The construction of this well would not cause or contribute to adverse impacts to the groundwater resources in this area.

During construction, the Alliance may use the new and existing groundwater wells onsite to provide water to support construction needs. Water could also be obtained from the village of Meredosia or trucked in to support construction. The construction demand is not expected to exceed the operational demand for the project, and would be less than the historical water demand of the Meredosia Energy Center (see Table 3.5-1). As a result, adverse impacts to the local aquifer, which is connected to the Illinois River, are expected to be negligible. In addition, there would be no direct onsite discharge to groundwater during the construction process.

CO₂ Pipeline

Potential impacts to groundwater from spills that could occur during construction of the CO₂ pipeline would be similar to those addressed for the energy center. **In the Draft EIS, one existing water well was identified within the construction ROW for the southern pipeline route. Since publication of the Draft EIS, the Alliance identified an updated alignment for the southern pipeline route that no longer intersects (i.e., within the construction ROW) any water wells.** Therefore, construction activities would not directly impact groundwater resources.

Based on the proposed depth of pipeline burial (**between 4 and 5 feet**), shallow groundwater is unlikely to be encountered during excavation of the pipeline trench. Any groundwater wells that exist within the vicinity of the pipeline would likely be screened at depths much deeper than the pipeline trench; therefore, the aquifers used would not be directly impacted by trenching or horizontal directional drilling because of their depth below the pipeline and the distance from the pipeline to the wells. Therefore, based on the location of the proposed pipeline routes, it is not anticipated that any existing water supply wells would be directly affected by construction of the CO₂ pipeline. In the unlikely event that an existing supply well were to be directly impacted by the construction activities, resulting in the temporary impairment of the quantity or quality of water available in that well, alternative sources of water would be identified and provided (e.g., a new well would be drilled to replace the damaged well or other water service would be provided until such time as the issue was resolved).

For the portion of the pipeline traversing the CO₂ storage study area, impact analysis in the Draft EIS used hypothetical end-of-pipeline routes (spurs) to evaluate a range of reasonable siting scenarios (see Section 3.0). Since the release of the Draft EIS, the Alliance identified a location for the injection wells (see Section 2.5.2.3) and established the pipeline routing within the CO₂ storage study area for the southern route to the proposed injection well site. Since the Alliance does not plan to move forward with the northern pipeline route, final routing within the storage study area was not identified for the northern route to the injection well site. As a result, DOE analyzed the pipeline impacts for the southern route based on the currently proposed pipeline alignment from the energy center to the injection well site; and for the northern route based on the analysis presented in the Draft EIS using hypothetical end-of-pipeline spurs.

The Alliance designed the southern pipeline route such that the construction ROW would not intersect existing water supply wells; therefore, no direct impacts to water supply wells are anticipated. Potential indirect impacts resulting from the construction of the pipeline across the CO₂ storage study area would be similar to those described regarding pipeline construction within the pipeline corridor. The pipeline route could ultimately deviate as a result of final project design and continued coordination with landowners; however, the same siting criteria would be followed and impacts would be consistent with those addressed in this section.

The Alliance has no current plans to withdraw groundwater or to discharge directly to groundwater during construction of the proposed pipeline. Water required for construction purposes (e.g., hydrostatic testing, preparation of drilling mud for directional drilling, and dust suppression) may be trucked in or obtained from surface waterbodies adjacent to the pipeline. If hydrostatic test water is discharged to the ground after testing, an NPDES permit would be obtained for each discharge, as appropriate, and applicable procedures, including water quality testing, would be followed; therefore, impacts to groundwater resources would be negligible.

CO₂ Storage Study Area

The injection wells would be located above a major sand and gravel aquifer, so the construction impacts would be similar to those described for the groundwater wells at the Meredosia Energy Center. The wells would be designed and installed in accordance with the design standards specified by the Class VI injection well regulations and as defined in the UIC permits. These design standards were adopted to protect drinking water resources from well construction and operation. The wells would be constructed to isolate each of the potential aquifers from one another and from the CO₂ reservoir. This would be accomplished by constructing the injection wells with casings that telescope down in diameter with depth. In other words, the largest diameter casing is at the surface and each succeeding casing of smaller diameter is drilled and installed through the larger casing above. As each casing is installed, it would be cemented in place before the borehole was advanced. The base of the long string casing would be cemented with CO₂-resistant cement in the injection zone. Figure 2-24 and Figure 2-25 present the casing program, depths, cement types, and well design for vertical and horizontal injection wells, respectively.

The series of cemented casings would prevent CO₂ from escaping around the borehole casing and would isolate each of the aquifers.

In addition, the Alliance would locate the pipeline and injection wells using the siting criteria listed in Sections 2.5.1.1 and 2.5.2.1, which includes avoiding major bodies of water and wetland areas. Such areas tend to have shallow groundwater tables and high infiltration rates, so avoiding these locations would reduce the potential for impacts to shallow groundwater resources.

Educational Facilities

The construction of the educational facilities would not require groundwater pumping or the direct discharge of water or wastewater to an aquifer. Potential impacts to shallow aquifers would be consistent with those described for the energy center and would be expected to be negligible.

3.5.3.2 Operational Impacts

During operations, petroleum, oils, lubricants, and other hazardous materials could be spilled onto the ground surface and potentially contaminate groundwater resources at any of the project facilities. However, the operational BMPs and SPCC plan for the project, as described in Section 3.3, Physiography and Soils, would be implemented to reduce the potential for impacts to groundwater resources from spills.

Meredosia Energy Center

Historically, the Meredosia Energy Center used well water as its source for drinking water as well as for freeze protection of the bottom ash pond piping during the winter months when necessary. Groundwater was obtained from several groundwater wells located east of the energy center on the property. As shown in Table 3.5-1, in the late 2000s, Ameren was withdrawing up to 294,000 gpd (daily maximum flow) from each of the three operational wells. The planned operations of the oxy-combustion facility under the proposed project would require approximately 124,000 gpd. Groundwater would be pumped from one new well and two existing wells on the Meredosia Energy Center site.

The IEPA has determined that the groundwater flow at the Meredosia Energy Center is toward the Illinois River (IEPA 2011c). While withdrawal from the new well would change highly localized groundwater movements, the changes are not anticipated to affect the surrounding groundwater wells. The new well would be located further from the river and would not withdraw enough water to divert the local groundwater flow. A groundwater monitoring study performed in 1981 at an industrial site less than a mile from the energy center determined that, while pumping 1,400,000 gpd, the drawdown cone stayed within 100 feet of the well (Naymik and Barcelona 1981). The municipal and other industrial wells are located over 100 feet from the energy center wells, which suggests that any impacts on existing wells from changes in local groundwater movement caused by the addition of the new well would be minor.

The amount of water withdrawn for the FutureGen 2.0 Project would generally be lower than the historical usage at the energy center. Based on the characteristics of the sand and gravel aquifer and the history of pumping at the facility, the aquifer can readily supply the water required to support operations of the energy center and would not affect the available capacity or quality of groundwater in the area. Therefore, DOE would expect impacts to groundwater availability to be minor.

A revised NPDES permit application has been submitted for the FutureGen 2.0 Project. Under the NPDES permit, stormwater not exposed to industrial pollutants would flow to a stormwater management basin, which would allow the water to infiltrate back to the groundwater. Since the water from this basin would not be exposed to industrial contaminants, it is not expected that the infiltration of stormwater to the groundwater table would adversely impact groundwater quality in the area.

CO₂ Pipeline

Although there are no anticipated needs for groundwater supplies along the pipeline and no plans to discharge directly to groundwater during operations, there may be limited discharges of water to the ground (e.g., spent hydrostatic test water used for periodic testing of pipeline integrity), subject to the

provisions of the NPDES permit. During project operations, there is also some potential for spills to occur from operational equipment (e.g., hydraulic fluids, fuels, lubricants) during maintenance activities. These activities along the pipeline would be limited in scope and frequency. The Alliance would follow the BMPs discussed in Section 3.3, Physiography and Soils, as applicable, during maintenance activities to avoid or minimize potential impacts to groundwater resources from accidental spills of fuel, fuel constituents, and other materials. Taking these BMPs into account, DOE anticipates that potential impacts to groundwater quality from the operation of the CO₂ pipeline would be minor. DOE expects that operation of the CO₂ pipeline would not impact the availability of groundwater resources.

During the operation of the pipeline, supercritical CO₂ would be pumped through the pipeline to the injection wells. As discussed in Section 3.17, Human Health and Safety, based on the frequency of releases from similar pipelines in the United States, a release of CO₂ due to pipeline puncture or rupture is considered unlikely. Several design and procedural methods would be implemented to minimize the potential for an accidental pipeline release. The CO₂ pipeline would use mainline block valves to isolate pipeline sections, a leak detection system to alert the operator, and a SCADA telecommunication system to communicate information and data about pipeline performance. In addition, pipeline monitoring and surveillance procedures would be included in the Operating Manual for the pipeline and implemented in the field on a daily basis. If CO₂ were released from the pipeline, it would expand rapidly as a gas and could include both liquid and solid phases, depending on temperature and pressure. As the product in the pipeline is over 97 percent CO₂ with few impurities and would not remain under sufficient pressure to dissolve into groundwater, it would have negligible impacts to groundwater quality in the unlikely event of a release.

CO₂ Storage Study Area

The Alliance evaluated several injection well configurations using both vertical and horizontal injection wells at one or two injection well sites. After consideration of site-specific data from the stratigraphic well, the Alliance is currently proposing to operate up to four horizontal injection wells at one injection well site for the annual injection of 1.2 million tons (1.1 million metric tons) of CO₂ over a 20-year period. The injection wells would be designed to inject CO₂ in a horizon within the Mt. Simon Formation (the target injection formation). Under normal operating conditions, **64 percent** of the CO₂ flow would be split equally between two of the wells while the other two wells **would receive 17 and 19 percent of the flow, respectively**. The injection wells would be constructed to provide operational flexibility and backup capability, such that one well could be taken off line while the remaining three injection wells receive 100 percent of the flow. The horizontal injection would occur along the final 1,500 to **2,500** foot section of each injection well, allowing the CO₂ to infiltrate through a single horizon within the Mt. Simon Formation at about 4,030 feet bgs. Over the course of the injection period, the individual CO₂ streams from each of the four wells would merge to form a combined plume.

The Alliance conducted modeling using the STOMP-CO₂ computer program to predict the areal extent and distribution of the CO₂ plume for the proposed injection well configuration. Data from the stratigraphic well, as well as data collected from hydrologic testing, wireline logging, and vertical seismic profiling, was used to support the modeling effort. The Alliance used multiple variables to model the formation (e.g., vertical and horizontal permeability and porosity, rock and grain density, capillary pressure) and the reservoir (e.g., temperature, fluid pressure, salinity), combined with the injection stream values (i.e., pressure, saturation) to determine the lateral extent of the plume after 20 and 70 years. The Alliance ran the model to determine the maximum extent of the plume, the time period of pressure buildup and drop off, and a sensitivity analysis to determine the most significant parameters for determining plume size (i.e., fracture gradient and porosity). Appendix G, Geological Report, contains the technical report detailing the model's inputs, assumptions, and outputs. As shown in **Figure 2-26**, the plume model predicted that the CO₂ plume would occupy a subsurface area of approximately 4,000 acres within the CO₂ storage study area.

Injected CO₂ would be less dense than the surrounding brine (saline groundwater), so it would migrate upwards and laterally within the injection zone to areas of lower pressure until it reached impermeable layers (e.g., the caprock). Over time, the CO₂ would be incorporated into the brine and would either migrate with the groundwater flow, be trapped in the formation's pore space by capillary action, or would begin to mineralize to form new carbonate minerals. As the CO₂ migrates through the formation, it would displace the Mt. Simon Formation brine within the plume radius. As a result, the brine would migrate laterally to lower pressure areas within the formation. Brine displacement would decrease with distance from the injection wells and CO₂ plume.

The potential impacts associated with well operations and CO₂ injection into geologic formations are largely associated with the possibility of CO₂ leakage into drinking water aquifer resources. CO₂ could leak from the target formation by:

- Passing through the caprock through a higher permeability zone or from excessive pressure within the injection zone;
- Leaking into a drinking water aquifer via a transmissive fault;
- Escaping through a fracture or more permeable zone in the caprock into a drinking water aquifer;
- Migrating up-dip and increasing reservoir pressure and permeability of an existing fault; or
- Escaping into a drinking water aquifer via improperly installed, abandoned, or unknown wells.

The potential for leaks to occur would depend on caprock integrity, the reliability of well construction and well-capping methods, and the degree to which CO₂ is permanently stored by long-term trapping mechanisms. CO₂ is trapped in the injection zone through four mechanisms: (1) structural trapping, (2) residual CO₂ trapping, (3) solubility trapping, and (4) mineralization. These mechanisms are described in Section 3.4, Geology.

If CO₂ were to escape the injection zone and reach a USDW, there is a potential that it could react with and acidify the groundwater. However, this occurrence would be very unlikely because the CO₂ would have to escape from the injection zone to reach the St. Peter Formation or shallower drinking water aquifers and, as discussed earlier, the site was specifically selected to reduce the potential of this happening. In addition, vertical migration of CO₂ to USDW aquifers would be unlikely as a consequence of the following:

- Depth of the injection zone in the Mt. Simon Formation;
- Substantial primary seal provided by the Eau Claire Formation (413 feet thick);
- Presence of a secondary seal formation (Franconia Dolomite) between the Mt. Simon Formation and the St. Peter Formation;
- Presence of more than 3,700 feet of various strata (much of it with low permeability) between the injection zone and any actively used drinking water aquifers in the project area;
- Lack of regional wells that penetrate the Eau Claire Formation; and
- Aquifer monitoring of the injection zone, St. Peter Formation and shallow sand and gravel aquifers as outlined in the MVA plan.

CO₂ would be injected into the **middle of the** Mt. Simon Formation, so that the CO₂ would need to migrate up before it would reach the base of the primary confining zone, the Proviso and Lombard Members of the Eau Claire Formation. Refer to Section 3.4, Geology, for a detailed description of the primary confining zone. In addition, the lenses of silt and clay that are present throughout the Mt. Simon Formation would likely help to laterally disperse the CO₂ and reduce opportunities for vertical migration.

Section 3.4, Geology, presents a full discussion on how the site selection has minimized the potential for CO₂ leaks and migration. A two-dimensional seismic study performed by the Alliance in 2011 confirmed that the Mt. Simon Formation is uniformly thick, dips gently (less than 1 degree) to the southeast, and there are no faults or breaks in the lateral continuity of the formation (Alliance 2013a).

In the UIC survey area, the only well that currently penetrates the St. Peter, Eau Claire, or Mt. Simon Formations is the stratigraphic well completed by the Alliance, which was specifically drilled with CO₂ injection well techniques. Any other deep wells that would be drilled for the proposed project (e.g., injection, or other monitoring wells) would be constructed to the same CO₂-resistant standards. The next deepest water well is 1,056 feet bgs, which is almost 700 feet shallower than the top of the St. Peter Formation. Because of the lack of deep wells in the area, it is very unlikely that the CO₂ could migrate to shallower USDWs through improperly sealed water wells.

The longer that CO₂ is in contact with the brine in the Mt. Simon Formation, the more time is available for the CO₂ to react and dissolve, producing carbonic acid that would slightly lower the pH of the injection zone brine. While the carbonic acid would react with any clay-rich or calcium-rich minerals in the Mt. Simon and Eau Claire Formations, the quartz in the formations would not react to the change in pH (IPCC 2005). Heavy metals could be liberated as minerals react with the CO₂-brine solution and dissolve; however, there are no known anomalous concentrations of metals that could pose a risk to the shallower drinking water aquifers. The injection wells would be constructed with CO₂-resistant cement and specifically designed so that the acidification of the brine would not reduce the well integrity.

The increased pressure from CO₂ injection would also force the brine in the target formation laterally from the injection zone. The research on brine migration in reaction to the injection pressure front is still ongoing, as models are refined with new data. As discussed in Section 3.4, Geology, there is a potential, if the injection pressure is high enough, for small amounts of brine to diffuse into or through the caprock, while simultaneously trapping the CO₂ (Birkolzer et al. 2009; Zhou and Birkolzer 2011; Lemieux 2011). While the upward movement of brine would reduce the overall pressure to the Mt. Simon Formation and the Eau Claire Formation, it would increase the possibility that brine could reach a shallower drinking water aquifer. However, if the brine were to pass through the caprock and reach a shallower (less than 3,700 feet bgs) permeable formation, it would tend to spread laterally and slow its vertical migration. The temperature and density differential between the target formation brine and the shallower formation would cause the dense brine to only remain within the lower-most region. Models suggest that the gradual cooling at the shallower horizon would increase the density of the brine, and pull it back to the deeper reservoir (Oldenburg and Rinaldi 2011).

The Ironton-Galesville Sandstone is located between the primary and secondary confining formations, at about 3,300 feet bgs. If brine were forced upwards, it is likely that it would first reach the Ironton-Galesville Sandstone and spread laterally along the formation bed before continuing upwards. Another sandstone formation, the New Richmond Sandstone, is also located between the secondary confining zone and the St. Peter Formation. Therefore, it is very unlikely that brine displaced by CO₂ and the injection pressure front would reach the St. Peter Formation.

In formations like the Mt. Simon that have slowly flowing groundwater, reservoir-scale modeling for similar projects shows that, over tens of years, up to 30 percent of the CO₂ would dissolve (IPCC 2005). Once CO₂ dissolves in the saline groundwater, it could be transported away from the injection wells by circulation on a regional scale, or it could sink from the increased density, but the time scales of such transport are millions of years and are not considered relevant for this EIS (IPCC 2005). Therefore, it is extremely unlikely that the laterally moving brine would reach locations in northern Illinois and Wisconsin where the Mt. Simon USDW aquifers are closer to the land surface.

The Alliance would employ a series of construction and operation techniques, materials, activities, and other injection BMPs to prevent the migration of CO₂ or brine from the injection zone. The USEPA also requires all UIC Class VI permit applications to submit a detailed description of all of the procedures that

would be implemented to prevent impacts to USDWs, and to create an early warning system in the event of a problem. The MVA program would be implemented to track the lateral migration of CO₂ within the injection zone, monitor containment within the injection zone, characterize any geochemical or geomechanical changes that occur within the injection zone and overlying confining zones, and provide for early detection of any leakage of injected CO₂ or brine to ensure protection of USDWs (Alliance 2013a).

Although unlikely, if the monitoring results showed that CO₂ was released from the injection zone, then injection would be halted, the source of the leak would be identified, and a series of remediation procedures would be implemented, depending on the adverse event. These procedures could include repairing the well casing, lowering the reservoir pressure by removing brine or CO₂, increasing upstream reservoir pressure (e.g., creating a hydraulic barrier), diverting the CO₂ stream, or modifying the injection flow rate or quantity. In a situation where CO₂ or brine reaches a USDW, the Alliance would implement groundwater remediation in the impacted aquifer.

As required by the Class VI Rule, a **single** monitoring well would be drilled into the lowermost USDW aquifer (St. Peter Formation) above the injection zone to monitor changes to the aquifer during CO₂ injection and storage. **In addition, three early detection monitoring wells would be installed within the first permeable formation above the confining zone (e.g., Ironton Sandstone), which lies approximately 1,300 feet below the lowermost USDW aquifer (St. Peter Formation).** As the St. Peter Formation contains the deepest USDW in relation to the injection zone, the **early detection** monitoring wells would provide first evidence of a leak in the caprock formations **before CO₂ can reach the USDW**. Collectively, these measures would minimize the potential for long-term impacts on potable groundwater from CO₂ storage activities to a negligible level.

Educational Facilities

There would be no impacts to groundwater from the operation of the educational facilities. The activities at the facilities would be located in buildings with little opportunity for an outside spill. The educational facilities would not consume groundwater or directly discharge to groundwater; therefore, no impacts to groundwater resources are expected from the operation of the educational facilities.

3.5.4 Impacts of the No Action Alternative

Under the no action alternative, DOE would not provide cost-shared funding for the FutureGen 2.0 Project. Although the Alliance may still elect to construct and operate the project in the absence of DOE cost-shared funding, for the purposes of the analysis in this EIS, DOE assumed that the no action alternative is equivalent to the no-build alternative. Therefore, the project would not be constructed and there would be no impacts to groundwater resources.

3.6 SURFACE WATER

3.6.1 Introduction

This section describes the surface waters potentially affected by the construction and operation of the proposed project. This section also analyzes the potential direct and indirect effects of this project on these resources. Surface waters are closely related to wetlands and floodplains, which are further addressed in Section 3.7, Wetlands and Floodplains.

3.6.1.1 Region of Influence

The ROI defines the extent of the areas where direct effects from construction and operation may be experienced, and it encompasses the areas where indirect effects from the proposed project would most likely occur. The ROI for surface water resources includes the surface waters that exist within the areas potentially affected by the construction and operation of the proposed project, consisting of the Meredosia Energy Center, the CO₂ pipeline, the CO₂ injection wells, and the proposed educational facilities. It also includes the surface waters that would receive stormwater and wastewater discharges from the construction and operation of the proposed project.

3.6.1.2 Method of Analysis and Factors Considered

DOE reviewed the proposed project to determine which construction and operational activities would have the potential to directly or indirectly affect surface waters. DOE also reviewed published studies and GIS-based data of surface water features within the ROI. DOE assessed the potential for impacts to surface waters based on whether the project would:

- Alter stormwater discharges, which could adversely affect drainage patterns, flooding, erosion, and sedimentation;
- Alter or damage existing farmland drainage infrastructure;
- Alter infiltration rates, which could affect (substantially increase or decrease) the volume of surface water that flows downstream;
- Conflict with applicable stormwater management plans or ordinances;
- Violate any federal, state, or regional water quality standards or discharge limitations;
- Modify surface waters such that water quality no longer meets water quality criteria or standards established in accordance with the CWA, state regulations, or permits; or
- Change the availability of surface water resources for current or future uses.

3.6.1.3 Regulatory Framework

The USEPA regulates water quality under the Safe Drinking Water Act (SDWA) and the CWA. Section 303(d) of the CWA requires states to identify and develop a list of impaired waterbodies. Impaired waterbodies are considered too polluted or otherwise degraded to meet the water quality standards or designated uses set by the state. Section 305(b) of the CWA requires states to assess and report the quality of their waterbodies. The IEPA monitors the waters of the state as required by the CWA and reports the results in the Impaired Waters of Illinois Integrated Report, published biennially in even-numbered years. This report lists impaired waterbodies under Section 303(d) indicating their total maximum daily loads (TMDLs) and their water assessment and designated use determinations under Section 305(b).

Total Maximum Daily Load (TMDL) is defined as the maximum amount of a pollutant that a waterbody can receive and still safely meet water quality standards. TMDLs are based on analyses that include pollution source identification and development of strategies for contaminant source reduction or elimination.

Stormwater and wastewater discharges are regulated by the IEPA under Sections 401 and 402 of the CWA (permitting requirements) through the NPDES permit program. The state's NPDES program is

modeled on the federal NPDES program, which requires stormwater to be treated to the maximum extent practicable. NPDES permits also include effluent limits and requirements for facility operation and maintenance, discharge monitoring, and routine reporting.

Many of the surface water resources addressed in this section qualify as waters of the U.S., which are regulated by the USACE under the CWA, because they are important for the preservation of navigable waterways and interstate commerce. Waters of the U.S. are subject to federal jurisdiction and permitting under Section 404 of the CWA and Section 10 of the Rivers and Harbors Act of 1899. Waters of the U.S. include all navigable waterways and their tributaries, as well as wetlands contiguous (connected) to and adjacent to those navigable waterways and tributaries.

Under Section 404 of the CWA, a USACE permit would be required for the discharge of dredged or fill material into waters of the U.S., which is often authorized by a Nationwide Permit or could be authorized by an Individual Permit. Construction of utility lines (e.g., pipelines) that would affect waters of the U.S. can be permitted with a Nationwide Permit (Number 12 – “Utility Line Activities”) if less than 0.5 acre of waters of the U.S. are disturbed, or an Individual Permit, if more than 0.5 acre is disturbed. Throughout the project area, federal regulations are enforced by either the USACE St. Louis or Rock Island District.

Construction within or alteration of (e.g., dredging activities, placement of fill material) a traditional navigable waterway (e.g., the Illinois River) below the defined ordinary high water mark requires USACE permitting under Section 10 of the Rivers and Harbors Appropriation Act. The ordinary high water mark is the highest level that a body of water maintains for a sufficient period of time to leave visual evidence (i.e., changes in character of soil, destruction of vegetation) on the shoreline.

3.6.2 Affected Environment

This section describes the surface water resources potentially affected by the construction and operation of an oxy-combustion facility at the existing Meredosia Energy Center, as well as those present within the potential CO₂ pipeline corridor and CO₂ storage study area, and the location for the proposed educational facilities. As discussed in this section, surface waters in these areas can be broadly classified as follows:

- Perennial Streams and Rivers: Waterbodies in which some water flows throughout the year.
- Intermittent Streams and Rivers: Waterbodies in which water flows for only part of the year and may come from groundwater or runoff (e.g., from rainfall). When not flowing, surface water may remain in isolated pools or may be absent.
- Ephemeral Streams and Rivers: Waterbodies in which water flows only during, and for a short duration after, precipitation events in a typical year. Runoff from rainfall is the primary source of water for streamflow; groundwater is not a source of streamflow.
- Ditches and Canals: Man-made waterbodies generally used for drainage or to convey stormwater (i.e., ditches and swales) or to provide water for irrigation or industrial use (i.e., canals).
- Lakes and Ponds: Naturally occurring or man-made waterbodies typically located in topographic low spots, that receive water from runoff (e.g., from rainfall) or other overland flow (e.g., creeks, streams, rivers) or from groundwater sources (i.e., springs and seeps) and generally do not flow.

Wetland areas (i.e., areas that are generally inundated or saturated by water and that support vegetation typically adapted to saturated soil conditions, such as swamps, marshes, bogs, and similar areas) may also occur within or around the perimeter of surface waterbodies. Additional details regarding wetlands are provided in Section 3.7, Wetlands and Floodplains.

Surface water systems are typically defined in terms of watersheds (also called basins). A watershed is a land area bounded by topography that drains water to a common destination. Watersheds vary in size; every waterway (stream, tributary, and river) has an associated watershed and smaller watersheds

combine to form larger watersheds. Any activity that affects water quality, quantity, or rate of movement at one location within a watershed has the potential to affect the characteristics of locations downstream.

The proposed project would be located within the Illinois River Basin (see Figure 3.6-1), which encompasses approximately 30,000 square miles, covering 44 percent of the land area of the state of Illinois (USACE 2007). Nearly 11,000 miles of perennial streams occur in the Illinois River Basin, with an estimated 20,000 to 25,000 additional miles of ephemeral streams (USACE 2007). The Illinois River Basin is divided into the Upper and Lower Illinois River watersheds. The proposed project would be located in the Lower Illinois River Watershed (HUC 07130011), which encompasses 17,960 square miles of central and western Illinois (USEPA 2011j; USDOJ/USGS 1994). This watershed extends from the downstream end of the Upper Illinois River Watershed at Ottawa, Illinois, to the confluence of the Illinois and Mississippi rivers at Grafton, Illinois. Major rivers in the watershed include the Illinois, Vermilion, Mackinaw, Spoon, Sangamon, and La Moine rivers.

The mean annual precipitation for the Lower Illinois River watershed is 35 to 39 inches and the mean annual precipitation at the Meredosia Energy Center is 38 to 39 inches (USGS 2011a). Precipitation and discharge from the Upper Illinois River watershed account for most of the inflow to the Lower Illinois River watershed. Discharge to the Illinois River across the watershed basin consists of return flow, surface runoff, and groundwater discharge. Return flow is water that has been released from a facility (e.g., discharges from industrial and municipal wastewater treatment facilities). The combined return flow, based on average annual discharge for all facilities, was 4,400 mgd in 1991 (USGS 2011a).

Major water quality issues in the Lower Illinois River watershed include sedimentation, toxic substances in sediment, high concentrations of nutrients and agricultural chemicals, and low dissolved oxygen concentrations. Sedimentation has resulted in the partial or complete filling of many lakes within the watershed. The Illinois River receives much of the state's human, animal, industrial, and agricultural wastes (USGS 2000c). As a result, contaminants detected in sediments from the Chicago metropolitan area in the Upper Illinois River have also been identified in sediments in the Lower Illinois River watershed. The Chicago area appears to be the source of these contaminants, which include the USEPA priority pollutants: arsenic, barium, chromium, lead, and mercury (Colman and Sanzolone 1991).

The Illinois River flows for a distance of 273 miles, entering the Mississippi River at Grafton, Illinois, approximately 40 miles north of St. Louis, Missouri. The Illinois River is the largest tributary to the Mississippi River above the mouth of the Missouri River (USACE 2007) and is a navigable link between Lake Michigan and the Mississippi River (USDOJ/USGS 1994). Water depth and flow in the Illinois River is maintained by a series of locks and dams (see Figure 3.6-2) (USDOJ/USGS 1994; USGS 2011a). The Alton, La Grange, Peoria, and Starved Rock pools are the reaches of stream (i.e., navigation pools) between the locks and dams from Grafton to Ottawa. The general change in stream elevation between locks and dams is 20 feet, and each pool is named for the dam immediately downstream. The Alton Lock and Dam are located on the Mississippi River and also regulate flow on the Illinois River.

3.6.2.1 Meredosia Energy Center

Surface waters located on the Meredosia Energy Center property are limited to fly and bottom ash ponds (these ponds are not part of the FutureGen 2.0 Project). The nearest natural surface water feature is the Illinois River, which is located immediately adjacent to the Meredosia Energy Center property, approximately 700 feet west of the proposed oxy-combustion facility. The USACE determined that the ordinary high water mark of the river in the area is 440 feet above sea level (see Appendix D, Wetlands Surveys [D1]). The Meredosia Energy Center is located between miles 70 and 71 on the Illinois River (USACE 1998), where the Illinois River ranges in width between approximately 1,000 and 1,200 feet. The La Grange Lock and Dam is the closest dam to the Meredosia Energy Center, located approximately 9 miles upstream (north).

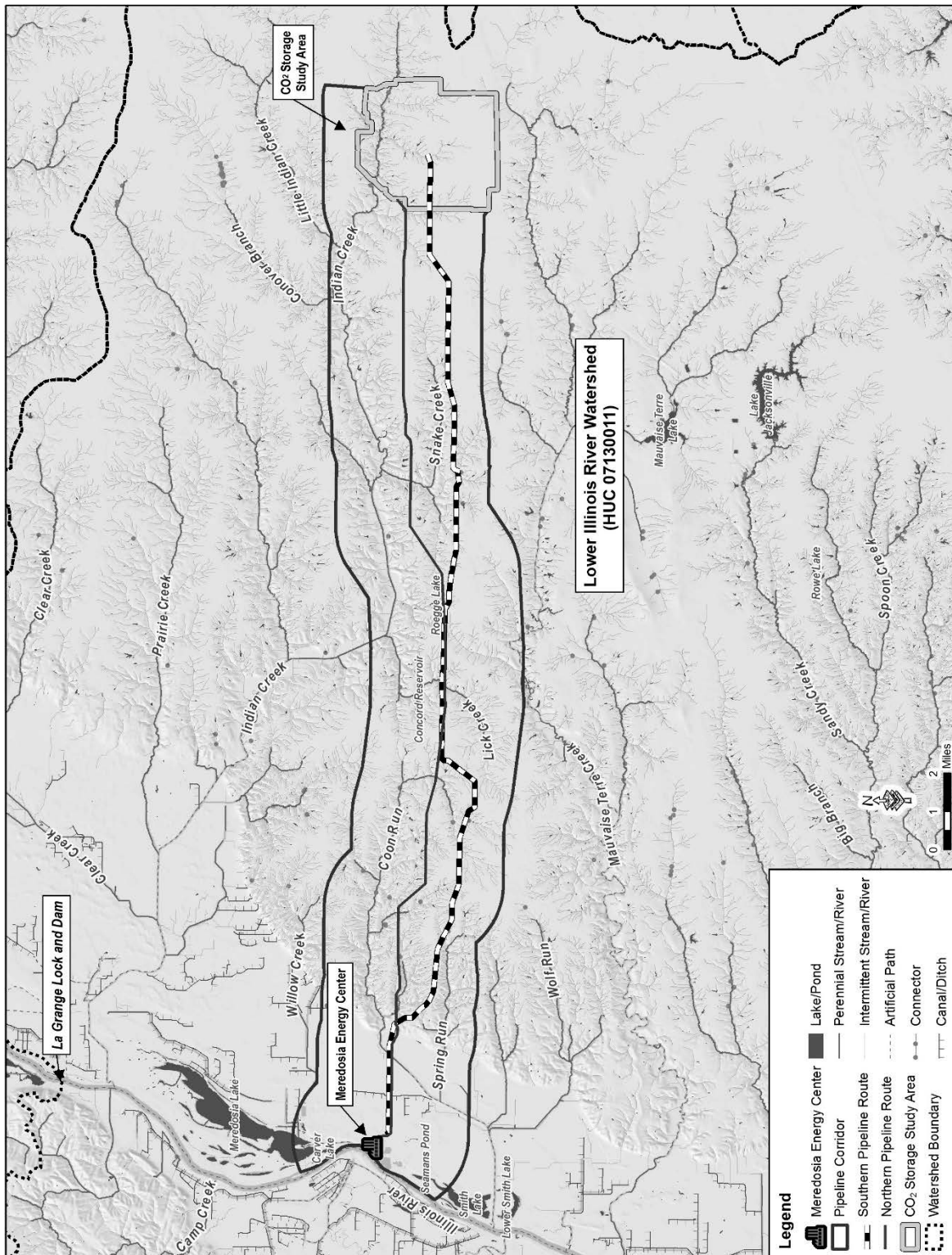

Source: USGS 2011a
 CO₂ = carbon dioxide

Figure 3.6-1. Watershed Boundaries and Surface Water Features in the ROI

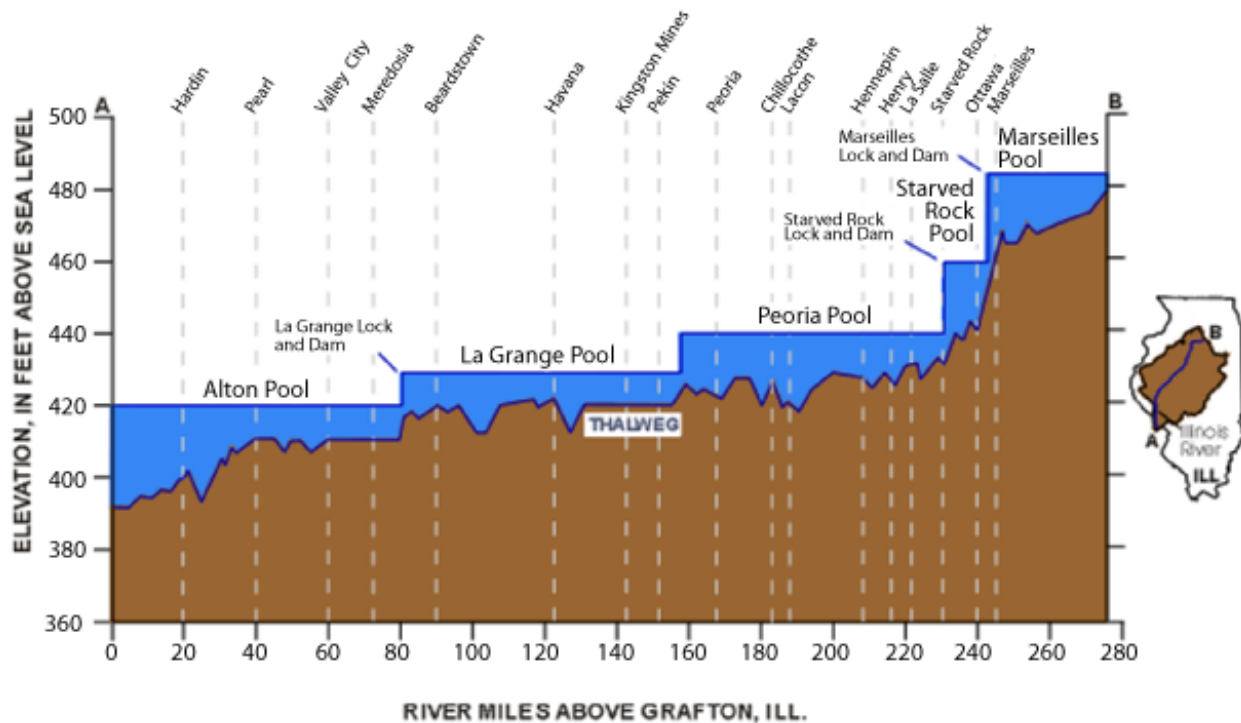

Source: USGS 2011a

Figure 3.6-2. The Elevation of the Lower Illinois River Watershed and Locations of the U.S. Geological Survey Surface Water Monitoring Stations

The Meredosia Energy Center is located along the Alton Pool portion of the Illinois River (see Figure 3.6-2). The Alton Pool extends from the confluence of the Mississippi and Illinois rivers (River Mile 0) to the base of the La Grange Lock and Dam (River Mile 80.2), for a total length of 80.2 miles. The Alton Pool is characterized by a dramatic loss in productive backwaters, side channels, and channel border areas due to excessive sedimentation and erosion, which limits the ecological health and alters the character of the river (IEPA 2010b).

The section of the Illinois River adjacent to the energy center is impaired due to mercury, PCBs, and fecal coliform contamination (IEPA 2012a; IEPA 2010b). This segment, a subsection of the Alton Pool described above, is identified as segment IL_D-32 by the USEPA. Table 3.6-1 summarizes the information from the 2010 and 2012 Impaired Waters of Illinois Integrated Reports related to the impairment (from Section 303(d) of the CWA) of the Illinois River in this area.

Table 3.6-1. Summary of Impaired Waters Data for Illinois River

Year Listed	Segment ID	Miles/Priority	Designated Use	Cause of Impairment
2010	IL_D-32	33.8/Medium	Fish Consumption	Mercury and PCBs
2010	IL_D-32	33.8/Medium	Primary Contact Recreation	Fecal Coliform
2012	IL_D-32	34.01/Medium	Fish Consumption	Mercury and PCBs
2012	IL_D-32	34.01/Medium	Primary Contact Recreation	Fecal Coliform

Sources: IEPA 2010b; IEPA 2012a
 PCBs = polychlorinated biphenyls

DOE reviewed streamflow data for the Illinois River upstream and downstream of the energy center to characterize flow rates. Table 3.6-2 summarizes this data, which shows that streamflow in the Illinois River is highly regulated by locks and dams. In addition, the minimum and maximum flow rates vary significantly, which demonstrates that the Illinois River is highly influenced by precipitation and surface runoff.

Table 3.6-2. Average Flow Rates of the Illinois River in Morgan County

Gauging Station Number	Gauging Station Location	Period of Record	Annual Flow Rate	Minimum Flow Rate (year)	Maximum Flow Rate (year)
05586100	Valley City, Illinois (MP 61.3)	October 1938 to Current	14,923 mgd	5,802 mgd (1940)	30,254 mgd (1993)
05585500	Meredosia, Illinois (MP 70.8)	October 1938 to September 1989	14,139 mgd	5,976 mgd (1940)	24,276 mgd (1973)
05568500	Kingston Mines, Illinois (MP 145.3)	October 1939 to Current	10,309 mgd	4,408 mgd (1964)	20,811 mgd (1993)

Sources: USGS 2011b; USGS 2010; USGS 2009a; USGS 2009b
 mgd = million gallons per day; MP = milepost

The 7-day, 10-year (7Q10) low-flow frequency value is a widely used measure of surface water availability. It represents the lowest streamflow for 7 consecutive days that would be expected to occur once in 10 years. The 7Q10 low-flow frequency value is determined by statistically analyzing streamflow data from USGS stream gauging stations. The 7Q10 low-flow value for the stream gauging station closest to the energy center (Meredosia gauge) was 2,391 mgd, while the 7Q10 low-flow value at a stream gauging station upstream of the energy center (Kingston Mines gauge) was 1,971 mgd (Singh et al. 1988).

At the end of 2011, operational activities at the Meredosia Energy Center were suspended. Until that time, the energy center pumped water from the Illinois River at an average rate of 217 mgd to support energy center operations. Water was drawn from a river water intake structure (with five separate intake bays) located at mile 70.8 in the Illinois River (USACE 1998). The design capacity for the intake structure is 414 mgd, which represents 17 percent of the 7Q10 low-flow rate for the river.

Prior to the suspension of operations at the Meredosia Energy Center, the facility generated approximately 189 mgd of wastewater from industrial processes. The treated wastewater and stormwater from the site was discharged to the Illinois River at eight locations (outfalls) under NPDES Permit No. IL0000116. The NPDES Permit was renewed on September 30, 2011 (IEPA 2011d). **An application to modify this permit based on the proposed future operations at the energy center was submitted to IEPA on June 20, 2013. This application is discussed further in Section 3.6.3.2.** The existing (2011) permit covers eight discharges (outfalls) to the river and includes the following:

- Outfall 001 – Condenser cooling water (Units 1, 2, and 3)
- Outfall A01 – Boiler blowdown
- Outfall 002 – Cooling tower blowdown
- Outfall A02 – Cooling tower emergency overflow
- Outfall 003 – Bottom ash pond discharge
- Outfall A03 – Chemical metal cleaning wastewater
- Outfall 004 – Fly ash pond discharge

- Outfall 006 – Intake screen backwash

From 2006 to 2010, there were two exceedances of NPDES permit discharge limitations, both for total suspended solids only. One exceedance occurred in 2008 at discharge point (Outfall) 003 and the other in 2009 at discharge point (Outfall) 004 (IEPA 2011d). There have been no exceedances of permit discharge limits since the permit was renewed in September 2011. The location of each outfall at the Meredosia Energy Center is depicted on Figure 2-4 in Chapter 2.

3.6.2.2 CO₂ Pipeline

The proposed CO₂ pipeline corridor from the Meredosia Energy Center to the CO₂ storage study area is approximately 26 miles in length and 4 miles in width (see Figure 3.6-1) (note that the total length of the CO₂ pipeline would be approximately 30 miles and the operational pipeline ROW would be 50 feet wide). Table 3.6-3 summarizes the existing surface water features within the CO₂ pipeline corridor. These surface water features are located within the Lower Illinois River watershed and ultimately drain to the Illinois River. The Alliance identified two possible pipeline routes from the energy center to the western border of the CO₂ storage study area in which the injection wells would be located. These are referred to as the southern route and northern route. As discussed in Section 2.5.1.1, the Alliance’s proposed option is the southern route.

Table 3.6-3. Surface Waters within the CO₂ Pipeline Corridor

Surface Water	Distance/Area
Streams	(miles)
Perennial Streams and Creeks	66.4
Intermittent Streams	624.0
<i>Impaired Streams</i>	16.9
Waterbodies	(acres)
Ponds and Lakes	484.1
<i>Impaired Waterbodies</i>	0.0

Sources: USEPA 2012e; USGS/USEPA 2011
 CO₂ = carbon dioxide

The CO₂ pipeline corridor includes a total of approximately **690** miles of perennial and intermittent waterways and **484** acres of ponds and lakes (Table 3.6-3). Major streams within the corridor include Willow Creek, Coon Run, Spring Run, Indian Creek, Lick Branch, Snake Creek, and Conover Branch. A levee (dike) has been constructed along a portion of Coon Run, which extends from the Illinois River to U.S. Highway (US-) 67 (State Route 100), approximately 3 miles east of the Meredosia Energy Center.

Two of the perennial streams within the pipeline corridor are impaired; the Mauvaise Terre Creek (also called Mauvaise Terre River) and Indian Creek. The Mauvaise Terre Creek runs along the southern boundary of the pipeline corridor just east of Jacksonville with tributaries extending further north into the pipeline corridor. The Mauvaise Terre Creek supports aquatic life and is impaired due to turbidity and mercury (IEPA 2010b; IEPA 2012a). Approximately 1.7 miles of Mauvaise Terre Creek is located within the pipeline corridor. A 15.1-mile-long section of Indian Creek, which flows through much of the eastern half of the pipeline corridor, supports aquatic life and is impaired due to habitat alterations. Impairment due to habitat alteration indicates that adverse changes to the stream environment, including channelization, absence of streambank vegetation, bank failure, and heavy erosion, have significantly affected the waterbody and may limit its ability to support aquatic life.

3.6.2.3 CO₂ Storage Study Area

Indian Creek and its associated tributaries flow through the northern half of the 6,800-acre CO₂ storage study area from east to west. The entire section of Indian Creek within the CO₂ storage study area (approximately 3 miles in length) is impaired from habitat alteration. The CO₂ storage study area also includes approximately 52 miles of intermittent streams and 14 acres of ponds and lakes, none of which are listed as an impaired waterbody. Table 3.6-4 summarizes the existing surface water features within the proposed CO₂ storage study area.

Table 3.6-4. Surface Waters within the CO₂ Storage Study Area

Surface Water	Distance/Area ^a
Streams	(miles)
Perennial Streams and Creeks	3.3
Intermittent Streams	51.9
<i>Impaired Streams</i>	3.0
Waterbodies	(acres)
Ponds and Lakes	14.2
<i>Impaired Waterbodies</i>	0.0

Sources: USEPA 2012e; USGS/USEPA 2011

^a The CO₂ storage study area was originally analyzed in the Draft EIS as a 5,300-acre area. Since the Draft EIS was issued, the Alliance expanded the study area to 6,800 acres to allow for additional flexibility for CO₂ injection. Refer to section 2.5.2 for additional details about the CO₂ storage study area. This table reflects data based on the updated 6,800-acre storage study area.

CO₂ = carbon dioxide

3.6.2.4 Educational Facilities

Visitor, research, and training facilities (also referred to as the educational facilities) would be provided at a suitable location in the Jacksonville area. Jacksonville is approximately 10 square miles in size, of which approximately 0.2 square mile is covered with surface water (U.S. Cities 2012). Major surface waters in Jacksonville include Mauvaise Terre Creek, Jacksonville Lake, and Mauvaise Terre Lake.

3.6.3 Impacts of Proposed Action

This section summarizes potential impacts to surface waters that could result from the construction and operation of the proposed oxy-combustion facility, CO₂ pipeline, CO₂ injection wells and associated infrastructure (e.g., access roads). This section also discusses impacts to surface waters that would result from the construction and operation of the proposed educational facilities. DOE assessed the potential for impacts to surface water resources based on whether the proposed project would result in any of the effects identified in Section 3.6.1.2. Impacts are limited to those associated with water quality as well as the availability and use of surface water resources. Section 3.7, Wetlands and Floodplains, addresses impacts to wetlands in terms of impacts related to the placement of fill material, type conversions, and surface disturbances, which can ultimately affect the functions and values of these resources (e.g., flood flow attenuation).

3.6.3.1 Construction Impacts

Many of the general construction activities for the proposed project would be similar in nature; therefore, the potential impacts to surface water resources from these construction activities would also be similar, regardless of where or when the construction takes place. This section summarizes potential impacts resulting from general construction activities, while the remaining subsections address impacts related to

construction specific to the energy center, CO₂ pipeline, injection wells, and proposed educational facilities.

Initial construction activities for the proposed project would consist of clearing vegetation and leveling areas, which would expose soil and make it susceptible to erosion. Stormwater runoff from construction sites has the potential to carry the exposed soils offsite, resulting in increased sedimentation and turbidity to receiving waters downstream. Additionally, stormwater runoff from construction sites has the potential to be contaminated by hazardous materials, such as fuel, that are used onsite. These types of impacts would increase during heavy rains or during snowmelt due to the increase in stormwater runoff.

Stormwater runoff from construction sites is regulated by the IEPA and the IDNR under Sections 401 and 402 of the CWA (permitting requirements) and implemented through NPDES permits. For the components of the proposed project that would require more than 1 acre of disturbance and that are not currently regulated by an NPDES permit, an NPDES General Permit from the IEPA would be required prior to construction activities. The NPDES General Permit for construction would require the preparation of a SWPPP that includes BMPs for erosion control and pollution prevention. The NPDES permit would also require that the construction standards outlined in the IEPA Urban Manual be followed, including material specifications, planning principles, and procedures (AISWCD 2012).

The SWPPP would describe all of the BMPs to be followed during construction. Typical BMPs that could be used to minimize impacts on surface waters during construction are listed below:

- Use silt fencing and other erosion control devices to prevent soils and debris from entering nearby streams during construction.
- Except on cropland, use temporary seeding and mulching or matting to produce a quick ground cover to reduce erosion on exposed soils that may be re-disturbed or permanently stabilized at a later date. This would minimize bare soil available for sediment transport during storm events.
- Use gravel or stones to stabilize temporary access roads, haul roads, parking areas, laydown areas, material storage areas, and other onsite vehicle transportation routes immediately after grading. This practice would reduce erosion and the need for subsequent regrading of temporary and permanent roadbeds, work areas, and parking areas rutted by construction traffic during wet weather.
- Maximize use of existing roads when planning site access.
- Keep construction materials, debris, construction chemicals, construction staging, fueling, etc. at a safe distance from surface waters to prevent unintentional contamination and keep spill kits on hand in case of spills to reduce response time.
- Where practical, consider weather and ground conditions when scheduling construction activities to minimize potential impacts to surface waters, such as erosion and the spread of contaminants that may be exacerbated by sheet flow during storm events.
- Locate construction staging, parking, and equipment storage activities in areas already disturbed by past construction activities to minimize the need for additional land disturbance.
- Use water conservation measures to the extent practicable (e.g., efficient landscaping and recycling wastewater).
- After construction, re-seed all temporarily disturbed areas with indigenous species to re-establish vegetative cover, except on cropland.

In addition, the Alliance intends to drill under all waterbodies, except perhaps for **certain ephemeral or intermittent** streams that would be trenched only when **seasonally** dry. With implementation of BMPs as a condition of the NPDES General Permit and drilling under all waterbodies, it is anticipated that impacts

to surface waters during construction would be temporary and minor. Proper project design would ensure that drainage and runoff would occur without excessive erosion and increased turbidity.

Meredosia Energy Center

As described in Chapter 2, construction would take place in several areas of the Meredosia Energy Center and nearby offsite areas, as shown on Figure 2-14 and Figure 2-15. **Figure 2-14 depicts the extent of impact areas based upon the project design presented in the Draft EIS, while Figure 2-15 depicts the reduced impact areas based upon project design revisions that occurred after the Draft EIS was issued.** As no surface waters exist within the footprint for the oxy-combustion facility and the construction laydown areas, no direct impacts to surface waters would occur **under either the original or the revised project design.** Temporary indirect impacts resulting from potential stormwater runoff to the Illinois River from areas of construction would be consistent with those described above for general construction. Development of impervious surfaces in areas that were previously pervious (e.g., grassy areas) would cause an increase in stormwater runoff; however, this effect would be negligible, as a majority of stormwater would be routed to **an existing stormwater detention area** (see Section 2.4.2.2).

No water would be withdrawn from surface waters on or adjacent to the site to support construction activities. Water required during construction (for mixing concrete, dust suppression, washing tools and machinery, etc.) would be supplied by onsite groundwater wells and city water; therefore, the availability of surface water resources would not be impacted by construction.

The temporary barge unloading facility (see Section 2.4.3.2) would be located on the eastern bank of the Illinois River. **The Draft EIS evaluated two options** for barge unloading operations: (1) using mooring dolphins or (2) grounding the barges on the river bottom. The use of mooring dolphins would require the installation of support piles into the riverbed and subsequent removal at the end of the barge delivery phases. Each of the 3 to 5 pilings that would be required for this option would be up to 48 inches in diameter. Pile driving is likely to stir up sediments that would be carried downstream, as would also occur during removal of the pilings. The suspension of sediment would increase turbidity locally, but the river current would provide some dilution. Dissolved oxygen demand could increase locally with the suspension of anaerobic sediments. Given the small amount of sediment resuspension expected to occur during pile driving (and later removal), it is anticipated that temporary direct impacts to the Illinois River would include minor increases in turbidity during construction. It is also possible that sediments contaminated with mercury and PCBs could be resuspended, which could temporarily increase the concentrations of these contaminants in the water column during construction. Overall, the construction of the pilings for the barge unloading facility and subsequent removal would result in minor temporary impacts to water quality in the Illinois River during the construction and removal events.

The second option for the barge unloading facility, grounding the barges, would require that large objects (e.g., boulders) be removed from the river bottom to ensure that they do not puncture the barge during unloading. If necessary, rip-rap or other suitable material would be placed on the river bottom to provide a foundation for the barge and prevent damage to the barge. This option could result in the disturbance of up to 18,360 square feet of the river bottom and bank. Disturbance would occur during the installation of rip-rap on the river bottom (and subsequent removal at the end of construction) or during each grounding and unloading event (in the event that rip-rap is not used). These disturbances and the potential installation of rip-rap on the river bottom would result in increased turbidity and temporary streambed disturbance. These impacts would be similar in nature to those described for the installation of pilings but would occur over a larger area of the streambed.

Implementation of either of these options would require a permit from USACE under Section 10 of the Rivers and Harbors Act for construction of the temporary facility and for the potential temporary placement of fill material. It is possible that a Section 404 Permit (Nationwide Permit 33) may also be required depending upon the option selected and the specific nature of the activities; however, the specific permit(s) needed will be confirmed after the design has been finalized and prior to construction. It is also

possible that these permits could be applied for as part of an Individual Permit application that could cover other regulated activities related to the proposed project.

After construction, any rip-rap or other temporary fill material would be removed from the river. This would create additional turbidity and increased streambed disturbance, resulting in additional minor temporary impacts.

The Alliance is also evaluating options for unloading equipment from barges that would avoid potential impacts by using a combination of on-shore equipment, tugs, and temporary ramps so that there would be no disturbance to the bank or bottom of the Illinois River. **Under this scenario, a portion of the temporary ramp may extend into the river to form a usable platform between the edge of the barge and the existing boat ramp. This temporary ramp might extend 20 feet from the shoreline, although it has not yet been defined. River currents at the boat ramp area are usually mild, and there would be no need for filling, dredging, or modifications to the shoreline. Heavy equipment or haul trucks parked above the boat ramp could be used as temporary mooring devices for the barges. However, these plans are still under development and are being reviewed for their feasibility. Because the Alliance has not thoroughly determined the feasibility of this alternative scenario or developed a preliminary design, the Final EIS considers the impacts presented in the Draft EIS as representing appropriate, upper bounds for the barge unloading operations during construction of the oxy-combustion facility.**

CO₂ Pipeline

As described in Chapter 2 and in further detail below, DOE would use one of three primary methods to construct the pipeline in areas of surface water features. The method used to construct pipeline crossings would be dependent upon the size of the stream or waterbody to be crossed, as well as the presence or absence of water within the feature (e.g., seasonally dry ephemeral and intermittent stream channels). The three methods to be used by DOE include horizontal directional drilling, jack and bore tunneling, and dry trenching.

Horizontal directional drilling would be used to cross major waterbodies (i.e., crossings of perennial streams, and ponds and lakes, greater than 100 feet in width). As necessary, geotechnical investigations would be performed prior to the use of horizontal directional drilling to ensure that subsurface conditions can safely support drilling operations. Horizontal directional drilling would not disturb the bed or bank of the waterbody that would be crossed, thereby eliminating impacts such as increased turbidity and sedimentation. However, it could still present a remote potential for surface disturbance through inadvertent drilling fluid releases, as well as minor increases in sedimentation and turbidity from ground vibrations caused by drilling adjacent to the stream. An unexpected release of drilling mud (consisting primarily of water and bentonite, a naturally occurring clay) to the environment could occur if a natural fracture or unconsolidated area in the ground is encountered. Therefore, primary factors in selecting the pipeline crossing profile include the type of soil and rock in the geological material and the depth of cover material. Impacts resulting from horizontal directional drilling are expected to be minor, since geotechnical investigations and adequate planning would be conducted to reduce the likelihood of any releases of drilling fluid.

Jack and bore tunneling (also known as pipe ramming) would be used for crossings of smaller perennial streams and wetlands, as well as intermittent and ephemeral streams that contain water at the time of construction. The jack and bore tunneling method involves the use of a horizontal bore machine or auger to drill a hole and a hydraulic jack to push a casing through the hole under the crossing. As the bore proceeds, a steel casing pipe would be jacked into the hole; then the pipeline is installed in the casing. The casing would be jacked using a large hydraulic jack in a pit located at one end of the crossing. The jack pit would be excavated and shored. Similar to horizontal direction drilling, jack and bore tunneling would involve no disturbance to the bed or bank of the stream being crossed, eliminating impacts related to stream diversion. Impacts from jack and bore tunneling would be minor and limited to increased turbidity

and sedimentation resulting from stormwater runoff from the jack and bore pits on either side of the stream.

Dry trenching would be employed for narrow intermittent and ephemeral stream channels that are devoid of water at the time of construction, such as when a stream feature is seasonally dry or is frozen to the bottom. A field assessment would be made prior to construction at each crossing to determine the presence of water, and weather forecasts would be monitored to evaluate the potential for precipitation events that could lead to temporary water flow within the stream channel. Dry trenching would consist of excavating a trench through the stream channel, laying the pipe down, and then burying the pipe with the spoils removed during trench excavation. The pipeline crossing would be as nearly perpendicular to the stream channel as possible to minimize overall linear disturbance to the stream channel. After pipeline installation, the surface would be regraded to match pre-construction contours, which would allow the stream channel to continue to function without permanent impacts to surface water flow. BMPs required through Section 404 permitting (i.e., Nationwide Permit No. 12, Utility Line Activities) would be implemented both during and after construction. The BMPs would reduce temporary minor impacts by ensuring that stream crossings are restored to their original grade to stabilize streambanks post construction. Dry trenching would cause temporary direct and indirect disturbances to stream channels and streambanks during trench excavation and pipe installation.

For the purposes of analysis **in the Draft EIS**, DOE conservatively assumed that all surface waters within the 50-foot operational ROW would be drilled underneath for placement of the pipeline. Furthermore, any streams located outside of the operational ROW, but within the construction ROW (80 to 100 feet), would be avoided to the maximum extent practicable. In the event that avoidance of surface waters within the construction ROW is determined to be impracticable, temporary impacts to surface waters would be minimized and mitigated as necessary. Pipeline attributes (e.g., ROW width, pipe size, etc.) and methods of installation (e.g., horizontal directional drilling, jack and bore, or dry trenching) would be essentially the same for each potential pipeline route. Therefore, the type of construction impacts would be the same for each route; however, the magnitude of potential temporary impacts would be dependent upon the number of dry stream crossings that would be required.

Table 3.6-5 summarizes the types and quantities of stream crossings that would be required for each pipeline route based upon GIS mapping data. A subsequent investigation of the proposed southern pipeline route conducted by the Alliance identified far fewer streams within the ROW; the results of this investigation are discussed in further detail later in this section. Since the release of the Draft EIS, the Alliance identified the location of the injection well site (see Section 2.5.2.3). As a result, DOE updated the number of waterbodies shown in Table 3.6-5 (based on GIS mapping) to account for the Alliance's currently proposed southern pipeline routing from the Meredosia Energy Center to the proposed injection well site.

As discussed in Chapter 2, additional easements have been identified along the southern pipeline route that would be used to support trenchless drilling and boring activities. These easements represent construction areas that would be required on either side of a crossing. The total area of all of these easements would be approximately 26 acres and would intersect with one stream. A 0.1-mile section of intermittent stream is located within the additional easement areas. This value has been included in Table 3.6-5. Impacts to this stream would be similar to those addressed above for intermittent stream crossings.

The Alliance has not defined any additional routing for the northern route to the proposed injection well site, since it is no longer under consideration. In order to facilitate a representative comparison of the two routes, Table 3.6-5 presents the number of surface water crossings for the northern route including crossings through the CO₂ storage study area based on hypothetical routing scenarios analyzed in the Draft EIS. As explained in Section 3.0, DOE used these hypothetical siting scenarios to evaluate a range of potential impacts, whereby some hypothetical routes would have less impact

to physical resources and others would have greater impact, while still representing reasonable routes. Impacts related to the crossing of intermittent and ephemeral streams using dry trenching would be consistent with those presented above. There would be no impacts associated with stream channels that would be avoided using horizontal directional drilling or jack and bore tunneling.

Table 3.6-5. Surface Water Crossings for Pipeline Routes (GIS-based)

Surface Waters	Southern Route		Northern Route	
	Total Crossings	Total Distance of Crossings ^a (miles)	Total Crossings ^b	Total Distance of Crossings (miles)
Streams				
Perennial Streams	2	0.04	8	0.2
Intermittent Streams	82	1.7	85	1.8
<i>Impaired Streams</i>	0	0	0	0
Waterbodies				
Perennial Lakes and Ponds	1	0.1	2	0.2
Intermittent Lakes and Ponds	1	0.2	0	0
<i>Impaired Waterbodies</i>	0	0	0	0

Sources: USEPA 2012e; USGS/USEPA 2011

^a. Includes 0.1 mile of intermittent stream located within additional easement areas outside of the primary construction ROW that would be required to facilitate construction equipment and activities at areas of trenchless drilling or boring.

^b. The numbers of crossings listed here represent the most conservative number of such crossings based upon the range of impacts identified in the analysis of the hypothetical end-of-pipeline spurs.

Note: The number of waterbody crossings listed in this table is based solely on GIS data from the National Hydrologic Dataset. This provides a conservative estimation of the number of features crossed by each pipeline route. The Alliance conducted a survey of waterbodies and wetlands along the southern pipeline route in spring 2013, which confirmed the presence of 2 perennial streams and only 13 intermittent streams (significantly fewer than the number identified via GIS mapping), as well as many ephemeral streams, ditches, and swales. Horizontal directional drilling or jack and bore technology would be used for all surface water crossings, except for dry intermittent or ephemeral streams.

In order to confirm the presence and extent of streams and other waterbodies, the Alliance conducted a formal wetland survey (delineation) of the southern pipeline route (proposed option) in spring 2013 (after the Draft EIS was published) in accordance with USACE delineation methodology. A similar investigation was not conducted for the northern pipeline route, as it is no longer under consideration by the Alliance. The wetland delineation, which included surface waterbodies (i.e., open water wetlands), confirmed the presence of two perennial streams within the southern route. The investigation also identified a total of only 13 intermittent streams within the proposed southern route (significantly fewer than the number identified via GIS mapping as analyzed in the Draft EIS and depicted in Table 3.6-5), as well as many ephemeral streams, ditches, and swales. The Alliance will use this information to submit a jurisdictional determination request to the USACE prior to construction. The USACE will ultimately determine which features are considered waters of the U.S. and which features may be considered intermittent versus ephemeral. The final wetland determination will also be used as part of a Nationwide Permit No. 12 application for the project. If any significant changes occur to the final southern route or if another pipeline route would be selected, the Alliance would conduct a formal wetland delineation of the final CO₂ pipeline route prior to construction.

The Alliance intends to avoid the surface water features during construction by employing the various trenchless technologies for the pipeline installation, as described earlier. Based on the results of the delineation described above, the Alliance indicated a projected total of 13 major pipeline crossing locations involving wetlands and/or surface waterbodies, some of which involve two or more co-located features, which would require horizontal direction drilling and/or jack and

bore tunneling in the currently proposed southern route. The exact number, type, and length of crossings would ultimately depend on the final pipeline route.

For either of the potential routes, the CO₂ pipeline would cross beneath the Coon Creek Dike. For this crossing, the Alliance would be required to obtain permission from the USACE. In addition, the Alliance would likely be required to consult with the Coon Run Levee and Drainage District prior to construction. The dike and the creek would be crossed using horizontal directional drilling and no direct impacts to the waterway would be anticipated.

In the event that the Alliance finds it necessary for the pipeline route to deviate from the southern pipeline route, impacts would be consistent with those addressed in this section, as the same siting criteria would be followed. In the event that the final pipeline routing would result in additional impacts to surface water resources, impacts would be temporary and minor, since they would be limited to the construction period and the Alliance would follow the construction processes and permitting requirements addressed earlier in this section.

Hydrostatic Testing

The construction of the CO₂ pipeline would require hydrostatic testing to certify the integrity of the pipeline before it can be put into operation. Hydrostatic testing would be performed in accordance with DOT pipeline safety regulations. If water is used, the pipeline would be filled with water and pressurized to check for any pressure loss that may indicate a leak. Table 3.6-6 summarizes the estimated amounts of water that would be required to support hydrostatic testing for both the southern and northern pipeline routes. These estimates represent a worst-case scenario and are based on the assumption that 31,000 gallons of water would be required for each mile of pipeline, that the entire pipeline would be a **nominal** 12 inches in diameter, and that no reuse of water would occur. Actual pipeline sizing would be determined during final engineering. If a smaller diameter pipeline were used, then less water would be required to support testing. **The proposed southern pipeline route would require slightly less water than the northern pipeline route based upon the potential maximum length of the northern route (including hypothetical end-of-pipeline spurs).**

Table 3.6-6. Hydrostatic Water Needs for Pipeline Routes

Pipeline Route Options	Length (miles)	Water Needs (gallons)
Southern Pipeline Route	27.6	855,600
Northern Pipeline Route	28.7	889,700

Water to support hydrostatic testing may be supplied from local streams or trucked in; however, sources for hydrostatic testing water have not yet been identified. In the event that water is withdrawn from local streams, a water use (appropriation) permit from the IDNR would likely be required, since any withdrawal of more than 10,000 gpd or 1 million gallons per year is required to be permitted. No chemicals would be added to the water used to test the pipeline. In the event that hydrostatic testing water is withdrawn from streams, it would cause temporary minor impacts to the streams from which it is withdrawn, due to the diversion of flow that would occur to support the water withdrawal. Water withdrawals from surface waterbodies would only occur at features with sufficient flow to sustain such withdrawals without permanent impacts. Any such withdrawals would be conducted in compliance with water use permit requirements.

Hydrostatic testing water that could not be reused would likely be discharged to local waterways under an NPDES permit from the IEPA or to an existing treatment facility. Sampling of the water would occur prior to discharge if required by the NPDES permit or receiving facility. The results of sample analysis would determine the fate of the discharge water. Since the hydrostatic testing would occur in virgin pipe

prior to implementation, it is not anticipated that unacceptable concentrations of contaminants would be present in the effluent. Since any disposal of hydrostatic testing water would occur in compliance with NPDES permit conditions, only minor temporary impacts to local surface water resources would occur from the disposal of hydrostatic test water.

CO₂ Storage Study Area

In the Draft EIS, DOE analyzed a dual-site injection well scenario, which would involve two injection well sites with one vertical injection well at each site. During the preparation of the Draft EIS, the Alliance modified its injection well design. The Alliance now proposes a single-site injection well scenario, which consists of one injection well site containing four horizontal injection wells located within one well pad.

Under the single-site scenario now proposed by the Alliance, only one building would be constructed at the injection well site. This building, known as the site control and maintenance building, would house the well annulus maintenance and monitoring system equipment. Other features of the surface facilities would include meters, surface piping, and piping-related equipment such as pig launchers. The conceptual layout for the injection well site includes a gravel well pad, the site control and maintenance building, and a parking lot connected to Beilschmidt Road by two access roads.

The updated design for the single-site scenario would affect up to 15 acres of land for construction of the injection wells and associated facilities, and up to 4 acres for the access roads. An additional 24 acres would be affected during staging and construction of the monitoring well network, which would include monitoring wells (see Figure 2-26). For the dual-site scenario analyzed in the Draft EIS, which is no longer being considered by the Alliance, construction activities would affect up to 28 acres for the injection and monitoring wells and associated facilities, and up to 64 acres for the staging and construction of access roads. See Section 2.5.2.2 for additional details about the proposed surface facilities.

The proposed location for the injection well site under the single-site scenario (the proposed option) is depicted in Figure 2-20 and intersects approximately 0.1 mile of an intermittent stream. The Alliance indicated that this stream, an unnamed tributary to Indian Creek, and the adjacent wooded area in the southwest corner of the proposed location would remain undisturbed during construction; therefore, no direct impacts to surface waters would occur under this option. However, the location(s) of the injection wells has not yet been finalized. It is anticipated that the Alliance would conduct a formal wetland delineation at the selected injection well site(s) prior to construction.

Direct and indirect impacts to surface water resources located in close proximity to the injection well site would be consistent with those described above for general construction impacts. Construction could cause temporary, indirect impacts to adjacent surface waters (including the unnamed tributary to Indian Creek depicted in Figure 2-20), such as increased sedimentation and surface water turbidity from runoff. These impacts would be minimized or avoided using BMPs as outlined in the NPDES and UIC permits (see Section 2.5.2.3).

Construction of the injection wells and monitoring wells would require fresh water to support drilling operations. The Alliance estimates that **up to a total of 8.68 million gallons of water could be required to drill and cement four horizontal wells**. The monitoring wells would likely require an amount less than this, since they would be smaller in diameter and shallower than the injection wells. The fresh water for well construction would be obtained from the North Morgan County Water Co-Op, as it was for the stratigraphic test well. The North Morgan County Water Co-Op obtains its water from the city of Jacksonville, which obtains raw water from groundwater and surface water sources. As a result, negligible impacts to surface water availability would occur due to the construction of the injection and monitoring wells.

Construction of the wells would result in the generation of wastewater, including brine, requiring disposal. For the injection wells and any deep monitoring wells, the groundwater withdrawn during well development would be very saline and would require measures to prevent this water from reaching surface waterbodies. These measures could include pre-treatment before discharge to surface water or direct removal of the withdrawn water by a tanker truck offsite. Lined earthen pits would contain any excess fluids generated during drilling, discarded water used in the cementing process, and spent drilling mud from mud change-outs. The pits would be lined with 30-mil high-density polyethylene plastic sheeting with welded seams to prevent infiltration of fluids into the subsurface. By appropriately storing and managing wastewater, potential runoff to nearby streams would be avoided. Potential impacts to surface waters from the construction of the wells would be short term and negligible based on the fluid-handling procedures employed during the well construction process.

Construction of access roads to the injection well site(s) from existing roadways could result in the need for additional stream crossings; however, the Alliance would use existing roads to the maximum extent practicable to avoid the need to construct access roads over streams. DOE does not anticipate that any perennial streams would be crossed to support the construction of access roads, since existing public roads are present throughout the CO₂ storage study area. Stream crossings would be limited to ephemeral and intermittent streams, which would be culverted. The construction of access roads over these features could result in minor to moderate temporary adverse impacts to these streams. BMPs required through Section 404 permitting (i.e., Nationwide Permit No. 12, Utility Line Activities) would be implemented both during and after construction. The BMPs, including a combination of stabilization and structural erosion and sediment control methods, would be implemented to reduce temporary impacts by controlling sedimentation and turbidity and to stabilize streambanks after construction. Key aspects of the BMPs are to control both surface and subsurface slope drainage, minimize slope erosion, and minimize or prevent channel erosion at stream crossings. Specific types of structural BMPs include installing temporary control structures such as sediment traps and filter fences.

Educational Facilities

As discussed in Section 2.5.3, the specific locations of the educational facilities are currently unknown, but would be located in the Jacksonville area. This proposed component would require approximately 3.5 acres of land and could involve new construction, rehabilitation of existing structures, or a combination of both types of construction activities. If development of the educational facilities involves new construction, it would most likely occur on previously disturbed land with existing utility connections. As such, it is unlikely that that direct impacts on surface waters would occur. Since the location of the educational facilities is flexible within Jacksonville, it is anticipated that sites with surface water features would be avoided. Potential indirect impacts to adjacent surface water features related to the construction of the educational facilities would be consistent with those addressed above for general construction activities. These impacts would be short term and minor with BMPs applied as described above for general construction activities.

As described in Sections 2.5.3 and 3.0, since the release of the Draft EIS, discussions between the Alliance and Jacksonville civic authorities have focused on a potential site in Jacksonville for the educational facilities. Because the locations of the educational facilities currently remain unknown, DOE cannot characterize existing surface water resources.

3.6.3.2 Operational Impacts

Impacts common to the operation of the proposed project would include water quality impacts to local streams from stormwater runoff generated at these facilities, which generally consist of increased sediment and contaminants entering these waterbodies from surface sources and increased flow due to an increase in impervious cover. Adequately designed stormwater collection and distribution systems and pollution prevention measures would reduce or eliminate the potential for these operational impacts to surface water resources. Adherence to applicable laws, regulations, policies, standards, and BMPs would

also help avoid and minimize potential adverse operational impacts to surface waters; therefore, impacts to water quality from typical operations would be minor.

As with any industrial activity, there is potential for surface water contamination from spills of fuels, lubricants, and coolants used by vehicles or heavy equipment for maintenance and operations at the Meredosia Energy Center, CO₂ pipeline, or the CO₂ injection wells. The Alliance would implement a SWPPP (if required), SPCC plan, and BMPs during maintenance activities to avoid or minimize potential impacts to surface waters from accidental spills of fuel, fuel constituents, and other materials. Taking into account the spill prevention and response procedures and BMPs that would minimize the potential for spills to affect surface water resources, DOE anticipates that potential impacts to surface water quality would be minor.

The remainder of this section addresses potential impacts from operations specific to each element of the proposed project.

Since the Draft EIS was published, project design changes have occurred. As a result of these changes, a modified NPDES permit application was prepared and submitted by the Alliance to the IEPA on June 20, 2013. The modified permit application contained revised estimates regarding water withdrawal volumes from the Illinois River; water discharge volumes to the Illinois River; and constituent loads within discharges from several outfalls at the energy center. These changes are addressed in this section.

Meredosia Energy Center

Stormwater runoff not exposed to industrial pollutants would be directed to an existing stormwater detention area that would be managed by Ameren. The location of the existing stormwater detention area is depicted on Figure 2-13. This detention area would store noncontact, non-industrial stormwater runoff (i.e., stormwater runoff not exposed to industrial pollutants). The collected water would naturally evaporate and infiltrate into the groundwater system. Runoff would be conveyed using surface drainage; however, it is likely that some newly constructed stormwater inlets and underground storm sewers would be required. Minor indirect impacts of sedimentation could occur as a result of any construction activities associated with the installation of any new stormwater conveyances; however, these impacts would be short term and minimized through the implementation of the SWPPP required for NPDES permitting, which would include BMPs to control eroded sediments.

Stormwater runoff exposed to coal storage (including coal pile runoff, coal handling dust suppression water, coal handling equipment wash-down water, and stormwater from the coal yard) would be diverted to a new lined **detention** basin through berms and above-ground conveyance systems. The basin would be lined to detain water and provide detention for removal of suspended solids. After an appropriate detention time, the stormwater would flow to the wastewater treatment system and would then be discharged to the Illinois River. Chemical reagents, including flocculants and polymers, may be used in the lined **detention** basin to increase detention before discharge to the wastewater treatment system.

The detention basin has not yet been designed; so the required size, depth, and retention time have not yet been determined for this feature. The Alliance designated the area where the detention basin is expected to be sited (Figure 2-13). The detention basin would be constructed on a portion of this site and would not encompass the entire area.

Stormwater from other areas where the water may be exposed to industrial materials or processes would be identified during the final design (e.g., the bottom ash bunker and fly ash silo unloading) and would flow either to the lined **detention** basin or flow directly to the wastewater treatment system through the use of curbing and either aboveground or underground conveyances. The treated effluent would be discharged to the Illinois River in compliance with an NPDES permit.

Water sources for the project's makeup water would include deep wells on the property, city water, and the Illinois River. The Illinois River would be the primary source of makeup process water for the proposed project and would require additional treatment at the new process water treatment facility as discussed in Section 2.4.2.2. River water would be used to meet the following needs:

- Screen and strainer backwash;
- Makeup water for the cooling towers for Unit 4, the direct contact cooler polishing system, and the air separation unit and compression and purification units;
- Makeup water for gas quality control equipment;
- Process water for the air separation unit and compression and purification unit;
- Equipment cooling;
- Equipment wash down; and
- Coal handling dust suppression in the coal yard.

As indicated earlier, the Meredosia Energy Center used an average of 217 mgd of cooling water supplied through the river water intake structure until operations were suspended at the energy center at the end of 2011. The maximum capacity of the river water intake structure is 414 mgd. The proposed project would require approximately **13.6** mgd of cooling water withdrawal from the river, which represents a nearly **94** percent reduction in river water usage from past operations at the energy center. However, water discharges from the Meredosia Energy Center to the Illinois River would equal approximately **10.6** mgd, which results in an actual net withdrawal from the river of only **3.0** mgd.

As a result of the significant reduction in cooling water withdrawal compared to historical values, there would be no need for an upgrade to the existing river water intake structure. The projected net total demand for the project of **3.0** mgd of water from the river represents **approximately** 0.02 percent of the average flow rate (14,139 mgd) and approximately 0.1 percent of the 7Q10 low-flow rate (2,391 mgd) for the Illinois River. Therefore, the proposed project would have a minor impact on the Illinois River even during typical drought (i.e., 7Q10 low-flow) conditions.

In 2011, a new rule was proposed under Section 316(b) of the CWA for existing facilities, which the USEPA plans to finalize by **November** 2013. As per the proposed rule, existing facilities that withdraw at least 25 percent of their water from an adjacent waterbody exclusively for cooling purposes and have a design intake flow of greater than 2 mgd would be subject to an upper limit on how many fish can be killed by being pinned against intake screens or other parts at the facility (i.e., impingement). In addition, existing facilities that withdraw very large amounts of water (125 mgd or more) would be required to conduct studies to help their permitting authority determine whether and what site-specific controls, if any, would be required to reduce the number of aquatic organisms sucked into cooling water systems (i.e., entrainment). The decision process may also include public input. The scheduled Section 316(b) rulemaking would likely have no bearing on the proposed project because the water withdrawn via the existing intake structure would be used predominantly to provide makeup water for the cooling water systems and the intake structure would be designed such that the intake velocity does not exceed 0.5 feet per second. At this rate, most fish can swim away from the cooling water intake of the facility (USEPA 2011k). See Section 3.8, Biological Resources, for an analysis of potential impacts of the cooling water intake on fish species. Cooling water intake structures are reviewed by the IEPA with each NPDES operating permit renewal application; therefore, any required upgrades would be identified during this process.

Prior to the suspension of the energy center at the end of 2011, the Meredosia Energy Center generated approximately 189 mgd of wastewater from industrial processes (including noncontact cooling water) and discharged treated wastewater to the Illinois River under NPDES Permit No. IL0000116. In September

2011, the Alliance received approval for a modified NPDES Permit No. IL0000116, which went into effect on November 1, 2011, and is valid through October 31, 2016. **As indicated earlier, on June 20, 2013, the Alliance submitted an NPDES permit application to further modify the existing NPDES Permit No. IL0000116 based on project operational design changes and revisions. The application was prepared after submittal of the Draft EIS; therefore, the analysis described herein has been updated accordingly. The new permit application includes changes in effluent water sources, contaminant loads, and flow rates (discussed in greater detail below) to support the planned discharges from the FutureGen 2.0 Project. If the final design for the proposed project results in any changes to contaminant loads or flow rates, the permit may need to be modified further.**

Under the proposed project, a considerably smaller amount of wastewater (**10.6 mgd**) would be discharged to the Illinois River, as summarized in Table 3.6-7. Most of the wastewater would come from **blowdown water from the main cooling tower (9.8 mgd)**, while the remainder would consist of backwash from the river water intake screen, once-through cooling water from the air compressor, effluent from two new onsite wastewater treatment systems, **and other minor sources. The other sources of wastewater discharge would include strainer backwash, effluent from the oil-water separators, and process condensate.**

The proposed project would use two wastewater treatment systems to remove contaminants from wastewater before discharge to the Illinois River. The compression and purification unit wastewater treatment system would use pH adjustment and mercury filtration media to treat wastewater before conveyance to the Unit 4 wastewater treatment system. The Unit 4 treatment system would be designed to meet all state of Illinois applicable water quality standards found in 35 IAC 302 (Water Quality Standards) and applicable state and federal effluent limits.

The proposed project would also utilize up to three oil-water separators during operations. The existing oil-water separator for Unit 4 would be replaced, and up to two additional oil-water separators would be installed as required for new facilities. One new oil-water separator would be installed near the compression and purification unit island and an additional unit would be installed near the air separation unit island. The proposed oil-water separators would be coalescing plate type units and would treat effluent water prior to discharge at Outfall 002.

Table 3.6-7. Estimated Wastewater Discharge to Illinois River

Source	Average Flow Rate (gpm)	Average Daily Discharge (gpd)	Discharge Point
Process Wastewater Treated Effluent	270	388,170	Illinois River
Cooling Water (including blowdown)	6,869	9,892,000	Illinois River
Intake Screen Backwash	208	300,000	Illinois River

gpd = gallons per day; gpm = gallons per minute

The Unit 4 wastewater treatment system would discharge effluent to the Illinois River through Outfall 002 under the existing (**last modified 2012**) NPDES Permit (IL0000116). Impacts to the Illinois River resulting from the discharge of wastewater are expected to be minor, and no effluent limits would be exceeded. In addition, discharges would not contribute to the impairment of the Illinois River for fecal coliform, PCBs, or mercury.

The total flows and loads associated with the FutureGen 2.0 Project would be substantially lower than the historic Meredosia Energy Center flows and loads, taking discharges from all outfalls into account, which includes Outfalls 001, A01, 002, 003, 004, and 006. **Collectively, the 33** constituent loadings listed on the NPDES discharge permit **application** would be reduced by an average of nearly **86** percent. Five of the six outfalls associated with the project would see a reduction for all applicable constituents. The discharges from Outfall 002 would have increased loads of certain constituents when examined in

isolation, which includes an increase in **sulfate of more than 50 percent at that outfall**. The increased **sulfate** discharged at Outfall 002 would be a result of removing sulfur dioxide from the boiler flue gas by the air pollution control devices and transferring the sulfur to water as **sulfate**. Other constituents that could increase in discharge amount at Outfall 002 include total suspended solids, **fluoride, nitrate/nitrite**, aluminum, **barium**, iron, **magnesium**, manganese, titanium, and chromium. However, as stated earlier, the FutureGen 2.0 Project would result in a net decrease in all constituents when all discharges are taken into account. In addition, since the recirculating cooling towers release heat to the surrounding air, the towers would minimize thermal discharges to the Illinois River, which would also have a positive impact on water quality when compared with historical operation of the energy center.

Table 3.6-8 provides a summary of the daily maximum effluent concentration limits for each constituent by outfall, pursuant to the modified NPDES Permit No. IL0000116. The permit also includes 30-day average concentration limits and 20 additional special conditions that are applicable to onsite operations and monitoring requirements.

Table 3.6-9 compares the water withdrawal rate and wastewater production rate for the FutureGen 2.0 Project with historic flow rates for the energy center prior to its suspension at the end of 2011. The historical scenario represents the water demand before the energy center suspended operations, while the projected scenario represents the estimated water demand for the proposed project. The river water withdrawal rate and wastewater production rate would decrease by approximately **94** percent when compared with the prior operation of the energy center. With this significant reduction in flow, the FutureGen 2.0 Project would reduce impacts to the Illinois River when compared with historical operation of the energy center. However, the river withdrawal and discharge rates would increase by a net withdrawal rate of 2.4 mgd, in comparison to the current conditions where there is no withdrawal or discharge.

Table 3.6-8. NPDES Permit No. IL0000116 Effluent Concentration Limits (Daily Maximum)

Constituent (mg/L) ^a	Outfall 001	Outfall A01	Outfall 002	Outfall A02	Outfall 003	Outfall A03	Outfall 004	Outfall 006
Total Residual Chlorine	–	–	0.05	–	–	–	0.05	0.05
Total Suspended Solids	–	30	–	–	–	100	100	–
Oil & Grease	–	20	–	–	–	20	20	–
pH	–	–	≥6.0 ≤9.0	–	–	–	≥6.0 ≤9.0	–
Copper	–	–	0.0423	–	1.0	–	–	–
Chromium	–	–	0.2	–	–	–	–	–
Zinc	–	–	1.0	–	–	–	–	–
Iron	–	–	–	–	1.0	–	–	–

^a All units are mg/L except for pH
 mg/L = milligrams per liter; NPDES = National Pollutant Discharge Elimination System; “–” = no permit limit currently exists; ≥ = greater than or equal to; ≤ = less than or equal to.

CO₂ Pipeline

Normal operations of the proposed CO₂ pipeline are not expected to affect surface waters. On occasion, maintenance or inspection activities may require excavation around segments of the pipeline. During these kinds of maintenance operations, the BMPs discussed in Section 3.6.3.1 would be used, as applicable, to avoid or minimize any indirect impacts (e.g., sedimentation and turbidity) to adjacent surface waters.

Hydrostatic testing may be required every 3 to 5 years to verify the integrity of the CO₂ pipeline. If water were used in the testing, it would be obtained from available sources and trucked to the testing sites. Hydrostatic testing water would likely be discharged to local waterways under an NPDES permit from the IEPA, or to a permitted treatment facility. Since any disposal of hydrostatic testing water to local waterways would occur in compliance with NPDES permit conditions, disposal of hydrostatic test water would have minor temporary impacts on local surface water resources. These impacts would be similar to the construction impacts discussed in Section 3.6.3.1.

Table 3.6-9. Operational Scenarios for Pre- and Post-Suspension of Meredosia Energy Center

	Historical Scenario Pre-suspension of Energy Center, Prior to the end of 2011 (mgd)	Projected Scenario FutureGen 2.0 Project (mgd)	Percent Decrease from Historical Rate (percent)
Average Withdrawal Rate from Illinois River	217.4	13.6	94
Average Discharge Rate to Illinois River	189	10.6	94

mgd = million gallons per day

As discussed in Section 3.17, Human Health and Safety, based on the frequency of releases from similar pipelines in the United States, a release of CO₂ due to a pipeline puncture or rupture is considered unlikely (frequency from 1 x 10⁻² to 1 x 10⁻⁴ per year). Mainline block valves would be provided approximately every 10 miles to isolate and contain any pipeline leak. If CO₂ were released from the pipeline, it would expand rapidly as a gas and could include both liquid and solid (i.e., dry ice) phases, depending on temperature and pressure. As the product in the pipeline would be over 97 percent CO₂ with few impurities (i.e., oxygen, nitrogen oxides, sulfur oxides, nitrogen, argon, and water) and would not remain under sufficient pressure to dissolve into surface water, it would have negligible adverse impact on surface water quality in the unlikely event of a release; however, it could potentially reduce surface water temperatures near a release. The magnitude of temperature reduction would depend upon the size of the release. The effects of temperature changes on aquatic biota are discussed further in Section 3.8, Biological Resources. Section 3.17, Human Health and Safety, addresses the potential human health impacts resulting from the operation of the CO₂ pipeline.

CO₂ Storage Study Area

As discussed in Section 3.17, Human Health and Safety, a possible impact from the operation of the injection wells may result from an injection well blowout (i.e., a sudden loss of CO₂ from failure of an injection well during operation), which is considered an extremely unlikely event. If a CO₂ injection well blowout were to occur, the main adverse outcome to surface waters near the wellhead would be the potential for release of formation fluids (e.g., brine) to an adjacent surface waterbody, which would be similar to a conventional spill. Because such a release is considered highly unlikely, operation of CO₂ injection wells would be expected to have a minor impact on any surface water resources present near the well. Effects would include an increase in salinity of nearby surface water features and would be localized to the area around the affected wellhead. This could have direct, temporary adverse impacts to surface water chemistry and aquatic biota. The effects would be temporary as continued flow would dilute and disperse the brine, in addition to remedial activities conducted during spill cleanup. Events of this type would be avoided or minimized by incorporating high-pressure piping, overpressure protection (i.e., relief) valves, and blowout preventers into the design of the injection wells.

No additional impacts, beyond those addressed previously for the operation of the CO₂ pipeline, would be anticipated during the operation of the pipeline across the CO₂ storage study area to the injection wells.

Educational Facilities

Normal operations of the educational facilities would generally not affect surface water resources. Considering that the selected site(s) would be located on previously disturbed land with existing utility connections, it is unlikely that direct or indirect impacts would result from operation of the facilities.

3.6.4 Impacts of the No Action Alternative

Under the no action alternative, DOE would not provide cost-shared funding for the FutureGen 2.0 Project. Although the Alliance may still elect to construct and operate the project in the absence of DOE cost-shared funding, for the purposes of the analysis in this EIS, DOE assumed the no action alternative is equivalent to the no-build alternative. Therefore, the project would not be constructed and there would be no change to surface water resources.

3.7 WETLANDS AND FLOODPLAINS

3.7.1 Introduction

This section describes wetlands and floodplains potentially affected by the construction and operation of the proposed project. This section also analyzes the potential direct and indirect effects of the proposed project on these resources.

This section provides the required wetland and floodplain assessment in compliance with regulations promulgated at 10 CFR 1022, "Compliance with Floodplain and Wetland Environmental Review Requirements." These regulations provide a guide for DOE compliance with Executive Order (EO) 11988, "Floodplain Management," and EO 11990, "Protection of Wetlands." EO 11988 requires federal agencies, while planning their actions, to avoid to the extent possible adverse impacts associated with the modification of floodplains and to avoid support for development in a floodplain when there is a better practicable alternative. EO 11990 requires that federal agencies, while planning their actions, consider alternatives to affecting wetlands, if applicable, and limit adverse impacts to the extent practicable if impacts cannot be avoided.

Floodplains are closely related to surface waters, as rivers, streams, lakes, and ponds are the ultimate destination for precipitation and snowmelt on land and the primary source of flood flows. Surface waters are specifically discussed in Section 3.6, Surface Water.

3.7.1.1 Wetlands

Wetlands are among the most productive environments in the world, comparable to rain forests and coral reefs. Many species of wildlife, including a large percentage of threatened and endangered species, depend on wetlands for survival. Wetlands are also important for scientific and educational opportunities and can provide open space for recreation where public access is available.

Wetlands have unique characteristics that set them apart from other environments, providing the basis for wetland identification and classification. These unique characteristics include a layer of soil that is saturated or inundated with water for part of the growing season, soils that contain little or no oxygen, and plants adapted to wet or seasonally saturated conditions. Wetlands serve many functions, including the storage and slow release of rain, snowmelt, and seasonal floodwaters to surface waters. Additionally, wetlands provide wildlife habitat, stabilize and retain sediment, and perform an important role in nutrient (e.g., nitrogen and phosphorus) cycling. Wetlands also help to maintain stream flow during dry periods and provide groundwater recharge functions.

Wetlands are defined by the USACE as follows (40 CFR 230): Those areas that are inundated or saturated by surface or groundwater at a frequency and duration sufficient to support, and that under normal circumstances do support, a prevalence of vegetation typically adapted for life in saturated soil conditions. Wetlands generally include swamps, marshes, bogs, and similar areas.

Wetland types are often categorized using the USFWS document *Classification of Wetlands and Deepwater Habitats of the United States*. This classification system is used by the USFWS when categorizing wetland types to develop the National Wetland Inventory (NWI), a series of maps that show wetlands and deepwater habitats of the United States. The Illinois Wetland Inventory (IWI) classification was developed to facilitate the use and presentation of NWI data. The IWI uses spatial data provided by the NWI, but provides its own, more simplified classification system describing each area of NWI-mapped wetlands. The IWI data does not include any additional wetland mapping, but relies on NWI-mapped wetlands.

Although the NWI classification provides valuable information, a relatively high level of detail makes data analysis cumbersome (e.g., there are 617 unique NWI codes used in Illinois) (Suloway and Hubbell 1994). In contrast, the IWI classification system is much less detailed, containing only 13 basic groups of wetland and deepwater classification codes. Certain wetland types in the IWI classification

system may be characterized as a combination of 2 or more of the 13 basic groups. For simplicity and consistency with IDNR, the description of wetlands in this section utilizes the IWI classification system.

The IWI classification system contains 13 wetland types (Suloway and Hubbell 1994; USFWS 2012a):

1. **Bottomland Forests:** Dominated by woody vegetation 20 feet tall or greater covering 30 percent or more of the area, which are temporarily or seasonally flooded, but which lack continuously standing water.
2. **Swamps:** Dominated by woody vegetation 20 feet tall or greater covering 30 percent or more of the area where water is present on a permanent or semi-permanent basis.
3. **Scrub-Shrub:** Characterized by woody vegetation less than 20 feet tall covering 30 percent or more of the area.
4. **Shallow Marsh and Wet Meadow:** Dominated by rooted, herbaceous vegetation. Characterized by standing water that is present for brief to moderate periods during the growing season.
5. **Deep Marsh:** Dominated by rooted, herbaceous vegetation. Characterized by standing water or soil saturation on a semi-permanent to permanent basis during the growing season.
6. **Open Water:** Unvegetated areas less than 20 acres that are covered by water less than 6.6 feet deep. This includes ponds, borrow pits, small reservoirs, and open water areas within a marsh or swamp.
7. **Shallow Lake:** Shallow open waterbodies that are 20 acres or more in area and less than 6.6 feet in depth that occupy topographic depressions or that are impounded river channels.
8. **Lake Shore:** Located along the edges of large rivers and the shores of wave-affected lakes.
9. **Emergent Lake:** Lake shore wetlands that have a zone of emergent vegetation extending from the shore to approximately 6.6 feet in depth.
10. **Perennial Riverine:** Characterized by flowing water throughout the year. Largely shallow (less than 6.6 feet deep) rivers and streams within unimpounded channels; they are either unvegetated or vegetated with nonpersistent emergent plants or aquatic plant beds.
11. **Intermittent Riverine:** Contain flowing water for only part of the year. Largely shallow (less than 6.6 feet deep) rivers and streams within unimpounded channels; they are either unvegetated or vegetated with nonpersistent emergent plants or aquatic plant beds.
12. **Deepwater Lakes (Lacustrine):** Waterbodies deeper than 6.6 feet that occupy topographic depressions or that are impounded river channels.
13. **Deepwater Rivers (Riverine):** Unimpounded channels containing flowing water greater than 6.6 feet in depth.

Wetlands once covered more than 8 million acres in Illinois, or approximately 23 percent of the total land area. As a result of human modification of the environment, approximately 90 percent of those wetlands

have been destroyed. Approximately 1.25 million acres of wetlands exist in the state, although approximately one-fourth of that total were modified or created by dikes, impoundments, or excavation activities. In Illinois, wetland loss is principally attributed to conversion of the land for agricultural purposes and to a lesser extent by land development associated with population growth (Suloway and Hubbell 1994).

Over half of the counties in Illinois (53 counties) have less than 2 percent of their land area occupied by natural wetlands. Most of the state's remaining natural wetlands (over 57 percent) are located in southern Illinois. Northern Illinois contains approximately 22 percent of the state's natural wetlands, while the remaining 21 percent are located in central Illinois (Suloway and Hubbell 1994).

3.7.1.2 Floodplains

Rivers and streams are part of nature's system for carrying water from high ground down to lakes and oceans. The land areas adjacent to the streams, rivers, and lakes that are inundated when flooding occurs are floodplains. Flooding is a natural process and floodplains are a vital part of that process. Beneficial values of floodplains include the moderation of floods, water quality, groundwater recharge, fish and wildlife habitat, open space, and recreational value. A flood occurs when heavy rains or snowmelt send more water downstream than the carrying channel can handle. There are three primary types of flooding in Illinois: riverine flooding (a flood typically seen as water flowing over a stream's banks), ponding (a flood occurring when low areas fill up faster than they can be drained), and sheet flooding (a flood when water flows along the surface without a channel) (IDNR 2006).

Flooding potential is generally described in terms of flooding recurrence intervals, such as the 100-year or 500-year flood. The 100-year floodplain is the area projected to be inundated by a storm that has a one percent probability of occurring in any year. The 500-year floodplain is the area projected to be inundated by a storm with a 0.2 percent probability of occurring in any year. The 100-year floodplain is the national standard on which floodplain management and the National Flood Insurance Program are based.

Since flooding events can cause very costly natural disasters, the Federal Emergency Management Agency (FEMA), through the National Flood Insurance Program, enables property owners to purchase insurance protection against losses from flooding. Floodplain management activities of the National Flood Insurance Program include the development of flood insurance rate maps for flood insurance rating purposes. A flood insurance rate map outlines flood risk zones within communities and is usually issued following a flood insurance study that summarizes the analysis of flood hazards within the subject community. FEMA provides flood insurance rate maps to a wide range of users including private citizens, community officials, insurance agents and brokers, lending institutions, and other federal agencies. A flood insurance study includes detailed engineering studies to map predicted flood elevations at specified flood recurrence intervals. Generally, the study is concerned with peak discharges in streams and rivers for 100-year and 500-year storm events and includes engineering analyses of predicted flood elevations for each flood recurrence interval. Based on the results of the engineering analyses, flood risk zones are assigned for insurance purposes.

Illinois has one of the largest inland systems of rivers, lakes, and streams in the nation. Nearly 15 percent of the total land area in the state (or 7,400 square miles) is subject to flooding. As Illinois developed, the state's waterways often served as the focal point for growth and commerce, because they provided needed water resources and transportation corridors. Homes, buildings, businesses, and, in some instances, entire communities now occupy floodplains across Illinois. This floodplain development has resulted in continual and, often, severe damage as well as loss of life. In Illinois, it is estimated that over 250,000 buildings are located in floodplains. Floods are by far the most common natural disaster in the state, accounting for well over 90 percent of the declared disasters. Annual damages due to flooding are estimated to average nearly \$700 million (IDNR 2006).

3.7.1.3 Region of Influence

The ROI for wetlands and floodplains includes the areas potentially affected by the construction and operation of the proposed project, consisting of the Meredosia Energy Center, the CO₂ pipeline, the CO₂ injection wells, and the proposed educational facilities. The ROI defines the extent of the areas where direct effects from construction and operation may be experienced, and it encompasses the areas where indirect effects from the proposed project would most likely occur.

3.7.1.4 Method of Analysis and Factors Considered

DOE assessed potential impacts to wetlands and floodplains primarily by using a GIS mapping application to calculate impact acreages for NWI-mapped (and IWI re-classified) or field delineated wetlands and FEMA-mapped floodplains. DOE overlaid baseline environmental data (i.e., wetland and floodplain locations) with potential project features to determine the locations and extents of potentially affected wetlands and floodplains. In locations where wetlands and floodplains would be impacted, qualitative assessments were made of what those impacts would be. DOE assessed the potential for impacts to wetlands and floodplains based on whether the proposed project would:

- Cause filling of wetlands or otherwise alter drainage patterns that would affect wetlands;
- Cause wetland type or classification conversions due to alterations of land cover attributes;
- Alter a floodway or floodplain or otherwise impede or redirect flows such that human health, the environment, or personal property could be affected;
- Conflict with applicable flood management plans or ordinances; or
- Conflict with FEMA's national standard for floodplain management (i.e., maximum allowable increase of water surface elevation of 1 foot for a 1 percent annual chance [100-year recurrence interval] flood event).

With respect to wetlands, this section discusses the potential for impacts related to the loss of resources (i.e., filling impacts), type or classification conversions (e.g., converting a forested wetland to an herbaceous wetland), and surface disturbances within wetlands or their vicinities that would alter or affect the wetland or its hydrology or characteristics. Each such action would ultimately affect the functions and values of wetland resources (e.g., attenuating flood flows and providing habitat for wildlife). For wetlands, the following three types of potential impacts could occur:

- Direct wetland loss by placement of fill material or structures;
- Wetland type conversions caused by project activities; and
- Wetland disturbances, which are generally considered temporary, construction-related impacts.

Fill material is defined by the applicable regulatory agencies [USACE and USEPA] as, "material placed in waters of the U.S. where the material has the effect of either replacing any portion of a water of the U.S. with dry land or changing the bottom elevation of any portion of a water." [67 FR 31129]

DOE assessed potential floodplain impacts by determining the potential of the proposed project components to place fill material or structures in a floodplain in a manner that would expose people or structures to increased levels of flood hazards or violate FEMA's national standard for floodplain management.

3.7.1.5 Regulatory Framework

Wetlands

Certain wetland features, called “waters of the U.S.,” are regulated by the USACE under the CWA because they are important for the preservation of navigable waterways and interstate commerce. Waters of the U.S. are subject to federal jurisdiction and permitting under Section 404 of the CWA and include all navigable waterways, their tributaries, as well as wetlands contiguous (connected) to and adjacent to those navigable waterways and tributaries. Isolated wetlands (those that have no physical, chemical, or biological connection to waters of the U.S.) are not regulated under federal jurisdiction unless they are adjacent to waters of the U.S. Isolated wetlands are not currently regulated by the state of Illinois.

Throughout the ROI for wetlands and floodplains, federal wetland regulations are enforced by the USACE St. Louis and Rock Island districts. Under Section 404 of the CWA, a USACE permit would be required for the discharge of dredged or fill material into waters of the U.S., which is authorized by a Nationwide Permit or an Individual Permit, depending upon the extent of the impact and the characteristics of the impacted wetland(s). Construction of utility lines (e.g., pipelines) that would affect waters of the U.S. can be permitted with a Nationwide Permit (Number 12 – “Utility Line Activities”) if less than 0.5 acre of wetlands or waters of the U.S. are disturbed, or an Individual Permit if more than 0.5 acre is disturbed. Both the Nationwide Permit and the Individual Permit require that certain conditions are met.

In addition, construction within or alteration of (e.g., dredging activities, placement of fill material) a traditional navigable waterway (e.g., the Illinois River) below the defined ordinary high water mark requires USACE permitting under Section 10 of the Rivers and Harbors Appropriation Act. This is discussed in greater detail in Section 3.6, Surface Water.

Floodplains

FEMA has adopted a maximum allowable increase of water surface elevation of 1 foot for a 1 percent annual chance (100-year recurrence interval) flood event as the national standard for floodplain management purposes. Many local ordinances have adopted this standard.

The Morgan County Floodplain Ordinance states that no elevation in flood heights is permissible unless approved via permit by IDNR. IDNR requires permitting for construction in a floodway (i.e., the channel of a river, lake, or stream and that portion of the adjacent land area that is needed to safely store and convey the 100-year flood event without substantial increases in flood heights), which are sometimes defined on FEMA maps. When FEMA mapping in an area does not include a floodway delineation, IDNR generally requires permitting for any work in the floodplain. Since FEMA has not mapped floodways in the project area, IDNR must review all construction activities within the 100-year floodplain.

The Illinois Floodplain Regulations enforced by IDNR (17 IAC 3700) state that the maximum water level increase within a floodway is 0.5 foot in rural areas and 0.1 foot in urban areas. The Morgan County Floodplain Ordinance also states that any non-residential buildings constructed in a 100-year floodplain must either be constructed such that the lowest floor (including basement) is elevated to, at least, one foot above the level of the base flood elevation or flood-proofed (i.e., watertight and capable of withstanding the effects of a 100-year flood) below 1 foot above the base flood elevation (Morgan County 2009).

3.7.2 Affected Environment

The entire proposed project would be located in Morgan County, Illinois. Morgan County contains approximately 6,170 acres of wetlands, which comprise approximately 1.7 percent of the county’s total land area. Of that acreage, approximately 4,210 acres are considered natural wetlands. The most abundant wetland type in the county is bottomland forest, which consists of temporarily or seasonally flooded forested wetlands that lack continuously standing water (Suloway and Hubbell 1994).

Morgan County contains approximately 36,830 acres of 100-year floodplains, which comprise approximately 10 percent of the county's total land area (IDNR 2009a).

3.7.2.1 Meredosia Energy Center

This section assesses impacts to wetlands and floodplains based on the original design for the energy center that was analyzed in the Draft EIS. Although the Alliance updated its design to reduce the amount of area that would be impacted by the construction and operation of the facility (see Figure 2-15), the impact analysis in this section addresses the original design, since it represents a conservative upper bound for the analysis of these resources.

Wetlands

Based on a wetland delineation conducted in May 2011 at the Meredosia Energy Center property, two small wetlands were identified. Both wetlands are located near the eastern property boundary along Old Naples Road (see Appendix D, Wetlands Surveys [D1]). These two wetlands cover areas of 0.37 acre (Wetland Area PA) and 0.26 acre (Wetland Area PB), respectively. **Based upon the current design, these wetland areas are not located within the proposed footprint of the FutureGen 2.0 Project.**

Representatives from the USACE performed a site visit at the Meredosia Energy Center on August 16, 2011, to conduct a Jurisdictional Determination. The USACE agreed with the results of the wetland delineation regarding the location and extent of each wetland feature. The USACE identified that the two onsite wetlands are both subject to USACE jurisdiction under Section 404 of the CWA. Although there is no surface hydrologic connection between these wetlands and the Illinois River (i.e., a navigable waterway), the USACE stated that the onsite wetlands are connected to the river via groundwater, rendering them waters of the U.S. The larger of the two wetlands is a low-lying area that appears to capture stormwater from other portions of the property, such as the main entrance and exit roads to the energy center.

These wetlands are not mapped by NWI, and therefore have not been categorized by the IWI. However, based on field observations, these wetlands would be classified as scrub-shrub/shallow marsh/wet meadow in the IWI classification system. Vegetation in these wetlands consists primarily of cattail (*Typha spp.*), eastern cottonwood (*Populus deltoides*) seedlings, and grasses (*Sedge spp.*). These wetland areas, as well as other NWI-mapped wetlands in the vicinity of the Meredosia Energy Center, are depicted in Figure 3.7-1 **superimposed over the potential impact areas from the original design presented in the Draft EIS.**

Floodplains

The FEMA Flood Insurance Rate Map covering the Meredosia Energy Center (Map Number 17137C0004D; effective date August 18, 2009) indicates that portions of the overall site and potentially affected offsite locations lie within the 100-year floodplain of the Illinois River. This 100-year floodplain has a mapped base flood elevation of 447 feet above mean sea level. Small areas of 500-year floodplain bordering this 100-year floodplain are also mapped **within the Meredosia Energy Center property.** The portion of the energy center where the main physical structure of the oxy-combustion facility is proposed to be located is outside of the mapped 100-year floodplain, indicating a minimal flood hazard in this specific location (FEMA 2009). **Areas of FEMA-mapped 100-year and 500-year floodplains at the energy center are depicted in Figure 3.7-2 superimposed over the potential impact areas from the original design presented in the Draft EIS.**



DOE = U.S. Department of Energy; NWI = National Wetland Inventory

Figure 3.7-1. Wetlands at the Mercedosia Energy Center



Source: FEMA 2009

Figure 3.7-2. Floodplains at the Meredosia Energy Center

3.7.2.2 CO₂ Pipeline

The proposed CO₂ pipeline corridor from the Meredosia Energy Center to the CO₂ storage study area is approximately 26 miles in length (see Figure 2-17). DOE derived wetland spatial data from NWI digital mapping data obtained from USFWS (USFWS 2011a). However, DOE cross-correlated and renamed the NWI codes with their corresponding, simpler IWI codes as described earlier. DOE obtained floodplain information for Morgan County through FEMA digital Flood Insurance Rate Map data (FEMA 2011).

Coon Run is located within the pipeline corridor. A levee has been constructed along a portion of Coon Run, from just east of the Illinois River until its intersection with US-67 (State Route 100), approximately 3 miles east of the Meredosia Energy Center. This levee serves to control and direct flood flows in this vicinity.

Wetlands

An overview of wetlands in Morgan County is presented in Section 3.7.2. Figure 3.7-3 and Figure 3.7-4 present the extents of NWI-mapped wetlands within the pipeline corridor. Table 3.7-1 summarizes the wetland types (based on their corresponding IWI classifications; see Section 3.7.1.1) within the 4-mile wide pipeline corridor.

Table 3.7-1. NWI-Mapped Wetlands within the CO₂ Pipeline Corridor

IWI Wetland Type	Acres ^a
Bottomland Forest	792.3
Shallow Marsh/Wet Meadow	67.5
Scrub-Shrub	84.8
Deep Marsh	17.5
Scrub-Shrub/Shallow Marsh/Wet Meadow	7.2
Bottomland Forest/Scrub-Shrub	4.8
Open Water	349.8
Lacustrine Deepwater Habitat	254.9
Perennial Stream	59.4

Sources: USFWS 2012a; Suloway and Hubbell 1994

^a Acreage of NWI-mapped wetlands.

CO₂ = carbon dioxide; IWI = Illinois Wetland Inventory; NWI = National Wetland Inventory

Within the pipeline corridor, several wetland types are present as indicated in Table 3.7-1. The majority of these wetlands (approximately 60 percent) are either bottomland forest or perennial stream. Refer to Figure 3.7-3 and Figure 3.7-4 for specific wetland locations, as well as the map view figures in Appendix C, Map Views of Pipeline. **Wetland delineations were conducted along the entire pipeline ROW in the spring and summer of 2013. All waters of the U.S. that could be considered jurisdictional by the USACE were identified and will be submitted to the Corps in September 2013 for Jurisdictional Determination.**

Floodplains

An overview of floodplains in Morgan County is presented in Section 3.7.2. Figure 3.7-3 and Figure 3.7-4 present the extents of mapped floodplains within the 4-mile wide pipeline corridor.

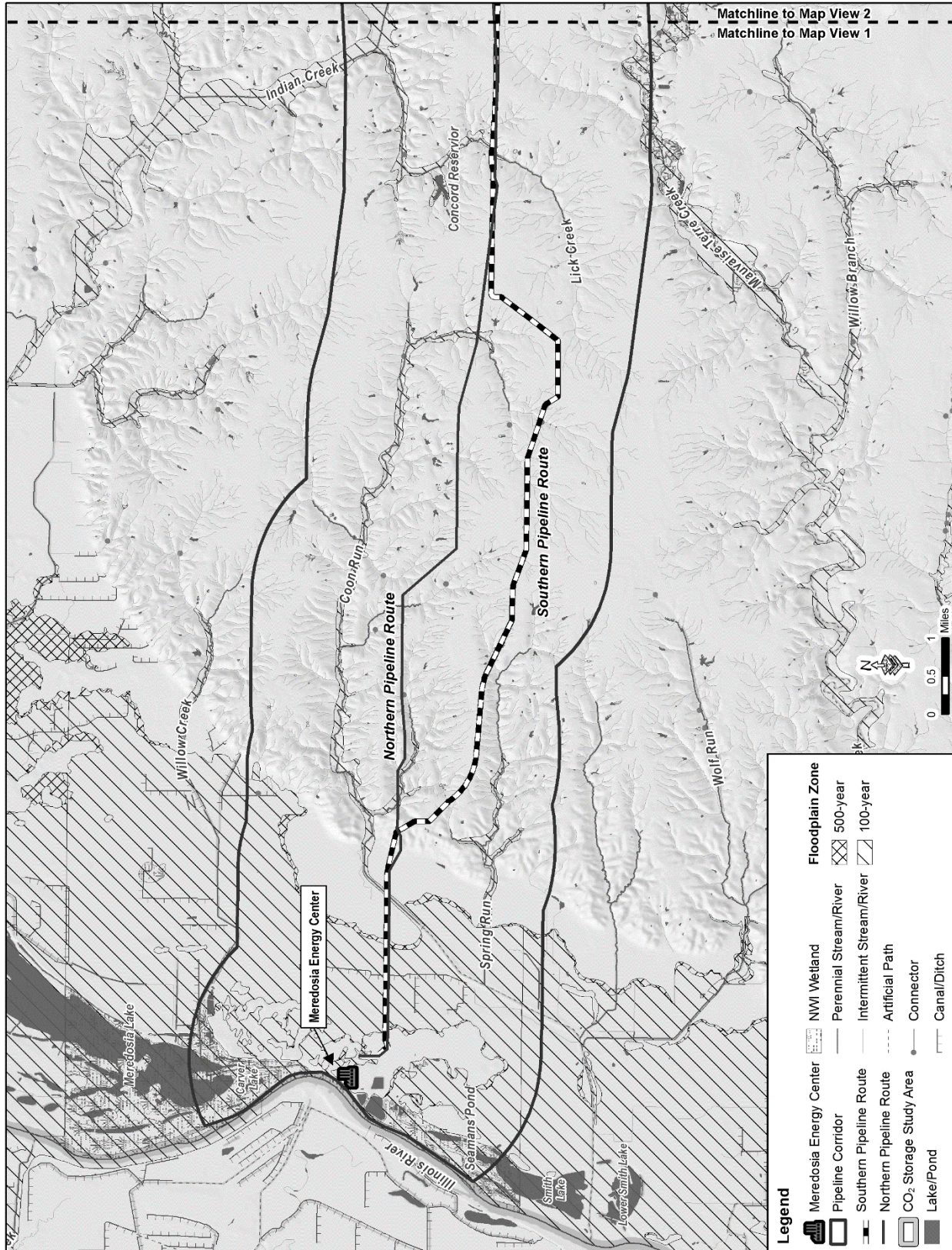

CO₂ = carbon dioxide; NWI = National Wetland Inventory

Figure 3.7-3. Wetlands and Floodplains in CO₂ Pipeline Corridor (Western Portion)

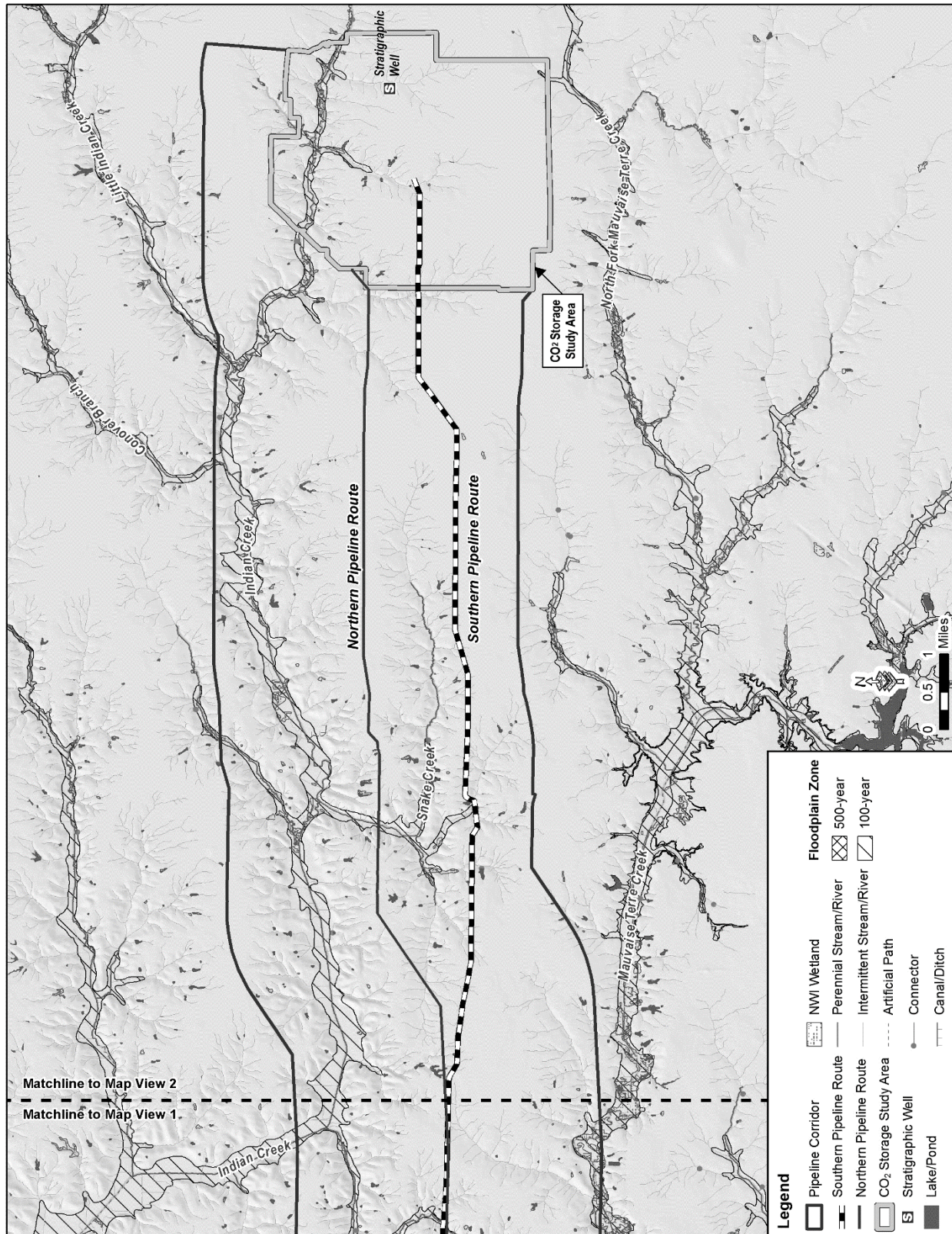

CO₂ = carbon dioxide; NWI = National Wetland Inventory

Figure 3.7-4. Wetlands and Floodplains in CO₂ Pipeline Corridor (Eastern Portion) and CO₂ Storage Study Area

Within the 4-mile wide corridor for the proposed CO₂ pipeline, several major surface waters have associated floodplains along their banks. As shown in Table 3.7-2, these include the Illinois River, which has a wide floodplain in western Morgan County and is the only surface water in the ROI with substantial areas of 500-year floodplains. Other surface waters in the ROI with associated 100-year floodplains include: Willow Creek, Coon Run, Spring Run, Indian Creek, Lick Branch, Snake Creek, Conover Branch, Mauvaise Terre Creek, and Little Indian Creek (FEMA 2011).

Table 3.7-2. Floodplains within the CO₂ Pipeline Corridor

Floodplain	Associated Waters	Acres
100-year	Illinois River, Coon Run, Indian Creek, Lick Branch, Mauvaise Terre Creek, Snake Creek, Spring Run, Willow Creek, Conover Branch, Little Indian Creek	10,465.2
500-year	Illinois River, Spring Run, Coon Run	253.9

Source: FEMA 2011
 CO₂ = carbon dioxide

3.7.2.3 CO₂ Storage Study Area

Tables 3.7-3 and 3.7-4 provide a summary of wetland features and floodplains that are located within the CO₂ storage study area. DOE derived wetland spatial data from NWI digital mapping data obtained from USFWS (USFWS 2011a). However, DOE cross-correlated and renamed the NWI codes with their corresponding IWI codes as described earlier. DOE obtained floodplain information for Morgan County through FEMA digital Flood Insurance Rate Map data (FEMA 2011).

Wetlands

In April 2011, a wetland field investigation was conducted by the Alliance on two separate parcels within the CO₂ storage study area. The field investigation was conducted to inspect for the presence of jurisdictional wetlands at two proposed locations for the stratigraphic well pad. The proposed locations included the Beilschmidt Characterization Pad and the Hoagland Characterization Pad. The Beilschmidt Pad is an approximately 11.25-acre area located on the south side of Beilschmidt Road (shown in Figure 3.7-4 as stratigraphic well); the Hoagland Pad is approximately 15.28 acres and is located on the north side of Beilschmidt Road (approximately 2,000 feet northwest of the stratigraphic well). Jurisdictional wetlands were not identified on either parcel during the investigation (see Appendix D, Wetlands Surveys [D3]) and the USACE later concurred with these findings. The Beilschmidt Pad was eventually selected as the location for the stratigraphic well, which was installed during the period October to December 2011. Refer to Section 2.5.2.5 for additional details regarding the stratigraphic well.

The Alliance also conducted a wetland delineation of the preliminary locations for soil gas monitoring within the CO₂ storage study area (see Appendix D, Wetlands Surveys [D2]). This wetland delineation was limited to seven monitoring sites comprising less than 50 square feet in total, all of which were located adjacent to county roads. No wetlands were observed during this survey. No other wetland delineation has yet been conducted elsewhere on the CO₂ storage study area.

Elsewhere within the CO₂ storage study area, three NWI-mapped wetland types have been mapped, totaling approximately 67.5 acres (see Figure 3.7-5 and Map View 4 in Appendix C, Maps Views of Pipeline [C1]). These wetland types include open water, shallow marsh/wet meadow, and bottomland forest (USFWS 2012a). These wetland areas represent less than 1.0 percent of the 6,800-acre CO₂ storage study area. As such, the NWI identifies relatively few wetlands in this area.

Additional areas of wetlands outside of those mapped by NWI may be present elsewhere on the CO₂ storage study area. Based upon the size of the site and the presence of forested (unfarmed) areas along streams within the site, it is possible that additional wetlands exist. A formal wetland delineation would be conducted prior to construction activities.

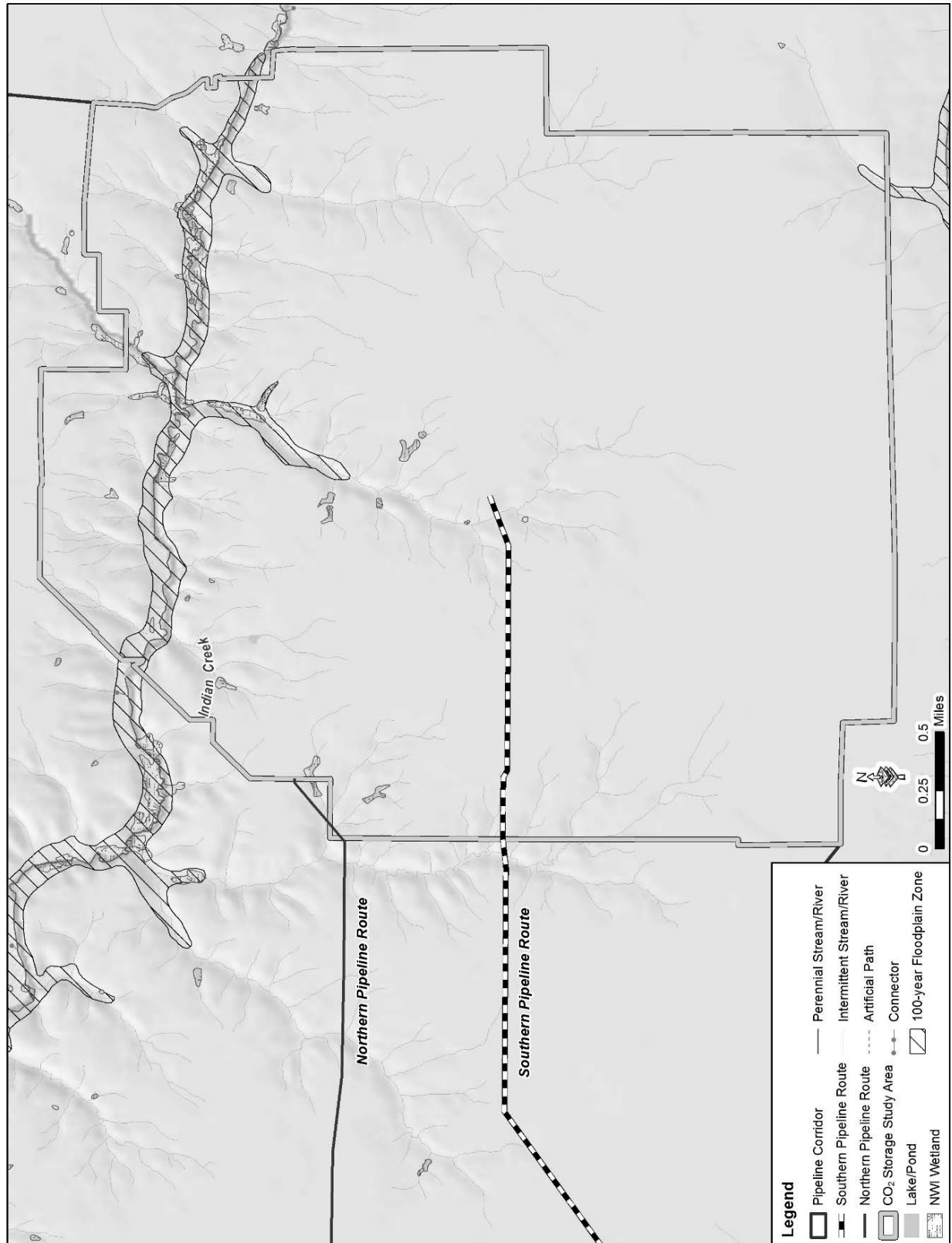

CO₂ = carbon dioxide; NWI = National Wetland Inventory

Figure 3.7-5. Wetlands and Floodplains at the CO₂ Storage Study Area

Table 3.7-3. NWI-Mapped Wetlands within the CO₂ Storage Study Area

IWI Wetland Type	Acres ^a
Bottomland Forest	7.0
Shallow Marsh/Wet Meadow	44.2
Scrub-Shrub	0
Deep Marsh	0
Scrub-Shrub/Shallow Marsh/Wet Meadow	0
Bottomland Forest/Scrub-Shrub	0
Shallow Marsh/Wet Meadow/Bottomland Forest	0
Open Water	16.3
Lacustrine Deepwater Habitat	0
Perennial Stream	0

Source: USFWS 2012a

^a. Acreage of NWI-mapped wetlands.

CO₂ = carbon dioxide; IWI = Illinois Wetland Inventory; NWI = National Wetland Inventory

Floodplains

Within the CO₂ storage study area, 100-year floodplains are present along Indian Creek and associated branches or drainages **on the northern portion of the study area, as well as along an unnamed tributary to North Fork Mauvaise Terre Creek in the far southeast portion of the study area** (see Figure 3.7-5) (FEMA 2011).

Table 3.7-4. Floodplains within the CO₂ Storage Study Area

Floodplain	Associated Waters	Acres
100-year	Indian Creek, North Fork Mauvaise Terre Creek	238.7
500-year	NA	0

Sources: FEMA 2011; ISWS 1996

CO₂ = carbon dioxide; NA = not applicable

3.7.2.4 Educational Facilities

Visitor, research, and training facilities (also referred to as the educational facilities) would be provided at a suitable location in the Jacksonville area. These facilities would support public outreach as well as provide training and research opportunities associated with near zero emissions power and carbon capture and storage technologies.

Wetlands

Within Jacksonville and South Jacksonville, there are few wetlands, as these areas are heavily developed. The primary locations within each city that have wetlands occur around Mauvaise Terre Lake. Wetland areas around Mauvaise Terre Lake consist of the following wetland types: bottomland forest, scrub-shrub, shallow marsh/wet meadow, deep marsh, and lacustrine deepwater lakes (see Section 3.7.1.1). One other concentrated area of wetlands occurs in northern Jacksonville, near Mauvaise Terre Creek. This area contains the following wetland types: bottomland forest, shallow marsh/wet meadow, deep marsh, and

open water (see Section 3.7.1.1). Most of the land area in the immediate vicinity of Jacksonville consists of agricultural land with few wetlands. The majority of wetlands outside of Jacksonville consist of farm ponds or wetlands adjacent to surface waters (USEPA 2011).

Floodplains

Floodplains in the Jacksonville area consist primarily of 100- and 500-year floodplains associated with Mauvaise Terre Creek and associated branches and tributaries. Mauvaise Terre Creek runs roughly along the northern and eastern boundaries of Jacksonville and the eastern boundary of South Jacksonville. Town Brook runs in an east-west direction across Jacksonville, roughly paralleling Hoagland Boulevard. Town Brook, a tributary to Mauvaise Terre Creek, is bounded by narrow, mapped 100- and 500-year floodplains. Town Brook and its associated floodplains extend across the mid to southern portion of Jacksonville. The 500-year floodplains in the area generally extend in narrow bands along the boundaries of the 100-year floodplains (USEPA 2011).

South of the town of South Jacksonville, mostly along the south side of US-72, 100-year floodplains occur along Big Sandy Creek, associated branches and tributaries, and Lake Jacksonville (USEPA 2011).

3.7.3 Impacts of Proposed Action

3.7.3.1 Construction Impacts

Meredosia Energy Center

Wetlands

Stormwater runoff not exposed to industrial pollutants would be directed to **an existing stormwater detention area. The location of the existing stormwater detention area is south of two small, delineated wetland areas (see Figure 3.7-1 and Appendix D, Wetlands Surveys [D1]) at the energy center and is depicted on Figure 2-13.** This **detention area** would store noncontact, non-industrial stormwater runoff (i.e., stormwater runoff not exposed to industrial pollutants). **The collected water would naturally evaporate and infiltrate into the groundwater system. The detention area currently exists and would not be significantly altered as part of the proposed project.** As a result, no direct impacts are expected and no permitting associated with the nearby small jurisdictional wetlands would be required.

Runoff would be conveyed using surface drainage; however, it is likely that some newly constructed stormwater inlets and underground storm sewers would be required. Minor indirect impacts of sedimentation could occur as a result of any construction activities associated with the installation of any new stormwater conveyances; however, these impacts would be short term and minimized through the implementation of the SWPPP required for NPDES permitting, which would include BMPs to control eroded sediments. Stormwater runoff exposed to coal storage (including coal pile runoff, coal handling dust suppression water, coal handling equipment wash-down water, and stormwater from the coal yard) would be diverted to the **new coal handling and contact runoff treatment system (see Section 2.4.2.2).**

No project components are proposed within or immediately adjacent to the onsite wetlands. The majority of construction would occur in areas that are currently developed or have historically been disturbed. In addition, no other NWI wetlands have been mapped within the boundaries of the FutureGen 2.0 impact areas as identified in Figure 3.7-1. No other wetlands were observed within, or immediately adjacent to, these impact areas during the field investigation conducted from May 23 to 27, 2011. As such, direct and indirect effects to wetlands at the Meredosia Energy Center would be minor, and would be avoided through sensitive project siting and design.

Floodplains

As shown on Figure 3.7-2, portions of the Meredosia Energy Center property and potentially affected offsite properties are located within mapped 100-year and 500-year floodplains associated with the Illinois River.

As described in Section 2.4.3, portions of the Meredosia Energy Center and nearby offsite areas are proposed for either permanent, temporary, or barge construction impacts as follows:

- Proposed permanent impact areas include the areas that would contain the oxy-combustion facility and associated features (e.g., paved areas) as shown in Figure 2-14 and Figure 2-15.
- Proposed temporary and barge impact areas include construction laydown areas or other construction-related work areas. This could also include areas in the Illinois River and along the shoreline where temporary pilings for fill could be installed to support barge unloading during construction. These areas would only be used during the construction period.

As shown on Figure 3.7-2, some of these proposed areas are located within mapped 100-year and 500-year floodplains. **Based upon original project design, as presented in the Draft EIS, approximately 24 acres of proposed permanent impact areas are located within the 100-year floodplain, while an additional 13.6 acres of proposed temporary or barge impact areas are located in the 100-year floodplain. However, the current design for the energy center would reduce the area of disturbance during construction to approximately 7.6 acres for permanent impact areas and 7.4 acres for temporary impact areas (see Section 2.4.3 for further discussion on estimated impact areas).**

The structures associated with the proposed oxy-combustion facility would be constructed adjacent to the existing Meredosia Energy Center within an area that is outside of mapped floodplains. Thus, the proposed structures would not present obstructions to flood flows in a mapped floodplain.

The **existing** stormwater **detention area** intersects the 100-year floodplain. This **existing** structure would not adversely affect flood flows or the floodplain since it would not interfere with flood flows and would likely provide additional storage. The **settling basin for the coal handling and contact runoff treatment system** would be constructed in an area outside of any mapped floodplain. As such, **neither of these structures would** adversely affect flood flows or the floodplain.

Although no new permanent structures are proposed to be constructed in a mapped floodplain, associated features (e.g., paved areas) would be located within up to 24 acres of a mapped floodplain **based upon the original project design as analyzed in the Draft EIS. However, based upon the current project design, only 7.6 acres of permanent impact areas would be located within a mapped floodplain.** These permanent impact areas would be developed in a manner that would not obstruct flood flows; however, specific plans have not yet been developed. Development of approximately 10 acres of impervious surfaces in areas that were previously pervious (e.g., grassy areas) would result in increased flow velocity and a reduction in infiltration rates in these areas. Certain beneficial aspects of floodplains, such as groundwater recharge and water quality maintenance, would also be reduced by an increase in impervious cover within the floodplain. However, these effects would be minor in terms of the size of the newly paved areas relative to the remaining unpaved areas. Should project planning ultimately propose additional buildings or structures within mapped 100-year floodplains, the Alliance would construct these buildings in accordance with the IAC and Morgan County Floodplain Ordinance as described in Section 3.7.1.5.

As noted above, up to 13.6 acres of proposed temporary or barge impact areas are located in the 100-year floodplain (**based upon the original configuration presented in the Draft EIS; current project design would reduce these impact areas to 7.4 acres**). The temporary presence of construction equipment and materials in these areas could cause a minor temporary direct impact. Impacts would not endanger human health or property or conflict with any state, local, or federal floodplain ordinances, as equipment would represent relatively small obstructions compared to the overall area of the Illinois River floodplain.

IDNR, Office of Water Resources, requires permits for various construction activities that occur in floodplains or floodways, under the Rivers, Lakes, and Streams Act. Depending on the types and locations of proposed construction activities, the Alliance may be required to obtain either a Statewide

Permit #6 (Minor, Non-Obstructive Floodway Construction Activities), Statewide Permit #8 (Underground Pipeline and Utility Crossings), or Statewide Permit #13 (Temporary Construction Activities) from IDNR prior to any construction activities.

Emplacement and use of the proposed temporary barge unloading facility during construction would result in only negligible floodplain impacts. Two options have been evaluated for barge unloading operations that would involve some level of disturbance to the river bottom, as detailed in Section 2.4.3.2. Under the first option, the placement of three to five dolphins would add 54 to 89 cubic yards of fill to the 100-year floodplain and reduce the 100-year flood area by 553 to 922 square feet. In comparison, IDOT determined that the proposed Illinois Route 104 bridge project, which would require 18,800 cubic yards of fill in the Illinois River, would cause a less than 0.005-inch increase in flood height and a minimal increase in floodplain limits (IDOT 2011). Thus, placement of the dolphins would cause a negligible increase in flood hazards and would not exceed any regulatory standards. Under the second option, the placement of any rip-rap on the riverbed (assumed to be 1-foot thick over an area of 200 feet by 50 feet) would add 370 cubic yards of material (2 percent of the new bridge volume [IDOT 2011]) and decrease the flow area by 50 square feet (0.1 percent of the existing flow area). This reduction would also cause a negligible increase in flood hazards and would not exceed any regulatory standards. If either of these options were carried forward, hydrologic modeling would likely be required to support required permitting of such activities and to ensure that no unacceptable impacts would occur to the floodway.

Development of the temporary barge unloading facility under either of these options would require a permit from IDNR for construction in a floodway, under IAC 17, Chapter I, Subchapter H, Part 3700. For a large waterbody such as the Illinois River, flash flooding is typically not a concern based upon the large volume of the streambed. However, large precipitation events or rapid snowmelt upstream within the watershed can result in significant riverine flooding. These types of flood events can typically be predicted hours to days ahead of time, based upon water levels within the river and known flood stage thresholds. The National Weather Service is the primary agency responsible for issuing flood advisories, watches, and warnings; such notices are often issued when flood conditions are anticipated within 48 to 72 hours or less. To avoid impacts from foreseeable flood events, the construction contractor would monitor official statements issued by the National Weather Service regarding flood potential in the project area. If such conditions are anticipated, the contractor would, to the extent possible, cease operations and move all equipment out of the floodplain prior to any flood occurrences.

The Alliance is also evaluating options for unloading equipment from barges that would avoid potential impacts by using a combination of on-shore equipment, tugs, and temporary ramps, so that there would be no disturbance to the bank or bottom of the Illinois River. Under this scenario, a portion of the temporary ramp may extend into the river to form a usable platform between the edge of the barge and the existing public boat ramps. This temporary ramp might extend 20 feet from the shoreline, although it has not yet been defined. River currents at the boat ramp area are usually mild, and there would be no need for filling, dredging, or modifications to the shoreline. Heavy equipment or haul trucks parked above the boat ramp area would potentially be used as temporary mooring devices for the barges. However, these plans are still under development and are being reviewed for their feasibility. Because the Alliance has not thoroughly determined the feasibility of this alternative scenario or developed a preliminary design, the Final EIS considers the impacts presented in the Draft EIS as representing appropriate, upper bounds for the barge unloading operations during construction of the oxy-combustion facility.

CO₂ Pipeline

Within the 4-mile wide pipeline corridor to the CO₂ storage study area, DOE analyzed two alternative routes: the southern route and the northern route (see Figure 2-18). **After the Draft EIS was published, the Alliance identified a proposed location for the injection well site (see Section 2.5.2.3) and additional routing for the southern pipeline (the Alliance's proposed route) so that it terminates at the proposed injection well site (see Section 2.5.1.1). The Alliance has not defined any additional**

routing for the northern route to the proposed injection well site, because the route is no longer under consideration.

In order to facilitate a representative comparison of wetlands and floodplains impacts for the two routes, the assessment of the southern route has been updated to include the final pipeline routing to the proposed injection well site. The assessment of the northern route has been updated to include potential impacts as determined through an analysis of hypothetical routing scenarios, as further described in Section 3.0. DOE used these hypothetical siting scenarios to evaluate a range of potential impacts, whereby some hypothetical routes would have less impact to physical resources and others would have greater impacts, while still representing reasonable routes.

Wetlands

As discussed in the Draft EIS, no NWI-mapped wetlands exist within the construction ROW for the southern route, and only approximately 0.2 acre of open water wetland is mapped within the construction ROW for the northern route (including hypothetical end-of-pipeline routes). However, it is noted that additional, non-NWI-mapped wetlands may be present within the construction ROWs, since the absence of NWI-mapped wetlands does not conclusively indicate the absence of wetlands.

In order to further confirm the presence and extent of wetlands, the Alliance conducted a formal wetland delineation of the southern pipeline route (proposed option) in spring 2013 (after the Draft EIS was published) in accordance with USACE delineation methodology. Based on the delineation, 14 wetland areas, ranging in size from about 0.02 to 0.1 acre for a total of approximately 0.5 acre of wetland, were identified within the ROW for the southern pipeline. The wetland survey also indicated that the southern route would cross 2 perennial streams, 13 intermittent streams (as classified by the USGS), and many ephemeral streams, swales, and ditches; see Section 3.6, Surface Water.

The Alliance is coordinating with USACE for a determination with respect to wetlands that are considered waters of the U.S. and to identify permitting requirements. The Alliance intends to avoid wetlands by using the trenchless technologies described in Chapter 2 in order to meet the requirement of Nationwide Permit No. 12 (Utility Line Activities) that “the activity does not result in the loss of greater than 0.5 acre of waters of the United States.” The Alliance plans to trench through only 0.03 acre of wetland, as authorized by the USACE (which is not anticipated to consider the feature jurisdictional), in an area that is currently actively-cultivated agricultural land and which is expected to return to the same use after installation of the pipeline.

Table 3.7-5 summarizes the amounts of wetland present within the construction ROW of each pipeline route option, and includes both wetlands mapped by NWI and wetlands identified by the Alliance as described above. The wetland acreage presented for the southern pipeline route is based upon the delineation conducted by the Alliance; the acreage presented for the northern route is based solely on NWI mapping data. As stated earlier, the actual number, type, and extent of wetland areas within the southern pipeline corridor must ultimately be verified by the USACE prior to construction; therefore, the acreages of wetlands present and amount of impact may change slightly.

A formal wetland delineation has not been conducted for the northern pipeline route, since it is no longer under consideration by the Alliance. If any significant changes occur to the final southern route and/or if another pipeline route is selected, the Alliance would conduct a formal wetland delineation of the final CO₂ pipeline route prior to construction. The final wetland determination will also be used as part of a Nationwide Permit No. 12 application for the project.

The Alliance sited the proposed southern pipeline route to minimize crossings of waterways (e.g., larger streams, rivers, ponds, and lakes) and wetlands. However, where water and wetland crossings are unavoidable for either route, the Alliance committed to using trenchless technologies, such as horizontal

directional drilling or jack and bore tunneling, to lay pipe beneath wetlands and surface waterbodies. Traditional trenching activities may still be used during pipeline installation across seasonally dry ephemeral or intermittent streams that are devoid of water at the time of construction.

Table 3.7-5. Wetlands within the Proposed Construction Right-of-Way for CO₂ Pipeline Routes

Route ^a	Acres ^b
Southern Route	0.5
Northern Route ^c	0.2 ^d

Source: USFWS 2012a

^a Construction ROW would be 80 feet wide.

^b Includes both NWI-mapped wetlands and wetlands identified during delineation of the southern route conducted by the Alliance in spring 2013. These wetlands have not yet been verified by the USACE.

^c The portion of the northern route within the storage study area is analyzed using a range of reasonable hypothetical end-of-pipeline routes as presented in the Draft EIS (see Section 3.0 for further discussion). This table presents the most conservative acreages from that analysis.

^d Only includes 'open water' wetland type identified by NWI mapping.

CO₂ = carbon dioxide; NWI = National Wetland Inventory; ROW = right-of-way

Horizontal directional drilling would be used for major waterbody crossings (i.e., waterbodies more than 100 feet wide). The minimum depth of cover for waterbodies requiring horizontal directional drilling would be at least 4 feet as required under 49 CFR 195.248(a). Jack and bore tunneling would be used for smaller surface water features and wetland areas. Additional trenchless technologies may be required due to environmental, land, or constructability requirements. Geotechnical investigations would be performed at proposed horizontal directional drilling locations, and contingency plans would be developed, as required, for completing waterbody crossings in the event of an unsuccessful horizontal directional drilling. By implementing trenchless construction techniques, impacts to waterbodies (such as the 0.2-acre open water area identified in Table 3-7.5) would be avoided and the waterways' beds and banks would not be disturbed. See Section 3.6, Surface Water, for further discussion of impacts to these surface water features.

The Alliance intends to avoid wetland features (including open water wetlands) during construction by employing the various trenchless technologies for the pipeline installation, as described earlier. Based on the results of the wetland delineation described above, the Alliance indicated a projected total of 13 major pipeline crossing locations involving wetlands and/or surface waterbodies in the currently proposed southern route, some of which involve two or more co-located features, which would require horizontal direction drilling and/or jack and bore tunneling. The exact number, type, and length of crossings would ultimately depend on the final pipeline route.

Through the implementation of trenchless technologies, the only wetland areas that could be directly impacted by conventional pipeline construction would be wetland areas encountered within or immediately adjacent to agricultural lands, as is the case for the 0.03 acre of potential wetland impacts for the southern route discussed earlier. However, these types of wetland areas are not expected to be considered jurisdictional by the USACE. Many wetland features in agricultural fields are not considered jurisdictional, because they typically lack the presence of sufficient hydrophytic vegetation due to the existence and maintenance of agricultural crops at these locations. To meet the criteria for a regulated (jurisdictional) wetland as defined by the USACE, a feature must possess each of the characteristics (hydric soils, hydrophytic vegetation, and hydrology) of the USACE's three-parameter approach to wetland identification. Additionally, it is also probable that wetlands within a large farm field would be hydrologically isolated from waters of the U.S., which would also likely exclude them from regulation under the CWA. However, the USACE would have ultimate discretion over which

wetland areas are considered regulated or not. A formal delineation would be conducted in the final pipeline route, and would be submitted to the USACE for Jurisdictional Determination, prior to construction.

Following any trenching and pipeline installation activities in agricultural wetlands, excavated wetland soils would be backfilled into the trenches so that the deepest soils excavated are returned as the deepest soils backfilled. This method of wetland soil backfilling would help maintain pre-construction wetland soil characteristics. These areas could then be returned to agricultural use consistent with pre-existing conditions.

The only regulated waters of the U.S. that could be directly impacted by pipeline construction would be dry ephemeral and intermittent streambeds. The majority of pipeline construction impacts to these features would be temporary and minor, consisting of short-term disturbances during pipeline construction. For crossings of dry streambeds, the pipeline construction ROWs would be cleared of any woody vegetation and the ground surface disturbed, primarily by the movement of equipment, digging of trenches, and stockpiling of excavated soils. After pipeline installation has been completed across a dry streambed, the ground surface would be restored and regraded to pre-construction contours, including restoration of the streambed and banks, so that there would be no permanent impact to, or loss of, jurisdictional ephemeral or intermittent streams.

In the event that the Alliance finds it necessary for the pipeline route to deviate from either the proposed southern route or the northern pipeline route, it is expected that impacts would be consistent with those addressed in this section, since the same siting criteria would be followed. In the event that the final pipeline routing results in additional impacts to wetlands, or if the pre-construction wetland delineation of the final CO₂ pipeline route identifies potential jurisdictional wetlands, trenchless construction methods would be used to avoid impacts to these areas; therefore, no direct impacts would be anticipated. Trenching would only be used within jurisdictional features if additional dry intermittent or ephemeral streams are encountered. In such cases, impacts would be similar to those described above.

Potential indirect impacts to wetlands from construction would be consistent with those presented earlier in this section.

As previously indicated, it is assumed that construction of the CO₂ pipeline would be authorized under a Nationwide Permit 12 (Utility Line Activities) issued by the USACE. A Nationwide Permit 12 authorizes the construction, maintenance, or repair of utility lines, including outfall and intake structures, and the associated excavation, backfill, or bedding for the utility lines, in all waters of the U.S., provided there is no change in pre-construction contours. Wetland mitigation is often required by USACE to allow activities to be performed in waters of the U.S. as part of the permitting process. Wetland mitigation offsets the loss of the benefits and functions of wetlands by providing an equivalent increase in benefits and functions in another area. There are five types of wetland mitigation: creation, restoration, enhancement, preservation, and the purchase of wetland mitigation credits from a wetland mitigation bank. If wetland mitigation is required, the magnitude and form of mitigation would be determined during the permitting process by USACE. Wetland mitigation would follow the USACE Rock Island District Compensatory Mitigation Policy for Illinois and would be determined through coordination with the USACE Rock Island District and St. Louis District, as needed and applicable.

Floodplains

Table 3.7-6 identifies the areas of mapped floodplains within the construction ROWs for the each of the proposed routes to the CO₂ storage study area.

Construction of the proposed pipeline would result in minor direct temporary impacts to 100-year and 500-year floodplains. At any crossing of a perennial stream or waterbody (e.g., larger streams, rivers, ponds, and lakes), the Alliance would use trenchless technologies to construct the pipeline beneath the waterway and any associated floodplain, thereby avoiding impacts. For the largest crossings, such as

beneath the Coon Creek Dike, soil boring may be required prior to horizontal directional drilling to characterize the underlying soils. These borings would likely be narrow-diameter, direct-push boreholes that would create negligible disturbance to adjacent waterbodies or floodplains. All boreholes would be properly closed in accordance with state regulations and restored to original grade. In areas where trenching occurs in floodplains, trenching would not be expected to increase flood hazards in the area or reduce the beneficial values of the floodplains. The installation of the pipeline through floodways would likely be covered under Statewide Permit No. 8 (Authorizing the Construction of Underground Pipeline and Utility Crossings), which authorizes the construction of pipelines beneath rivers, lakes, and streams.

Table 3.7-6. Floodplains within the Proposed Construction Right-of-Way for CO₂ Pipeline Routes

Floodplain	Southern Route ^a		Northern Route ^{a,b}	
	Associated Waters	Acres	Associated Waters	Acres
100-year	Illinois River, Coon Run, Lick Branch, Snake Creek	13.2 ^c	Illinois River, Coon Run, Lick Branch, Snake Creek, Indian Creek	19.6
500-year	Illinois River, Coon Run	1.1	Illinois River, Coon Run	1.1

Source: FEMA 2011

^a. Construction ROW would be 80 feet wide.

^b. **The portion of the northern route within the storage study area is analyzed using a range of reasonable hypothetical end-of-pipeline routes as presented in the Draft EIS (see Section 3.0 for further discussion). This table presents the most conservative acreages from that analysis.**

^c. **Includes 0.9 acre of floodplains located within additional easement areas outside of the primary construction ROW that would be required to facilitate construction equipment and activities at areas of trenchless drilling or boring.**

CO₂ = carbon dioxide; ROW = right-of-way

The temporary presence of construction equipment and soil piles in floodplains, however, could cause a minor temporary direct impact. By placing construction materials within the floodplain, flood flows could be impeded if a flooding event occurred during construction. It is not expected that this impact would reach a level of endangering human health or property or conflict with any state, local, or federal floodplain ordinances. Equipment and soil piles would be contained within the construction ROW and would represent relatively small obstructions for a short duration. As described earlier in this chapter, in order to avoid impacts from foreseeable flood events, the construction contractor would monitor official statements issued by the National Weather Service regarding flood potential in the project area. If such conditions are anticipated, the contractor would, to the extent possible, cease operations and move all equipment out of the floodplain prior to any flood occurrences.

Following installation of the pipeline, excavated soils would be backfilled and all disturbed land areas would be returned to their original grade, to the extent practicable. Exposed soil areas would be reseeded with native vegetation.

Although the pipeline itself would be buried, aboveground features would include meter stations and the launcher and receivers (start and end of the pipeline). Other aboveground features of the pipeline system would include:

- Pipeline markers at all crossings;
- Mainline block valve shelters;
- Cathodic protection station markers; and
- Temporary zinc anode site markers.

As stated in Chapter 2, mainline block valves would be placed along the pipeline to isolate and contain any line leak. The Alliance’s current conceptual design assumes that there would be one

mainline block valve at the beginning of the pipeline (at the Meredosia Energy Center), one at the end of the pipeline (at the injection well site), and two in between (i.e., 10 miles apart along the approximately 30-mile pipeline). While the exact number and location of the mainline block valves will be determined after additional hydraulic analysis, the Alliance committed to a maximum distance of 10 miles between mainline block valves; therefore, the impact analysis in the Final EIS addresses the 10-mile maximum spacing.

The Alliance indicated that the mainline block valves would be located on high ground outside of floodplains to the extent possible. The Alliance also indicated that the mainline block valves would be placed adjacent to existing roadways to the extent possible, to facilitate accessibility and avoid the need to construct access roads. Final placement of each mainline block valve and the need for access roads, if any, will not be determined until final design and siting are complete. Any aboveground features associated with the proposed pipeline would be small and widely-spaced along the operational ROW. If any aboveground features would be constructed in a floodplain, they would be constructed in accordance with the IAC and Morgan County Floodplain Ordinance as described in Section 3.7.1.5. This would minimize the potential for these structures to impede flood flows or reduce the beneficial value of these floodplains. Overall, minor impacts would be expected if structures are ultimately built within 100-year floodplains.

The IDNR, Office of Water Resources, requires permits for various construction activities that occur in floodplains or floodways, under the Rivers, Lakes, and Streams Act. Depending on the types and locations of proposed construction activities, the Alliance may be required to obtain either a Statewide Permit #6 (Minor, Non-Obstructive Floodway Construction Activities), Statewide Permit #8 (Underground Pipeline and Utility Crossings), or Statewide Permit #13 (Temporary Construction Activities) from IDNR prior to any construction activities.

For both the southern route and northern route, the CO₂ pipeline would cross underneath the portion of Coon Run that has been diked with a flood control levee. Prior to construction, the Alliance would obtain permission from the USACE for this crossing. To obtain permission for the crossing, the Alliance would provide a construction plan, site layout plan, project schedule, communication plan, safety procedures, emergency procedures, company experience record, contingency plan, and drilling fluid management plan to the USACE. The dike and the creek would be crossed using horizontal directional drilling and no direct impacts to the waterway would occur. However, it is important to ensure that construction beneath the dike does not adversely impact the stability of the dike. If the integrity of the dike were undermined, it could create a substantial flood hazard to the surrounding area. Should the Alliance receive USACE approval demonstrating adequate planning and design measures, negligible to minor impacts on flood hazards would be expected.

In the event that the Alliance finds it necessary for the pipeline route to deviate from either the southern or northern pipeline routes, it is expected that impacts would be consistent with those addressed in this section, since the same siting criteria would be followed. In the event that the final pipeline routing results in additional impacts to floodplains, such impacts would be similar to those addressed above since any aboveground features associated with the proposed pipeline would be small and widely-spaced along the operational ROW.

This section analyzed the impacts of the southern and northern pipeline routes, which end at the western border of the CO₂ storage study area. The route that the pipeline would take across the CO₂ storage study area depends upon the final siting of the CO₂ injection wells. Impacts related to these end-of-pipeline routes (spurs) to the injection wells are addressed in the next section, CO₂ Storage Study Area.

CO₂ Storage Study Area

In the Draft EIS, DOE analyzed a dual-site injection well scenario, which would involve two injection well sites with one vertical injection well at each site. During the preparation of the Draft EIS, the Alliance modified its injection well design. The Alliance now proposes a single-site

injection well scenario, which consists of one injection well site containing four horizontal injection wells located within one well pad.

Under the single-site scenario currently proposed by the Alliance, only one building would be required to be constructed at the injection well site. This building, known as the site control and maintenance building, would house the well annulus maintenance and monitoring system equipment. Other features of the surface facilities would include meters, surface piping, and piping-related equipment such as pig launchers. The conceptual layout for the injection well site includes a gravel well pad, the site control and maintenance building, and a parking lot connected to Beilschmidt Road by two access roads. Refer to Figure 2-20 for the proposed location of the single-site scenario injection wells and surface facilities.

The updated design for the single-site scenario would affect up to 15 acres for construction of the injection wells and associated facilities, and up to 4 acres for the access roads. An additional 24 acres would be affected during staging and construction of the monitoring well network, which would include monitoring wells located within the plume radius (see Figure 2-26). For the dual-site scenario analyzed in the Draft EIS which is no longer being considered by the Alliance, construction activities would affect up to 28 acres for the injection and monitoring wells and associated facilities; and up to 64 acres for staging and construction of access roads.

Wetlands

Table 3.7-3 and Figure 3.7-5 identify the types, locations, and extents of NWI-mapped wetlands within the CO₂ storage study area. For a more-detailed view of NWI wetlands, types, and locations, also refer to Figure C-6 in Appendix C, Map Views of Pipeline. Approximately 67.5 acres of wetlands are located within the 6,800-acre CO₂ storage study area, representing less than 1 percent of this area. The majority of these wetlands are located immediately along Indian Creek on the north side of the study area, as well as along portions of Indian Creek's largest tributaries.

Following the siting criteria detailed in Section 2.5.2.1, the Alliance would avoid regulated wetlands and waters of the U.S. during the formal design process of these proposed project components. Given the large area available within the study area compared to the relatively small size of proposed components, avoidance is feasible. Since no direct impact would occur to wetlands or waters of the U.S., no USACE wetland permitting would be required.

While wetlands and waters of the U.S. would be avoided, it is possible that land-disturbing activities could occur near wetland areas. This could result in minor short-term indirect impacts of increased sedimentation to these features. Neither the USACE nor the state of Illinois regulates wetland buffer areas (i.e., those areas immediately adjacent to wetlands). Such indirect effects would be minimized through the implementation of a SWPPP required for NPDES permitting, which would include BMPs to control eroded sediments (e.g., use of filter fencing).

The currently proposed location for the siting of the injection wells under the single-site scenario (the Alliance's proposed option) is depicted in Figure 2-20. The Alliance indicated that the intermittent stream (an unnamed tributary to Indian Creek) and adjacent wooded area in the southwest corner of the proposed impact area would not be disturbed during construction and operation; therefore, no direct impacts to wetlands or waters of the U.S. would occur under this option. However, a final decision about the location of the injection wells has not yet been made.

Floodplains

There are approximately 238 acres of FEMA-mapped 100-year floodplains within the CO₂ storage study area as identified in Table 3.7-4 and Figure 3.7-5. The majority of these floodplains are located along and immediately adjacent to Indian Creek in the northern portion of the study area.

Following the siting criteria detailed in Section 2.5.2.1, the Alliance would avoid mapped floodplains during the formal design process of these proposed project components. The criteria stipulate that the entire proposed injection well site(s) must be above the floodplain to ensure low potential for flood damage to the well infrastructure. Given the large area available within the study area compared to the relatively small size and footprint of the proposed components, avoidance is feasible. Therefore, no impacts to floodplains would occur.

The unnamed tributary to Indian Creek, located at the proposed injection well site (Figure 2-20) does not have any FEMA-mapped floodplains associated with it; therefore, no floodplain impacts would occur under this option. However, a final decision about the location of the injection wells has not yet been made.

Educational Facilities

As discussed in Section 2.5.3, the specific locations of the educational facilities are currently unknown, but would be located in the Jacksonville area. This proposed component would require approximately 3.5 acres of land and could involve new construction, rehabilitation of existing structures, or a combination of both types of construction activities. If development of the educational facilities involves new construction, it would most likely occur on previously disturbed land with existing utility connections. As such, it is unlikely that wetlands or floodplains would be present or affected. In the event that the educational facilities would require new construction, a wetland delineation and an analysis of floodplains on the proposed site would be conducted prior to construction. Since the location of the educational facilities is flexible within Jacksonville, it is anticipated that wetlands and floodplains would be avoided.

As described in Sections 2.5.3 and 3.0, since the release of the Draft EIS, discussions between the Alliance and Jacksonville civic authorities have focused on a potential site in Jacksonville for the educational facilities. Because the locations of the educational facilities currently remain unknown, DOE cannot address corresponding impacts to wetlands or floodplains, if any, at this time related to the siting of the educational facilities.

3.7.3.2 Operational Impacts

Meredosia Energy Center

This section discusses potential effects to wetlands and floodplains that would occur during operation of the proposed project at and in the vicinity of the Meredosia Energy Center.

Wetlands

Operation of the proposed oxy-combustion facility would not require the placement of fill material in or other disturbances to onsite wetland areas. Therefore, no effects to wetlands would be expected. Potential stormwater flows through onsite wetlands have been addressed in Section 3.7.3.1. These effects would be minor and could be beneficial to onsite wetlands.

During operation and on lands it controls, the Alliance would permanently preserve onsite, delineated wetland areas with fencing and signage so that these areas are not inadvertently disturbed, mowed, or cleared of vegetation.

Floodplains

Operation of the oxy-combustion facility would not result in any additional floodplain effects beyond those discussed in Section 3.7.3.1. Therefore, no additional effects to floodplains would be expected. Over the operational life of the proposed project, the stormwater detention area could result in a slight reduction of potential flood hazards, as the basin's purpose would be to infiltrate onsite stormwater and reduce surface water runoff entering the river. This impact would be considered positive or beneficial.

CO₂ Pipeline

Wetlands

Over the operational life of the proposed project, impacts to wetlands would be minimal. Minimal wetland impacts would result from maintenance activities, such as mowing, in close proximity to wetland areas. No mowing would be performed in wetland areas that occur within the operational ROW for the pipeline. Table 3.7-7 identifies wetlands that are located within the operational ROWs associated with the southern and northern CO₂ pipeline routes. **The wetland acreage presented for the southern pipeline route is based upon the delineation conducted by the Alliance; the acreage presented for the northern route is based solely on NWI mapping.**

Table 3.7-7. Wetlands within the Operational Right-of-Way for CO₂ Pipeline Routes

Route ^a	Acres ^b
Southern Route	0.3 ^c
Northern Route ^d	0.1 ^e

Source: USFWS 2012a

^a Operational ROW would be 50 feet wide.

^b Includes both NWI-mapped wetlands and wetlands identified during delineation of the southern route conducted by the Alliance in spring 2013. These wetlands have not yet been verified by the USACE.

^c Estimated based on approximate extent of wetlands observed with thin the southern pipeline route during the delineation conducted by the Alliance in spring 2013.

^d The portion of the northern route within the storage study area is analyzed using a range of reasonable hypothetical end-of-pipeline routes as presented in the Draft EIS (see Section 3.0 for further discussion). This table presents the most conservative acreages from that analysis for each resource.

^e Only includes ‘open water’ wetland type identified by NWI mapping.

CO₂ = carbon dioxide; NWI = National Wetland Inventory; ROW = right-of-way

In the event that the Alliance finds it necessary for the pipeline route to deviate from its proposed southern pipeline route, it is expected that impacts would be consistent with those addressed in this section, since the same siting criteria would be followed.

However, the Alliance also indicated that trenching may occur in any wetland area(s) encountered within agricultural lands within the ROW. Although the presence and extent of such areas are anticipated to be minimal and are not expected to be considered jurisdictional, these areas would be re-contoured to their pre-construction states after construction activities were completed, and subsequently replanted with pre-existing crops. Therefore, wetlands affected during construction would continue to exist as functioning wetlands during the operational life of the proposed project (i.e., they would not be filled). The Alliance indicated that maintenance activities within the operational ROW, such as mowing, would not be conducted in wetland areas. Therefore, no operational impacts would occur.

Based on current NWI mapping, **the results of the wetland delineation conducted by the Alliance**, and the proposed trenchless construction techniques to be utilized, **0.5 acre of wetlands would be avoided along** the proposed southern pipeline route, and approximately 0.2 acre of open water would be avoided via horizontal directional drilling along the northern pipeline route. As stated earlier, the Alliance indicated that maintenance activities within the operational ROW, such as mowing, would not be conducted in wetland areas. Therefore, no operational impacts would occur.

Though not anticipated, if any wetlands are impacted by the final pipeline route, wetland mitigation may be required. Wetland mitigation is often required by USACE to allow activities to be performed in waters of the U.S. as part of the permitting process. Wetland mitigation offsets the loss of the benefits and functions of wetlands by providing an equivalent increase in benefits and functions in another area. There are five types of wetland mitigation: creation, restoration, enhancement, preservation, and the purchase of

wetland mitigation credits from a wetland mitigation bank. If wetland mitigation is required, the magnitude and form of mitigation would be determined during the permitting process by USACE. Wetland mitigation would follow the USACE Rock Island District Compensatory Mitigation Policy for Illinois and would be determined through coordination with the USACE Rock Island District and St. Louis District, as needed and applicable.

In the event that a pipeline in a wetland required maintenance that necessitated excavation to expose the pipe, wetland impacts would be minor and the same as those described for construction (see Section 3.7.3.1).

Floodplains

Over the operational life of the proposed project, impacts to floodplains would be negligible within the 50-foot wide operational ROW. Table 3.7-8 identifies floodplains that are located within the operational ROWs associated with the southern and northern routes.

Table 3.7-8. Floodplains within the Operational Right-of-Way for CO₂ Pipeline Routes

Floodplain	Southern Route ^a		Northern Route ^{a,b}	
	Associated Waters	Acres	Associated Waters	Acres
100-year	Illinois River, Coon Run, Lick Branch, Snake Creek	7.6	Illinois River, Coon Run, Lick Branch, Snake Creek, Indian Creek	12.2
500-year	Illinois River	0.7	Illinois River	0.7

Source: FEMA 2011

^a. Operational ROW would be 50 feet wide.

^b. **The portion of the northern route within the storage study area is analyzed using a range of reasonable hypothetical end-of-pipeline routes as presented in the Draft EIS (see Section 3.0 for further discussion). This table presents the most conservative acreages from that analysis for each resource.**

CO₂ = carbon dioxide; ROW = right-of-way

Following construction, floodplain areas disturbed during pipeline installation would be restored to their original grades to the extent practicable. As identified in Section 3.7.3.1, if any aboveground features would be constructed in a floodplain, they would be constructed in accordance with the IAC and Morgan County Floodplain Ordinance as described in Section 3.7.1.5. As such, these features would result in negligible floodplain effects over the operational life of the proposed project.

CO₂ Storage Study Area

No additional impacts to wetlands or floodplains, beyond those addressed in Section 3.7.3.1, would be anticipated during the operation of the pipeline across the CO₂ storage study area to the injection wells.

Wetlands

No additional operational effects to wetlands beyond those discussed in Section 3.7.3.1 would be anticipated. Depending upon final siting of the proposed well site(s), it is possible that the movement of vehicles on access roads and in parking areas in the immediate vicinity could impact adjacent wetlands. This activity would result in minimal amounts of additional sedimentation to wetlands if they occur nearby. Should they occur, these potential indirect impacts would be negligible.

Floodplains

No additional operational effects to floodplains beyond those discussed in Section 3.7.3.1 would be anticipated.

Educational Facilities

No additional operational effects to wetlands or floodplains beyond those discussed in Section 3.7.3.1 would be anticipated.

3.7.4 Impacts of the No Action Alternative

Under the no action alternative, DOE would not provide cost-shared funding for the FutureGen 2.0 Project. Although the Alliance may still elect to construct and operate the project in the absence of DOE cost-shared funding, for the purposes of the analysis in this EIS, DOE assumed the no action alternative is equivalent to the no-build alternative. Therefore, the project would not be constructed and there would be no change to wetlands or floodplains.

INTENTIONALLY LEFT BLANK

3.8 BIOLOGICAL RESOURCES

3.8.1 Introduction

This section describes the biological resources potentially affected by the construction and operation of all components of the proposed FutureGen 2.0 Project. This section also analyzes the potential direct and indirect effects of this project on these resources.

3.8.1.1 Region of Influence

The ROI for biological resources includes the areas within Morgan County potentially affected by the construction and operation of the proposed project. These areas include the Meredosia Energy Center, the CO₂ pipeline, the injection wells, and the educational facilities. The ROI defines the extent of the areas where direct effects from construction and operation may be experienced, and it encompasses the areas where indirect effects from the proposed project would most likely occur.

3.8.1.2 Method of Analysis and Factors Considered

DOE reviewed a number of references to obtain information on the types of terrestrial and aquatic habitats and associated biological resources that could be affected by the proposed project. These included USFWS and state of Illinois lists and databases of protected species and habitats and state of Illinois ecological reports. In addition, DOE made observations of biological resources conditions at the Meredosia Energy Center and its vicinity during site visits in May 2011. DOE used this information to provide a description of the biological resources within the ROI in terms of the species and habitats present. DOE calculated quantitative estimates of potential direct terrestrial habitat loss utilizing GIS and land cover data. DOE made qualitative assessments of the overall direct and indirect effects to biological resources based on each component of the proposed project. DOE assessed the potential for impacts based on whether the proposed project would:

- Cause displacement of terrestrial or aquatic communities or loss of habitat;
- Diminish the value of habitat for wildlife or plants;
- Cause a decline in native wildlife populations;
- Interfere with the movement of native resident or migratory wildlife species;
- Conflict with applicable management plans for terrestrial, avian, and aquatic species and their habitat;
- Cause the introduction of noxious or invasive plant species;
- Diminish the value of habitat for fish species (including altering drainage patterns causing displacement of fish species or interfering with movement of native resident fish species);
- Cause a decline in native fish populations;
- Affect or displace endangered, threatened, or other special status species; or
- Cause encroachment on or affect designated critical habitat of a federally-listed species.

3.8.1.3 Regulatory Framework

Certain species, designated as threatened or endangered, are protected by the Endangered Species Act (ESA) of 1973, under the purview of the USFWS or NOAA Fisheries Service. While both agencies work to protect designated species, NOAA Fisheries Service has jurisdiction over marine resources within the United States' Exclusive Economic Zone (i.e., water 3 to 200 miles offshore) (NOAA Fisheries Service 2012). Due to the nature and location of the proposed project, no marine offshore species would be affected. Any protected species present within the ROI would fall under the jurisdiction of the USFWS, and for this reason, DOE did not consult with NOAA Fisheries Service regarding this proposed project.

The ESA prohibits the unauthorized “take” (i.e., harassment, harm, pursuit, hunting, shooting, wounding, killing, trapping, capture, collection, or the attempt to engage in any such conduct) of federally-protected species. Section 7 of the ESA requires all federal agencies to ensure that any action authorized, funded, or carried out by them is not likely to jeopardize the continued existence of a federally-protected species or adversely modify its designated “critical habitat.” Federally-protected species fall under one of two classifications:

- Endangered, including species, subspecies, or varieties in danger of extinction throughout all or a significant portion of their range; and
- Threatened, including species, subspecies, or varieties likely to become endangered within the foreseeable future.

Critical habitat is defined by the Endangered Species Act of 1973, as follows: a geographic area that contains features essential for the conservation of a threatened or endangered species that may require special management and protection. These areas are delineated by the USFWS and National Oceanic and Atmospheric Administration Fisheries Service with appropriate public review and notification in the *Federal Register*.

In addition, a species can be designated as “proposed” or “candidate.” This means that the species is being considered for protection as either endangered or threatened under the ESA. A proposed endangered or threatened species is one for which a proposed regulation, but not a final rule, has been published in the FR. A candidate species is one being considered for listing as endangered or threatened, but a proposed regulation has not yet been published in the FR. Until a final rule is published, a species designated as either proposed or candidate is not afforded any legal protection.

To comply with Section 7 of the ESA, DOE sent a consultation letter to the USFWS Marion Illinois Ecological Services Office to request information on federally-listed species and their critical habitats within the ROI and to solicit comments on the proposed project. The USFWS responded with a letter dated August 16, 2011 and provided information about federally-listed species potentially occurring in Morgan, Christian, and Douglas counties that could be affected by the FutureGen 2.0 Project (see Appendix B, Consultation Letters). Both the Alliance and DOE have continued dialogue with the USFWS regarding the proposed project and its potential effect on protected species.

The Alliance also discussed the project with the IDNR to aid in project siting, determining the potential impacts to state-protected species, and determining the need to perform species-specific surveys. As all discussions between the Alliance and IDNR have been considered informal, Appendix B, Consultation Letters, does not include any consultation letters from this state agency.

Under the Bald and Golden Eagle Protection Act of 1940, both species are afforded certain protections. Should any bald eagle nests be found within the ROI during pre-construction nesting surveys, the Alliance and DOE would adhere to the following guidelines established by the USFWS (USFWS 2010):

- Maintain a buffer between proposed construction activities and active bald eagle nests. If the proposed construction includes the emplacement of linear utilities (e.g., the proposed pipeline) and the nest is visible from the site, this buffer should be at least 660 feet wide. This buffer should be at least 330 feet wide if the nest is not visible from the site. If a similar activity is currently ongoing within the preferred buffer distance, the proposed construction may maintain a similar buffer as the existing, tolerated activity.
- Should construction occur within the recommended 660- or 330-foot wide buffer due to the existing presence of a similar activity, all clearing, construction, and landscaping would be limited to outside of the bald eagle nesting season (i.e., such activities should occur between early August and mid-July).
- Maintain an established landscape buffer to screen an active nest from the proposed project.

The Migratory Bird Treaty Act of 1918 provides protection to approximately 1,017 migratory bird species. Migratory birds are defined as any bird species that lives, reproduces, or migrates within or across international borders during its annual life cycle. As such, migratory birds are present within the ROI at various periods throughout the year. The act prohibits the taking (i.e., hunting, wounding, killing, possessing, or transporting) of any migratory bird, their eggs, feathers, or nests (USFWS 2012b).

The Illinois Endangered Species Protection Act of 1972 provides protection to species that are either in danger of becoming extinct in the state (designated as “endangered”) or are likely to become a state-endangered species (designated as “threatened”) as determined by the Illinois Endangered Species Protection Board. Species designated as threatened or endangered are noted as being on the “Illinois List.” The Illinois Endangered Species Protection Act makes it unlawful to:

- Possess, take (i.e., harm, hunt, shoot, pursue, lure, wound, kill, destroy, harass, spear, ensnare, trap, capture, collect, or attempt to engage in such conduct), transport, sell, offer for sale, give, or otherwise dispose of any animal, or the product of any animal, species that occurs on the Illinois List;
- Deliver, receive, carry, transport, or ship in interstate or foreign commerce and plant species listed as endangered by the federal government without an appropriate permit; or
- Take (i.e., collect, pick, cut, dig up, kill, destroy, bury, crush, or harm in any manner) plants on the Illinois List without the express written permission of the landowner; or sell or offer for sale plants or plant products of endangered species on the Illinois List.

3.8.2 Affected Environment

All components of the FutureGen 2.0 Project (i.e., the Meredosia Energy Center, CO₂ pipeline corridor, CO₂ storage study area, and the educational facilities) occur within the Interior River Valleys and Hills and the Central Corn Belt Plains Level III Ecoregions¹ (Woods et al. 2006a; represented respectively by numbers 72 and 54 in Figure 3.8-1). The Interior River Valleys and Hills Level III Ecoregion consists of many wide, flat-bottomed terraced valleys, forested valley slopes, and dissected glacial till plains. Prior to settlement as a U.S. territory in the 1800s, bottomland forests, prairies, and marshes were common in the alluvial plain and the river channel, while mixed oak and oak-hickory forests occupied the upland areas. Currently, the natural vegetation has largely been replaced by agriculture. Corn (*Zea mays*) and soybeans (*Glycine max*) are the major crops in this area (Woods et al. 2006b; USEPA 2010g).

¹ Designed to serve as a spatial framework for research assessment and monitoring of ecosystems and ecosystem components, ecoregions denote areas within which lands and aquatic areas, vegetation communities, and habitats (and the type, quality, and quantity of environmental resources) are generally similar. For the purposes of this EIS, Omernik’s ecoregion classifications are used. This hierarchical system, also used by the USEPA, identifies distinct ecoregions on the basis of “the spatial patterns of both the living and non-living components of the region, such as geology, physiography, vegetation, climate, soils, land use, wildlife water quality, and hydrology” (National Atlas of the United States 2012). Phenomena generally used to make these differentiations between ecoregions include geology, physiography, vegetation, climate, soils, land use, wildlife, and hydrology. Different levels have been developed to describe ecoregions at varying scales. A Roman numeral classification scheme distinguishes between these levels. Level I is the broadest level, dividing North America into 15 ecological regions; Level II divides the continent into 50 levels; and Level III divides the continent into 85 levels. For most of the United States, the ecoregions have been further subdivided to Level IV, which includes hundreds of levels.

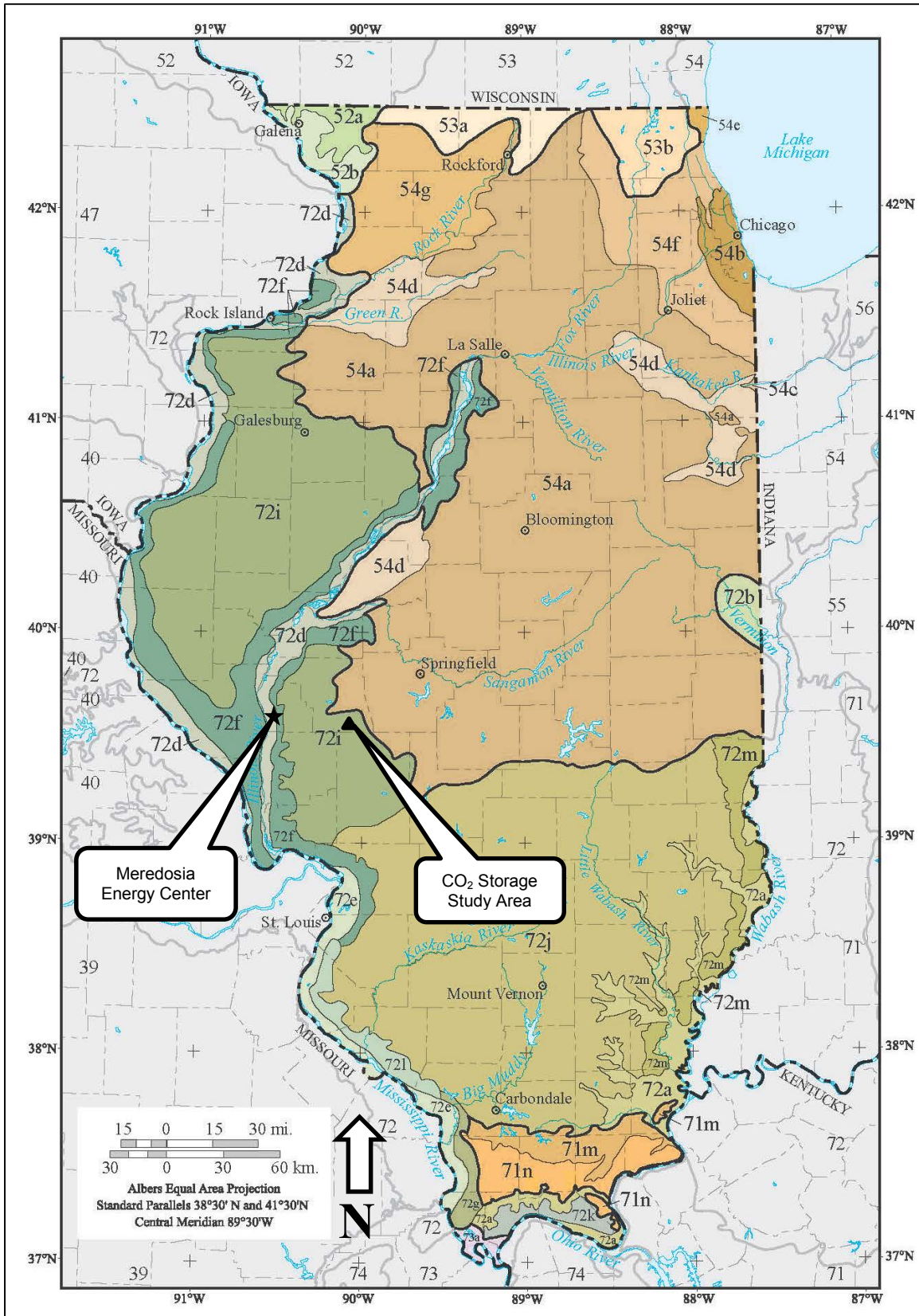

Source: Woods et al. 2006a

Figure 3.8-1. Illinois Level III and IV Ecoregions

Historically, the Central Corn Belt Plains Level III Ecoregion included extensive prairie communities intermixed with oak-hickory forests; however, European settlers replaced most of the native prairies with agricultural land. Extensive corn and soybean farms now dominate the dark, fertile soils of the Central Corn Belt Plains. Farms in this region also raise cattle, sheep, poultry, and especially hogs. Agricultural activities negatively affect stream chemistry, turbidity, and habitat throughout the area (Woods et al. 2006b).

The ROI includes portions of four different Level IV Ecoregions. Moving from west to east, these include the Upper Mississippi Alluvial Plain, River Hills, Western Dissected Illinoian Till Plain, and Illinois/Indiana Prairies (Woods et al. 2006a; see Figure 3.8-1). The presence of multiple Level IV Ecoregions in western and central Morgan County is primarily driven by proximity to the Illinois River, which is a major waterway with a large influence on the surrounding landscape. The following provides a brief description of each Level IV Ecoregion:

- The **Upper Mississippi Alluvial Plain Level IV Ecoregion** (Ecoregion 72d in Figure 3.8-1) encompasses the broad floodplains and low river terraces of the Mississippi River and its major tributaries upstream of the Mississippi's confluence with the Missouri River, including much of the Illinois River. Both the alluvial plain and the river channel have been heavily modified in the last 100 years. Prior to 1800, bottomland forests, prairies, and marshes were common. Agricultural land uses have now largely replaced the natural vegetation (Woods et al. 2006b).
- The **River Hills Level IV Ecoregion** (Ecoregion 72f in Figure 3.8-1) flanks the floodplains of the Mississippi, Illinois, and lower Sangamon Rivers in west central Illinois on dissected and forested hills, bluffs, cliffs, and ravines. Floodplain forests grow on bottomlands (Woods et al. 2006b).
- The **Western Dissected Illinoian Till Plain Level IV Ecoregion** (Ecoregion 72i in Figure 3.8-1) is a well-dissected till plain with broad, nearly level ridges, and many forested slopes, ravines, and floodplains. In the early 1800s, forests covered well-drained slopes and sites capable of holding moderate amounts of moisture. Prairies were found on nearly level ridges. Marshes and wet prairie also occurred, but were not common. Agricultural land uses have now almost entirely replaced the native prairies. Steep slopes and ravines remain largely wooded, but forested acreage is considerably less than it was at the time of European settlement (Woods et al. 2006b).
- The **Illinois/Indiana Prairies Level IV Ecoregion** (Ecoregion 54a in Figure 3.8-1) includes flat to rolling plains formed during the Wisconsinan glaciation. Naturally poorly drained, this area supported many ponds and swamps prior to European settlement. Settlers tilled, ditched, and drained the landscape to develop cropland. As dark, fertile soils characterize this ecoregion, farms flourished. Currently, croplands growing corn and soybeans and pastures supporting cattle, sheep, poultry, and hogs dominate the landscape (Woods et al. 2006b).

Specific habitats occurring within the ROI include terrestrial and aquatic habitats.

3.8.2.1 Terrestrial Habitat

Terrestrial habitats include agricultural land (including cropland and pastureland), developed land, forests (including deciduous forest and forested wetlands), and grassland.

Agricultural Land

Agricultural land is typically managed to support stands of a single plant species and is generally considered low-quality habitat. The lack of vegetative diversity leads to a lack of diversity in the species that inhabit these areas. Typical species encountered in agricultural areas include the following (IDNR 1997; IDNR 2001):

- **Vegetation:** The inherent management of agricultural land precludes the establishment of native vegetation within cultivated areas. Native plants may still exist in fence rows, drainage ditches, or isolated forest islands.

- **Mammals:** Mammal species found in such areas are generally limited to raccoon (*Procyon lotor*), white-tailed deer (*Odocoileus virginianus*), striped skunk (*Mephitis mephitis*), coyote (*Canis latrans*), red fox (*Vulpes vulpes*) and various rodents.
- **Amphibians and Reptiles:** Some amphibians (i.e., smallmouth salamander [*Ambystoma texanum*], American toad [*Bufo americanus*], western chorus frog [*Pseudacris triseriata*], and bullfrog [*Rana catesbeiana*]) can be found in agricultural areas if adequate breeding sites (e.g., ditches and flooded fields) are present. In addition, some reptile species, such as common garter snake (*Thamnophis sirtalis*), and fox snake (*Elaphe vulpina*), may also be present.
- **Birds:** Agricultural land is generally considered poor-quality habitat for bird species, and such areas are generally utilized by many invasive species, including rock dove (*Columba livia*) and European starling (*Sturnus vulgaris*). A few native grassland species utilize agricultural land, including horned lark (*Eremophila alpestris*) and American crow (*Corvus brachyrhynchos*). Agricultural lands offer very little in terms of stopover habitat for migratory birds, but during migration and winter, a few species (e.g., American pipit [*Anthus rubescens*] and snow bunting [*Plectrophenax nivalis*]) forage over some fields.

Developed Land

Developed land, including “barren land,” predominates in areas disturbed by human action. The existing landscape, potentially including topography and vegetative communities, has been altered so that it no longer maintains its natural characteristics. Typical species found in developed areas include the following (IDNR 2001):

- **Vegetation:** Plant species found in developed areas are typically those able to withstand human disturbance. These generally include weed species or invasive species, which provide low-quality habitat for animal species.
- **Mammals:** The general low-quality nature of developed areas provides habitat for more common wildlife species that are capable of surviving near human activities and disturbances. Mammal species typically present in developed habitats include white-tailed deer, gray squirrel (*Sciurus carolinensis*), and raccoon; common smaller mammal species include house mouse (*Mus musculus*) and eastern mole (*Scalopus aquaticus*). Certain bat species (e.g., big brown [*Eptesicus fuscus*] and little brown [*Myotis lucifugus*]) often roost in buildings and some can be present in developed habitats, foraging in areas with concentrations of flying insects (e.g., over stormwater drainage ditches).
- **Amphibians and Reptiles:** Relatively few reptile and amphibian species are present in developed landscapes. Amphibians present could include western chorus frog, if adequate breeding sites are located in the area (e.g., ditches or other wet areas), and Fowler’s toad (*Bufo fowleri*). Reptile species present could include brown snake (*Storeria dekayi*) or others that can tolerate a wide range of ecological conditions.
- **Birds:** Developed areas typically contain a mix of bird species due to artificial food sources provided by property owners and the overall variety of habitats that birds can exploit (e.g., maintained vegetation and buildings). Native bird species in developed areas include American crow, chipping sparrow (*Spizella passerina*), chimney swift (*Chaetura pelagica*), killdeer (*Charadrius vociferus*), and barn swallow (*Hirundo rustica*).

Forests

Forests typically provide diverse habitats for wildlife. Many species require forests to meet survival and breeding requirements. Overall, forests are the most biologically diverse terrestrial habitats in the ROI, particularly floodplain or wetland forests that offer nearby aquatic habitat. Examples of the types of

wildlife generally associated with central Illinois forests include the following (IDNR 1997; IDNR 2000; IDNR 2001):

- **Vegetation:** The plant species composition of each forest community is primarily driven by the soil moisture content, often related to relative elevation in the landscape and soil characteristics. Forested areas in the ROI, including deciduous forest and forested wetlands, contain a variety of tree species, such as: eastern cottonwood (*Populus deltoides*), elm (*Ulmus spp.*), ash (*Fraxinus spp.*), silver maple (*Acer saccharinum*), northern catalpa (*Catalpa speciosa*), red mulberry (*Morus rubra*), black locust (*Robinia pseudoacacia*), black oak (*Quercus velutina*), and sassafras (*Sassafras albidum*). The understory, or shrubbery, of the forested areas contains species such as dogwood (*Cornus spp.*), multiflora rose (*Rosa multiflora*), and honeysuckle (*Lonicera spp.*). Herbaceous groundcover within the forested areas consists of species such as Virginia creeper (*Parthenocissus quinquefolia*), catchweed bedstraw (*Galium aparine*), giant ragweed (*Ambrosia trifida*), common pokeweed (*Phytolacca americana*), poison ivy (*Toxicodendron radicans*), and greenbrier (*Smilax spp.*).
- **Mammals:** Mammal species found in the ROI's forests include eastern chipmunk (*Tamias striatus*), southern flying squirrel (*Glaucomys volans*), woodland vole (*Microtus pinetorum*), gray fox (*Urocyon cinereoargenteus*), gray squirrel, white-footed mouse (*Peromyscus leucopus*), raccoon, and white-tailed deer. Many bat species forage in forested habitats (e.g., little brown bat) and some roost under loose tree bark or in tree cavities (e.g., hoary bat [*Lasiurus cinereus*]).
- **Amphibians and reptiles:** Amphibian and reptile species present in forested areas include slimy salamander (*Plethodon glutinosus*), eastern gray treefrog (*Hyla versicolor*), spring peeper (*Pseudacris crucifer*), ground skink (*Scincella lateralis*), racer (*Coluber constrictor*), rat snake (*Elaphe obsoleta*), brown snake, and eastern hognose snake (*Heterodon platirhinos*). Most amphibians also require aquatic habitats for breeding.
- **Birds:** Overall, forest habitats are very important for migratory birds. For example, large concentrations of migratory birds may gather in forest habitats when bad weather forces them to stop in the area. Migrant bird species potentially encountered in forested areas include American woodcock (*Scolopax minor*), yellow-billed cuckoo (*Coccyzus americanus*), ruby-throated hummingbird (*Archilochus colubris*), great crested flycatcher (*Myiarchus crinitus*), red-eyed vireo (*Vireo olivaceus*), brown-headed cowbird (*Molothrus ater*), wood thrush (*Hylocichla mustelina*), blue-gray gnatcatcher (*Polioptila caerulea*), and Kentucky warbler (*Oporornis formosus*). Resident bird species typically found in forested areas include blue jay (*Cyanocitta cristata*), black-capped chickadee (*Poecile atricapillus*), tufted titmouse (*Baeolophus bicolor*), Carolina wren (*Thryothorus ludovicianus*), and northern cardinal (*Cardinalis cardinalis*).

Grasslands

Grassland habitats typically consist of warm-season grasses, with tree species providing 10 percent cover or less. The majority of the existing grasslands represent disturbed areas; few remnants of original grassland habitat remain. Disturbance in these areas includes the alternation of the natural fire regime and fragmentation, which leads to increased susceptibility to invasion by exotic species, habitat degradation, and small isolated populations of native species (IDNR 2001).

- **Vegetation:** Grassland/herbaceous (“open”) areas contain numerous species. Grasses consist mainly of *Carex* and *Panicum* species. Wildflower species present include false aster (*Boltonia asteroides*), Ohio spiderwort (*Tradescantia ohiensis*), violet (*Viola spp.*), goatsbeard (*Tragopogon pratensis*), and purple vetch (*Vicia americana*). Other herbaceous vegetation present in these areas includes species such as chive (*Allium schoenoprasum*), prickly pear cactus (*Opuntia humifusa*), common ragweed (*Ambrosia artemisiifolia*), and milkweed (*Asclepias spp.*).

- **Mammals:** Typical mammal species found in grassland habitats include the prairie vole (*Microtus ochrogaster*), woodland vole (*Microtus pinetorum*), and meadow jumping mouse (*Zapus hudsonius*).
- **Amphibians and reptiles:** Amphibian and reptile species that typically inhabit grasslands include the prairie kingsnake (*Lampropeltis calligaster*), tiger salamander (*Ambystoma tigrinum*), and gopher snake (*Pituophis menanoleucus*).
- **Birds:** A number of non-native bird species may utilize grasslands, such as European starling and rock dove. Native species include northern bobwhite (*Colinus virginianus*), field sparrow (*Spizella pusilla*), grasshopper sparrow (*Ammodramus savannarum*), and northern harrier (*Circus cyaneus*).

3.8.2.2 Aquatic Habitat

Wetlands, defined by the USACE as “those areas that are inundated or saturated by surface or groundwater at a frequency and duration sufficient to support, and that under normal circumstances do support, a prevalence of vegetation typically adapted for life in saturated soil conditions” (40 CFR 230), occur within the ROI. Specifically, a wetland delineation performed in 2011 identified two wetlands at the Meredosia Energy Center. Section 3.7, Wetlands and Floodplains, is dedicated to the discussion of wetlands and floodplains and provides additional details and analysis of these aquatic features within the ROI.

The Illinois River is the largest surface water feature in the ROI, and lies adjacent to the northwest of the Meredosia Energy Center. The Illinois River begins at the point where the Des Plaines and Kankakee Rivers converge near the Will County and Grundy County lines in Illinois. The Illinois River flows for a distance of 273 miles, ultimately entering the Mississippi River at Grafton, Illinois, approximately 40 miles north of St. Louis, Missouri. The Meredosia Energy Center is located between river miles 70 and 71 (i.e., between 70 and 71 miles from where the Illinois River meets the Mississippi River). The Illinois River is the largest tributary to the Mississippi River above the mouth of the Missouri River.

Historically, waterways in the Illinois River Basin (or Illinois River watershed) have experienced loss of ecological integrity due to sedimentation of backwaters and side channels; degradation of tributary streams; increased water level fluctuations partially due to the operation of locks and dams; reduction of floodplain and tributary habitat and connectivity; and other adverse impacts caused by human activities. A dramatic loss in productive Illinois River Basin backwaters, side channels, and channel border areas due to excessive sedimentation is limiting ecological health and altering the character of the overall river system. In particular, the Illinois River has lost much of its critical spawning, nursery, and overwintering areas for fish; habitat for waterfowl and aquatic species; and backwater aquatic plant communities, limiting ecological health and altering the floodplain river system (USACE 2007).

Section 303(d) of the CWA requires that states identify all waters where required pollution controls are not sufficient to attain or maintain applicable water quality standards and intended water uses, then implement appropriate measures to improve the water quality. As of 2012, the IEPA has identified 10 segments of the Illinois River (i.e., approximately 285 river miles) as impaired under Section 303(d). The USEPA approved each of these 10 impairments. One of these listed segments is the same portion of the Illinois River that forms the western boundary of Morgan County and is included in the ROI. Specifically, this river segment does not meet water quality standards for mercury, PCBs, and fecal coliform, rendering it unsuitable for fish consumption or primary contact recreation (IEPA 2012a). Refer to Section 3.6, Surface Water, for additional information regarding Section 303(d) waterways and the condition of this segment of the Illinois River.

Despite this damage and degradation, the ecology of the Illinois River system remains relatively diverse and biologically productive. Fish diversity is relatively high, with 115 fish species present. Ninety-five

(95) percent of these fish species are native. Many of these fish species require both riverine and backwater habitats as part of their life cycle (USACE 2007).

The most abundant fish species in the Illinois River mainstem in the general vicinity of the Meredosia Energy Center are gizzard shad (*Dorosoma cepedianum*) and emerald shiner (*Notropis atherinoides*). Several sport or commercially fished species are present, such as white bass (*Morone chrysops*), largemouth bass (*Micropterus salmoides*), and channel catfish (*Ictalurus punctatus*). In addition, several non-native fish species are present, which have the potential to outcompete native fishes for resources. Examples of such non-native species include silver carp (*Hypophthalmichthys molitrix*) and bighead carp (*Hypophthalmichthys nobilis*), collectively referred to as “Asian carp”, as well as white perch (*Morone americana*) (Thomas 1999).

A survey of mussel species in the Illinois River from 1993 to 1995, identified a total of 23 different species of Unionids (Family), as compared to 49 species present in the early 1900s. The most abundant species were threeridge (*Amblema plicata*), mapleleaf (*Quadrula quadrula*), deertoe (*Truncilla truncata*), fragile papershell (*Leptodea fragilis*), threehorn wartyback (*Obliquaria reflexa*), and giant floater (*Pyganodon grandis*). In addition, two non-native mussels were found between 1993 and 1995: zebra mussel (*Dreissena polymorpha*) and Asian clam (*Corbicula fluminea*) (Whitney et al. 1997). Zebra mussel infestations have played a large role in declining native mussel populations. However, these infestations have subsided considerably since 1995 (USACE 2007).

Other aquatic macroinvertebrate species of the Illinois River include mayflies (Order Ephemeroptera), fingernail clams (*Pisidium spp.*), midges (Family Chironomidae), and worms. Fingernail clams are a major food source for larger vertebrates (e.g., diving ducks). Fingernail clams suffered substantial population declines in the Illinois River in the 1950s (USACE 2007).

Surface waters in the ROI support a large diversity of aquatic biota. Habitats range in size from small headwater streams to large lakes or reservoirs artificially created through impounding. Fish species may be specific to certain habitat types (e.g., small headwater streams). However, many fish species can be found in a variety of aquatic habitats, particularly fish species common in standing water (e.g., lakes and ponds). Examples of common aquatic species in the ROI (i.e., central Illinois) include the following (IDNR 1997; IDNR 2000; IDNR 2001):

- **Fish (streams)** – creek chub (*Semotilus atromaculatus*), sand shiner (*Notropis ludibundus*), bluntnose minnow (*Pimephales notatus*), johnny darter (*Etheostoma nigrum*), and central stoneroller (*Campostoma anomalum*);
- **Fish (rivers)** – channel catfish, bullhead minnow (*Pimephales vigilax*), gizzard shad (*Dorosoma cepedianum*), smallmouth buffalo (*Ictiobus bubalus*), and freshwater drum (*Aplodinotus grunniens*);
- **Fish (standing water)** – largemouth bass, bluegill (*Lepomis macrochirus*), black bullhead (*Ameiurus melas*), green sunfish (*Lepomis cyanellus*), and white crappie (*Pomoxis annularis*);
- **Mussels** – pimpleback (*Quadrula pustulosa*), plain pocketbook (*Lampsilis cardium*), fragile papershell, mapleleaf, and white heelsplitter (*Lasmigona complanata*);
- **Crustaceans** – virile crayfish (*Orconectes virilis*), *Caecidotea intermedia* (isopod), and *Hyaella azteca* (amphipod); and
- **Other Macroinvertebrates** – segmented worms (e.g., *Aeolosoma hemprichi*), leeches (e.g., *Helobdella stagnalis*), mayflies (e.g., *Acentrella ampla*), damselflies (e.g., *Hetaerina titia*), and snails (e.g., *Micromenetus dilatatus*).

Aquatic habitats offer an important landscape feature for several species of birds – open, permanent water with a near-shore shallow water area (littoral zone). Species such as great blue heron (*Ardea herodias*), Canada goose (*Branta canadensis*), mallard (*Anas platyrhynchos*), and wood duck (*Aix sponsa*) often nest

along forested streams and rivers. Species such as common grackle (*Quiscalus quiscula*), red-winged blackbird (*Agelaius phoeniceus*), and song sparrow (*Melospiza melodia*) often nest on the shores of lakes and ponds. Species such as barn swallow and belted kingfisher (*Ceryle alcyon*) often forage over lakes and ponds. Overall, the most important role of lakes, ponds, and impoundments for birds are as resting habitat for migratory water birds (IDNR 1997; IDNR 2000; IDNR 2001).

The Illinois River is a major component of the internationally significant Mississippi River Flyway, a route followed by migratory birds between Canada and the Gulf Coast. The Mississippi River Flyway is utilized by 40 percent of all North American waterfowl and nearly half of all North American bird species (Audubon Society 2012). While not classified as an Audubon Important Bird Area, a survey conducted in the fall of 1994 found that 81 percent of the fall waterfowl migration in the Mississippi River Flyway utilized the Illinois River (USACE 2007).

The USFWS established a refuge in 1973 to provide habitat and protection to migratory birds utilizing the Mississippi River Flyway, and specifically the Illinois River. The 3,582-acre Meredosia National Wildlife Refuge is located approximately 2 miles north of the Meredosia Energy Center and, when complete, will provide a range of vital habitats, including seasonal wetlands and permanent marsh (USFWS 2012c).

3.8.2.3 Protected Species

Table 3.8-1 provides a summary of the federally- and state-protected species identified as potentially occurring in the ROI. As noted above, DOE determined these species using USFWS and IDNR county distribution lists, and the results of ongoing consultations with these agencies (USFWS 2012d; IDNR 2011). As requested by the IDNR, information regarding the specific locations of state-listed protected species is not included in this EIS.

Four federally-listed species potentially occur in Morgan County: decurrent false aster (*Boltonia decurrens*), eastern prairie fringed orchid (*Platanthera leucophaea*), Indiana bat (*Myotis sodalis*), and sheepsnose mussel (*Plethobasus cyphus*) (USFWS 2012d). Each of these four federally-listed species receives its protected status from the USFWS based on the effects of habitat conversion. The decurrent false aster naturally inhabits wet prairies along the Illinois and Mississippi rivers, but wetlands in these areas are being drained and modified to serve agricultural purposes (53 FR 45858). The eastern prairie fringed orchid thrives in natural prairie habitat, but much of the species' native range has been converted for crop fields or grazing, drained, or modified to reduce the risk of fires (54 FR 39857). The Indiana bat typically roosts under the loose bark of dead or dying trees and forage along edges of forested areas. Reasons for the bat's decline include disturbance of colonies by human beings, pesticide use and loss of summer habitat resulting from the clearing of forest cover (72 FR 19015). The sheepsnose mussel has suffered a 67 percent decline in occupied rivers as many stretches of large river habitat has been impounded in recent years. Small remaining populations are now isolated from each other, leaving all sheepsnose mussels at risk of extinction (USFWS 2012e). However, no critical habitat for these federally-listed species has been identified within Morgan County.

Thirteen additional species protected under the Illinois Endangered Species Protection Act, listed by the Illinois Endangered Species Protection Board and included in the Illinois Natural Heritage Database, have been identified in Morgan County: blue hearts (*Buchnera americana*), bunchflower (*Melanthium virginicum*), ebonyshell (*Fusconaia ebena*), Hall's bulrush (*Schoenoplectus hallii*), Illinois chorus frog (*Pseudacris streckeri illinoensis*), lined snake (*Tropidoclonion lineatum*), loggerhead shrike (*Lanius ludovicianus*), ottoe skipper (*Hesperia ottoe*), pale false foxglove (*Agalinis skinneriana*), pink milkwort (*Polygala incarnata*), regal fritillary, starhead topminnow (*Fundulus dispar*), and upland sandpiper (*Bartramia longicauda*) (IDNR 2011; see Table 3.8-1).

In addition to the species listed above, the state-endangered bent milkvetch (*Astragalus distortus*) is listed as occurring in some Illinois counties, but not currently within Morgan County. A qualified biologist identified a population of bent milkvetch at the Meredosia Energy Center during a field survey for other

species. This population has been flagged, brought to the attention of the IDNR, and included in Table 3.8-1.

Table 3.8-1. Federally- and State-Protected Species Potentially Occurring in Morgan County

Common Name	Scientific Name	Status ^a	Typical Habitat	Suitable Habitat Within ROI?
Plants				
Bent milkvetch	<i>Astragalus distortus</i>	SE	Dry prairies, barrens, and open woods	X
Blue hearts	<i>Buchnera americana</i>	ST	Sandy or gravelly soil of upland woods or prairies.	
Bunchflower	<i>Melanthium virginicum</i>	ST	Bogs, marshes, wet woods, savannas, meadows along railroads.	
Decurrent false aster	<i>Boltonia decurrens</i>	FT, ST	Moist alluvial soils that are regularly disturbed, preferably by periodic flooding. Historically occurred on lake shores and streambanks, including the Illinois River.	X
Eastern prairie fringed orchid	<i>Platanthera leucophaea</i>	FT	Moist to wet prairies and wet sedge meadows. Based on information from USFWS, this plant may occur in wet prairie remnants (see Appendix B, Consultation Letters).	X
Hall's bulrush	<i>Schoenoplectus hallii</i>	ST	Shores and bottoms of shallow ephemeral ponds, sinkhole ponds, coastal plain marshes, and similar habitats where widely fluctuating water levels keep the sands free of other vegetation.	
Pale false foxglove	<i>Agalinis skinneriana</i>	ST	Occurs mostly on moist to wet sandy prairies and on loess hill prairies.	X
Pink milkwort	<i>Polygala incarnata</i>	SE	Dry soil, upland woods, barrens, and prairies.	X
Mussels				
Sheepnose mussel	<i>Plethobasus cyphus</i>	FE	Large streams; prefers shallow shoal habitats with moderate currents over coarse sand and gravel. Extirpated from the Illinois River.	
Ebonys shell	<i>Fusconaia ebena</i>	ST	Large rivers; prefers swift water and stable sandy or gravelly shoals.	X
Insects				
Ottoe skipper	<i>Hesperia ottoe</i>	SE	Mid-grass to tall grass undisturbed prairies on the Great Plains, and dry fields and prairies, including sand prairies near the Great Lakes.	
Regal fritillary	<i>Speyeria idalia</i>	ST	Open grassy environments, ranging from xeric to quite hydric, completely flat to hilly. Populations require a large number of violet plants, the sole larval food plants of this species.	X
Amphibians				
Illinois chorus frog	<i>Pseudacris streckeri illinoensis</i>	ST	Sand prairies and cultivated fields, open sandy areas of river lowlands. Eggs and larvae develop in flooded fields, ditches, sloughs, small ponds, or other temporary bodies of water.	X
Reptiles				
Lined snake	<i>Tropidoclonion lineatum</i>	ST	Prairie hillsides and canyon bottoms, woodland edges, vacant city lots, residential yards, and abandoned trash dumps in moist environments; in daytime, this snake can be found under rocks, logs, trash, and other cover.	X

Table 3.8-1. Federally- and State-Protected Species Potentially Occurring in Morgan County

Common Name	Scientific Name	Status ^a	Typical Habitat	Suitable Habitat Within ROI?
Fish				
Starhead topminnow	<i>Fundulus dispar</i>	ST	Glacial lakes and clear, well-vegetated floodplain sloughs and lakes, quiet pools and backwaters of streams, swamps, and marshes.	
Birds				
Bald eagle	<i>Haliaeetus leucocephalus</i>	P ^b	Shorelines of rivers, lakes, reservoirs, and estuaries with tall trees for perching and nesting.	X
Loggerhead shrike	<i>Lanius ludovicianus</i>	SE	Breeds in open country with scattered trees and shrubs and, occasionally, open woodland; often perches on poles, wires, or fence posts. Nests in shrubs or small trees.	X
Upland sandpiper	<i>Bartramia longicauda</i>	SE	Extensive open tracts of short grass interspersed with or adjacent to taller grasses for nesting and brood cover.	X
Mammals				
Indiana bat	<i>Myotis sodalis</i>	FE	During the summer, roosts under loose bark on dead or dying trees and forages in or along the edges of forested areas. Hibernates in cool, humid caves with temperatures between 32° and 50° Fahrenheit.	X

Sources: Flora of North America, undated; IDNR 1997; IDNR 1998; IDNR 2000; IDNR 2001; Herkert and Ebinger 2002; IDNR 2003; Hill 2006; Minnis et al. 2006; NatureServe 2010; Battelle 2011a; IDNR 2011; Missouri Department of Conservation 2011; Smithsonian 2012; and USFWS 2012d.

^a FE = federally endangered; FT = federally threatened; P = protected; SE = state endangered in Illinois; ST = state threatened in Illinois

^b Although no longer protected under the ESA (USFWS 2012d), the bald eagle is still federally protected under the Bald and Golden Eagle Protection Act of 1940.

ESA = Endangered Species Act; ROI = region of influence; USFWS = U.S. Fish and Wildlife Service

3.8.2.4 Meredosia Energy Center

The Meredosia Energy Center and its vicinity are located in Morgan County, Illinois. The project ROI includes the entire 263-acre property. **As described in the Draft EIS, the Alliance originally anticipated the need to disturb 164 acres of the property for construction of the proposed oxy-combustion facility, including approximately 33 acres of forested area. The Alliance undertook steps to reduce potential impacts on forested areas of the property. Through ongoing refinements in site plans, the Alliance reduced the anticipated area of disturbance to 114 acres total, including up to 9 acres of forested area, as described in this Final EIS.**

Table 3.8-2, **as updated to show changes for the Final EIS**, provides a summary of the land cover types in the potential disturbance areas at the Meredosia Energy Center based on recent aerial photographs and data provided by the USDA/NRCS (2001). Land cover types typically indicate the habitat in the area and thus the wildlife or plant communities potentially present. Based on these data, the areas of proposed disturbance at the Meredosia Energy Center are primarily developed land or grasslands. **Figure 3.8-2 depicts the land cover types for the areas of anticipated disturbance based on the Alliance’s refinements to site plans for the Final EIS. For comparison, Figure 3.8-3 depicts the land cover types for the areas of anticipated disturbance as presented in the Draft EIS, which as described in Section 2.4.3, serves to represent the upper bound of potential impacts.**

Terrestrial Habitats

The Meredosia Energy Center and its vicinity are located entirely within the Upper Mississippi Alluvial Plain Level IV Ecoregion (Woods et al. 2006a; see Figure 3.8-1). As described in Section 3.8.2, this

Level IV Ecoregion encompasses the broad floodplains and low river terraces of the Mississippi River and its major tributaries above the Mississippi’s confluence with the Missouri River, including much of the Illinois River.

The terrestrial habitats of the Meredosia Energy Center and its vicinity consist of developed industrial land for the energy center infrastructure with areas of maintained grasslands and non-contiguous forested “islands” (see **Figure 3.8-2**).

Table 3.8-2. Land Cover Types within Potential Areas of Disturbance at the Meredosia Energy Center

Land Cover Type	Draft EIS (Acres) ^a	Final EIS (Acres) ^b
Developed or Barren	84	51
Forest, including Deciduous Forest and Forested Wetland ^c	33	9
Grassland	47	54
Water Feature, including Herbaceous Wetland and Open Water ^c	<1	0

Source: USDA/NRCS 2001

^a Represents the most conservative upper bound for impacts, as reflected in **Figure 3.8-3**.

^b Represents the Alliance’s current plans for impacts, as reflected in **Figure 3.8-2**.

^c A wetland delineation conducted at the Meredosia Energy Center **did not identify any surface water features, including wetlands, within the impact area** (see **Figure 3.8-2**). This delineation encompassed only the Meredosia Energy Center; no delineation has yet been performed along the proposed CO₂ pipeline corridor or at the proposed CO₂ storage study area. See Section 3.7, Wetlands and Floodplains, for more information.

CO₂ = carbon dioxide

Aquatic Habitat

While no natural aquatic features are present on the 263-acre Meredosia Energy Center property, a man-made bottom ash pond and a man-made fly ash pond exist along the western site boundary. The ponds were associated with energy center operations prior to the suspension of operations in 2011. Due to their man-made and industrial nature, coupled with regular disturbance, these aquatic features provide low habitat values.

A wetland delineation performed in May 2011 identified two wetlands along the eastern property boundary of the Meredosia Energy Center (see **Figure 3.7-1**). As discussed in Section 3.7, Wetlands and Floodplains, these two wetlands encompass approximately 0.37 acre and 0.26 acre, respectively, and, though not currently classified, would be described as scrub-shrub or shallow marsh or wet meadow by the IWI. A Jurisdictional Determination conducted by the USACE in August 2011 confirmed the results of this delineation and declared these two wetlands as waters of the U.S., subject to USACE jurisdiction under Section 404 of the CWA. **However, these two identified wetlands do not lie within the updated potential impact area at the Meredosia Energy Center and would not be affected by the proposed action.** No other wetlands were identified within the potential impact areas at the energy center. Refer to Section 3.7, Wetlands and Floodplains, for additional information regarding wetlands.

In 2002, a mussel survey identified four mussel beds in the Illinois River in the area of the Meredosia Energy Center (IDOT 2011). In addition, the Illinois Natural Areas Inventory identifies five areas in the Illinois River within approximately 2 miles downstream of the Meredosia Energy Center that are classified as Category VI natural areas. Category VI denotes areas of “unusual concentrations of flora or fauna” (IDNR 2009b). Presumably, in this case, this designation identifies mussel beds. It is important to note that the federally-listed sheepsnose mussel is extirpated from the Illinois River and the Category VI designation does not relate to protected species or specifically high-quality habitats.



Figure 3.8-2. Land Cover at the Meredosia Energy Center in Areas of Disturbance (Final EIS)

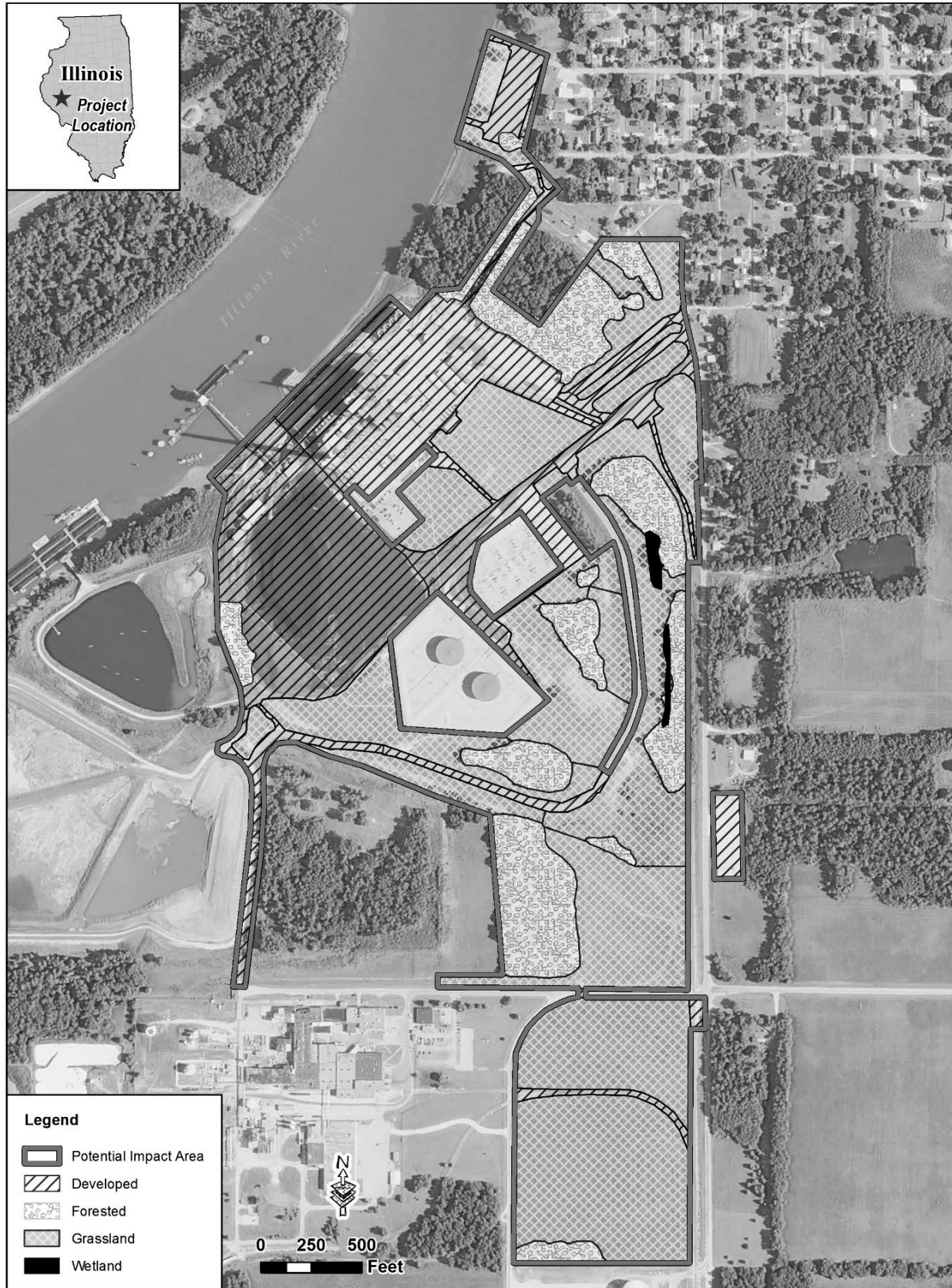

Figure 3.8-3. Land Cover at the Meredosia Energy Center in Areas of Disturbance (Draft EIS)

Protected Species

Based on existing habitats and consultation with the USFWS, bald eagle, decurrent false aster, and Indiana bat are the only federally-protected species with the potential to occur at the Meredosia Energy Center. Similar habitat analyses and consultation with the IDNR identified that the bent milkvetch, Illinois chorus frog, regal fritillary, and ebonyshell are the only state-protected species with the potential to occur at the Meredosia Energy Center or within the adjacent segment of the Illinois River (Battelle 2011a; IDOT 2011). Refer to Table 3.8-1 for more information regarding protected species. The list below summarizes the federally- and state-listed species with the potential to occur at the energy center.

- **Bald eagle – federally protected.** Although no longer protected by the USFWS under the ESA (USFWS 2012d), the bald eagle is still federally protected under the Bald and Golden Eagle Protection Act of 1940 (see Section 3.8.1.3). The bald eagle has been documented perching in trees along the Illinois River in the area of the Meredosia Energy Center (IDOT 2011; Ong 2012). Bald eagles typically nest in larger trees within 0.5 mile of a body of water with an unobstructed view of the water, primarily in undeveloped areas with little human activity. Bald eagles feed on fish primarily and nest near waterbodies (USFWS 2011b). As such, while no bald eagle nests have yet been observed in the area, the bald eagle may be present at or near the Meredosia Energy Center.
- **Bent milkvetch – state endangered.** The IDNR identifies bent milkvetch as a state-endangered plant species protected by the Illinois Endangered Species Protection Act. This species has been observed on the grounds of the Meredosia Energy Center site in a survey conducted by the Alliance. The areas containing the observed plants have been flagged and reported to Ameren; no additional bent milkvetch populations have currently been identified within the ROI (see Appendix E, Biological Surveys [E2]).
- **Decurrent false aster – federally threatened and state threatened.** Decurrent false asters may be present to the west of the Meredosia Energy Center site in an area that is periodically submerged within the Illinois River channel. During a March 2012 site visit, several asters were observed in this area; however, the specimens were dead and dried and could not be identified to the species level. It is unknown if these specimens were decurrent false asters. During a site visit in May 2011, several false asters (*Boltonia asteroides*), a non-listed, common species, were observed in the same general area. This may indicate that the dead specimens were the same common species and not the federally-listed species. However, this is not known, and this species may be present to the west of the Meredosia Energy Center.
- **Ebonyshell – state threatened.** While not located within the proposed barge unloading area, ebonyshell have been identified within the Illinois River. This species may be present in one of the five mussel beds identified within 2 miles downstream of the energy center in 2002 (IDOT 2011). Although this species has not been found onsite, it may occur within the immediate vicinity.
- **Illinois chorus frog – state threatened.** During a site visit in May 2011, DOE personnel delineated two relatively small wetland areas in a low area near the site boundary along Old Naples Road containing standing water at the surface (see **Figure 3.8-2**). These small wetland areas could provide Illinois chorus frog breeding habitat, as the Illinois chorus frog has been documented at a larger wetland located directly across Old Naples Road to the east (IDOT 2011). Considering the close proximity to the documented occurrence, it is possible that Illinois chorus frog may occur in these small, onsite wetland areas. While no Illinois chorus frogs were found on the site during a spring 2012 survey of the potential impact areas, there is still potential that they could be present on the site (see Appendix E, Biological Surveys [E1]). It is important to note that the lack of observations could also be a result of the unusually high temperatures and drought conditions present during the 2012 survey period.

- **Indiana bat – federally threatened.** Although not listed by the USFWS as occurring in Morgan County, the Alliance consulted with the USFWS and determined that suitable summer habitat may exist within the ROI. The USDA/NRCS identified approximately 35 acres of forested land cover at the Meredosia Energy Center in 2001. Indiana bats roost under the loose bark of dead or dying trees and forage along edges of forested areas. As such, though no Indiana bats have yet been observed in the area, individuals may be encountered in the forested areas at the Meredosia Energy Center.
- **Regal fritillary – state threatened.** Onsite grasslands could provide habitat for the regal fritillary butterfly. Regal fritillaries require large numbers of violet plants (on the order of hundreds of plants per square yard) for population viability as violets serve as the sole food plants for regal fritillary larvae. DOE performed a survey for violet plants and regal fritillaries in potential disturbance areas at the Meredosia Energy Center in the spring of 2012. The state-threatened butterfly and its habitat were both identified onsite during this survey (see Appendix E, Biological Surveys [E2]).

3.8.2.5 CO₂ Pipeline

The ROI associated with the CO₂ pipeline includes the entire CO₂ pipeline corridor, which includes approximately **69,380** acres in Morgan County, Illinois. The CO₂ pipeline corridor includes portions of three different Level IV Ecoregions, including the Upper Mississippi Alluvial Plain, River Hills, and Western Dissected Illinoian Till Plain (Woods et al. 2006a). Refer to Section 3.8.2 for a discussion of each of these ecoregions.

This section provides a general summary of the land cover occurring within this corridor based on data provided by the USDA/NRCS (see Table 3.8-3). As this data dates from 2001, the specific acreages of each land cover type may have changed over time.

Table 3.8-3. Land Cover Types within the CO₂ Pipeline Corridor and CO₂ Storage Study Area

Land Cover Type	CO ₂ Pipeline Corridor (acres) ^a	CO ₂ Storage Study Area ^b (acres) ^a
Agriculture, including Cropland and Pastureland	51,051 (74%)	6,201 (91%)
Developed or Barren	4,208 (6%)	223 (3%)
Forest, including Deciduous Forest and Forested Wetland	12,055 (17%)	357 (5%)
Grassland	51 (0.01%)	0
Water Feature, including Herbaceous Wetland and Open Water	2,015 (3%)	4 (0.01%)

Source: USDA/NRCS 2001

^a Percentage values are approximations due to rounding.

^b The CO₂ storage study area was originally analyzed in the Draft EIS as a 5,300-acre area. Since the Draft EIS was completed, the Alliance expanded the study area to approximately 6,800 acres to account for additional flexibility for CO₂ injection. Refer to Section 2.5.2 for additional details about the CO₂ storage study area. This table reflects the acreages and percentages based on the expanded storage study area.

CO₂ = carbon dioxide; % = percent

Terrestrial Habitat

Agricultural Land

The majority (74 percent) of the terrestrial landscape within the CO₂ pipeline corridor is agricultural, comprised of cropland and pastureland. Primary crops cultivated in this area include corn and soybeans.

Forests

Forested lands comprise approximately 17 percent of the CO₂ pipeline corridor. Most forested habitats within the ROI exist along streams and rivers where the terrain is too steep to plow or in areas set aside by government agencies for conservation and recreation.

Aquatic Habitat

Aquatic habitats, including herbaceous wetlands and open water, comprise approximately 3 percent of the CO₂ pipeline corridor. Aquatic habitats in the ROI include several surface waters, the most prominent of which include: Willow Creek, Coon Run, Spring Run, Mud Creek, Indian Creek, Lick Branch, Snake Creek, Conover Branch, and an upper tributary to Indian Creek (Battelle 2011a). Refer to Section 3.6, Surface Water, for additional information regarding surface water features within the proposed CO₂ pipeline corridor.

Protected Species

Federally- and state-listed species known to occur or potentially occurring within the CO₂ pipeline corridor include the following (Battelle 2011a; see Table 3.8-1 and Appendix E, Biological Surveys [E2]):

- **Indiana bat – federally endangered.** While the Indiana bat is not known to occur in Morgan County, potential habitat for this species includes wooded riparian areas within the CO₂ pipeline corridor (Battelle 2011a). As such, this special has potential to occur within the ROI.
- **Decurrent false aster – federally threatened.** According to the IDNR, this species is known to occur approximately 1.5 miles northwest and approximately 2.5 miles south of the proposed southern pipeline route (Battelle 2011a). No other populations of this species have been identified within the CO₂ pipeline corridor (i.e., no decurrent false asters have been observed within the proposed southern or northern pipeline routes). However, this species has potential to occur on streambanks and lake shores in the ROI.
- **Eastern prairie fringed orchid – federally threatened.** It is possible that this species could occur in lowland or wetland areas in the ROI. The primary habitat of the eastern prairie fringed orchid consists of moist to wet prairies and meadows. Based on land cover data, relatively limited grassland/herbaceous and emergent herbaceous wetland land cover exists within the CO₂ pipeline corridor (see Table 3.8-3). However, this species has potential to occur in lowland or wetland areas in the ROI.
- **Pale false foxglove – state threatened.** This plant species has been found by IDNR approximately 0.75 mile north of the proposed southern pipeline route in the vicinity of the Northeast Meredosia Nature Preserve (Battelle 2011a). This sighting represents the only known occurrence of this species within the CO₂ pipeline corridor. However, this species has potential to occur in moist to wet sandy prairies and on loess hill prairies in the ROI.
- **Regal fritillary – state threatened.** This species is known to occur approximately 2 to 3.5 miles from the proposed southern pipeline route, according to the IDNR (Battelle 2011a). A survey for individuals and habitat performed in spring 2012 identified 14 populations of violets, this species' sole larval food source, within the CO₂ pipeline corridor. In addition, emergent male and female

adult regal fritillary butterflies were observed within the CO₂ pipeline corridor during the 2012 survey (see Appendix E, Biological Surveys [E2]).

- **Illinois chorus frog – state threatened.** While past surveys observed this species adjacent to the proposed southern pipeline route, a more recent survey, conducted in March 2012, did not identify any Illinois chorus frogs in the ROI (see Appendix E, Biological Surveys [E1]). However, this species has potential to occur in wetland areas in the ROI.
- **Loggerhead shrike – state endangered.** This bird has been observed in the northern portion of the CO₂ pipeline corridor, approximately 1.3 miles from the southern pipeline route. There have been no additional reported occurrences in the ROI. However, this species has potential to nest in scattered shrubs and trees in the ROI.

3.8.2.6 CO₂ Storage Study Area

The **approximately 6,800-acre** CO₂ storage study area is entirely located within the Western Dissected Illinoian Till Plain Level IV Ecoregion (Woods et al. 2006a). Refer to Section 3.8.2 for a description of this ecoregion and a list of the land cover types (including associated flora and fauna) expected to occur there. Table 3.8-3 presents a summary of land cover types within the CO₂ storage study area, which is dominated (91 percent) by agricultural lands.

There are no known occurrences of federally- or state-protected species in the CO₂ storage study area (Battelle 2011a). The Alliance performed site-specific surveys for federally- and state-protected species to support development of the stratigraphic well. These surveys identified no federally- or state-protected species or their habitats in the area (see Appendix E, Biological Surveys [E4]). The Alliance also conducted a survey for federally- and state-protected species at the preliminary locations for soil gas monitoring within the CO₂ storage study area (see Appendix E, Biological Surveys [E3]). This survey was limited to seven monitoring sites comprising less than 50 square feet in total, all of which were located adjacent to county roads. No federally- or state-protected species were observed during this investigation. No other biological surveys have been conducted elsewhere on the CO₂ storage study area.

3.8.2.7 Educational Facilities

Educational facilities are proposed to be located in or near Jacksonville, Morgan County, Illinois on **approximately 2 acres** of land. Land cover in Jacksonville consists primarily of developed land, while the majority of the surrounding area consists of agricultural land with small, interspersed areas of forests, mostly around surface waters. The developed lands within Jacksonville and nearby agricultural lands offer limited habitat for wildlife, while wooded riparian areas likely offer the highest quality and most diverse habitat. There are numerous streams in the area, including Mauvaise Terre Creek and Big Sandy Creek, which feed Mauvaise Terre Lake and Lake Jacksonville, respectively. Generalized descriptions of terrestrial and aquatic habitats and the types of species anticipated to be present are described in Section 3.8.2.

3.8.3 Impacts of Proposed Action

DOE updated this section to reflect refinements that have been made to the project design since the Draft EIS was published.

Agricultural land would experience the greatest impact from the proposed project. However, with the exception of the acreage permanently dedicated for the siting of the injection and monitoring wells and associated infrastructure, all agricultural lands could be returned to their current, productive use after construction. The following subsections discuss potential impacts to land cover types and the species that inhabit them for each of the project components.

Table 3.8-4, **as included in the Draft EIS**, presents the likelihood of the proposed project to affect federally- and state-protected species potentially occurring within the ROI. **DOE consulted with the**

Table 3.8-4. Potential for Effects to Protected Species Potentially Occurring within the Region of Influence

Common Name	Status ^a	Potential for Effect	Potentially Occurring Within:			
			Meredosia Energy Center	CO ₂ Pipeline Corridor	CO ₂ Storage Study Area	Educational Facilities
Plants						
Bent milkvetch	SE	The proposed project would not affect a bent milkvetch population identified in the vicinity of the Meredosia Energy Center. A biologist identified 95 individuals of this protected species while conducting a survey for regal fritillary habitat. These populations occur in an area that would not be owned or disturbed by the Alliance during the construction or operation of the proposed project.	X			
Decurrent false aster	FT, ST	The proposed project may result in minor effects to the decurrent false aster. Appropriate habitat exists within the ROI and individuals have been observed within the proposed CO ₂ pipeline corridor; however, no individuals have been observed in areas that would be directly impacted by the proposed project. The Alliance and DOE have performed pre-construction surveys for this species within suitable habitat found at the Meredosia Energy Center and along portions of the southern pipeline route where potential habitat was previously identified; however, none were observed during these surveys.	X	X		
Eastern prairie fringed orchid	FT	The proposed project is not likely to affect the eastern prairie fringed orchid. Although appropriate habitat exists within the ROI, no individuals have been observed. If suitable habitat, such as lowland or wetland areas, would be impacted by project activities, the Alliance and DOE would perform a pre-construction survey in those areas prior to initial land clearing. If this species is identified, the Alliance and DOE would consult with the USFWS to develop and implement appropriate conservation measures to minimize potential impacts.			X	
Pale false foxglove	ST	The proposed project may result in minor adverse effects to the pale false foxglove. This species has been sighted within the CO ₂ pipeline corridor. If suitable habitat would be impacted by project activities, the Alliance and DOE would perform a pre-construction survey within the proposed final CO ₂ pipeline route prior to initial land clearing. If this species is identified, the Alliance and DOE would consult with the IDNR to develop and implement appropriate conservation measures to minimize potential impacts.		X		

Table 3.8-4. Potential for Effects to Protected Species Potentially Occurring within the Region of Influence

Common Name	Status ^a	Potential for Effect	Potentially Occurring Within:			
			Meredosia Energy Center	CO ₂ Pipeline Corridor	CO ₂ Storage Study Area	Educational Facilities
Mussels						
Ebonyshell	ST	If the Alliance undertakes activities related to the temporary barge unloading facility that would disturb the river bottom, minor adverse effects to the ebonyshell could result. While not located within the proposed barge unloading area, ebonyshell have been identified within the Illinois River. In the event that the Alliance plans to undertake construction activities that would disturb the river bottom, the Alliance and DOE would conduct a survey in the planned area of disturbance within the Illinois River. If the species is identified, the Alliance and DOE would consult with IDNR to develop and implement appropriate conservation measures to minimize impacts to this species.	X			
Insects						
Regal fritillary	ST	The proposed project may result in minor adverse effects to the regal fritillary. The Alliance and DOE have surveyed grasslands at the Meredosia Energy Center and within the CO ₂ pipeline corridor. Adult regal fritillaries and appropriate habitat were observed (see Appendix E, Biological Surveys [E2]). The Alliance and DOE would continue to consult with the IDNR to develop and implement appropriate conservation measures to minimize potential impacts.	X	X		
Amphibians						
Illinois chorus frog	ST	The proposed project may affect the Illinois chorus frog. The Alliance and DOE conducted a survey for this species at the Meredosia Energy Center and along the first 10 miles of the CO ₂ pipeline corridor, but did not identify any individuals (see Appendix E, Biological Surveys [E1]). Currently, no surveys for this species have been conducted along the remaining 16 miles of the CO ₂ pipeline corridor, and the likelihood of encountering Illinois chorus frogs in this area remains unknown. If individuals are identified in the future, the Alliance and DOE would consult with the IDNR to develop and implement appropriate conservation measures to minimize potential impacts.	X	X		

Table 3.8-4. Potential for Effects to Protected Species Potentially Occurring Within the Region of Influence

Common Name	Status ^a	Potential for Effect	Potentially Occurring Within:			
			Meredosia Energy Center	CO ₂ Pipeline Corridor	CO ₂ Storage Study Area	Educational Facilities
Reptiles						
Lined snake	ST	The proposed project is not likely to affect the lined snake. This species may inhabit the developed area in the vicinity of the proposed educational facilities. However, the Alliance currently proposes to utilize an existing structure to house these facilities. No lined snake habitat would be created or lost as a result of the proposed project. Should individuals be encountered during construction, the Alliance and DOE would consult with the IDNR to discuss whether conservation measures would be required.				X
Birds						
Bald eagle	P ^b	The proposed project may result in minor adverse effects to the bald eagle. Bald eagles have been observed along the Illinois River in the vicinity of the Meredosia Energy Center and forested areas exist within the proposed CO ₂ pipeline corridor. However, no nests have yet been identified. Should a bald eagle nest be encountered in the vicinity, the Alliance and DOE would consult with the USFWS to develop and implement appropriate conservation measures to minimize potential impacts.	X	X		
Loggerhead shrike	SE	The proposed project may result in minor adverse effects to the loggerhead shrike. This species may be encountered within the proposed CO ₂ pipeline corridor, but a concern would only arise if nesting habitat were removed (Ong 2012). The Alliance and DOE would survey open areas with scattered shrubs and small trees along the finalized pipeline route. If nests are identified, the Alliance and DOE would consult with IDNR to develop and implement appropriate conservation measures to minimize potential impacts.		X		

Table 3.8-4. Potential for Effects to Protected Species Potentially Occurring within the Region of Influence

Common Name	Status ^a	Potential for Effect	Potentially Occurring Within:			
			Meredosia Energy Center	CO ₂ Pipeline Corridor	CO ₂ Storage Study Area	Educational Facilities
Birds (continued)						
Upland Sandpiper	SE	The proposed project is not likely to affect the upland sandpiper. This species inhabits grasslands, which would only be temporarily disturbed under the proposed project and quickly re-established with native vegetation. The Alliance and DOE would survey areas of suitable habitat within the proposed CO ₂ pipeline corridor and the proposed CO ₂ storage study area. Should any individuals be encountered, the Alliance and DOE would consult with IDNR to develop and implement appropriate conservation measures to minimize potential impacts.		X	X	
Mammals						
Indiana bat	FE	The proposed project may result in minor adverse effects to the Indiana bat. This species roosts beneath loose bark of dead and dying trees. The Alliance and DOE would survey forested areas in the vicinity of the Meredosia Energy Center and within the proposed CO ₂ pipeline corridor. If any individuals are encountered, the Alliance and DOE would consult with the USFWS to develop and implement appropriate conservation measures to minimize potential impacts.	X	X		

^a. FE = federally endangered; FT = federally threatened; P = protected; SE = state endangered in Illinois; ST = state threatened in Illinois.

^b. Although no longer protected under the ESA (USFWS 2012d), the bald eagle is still federally protected under the Bald and Golden Eagle Protection Act of 1940.

CO₂ = carbon dioxide; DOE = U.S. Department of Energy; ESA = Endangered Species Act; IDNR = Illinois Department of Natural Resources; ROI = region of influence; USFWS = U.S. Fish and Wildlife Service

USFWS on the project, including updates to the project footprint and the status of surveys for threatened or endangered species. DOE plans to continue consultation with the IDNR regarding state-listed species. DOE is currently preparing a Biological Assessment for submission to the USFWS that addresses the three federally-listed species for which suitable habitat occurs in the project area: the Indiana bat, decurrent false aster, and eastern prairie fringed orchid. In the spring and summer of 2013, Indiana bat habitat assessment surveys were completed at the Meredosia Energy Center, along the current southern pipeline route, and at the proposed injection site. These bat surveys were conducted according to methods outlined in the 2013 Indiana Bat Summer Survey Guidance Overview (USFWS 2013).

Decurrent false aster surveys were conducted during flowering in late summer 2013 where potential habitat was identified in the project area. DOE oversaw an initial survey in November 2011 for the eastern prairie fringed orchid in the project area where potential habitat was identified. The soil types found in this area are not suitable for this species, and no individuals were found.

Appendix E, Biological Surveys, has been updated to include the status of surveys completed since the Draft EIS was published. The Biological Assessment was not yet completed for inclusion in the Final EIS. However, DOE is responsible under Section 7 of the Endangered Species Act to determine whether the proposed action may adversely affect listed species. Based on the progress of the Biological Assessment at publication of the Final EIS, DOE believes that the proposed action is not likely to adversely affect any of the listed species. The Biological Assessment, when submitted to the USFWS, will provide DOE's final determinations for each species and will identify measures as appropriate to minimize impacts to federally-listed species. The Biological Assessment would also support the USFWS in issuing its Biological Opinion for the project, if one is needed. The Alliance and DOE will also continue informal consultation with the IDNR regarding potential impacts to state-protected species and the need for species-specific surveys.

3.8.3.1 Construction Impacts

Meredosia Energy Center

This section analyzes impacts of the construction of the proposed project at the Meredosia Energy Center. Since publication of the Draft EIS, the Alliance undertook steps to reduce potential impacts on forested areas of the Meredosia Energy Center property. Through ongoing refinements in site plans by the Alliance, DOE determined that the potential loss of forested land would be reduced from the 33 acres described in the Draft EIS to a current estimate of approximately 9 acres or less (see Figures 3.8-2 and 3.8-3). If it is determined that any special status species or their habitat could be affected by the proposed project, the Alliance and DOE would work with IDNR and USFWS to develop and implement appropriate conservation measures to minimize potential impacts to these species.

Vegetation and Habitats – Meredosia Energy Center

Table 3.8-5, as updated for the Final EIS, identifies the amount of each land cover type that could be either temporarily disturbed or permanently displaced with implementation of the proposed project at the Meredosia Energy Center. As shown in that table, implementation of the proposed project could disturb approximately 9 acres of forested habitat, which would effectively be permanently lost due to the long period required for regeneration of the forested habitat. Construction would also temporarily disturb approximately 35 acres of grassland vegetation and permanently impact 19 acres of grassland (USDA/NRCS 2001). Refer to Figure 3.8-2, which has been updated for the Final EIS, for the current locations of these land cover types at the Meredosia Energy Center.

Within permanent impact areas, vegetation and habitats would be permanently converted to a non-vegetated state (i.e., industrial facilities, pavement, etc.). Within temporary disturbance areas, vegetation would be removed during construction, but the areas would be revegetated with native grassland species following construction.

Table 3.8-5. Potential Land Cover Lost within the Disturbed Areas of the Energy Center and Pipeline Routes

Land Cover Type	Meredosia Energy Center ^a		Proposed Southern CO ₂ Pipeline Route ^{b, c}		Proposed Northern CO ₂ Pipeline Route ^d	
	Temporarily Lost (acres)	Permanently Lost (acres)	Temporarily Lost (acres)	Permanently Lost (acres)	Temporarily Lost (acres)	Permanently Lost (acres)
Agriculture, including Cropland and Pastureland	0	0	248	0	243	0
Developed or Barren	6	45	1	2	6	9
Forest, including Deciduous Forest and Forested Wetland	0	9	0	6 ^{e, f}	0	22
Grassland	35	19	0	0	0	0
Water Feature, including Herbaceous Wetland and Open Water	0	0	0	0	0	0
Total	41	73	249	8	249	31

Source: USDA/NRCS 2001

^a The acreages for the Meredosia Energy Center presented in this table have been revised based on refinements to the preliminary design and site plan since the publication of the Draft EIS as explained in Section 3.8.2.4. The upper bound for potential areas of disturbance are reflected in the Draft EIS values shown in Table 3.8-2.

^b Since the release of the Draft EIS, the Alliance identified a location for the injection wells (see Section 2.5.2.3) and established the pipeline routing within the CO₂ storage study area for the southern route to the proposed injection well site. This table reflects the pipeline impacts for the southern route based on the currently proposed pipeline alignment from the energy center to the injection well site.

^c The Alliance would use trenchless pipe-boring techniques (i.e., jack and bore and horizontal directional drilling techniques) under sensitive natural resources. By implementing these underground boring techniques, the Alliance would avoid impacting sensitive resources at the surface, including wetlands and forested habitats. The numbers in this table present the actual acreages that would be lost and therefore do not include the areas for which boring is proposed.

^d The portion of the northern route within the storage study area is analyzed using a range of reasonable hypothetical end-of-pipeline routes as presented in the Draft EIS (see Section 3.0 for further discussion). This table presents the most conservative acreages from that analysis for each resource.

^e Since publication of the Draft EIS, the Alliance reduced the impact to forested area along the pipeline route to an approximate total forested area loss of 6.0 acres compared to the upper bound of 8.0 acres described in the Draft EIS. In all cases, the small areas of forest that would be affected are part of larger swaths of available forested habitat.

^f Due to the long regeneration time of trees, any forested habitat disturbed by short-term construction or long-term operation activities associated with the proposed action would effectively be permanently lost.

CO₂ = carbon dioxide

Overall, potential impacts to vegetation and wildlife habitats within the boundaries of the Meredosia Energy Center site would be minor. This area is a heavily developed, industrial landscape that provides low-quality wildlife habitat. During earth-disturbing activities, some smaller, less-mobile species, such as rodents, may perish, most likely due to collisions with equipment. However, these species are common, and losses would not be expected at a magnitude that would have population-level effects.

Vegetation and Habitats – Immediate Vicinity

The temporary barge unloading facility that would be used during construction, would be located near the eastern bank of the Illinois River, to the north of the Meredosia Energy Center site. The Draft EIS evaluated two options for barge unloading operations: (1) using mooring dolphins, or (2) grounding the barges on the river bottom. Both options would require disturbance to the riverbed. Section 3.6, Surface Water, describes the potential impacts of these options on local aquatic conditions.

The use of mooring dolphins would require installation of support piles driven into the riverbed. This would consist of a single disturbance during installation of three to five mooring dolphins (pilings) no greater than 48 inches in diameter (less than 100 square feet of disturbance in total). All mooring dolphins emplaced during this process would be removed after all modules have been delivered to the Meredosia Energy Center, expected to occur in early 2016. The emplacement and subsequent removal of mooring dolphins would disturb the riverbed and cause a slight increase in downstream sedimentation. The use of mooring dolphins could result in potential indirect, less-than-significant adverse effects to biological resources.

Grounding the barges on the river bottom would result in greater disturbance to the riverbed. Approximately 18,360 square feet (0.4 acre) of riverbed would be directly affected during each grounding and unloading event. The river bottom would be prepared by removing any large objects that may puncture the barge. If necessary, rip-rap or other suitable material would be placed on the river bottom to provide a foundation for the barge, prevent damage, and minimize riverbed impacts. All rip-rap emplaced during this process would be removed after all modules have been delivered to the Meredosia Energy Center.

The emplacement and removal of rip-rap would disturb the Illinois River riverbed and increase downstream sedimentation. While the sedimentation in and of itself would be considered a minor impact, this segment of the Illinois River has been designated as impaired under Section 303(d) of the CWA (see Section 3.6, Surface Water). The impaired designation is due, in part, to the presence of heavy metals (i.e., mercury and PCBs). When released into water, such heavy metals settle out of the water column and into the riverbed sediments. The emplacement or removal of rip-rap or grounding of a barge could disturb these contaminated sediments and re-suspend heavy metals into the water column. The re-suspension of mercury and PCBs could result in an indirect adverse impact to biological resources. The concentrations of buried contaminants within the sediment and the area potentially affected by re-suspension remain unknown at this time. However, increased exposure to or intake of these contaminants could result in a moderate adverse impact to local species within the in-water construction area. Re-suspended contaminants would disperse and dilute after entering the water column, possibly resulting in minor adverse effects downstream. The Alliance and DOE would coordinate with the USFWS, IDNR, and USACE to determine the potential extent of such impacts; develop and implement appropriate conservation measures; and determine the permits required to perform this work. Through this consultation and the implementation of appropriate conservation measures, potential adverse effects could be further reduced.

More mobile species (e.g., fish) would likely avoid the area of impact as barges approach, although it is possible that fish species could incur inadvertent mortality as barges are grounded. Adverse mortality impacts to other less-mobile aquatic species would be expected to be minor, considering that a relatively small area would be disturbed over a short period of time and that the Alliance and DOE would survey the affected length of the Illinois River and local downstream areas to ensure no protected species are present.

The Alliance is also evaluating options for unloading equipment from barges that would avoid potential impacts by using a combination of on-shore equipment, tugs, and temporary ramps so that there would be no disturbance to the bank or bottom of the Illinois River. **The Alliance is evaluating the use of a temporary ramp that might extend 20 feet from the shoreline. Under this scenario, there would be no need for filling, dredging, or modifications to the shoreline since river currents at the boat ramp area are usually mild. Heavy equipment or haul trucks parked above the boat ramp area could be used as temporary mooring devices for the barges.** However, these plans are still under development and being reviewed for their feasibility. **Because the Alliance has not thoroughly determined the feasibility of this alternative scenario or developed a preliminary design, the Final EIS considers the impacts presented in the Draft EIS as representing appropriate, upper bounds for the barge unloading operations during construction of the oxy-combustion facility.**

Overall, proposed construction activities at and in the vicinity of the Meredosia Energy Center would increase the potential for sedimentation in the Illinois River. In accordance with NPDES construction permitting requirements, the Alliance would develop and implement appropriate erosion controls and stormwater management plans to minimize the potential for erosion and sedimentation, reducing the potential for adverse impacts to aquatic species during construction activities (see Section 3.6, Surface Water).

Protected Species

As discussed in Section 3.8.2.4, and shown in Table 3.8-4, special status species may occur at the Meredosia Energy Center or within the immediate vicinity. **Section 3.8.3 discusses the status of consultations with USFWS and IDNR, surveys, the Biological Assessment, and the potential for the proposed project to affect these species.**

While not a special status species currently identified as occurring in Morgan County, bent milkvetch is listed as a state-endangered plant species in four Illinois counties. Individuals of this species have been observed, mapped, and flagged within a proposed permanent impact area on the grounds of the Meredosia Energy Center site. However, Ameren Transmission Company of Illinois is planning to purchase this portion of the Meredosia Energy Center and construct an electrical substation and overhead electrical transmission lines. Ameren is aware of these plants and has agreed to make every feasible effort to avoid impacts to the protected bent milkvetch. Should avoidance not be feasible, Ameren would coordinate with the IDNR to mitigate impacts as needed through the incidental take permitting regulatory process. Regardless of the plans of a future landowner, implementation of the proposed project by the Alliance would have no adverse impacts to bent milkvetch.

Forested areas in the vicinity of the Illinois River would be disturbed for construction. Such areas could provide nesting habitat for federally-protected bald eagles, although there are no documented nest sites on the Meredosia Energy Center. **DOE conducted bald eagle surveys on the Meredosia Energy Center in June 2013 and found no nesting bald eagles onsite. These results have been communicated verbally to USFWS and will be documented in the Biological Assessment as part of the Section 7 consultations.** DOE and the Alliance would comply with the guidelines established by the USFWS (see Section 3.8.1.3), thereby minimizing potential adverse effects to bald eagles.

Migratory Birds

In order to comply with the Migratory Bird Treaty Act (see Section 3.8.1.3), the Alliance would perform initial land clearing activities **between September and February to avoid disturbing nesting migratory birds.** As discussed in Appendix I, Public Comments on the Draft EIS, the forested acreage to be disturbed would be substantially less than estimated in the Draft EIS. Based on the revised estimate of affected forested lands in the Final EIS, and because only 9 acres of forested habitat would be affected, a small area in relation to the total available habitat in the region, DOE determined that **USDOI's recommendation for a conservation plan to restore and enhance migratory bird habitat in the vicinity of the project area is no longer warranted.** As such, no impacts to migratory birds or their nests or eggs would be anticipated, and no violations of the Act would occur.

CO₂ Pipeline

Since publication of the Draft EIS, the Alliance identified a location for the injection wells (see Section 2.5.2) and established the pipeline routing within the CO₂ storage study area for the southern route to the proposed injection well site. The Alliance has not identified a final routing within the storage study area for the northern route to the injection well site because the Alliance does not intend to use the northern route. As a result, the Final EIS addresses the pipeline impacts for the Alliance's proposed southern route, based on the currently proposed pipeline alignment from the energy center to the injection wells including refinements to the alignment as discussed in Section 2.5.1.1. This section addresses the pipeline impacts for the northern route based on the

analysis presented in the Draft EIS using hypothetical end-of-pipeline spurs as discussed in Section 3.0.

Construction of the proposed CO₂ pipeline would require the clearing of vegetation within the 80-foot wide construction ROW. This clearing would temporarily remove vegetated habitats from use by wildlife in the construction ROW and permanently remove up to **22 acres of forested land within the 50-foot operational ROW for the alternative northern pipeline route or up to 6 acres of forested land for the proposed southern route.** This would result in minor biological resources effects.

In the event that the Alliance finds it necessary for the pipeline route to deviate from either the southern or northern pipeline routes analyzed in this EIS, it is expected that impacts would be consistent with those addressed in this section, since the same siting criteria would be followed. In the event that the final pipeline routing results in additional impacts to biological resources, the Alliance would continue to consult with regulatory agencies, including the USFWS and IDNR, to develop appropriate conservation measures to minimize impact to species and habitats. As a result, impacts to biological resources along the final pipeline route are expected to be minor.

The construction ROW would generally be 80 feet wide, but a 100-foot wide construction ROW may be required under certain circumstances, such as for pipe transportation in wooded hilly terrain (see Section 2.5.1.3). Following construction, the temporarily disturbed land areas (i.e., the portions of the construction ROW outside of the 50-foot operational ROW) would be re-contoured and re-seeded with native plants appropriate to the area in order to restore the lands to their previous conditions; lands previously in agricultural production could return to agricultural production. The Alliance would implement measures to avoid the spread of invasive plants, such as washing construction equipment prior to its delivery to the construction site to minimize the potential for introduction of invasive seeds that may have been picked up at other locations. Disturbed agricultural land would be returned to agricultural production within the entire ROW (see Section 2.5.1.4), such that no long-term loss of agricultural lands would be anticipated.

Table 3.8-5 presents the extent of each land cover type within both the proposed CO₂ pipeline southern route and northern route.

Terrestrial Habitat

As shown in Table 3.8-5, the vast majority of affected land areas (**91 percent** along the proposed southern route and **86 percent** along the northern route) consist of agricultural land, including cropland and pastureland. As noted above, no long-term loss of agricultural lands would be anticipated. These areas provide low-quality habitat for wildlife. Higher-quality habitats, providing overall greater biodiversity, include wetlands and forested areas, which mainly occur adjacent to stream corridors and other surface waters.

During construction in areas where horizontal directional or jack and bore drilling is not utilized, habitats within the proposed construction ROW would be disturbed. Clearing of forested areas within the proposed construction ROW would cause a small degree of habitat fragmentation. Although the cleared ROW would not necessarily create an impassable barrier to wildlife movement, some species may not cross a location because the area was disturbed and the habitat altered. However, these effects would be localized and minor as there is relatively little forested habitat in the proposed construction ROWs (**approximately 6 acres** along the proposed southern route and **22 acres** along the northern route). Accidental mortality of wildlife could occur due to collisions with construction vehicles and equipment.

Impacts to forested areas and associated wildlife habitat along either the proposed southern route or northern route would be minor. **The Alliance plans to reduce potential impacts to forested areas through implementation of trenchless boring techniques. By using jack and bore or horizontal directional drilling, the pipeline could be installed under streams, wetlands, and road crossings without impacting sensitive natural resources on the surface. The southern pipeline route was**

selected to avoid additional habitat fragmentation by skirting the edges of forest patches and by minimizing the crossing distance at linear forested areas. As stated above, approximately 6 acres of forested habitat would be disturbed within the southern pipeline route. However, the Alliance would avoid impacts to an additional 7 acres of forest since these areas would be bored under to avoid wetland areas collocated within the forests. Because the forested areas are scattered along the route, the impact at each area would be small and range from about 0.03 acre to 1.7 acres. In all cases, the small areas of forest that would be affected are part of larger swaths of available forested habitat.

Aquatic Habitat

For either of the potential routes, the CO₂ pipeline would cross several streams (see Section 3.6, Surface Water, for more detailed information on water crossings). To avoid or reduce potential adverse impacts to wildlife habitat (i.e., especially to the high-quality habitats of wetlands and surface waters), the Alliance committed to adhering to a SWPPP (see Section 3.6, Surface Water) and performing trenchless drilling beneath all perennial surface water features without disturbing the bed or banks. Sedimentation could occur from construction activities in the general area of surface waters; however, this would likely be at small magnitudes and cause negligible, short-term impacts. Section 3.6, Surface Water, describes the horizontal directional and jack and bore drilling techniques in detail; based on that description, this process would not disturb the surface water feature being crossed.

Trenching could be employed for crossing narrow intermittent and ephemeral stream channels that were devoid of water at the time of construction, such as when a stream feature is seasonally dry or is frozen to the bottom. A field assessment would be made prior to construction at each crossing to determine the presence of water, and weather forecasts would be monitored to evaluate the potential for precipitation events that could lead to temporary water flow within the stream channel. Dry trenching would consist of excavating a trench through the stream channel, laying the pipe down, and then burying the pipe with the spoils removed during trench excavation. The pipeline crossing would be as nearly perpendicular to the stream channel as possible to minimize overall linear disturbance to the stream channel. Aquatic habitat, including streambanks and streambed substrate, would be restored to original grade following trenching activities. Streambanks would be restored using appropriate stabilization measures and revegetated following specifications outlined in Section 404 permitting. Aquatic habitats would likely recover shortly after construction activities, resulting in short-term, minor adverse impacts. Section 3.6, Surface Water, further discusses BMPs used during construction for protection of surface waters and required construction permitting.

Disturbance of the dry stream channels could cause some degree of temporary downstream sedimentation when flow returns to the channel, which could have negative effects to aquatic life primarily because the sediments can fill in open spaces within the stream bed that provide habitat for aquatic macroinvertebrates (e.g., insects). Therefore, construction activities across dry stream channels could cause a localized and temporary decline in insect populations downstream of the crossing, reducing available food resources for larger species (e.g., fish) within the affected segment of the stream. Since the stream channel would be stabilized and revegetated immediately following construction, these types of impacts would be significantly reduced and only minor impacts to aquatic species would be expected.

Protected Species

As discussed in Section 3.8.2.5 and shown in Table 3.8-4, multiple protected species may potentially occur within the CO₂ pipeline corridor. **The status of consultations with USFWS and IDNR, surveys, the Biological Assessment, and the potential for the proposed project to affect these species are discussed in Section 3.8.3.** Conservation measures that would or could be implemented are described in Section 4.2, Measures to Mitigate Adverse Impacts.

Migratory Birds

In order to avoid violating the Migratory Bird Treaty Act, the Alliance would perform initial land clearing activities between September and February to avoid disturbing nesting migratory birds. As discussed in Appendix I, Public Comments on the Draft EIS, the forested land to be disturbed would be approximately 9 acres, substantially less than the estimated 33 acres described in the Draft EIS. Based on the revised estimate of affected forested lands in the Final EIS, and because only a small amount of forested habitat would be affected in relation to the available habitat in the region, DOE believes that USDOJ's recommendation for a conservation plan to restore and enhance migratory bird habitat in the vicinity of project area is no longer warranted. As such, no impacts to migratory birds or their nests or eggs would be anticipated, and no violations of the Act would occur.

CO₂ Storage Study Area

Terrestrial and Aquatic Habitats

Construction of the CO₂ injection well site(s) would have temporary and permanent impacts on biological resources within the CO₂ storage study area. Table 3.8-3 presents the land cover types within the approximately 6,800-acre CO₂ storage study area. Minor terrestrial and no aquatic habitat effects would be anticipated.

For the dual-site scenario analyzed in the Draft EIS, but no longer under consideration by the Alliance, construction of the injection and monitoring wells and access roads would require up to 92 acres. Operation of the proposed facilities and roads would require up to 25 acres. The updated design for the single-site scenario currently proposed by the Alliance would require approximately 42 acres for construction of the injection and monitoring wells, associated facilities, and access roads; operation of these injection and monitoring facilities would require up to 14 acres.

Since publication of the Draft EIS, the Alliance identified a proposed 10-acre location for the injection well site as described in Section 2.5.2.1 and illustrated in Figure 2-20. The 10-acre site (referred to as the single-site scenario, and depicted in Figure 2-20) includes a forested wetland area along the western border and a cluster of trees in the southeastern corner collectively comprising approximately 2 acres. The Alliance intends to avoid impacts on the forested wetland by boring under it for the final CO₂ pipeline segment. The Alliance also plans to preserve existing trees on the site to the extent practicable by incorporating them into the site plan. The Alliance plans to lease an adjoining parcel to the north of the site for construction staging, which is almost entirely cultivated cropland. Approximately 4 acres of additional land area would be required for monitoring wells and access roads. The monitoring well network is depicted in Figure 2-26, but the locations are approximate and subject to landowner approval.

Construction at the CO₂ injection well site would disturb mostly agricultural land. Impacts to biological resources during construction activities would result from clearing of vegetation during construction of the injection wells and surface facilities, equipment movement, and construction equipment laydown. Once construction is completed, the areas not used for the wells and surface facilities would be regraded and revegetated to the extent practicable, with temporary and minor impacts to biological resources. Arrangements would be made with landowners to reduce the long-term impacts on agricultural land or other activities around the facilities. Potential impacts to prime farmland are discussed in Section 3.3, Physiography and Soils. To reduce impacts on agricultural land, the Alliance would adhere to mitigative actions specified in construction standards and policies set forth in an Agricultural Impact Mitigation agreement with the IDOA (see Section 3.3, Physiography and Soils).

Protected Species

Because the Alliance intends to follow its established siting criteria (see Section 2.5) to avoid protected species, no federally- or state-protected species would be affected by the construction of the proposed injection or monitoring wells. While loggerhead shrikes may forage in agricultural lands, this species nests in shrubs or small trees. Such areas would not be affected by proposed injection or monitoring well development.

Educational Facilities

The Alliance anticipates that the visitor, research, and training facilities would be located in or near Jacksonville, Illinois. The Alliance is working with local stakeholders to identify the locations that would best serve the functions of these facilities, as discussed in Sections 2.5.3 and 3.0. The facilities may be co-located, or there may be one location for the visitor and research center and another for the training facility. It is expected that they would be located in an existing building or occupy an area that has been previously disturbed and has existing utility connections onsite or immediately adjacent. Once the Alliance identifies a potential site, pre-construction surveys would be conducted to verify that no protected species would be impacted by the development of the facilities.

As described in Sections 2.5.3 and 3.0, since the release of the Draft EIS, discussions between the Alliance and Jacksonville civic authorities have focused on a potential site in Jacksonville for the educational facilities. Because the locations of the educational facilities currently remain unknown, DOE cannot characterize the existing biological resources.

It is likely that any habitat affected by the construction of the educational facilities would be in a developed setting and of low quality for wildlife use. Overall, minor habitat loss could occur during construction of this proposed project component and is not expected to adversely affect any federally- or state-listed species.

3.8.3.2 Operational Impacts

Meredosia Energy Center

Overall, minor biological resources impacts would be expected from the operation of the oxy-combustion facility. Any potential habitat losses arising from the FutureGen 2.0 Project would be incurred during the construction phase. The site is located within a disturbed industrial setting with high levels of human activity offering low-quality wildlife habitat. No additional long-term noise, light, glare, or air quality impacts to biological resources would be anticipated as compared to existing conditions.

As described in Section 3.6, Surface Water, the Meredosia Energy Center would use the existing intake to withdraw water from the Illinois River at a maximum velocity of 0.5 feet per second. This rate represents a reduced rate compared to that used prior to the suspension of facility operations at the end of 2011. At a withdrawal rate of 0.5 feet per second, most fish would be able to swim away from the intake structure without becoming trapped within the intake current, pinned against intake screens, and ultimately dying. Such a low velocity would also reduce the risk to fish eggs and newly-hatched fish. None of the species potentially affected by the intake structure are likely to be protected at either the state or the federal level, as the most proximate protected aquatic species (the ebonyshell) may occur two miles downstream from the Meredosia Energy Center (see Section 3.8.2.4). As such, operation of the intake structure under the FutureGen 2.0 Project would only have a minor adverse effect on aquatic life in the immediate vicinity.

The Meredosia Energy Center would utilize existing outfalls for the discharge of approximately **10.6** mgd of treated effluent and cooling water to the Illinois River. Of this, approximately **9.9** mgd would be thermal discharges from the cooling towers. Depending on the amount and temperature, the discharge of artificially-warmed water to the Illinois River could result in reduced levels of dissolved oxygen, increased algal growth, or a change in the composition of the local fish community, including a potential increase in non-native species (USEPA 2011m). As operations at the Meredosia Energy Center were suspended at the end of 2011, the discharge rate proposed under the FutureGen 2.0 Project represents an

increase over current levels. However, the proposed discharge represents an approximately **94** percent reduction in both overall and thermal discharges to the Illinois River over the historical operation of the energy center. As a result, operation of the Meredosia Energy Center under the proposed project would result in fewer adverse impacts to biological resources within the Illinois River than operation of the facility prior to suspension of the energy center's operations, reducing impacts to a minor level. However, the thermal discharge rates would increase in comparison to the current conditions where there is no discharge to the Illinois River. No appreciable effect on overall habitat quality of the Illinois River would be expected. Refer to Section 3.6, Surface Water, for additional details regarding proposed discharges and potential impacts to the Illinois River.

No impacts related to the temporary barge unloading facility would occur during operations, as the area would be returned to its pre-existing condition following construction.

CO₂ Pipeline

During operations, impacts to biological resources within the final pipeline ROW would be limited to permanent habitat conversions during construction, potentially removing these areas as viable habitat for species utilizing the pre-existing land covers. These impacts would occur during construction as described in Section 3.8.3.1, but would persist in currently forested areas within the operational ROW throughout the life of the project. Agricultural lands would be returned to agricultural production following construction, including within the operational ROW. As such, no long-term loss of agricultural lands would be anticipated.

Table 3.8-5 presents the land cover types within the proposed operational ROWs of the southern and northern pipeline routes from the Meredosia Energy Center to the western border of the CO₂ storage study area. Agricultural land accounts for the vast majority of potentially affected land covers. However, some natural forested habitat and developed or barren areas would be affected. The proposed southern route would result in the loss of up to **6** acres of forested lands (see Table 3.8-4). The northern route would result in the loss of up to **22** acres of forested lands within the operational ROW.

Throughout the life of the project, the 50-foot wide operational ROW would be kept free of woody vegetation to permit access for inspection and maintenance activities. This would leave the vegetation in the operational ROW in a persistent herbaceous state, creating a long-term (during the life of the project) habitat conversion in areas that were previously forested. Clearing of forested areas would cause a small degree of habitat fragmentation. Although the cleared corridor would not necessarily create an impassable barrier to wildlife movement, some species may not cross a location because the area was disturbed and habitat altered.

The vast majority of potentially affected land areas consist of agricultural land, including cropland and pastureland. Affected agricultural lands would be returned to agricultural uses following construction of the proposed CO₂ pipeline route. It is anticipated that the proposed project would have no long-term impact on agricultural land.

Vegetation maintenance (e.g., mowing and herbicide treatments) would be performed outside of the migratory bird nesting season (April 1 to July 31) in order to avoid potential long-term impacts to migratory birds and violating the Migratory Bird Treaty Act (see Section 3.8.1.3).

As identified in Section 3.8.1.3, bald eagles receive protection under the Bald and Golden Eagle Protection Act of 1940 and the conservation measures recommended by the USFWS (2010b). The Alliance would comply with these guidelines; therefore, no impacts to bald eagles are anticipated as a result of the operation of the proposed project.

The potential release of CO₂ from the pipeline as a result of either a puncture or rupture is considered to be highly unlikely. If a leak or rupture of the proposed CO₂ pipeline were to occur, respiratory effects to biota due to increased atmospheric CO₂ concentrations would be limited to the immediate vicinity where

the rupture or leak occurred. Refer to Section 3.17, Human Health and Safety, for additional information about the potential for pipeline leakage or rupture.

Should the CO₂ be released into a stream or waterbody, it would dissolve in the water up to its solubility, given the pH, total dissolved solids, and temperature of the water at the time of the release. The CO₂ concentration in the water is unlikely to reach 2 percent (which is when injuries to aquatic life can occur), since the solubility of CO₂ at typical atmospheric conditions would keep the concentration less than approximately 0.2 percent.

Under normal operating conditions, the temperature of the CO₂ being transported through the pipeline would be approximately 90°F at the pipeline point of entry at the Meredosia Energy Center; the maximum temperature could be up to 110°F. The temperature would drop to approximately 72°F at the CO₂ injection site. While the presence of the pipeline could cause some degree of warming of the surrounding soils, particularly during the winter months, the pipeline would be placed at least 5 feet beneath the ground surface in agricultural areas in accordance with IDOA pipeline construction standards and policies and the Agricultural Impact Mitigation Agreement signed by the Alliance (see Section 2.5.1.3 and Appendix H, Agricultural Mitigation). At this depth, the proposed pipeline would have little effect on the root zone temperature of agricultural crops.

The U.S. Department of State conducted a study of the effects of soil temperature increases as a result of pipeline operations for the proposed Keystone XL oil pipeline. In the Pipeline Temperature Effects Study, included in Appendix L of the Keystone XL Draft EIS, the pipeline temperature was expected to be warmer than the proposed CO₂ pipeline (i.e., approximately 95°F to 130°F). The study modeled anticipated heat flux to the surrounding ground, studied the existing literature, and consulted land management experts to determine potential effects to vegetation and crops. The study concluded that positive effects on vegetation and crops have been documented in terms of spring emergence and plant growth, while negative aspects on plant growth have not been documented for the potential temperature range associated with the pipeline (U.S. Department of State 2011).

DOE received a scoping comment asking if the proposed “warm” pipeline could cause mold or insects to proliferate during the winter months. DOE researched the issue and was unable to find any literature regarding potential growth of mold or insects, although it appears unlikely that such impacts would result. Although the Pipeline Temperature Effects Study included from the Keystone XL Draft EIS did not specifically address the potential effects of molds and insects, the study identified that temperature fluxes would be directed downward and, in the winter, root zone temperatures would be affected by the ambient temperature as opposed to the proposed pipeline (U.S. Department of State 2011). Soil molds and insects would most likely occur near the plant root zone and close to the ground surface. Considering the many miles of existing pipelines in the United States, studies regarding the ecological impacts of pipeline development, and the lack of literature on effects of molds, insects, or other pests due to pipeline-caused thermal variations, there is no evidence that the operation of the proposed pipeline could result in the potential issues raised by the commentor. Thus, DOE has no reason to conclude that thermal impacts to vegetation or crops due to operation of the proposed pipeline would occur.

CO₂ Storage Study Area

Overall, minor impacts to biological resources would be expected during operation of the injection and monitoring well sites as any potential habitat losses resulting from the proposed project would occur during the construction phase. It is important to note that, for the injection and monitoring well sites, agricultural lands are the most likely to be affected, and these are generally considered low-quality wildlife habitat.

Following construction, **as many as 25 acres** would be permanently converted to developed uses due to placement of facilities and infrastructure. **Under the dual-site scenario, which is no longer under consideration by the Alliance, the permanent operational footprint of the CO₂ injection wells and supporting facilities would occupy approximately 10 acres, while up to 15 acres would be occupied**

by access roads to the injection well sites. Under the single-site scenario currently proposed by the Alliance, the CO₂ injection wells and supporting facilities would occupy approximately 10 acres for the permanent operational footprint and approximately 4 acres for access roads to the monitoring wells.

Operation of the proposed wells would generate noise, light, and glare, which may cause avoidance of the area by wildlife. Should there be any surface waters in the immediate vicinity of the selected well sites, it is possible that surface disturbances, such as vehicular movements, could indirectly contribute small amounts of sedimentation to those waterways, which would cause negligible aquatic habitat degradation. However, these potential effects would likely be avoided with implementation of BMPs (see Section 3.6, Surface Water) and adherence to the Alliance's well siting criteria.

The driving force behind siting the injection wells is suitable geology, which includes the presence of a suitable impermeable caprock to prevent the upward migration of CO₂ to the surface. Thus, it is highly unlikely that the injected CO₂ would migrate to the surface and cause any impacts to aquatic or terrestrial habitats.

The injection of CO₂ into the deep subsurface has the potential to affect subsurface organisms **within the approximately 4,000-acre CO₂ plume radius**. Microbial life in the deep subsurface was discovered approximately 20 years ago. Until recently, the deep subsurface has been considered a place where only single-celled organisms could exist due to temperature, energy, oxygen, and space constraints. However, species of multicellular roundworms (phylum Nematoda) have been discovered in South Africa, from water at a depth of approximately 2 miles (Borgonie et al. 2011). In general, these subsurface biological communities are poorly understood and may be more complex than previously thought.

DOE/NETL is funding a study with the University of Illinois Urbana-Champaign at a carbon capture and storage project near Decatur, Illinois in order to improve the understanding of subsurface ecology and impacts of CO₂ storage. The study is being performed in the Mt. Simon Formation and includes identifying sets of subsurface microbes before and after CO₂ injection. The total set of observations would allow characterization of the subsurface microbial community in a CO₂ storage reservoir in the context of the local reservoir environmental conditions, sedimentary substrate, and pore-water environment (NETL 2010b). Although this study is in the preliminary stages, results would likely further aid in the understanding of the effects of CO₂ injection on subsurface microbial communities in the general area of the proposed injection well site(s) (DOE 2011b). DOE continues to monitor this study and will apply new information from this study to the FutureGen 2.0 Project, if warranted.

In general, microbial communities and activity can be influenced by changes in pH value, pressure, temperature, salinity, and other factors, which can all be influenced by CO₂ injection into the deep subsurface. A study in Germany analyzed the response of the microbial community to CO₂ storage in a saline aquifer. The study revealed a shift in the microbial community composition following CO₂ injection; however, after 5 months of CO₂ storage, enhanced activity of the microbes indicated that the community was able to adapt to the changed conditions (Morozova et al. 2010).

Until further research has been conducted, the effects of CO₂ storage on microbial communities remain uncertain. It is also unclear how widespread multicellular organisms, such as roundworms, may be in the deep subsurface and how they may be affected by CO₂ storage. Operation of the CO₂ injection wells would likely affect subsurface organisms; however, whether those effects would be considered adverse and the magnitude of impact is currently unknown (DOE 2011b).

Educational Facilities

Because the proposed educational facilities would occupy existing structures or be constructed within previously developed areas, the operation of this proposed project component is not expected to cause any adverse impacts to biological resources. Any minor habitat losses related to the educational facilities would be incurred during the construction phase and are not likely to cause long-term effects. Due to the

proposed disturbed nature of the potential location for facilities, no federally- or state-listed species would experience long-term impacts during operation of these facilities.

3.8.4 Impacts of the No Action Alternative

Under the no action alternative, DOE would not provide cost-shared funding for the FutureGen 2.0 Project. Although the Alliance may still elect to construct and operate the project in the absence of DOE cost-shared funding, for the purposes of the analysis in this EIS, DOE assumed the no action alternative is equivalent to the no-build alternative. The project would not be constructed, and there would be no change to biological resources.

INTENTIONALLY LEFT BLANK

3.9 CULTURAL RESOURCES

3.9.1 Introduction

This section describes cultural resources potentially affected by the construction and operation of the FutureGen 2.0 Project as well as the potential direct and indirect effects of the proposed project on these resources.

3.9.1.1 Region of Influence

The ROI for cultural resources is the Meredosia Energy Center, a 4-mile wide corridor for the CO₂ pipeline, and a **6,800**-acre ROI for the CO₂ storage study area. The ROI was used to identify areas containing cultural resources and to help guide the siting process.

The Area of Potential Effect (APE) is a smaller geographic area within which an undertaking may directly or indirectly cause alterations in the character or use of historic properties. Adverse effects to archaeological, paleontological, and cemetery resources are generally the result of direct impacts from ground disturbing activities. The APE for such resources therefore coincides with those areas where direct impacts from the construction and operation of the proposed facility would occur. Adverse effects to historic resources (i.e., standing structures) may occur through direct impacts that could change the character of a property's use or the physical features within a property's setting that contribute to its historic significance, or through indirect impacts that could introduce visual, atmospheric, or audible elements that diminish the integrity of the property's significant historic features. Traditional cultural properties may be subject to both direct and indirect impacts.

The Area of Potential Effect is the geographic area or areas within which an undertaking may directly or indirectly cause alterations in the character or use of historic properties, if such properties exist (36 CFR 800.16[d]).

Project APEs for the different project components would be defined in an iterative process involving DOE, SHPO, and the Advisory Council on Historic Preservation (ACHP) as needed, pursuant to a Programmatic Agreement (see Appendix B, Cultural Resources Consultation [B3]). Because the proposed project involves potential effects to historic properties on a regional scale, which cannot be fully determined prior to approval, a Programmatic Agreement **has been** developed in accordance with 36 CFR 800.14(b). The Programmatic Agreement is discussed further in Section 3.9.1.3.

3.9.1.2 Method of Analysis and Factors Considered

To determine the extent to which archaeological and historic resources are known to exist or may exist within the ROI for this project, DOE reviewed the Illinois Archaeological Survey site files and the Illinois Historic Preservation Agency's Historic Architectural and Archaeology Resources Geographic Information System. In addition, Phase I Cultural Resources Surveys (see Table 3.9-1) were prepared for the CO₂ storage study area (see Appendix F, Cultural Surveys [F1]), the Meredosia Energy Center¹ (see Appendix F, Cultural Surveys [F2]), the Bluff Area segment located within the CO₂ pipeline corridor (see Appendix F, Cultural Surveys [F3]), and the soil gas monitoring locations located within the CO₂ storage study area (see Appendix F, Cultural Surveys [F4]). APEs were defined for these studies and are described further in Section 3.9.2. These studies served as reconnaissance level research to gain a better understanding of cultural resources in the ROI and to guide the siting process. Table 3.9-1 presents all studies conducted thus far and their SHPO concurrence status. Further studies would be necessary once the exact locations of the various project components are decided. The Programmatic Agreement, **which has been finalized since publication of the Draft EIS, outlines** additional steps to be taken by the appropriate parties to identify, evaluate, and treat historic properties in the context of the proposed project.

¹ The Phase I Cultural Resources Survey at the Meredosia Energy Center surveyed the area planned for impact, which amounted to 147 acres of the 263-acre energy center property.

Table 3.9-1. Cultural Resources Surveys Completed within the Region of Influence

Study Name	Project Component	Submitted to SHPO	Date of SHPO Concurrence
Phase I Cultural Resource Survey - 147-acre FutureGen 2.0 Power Plant Site Near the Village of Meredosia	Meredosia Energy Center	April 2012	May 2013
Phase I Cultural Resource Survey - FutureGen Industrial Alliance, Inc. Bluff Area Pipeline Right-of-Way Segment	CO ₂ Pipeline	January 2012	May 2013
Phase I Cultural Resource Survey - FutureGen Industrial Alliance, Inc. Soil Gas Monitoring Locations	CO ₂ Storage Study Area	November 2011	November 29, 2011
Phase I Cultural Resource Survey - FutureGen Industrial Alliance, Inc. Site Characterization Locale	CO ₂ Storage Study Area	April 2011	June 21, 2011

CO₂ = carbon dioxide; SHPO = State Historic Preservation Office; TBD = to be determined

The FutureGen 2.0 Project would not affect any lands designated as Native American tribal reservations or otherwise known to be tribal lands. However, to determine whether any federally-recognized tribes have a cultural or historic affiliation with the proposed project site, DOE contacted several tribal organizations after reviewing the National Park Service’s Native American Consultation Database of tribes to be contacted in conformance with the Native American Graves Protection and Repatriation Act. In addition, the SHPO and the IDOT provided input into which tribes to contract. DOE contacted the following tribal organizations:

- Citizen Potawatomi Nation
- Delaware Nation, Oklahoma
- Eastern Shawnee Tribe of Oklahoma
- Forest County Potawatomi Community
- Hannahville Indian Community
- Ho-Chunk Nation of Wisconsin
- Iowa Tribe of Kansas & Nebraska
- Iowa Tribe of Oklahoma
- Kaw Nation
- Kickapoo Traditional Tribe of Texas
- Kickapoo Tribe of Indians of the Kickapoo Reservation in Kansas
- Kickapoo Tribe of Oklahoma
- Match-e-be-nash-she-wish Band of Pottawatomi Indians of Michigan
- Miami Tribe of Oklahoma
- Nottawaseppi Huron Band of the Potawatomi, Michigan
- Osage Nation
- Peoria Tribe of Indians of Oklahoma
- Pokagon Band of Potawatomi Indians

- Prairie Band of the Potawatomi Nation
- Sac and Fox Nation of Missouri in Kansas and Nebraska
- Sac and Fox Nation of Oklahoma
- Sac and Fox Tribe of the Mississippi in Iowa
- Shawnee Tribe
- Shawnee Tribe of Indians of Oklahoma

Copies of the letters sent by DOE, which conveyed information about the proposed FutureGen 2.0 Project and invited the tribes to request additional information, are included in Appendix B, Consultation Letters. Two tribal organizations, the Kickapoo Traditional Tribe of Texas and the Miami Tribe of Oklahoma, responded to the letters and did not have any comments or concerns regarding the project.

DOE assessed the potential for impacts based on whether the proposed FutureGen 2.0 Project would cause the loss, isolation, or alteration of:

- Archaeological resources listed or eligible for NRHP listing;
- Historic sites or structures listed or eligible for NRHP listing, either directly or by introducing visual, audible, or atmospheric elements that would adversely affect the historic resource;
- Native American resources, including graves, remains, and funerary objects, either directly or by introducing visual, audible, or atmospheric elements that would adversely affect the resource's use;
- Paleontological resources listed or eligible for listing as a National Natural Landmark; or
- Cemeteries.

3.9.1.3 Regulatory Framework

Section 106 of the National Historic Preservation Act (NHPA) and its implementing regulations at 36 CFR 800 (incorporating amendments effective August 5, 2004) require federal agencies to take into account the effects of their undertakings on historic properties, and to afford the ACHP a reasonable opportunity to comment on such undertakings.

The National Historic Preservation Act of 1966 (16 USC 470), as amended, establishes a program for the preservation of historic properties throughout the nation.

Under NHPA Section 106, a historic property is any prehistoric or historic district, site, building, structure, or object included in, or eligible for inclusion in, the NRHP maintained by the Secretary of the Interior. Historic properties can include artifacts, records, and remains related to and located within such properties. Properties of traditional religious and cultural importance to a Native American tribe or Native Hawaiian organization that meet NRHP criteria (36 CFR 800.16[1][1]) are also historic properties.

For purposes of this EIS, cultural resources are the following:

- Archaeological resources, including prehistoric and historic archaeological sites;
- Historic resources, including extant standing structures;
- Cultural or historic landscapes or viewsheds;
- Native American resources, including Traditional Cultural Properties important to Native American tribes; and
- Other cultural resources, including extant cemeteries and paleontological resources.

36 CFR 800 outlines procedures to comply with NHPA Section 106. Under 36 CFR 800(a), federal agencies are encouraged to coordinate NHPA Section 106 compliance with any steps taken to meet the requirements of NEPA, and to coordinate their public participation, review, and analysis in such a way that they can meet the purposes and requirements of both the NEPA and the NHPA in a timely and efficient manner. The Section 106 process has been initiated for the FutureGen 2.0 Project with the intent of coordinating that process with DOE's obligations under NEPA regarding cultural resources.

Participants in the Section 106 process include an agency official with jurisdiction over the undertaking, the ACHP, consulting parties, and the public. Consulting parties include the SHPO; Indian tribes; representatives of local government; applicants for federal assistance, permits, licenses, and other approvals; and additional consulting parties that include individuals and organizations with a demonstrated interest in an undertaking due to the nature of their legal or economic relation to the undertaking or affected properties, or their concern with the effects of the undertakings on historic properties. In Illinois, the Director of Historic Preservation within the Illinois Historic Preservation Agency serves as the SHPO.

The NHPA Section 106 process is conducted in parallel with the Illinois Section 707 process. The Section 707 process is embodied in the Illinois State Agency Historic Resources Preservation Act (20 Illinois Compiled Statutes (ILCS) 3420) governing projects under the direct or indirect jurisdiction of a state agency, or licensed or assisted by a state agency. The Illinois Archaeological and Paleontological Resources Protection Act (20 ILCS 3435) applies to all public lands in Illinois and contains criminal sanctions for those who disturb burial mounds, human remains, shipwrecks, and other archaeological resources or fossils on public lands. Human burials are afforded additional protection under the Illinois Human Skeletal Remains Protection Act (20 ILCS 3440), which forbids disturbance of human skeletal remains and grave markers in unregistered cemeteries, including isolated graves and burial mounds, that are at least 100 years old. Younger graves and registered cemeteries are protected under the Illinois Cemetery Protection Act (765 ILCS 835).

Under the Illinois Historic Preservation Act (20 ILCS 3410), a Comprehensive Statewide Historic Preservation Plan was prepared in 1995, and updated in **2012**, that broadly outlines a framework for historic preservation in the state.

As described in Section 3.9.1.1, because the proposed project involves potential effects to historic properties on a regional scale, which cannot be fully determined prior to approval, the Illinois SHPO suggested that DOE work with the Alliance to draft a Programmatic Agreement in accordance with 36 CFR 800.14(b). This agreement would cover the scope of the entire DOE action for the FutureGen 2.0 Project and implementation of NHPA Section 106 throughout the course of the proposed project. The SHPO suggested the following signatories for this Programmatic Agreement: ACHP, SHPO, DOE, and the Alliance. The SHPO asked DOE and the Alliance to take the lead on drafting the Programmatic Agreement for SHPO review. On January 26, 2012, DOE sent a letter to the SHPO notifying them that they would be contacting them regarding entering into a Programmatic Agreement. A draft Programmatic Agreement was submitted to the SHPO on August 28, 2012 (see Appendix B, Cultural Resources Consultation [B3]). The Programmatic Agreement outlines steps to be taken by the appropriate parties to identify, evaluate, and treat historic properties in the context of the proposed project. The goal of the Programmatic Agreement is to implement a consistent approach to the identification, evaluation, and treatment of historic properties throughout the project's various elements (Battelle 2011b).

In support of Section 106 Consultation activities, DOE met with the SHPO on March 31, 2011, June 24, 2011, December 6, 2011, **May 9, 2013, and June 20, 2013** to discuss the project and specific project areas of concern. **A letter was received from the SHPO on May 30, 2013 stating that they concurred with the findings of the Draft EIS and that a Programmatic Agreement would be implemented to mitigate any adverse impacts to cultural resources. On June 12, 2013, a letter was sent to the ACHP formally inviting them to participate in the Section 106 process for the project. To date, no response**

has been received. On August 5, 2013, the DOE and IHPA formalized the Programmatic Agreement and the Alliance signed as a concurring party. The signed Programmatic Agreement is included in Appendix B, Cultural Resources Consultation [B3]. Communication and consultation with the SHPO is ongoing.

3.9.2 Affected Environment

3.9.2.1 Regional Cultural Context

Humans have inhabited the state of Illinois for at least 12,000 years (Battelle 2011b). Paleo-Indians appeared after the retreat of the last glacier. The archaeological record indicates prehistoric occupation of the state as follows: Paleo-Indian (10,000 B.C. to 8000 B.C.), Archaic (8000 B.C. to 800 B.C.), Woodland (800 B.C. to 1100 A.D.), and Mississippian (900 A.D. to 1500 A.D.). Illinois' prehistoric sites document the interaction of small foraging band societies and the evolution of tribal and chiefdom societies. Throughout prehistory, west central Illinois, where portions of the FutureGen 2.0 Project are located, was one of the most intensively occupied regions in the midwestern United States.

The eastern floodplain of the Illinois River in Scott, Cass, and Morgan counties near Meredosia possesses a particularly rich archaeological record (Battelle 2011b). The Meredosia Lake drainage includes more than 100 prehistoric and historic sites. Archaeological material found at the sites contains records of how specific cultural groups—from the Archaic Period through the Mississippian Period—used this specific area and how settlement and subsistence strategies changed over time.

Beginning in the 1600s, when American Indians first came into contact with Europeans, the Illinois (or Illiniwek) Nation, a group of 12 tribes, occupied most of what today forms the state of Illinois (Battelle 2011b). In the 1700s and 1800s, the Illinois Nation's territory shrank and other tribes moved into the state. Five main tribes survived into the 1700s. Only two, the Kakaskia and Peoria, existed in the early 1800s, and by the mid-1800s they had ceded their lands to the U.S. Government. No federally-recognized tribe occupies the state of Illinois today.

In 1673, French explorers, Father Jacques Marquette and Louis Jolliet, became the first Europeans to explore Illinois (Battelle 2011b). Rene-Robert Cavalier, Sieur de La Salle arrived in 1679, and claimed the entire Mississippi River Basin for France. This led to the French establishing colonial missions and outposts in the state. In 1717, Illinois became part of the French colony of Louisiana and in 1783, became United States territory through the Treaty of Paris. The first European settlers came to the Morgan County area in approximately 1823.

3.9.2.2 History of the Meredosia Energy Center and the Central Illinois Public Service Company

The Meredosia Energy Center was constructed in the 1940s and was operated by the Central Illinois Public Service Company (CIPSCO). As a private business enterprise, CIPSCO began in 1902, as the Mattoon City Railway Company, which was organized to provide streetcar service in Mattoon, Illinois. Between 1903 and 1904, Mattoon City Railway quickly diversified its services and assets to include an electric generating plant and distribution system supplying both Mattoon and the surrounding region.

By 1914, CIPSCO was operating 8 generating stations and serving 232 communities, including over 100,000 electric customers (see Appendix F, Cultural Surveys [F2]). In addition to its electric, gas, and heat utility businesses, the company's service included supplying water, selling ice wholesale to some communities, and operating retail ice businesses in select cities. Business expanded rapidly in the 1920s, and in spite of the impending national Great Depression, CIPSCO continued acquiring minor electric and ice properties and extended both electric and gas service to previously un-served communities and rural areas during the late 1920s. By 1931, however, the impact of the economic decline brought on by the Depression resulted in significant reductions in profit, and CIPSCO reduced most classes of service to its customers (see Appendix F, Cultural Surveys [F2]).

In 1941, preliminary construction began on a steam electric generating plant on the Illinois River south of the village of Meredosia in Morgan County, Illinois (see Appendix F, Cultural Surveys [F2]). However, due to the United States entering into World War II, construction was brought to a quick halt in 1942 by a directive of the War Production Board. As a matter of national safety, the War Production Board effectively suspended all construction at facilities not vital to the war effort, including the Meredosia Energy Center. Construction materials originally intended for the energy center were redirected to support America's military needs. Specifically, the turbo-generator and related equipment initially destined for the energy center were shipped by the War Production Board to assist the United States' World War II ally, Russia.

Construction resumed at Meredosia Energy Center following the war, and the station's first generating unit was completed in 1946, and went into service in 1948 (see Appendix F, Cultural Surveys [F2]). CIPSCO continued operating and expanding the energy center through the 1960s, 1970s, and 1980s. In 1995, shareholders of CIPSCO and the Union Electric Company approved the merger of the two companies, which were combined as Ameren Corporation. Ameren continued power generation at Meredosia Energy Center until operations were suspended at the end of 2011.

3.9.2.3 Meredosia Energy Center

As described in Section 3.9.1.2, various studies were completed as reconnaissance level research to identify cultural resources within the ROI. The *Phase I Cultural Resource Survey - 147-acre FutureGen 2.0 Power Plant Site Near the Village of Meredosia* (see Appendix F, Cultural Surveys [F2]) was conducted to identify cultural resources on the Meredosia Energy Center site. The APE was defined as 100 acres of previously disturbed and developed areas, 18 acres of woods, 24 acres of agricultural areas, and 5 acres of grassy or fallow areas on the Meredosia Energy Center site. This study included an examination of historical maps and atlases pertinent to the subject property, a computer database search of the archaeological site files maintained by the Illinois State Museum, a review of the NRHP, and a review of the Illinois Register of Historic Sites maintained by the Illinois Historic Preservation Agency (see Appendix F, Cultural Surveys [F2]). In addition to archival records and database examination, the subject property was examined by archaeologists utilizing shovel-probe reconnaissance at approximately 50-foot (15-meter) intervals within wooded areas and pedestrian reconnaissance at approximately 16-foot (5-meter) intervals within agricultural fields and grassy or fallow areas.

The records review revealed that a portion of the project area was previously surveyed by the Center for American Archaeology in 1991 (see Appendix F, Cultural Surveys [F2]). The records review also indicated that an unknown survey was conducted in the southern portion of the project area. One site, 11Mg473, was reported within the northeast portion of the project area. Archeological site 11Mg473 represents the subsurface remains of the extant Meredosia Train Depot. The site was reported in 2010. The site database indicates that 60 artifacts were recovered from the site and date from 1850 through the 1870s. Currently, the site is situated in a public park and includes the remains of a circa 1850s cut-stone bridge pier, a small track segment, a late 19th to early 20th century caboose, and the late 19th century depot. The depot is located adjacent to the Northern Cross Railroad line, one of the first rail lines constructed in the state of Illinois during the late 1830s.

A second site, 11Mg22, was reported by A. Berkson in 1976. Dating to the Early Woodland (circa 1000 B.C.) based on temporally-diagnostic artifacts, the site was described as a light density artifact scatter exposed along the cutbank of the Illinois River and adjacent to the developed portion of the Meredosia Energy Center. Collected from the eroded shoreline, a total of four artifacts, including a chert blade, a small dart point fragment, and two small and eroded pottery shards were recovered. The vertical extent of the archaeological site is unknown; however, the archaeologist who identified the site suspected that up to 90 percent of the site may have been compromised by construction and use of the energy center.

The shovel-probe reconnaissance revealed that the entire campus has experienced dramatic ground disturbance due to construction and continued operation and expansion over the last 60 years.

Investigations failed to identify the presence of archaeological resources. In addition, examination of the standing structures occupying the facility did not document any existing structures greater than 50 years in age that are of architectural or historical merit.

3.9.2.4 CO₂ Pipeline

Seven cultural resource surveys have been conducted within close proximity to the southern and northern pipeline routes. These studies were evaluated to better determine the presence of cultural resources within the ROI. A larger portion of the southern route has been examined previously due to its path traversing the proposed expansion of US-67. This highway corridor was surveyed by the Center for American Archaeology in 1996.

Survey #3411 was a 40-mile electrical transmission line survey conducted in 1990 by the Center for American Archaeology (Prairie Archaeology & Research 2012a). The survey corridor ran south out of Meredosia along Old Grace Road. No cultural, archaeological, or historical resources were identified within the pipeline ROW during this survey.

Survey #10129 extended east at the intersection of Old Grace Road and Yeck Road and continued northward away from the pipeline corridor (Prairie Archaeology & Research 2012a). It ran parallel and within close proximity to the proposed pipeline routes but did not actually intersect the routes at any point. This survey was conducted in 2000 by American Resources Group for the construction of Yeck Road. No cultural, archaeological, or historical resources were identified within the pipeline ROW by this survey.

Survey #972 is a flood control study survey conducted in 1985 by the Center for American Archaeology (Prairie Archaeology & Research 2012a). The survey area consisted of numerous noncontiguous land tracts throughout the Illinois River valley floodplain in Scott, Cass, and Morgan counties. The southern and northern routes intersect a portion of this survey just southeast of Meredosia along the eastbound section of Yeck Road as it curves northbound. In total, this survey identified 57 prehistoric and 52 historic sites. None of the identified sites were within the surveyed portion intersecting the proposed pipeline corridor.

Survey #9344 is the US-67 survey conducted in 1996 by the Center for American Archaeology (Prairie Archaeology & Research 2012a). As mentioned earlier, the southern route follows this survey from its entrance near the bluffs to its departure approximately 3.5 miles to the southeast. The northern route intersects a very small portion of this survey as it crosses US-67 near the bluffs. As the southern and northern routes meet up to the east, the routes would again intersect the portion of this survey located south of Concord and west of Joy Lane. The over 10,000-acre survey identified 174 prehistoric and 163 historic sites. Over 100 sites were recommended for Phase II investigations. IDOT is in the process of completing the Phase II investigations for these sites. Site 11Mg281, an early historic site dating to the late 1800s, was identified during this survey. Remains of structures, a well, and a cistern were noted at this location as well as piles of brick. The site is within the proximity of a 19th century school appearing on historical atlases. The school was reported to have burned down in 1905.

Further evaluation of the bluff area was determined necessary through discussions with the SHPO and the *Phase I Cultural Resources Survey - FutureGen Industrial Alliance, Inc. Bluff Area Pipeline Right-of-Way Segment* was conducted in January 2012 (see Appendix F, Cultural Surveys [F3]). The APE was composed of a 75-foot wide corridor approximately 3,250 linear feet (990 linear meters) in length in wooded, grassy, and fallow areas, just south of the intersection of IL-100 and IL-104. Due to the APE's location along the bluff and uplands of Morgan County, deep burial of cultural deposits or remains were deemed unlikely.

Survey #17765 represents a corridor survey intersected by the northern route (Prairie Archaeology & Research 2012a). This survey was conducted by the Illinois Transportation Archaeological Research Program in 1999 for IL-78. The northern route would intersect perpendicularly to the survey corridor and

thus encounter only a very small portion. No cultural, archaeological, or historical resources were identified within the pipeline ROW by this survey.

Survey #18092 is a corridor survey covering various roadways in rural Morgan County (Prairie Archaeology & Research 2012a). Both routes would cross perpendicularly to this survey. No cultural, archaeological, or historical resources were identified within the pipeline ROW by this survey.

3.9.2.5 CO₂ Storage Study Area

Two Phase I Cultural Resources Surveys have been conducted within the CO₂ storage study area to identify cultural resources within the ROI, the *Phase I Cultural Resources Survey- FutureGen Industrial Alliance, Inc. Site Characterization Locale* (see Appendix F, Cultural Surveys [F1]) and the *Phase I Cultural Resources Survey - FutureGen Industrial Alliance, Inc. Soil Gas Monitoring Locations* (see Appendix F, Cultural Surveys [F4]).

The Alliance conducted a detailed geological stratigraphic analysis to characterize and verify the viability of the proposed CO₂ storage study area. In support of this analysis, the *Phase I Cultural Resources Survey - FutureGen Industrial Alliance, Inc. Site Characterization Locale* was completed for the CO₂ storage study area in April 2011 (see Appendix F, Cultural Surveys [F1]). The APE consisted of approximately 15.3 acres of agricultural fields within the CO₂ storage study area.

This inventory was completed to identify cultural resources within the ROI and included an examination of historical maps and atlases pertinent to the subject property, a computer database search of the archaeological site files maintained by the Illinois State Museum, reviews of the NRHP and Illinois Register of Historic Sites, and field investigations utilizing a pedestrian reconnaissance at approximately 16-foot (5-meter) intervals (see Appendix F, Cultural Surveys [F1]). Based on the results of field investigations and information collected during archival and background research, the area that was surveyed for the stratigraphic well contained no significant historic, architectural, and archaeological resources.

The *Phase I Cultural Resources Survey - FutureGen Industrial Alliance, Inc. Soil Gas Monitoring Locations* (see Appendix F, Cultural Surveys [F4]) was completed within the CO₂ storage study area in November 2011. The APE for this study included 5 acres of agricultural fields and 1 acre of fallow fields within the CO₂ storage study area. The same resources were evaluated as for the Site Characterization Locale. Based on the results of field investigations and information collected during archival and background research, the area that was surveyed for the stratigraphic well contained no significant historic, architectural, and archaeological resources.

3.9.2.6 Educational Facilities

The location of the educational facilities in Jacksonville, Illinois has not yet been determined. Once the locations are selected, and prior to construction, steps described in the Programmatic Agreement would be undertaken to characterize the presence of cultural resources in areas that have not been disturbed or surveyed previously, as well as to assess and resolve adverse effects to historic properties, if necessary.

3.9.3 Impacts of Proposed Action

3.9.3.1 Construction Impacts

Meredosia Energy Center

As described in Section 3.9.2.3, the entire Meredosia Energy Center has experienced extensive ground disturbance during construction, continued operations, and expansion over the last 60 years. No cultural resources were identified directly on the site; however, as described in Section 3.9.2.3, the *Phase I Cultural Resource Survey - 147-acre FutureGen 2.0 Power Plant Site Near the Village of Meredosia* identified two archeological sites in close proximity to the Meredosia Energy Center, 11Mg473 (the Meredosia Train Depot) and 11Mg22 (a light density lithic scatter) (see Table 3.9-2).

As currently conceptualized, the proposed project would not result in an adverse impact to cultural deposits that may be present at archaeological site 11Mg473 (the Meredosia Train Depot), nor would this archeological site likely contain sufficient integrity with potential to yield significant scientific or historical information to be considered eligible for inclusion on the NRHP. Currently, the existing energy center is adjacent to the physical boundaries of site 11Mg473 and is visible from the resource. As such, the proposed project would not result in an adverse visual intrusion to the setting or viewshed of any extant structures (such as the depot, caboose, rail track segment, or bridge pier) that may contain sufficient historical, architectural, or engineering value which would render such structure as eligible for inclusion on the NRHP.

With regard to site 11Mg22 (a light density lithic scatter), construction, use, and repeated land modifications associated with the energy center has not only compromised the integrity of the site but also removed any evidence that archaeological site 11Mg22 extended into the project's APE. Archaeological investigations in the vicinity of site 11Mg22 failed to produce evidence of intact cultural deposits, failed to generate artifacts, and failed to provide scientific information regarding prehistoric use by past inhabitants at the site. The current investigation has demonstrated that prehistoric archaeological site 11Mg22 lacks a degree of significance and a level of integrity that would render the site eligible for nomination or listing on the NRHP. Investigations have demonstrated that the proposed activities would not result in an adverse impact to a significant resource and that archaeological site 11Mg22 is ineligible for nomination to the NRHP.

In addition, the shovel-probe reconnaissance for the Phase I Cultural Resources Survey (completed on a 147-acre portion of the Meredosia Energy Center) failed to identify the presence of archaeological resources. Examination of the standing structures occupying the facility did not document any existing structures greater than 50 years in age that are of architectural or historical merit.

Based on the findings included in the *Phase I Cultural Resource Survey - 147-acre FutureGen 2.0 Power Plant Site Near the Village of Meredosia*, additional cultural resource investigations are neither warranted nor recommended. No impact to historic resources is anticipated as a result of construction for the oxy-combustion facility. To date, the SHPO has not concurred with these findings. Prior to construction, the SHPO must concur with these findings. In addition, steps described in the Programmatic Agreement would be undertaken to characterize, assess, and resolve any adverse effects to cultural resources that have not been disturbed or surveyed previously.

CO₂ Pipeline

As described in Section 3.9.2.4, seven cultural resource surveys have been conducted in areas along the southern and northern pipeline routes. Review of the surveys conducted in the area identified one historic site, 11Mg281, in close proximity to a portion of the southern route (see Table 3.9-2). This site is currently being mitigated by IDOT for a roadway-widening project. Therefore, it is not anticipated that the southern route would have an adverse effect on this resource.

The cultural resources survey for the *Phase I Cultural Resources Survey - FutureGen Industrial Alliance, Inc. Bluff Area Pipeline Right-of-Way Segment* did not identify any cultural resources within the APE for the study. Due to the APE's location along the bluff and uplands of Morgan County, deep burial of cultural deposits or remains were deemed unlikely. To date, SHPO concurrence has not been received.

Many areas along the southern and northern pipeline routes have not been surveyed. Therefore, the potential for the discovery or disturbance of an unknown cultural resource during construction on either the southern or northern route exists, particularly in areas where there has been no prior land disturbance. **Although the Alliance selected the southern route as the proposed route since publication of the Draft EIS, the pipeline route could deviate slightly within the identified corridor as a result of final project design and coordination with landowners; however, the steps outlined in the Programmatic Agreement (see Appendix B, Cultural Resources Consultation [B3]) would be implemented and the same siting criteria would be followed.** Additionally, prior to construction, steps described in the

Programmatic Agreement would be undertaken to characterize the presence of cultural resources in areas that have not been disturbed or surveyed previously and assess and resolve any adverse effects to cultural resources, if necessary. In addition, procedures are in place should cultural resources be discovered inadvertently during construction (inadvertent discovery procedures). Where possible, the CO₂ pipeline would follow existing road and utility ROWs to reduce impacts to cultural resources. **Impacts would be consistent with those addressed in this section.**

Table 3.9-2. Cultural Resources Identified within the Region of Influence

Site Number	Project Component	Resource Type	Description	Impacted as a Result of the Project (Yes or No)
11Mg473	Meredosia Energy Center	Archeological Site	Subsurface remains of the extant Meredosia Train Depot	No
11Mg22	Meredosia Energy Center	Archeological Site	Light density artifact scatter	No
11Mg281	CO ₂ Pipeline	Historic Site	Remains of structures, a well, and a cistern, as well as piles of brick	No

CO₂ = carbon dioxide

CO₂ Storage Study Area

As described in Section 2.5.2.1, since the publication of the Draft EIS, the Alliance identified a proposed property for the injection well site based on the geotechnical evaluations of the subsurface and negotiations with the landowners. This property contains an abandoned house within the APE. The landowners are willing to let the Alliance demolish the house to provide sufficient space for the injection wells while minimizing the reduction in farmable land. The Alliance believes that the standing structure is greater than 50 years in age. This one-story structure was used as a rural residence and, based on an assessment of available archival information, was constructed between 1959 and 1963. This structure is not unique in the region and rural residences of similar age are ubiquitous throughout the Morgan County rural countryside. In addition to the recent age of the building and the absence of unique architectural or historical significance, the building appears to lack the necessary degree of architectural integrity to be considered as potentially eligible for listing on the NRHP due to factors such as the significant alterations of the original fabric of the residential structure including modernization of windows, exterior siding, and roofing materials, and the recent additions at the side and rear elevations of the original structure. Further, the structure appears to contain little historical relevance or any semblance of architectural merit that would render the building potentially significant under criteria A, B, or C of the NRHP's criteria for historical, architectural, or engineering significance.

As described in Section 3.9.2.5, the area surveyed for the stratigraphic well does not contain evidence for the presence of archaeological, historical, or cultural resources, sites, areas, or artifacts. The SHPO concurred with the findings of the *Phase I Cultural Resources Survey - FutureGen Industrial Alliance, Inc. Site Characterization Locale* in a letter dated June 1, 2011 (IHPA 2011a). Therefore, should the CO₂ injection wells and monitoring wells be located in this previously surveyed area, no impacts to cultural resources would be anticipated.

The area surveyed for the soil gas monitoring locations also does not contain evidence for the presence of archaeological, historical, or cultural resources, sites, areas, or artifacts. The SHPO concurred with the findings of the *Phase I Cultural Resources Survey - FutureGen Industrial Alliance, Inc. Soil Gas Monitoring Locations* in a letter dated November 29, 2011 (IHPA 2011b). Therefore, should the CO₂ injection wells and monitoring wells be located in this previously surveyed area, no impacts to cultural resources would be anticipated.

The potential for the discovery or disturbance of an unknown cultural resource during construction exists in areas where there has been no prior land disturbance. Prior to construction, steps described in the Programmatic Agreement would be undertaken to characterize the presence of cultural resources in areas that have not been disturbed or surveyed previously as well as to assess and resolve adverse effects to historic properties.

Educational Facilities

As described in Sections 2.5.3 and 3.0, since the release of the Draft EIS, discussions between the Alliance and Jacksonville civic authorities have focused on a potential site in Jacksonville for the educational facilities, but the sites currently remain unknown. The potential for the discovery or disturbance of an unknown cultural resource during construction exists, particularly in areas where there has been no prior land disturbance. Prior to construction, steps described in the Programmatic Agreement would be undertaken to characterize the presence of cultural resources in areas that have not been disturbed or surveyed previously as well as to assess and resolve adverse effects to historic properties.

3.9.3.2 Operational Impacts

Once the FutureGen 2.0 Project is operating, there would be no additional subsurface disturbance, other than for occasional pipeline repairs, which would limit the potential to disturb or harm buried cultural resources. The oxy-combustion facility would be located on the existing Meredosia Energy Center property and would not introduce new operational noise or stack emissions that would represent substantial changes to the activities historically conducted at the site. Therefore, impacts to cultural resources during the project's operational phase would be negligible to minor. The Alliance would implement BMPs, including inadvertent discovery procedures.

3.9.4 Impacts of the No Action Alternative

Under the no action alternative, DOE would not provide cost-shared funding for the FutureGen 2.0 Project. Although the Alliance may still elect to construct and operate the project in the absence of DOE cost-shared funding, for the purposes of the analysis in this EIS, DOE assumed that the no action alternative is equivalent to a no-build alternative. Therefore, the project would not be constructed and there would be no impact to cultural resources as a result of the no action alternative.

INTENTIONALLY LEFT BLANK

3.10 LAND USE

3.10.1 Introduction

This section describes existing land use within the proposed project's ROI. Additionally, this section analyzes the potential direct and indirect effects of the construction and operation of the proposed project on the existing land uses and addresses the compatibility of the proposed project with current and future land uses in the ROI.

3.10.1.1 Region of Influence

The ROI for land use includes the areas proposed for the construction and operation of the proposed project (direct effects) and their adjacent properties (indirect effects), including the Meredosia Energy Center, the CO₂ pipeline, the CO₂ injection wells, and the educational facilities.

3.10.1.2 Method of Analysis and Factors Considered

In order to describe the affected environment for land use and analyze potential impacts, DOE considered current and future plans for land use based on available county and city zoning ordinances, GIS data, comprehensive plans, and interviews with county and city officials (e.g., the Morgan County Regional Planning Commission, city of Jacksonville). DOE obtained further details about site-specific land use characteristics from USDA/NRCS land cover data and information gathered during site visits. DOE used such information to supplement existing land use data for Morgan County.

For the purposes of this analysis, DOE used the following land use groupings:

- Agricultural Land – Includes farmland, cropland, pasture/hay, and land used for cultivated crop and livestock production.
- Developed Land – Includes urban areas (cities or towns) as well as rural developments including farm-related residential properties, rural commercial and industrial facilities, cultural and recreational facilities, barren land, and other structures and developed uses.
- Vegetated Land – Includes forests (deciduous, evergreen, and mixed forest), scrub-shrub, and grasslands.
- Water Features – Includes open water such as permanent surface waterbodies including lakes, rivers, reservoirs, ditches, and permanent and intermittently exposed open water areas. Wetlands include bogs, marshes, and fens characterized by a high water table, standing or slow-moving water, and hydrophytic vegetation.

DOE assessed the potential impacts on land use based on whether the proposed project would:

- Be compatible with land use adjacent to the Meredosia Energy Center and within and adjacent to the CO₂ pipeline corridor, CO₂ storage study area, and associated components and facilities;
- Result in land use restrictions on adjacent properties; or
- Conflict with regional or local land use plans and zoning.

3.10.1.3 Regulatory Framework

Based on information obtained from the Morgan County Regional Planning Commission, the unincorporated county does not have zoning information or current land use plans (Douglas 2011). The city of Jacksonville has a comprehensive plan, but it is not applicable to areas of Morgan County outside of Jacksonville city limits. The Illinois Pollution Control Board's 35 IAC 901 Appendix B, *Land-Based Classification Standards and Corresponding Land Classes* includes classifications of land according to use, which are applied to noise emissions regulations (IPCB 2007). The Code categorizes land use into

Land Classes A, B, and C depending on type (i.e., developed, agricultural, vegetated, etc.). See Section 3.14, Noise and Vibration, for additional details. DOE used GIS data, obtained from the County GIS Coordinator in combination with the county online parcel website, to evaluate land use types and land ownership information to infer the current land uses in the ROI.

The Federal Farmland Protection Policy Act (7 USC 4201 *et seq.*) established guidelines to minimize the extent to which federal programs contribute to the unnecessary conversion of farmland to nonagricultural uses. The Act assures that federal programs are administered in a manner that, to the extent practicable, would be compatible with state, local, and private efforts to protect farmland. Additionally, the IDOA reviews federal agency programs, projects, and activities for compliance with the Farmland Preservation Act (8 IAC 700) and the Federal Farmland Protection Policy Act. See Section 3.3, Physiography and Soils, for additional details about the Farmland Protection Policy Act and the IDOA requirements.

3.10.2 Affected Environment

The FutureGen 2.0 Project would be located in west central Illinois in Morgan County. Regional land use is largely agricultural and rural with small areas of developed land. The existing Meredosia Energy Center is located south of the village of Meredosia, which has a population of approximately 1,044 (USCB 2010b). The most heavily developed land in Morgan County is within the city of Jacksonville, approximately 17 miles southeast of the energy center. Jacksonville encompasses approximately 10 square miles of low, medium, and high-density developed land and has a population of 19,446 (USCB 2010c). The land outside of the city of Jacksonville in Morgan County is predominantly agricultural. Morgan County encompasses approximately 366,617 acres, of which 279,840 acres or 76 percent are agricultural. The balance of land in Morgan County is mainly vegetated.

Table 3.10-1 provides a detailed breakdown of the existing land use acreages in Morgan County and the state of Illinois, based on the land use groupings identified in Section 3.10.1.2. Acreage data is based on USDA/NRCS land cover data.

Table 3.10-1. Land Use Acreage by Type

Affected Area	Agricultural (acres) ^a	Developed (acres) ^a	Vegetated (acres) ^a	Water Features (acres) ^a	Total Land (acres) ^b
Morgan County	279,840 (76%)	29,021 (8%)	51,102 (14%)	6,654 (2%)	366,617
Illinois	25,019,220 (67%)	4,178,294 (11%)	5,819,236 (16%)	2,217,849 (6%)	37,234,599

Source: USDA/NRCS 2001

^a Percentage values are approximations due to rounding.

^b Total percentage is 100 percent.

% = percent

Land use in Morgan County is generally consistent with state-wide land use, which is dominated by agricultural land. Comparatively, Morgan County has a greater percentage of agricultural land and subsequently a lesser percentage of the other land use types than the remainder of the state.

3.10.2.1 Meredosia Energy Center

The Meredosia Energy Center property is a heavily developed industrial site, typical of a coal-fired power plant. This property includes generating units, cooling towers, a coal barge unloading area, storage areas for coal and coal combustion by-products, chimneys (stacks), substations, and multiple warehouse buildings (see Chapter 2 for further details). Additionally, there are fields and open space areas (e.g., trees and grassy areas) within the property.

Table 3.10-2, as updated to show changes for the Final EIS, provides a summary of the land use types in the potential disturbance areas at the Meredosia Energy Center based on recent aerial photographs and data provided by the USDA/NRCS (2001).

Table 3.10-2. Land Use Types within Potential Areas of Disturbance at the Meredosia Energy Center

Land Cover Type	Draft EIS (acres) ^a	Final EIS (acres) ^b
Developed	84	51
Vegetated	80	63
Water Features	<1	<1

Source: USDA/NRCS 2001

^a. Represents the most conservative upper bound for impacts, as presented in the Draft EIS and reflected in Figure 2-14.

^b. Represents the Alliance’s current plans for impacts, as reflected in Figure 2-15.

At the end of 2011, operations were suspended at the Meredosia Energy Center. Although all operational activities stopped (e.g., no coal consumption or energy generation), the existing land use remains unchanged.

The Meredosia Energy Center is surrounded by a variety of land uses, including developed land (i.e., residential and manufacturing facilities) and agricultural land. Adjacent to the northern border of the property is a wooded area with an access road (Front Street) leading to a public boat ramp area that includes two boat ramps, which are owned and controlled by the village of Meredosia. An area beyond the boat ramps was used as a small camping area in previous years but is no longer in use (Salinger 2013). The area north of the boat ramps is occupied by the Cargill, Inc. (Cargill) grain elevator facility and the Meredosia Bridge. The bridge (IL-104) provides a connection between Pike County and Morgan County. North of the Meredosia Energy Center is the village of Meredosia, which is **predominantly** surrounded by agricultural land.

Old Naples Road borders the eastern boundary of the Meredosia Energy Center. Properties to the east of Old Naples Road consist of mostly developed residential properties but also include a few parcels of land that involve industrial activities.

The adjoining land to the south of the Meredosia Energy Center is occupied by the Celanese Emulsions (National Starch & Chemical) plant and Norfolk & Western Railway. Additional chemical plant facilities, including TA Terminals Inc. and Agrium Inc., lie to the east of the Celanese Emulsions plant, generally southeast of the Meredosia Energy Center.

The Illinois River borders the western boundary of the Meredosia Energy Center. Pike County is located across the Illinois River to the west of Morgan County. Land use in Pike County is also mostly agricultural, but Pike County has a higher proportion of vegetated land (28 percent) compared to nearby counties, including Morgan County.

3.10.2.2 CO₂ Pipeline

The FutureGen 2.0 Project would include a CO₂ pipeline and CO₂ injection wells centrally located in Illinois and entirely within Morgan County. The Alliance identified two possible pipeline routes from the Meredosia Energy Center to the CO₂ storage study area. The two pipeline route options are located within the 4-mile wide corridor shown in Figure 2-17. Table 3.10-3 provides a detailed breakdown of land use acreage by project component, based on the land use groupings identified in Section 3.10.1.2. Acreage data is based on USDA/NRCS land cover data.

Table 3.10-3. Land Use within the CO₂ Pipeline Corridor and Storage Study Area

Affected Area	Agricultural (acres) ^a	Developed (acres) ^a	Vegetated (acres) ^a	Water Features (acres) ^a
CO ₂ Pipeline Corridor	51,051 (74%)	4,208 (6%)	12,106 (17%)	2,015 (3%)
CO ₂ Storage Study Area ^b	6,201 (91%)	223 (3%)	357 (5%)	4 (0.1%)

Source: USDA/NRCS 2001

^a. Percentage values are approximations due to rounding.

^b. The CO₂ storage study area was originally analyzed in the Draft EIS as a 5,300-acre area. Since the Draft EIS was released, the Alliance expanded the study area to approximately 6,800 acres to account for additional flexibility for CO₂ injection. Refer to section 2.5.2 for additional details about the CO₂ storage study area. This table reflects the acreages and percentages based on the updated 6,800-acre storage study area.

CO₂ = carbon dioxide; % = percent

Agricultural land is the most abundant land use type found within the ROI. Substantially smaller areas of vegetated and developed land are also present.

The CO₂ pipeline route options from the Meredosia Energy Center to the CO₂ injection wells traverse approximately 30 miles west to east within the northern portion of Morgan County. As the land between the Meredosia Energy Center and the storage study area is not owned by the Alliance, legal ROW easements must be obtained from land owners when a route is finalized. The pipeline would be sited in accordance with applicable federal and state regulations, including 49 CFR 195.210; 49 CFR 195.210 states that pipeline ROWs would avoid, to the extent practicable, areas containing private dwellings, industrial buildings, and places of public assembly. Additionally, regulations require CO₂ pipelines to be located no closer than 50 feet from residences. The Alliance proposes to locate the pipeline no closer than 150 feet from residences. It is possible that a distance less than 150 feet would be needed in order to avoid a sensitive environmental resource or at the request of an affected landowner but the distance would not be less than the 50 feet required by federal regulations.

The 4-mile wide pipeline corridor avoids the city limits of Jacksonville and includes predominantly agricultural land (74 percent). Other land use types within the corridor consist of vegetated land (17 percent), water features (3 percent), and small areas of developed land such as farm-related residential properties and residential neighborhoods (6 percent), including areas near the villages of Concord and Meredosia.

3.10.2.3 CO₂ Storage Study Area

The CO₂ injection and monitoring wells and associated surface facilities would be located on up to 25 acres within the CO₂ storage study area in the northeastern portion of Morgan County (see Figure 2-17). As shown in Table 3.10-3, the CO₂ storage study area is predominantly agricultural land. The 6,800-acre storage study area consists of approximately 6,201 acres of agricultural land, 357 acres of vegetated land, and 4 acres of water features. During early project planning, the Alliance selected the CO₂ storage study area to avoid developed areas to the extent practicable. Farm-related properties account for the majority of the 223 acres of developed land within the 6,800-acre CO₂ storage study area.

3.10.2.4 Educational Facilities

The Alliance anticipates that the educational facilities would be located in or near Jacksonville, Illinois. The Alliance is working with local stakeholders to identify the locations that would best serve the functions of these facilities.

The city of Jacksonville is an approximately 10-square mile area that includes a variety of land uses. Land uses in the city of Jacksonville include developed land ranging from open space to high-density

development, open water and wetlands such as the Mauvaise Terre Lake and Lake Jacksonville, and agricultural lands surrounding the city.

Jacksonville has a comprehensive plan and zoning ordinance that delineates boundaries for land use within the city. The zoning ordinance applies to all land within the corporate limits of Jacksonville and contiguous territory within 1.5 miles beyond the corporate limits (City of Jacksonville 2012b). The comprehensive plan includes a future land use plan (City of Jacksonville 2002). Additionally, the Jacksonville Regional Economic Development Corporation provides economic development services that focus on business retention, expansion, and attraction.

3.10.3 Impacts of Proposed Action

3.10.3.1 Construction Impacts

Meredosia Energy Center

Construction of the oxy-combustion facility at the Meredosia Energy Center would have negligible to minor short-term impacts on land use. **Initial design, as presented in the Draft EIS, estimated that approximately 164 acres could be impacted during construction at the energy center (see Table 3.10-2). However, the current design at the energy center could reduce the area of disturbance to approximately 114 acres during construction (see Section 2.4.3 for further discussion on estimated impact areas).** The vast majority of construction of the oxy-combustion facility would occur on the Meredosia Energy Center property, although additional land area outside of the energy center would be needed for construction staging and equipment laydown. Construction of the proposed oxy-combustion facility would not conflict with any designated zoning plans, since there is no local or county-wide zoning ordinance that applies to the energy center. The Meredosia Energy Center is characterized as previously disturbed, industrial land use, with areas of open space (i.e., grass areas). Construction activities at the Meredosia Energy Center would be consistent with the industrial nature of the property and would not result in conversion of land use within the energy center property; therefore, impacts would be negligible. Adjacent properties are mostly occupied by industrial land uses, but a few residential properties are located to the east and north. The nearest residences are located approximately 1,300 feet from the proposed location of the oxy-combustion facility. Construction of the oxy-combustion facility would have a short-term, minor impact on land use compatibility in the immediate area and on neighboring property owners due to temporary increases in traffic and noise levels. Potential impacts to nearby residential and other properties during construction of the oxy-combustion facility are further described in Section 3.11, Aesthetics; Section 3.13, Traffic and Transportation; and Section 3.14, Noise and Vibration.

Construction staging would primarily occur on the Meredosia Energy Center property, but a few parcels of vacant and/or industrial land outside of the energy center would be utilized for additional laydown areas. The parcels outside of the Meredosia Energy Center being considered for use during construction include the following (USDA/NRCS 2001; **Beacon 2013**):

- **Approximately 28 acres of land to the southeast of the energy center based on the original configuration analyzed in the Draft EIS; and approximately 25 acres of land based on the current configuration:** This land is owned by the Norfolk & Western Railway Company and is primarily agricultural cropland with a segment of ROW for a rail line. It would be used as a staging area, which would result in a temporary loss of this area from agricultural use during the duration of construction.
- **Approximately 1.5 acres of land to the east of the energy center:** This land is a gravel parking area owned by Celanese Ltd, which would be used for parking during the construction period.
- **Approximately 3.4 acres of open space to the north of the energy center:** This land is undeveloped city-owned ROW. Construction activities would utilize the ROW for temporary parking and would revert back to its original use upon completion of the construction phase.

The areas for construction staging would primarily experience temporary impacts. Although the land would not be available to the owners during the construction period, once proposed construction is completed, the land would revert back to its original use. Additionally, the properties adjacent to the potential construction staging areas are mostly industrial and, therefore, construction staging would not have a substantial land use impact on these properties and would not conflict with surrounding land uses.

The existing public boat ramp area located northeast of the Meredosia Energy Center would be used as a temporary facility for unloading barges delivering modules of oxy-combustion equipment during construction. The boat ramp area has two boat ramps and is owned by the village of Meredosia. It is not anticipated that both of the boat ramps would be shut down during barge unloading since only one ramp would be needed to offload the materials; however, additional phases of project engineering and coordination with the village of Meredosia would be required to determine further access arrangements. It is anticipated that impacts to the boat ramp area would be short term, lasting between 1 to 3 months during each of several construction unloading timeframes. Properties adjacent to the temporary barge unloading facility include ROW and developed residential properties. Impacts to the adjacent properties due to barge unloading activities would be minor and primarily associated with noise and visual impacts (see Section 3.11, Aesthetics, and Section 3.14, Noise and Vibration). Such activities would be short term and similar to activities at other nearby properties that are industrial in nature (e.g., the Cargill grain elevator to the north of the boat ramp area and the Meredosia Energy Center to the south).

The use of the boat ramp area to support barge unloading operations would result in a temporary shutdown or closure of one of the boat ramps during offloading activities, which could result in temporary impacts to the boat ramp area. Even though it is not anticipated that public access to the river would be blocked by barge unloading activities, there is the potential to cause a temporary increase in residential and boat travel at alternate facilities. Details about the temporary barge unloading facility are provided in Section 2.4.3.2.

Permanent impact areas would be limited to land within the Meredosia Energy Center boundaries and would not change the current industrial land use. In general, impacts to the energy center and adjacent properties during construction would be negligible to minor and temporary, as no major conflicts to land use compatibility are expected to occur.

CO₂ Pipeline

Construction of the pipeline would involve land clearing and trenching within the 80-foot wide construction ROW for approximately 30 miles to the injection wells within the CO₂ storage study area. These activities would have both short-term and potentially long-term impacts on land use. All impacts on land use during construction of the pipeline would be minor. Short-term impacts would result from temporarily restricting access and disrupting the ability to use the land for existing purposes (e.g., agricultural crops); land would be returned to its original condition after construction to the extent practicable. Long-term impacts could result from land cover changes to small areas of vegetated land (i.e., forests) due to land-clearing activities during construction and in situations that require the conversion of vegetated land to permanent 50-foot wide ROWs and access roads. To reduce land use impacts, access to construction ROWs would be provided from existing roads crossing the pipeline route to the extent practicable. Because the pipeline would be installed underground, the aboveground ROWs could be restored to their prior uses after construction with minimal aboveground features (i.e., pipeline markers at crossings and mainline block valve shelters). This would result in negligible to minor impacts on adjacent lands.

To the extent practicable, the pipeline would be located along existing ROWs. In such cases, there would be short-term and negligible impacts, because land use within the original easement would remain the same. For example, approximately 2 miles of the pipeline for the southern route to the injection wells would be located within an existing US-67 ROW, which would not change the land use within the ROW. For portions of the pipeline that would be unable to return to existing conditions (i.e., forested land),

impacts would be long term and permanent. **Impacts would be reduced by using trenchless pipe-boring techniques such as horizontal directional drilling or jack and bore technology to bury the pipeline beneath lands without disturbing the land directly above the pipeline. The Alliance plans to use such technology where sensitive areas have been identified along the pipeline (i.e., wetlands and forested areas), as practicable. See the map views in Appendix C, Map Views of Pipeline, which include the boring locations.**

For the portion of the pipeline traversing through the CO₂ storage study area, impact analysis in the Draft EIS used hypothetical end-of-pipeline routes (spurs) to evaluate a range of reasonable siting scenarios (see Section 3.0). Since the release of the Draft EIS, the Alliance identified a location for the injection wells (see Section 2.5.2.1) and established the pipeline routing within the CO₂ storage study area for the southern route to the proposed injection well site. The pipeline route could ultimately deviate as a result of final project design and coordination with landowners; however, the same siting criteria would be followed and impacts would be consistent with those addressed in this section. Since the Alliance does not plan to move forward with the northern pipeline route, final routing within the storage study area was not identified for the northern route to the injection wells. As a result, DOE addressed the pipeline impacts for the southern route based on the currently proposed pipeline alignment from the energy center to the injection wells and addressed the pipeline impacts for the northern route based on the analysis presented in the Draft EIS using hypothetical end-of-pipeline spurs.

Table 3.10-4 presents the potential land use acreages temporarily and permanently lost as a result of construction of the pipeline route options from the Meredosia Energy Center to the injection wells. The two CO₂ pipeline route options from the energy center to the injection wells would require similar acreage for construction ROW (approximately 249 acres). As discussed in Section 3.10.2, agricultural land is the most prevalent land use in the ROI. Therefore, agricultural land would be encountered most frequently during construction. Agricultural land accounts for an average of approximately 90 percent of land use within the construction ROW of the two pipeline route options. Agricultural land affected by construction of the pipeline would be temporarily unavailable and then restored after construction, resulting in no permanent loss of agricultural land. While the soils within the construction ROW could be returned to production if farmed, they may be less productive in the short term due to increased compaction and some loss from soil erosion. To help preserve the integrity of any agricultural land that would be impacted by pipeline construction, the Alliance would adhere to mitigative actions specified in construction standards and policies set forth in an Agricultural Impact Mitigation agreement with the IDOA; this agreement is discussed in greater detail in Section 3.3, Physiography and Soils, **and Appendix H, Agricultural Mitigation.**

The construction ROW would involve a minimal amount of developed land. The **northern** route would result in a greater amount of developed land temporarily lost (approximately 6 acres) as compared to the **southern** route (approximately 1 acre) (see Table 3.10-4). However, most of this is open land associated with rural development (e.g., farm-related properties).

Although farm-related residential properties (i.e., developed land) are located within the 4-mile wide pipeline corridor, it is unlikely that residential structures would be directly impacted by the route selected for the proposed project. Regulations require CO₂ pipelines to be located no closer than 50 feet from residences (49 CFR 195). The Alliance proposes to locate the pipeline at least 150 feet from residences. It is possible that a shorter distance would be deemed necessary in order to avoid a sensitive environmental resource or at the request of an affected landowner, but the distance would not be less than the 50 feet required by federal regulations. The Alliance is in the process of securing easements for both temporary (for construction) and permanent (for operation and maintenance) ROWs on private lands. If it is necessary for the pipeline to bisect a private property, the design would include a suitable crossing of the pipeline to support vehicle access by the property owner throughout construction. Conformance to pipeline siting regulations would reduce potential impacts to nearby residences. It is expected that

construction of the pipeline would not place any restrictions on a landowner’s ability to sell or transfer ownership of a property during or after construction. In general, construction impacts to developed (i.e., rural residential) land use would be driven by concerns related to temporary impacts from dust, aesthetics, traffic, and noise (see Section 3.1, Air Quality; Section 3.11, Aesthetics; Section 3.13, Traffic and Transportation; and Section 3.14, Noise and Vibration).

Table 3.10-4. Potential Pipeline Route Construction Disturbances to Land Use

Land Cover Type ^a	Southern Route ^b		Northern Route ^c	
	Temporarily Lost (acres)	Permanently Lost (acres)	Temporarily Lost (acres)	Permanently Lost (acres)
Agricultural	248	0	243	0
Developed	1	2	6	9
Vegetated	0	6 ^d	0	22
Water Features	0	0	0	0
Total	249	8	249	31

Source: USDA/NRCS 2001

^a Acreages presented in this table represent the pipeline right-of-way. The Alliance would use trenchless pipe-boring techniques such as jack and bore techniques and horizontal directional drilling under sensitive natural resources. The numbers in this table present the actual acreage that would be lost, and therefore do not include the areas that would be bored under to avoid impacts.

^b Since the release of the Draft EIS, the Alliance identified a location for the injection wells (see Section 2.5.2.1) and established the pipeline routing within the CO₂ storage study area for the southern route to the proposed injection well site. This table reflects the pipeline impacts for the southern route based on the currently proposed pipeline alignment from the energy center to the injection wells.

^c The portion of the northern route within the storage study area is analyzed using a range of reasonable hypothetical end-of-pipeline spurs as presented in the Draft EIS (see Section 3.0 for further discussion). This table presents the most conservative acreages from that analysis for each resource.

^d Since publication of the Draft EIS, the Alliance reduced the impact to forested area along the pipeline route to an approximate total forested area loss of 6.0 acres compared to the upper bound of 8.0 acres described in the Draft EIS.

CO₂ = carbon dioxide

If necessary, and only after receiving a certificate of authority from the Illinois Commerce Commission for the CO₂ pipeline, the Alliance could use the right of eminent domain under Illinois law to obtain ROWs and temporary work areas in the event that an easement could not be negotiated with the affected landowner. As would be the case for all landowners, the Alliance would compensate the landowner for the ROW and for any damages incurred during construction; however, the level of compensation may be determined by the court.

Construction for pipeline crossings of roads and railroads would be accomplished using horizontal directional drilling or jack and bore technology, which allows for portions of the pipeline to be buried beneath lands without disturbing the surface directly above the pipeline. Any potential traffic lane closures to roadways would be temporary; safety measures such as the use of flaggers and signage would be used to minimize traffic delays and hazards. Therefore, impacts to traffic flow during pipeline construction are expected to be minor (see Section 3.13, Traffic and Transportation).

There are no major recreational areas along either pipeline route; therefore, access restrictions to public areas are not expected to occur during construction.

In the event that the Alliance finds it necessary for the pipeline route to deviate from the routes analyzed in this EIS, DOE expects that impacts would be consistent with those addressed in this section, since the same siting criteria would be followed. In the event that the final pipeline routing results in additional impacts to land use resources, the following potential impacts would apply. In cases where existing ROW is unavailable and the land is unable to revert back to original use (i.e., vegetated), long-term impacts would result from conversion of land to operational ROW. Agricultural land impacted during construction would be managed in accordance with the Agricultural Impact Mitigation agreement with the IDOA and

would result in short-term impacts (see **Appendix H, Agricultural Mitigation**). As a result, construction impacts to land along the final pipeline route are expected to be minor.

CO₂ Storage Study Area

Construction of the CO₂ injection well site(s) would have temporary and permanent impacts on land use within the CO₂ storage study area. **The Alliance identified the location of the proposed injection well site (referred to as the single-site scenario and shown in Figure 2-20) using results of plume modeling, characterization activities, and the siting criteria detailed in Section 2.5.2.1, such that they would not conflict with zoning requirements, if applicable. The Alliance entered into agreements with landowners within the 6,800-acre CO₂ storage study area to acquire the subsurface pore space and aboveground land area needed for the injection wells, monitoring wells, and surface facilities. The geologic formations considered for CO₂ injection are not used for any other purposes and contain no minerals and no water suitable for drinking or irrigation. Other than on the specific sites for wells and aboveground facilities, landowners would be able to use their surface property for existing purposes, such as agriculture. Refer to Section 3.4, Geology, and Section 3.5, Groundwater, for additional details.**

For the dual-site scenario analyzed in the Draft EIS, which is no longer under consideration by the Alliance, construction activities would affect up to 28 acres for the injection and monitoring wells and associated facilities; and up to 64 acres for the staging and construction of access roads. The updated design for the single-site scenario would affect approximately 15 acres for construction of the injection wells and associated facilities, and up to 4 acres for the access roads. An additional 24 acres would be affected during staging and construction of the monitoring well network, which would involve monitoring wells located at the injection wells and within the plume radius (see Figure 2-26). See Figure 2-20 for the proposed location of the injection wells under the single-site scenario, including the parcel to be purchased for injection wells and surface facilities, and the parcel to be leased for staging and laydown during construction. The property proposed for the single-site scenario includes mostly agricultural land but also a vacant house and wooded areas. The Alliance would demolish the existing vacant house for construction of surface facilities but would avoid disturbing the forested area associated with the unnamed tributary to Indian Creek along the western edge of the parcels. The Alliance also intends to preserve trees around the existing house site to the extent practicable in the site plan.

Impacts on land use during construction activities would result from clearing of vegetation, construction of the injection wells and surface facilities, equipment movement, and construction equipment laydown. Once construction is completed, the areas not used for the wells and surface facilities would be regraded and revegetated to the extent practicable, with temporary and minor land use impacts. Arrangements would be made with landowners to reduce the long-term impacts on agricultural land use or other activities around the facilities, **and the parcel leased for construction staging and laydown would be returned to availability for agricultural use.** Potential impacts to prime farmland are discussed in Section 3.3, Physiography and Soils. To reduce impacts on agricultural land, the Alliance would adhere to mitigative actions specified in construction standards and policies set forth in an Agricultural Impact Mitigation agreement with the IDOA (see Section 3.3, Physiography and Soils, **and Appendix H, Agricultural Mitigation**).

Educational Facilities

Construction of the educational facilities would have short-term, negligible impacts. The site or sites for the educational facilities would be in areas that have been previously disturbed. This proposed component would require approximately 3.5 acres of land and could involve new construction, rehabilitation of existing structures, or a combination of both types of construction activities. The Alliance would abide by stipulations of the Jacksonville Zoning Ordinance that applies to all land within the corporate limits of Jacksonville and contiguous territory within 1.5 miles beyond. Additionally, the Jacksonville comprehensive plan and future land use plans would be used during site coordination and selection, and the Alliance would coordinate with the Jacksonville Regional Economic Development Corporation during

the site identification process. Since the facilities would be constructed on previously disturbed and/or developed land, construction impacts to land use are anticipated to be negligible. **As described in Sections 2.5.3 and 3.0, since the release of the Draft EIS, discussions between the Alliance and Jacksonville civic authorities have focused on a potential site in Jacksonville, but the specific locations of the educational facilities currently remain unknown.**

3.10.3.2 Operational Impacts

Meredosia Energy Center

The operation of the oxy-combustion facility would have a negligible impact on the previously developed, industrial land use within the Meredosia Energy Center as it would not change the existing industrial use of the energy center. Since there are no land use and zoning plans for unincorporated Morgan County, no impacts to zoning would be anticipated. The proposed oxy-combustion facility represents a return to the former land use and would be compatible with land use of the industrial facilities adjacent to the energy center. Since the oxy-combustion facility would be consistent with the current land use at the energy center, nearby residential properties would not be substantially impacted by operation of the facility. Adjacent offsite properties used for construction staging would be converted back to their original use; therefore, no operational land use impacts are anticipated for these adjacent properties. Potential land use compatibility impacts on nearby residential properties would result from changes to the viewshed and increased traffic and noise levels during operation and are described in Section 3.11, Aesthetics; Section 3.13, Traffic and Transportation; and Section 3.14, Noise and Vibration, respectively.

CO₂ Pipeline

Long-term impacts to land use along the pipeline ROW would occur from the permanent conversion of land cover, including vegetated land (i.e., forests), to permanent pipeline ROW. As shown in Table 3.10-4, the amount of land permanently lost due to the pipeline would vary according to which pipeline route option would be selected (southern or northern). As such, the impact analysis focuses on the comparison of the two pipeline route options.

Any potential impacts to agricultural land would be mitigated by restoring the land to its original condition to the extent practicable and allowing the current land use to resume after construction. Adherence to ROW restrictions would be required to allow access for maintenance and limit construction of permanent structures within the permanent pipeline easement. Impacts on potential crop production would be further minimized if maintenance activities within the pipeline ROWs could be performed outside the planting and growing seasons. Therefore, operation of the pipeline would have negligible to minor long-term impacts on agricultural land use.

To further reduce impacts on agricultural land, the Alliance would adhere to mitigative actions specified in construction standards and policies set forth in an Agricultural Impact Mitigation agreement with the IDOA (see Section 3.3, Physiography and Soils, **and Appendix H, Agricultural Mitigation**). Per the Agricultural Impact Mitigation agreement, the Alliance would provide a monitoring and remediation period of no less than two years immediately following initial operation of the pipeline or the completion of initial ROW restoration, whichever occurs last. The two-year period would allow for the effects of climate cycles, trench settling, crop growth, drainage, soil erosion, etc. to be identified through monitoring. Essentially, this period would be used to identify any remaining impacts associated with the pipeline construction that would need correction and follow-up restoration, and would allow time for the Alliance to effect necessary restoration (see **Appendix H, Agricultural Mitigation**).

Pipeline construction that coincides with existing ROWs would have no long-term impacts on land use since the land would remain as operational ROW. **DOE estimates there would be approximately 167 acres of surface disturbance associated with the operational ROW for the southern pipeline route. Most of the surface disturbance would occur on agricultural land which would revert to its original use during operations and as previously discussed, would result in negligible to minor long-term**

impacts. Areas of vegetated land (e.g., forested) permanently impacted by the pipeline would account for **6** acres of land along the southern route and **22** acres along the northern route. Vegetated land in the operational ROW would be cleared, and the new ROW would be subject to restrictions within the pipeline easement regarding allowable vegetation. New ROW that would be created would have a minor long-term impact. In cases where a new pipeline would bisect a property, impacts may occur if the pipeline would obstruct current or future access within the property (i.e., road crossings and vehicle access). This impact would be avoided as the pipeline would be placed underground and engineered to withstand the weight of typical rural or residential vehicles (i.e., cars, trucks, tractors). The **northern** route would impact a greater amount of developed land than the **southern** route; potentially, **there could be** a permanent loss of approximately **9** acres of developed land in the **northern** route and approximately **2** acres in the **southern** route (see Table 3.10-4). However, most of this is open land associated with rural development (e.g., farm-related properties).

Since the Alliance proposes to locate the pipeline at least 150 feet from the nearest residences, and the land would revert back to its original use, it is unlikely that residential land or residential structures would be directly impacted; therefore, impacts would be negligible. Potential public safety impacts to residential land use during operations are discussed in Section 3.17, Human Health and Safety.

CO₂ Storage Study Area

Operation of the CO₂ injection well site(s) **could** permanently remove **some** agricultural land from existing use. Specifically, the CO₂ injection wells and supporting facilities **for the dual-site scenario, which is no longer under consideration by the Alliance,** would occupy **approximately 10** acres for the permanent operational footprint of the injection and monitoring wells and associated infrastructure and buildings, **and up to 15** acres for access roads to the well sites. **The CO₂ injection wells and supporting facilities for the single-site scenario currently proposed by the Alliance would occupy approximately 10 acres for the permanent operational footprint of the injection wells and associated infrastructure and buildings, and approximately 4 acres for access roads to the monitoring wells.**

Arrangements would be made with landowners to reduce the long-term impacts on agricultural land use or other activities around the proposed facilities. To the extent practicable, the Alliance would avoid net reductions in agricultural land. This would include designating land that is currently not farmed for use as agricultural land to replace acreages of land that would be removed from agricultural use because of the project. Land potentially placed into new agricultural use would be in the immediate vicinity of land taken out of agricultural use. Potential impacts to prime farmland are discussed in Section 3.3, Physiography and Soils, **and Appendix H, Agricultural Mitigation.** The CO₂ storage study area includes **predominantly** agricultural land but also includes areas of vegetated land that could be permanently lost if it were used for the CO₂ injection **and monitoring** wells, related facilities, **and roads.** **The footprint for the proposed injection well site (single-site scenario) would impact approximately 14 acres which primarily consists of agricultural land, thus creating long-term, minor impacts.**

Immediately adjacent land surrounding the CO₂ injection well site would remain unchanged and current uses would continue. For instance, agricultural activities would continue up to the fence line of the CO₂ injection well site; therefore, no impacts to land use adjacent to the proposed facilities would occur.

The **14-acre** area required for the CO₂ injection and monitoring wells and associated facilities **for the single-site scenario** would be owned by the Alliance, which would include the surface and deep subsurface mineral rights. Because the Alliance would own the surface and deep subsurface mineral rights of the CO₂ injection well site, it is unlikely that future drilling of wells for water, oil, or gas would occur in the operational area. Given the small area involved, this would be a negligible impact.

Additionally, the Alliance would own the deep pore space (about 4,000 feet underground) for the CO₂ plume radius (approximately 4,000 acres), which would be contained within the **6,800-acre** CO₂ storage study area. As discussed in Section 3.4, Geology, the Alliance identified a preliminary **25-square mile**

survey area centered on the **proposed injection site**. The AoR contains a variety of existing wells, including oil and gas wells, shallow water wells, and a few deep wells (three wells at 1,000 feet bgs); however, since gas, oil, and water are relatively close to the surface (e.g., groundwater at approximately 200 feet), drilling for those resources would not be precluded by the presence of CO₂ stored in the Mt. Simon Formation within the CO₂ storage study area. Therefore, the mineral rights for the adjacent land with respect to the shallow well horizon (i.e., water, oil, and gas) at similar depth to existing wells in the area would not be impacted.

Since no zoning plans or ordinances exist in unincorporated Morgan County, there would be no impacts to zoning. Land use adjacent to the CO₂ injection well site(s) would not change, and would remain in agricultural use.

Educational Facilities

Operation of the educational facilities would have negligible or no impacts on land use, because it is anticipated that these proposed facilities would be located in areas already zoned for these types of uses. As discussed in Section 3.10.3.1, the Alliance would abide by requirements of the Jacksonville Zoning Ordinance and Comprehensive Plan. **Refer, also, to Sections 2.5.3 and 3.0 for additional discussions of the educational facilities siting efforts.**

3.10.4 Impacts of the No Action Alternative

Under the no action alternative, DOE would not provide cost-shared funding for the proposed FutureGen 2.0 Project. Although the Alliance may still elect to construct and operate the project in the absence of DOE cost-shared funding, for the purposes of the analysis in this EIS, DOE assumed the no action alternative is equivalent to the no-build alternative. Therefore, the project would not be constructed and there would be no change to existing land use.

3.11 AESTHETICS

3.11.1 Introduction

This section describes existing aesthetic resources in the area that may be affected by implementation of the FutureGen 2.0 Project and the corresponding direct and indirect impacts that would occur. Aesthetic resources are considered to have inherent natural or man-made scenic properties that give a landscape its character and value as an environmental factor. For the purpose of this analysis, aesthetic resources include scenic areas such as public lands (e.g., national parks or forests), nature preserves, viewsheds (i.e., the land, water, cultural, and other aesthetic elements that are visible from a fixed vantage point), and other resources preserved and managed by federal, state, and local governments. Aesthetic resources can be affected by changes in the visual landscape, increased glares or lighting, elevated noise levels, or other factors diminishing the physical value of these resources.

Existing conditions that may also affect aesthetic qualities are addressed in other chapters of this document, such as Section 3.1, Air Quality; Section 3.9, Cultural Resources; Section 3.10, Land Use; Section 3.13, Traffic and Transportation; and Section 3.14, Noise and Vibration.

3.11.1.1 Region of Influence

The ROI for aesthetic resources includes the areas that would be impacted from construction and operation of the Meredosia Energy Center, CO₂ pipeline, storage study area, and supporting facilities (i.e., access roads and the educational facilities). Generally, the ROI would extend to the distances from which the project components are visible and would thus impact the viewshed.

Because of the relatively flat topography, it is anticipated that the new energy center emissions stack, cooling towers, and associated emissions plumes would be visible from several miles away. For the purposes of this assessment, the ROI for the energy center is defined as a fixed 5-mile radius around the center point of the Meredosia Energy Center (39.8224° North, 90.5643° West). DOE assumed a ROI for the pipeline routes and injection wells to be a 0.5-mile distance from the border of the pipeline ROW and a 1-mile radius from the injection wells. The ROI for the educational facilities is defined generally as the town identified for potential siting of the facilities, as specific sites have not yet been selected.

The oxy-combustion facility would be constructed and operated at the existing, but now suspended, Meredosia Energy Center site co-located with other industrial facilities. The CO₂ pipeline and injection well site(s) would be constructed and operated in a rural, primarily flat portion of central Illinois (see Figure 3.11-1). The landscape is predominately row-crop farmland (i.e., corn and soybeans) during the growing season, and barren, fallow fields during the remainder of the year. Additional features within the viewshed include minor stream drainages characterized by dense deciduous forest cover and shrubbery, as well as other waterbodies (e.g., ponds, lakes, and rivers). Small towns are located throughout the region, as are scattered single-family homes and agricultural structures (e.g., grain silos). Small portions of the region, specifically within the proposed CO₂ pipeline corridor and storage study area, include vistas of varied topography with scattered patches of thickets and forest, and rolling open farmland characterized by visibility ranging from a few feet to many miles in all directions. On the horizon, widely spaced infrastructure is visible, including industrial grain elevators located at rail access points and other groupings of buildings. See Section 3.10, Land Use, for further discussion of land use in the region.

Because of the rural nature of the landscape and associated lack of large urban centers in close proximity, light pollution is minimal throughout the region in which the proposed project would occur. The nighttime views include very widely spaced outdoor lights at farms and more significant light domes associated with small towns within the horizon. From some vantage points along the pipeline corridor and within the storage study area, the light domes of Jacksonville and Springfield are visible over the horizon. DOE is not aware of any current light pollution regulations in the affected areas.



Figure 3.11-1. Typical Regional Landscape

3.11.1.2 Method of Analysis and Factors Considered

Aesthetic resources in the ROI were identified through aerial photography, zoning maps, site visits, and a review of local published resources (i.e., county zoning maps, aerial photography, land use cover maps, county and town comprehensive plans).

The evaluation of potential impacts to aesthetic resources considered whether the proposed project would:

- Block or degrade a scenic vista or viewshed;
- Degrade or diminish a federal, state, or local scenic resource;
- Change the area's visual resources;
- Create glare or illumination that would be obtrusive or incompatible with existing land use; or
- Create visual intrusions or visual contrasts affecting the quality of a landscape.

Specifically, these impacts were considered relative to the proximity of sensitive receptors (e.g., residences).

3.11.1.3 Regulatory Framework

49 CFR 195.210 ("Pipeline Location") specifies that pipeline ROWs should be sited to avoid, as far as practicable, areas containing private dwellings, industrial buildings, and places of public assembly. In addition, pipelines should not be sited within 50 feet of any private dwelling, industrial building, or place of public assembly in which persons work, congregate, or assemble, unless the pipeline is provided with at least 12 inches of soil cover in addition to that prescribed in 49 CFR 195.248 ("Cover Over Buried Pipeline").

No applicable regulations have been identified that would restrict the height of the proposed project. Regulations regarding the opacity and visibility of emissions are discussed in Section 3.1, Air Quality. Regulations pertaining to noise are discussed in Section 3.14, Noise and Vibration.

3.11.2 Affected Environment

3.11.2.1 Meredosia Energy Center

The Meredosia Energy Center is located in an industrial area typical of power plants and consists of aboveground storage tanks, chimney stacks, transmission lines, barge unloading facilities, and various operational buildings. Nearby industrial facilities include the adjoining property to the south of the energy center site, which is developed and occupied by the Celanese Emulsions (National Starch & Chemical) plant and Norfolk & Western Railway. Additional chemical plant facilities, including TA Terminals Inc.

and Agrium Inc., lie to the east of the Celanese Emulsions plant, essentially southeast of the Meredosia Energy Center. These facilities utilize similar industrial structures (e.g., aboveground storage tanks). A 526-foot chimney stack at the Meredosia Energy Center is the tallest visible structure within a 5-mile radius of the energy center. Additional structures include two smaller chimney stacks measuring 301 feet and 184 feet in height, components of the oxy-combustion facility buildings ranging in height from 24 to 209 feet, and various transmission towers. Blinking aviation beacon lights on the stack are visible during nighttime hours. Historically, during operations of the energy center, a water vapor plume emanated from the facility and was visible from several miles depending on weather conditions. At the end of 2011, operations at the Meredosia Energy Center were suspended. All major structures remain in place; however, no emissions or vapor plumes emanate from the stacks. In addition, the energy center has a limited staff and traffic and noise are minimal (see Section 3.13, Traffic and Transportation; and Section 3.14, Noise and Vibration, respectively).

The area surrounding the Meredosia Energy Center has a landscape similar to the overall region. The village of Meredosia is located directly north of the energy center. The village has a population of approximately 1,044 and is of moderate density. Views of the Meredosia Energy Center from within the village are partially obstructed by existing buildings from certain vantage points. The tallest structures in Meredosia include a grain elevator and the IL-104 Bridge over the Illinois River, which has been determined eligible for listing on the NRHP. Height for the grain elevator is unavailable, but would be equivalent to that of a four story building (Hull 2012a). There are multiple tree lines in the vicinity of the Meredosia Energy Center, many of which block the oxy-combustion facility structures from outside visibility. The Illinois River is located directly west of the Meredosia Energy Center and is used for fishing, boating, canoeing, and other recreational activities (IDNR 2012). Nearby public lands or potentially scenic areas include the Meredosia National Wildlife Refuge located approximately 1 mile north of the energy center, and the Meredosia Hill Prairie Nature Preserve located approximately 5 miles to the northeast. Boyd Park, a small recreation area, is also located within the village of Meredosia. Figure 3.11-2 depicts the surrounding area with the Meredosia Energy Center in the background.

3.11.2.2 CO₂ Pipeline

The CO₂ pipeline corridor would begin in Meredosia and traverse a portion of northern Morgan County. The Alliance originally identified two possible pipeline routes from the Meredosia Energy Center to the injection wells in Morgan County. The two pipeline route options (i.e., the southern and northern route) are located within the 4-mile wide corridor shown in Figure 2-17. The corridor has a similar landscape to the overall region (see Figure 3.11-2) and encompasses the small communities of Concord and Sinclair. There are no national parks, state parks, forests, recreation areas, or wildlife refuges within the corridor.

3.11.2.3 CO₂ Storage Study Area

The CO₂ storage study area has a similar agricultural landscape to the overall region. There are no existing communities, national parks, state parks, forests, recreation areas, or wildlife refuges within the proposed area. Figure 3.11-3 depicts a typical viewshed within the storage study area.

3.11.2.4 Educational Facilities

The visitor, research, and training **facilities** are expected to be located in a city or town near the CO₂ storage study area. The Alliance is working with local stakeholders to identify the locations that would best serve the functions of the facilities. The facilities are expected to be located in or near Jacksonville, Illinois, which is the county seat and largest city in Morgan County. Jacksonville has a large historic district with well-preserved architecture, in addition to multiple historic sites listed on the NRHP (see Section 3.9, Cultural Resources). Public parks and potentially scenic areas within Jacksonville include Duncan Park, Central Plaza Park, Barr Park, Kiwanis Park, Foreman Park, Nichols Park, and the Jacksonville Community Park. The Jacksonville Municipal Airport is located approximately 3 miles north of the city center.



Figure 3.11-2. Surrounding Area with Meredosia Energy Center in Background



Figure 3.11-3. Morgan County CO₂ Storage Study Area View from North

3.11.3 Impacts of Proposed Action

3.11.3.1 Construction Impacts

Meredosia Energy Center

During construction, neighboring properties would have a partial or unobstructed view of the construction site and equipment. Figure 2-14 shows the **original** temporary and permanent impact areas **analyzed in**

the Draft EIS within the Meredosia Energy Center property. Through ongoing modifications in site plans, the Alliance significantly reduced the anticipated area of disturbance. Figure 2-15 shows the updated temporary and permanent impact areas at the Meredosia Energy Center.

Temporary impact areas are those that would be restored to their original condition to the extent practicable after construction of a project is completed. This restoration could take place in the near term or years after the areas are initially impacted, depending on the nature of the impact. Permanent impact areas are those that would be changed permanently from their prior conditions as needed for oxy-combustion facility infrastructure. The barge impact area may have shorter temporary impact durations, with impacts to aesthetics occurring only during periods of barge unloading activities.

Aesthetic impacts to the estimated 27 residences located directly adjacent to the northeast of the energy center and laydown areas would be greatest, mainly attributable to fugitive dust and noise (see Section 3.1, Air Quality; and Section 3.14, Noise and Vibration) during construction. Sensitive receptors with a direct view of the construction would experience temporary, minor adverse impacts as a result of increased visibility of construction operations. However, the site is in an existing industrial area, and construction of the proposed project would not represent a significant change in current aesthetic conditions or land use (see Section 3.10, Land Use). The majority of residents within the ROI would experience negligible impacts, as views of the Meredosia Energy Center would be obstructed by tree lines and existing structures. Certain tree lines may be temporarily deforested, which would increase visibility of construction activities. To the extent practicable, deforested areas along the site boundary would be reforested following construction; however, it may take considerable time for the vegetation to reach existing density and height (see Section 3.8, Biological Resources, for further discussion on vegetative impacts). Other wooded areas may be permanently deforested, specifically on the southern end of the site, **which could increase visibility of the energy center to sensitive receptors.**

An increase in truck traffic would occur during construction, resulting in temporary minor adverse impacts to aesthetics for the residences along the truck routes (see Section 3.13, Traffic and Transportation).

The temporary barge unloading facility would be located directly adjacent to and completely visible to an estimated nine residences. During construction, increased visibility of construction activities, noise, and increases in truck and barge traffic would adversely affect the aesthetics of the region (see Section 3.13, Traffic and Transportation; and Section 3.14, Noise and Vibration); however, these impacts would be short term and minor as the barge unloading facility would be decommissioned following the completion of the construction phase. Other nearby public lands or potentially scenic areas would experience negligible impacts.

CO₂ Pipeline

Aesthetic impacts from construction activity along the pipeline ROW would be related to increased fugitive dust, truck traffic, and noise (see Section 3.1, Air Quality; Section 3.13, Traffic and Transportation; and Section 3.14, Noise and Vibration, respectively). Temporary visual impacts from increased visibility of construction equipment and activity would occur to sensitive receptors located adjacent to the CO₂ pipeline route, as this activity would represent a considerable change from primary current agricultural uses. The alternative pipeline routes (i.e., southern and northern) were both sited to maximize the use of existing ROWs. The southern pipeline route was sited to address constructability criteria such as terrain, location criteria such as maintaining a minimum distance from residences and other occupied buildings, and environmental criteria such as avoiding sensitive environmental features. **In addition, the southern pipeline route has been sited at a minimum distance of 150 feet from occupied structures to the extent practicable, which is 100 feet further than what is federally mandated under 49 CFR 195.210. It is possible that a distance less than 150 feet would be needed in order to avoid a sensitive environmental resource or at the request of an affected landowner; however, the distance would not be less than the 50 feet required by federal regulations.** This would further reduce aesthetic

impacts from construction noise and traffic and the visible impact of pipeline construction along the southern route. Overall, minor temporary impacts to adjacent property owners would be anticipated during construction activities.

In the early stages of the FutureGen 2.0 Project, the Alliance identified the northern route for initial cost-estimating purposes. Based on subsequent investigations and field work, the Alliance identified the southern route as the proposed pipeline route. In the event that the final pipeline route deviates from the route options discussed in the EIS, the same siting criteria discussed in this section and in Section 2.5.1.1 would be utilized.

CO₂ Storage Study Area

Impacts from construction activity at the injection well site(s) would be related to fugitive dust, truck traffic, and noise (see Section 3.1, Air Quality; Section 3.13, Traffic and Transportation; and Section 3.14, Noise and Vibration, respectively). **Following publication of the Draft EIS, the Alliance selected a proposed location for the injection well site within the CO₂ storage study area, and is currently entering into agreements with property owners regarding the use of, and appropriate compensation for, surface land and subsurface pore space.**

Construction activities would require construction of surface facilities and land clearing. Once construction is complete, the areas not used for the wells and surface facilities would be regraded and revegetated to the extent practicable, with temporary minor aesthetic impacts to sensitive receptors located near the CO₂ injection well site(s). Traffic increases would adversely impact the viewshed with additional vehicles on the roads and associated engine noise; however, the Alliance would install pullouts and provide other upgrades to transportation infrastructure to reduce traffic congestion in the area and thereby reduce the adverse aesthetic impacts along the transportation routes (see Section 3.13, Traffic and Transportation).

Drilling of the injection wells would occur 24 hours per day, 7 days per week. DOE assumes the injection wells would have noise mitigation measures similar to those used at the stratigraphic well, which is currently surrounded by an earthen berm that mitigates the visual impacts and noise permeation (see Section 3.14, Noise and Vibration). The drill rig operation would be illuminated by bright lights 24 hours per day. Typical nighttime construction is depicted in Figure 2-28. Use of earthen berms and other lighting BMPs would reduce the amount of direct light visible to the nearest residence; however, it is likely that a small light dome would be visible to those residences closest to the injection well site(s), resulting in temporary moderate impacts to these receptors.

In addition to the injection wells, the Alliance expects to construct monitoring wells for the MVA program (see Section 2.5.2.2). Related aesthetic impacts would be similar to those described for the construction of the injection wells.

If electrical poles are required to bring electricity to the injection and monitoring well sites (see Section 3.15, Utilities), aesthetic impacts would occur during construction activities from equipment and noise. The Alliance would place the poles along existing or new access roads to the extent practicable.

The overall construction impacts to aesthetic resources at the injection well site(s) property would be temporary and moderate; however, the property is isolated from sensitive receptors such that these impacts would be mitigated due to distance.

Educational Facilities

The educational facilities would be located in or near Jacksonville. The site or sites for the educational facilities would be in areas that have been previously disturbed. The project may involve new construction, rehabilitation of existing structures, or a combination of both activities. Impacts from construction activity would be related to fugitive dust, truck traffic, and construction noise

(see Section 3.1, Air Quality; Section 3.13, Traffic and Transportation; and Section 3.14, Noise and Vibration, respectively). Although a specific site has not been selected, it is assumed that temporary visual impacts would occur to sensitive receptors located adjacent to the educational facilities as a result of increased visibility of construction operations. As Jacksonville contains a number of cultural resources, including a historic district (see Section 3.9, Cultural Resources), any new construction would be coordinated with the local government to best incorporate building design within the existing features of the city. **In addition, once the locations are selected, and prior to construction, steps described in the Programmatic Agreement would be undertaken to assess and resolve adverse effects on historic properties, if necessary.** Impacts from the construction of the educational facilities would be temporary and minor. **As described in Sections 2.5.3 and 3.0, since the release of the Draft EIS, discussions between the Alliance and Jacksonville civic authorities have recently focused on a potential site in Jacksonville, but the specific locations of the educational facilities currently remain undecided.**

3.11.3.2 Operational Impacts

Meredosia Energy Center

Long-term direct effects to existing viewsheds would occur from the introduction of new industrial structures at the Meredosia Energy Center. New features to the viewshed would include a stack no taller than 450 feet, a 180-foot oxy-combustion boiler building, **and various other structures ranging in height from 58 feet to 139 feet.** The existing onsite transmission towers would be demolished; in addition, four new towers of comparable height would be constructed to re-route the existing transmission lines. While some of these structures would be visible within a 5-mile radius, existing structures at the energy center exceed the height of the proposed tallest structures (i.e., the existing 526-foot stack). Moreover, the new structures would be consistent with the current infrastructure at the energy center. Large structures are also located within the village of Meredosia (e.g., grain elevator). Overall, the introduction of new structures to the viewshed would not considerably alter existing aesthetic conditions. The new stack and cooling towers would emit plume clouds that could be visible (potentially beyond the ROI) depending on weather conditions. The stack would have aviation beacon lighting, including two levels of three medium intensity strobe lights that would be visible at night. The lighting would not result in significant adverse impacts from light pollution, even when combined with the existing lighting infrastructure on the 526-foot stack.

Operational truck traffic would increase due to increased hauling of feedstock (mainly coal and limestone) and wastes (mainly fly ash and bottom ash); however, truck traffic would be routed to avoid the village of Meredosia and most sensitive receptors. This would result in minor aesthetic impacts to nearby residences along the truck routes (see Section 3.13, Traffic and Transportation).

CO₂ Pipeline

The CO₂ pipeline would be located underground and thus not visible from the surface; however, the 50-foot wide operational ROW would be permanently maintained free of woody vegetation to preserve access for inspection and maintenance activities; agricultural crops could continue to be grown within the pipeline ROW in agricultural areas. The areas outside the operational ROW, but that were disturbed as part of the 80- to 100-foot wide construction ROWs, would be replanted after construction to reestablish pre-existing conditions to the extent practicable. It would take time for these plants to grow to their prior heights and densities, particularly in forested areas (see Section 3.8, Biological Resources, for further discussion on the vegetative impacts in the ROWs). Removal and disposal of trees and brush would be consistent with the IDOA Agricultural Impact Mitigation Agreement, including consultation with the landowner to determine whether there are trees of value to the landowner that should be retained.

Along the operational ROW, there would be aboveground pipeline-related structures visible to receptors in close proximity. These structures would include meter stations, launchers and receivers (i.e., the start and end of the pipeline), pipeline markers at all crossings, mainline block valve shelters, cathodic protection station markers, and temporary zinc anode site markers (see Section 2.5.1.2 for further

discussion of these structures). These structures would be close to the ground and thus not expected to significantly alter the viewshed of any sensitive receptors.

As discussed in Section 3.11.3.1, pipeline routes have been sited to avoid major population areas, cultural resources, and public lands, and would utilize existing clearings and highway ROWs to the extent practicable. The pipeline would be located approximately 150 feet from residences (rather than the minimum 50-foot distance required under 49 CFR 195) **to the extent practicable**. This would reduce aesthetic impacts maintenance activities or other visible impacts of pipeline operations. Overall impacts from operation of the CO₂ pipeline would be minor.

CO₂ Storage Study Area

The CO₂ injection well site(s) would consist of surface facilities (**e.g., the site control and maintenance building**) and the injection and monitoring wells. These structures would not exceed one story and would be designed with surface components to blend in with the surrounding area. **Yard lighting would be provided by 158-watt LED fixtures equipped with motion sensors; light fixtures would be selected to minimize offsite glare and illumination. Lighting would be mounted on 25-foot poles that would be hinged to permit the fixtures to be lowered for maintenance.** Six-foot high fencing would be installed around the injection well site(s). Depending on the monitoring layout **and site requirements**, fencing would also enclose **some monitoring sites (see Section 2.5.2.2)**. The Alliance would also seek local landowner viewpoints on the final exterior design of surface facilities. The Alliance intends to incorporate low-height vegetated berms in their landscaping to lessen the visual impact of the facilities.

In the original scenario analyzed in the Draft EIS, if electrical poles are required to bring electricity to the well sites (see Section, 3.15 Utilities), the Alliance would place the poles along existing or new access roads, to the extent practicable. Under this scenario, **less than 1** mile of new line would be constructed. For low voltage rural lines, pole spacing of 320 feet can be assumed. With 320-foot pole spacing, **approximately 17** wooden single poles would be placed. **Since completion of the Draft EIS, the Alliance updated its design and if needed, new poles and wires would be placed along Martin Road from Negus Road to the site, a distance of one mile. Assuming 300-foot pole spacing for a three-phase line, approximately 18 wooden single poles would be placed along the road.** Pole height has not been determined; however, poles would be permanently visible from a short distance and would thus impact the viewshed for nearby sensitive receptors. Existing electrical poles are present along most major roads in the area and the placement of new poles would result in minor impacts to the viewshed.

Impacts at the injection well site(s) from traffic and noise would be negligible to minor (refer to Section 3.13, Traffic and Transportation; and Section 3.14, Noise and Vibration). Overall, aesthetic impacts from operations of the injection wells would be minor. Impacts related to aesthetics resulting from operation of the monitoring wells would be similar to those discussed for the injection wells.

Educational Facilities

The educational facilities would be located in or near Jacksonville. **The Alliance originally assumed that the visitor center and research functions would be housed in a separate building from the training function. Since the completion of the Draft EIS, the Alliance modified its plans such that the current conceptual design assumes that the visitor, research, and training facilities would potentially be housed in a single building, rather than two separate buildings.** Specific locations for these facilities have not yet been determined; however, it is expected that they would be located in existing buildings or occupy areas that have been previously disturbed. If the facilities were sited within existing structures, impacts to aesthetics would be negligible. If the Alliance constructs new buildings, the facilities would be one story and not significantly impact existing viewsheds. Increased traffic would occur as a result of patrons visiting the centers (see Section 3.13, Traffic and Transportation), whereby the impacts from traffic would depend on the pre-existing conditions of the chosen sites, though they are not anticipated to be any greater than negligible. **Refer, also, to Sections 2.5.3 and 3.0 for additional discussions of the educational facilities siting efforts.**

3.11.4 Impacts of the No Action Alternative

Under the no action alternative, DOE would not provide cost-shared funding for the FutureGen 2.0 Project. Although the Alliance may still elect to construct and operate the project in the absence of DOE cost-shared funding, for the purposes of the analysis in this EIS, DOE assumed the no action alternative is equivalent to the no-build alternative. Therefore, the project would not be constructed and land use would remain consistent with its current conditions, existing vistas and viewsheds would be preserved, and the aesthetic qualities of the ROI would remain as they are.

INTENTIONALLY LEFT BLANK

3.12 MATERIALS AND WASTE MANAGEMENT

3.12.1 Introduction

This section describes the materials and wastes historically associated with the Meredosia Energy Center prior to suspension of operations at the end of 2011. The section also presents potential direct and indirect impacts related to the materials that would be consumed and wastes that would be generated during the construction and operation of the proposed project.

3.12.1.1 Region of Influence

The ROI includes waste management facilities; industries that could use the FutureGen 2.0 Project by-products; and the suppliers of construction materials, coal, fuel oil, and process chemicals used in the construction and operation of the proposed FutureGen 2.0 Project. The extent of the ROI varies by material and waste type. The ROI for construction material suppliers and process chemical suppliers is small (within approximately 50 miles of the Meredosia Energy Center), because these types of resources are widely available and the large volumes of materials needed and wastes generated are costly to transport over large distances. Municipal landfills with adequate available capacity are present in Illinois within a distance of 100 miles from the energy center; therefore, the ROI for the disposal of non-hazardous waste is 100 miles. Treatment and disposal facilities for hazardous wastes are less common; hence, the associated ROI includes a multi-state (Illinois, Indiana, Missouri, and Michigan) area extending 100 to 400 miles from the Meredosia Energy Center. The ROI for coal includes the states of Illinois and Wyoming (the proposed suppliers for coal to operate the oxy-combustion facility).

3.12.1.2 Method of Analysis and Factors Considered

DOE evaluated impacts by comparing the demands posed by construction and operation of facilities for the FutureGen 2.0 Project to the capacities of material suppliers and waste management facilities within the ROI. The analysis also addressed regional demand and access to markets for fly ash and bottom ash. DOE assessed the potential for impacts based on whether the proposed FutureGen 2.0 Project would:

- Cause new sources of construction materials and operational supplies to be developed, such as new mining areas, processing plants, or fabrication plants;
- Affect the capacity of existing material suppliers and industries in the region;
- Create wastes for which there are no commercially available disposal or treatment technologies;
- Create the need for a hazardous waste treatment, storage, or disposal permit for the project;
- Affect the capacity of waste collection services and treatment, storage, and disposal facilities;
- Create reasonably foreseeable conditions that would increase the risk of a hazardous waste release; or
- Create reasonably foreseeable conditions that would increase the risk of a hazardous material release.

The specific quantities of materials and wastes that would be generated from the construction and operation of the energy center has been estimated based on preliminary design data for the FutureGen 2.0 Project. The impact analysis in this section uses the maximum estimated value for the materials required and waste generated by the project.

3.12.1.3 Regulatory Framework

The handling and storage of raw materials and the management of solid (non-hazardous) and hazardous wastes in Illinois are regulated by the IEPA (35 IAC) and by the USEPA (RCRA regulations in 40 CFR).

There are several in-state and out-of-state facilities that provide for the storage, treatment, recycling, and transportation of solid and hazardous waste that would be available to the FutureGen 2.0 Project.

The primary raw materials used at coal power plants are coal, water, wastewater treatment chemicals, natural gas, and backup fuel sources (e.g., fuel oil). Wastes generated at coal power plants primarily consist of coal combustion residuals. These residuals include:

- Fly ash, consisting of fine particles that are collected by the electrostatic precipitators or filter fabric baghouses from flue gasses prior to exit to the atmosphere;
- Bottom ash, or coarse particles that fall by gravity to the bottom of the boiler; and
- Boiler slag, which is molten bottom ash that when quenched with water forms uniform-sized pellets.

Coal combustion residuals are among the largest waste streams generated in the United States. According to the American Coal Ash Association's Coal Combustion Product Production & Use Survey Report, more than 136 million tons of these residuals were generated in 2008 (USEPA 2011n). Some coal combustion residuals are beneficially reused (e.g., fly and bottom ash are used in concrete production); however, when reuse is not feasible these residuals are typically placed in permitted ponds or landfills. Coal combustion residuals typically contain a broad range of metals, including arsenic, selenium, and cadmium; however, the leach test levels rarely reach the RCRA hazardous waste characteristic levels (USEPA 2011n). Coal combustion residuals are not currently regulated as RCRA hazardous waste under an amendment to RCRA.

Federal regulations governing the disposal of coal combustion residuals may become more stringent in the future. On June 21, 2010, USEPA proposed to regulate coal combustion residuals to address the risks from the disposal of the wastes generated by electric utilities and independent power producers. Under this proposal, USEPA is considering two possible options for the management of coal combustion residuals. Under the first option, USEPA would list these residuals as special wastes subject to regulation under subtitle C of RCRA, when destined for disposal in landfills or surface impoundments. For the second option, USEPA would regulate coal combustion residuals under subtitle D of RCRA, the section for non-hazardous wastes. USEPA has not issued a final ruling at the time this EIS was prepared. USEPA is proposing to retain the exemption from regulation for beneficial uses of coal combustion residuals (e.g., asphalt, cement, concrete).

Within the state of Illinois, coal combustion residuals are regulated as non-RCRA special waste unless the generator of these residuals certifies that the waste meets certain requirements to be declassified as a special waste (DOE 2006; IEPA 2012b). Special waste is defined by the IEPA as any potentially infectious medical waste, hazardous waste, pollution control waste, or industrial process waste and is regulated under 35 IAC, Subtitle G. Any non-hazardous industrial process waste or pollution control waste may be declassified if the generator certifies that the waste:

- Is not hazardous;
- Is not a liquid;
- Is not regulated asbestos-containing material as defined in 40 CFR 61.141;
- Does not contain PCBs regulated in accordance with 40 CFR 761;
- Is not formerly hazardous waste rendered non-hazardous; and
- Does not result from shredding recyclable metals;

Declassified special waste coal combustion residuals can be disposed of in any permitted commercial solid waste landfill in the state. Coal combustion residuals may also be disposed of in onsite, captive

landfills or surface impoundments. Captive disposal facilities do not need permits, but they must meet design standards for landfills and they can only receive coal combustion residual waste that was generated onsite.

Pollution control waste (e.g., dust collected from baghouses on air emissions control equipment) and wastewater are other wastes typically generated in large quantities at power plants. In Illinois, pollution control waste is regulated as a special waste. As discussed above, a special waste that has been declassified can be disposed of in a municipal landfill; otherwise, it must be disposed of in landfills permitted to receive special waste. Wastewater at power plants is typically treated onsite and discharged under a state-regulated wastewater discharge permit (see Section 3.6, Surface Water). Typical hazardous waste generated at coal power plants is generally limited to spent cleaners and solvents from maintenance and unused or spent wastewater treatment chemicals.

3.12.2 Affected Environment

Solid (Non-hazardous) Waste Landfills

As of 2011, Illinois had 40 active landfills (IEPA 2012c). The Illinois Nonhazardous Solid Waste Management and Landfill Capacity Report (IEPA 2012c), organizes these landfills into seven regions and provides the locations and life expectancies of each landfill. Table 3.12-1 lists the landfills within a 100-mile radius of the Meredosia Energy Center and their remaining disposal capacities. In addition to these and other landfills located in Illinois, there are available landfills in adjoining states. However, out-of-state landfills are not expected to be utilized based on the available in-state capacity.

Illinois landfills within a 100-mile radius of the Meredosia Energy Center are located in Illinois Regions Three, Four, Five, and Six (IEPA 2012c). Region Three includes the Peoria and Quad Cities area and is a 14-county region that includes landfills located in counties north of the Meredosia Energy Center. Region Three landfills within the ROI have an estimated combined remaining capacity of 62.6 million cubic yards. Region Four includes 19 counties to the east of the Meredosia Energy Center. Three landfills in this region are within the ROI, with an estimated capacity of 49.7 million cubic yards. Region Five is a 17-county region that includes Morgan County and has four active landfills, all within the project ROI. There are no landfills in Morgan County; the closest landfill to the Meredosia Energy Center is the Hickory Ridge Landfill located approximately 20 miles west of the Meredosia Energy Center. Region Five landfills have approximately 36.1 million cubic yards of remaining capacity. Finally, Region Six consists of nine counties to the south of the Meredosia Energy Center. Two landfills in this region are within the ROI, with an estimated capacity of 30.8 million cubic yards.

Hazardous Waste Treatment, Storage, Disposal and Recycling Facilities

Hazardous waste generated in Illinois may be managed both at the site of generation and at commercial facilities located within and outside of the state (IEPA 2011e). The FutureGen 2.0 Project would utilize one or more offsite facilities for hazardous waste management; onsite treatment of hazardous waste would not take place. There are several in-state options for storage, treatment, recycling, incinerating, processing, and transporting hazardous waste. The vast majority of in-state hazardous waste management consists of treatment and recycling (IEPA 2011e).

Within Illinois, there are a total of 18 hazardous waste treatment, storage, disposal, and recycling facilities (ENVCAP 2011). Within the states immediately bordering Illinois (Iowa, Wisconsin, Missouri, Kentucky, and Indiana) there are 45 additional hazardous waste treatment, storage, disposal, and recycling facilities (ENVCAP 2011).

Table 3.12-1. Illinois Landfills within the Region of Influence and Expected Year of Closure

Landfill Name	IEPA Region/County	Remaining Capacity as of 1/1/2012 (cubic yards)	Expected Year of Closure
Envirofil of Illinois	Region Three/McDonough	17,688,000	2105
Indian Creek Landfill #2	Region Three/Tazewell	39,701,000	2043
Peoria City/County Landfill #2	Region Three/Peoria	543,000	2021
Peoria Disposal Co. #1, Inc.	Region Three/Peoria	6,000	2013
Knox County Landfill #3	Region Three/Knox	4,705,000	2028
American Disposal Services Inc./McLean County Landfill #2	Region Four/McLean	1,859,000	2016
Clinton Landfill #3	Region Four/Clinton	47,501,000	2057
Veolia Environmental Services Valley View Landfill, Inc. ^a	Region Four/Macon	314,000	2013
Hickory Ridge Landfill, Inc.	Region Five/Pike	4,488,000	2023
Sangamon Valley Landfill, Inc.	Region Five/Sangamon	6,053,000	2024
Litchfield Hillsboro Landfill	Region Five/Montgomery	3,415,000	2026
Five Oaks Recycling and Disposal Facility	Region Five/Christian	22,103,000	2054
Roxana Landfill	Region Six/Madison	28,419,000	2021
Milam Recycling and Disposal Facility ^b	Region Six/St. Clair	2,369,000	2013

Source: IEPA 2012c

^a. Permit application Log #2009-571 for a proposed expansion (9,532,000 cubic yards) is under review as of December 31, 2011.^b. Permit application for a proposed expansion has been approved, to allow operations to continue beyond 2013.

Note: An additional landfill in Region 3, Spoon Ridge Landfill, has remaining capacity of 133,317,000 cubic yards but has been inactive since 2008. The existing fill area was capped in 2010 and 2011, and is in the process of being permanently closed. As of June 1, 2011, an affidavit for certification of completion of closure (Log 2011-250) has been submitted to IEPA for review. Once approved, the permitted landfill capacity will be zero. As of Dec. 31, 2011, the affidavit was under review.

IEPA = Illinois Environmental Protection Agency

3.12.2.1 Meredosia Energy Center

A review of various regulatory databases indicates that the Meredosia Energy Center property is not associated with voluntary cleanup for leaking underground storage tanks. There are no known Superfund sites within a 50-mile radius of the property (USEPA 2012f).

The Meredosia Energy Center is regulated under RCRA for activities associated with the handling, storage, and disposal of hazardous and solid waste. The facility is regulated as a small-quantity generator of hazardous waste, meaning the facility may generate more than 220 pounds, but less than 2,200 pounds, of hazardous waste per month. The Meredosia Energy Center has numerous aboveground storage tanks, warehouse buildings, and storage areas. In addition, the energy center maintains two ponds historically used for the disposal of fly ash and bottom ash generated onsite prior to the suspension of operations at the end of 2011. A description of the main process-related raw materials used for current operations is provided below.

Process-Related Materials

The primary process-related materials historically used (prior to the suspension of operations at the end of 2011) include IL No. 6 and Powder River Basin coal, fuel oil, natural gas, and process water treatment

chemicals. The storage and use of each of these materials is discussed below. Table 3.12-2 lists the historical quantities of coal and fuel oil delivered to the energy center each year.

Table 3.12-2. Historical Material Usage Rates

Product	Annual Usage				
	2007	2008	2009	2010	2011
IL No. 6 Coal (tpy) ^a	281,497	203,439	0	0	0
PRB Coal (tpy)	825,912	712,284	346,856	364,632	242,415
Residual Fuel Oil (gallons per year)	1,165,609	0	800,000 ^b	0	0
Distillate Fuel Oil (gallons per year)	479,217	500,019	190,820	350,313	107,994

^a. Assuming that all coal supplied by truck was IL No. 6 coal.

^b. Oil was sold and offloaded to a barge.

IL = Illinois; PRB = Powder River Basin; tpy = tons per year

Coal Supply. Historically, the Meredosia Energy Center used sub-bituminous coal from the Powder River Basin in Wyoming and bituminous coal from Illinois (Illinois No. 6 coal) to fuel Unit 3 (Boiler 5). Units 1 and 2 (Boilers 1 through 4) were typically supplied with Illinois No. 6 coal; operation of these units is currently suspended, though they could be reactivated in the future. The typical burn rate of Boilers 1 through 4 of bituminous coal was approximately 180 tons per hour at full load. The burn rate for Unit 3 (Boiler 5) was approximately 108 tons per hour of bituminous coal or 125 tons per hour of Powder River Basin coal. Coal was delivered by barge and truck, and stored in onsite storage piles.

Fuel Oil and Natural Gas. Boiler 6 operated on fuel oil that was stored in two 4.6 million-gallon aboveground storage tanks. Distillate fuel oil was used as auxiliary fuel for Boilers 1 through 6, to power onsite mobile power equipment (scraper dozers, etc.) and to operate stationary equipment. Distillate fuel was stored in eight 14,000-gallon aboveground storage tanks. Natural gas was provided via an underground pipeline (see Section 3.15, Utilities) and used for warmup and ignition of Boiler 6 and to fuel a small boiler to heat the molten sulfur tank when steam was not available from the main boilers.

Process Water Treatment Chemicals. The process chemicals used by the energy center, prior to the suspension of operations at the end of 2011, were common water treatment and conditioning chemicals that are widely used in industry. Sulfuric acid and sodium hydroxide were used to regenerate the ion exchange resin in the demineralizer, where deep well water was treated for use as boiler makeup water. Sulfuric acid was also used to control pH in the fly ash pond effluent. Sulfuric acid was stored in a 10,000-gallon aboveground storage tank; sodium hydroxide was stored in a 22,600-gallon aboveground storage tank and in a 10,000-gallon day tank. Boiler 6 utilized hydrazine and ammonium hydroxide for all-volatile treatment of boiler feed water, whereas Units 1, 2, and 3 utilized hydrazine and phosphate treatment. Hydrazine and ammonium hydroxide used in the boiler treatment chemical feed program were stored in aboveground storage tanks or smaller containers (e.g., 55-gallon drums). Disodium phosphate and trisodium phosphate were stored dry in bags or covered plastic barrels at the location of final use. Since the energy center suspended operations, no water treatment and conditioning chemicals have been delivered to the energy center.

Process-Related Waste

Fly Ash and Bottom Ash. The main process-related wastes historically generated at the Meredosia Energy Center were fly ash and bottom ash. Table 3.12-3 shows the annual generation of coal combustion residuals at the Meredosia Energy Center.

Table 3.12-3. Historical Coal Combustion Residuals Generation

Waste	Amount Generated (tpy)				
	2007	2008	2009	2010	2011
Fly Ash	54,387	45,970	14,526	19,332	20,570
Bottom Ash	13,597	2,419	2,563	3,412	3,630
Total CCR	67,984	48,389	17,089	22,744	24,200

CCR = coal combustion residuals; tpy = tons per year

Fly ash and bottom ash generated at the Meredosia Energy Center were historically disposed of in two onsite ash ponds (note that any ash generated in the future from operation of the proposed oxy-combustion facility would not be disposed of in these ponds). The fly ash pond was commissioned in 1968, is 34 acres in area, and has a total storage capacity of 620 acre-feet. The bottom ash pond was commissioned in 1972, is 11 acres in area, and has a total storage capacity of 186 acre-feet. There has been one incident within the past 10 years, which occurred in 2006, when water from the fly ash pond was released to the land (less than 500 gallons). In response, the pond was modified and the energy center adopted internal procedures to prevent a recurrence. No other spills or releases from the ash ponds have occurred.

The IEPA reports that there are 24 power plants in Illinois with a total of 68 active ash impoundments and 15 inactive ash impoundments that are regulated under Illinois' NPDES permit program. IEPA identified the Meredosia Energy Center surface impoundments as one of 10 "Priority 1" surface impoundments, for its high potential for aquifer recharge that could have an impact on existing or future potable water uses (IEPA 2011e). Priority 1 facilities were requested to install groundwater monitoring wells, implement a monitoring program, and submit electronic compliance reports to IEPA because a groundwater monitoring system was not already in place at these facilities. According to the IEPA, initial groundwater monitoring results have been submitted and reviewed for Priority 1 facilities (IEPA 2011c). IEPA analyzed groundwater flow direction based on the initial sampling event at the Meredosia Energy Center and determined that groundwater flows towards the river, which would not affect any of the potable water supply wells identified near the ash ponds. IEPA sent a letter to Ameren stating that if elevated levels of contaminants were identified, further investigation and appropriate remedial activities would be required where necessary. It should be noted that the existing ash ponds at the Meredosia Energy Center will remain the responsibility of Ameren and would not be used for the FutureGen 2.0 Project.

Other Hazardous and Solid (Non-Hazardous) Waste. The Meredosia Energy Center used nearby solid waste management facilities for the offsite disposal of its solid waste (other than coal combustion residual waste, which was placed in onsite ponds as discussed above). Hazardous waste was disposed of at an offsite treatment facility. Table 3.12-4 shows historical quantities of hazardous waste generated by the facility. Solid waste typically consisted of sanitary waste, general and bulk trash; scrap metal was also collected and sent to metal recyclers. Table 3.12-5 shows the approximate annual quantities of solid waste generated by the facility.

Table 3.12-4. Historical Hazardous Waste Generation

Waste Shipping Date	Waste Description	Quantity (pounds)	Quantity (gallons)
February 2009	Flammable liquid and hazardous waste solids	926	122
April 2009	Flammable liquid	413	55
December 2011	Corrosive liquid, inorganic	150	20

Table 3.12-5. Historical Solid (Non-hazardous) Waste Generation

Waste Receptacle	Capacity	Pickup Frequency	Approximate Annual Waste Generation ^a
Trash Compactor	6 cubic yards	Every 2 weeks (26 times per year)	156 cubic yards
Bulk Trash Compactor	25 cubic yards	Monthly (12 times per year)	300 cubic yards
Scrap Metal Dumpster	50,000 pounds	Three (3) times per year	150,000 pounds

^a. These quantities are calculated assuming that containers were full at the time of each pickup.

3.12.2.2 CO₂ Pipeline

The region around the proposed pipeline corridor from the Meredosia Energy Center to the CO₂ storage study area consists mainly of agricultural land, scattered small communities (i.e., Concord and Sinclair), and the larger city of Jacksonville. There are no known structures or material storage areas located along the proposed CO₂ pipeline corridor. Further, there are no known areas of historical or current contamination from hazardous materials or wastes present along the proposed pipeline corridor.

3.12.2.3 CO₂ Storage Study Area

There are no material storage areas located at the proposed CO₂ storage study area. Further, there are no known areas of historical or current contamination from hazardous materials or wastes. **Since publication of the Draft EIS, the Alliance identified a potential site within the CO₂ storage study area for constructing the CO₂ injection wells. There is an unoccupied residential structure located within the boundaries of the proposed construction site. The house was built between 1959 and 1963 and, while no studies have been conducted, it is possible that toxic substances such as lead and asbestos may be present due to the age of the structure. In addition, there is a potential for residential heating oil storage tanks to be present on the property.**

3.12.2.4 Educational Facilities

The visitor, research, and training **facilities** are expected to be located in or near Jacksonville, Illinois. The Alliance is working with local stakeholders to identify the locations that would best serve the functions of the facilities. Because the locations of the educational facilities are unknown, DOE cannot characterize the existing environment specifically; however, it is likely that the facilities would be located in a semi-urban to urban area. The city of Jacksonville and its vicinity has ample access to material supplies and waste disposal services. **As described in Sections 2.5.3 and 3.0, since the release of the Draft EIS, discussions between the Alliance and Jacksonville civic authorities have focused on a potential site in Jacksonville, but the specific locations of the educational facilities currently remain unknown.**

3.12.3 Impacts of Proposed Action

3.12.3.1 Construction Impacts

Meredosia Energy Center

Standard construction materials for the oxy-combustion facility at the Meredosia Energy Center would include structural steel members, steel and other metallic and non-metallic piping and tubing, tanks, valves, concrete, ductwork, insulation, electrical cable, sand, paint, fasteners, mechanical and electrical fittings, adhesives, and lumber for the proposed facilities and temporary structures (e.g., fencing and scaffolding). Components of the facilities would also include lighting fixtures, small electrical generators, transformers, and other miscellaneous electrical equipment. These materials are typical construction-related materials and would be available from local suppliers within the region. It is expected that the materials needed would be readily available, and the quantities required for construction at the energy center would not result in any adverse impacts on regional supplies. There would be larger electrical components and specialty materials needed for the project that would likely be obtained from national or international suppliers.

Waste from construction at the energy center and supporting infrastructure would include demolition materials from the removal of existing structures, excess materials, and miscellaneous materials such as pallets, crates, and other packing materials. Demolition materials would be segregated by materials that can be reused or recycled (e.g., scrap metal) from waste materials that would be disposed of in offsite demolition waste landfills. Regulated wastes such as asbestos or lead-based paint, if generated during construction activities, would be managed and disposed of in accordance with applicable regulations. Excess supplies of new materials would be returned to vendors or be retained for future use. Surplus paint, partial spools of electrical cable, and similar leftover materials would also be retained for possible future use in maintenance, repairs, and modifications. Scrap metal would be sold to scrap dealers. Packaging material (e.g., wooden pallets and crates), support cradles used for shipping large vessels and heavy components, and cardboard and plastic packaging would be collected in dumpsters and periodically transported offsite for recycling or disposal. Organic debris (e.g., dirt, brush) would be generated from clearing and grading, although the majority of the area is free of vegetation. Organic debris would be used as fill on the site when feasible or disposed of at an offsite facility.

Construction equipment would include cranes, forklifts, air compressors, welding machines, trucks, and trailers. Operation of heavy equipment would require fuel, oils, lubricants, and coolants. These materials may be stored onsite in aboveground storage tanks, 55-gallon drums, or smaller containers. Vehicle maintenance could be contracted either onsite or offsite. All liquid hazardous material storage would be equipped with secondary containment to prevent a release of these liquids to the environment. Should any of these liquids require disposal, they would be appropriately managed in accordance with Illinois and federal regulations by the construction contractor.

The available solid waste disposal capacity in the region is summarized in Table 3.12-1. Because the quantity of waste from construction of the oxy-combustion facility at the Meredosia Energy Center would be small in comparison to the landfill capacity and waste quantities routinely handled, the impact to waste collection and disposal services within the ROI would be negligible.

CO₂ Pipeline

During the construction of the CO₂ pipeline, removal and disposal of trees, brush, etc. would be consistent with the IDOA Impact Mitigation Agreement (**see Appendix H, Agricultural Mitigation**), including consultation with landowners to determine whether there are trees of commercial or other value to the landowner that should be retained. Construction-related debris would be used as fill along the pipeline whenever feasible and allowed by state regulation; other construction waste would be removed and disposed of at an offsite facility.

Additional raw materials (e.g., pipeline materials, fuel for equipment) would be required for pipeline construction. The quantities and types of materials required for the project are expected to be readily available within the region and nationally.

CO₂ Storage Study Area

As described in the Draft EIS, the Alliance evaluated several different injection well configurations, using both horizontal and vertical wells at one or two sites, and selected the single-site scenario with four horizontal injection wells as the proposed option. However, DOE considered and analyzed both scenarios (i.e., single-site and dual-site) in the Draft EIS, to develop a reasonable upper bound for impacts with respect to materials and waste. The dual-site scenario is no longer under consideration by the Alliance; in addition, since publication of the Draft EIS, the Alliance updated and refined the proposed design for the injection wells and surface facilities (see Sections 2.5.2.2 and 2.5.2.3 for a discussion of these changes as well as the current design). However, it is not expected that these changes would have a significant effect on materials use or waste generation from construction of the injection wells and surface facilities. Therefore, DOE believes that the analysis of impacts presented in the Draft EIS is still valid and has retained it for the Final EIS.

Construction materials for the surface facilities would consist primarily of structural steel beams and steel piping, tanks, valves, sand, paint, and lumber for the proposed facilities and temporary structures (e.g., fencing and scaffolding). Other materials needed would include concrete, ductwork, insulation, electrical cable, lighting fixtures, generators, and transformers. These materials are typical construction-related materials and would be available from local suppliers within the region.

Other components to be constructed at the CO₂ injection well site(s) would be the injection wells, monitoring wells, any piping associated with the wells, and access roads. The materials needed for well components would include piping and concrete for seaming. The construction of the pipeline would require metal, as well as joining and welding materials including compressed gases. Construction of the injection wells would require materials to operate and maintain construction equipment, including engine oil, hydraulic oil, diesel fuel, gasoline, antifreeze, and drilling fluids. Fuel would be stored in aboveground storage tanks equipped with secondary containment. Double-wall tanks would be preferred, but lined dikes with a capacity of 1.5 times the volume of the storage tank(s) could also be used. Sources for these construction materials are well established both regionally and nationally, and the quantities of materials required to construct the pipeline would have a negligible impact on the supply and demand for these materials.

Wastes generated during well construction would include drill cuttings, drilling fluid, and fluid removed from subsurface formations. It is anticipated that **up to** approximately **1,100** cubic yards of drill cutting waste would be generated. These wastes would be transported offsite by a licensed waste hauler for treatment and disposal at permitted facilities.

All construction materials would be ordered in the correct sizes and quantities, resulting in small amounts of excess material that could be saved for future use and very small amounts of waste to be disposed in a permitted landfill. Heavy equipment would be used that requires fuel, oils, lubricants, and coolants. Should any of these hazardous materials require disposal, they would likely be regulated as special waste or hazardous waste and would be appropriately managed (e.g., recycled or treated and disposed of offsite) by the construction contractor. Precautions would be taken to minimize the potential for spills; any releases would be immediately cleaned up. Personnel would be trained and equipped to respond to spills when they occur. There would be no impact to waste collection services or disposal capacity. As previously discussed, there is adequate solid waste disposal capacity in the region and adequate hazardous waste treatment, storage, and disposal facilities available within the region and nationally.

The existing residential structure within the proposed injection well site would be demolished prior to starting construction activities. The property would be examined for the presence of hazardous materials prior to demolition and if any hazardous materials are found to be present, they would be segregated and managed in accordance with all applicable local, state, and federal regulations.

Educational Facilities

The visitor, research, and training **facilities** would be located **in or near Jacksonville, Illinois**. Non-hazardous and hazardous or special waste generated from the construction of the educational facilities would be similar to those described above for the surface facilities at the injection wells. The construction of the educational facilities would generate approximately 82 tons of waste. As discussed earlier, the specific locations of the educational facilities are currently unknown, but they would be located in the Jacksonville area. The site or sites for the educational facilities would be in areas that have adequate access to sources of construction materials and waste disposal facilities. Therefore, impacts to materials availability and waste disposal would be negligible.

3.12.3.2 Operational Impacts

Meredosia Energy Center

Process-Related Materials

Similar raw materials as previously used at the Meredosia Energy Center would be required for the FutureGen 2.0 Project, namely coal, fuel oil, natural gas, and water treatment chemicals. Table 3.12-6 provides the estimated quantities of coal, trona, and **hydrated** lime that would be used. **These values have been updated to reflect the most current design, which involves slightly increased quantities of process-related materials. DOE has revisited the impact analysis presented in the Draft EIS and concluded that the impacts remain consistent with those reported in the Draft EIS.**

Table 3.12-6. Estimated Process Material Requirements for the Oxy-Combustion Facility

Material ^a	Quantity (tpd)	Quantity (tpy)
Bituminous Coal (IL No. 6) (60 percent)	1,224	446,760
Sub-bituminous Coal (Powder River Basin) (40 percent)	816	297,840
Hydrated Lime	186.9	68,219
Trona	8.9	3,241

^a Estimated values in this table have been updated to reflect project design changes since publication of the Draft EIS.

IL = Illinois; tpd = tons per day; tpy = tons per year

Coal Supply. Coal would be delivered to the Meredosia Energy Center site by barge or truck and would be stored in the existing coal pile, which has the capacity to handle coal for the proposed FutureGen 2.0 Project. Table 3.12-6 lists the quantities and types of coal that the oxy-combustion facility would use. The quantities required would be lower than the amounts historically used by the Ameren facility, and would have a negligible impact on national supplies of coal.

Hydrated Lime and Trona. The estimated consumption of **hydrated** lime and trona is presented in Table 3.12-6. **Hydrated** lime and trona would be delivered to the energy center by truck and stored onsite. The required quantities of these materials would have a negligible effect on supply, compared to regional and national availability.

Fuel Oil and Natural Gas. The estimated consumption of natural gas is not known. The estimated consumption of fuel oil by stationary sources would be up to 877,000 gallons per year, depending upon the number of warm and cold startups the system may experience. Fuel oil would be stored in aboveground storage tanks, while a natural gas pipeline already serves the Meredosia Energy Center (see Section 3.15, Utilities). Fuel oil and natural gas are commonly used in industrial facilities and are widely available from suppliers.

Water and Wastewater Treatment Chemicals. The estimated consumption of process chemicals by the oxy-combustion facility is not presently known. Water treatment chemicals expected to be used are commonly used in industrial facilities and are widely available from national suppliers. The materials needed in the largest quantities would be sulfuric acid, sodium hydroxide, and lime. The polymers, antiscalants, and stabilizers needed for the cooling tower, makeup water, and wastewater systems are not specified at this time; however, a variety of products are available from regional and national suppliers.

Process-Related Waste

Table 2-6 provides the estimated quantities of fly ash and bottom ash that would be generated from the operation of the oxy-combustion facility, while Table 3.12-7 provides the estimated quantities of other wastes that would be generated at the Meredosia Energy Center.

The primary waste stream anticipated from the operation of the oxy-combustion facility would consist of fly ash and bottom ash. The facility would generate in excess of 200,000 tons of fly ash and bottom ash per year. These wastes would be disposed of at an offsite facility; the two onsite ponds that historically accepted fly ash and bottom ash would not be used for disposal of fly ash or bottom ash for the FutureGen 2.0 Project. Fly ash and bottom ash would be stored onsite before being transferred into trucks that would transport these wastes to an offsite facility. See Section 2.4.4.2 for further information. Per IEPA regulations, coal combustion residuals (including fly ash and bottom ash) are considered special wastes (see Section 3.12.1.3) and may only be disposed of in landfills permitted to receive special waste. However, generators of special waste may request IEPA to declassify their waste if the waste meets certain criteria; if declassified, the waste can be disposed of in any permitted landfill. Coal combustion residuals are typically eligible for declassification based on the criteria established by IEPA (IEPA 2012b). If declassified, the fly ash and bottom ash generated by the FutureGen 2.0 Project would be disposed of in any available, permitted landfills; otherwise, they would be disposed of in landfills permitted to receive special waste.

In addition, the bottom ash and fly ash generated would be beneficially reused whenever possible, to reduce the volumes requiring disposal. If there is not a demand for the ash by-product, disposal of the bottom ash and fly ash at a commercial landfill could potentially shorten the lifespan of landfills selected for the project, due to the large quantity of ash that would be disposed. This could have a minor to moderate negative impact on the availability of disposal options for businesses and communities.

Table 3.12-7. Estimated Other Waste Generation Rates

Waste Type	Amount per day	Amount per year	Waste Type/Disposal
60 percent Illinois No. 6 and 40 percent PRB Coal Combustion			
Solid waste			
General trash; bulk trash	Highly variable	156 cubic yards	Municipal solid waste/Landfilled offsite
Scrap metal	Highly variable	75 tons	Scrap metal/Recycled offsite
Hazardous wastes	Highly variable	Similar to historical rates	RCRA hazardous waste/Offsite treatment and disposal
Water and Wastewater Treatment System Wastes			
Process water treatment system clarifier sludge	Highly variable	158 tons	Special waste/Offsite disposal
Process water and wastewater treatment wastes (Reverse osmosis chemical cleaning water; Mercury polishing system spent media and backwash; Wastewater treatment system clarifier sludge)	Quantity not known at this time	Quantity not known at this time	Special waste/Offsite treatment
Oil-water separator waste	Highly Variable	4,300 gallons per year	Oil recycler

PRB = Powder River Basin; RCRA = Resource Conservation and Recovery Act

As discussed earlier, the USEPA has also proposed new rules on the management and disposal of coal combustion residuals under RCRA (see Section 3.12.1.3). At the time of this EIS, these rules have not been finalized. If the USEPA finalizes these rules in the future, the FutureGen 2.0 Project would comply with them, as applicable. Per USEPA's current proposed rule, beneficial use of coal combustion residuals would continue to be exempted from regulation.

In addition to the waste previously described, the facility may generate hazardous waste such as solvents and paints from maintenance activities. If operations at the energy center generate enough hazardous waste to meet the threshold for a large quantity generator of hazardous waste as defined by USEPA (greater than 2,200 pounds of hazardous waste generated per month), the facility would be operated in compliance with all requirements applicable to large quantity generators. Hazardous waste would be managed in accordance with federal and state hazardous waste regulations, including providing secondary containment where necessary. All hazardous waste would be transferred offsite to a hazardous waste treatment, storage, and disposal facility.

Chemical waste would be generated by periodic cleaning of the steam generator and turbines. This waste would consist of alkaline and acidic cleaning solutions mixed with wash water, and is likely to contain heavy metals. Chemical cleaning would be performed by outside contractors who would be responsible for the removal of associated waste products from the site. Cleaning waste would be characterized prior to disposal and, if determined to be hazardous, would be managed and tracked appropriately; however, based on available information, it is not expected that this waste stream would be considered hazardous waste. Precautions would be taken to prevent releases by providing spill containment for tankers used to store cleaning solutions and waste.

Other wastes generated would include solids generated by water and wastewater treatment systems, such as activated carbon. Water from the Illinois River would serve as the process water supply for the oxy-combustion facility. The water supply would have to be treated to decrease the concentrations of dissolved solids and constituents such as sodium and potassium to levels consistent with the process water design parameters for the oxy-combustion facility. Waste generated by the water treatment facility would include sludge and spent filter media that would be transported offsite for disposal in a municipal landfill approved for disposal of special waste.

Wastewater from the CO₂ compression and purification unit would be pH-adjusted and treated to remove mercury, prior to discharge. Spent mercury polishing media and mercury polishing system backwash would be transferred offsite for disposal. This waste would be characterized prior to disposal and, if determined to be hazardous, would be managed accordingly. Wastewater from other Unit 4 processes would be treated to meet all applicable water quality standards found in 35 IAC 302 (Water Quality Standards) and applicable state and federal effluent limits. Wastewater contaminated with oil would be routed through oil-water separators before being sent to the wastewater treatment systems. Oil-water separator waste (i.e., oily water) would be collected in a storage reservoir integrated into each oil-water separator, and would be pumped out periodically for transport and disposal offsite. It is expected that separator waste would be transferred directly from the separators into a truck and would be removed from the facility on the same day; however, it is possible that the waste may be transferred to an intermediate tank with secondary containment prior to shipment offsite. Such an arrangement, if used, would be described in the SPCC plan along with procedures for preventing spills during transfers. Dewatered sludge from the wastewater treatment systems would be transported offsite for disposal in a municipal special waste landfill.

DOE estimates that the quantities of general (i.e., municipal) solid waste and hazardous waste generated would be comparable to the historical rates discussed in Section 3.12.2.1. Given the small amount of sanitary and hazardous waste (e.g., paints and solvents) that would be generated and the availability of commercial treatment and disposal facilities, the impact of disposal of generated waste would be negligible.

CO₂ Pipeline

Operation of the CO₂ pipeline would require periodic inspections and maintenance activities, including vegetation clearing along the pipeline ROW. Small amounts of organic land clearing debris would be generated as a result of these activities, and would be disposed of in an offsite disposal facility. No other solid or hazardous wastes would be generated as a result of pipeline operations.

CO₂ Storage Study Area

As described in the Draft EIS, the Alliance evaluated several different injection well configurations, using both horizontal and vertical wells at one or two sites, and selected the single-site scenario with four horizontal injection wells as the proposed option. However, DOE considered and analyzed both scenarios (i.e., single-site and dual-site) in the Draft EIS to develop a reasonable upper bound for impacts with respect to materials and waste. The dual-site scenario is no longer under consideration by the Alliance; in addition, since publication of the Draft EIS, the Alliance updated and refined the proposed design for the injection wells and surface facilities (see Sections 2.5.2.2 and 2.5.2.3 for a discussion of these changes as well as the current design). However, it is not expected that these changes would have a significant effect on materials use or waste generation from operation of the injection wells and surface facilities. Therefore, DOE believes that the analysis of impacts presented in the Draft EIS is still valid and has retained it for the Final EIS.

During normal operations at the injection wells, minimal waste would be generated from routine maintenance. The waste could be special or hazardous (e.g., lubricants and oils) and sanitary waste (e.g., packaging and food waste). The expected minimal waste quantities would not impact disposal capacities of area landfills and waste collection services. Diesel fuel used to operate the **emergency diesel** generator would be stored in an aboveground storage tank; the tank would be equipped with secondary containment to prevent spills.

Periodic injection well maintenance (or well workover) may result in the generation of wastes such as brine fluids and sand. Acid may be employed to remove scaling, in which case acid and scaling residue would be generated. The rigs used for well workover would also generate wastes including hydraulic fluids, rigwash, spent solvents, and used lubricating oil and filters. The frequency of workover operations would depend on data from well monitoring, but external mechanical integrity tests are planned at not less than 5-year intervals and workover activity would likely coincide with those activities. Solid waste materials would be transported in dump trucks and would be disposed in permitted landfills. The workover liquid waste would be collected and transported in vacuum tanker trucks and hauled to a wastewater treatment plant. The volume of waste material generated during a well workover would depend on pipe and equipment degradation. While the volume would vary greatly from well to well, it is expected that less than 40 liquid hauling trucks with capacities of up to 3,000 gallons each would be required for liquid wastes, and less than 20, 20-cubic yard roll-offs for solid wastes would be required for each workover. The volume and frequency of well workover waste generation would be low enough that impacts on waste treatment and disposal capacity in the region would be negligible. **The updated injection well design would likely result in a smaller amount of waste being generated as a result of injection well maintenance. However, DOE believes that the analysis of impacts presented in the Draft EIS is still valid, and has retained it as a conservative, upper-bound estimate of impacts resulting from injection well maintenance activities.**

The Alliance is reviewing a series of monitoring activities, which will be finalized in the MVA of the UIC Class VI permits. No waste would be generated from monitoring activities.

The **surface facilities at the** injection wells would contain equipment to supply the well with fluid to maintain annulus pressurization. No chemicals would be required to operate or maintain the well maintenance and monitoring system building, and no wastes would be generated.

Educational Facilities

Operation of the educational facilities would require minor amounts of materials for maintenance, and would result in the generation of primarily sanitary waste and solid waste (e.g., food containers and office trash) along with small amounts of hazardous and special wastes from facility operations and maintenance. Operation of the educational facilities would have negligible impacts to materials and waste management, since there is adequate access to required materials and to sanitary and hazardous waste disposal facilities in the Jacksonville area.

3.12.4 Impacts of the No Action Alternative

Under the no action alternative, DOE would not provide cost-shared funding for the FutureGen 2.0 Project. Although the Alliance may still elect to construct and operate the project in the absence of DOE cost-shared funding, for the purposes of the analysis in this EIS, DOE assumed that the no action alternative is equivalent to the no-build alternative. Therefore, the project would not be constructed and there would be no changes to material use and waste generation.

3.13 TRAFFIC AND TRANSPORTATION

3.13.1 Introduction

This section describes traffic and transportation systems potentially affected by the construction and operation of the FutureGen 2.0 Project and analyzes the potential direct and indirect effects from this project on these systems. This section discusses the existing roadways and other transportation infrastructure that would be used during construction and operation of the oxy-combustion facility, CO₂ pipeline, CO₂ injection wells, and educational facilities. This analysis focuses on the potential short- and long-term effects that may occur along existing maintained state and county roadways in the area. Specifically, it analyzes the ability of existing traffic and transportation infrastructure to meet the needs of the project while continuing to meet the needs of other users.

3.13.1.1 Region of Influence

The ROI for the transportation analysis consists of the primary roads most likely used for worker commute and delivery of materials. The ROI is easily accessible using different transportation modes, including roadways, rail, aircraft, and watercraft. Because the proposed project would primarily result in changes to roadway traffic, it is the main focus of the transportation resource section. The ROI includes the roadway network within 40 miles of the Meredosia Energy Center, along the pipeline corridor, and adjacent to the CO₂ storage study area. Since the proposed oxy-combustion facility, CO₂ pipeline, and CO₂ injection wells would be the focus of the transportation-based activities (e.g., vehicle traffic), indirect effects outside the ROI would be less than those described herein.

3.13.1.2 Method of Analysis and Factors Considered

Components of the project that would impact transportation resources include the number of personnel, as well as the volume of trucks transporting materials and wastes, during the construction and operation phases. The impact analysis was limited to major roadway segments leading to the project areas from nearby population centers (e.g., Jacksonville) as these would represent major transportation corridors for workers commuting to the site. The vehicular transport of materials and equipment is also expected to occur mainly on these roadways. DOE analyzed impacts on the roadway network within the ROI based on the following:

- Baseline traffic volumes and level of service (LOS);
- Geographic distribution of travel patterns of workers and truck transport of materials;
- No-build traffic volumes (i.e., projected future traffic volumes without the project); and
- Proposed project traffic volumes (i.e., “Build” scenario or projected future traffic volumes with the project).

DOE assessed the potential impacts on transportation resources based on whether the proposed project would:

- Substantially increase daily vehicular traffic on key roadway segments and thereby degrading the LOS to exceed traffic-handling capacity;
- Substantially increase daily barge traffic on the Illinois River to exceed capacity and interfere with other users; or
- Conflict with regional or local transportation improvement plans.

The number of vehicles that travel along a route in a 24-hour period is the average daily traffic, which is not adjusted for trucks or seasonal variations. The average annual daily traffic includes adjustments for seasonal, weekly, daily, and hourly variations and is calculated as the number of vehicles traveling along

a roadway in a year, divided by 365 days. For this project, the 2011 levels were obtained from IDOT. One-way peak hour volume is the number of vehicles using the primary travel lane during the busiest hour of the day, normally the morning or afternoon rush hour. The *Highway Capacity Manual* establishes a scale for the LOS of a road or intersection, which consists of six levels. This scale qualitatively measures the operational conditions within a traffic flow and the perception of these conditions by motorists. The six levels are given letter designations ranging from A to F, with “A” representing the best operating conditions (free flow, little delay) and “F” the worst (congestion, long delays). Various factors influence the operation of a roadway or intersection, including speed, delay, travel time, freedom to maneuver, traffic interruptions, comfort, convenience, and safety. LOS designations of A, B, or C are typically considered good operating conditions, in which motorists experience minor or tolerable delays. DOE used the highest average annual daily traffic, and subsequently the highest peak hourly traffic, for the road segments within the corridor to reflect worst-case baseline conditions.

DOE reviewed 2011 average annual daily traffic volumes obtained from the IDOT. DOE also estimated the number of vehicle trips generated during the peak construction period (2015) and first full year of operation (2017) based on project information provided by the Alliance and Ameren. This information included the anticipated total number of personnel during construction and operation, the projected truck volumes during construction and operation, and the proposed transport of feedstock and wastes that would occur at the Meredosia Energy Center during operation. Employee and truck traffic from the proposed project was distributed on roadways near the Meredosia Energy Center that would be affected by the FutureGen 2.0 Project. DOE used the volume-to-capacity ratio to determine the LOS of roadway segments in the ROI and to determine the level of effects. DOE assumed that the maximum one-way distance that a worker would drive is 40 miles, and the traffic distributed on roadways based on the population of each destination town.

To assess potential effects to the Illinois River, DOE compared the change in daily barge traffic during both construction and operation of the oxy-combustion facility and pipeline to existing conditions. Further, DOE assessed the ability of the existing water-base transportation infrastructure to accommodate the increased barge volume. An adverse effect would be created by any changes to barge traffic that would cause delays, exceed capacity along the waterways in the region, or affect other waterway traffic in the region. Since road and barges would be the primary modes of transportation, only a cursory review of air, rail, and public transit resources was performed.

3.13.2 Affected Environment

3.13.2.1 Regional and Local Roadway System

The ROI can be accessed from the north and south by I-55 from Chicago to Missouri, and from the east and west by I-70 and I-72 from Indiana to Missouri. The closest interstate is I-72, which is approximately 10 miles south of Meredosia. US-67 is the principal north-south highway serving western Illinois. IL-104 is the main regional route into Meredosia and to the energy center site. From IL-104, Washington Street and Old Naples Road provide direct access to Cips Drive, the main entrance to the Meredosia Energy Center. Historically, trucks accessing the energy center used a bypass road from IL-104 to access the energy center from the south and avoid traveling through residential areas of Meredosia. Other routes in the project area include IL-100, IL-125, IL-99, IL-123, IL-78, and IL-107, many of which cross US-67. Figure 3.13-1 presents a map of the primary roadways within 40 miles of the Meredosia Energy Center. Listed below are the functions and classifications of the major routes in the ROI:

- **US-67.** US-67 extends over 200 miles from I-280 at Rock Island to I-270 south of Alton. US-67 is predominately two lanes except from Macomb to Monmouth, and the Alton and Jacksonville Bypasses (IDOT 2002). IDOT is currently going through the process of improving this alignment along its entire length. Many sections of the corridor have been placed on IDOT’s multi-year program with the intent to develop it into a multilane divided highway configuration over most of its length. In May 2002, IDOT published the Final EIS for this project.

- **IL-104.** IL-104 is a two-lane roadway that connects with US-67 to the east of Meredosia and IL-99 to the west. IL-104 serves as Meredosia's main street through its business district, and crosses the Illinois River at the west end of the town. IDOT conducted an Environmental Assessment on the proposed infrastructure upgrades project from US-67 to IL-99 (Morgan and Pike counties), which includes plans to improve the Meredosia Bridge; in October 2011, IDOT published a Finding of No Significant Impact for its Environmental Assessment of the bridge project (IDOT 2011).
- **I-72/US-36.** I-72 is a four-lane roadway that travels from Indianapolis, Indiana to Kansas City, Missouri. It has served as a major interregional transportation route since 1919.
- **IL-100.** IL-100 is a two-lane roadway that originates near Alton and travels in a northerly direction to IL-136 near Havana. IL-100 is coterminous with US-67 between Meredosia and Beardstown.
- **IL-125.** IL-125 is a two-lane roadway that travels from Beardstown to Springfield.
- **IL-99.** IL-99 is a two-lane roadway traveling from IL-104 in Meredosia to Brooklyn. The IL-104/IL-99 link between US-67 and US-24 provides a shortcut for regional traffic between Jacksonville/Springfield and Quincy. IL-99 is also an alternate route to Rushville via US-24.
- **IL-107.** IL-107 is a two-lane roadway that connects Mount Sterling and Griggsville. IL-107 becomes US-54 as it traverses I-72 just north of Pittsfield.
- **IL-123.** IL-123 is a two-lane roadway that connects Ashland to I-72, which runs adjacent to the CO₂ storage study area.
- **IL-78.** IL-78 is a two-lane roadway that connects Virginia to Jacksonville and transects the pipeline corridor.

IDOT's proposed Highway Improvement Program lists the roadway improvements scheduled for years 2007-2012. Table 3.13-1 lists proposed improvements within the project area by route.

**Table 3.13-1. Illinois Department of Transportation
 Proposed Highway Improvement Near the Region of Influence**

Route	Location	Project Description
I-72/US-36	IL-100 to 0.5 mile west of Old US-36 west of Winchester	Resurfacing, bridge deck overlay, bridge joint repair, bridge raising
US-67/IL-100	Southeast of Rushville to 0.1 mile north of IL-100; 6.8 miles project	Resurfacing
US-67/IL-100	0.1 mile south of IL-125 in Beardstown to Morgan County line; 10.0-mile project	Resurfacing

Source: IDOT 2012a

I-# = Interstate; IL-# = Illinois Highway; US-# = U.S. Highway

3.13.2.2 Rail, Air, and Public Transportation

The Norfolk Southern Corporation has rail lines running between Bluffs and Meredosia before joining the main rail line, which connects Decatur, Illinois with Kansas City, Missouri. Primary products transported by rail include grain, granulated fertilizer, and potash (IDOT 2006; IDOT 2002). There are approximately 15 trains traveling along this rail segment each day. As stated in Section 2.4.1.4, the energy center previously had a rail spur for coal delivery, which has been removed. The closest Amtrak station providing passenger service is approximately 50 miles west of Meredosia in Quincy. This station has limited routes with service to Chicago. There is also a Springfield station approximately 60 miles east of

Meredosia with several connections, including high-speed rail service from St. Louis, Missouri to Dwight, Illinois (IDOT 2012c).

The Jacksonville Municipal Airport is located 18 miles east of the site and has 52 operations per day. The closest international airport is Lambert-St. Louis International approximately 70 miles south of the project area with an average of 512 daily operations. Within the project area, there are four smaller public airports and four private airstrips within 20 miles of the Meredosia Energy Center (FAA 2012).

None of the communities within the study area has a public transit (bus or rail) system. Jacksonville, Pittsfield, and Mount Sterling have bus service for seniors with limited service by appointment (West Central Mass Transit 2012).

3.13.2.3 Meredosia Energy Center

Existing Traffic and Level of Service

Table 3.13-2 lists the 2011 average annual daily traffic and estimated LOS for the primary roadway segments as presented in Figure 3.13-1, connecting population centers within 40 miles to the Meredosia Energy Center. As indicated by the average annual daily traffic levels, most of the roadways near the Meredosia Energy Center operate with little or no congestion due to the rural characteristic of the region and, consequently, operate within capacity (i.e., LOS C or better). Roadways estimated with LOS ratings of D are primarily roadways that travel through more urban areas, which are subject to higher traffic volumes during peak travel hours. Table 3.13-2 highlights the segments along each roadway with the highest traffic volume during peak periods. These roadways would operate at or better than these LOS on segments with lower traffic volumes, and during times other than peak traffic periods.

Historically, the majority of trucks accessing the Meredosia Energy Center were used to transport coal and fuel oil. The energy center used both bituminous coal from Illinois sources and Powder River Basin sub-bituminous coal from Wyoming. The bituminous coal was delivered by truck, while the Powder River Basin coal was delivered by barge. Although coal has been exclusively transported via barge over the past few years, prior to 2009 the annual number of trucks used to transport coal varied between 5,000 and 26,000. Approximately 8,000 trucks were used in 2008; the last year coal was delivered by truck. The number of trucks used to deliver fuel oil over the past several years ranged between 15 and 90 trucks per year. An average total of approximately 30 roundtrips per day were generated by the energy center in recent years. Trona **and hydrated lime** were not historically used at the Meredosia Energy Center. Ash disposal was conducted onsite and, therefore, did not generate any vehicle trips.

Separate barge unloading facilities at the Meredosia Energy Center are located on the Illinois River along the northwestern border of the Meredosia Energy Center site for Powder River Basin coal and for fuel oil deliveries. Historically, Powder River Basin coal was delivered by barge (from St. Louis, Missouri, where it was delivered from Wyoming via rail). Coal deliveries by barge over the past several years ranged from approximately 140 to 500 deliveries per year; annual fuel oil deliveries by barge were sparse, ranging from zero to two over the past several years. Water freight transport is an important part of the transportation system in the project area. The area from Beardstown to Naples on the Illinois River is an agri-business transportation center for west central Illinois. Truck traffic uses US-67 to reach these terminals to transfer shipments (IDOT 2002).

3.13.2.4 CO₂ Pipeline and CO₂ Storage Study Area

Existing Traffic and Level of Service

Table 3.13-3 lists primary state roadway segments within the pipeline corridor and adjacent to the CO₂ storage study area along with their average annual daily traffic and estimated LOS. As indicated by the average annual daily traffic levels, all roadway segments within the pipeline corridor and adjacent to the CO₂ storage study area operate with little or no congestion and within roadway capacity (i.e., LOS A or B). Table 3.13-3 highlights the segments along each roadway with the highest traffic volume during peak

periods. These roadways would operate at or better than these LOS on segments with lower traffic volumes, and during times other than peak traffic period.

Table 3.13-2. Level of Service on Roadway Segments Near the Meredosia Energy Center—Existing Conditions

Map ID	Roadway	Begins	Ends	2011 AADT ^a (vpd)	One-Way Peak Hour Volume (vph)	Volume-to-Capacity Ratio (V/C)	Level of Service (LOS)
Local							
1	Washington Street	Cips Lane	IL-104	1,400	151	0.09	A
Destinations to the West							
2	IL-104	Washington Street	IL-99	2,550	275	0.16	B
3	IL-99	IL-104	US-24	6,200	670	0.39	D
4	IL-104	IL-99	IL-107	2,250	243	0.14	B
5	IL-107	IL-104	I-72	3,200	346	0.20	B
6	US-54	I-72	IL-106	5,300	572	0.34	C
Destinations to the East							
7	IL-104	Green Street	US-67	4,150	448	0.26	C
8	US-67	IL-104	IL-125	2,250	243	0.14	B
9	US-67	IL-125	IL-24	4,050	437	0.26	C
10	US-67	US-67	IL-78	6,700	724	0.43	D
11	IL-104	US-67	I-72 Business	2,300	248	0.15	B
12	IL-267	US-78	US-36	9,500	1,026	0.60	D
13	IL-104	I-72 Business	IL-4	3,600	389	0.23	B
14 & 15	IL-106	IL-100	Old IL-36	1,550	167	0.10	A

^a. Source: IDOT 2012b

Note: Traffic volumes were obtained when the Meredosia Energy Center was not in operation.

AADT = average annual daily traffic; I-# = Interstate; IL-# = Illinois Highway; LOS = level of service; US-# = U.S. Highway; V/C = volume-to-capacity ratio; vpd = vehicles per day; vph = vehicles per hour

3.13.2.5 Educational Facilities

The Alliance anticipates that the visitor, **research, and training facilities** would be located in or near Jacksonville, Illinois. The Alliance is working with local stakeholders to identify the locations that would best serve the functions of these facilities. Because the locations of the educational facilities are unknown, DOE cannot characterize the existing environment specifically; however, roadways around Jacksonville are typical for a semi-urban setting, and are free flowing most of the day with some congestion during peak traffic periods. **As described in Sections 2.5.3 and 3.0, since the release of the Draft EIS, discussions between the Alliance and Jacksonville civic authorities have focused on a potential site in Jacksonville, but the specific locations of the educational facilities currently remain unknown.**

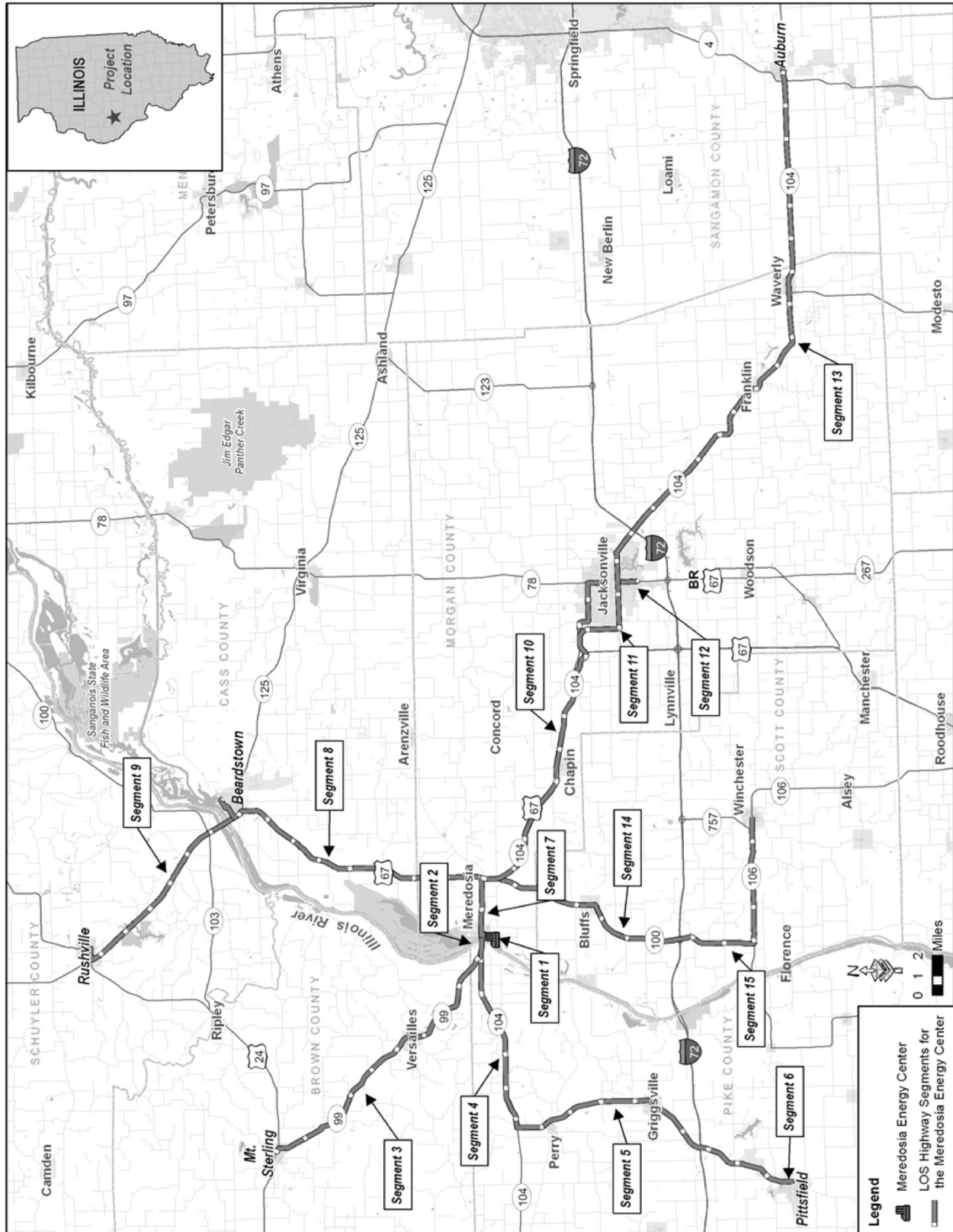

LOS = level of service

Figure 3.13-1. Primary Roadways within 40 Miles of the Meredosia Energy Center

Table 3.13-3. Roadways within the Pipeline Corridor and Adjacent to the CO₂ Storage Study Area

Road	AADT ^a [vpd]	One-Way Peak Hour Volume (vph)	Volume-to-Capacity Ratio (V/C)	Level of Service (LOS)
IL-104	2,550	275	0.16	B
US-67	3,100	335	0.20	B
IL-78	1,600	173	0.10	A
IL-100	1,600	173	0.10	A
IL-123 ^b	1,050	113	0.07	A

^a. Source: IDOT 2012b

^b. Roadway adjacent to the CO₂ storage area and educational facilities.

AADT = average annual daily traffic; CO₂ = carbon dioxide; IL-# = Illinois Highway; LOS = level of service; US-# = U.S. Highway; V/C = volume-to-capacity ratio; vpd = vehicles per day; vph = vehicles per hour

3.13.3 Impacts of Proposed Action

3.13.3.1 Construction Impacts

Meredosia Energy Center and CO₂ Pipeline

Construction at the Meredosia Energy Center and the CO₂ pipeline would have short-term minor adverse effects on transportation resources. Construction would cause temporary and localized congestion, particularly on roadways close to the facility. However, construction would be temporary, and all roadways in the area have the capacity for all traffic associated with the construction of the oxy-combustion facility and the pipeline. Additional barge traffic and offloading would have minor adverse effects.

All vehicles associated with the transportation of material and equipment to and from the site would comply with IDOT and the Federal Highway Administration (FHWA) weight and permitting regulations. Most trucks delivering equipment and supplies, including drilling equipment, would be less than 80,000 pounds gross vehicle weight with standard axle spacing; therefore, they would not be considered overweight by criteria outlined in either IDOT or federal regulations (625 ILCS 5 Chapter 15, Article 1; 23 CFR 658.17). However, depending on the exact nature of the delivery, some trucks may require an overweight permit, a non-divisible load permit, or both.

Traffic and Level of Service

As a reasonable worst-case scenario, DOE assumed that the peak construction year for both the Meredosia Energy Center and the pipeline would coincide in 2015, and all traffic would depart from and return to the Meredosia Energy Center and adjacent areas. Assuming that the construction of the pipeline would overlap with that of the oxy-combustion facility, the total traffic volumes used in the analysis were those from the Meredosia Energy Center and pipeline construction combined. As pipeline construction would move further away from the oxy-combustion facility, the effects would be less than those shown herein.

The number of construction and craft workers at the Meredosia Energy Center would range from 450 to 500 during peak construction activities. Construction of the oxy-combustion facility would occur six days per week between 2014 and 2017, and peak construction would occur between 2015 and 2016. During the peak of pipeline construction, there would be 300 workers who would generate 270 roundtrips per day assuming a 10 percent carpool rate. Pipeline construction trucks would generate approximately 53 roundtrips per day, which would be distributed throughout the workday. On average, there would be 150 pipeline construction workers who would generate 135 roundtrips per day assuming a 10 percent

carpool rate. Table 3.13-4 outlines the number of additional daily vehicles due to construction of the oxy-combustion facility and pipeline combined.

Table 3.13-4. Additional Daily Trips from Construction at the Meredosia Energy Center and CO₂ Pipeline

Activity	Estimated Additional Roundtrips [vpd] ^a		
	Worker Trips ^b	Truck Trips	Total
Meredosia Energy Center Construction	450	6	456
CO ₂ Pipeline Construction	270	53	323
Total	720	59	779

^a Estimation of trips due to the proposed project is based on the best available information. Small variations in the amount of trips may occur throughout the construction and operation of the project components.

^b Assumes a carpool rate of 10 percent.

CO₂ = carbon dioxide; vpd = vehicles per day

Table 3.13-5 lists the average annual daily traffic and estimated LOS with the construction traffic from the proposed energy center and pipeline for main roadways connecting to population centers within the ROI. Most roadways within the ROI would operate with little or no congestion (i.e., LOS A through C) during construction. Table 3.13-5 highlights the segments along each roadway with the highest traffic volume during peak periods. These roadways would operate at or better than these LOS on segments with lower traffic volumes, and during times other than peak traffic periods.

The pipeline would extend primarily throughout rural areas where the roadways are free flowing and well below design capacity. DOE performed a review of the roads that might be affected along the pipeline routes, and none of the major roads within the pipeline corridor are near capacity (i.e., very high average annual daily traffic levels or LOS D through F) (Table 3.13-3). All roadways in the pipeline corridor have the capacity for all construction traffic associated with the proposed project. As traffic would occur at different times and be distributed throughout the area, these effects would lessen on roadways further from the pipeline corridor. However, due to the limited number of worker trips during the peak of construction, these worker trips would have a minor adverse effect on transportation resources, particularly near the construction sites.

For comparison, Table 3.13-6 lists the estimated LOS for the existing (2011), no-build (2015), construction (2015), and operational conditions. Effects attributable to operations are discussed in Section 3.13.3.2. The LOS would degrade from LOS A to LOS B on Washington Street adjacent to the Meredosia Energy Center during peak construction at the energy center and the pipeline. Although traffic on Washington Street would increase by approximately 50 percent above current levels, it is estimated that the roadway would be able to handle the additional traffic. There may be some queuing at nearby intersections during peak traffic periods due to commuting workers. As traffic disperses, effects would lessen at roadways further from the construction site(s).

The LOS would remain unchanged at all other roadways analyzed with the proposed project when compared to future conditions without the proposed energy center and pipeline construction. Adding increases to background traffic from anticipated natural growth, the busiest portions of IL-267 would likely change from a LOS D to LOS E (i.e., from bad to worse) in the next few years, with or without the proposed project. Although IL-99, US-67, and IL-267 roadways would have LOS D or E under either the existing or the no build conditions, traffic associated with the proposed construction would not be sufficient to change the LOS on these roadways either initially or in the future. Although traffic conditions would be indistinguishable from those without the proposed project, the project would cause an incremental increase in traffic on these already congested roadways. These effects would be minor.

Table 3.13-5. Level of Service on Nearby Roadways - During Peak Construction (2015)

Map ID	Roadway	Begins	Ends	Existing 2011 AADT (vpd)	# of New Roundtrips per Day	AADT With Proposed Project (vpd)	Increase in AADT (percent)	One-Way Peak Hour Volume (vph)	Volume-to-Capacity Ratio (V/C)	Level of Service (2015) (LOS)
Local										
1	Washington Street	Cips Lane	IL-104	1,400	779	3,044	52	329	0.19	B
Destinations to the West										
2	IL-104	Washington Street	IL-99	2,550	107	2,920	4	315	0.19	B
3	IL-99	IL-104	US-24	6,200	35	6,650	1	718	0.42	D
4	IL-104	IL-99	IL-107	2,250	72	2,531	3	273	0.16	B
5	IL-107	IL-104	I-72	3,200	72	3,540	2	382	0.22	B
6	US-54	I-72	IL-106	5,300	67	5,758	1	622	0.37	C
Destinations to the East										
7	IL-104	Green Street	US-67	4,150	655	5,713	15	617	0.36	C
8	US-67	IL-104	IL-125	2,250	153	2,694	6	291	0.17	B
9	US-67	IL-125	IL-24	4,050	55	4,408	1	476	0.28	C
10	US-67	US-67	IL-78	6,700	456	8,023	6	866	0.51	D
11	IL-104	US-67	I-72 Business	2,300	133	2,707	5	292	0.17	B
12	IL-267	US-78	US-36	9,500	59	10,200	1	1102	0.65	E
13	IL-104	I-72 Business	IL-4	3,600	74	3,968	2	429	0.25	C
14	IL-106	IL-100	Old IL-36	1,550	45	1,735	3	187	0.11	A

AADT = average annual daily traffic; I-# = Interstate; IL-# = Illinois Highway; LOS = level of service; US-# = U.S. Highway; V/C = volume-to-capacity ratio; vpd = vehicles per day; vph = vehicles per hour

Table 3.13-6. Comparison of Level of Service on Nearby Roadways

Map ID	Roadway	Begins	Ends	Level of Service			Operations
				Existing (2011)	No Build (2015)	Peak Construction (2015)	
Local							
1	Washington Street	Cips Lane	IL-104	A	A	B	A
Destinations to the West							
2	IL-104	Washington Street	IL-99	B	B	B	B
3	IL-99	IL-104	US-24	D	D	D	D
4	IL-104	IL-99	IL-107	B	B	B	B
5	IL-107	IL-104	I-72	B	B	B	B
6	US-54	I-72	IL-106	C	C	C	C
Destinations to the East							
7	IL-104	Green Street	US-67	C	C	C	C
8	US-67	IL-104	IL-125	B	B	B	B
9	US-67	IL-125	IL-24	C	C	C	C
10	US-67	US-67	IL-78	D	D	D	D
11	IL-104	US-67	I-72 Business	B	B	B	B
12	IL-267	US-78	US-36	D	E	E	E
13	IL-104	I-72 Business	IL-4	B	C	C	C
14	IL-106	IL-100	Old IL-36	A	A	A	A

I-# = Interstate; IL-# = Illinois Highway; US-# = U.S. Highway

Trenching and pipe-laying activities would cause temporary increases in traffic near the construction areas. At certain locations where traffic or road-use restrictions would affect the construction schedule, construction would proceed during late evening hours. Equipment would not be fixed in one location for long durations but would progress along the construction ROW. Trenching and pipe-laying related traffic would be temporary and would subside at any particular location as construction progresses to subsequent segments of the pipeline. Parking may be a concern among some portions of the pipeline corridor. However, adverse parking conditions would subside at any particular location as construction progresses to subsequent segments of the pipeline and would end upon its completion.

Barge Traffic

The Alliance plans to use the existing public boat ramp area located southwest of Meredosia (and north of the Meredosia Energy Center) to unload large modules for the oxy-combustion facility (see Figure 2-14 and Figure 2-15). The existing boat ramp area is owned by the village of Meredosia. Additional phases of project engineering and coordination with the village of Meredosia would determine accessibility decisions. It is anticipated that any changes to the boat ramp area would be temporary and would be for barge unloading only. Twelve barge deliveries are expected during the construction phase to deliver equipment (see Section 2.4.3.4). Because the number of barge deliveries would be relatively low, the added barge volume is not expected to exceed the capacity of the Illinois River or interfere with other local uses. These effects would be minor.

Rail, Air, and Public Transportation

Construction of the oxy-combustion facility at the Meredosia Energy Center, the CO₂ pipeline, injection wells, and educational facilities would not change the operations for any airports, rail segments, or public transportation facilities.

CO₂ Storage Study Area

Construction within the CO₂ storage study area would have short-term minor adverse effects. Construction at the well sites could cause temporary and localized congestion, particularly where access roads intersect county and state roadways. However, due to the limited work force, delays to traffic would be minor.

Drilling activities would cause temporary increases in traffic near each of the well sites. Construction is estimated to last 100 to 120 days of drilling per injection well, and between 3 and 100 days for the monitoring wells depending on depth. Once drilling is initiated, drilling would generally occur 24 hours per day, 7 days per week. The schedule would consist of two 12-hour shifts with 14 construction workers each shift, generating a total of 28 roundtrips per day. Construction and delivery trucks would generate an additional 12 roundtrips per day, which would be distributed throughout the workday.

Construction of the surface facilities at the injection wells would take less than a year to complete and require approximately 41 construction workers, generating 82 roundtrips per day **for the dual-site scenario analyzed in the Draft EIS and no longer under consideration by the Alliance. The updated single-site scenario currently proposed by the Alliance would require approximately 21 construction workers.**

The CO₂ storage study area is a rural area where the roadways are free flowing and well below design capacity. DOE completed a review of the roads that might be affected by the injection well site(s), and none is near capacity (i.e., none has very high average annual daily traffic levels or LOS D through F) (Table 3.13-3). All roadways within and adjacent to the CO₂ storage study area have the capacity for all construction traffic associated with the proposed project. As traffic would occur at different times and be distributed throughout the area, these effects would lessen on roadways further from the CO₂ injection well site(s). Due to the limited number of worker trips during the development of the CO₂ injection well site(s), these worker trips would have a negligible adverse effect on transportation resources. Additionally, truck trips would be distributed throughout the day and not be focused during the peak traffic hour; therefore, truck traffic at the CO₂ storage study area would have a negligible adverse effect on transportation resources.

Educational Facilities

Construction of the educational facilities would have short-term minor adverse effects. Construction would cause temporary and localized congestion, particularly where access roads to the construction sites intersect county and state roadways. However, due to the limited workforce, delays to traffic would be minor. Construction of the educational facilities is estimated to last 52 weeks, and would likely occur in or near Jacksonville, away from the Meredosia Energy Center, CO₂ pipeline corridor, and CO₂ storage study area. The schedule would primarily be limited to daytime hours, and staff would consist of approximately 70 to 80 construction workers generating one roundtrip per day each **for the two-building scenario. The updated one-building scenario would require approximately 47 design and construction employees.** There would be a limited number (i.e., two per day) of delivery trucks throughout the workday.

The traffic associated with the construction of the educational facilities would be substantially less than that associated with the construction of the oxy-combustion facility and pipeline. The nature of effects would be similar to, but somewhat less than, those outlined for the construction of the oxy-combustion facility and CO₂ pipeline. It is unlikely that construction of these facilities would overlap appreciably

with that of the pipeline and injection well site(s) as it would occur towards the end of the total construction period. Therefore, these effects would be short term and minor.

3.13.3.2 Operational Impacts

Meredosia Energy Center

Operation of the oxy-combustion facility at the Meredosia Energy Center would have long-term minor adverse effects on transportation resources resulting from increased truck traffic transporting feedstock and waste. Operation would cause long-term but localized congestion, particularly on roadways close to the facility. Minor adverse effects due to additional barge traffic transporting coal would be expected. However, all roadways and waterways in the area would have the capacity for all traffic associated with operations.

Traffic and Level of Service

Operation of the oxy-combustion facility at the energy center is scheduled to begin in 2017. The primary vehicles that would contribute to additional daily traffic are trucks transporting feedstock (mainly coal and **hydrated lime**) and removing wastes (mainly fly ash and bottom ash) (for details on the transportation of materials and wastes to and from the energy center see Sections 2.4.4.1 and 2.4.4.2). The number of daily vehicles from the operation of the oxy-combustion facility at the energy center is outlined in Table 3.13-7. This would be in addition to existing traffic. As indicated in the table, the volume of additional truck traffic would total approximately 88 daily roundtrips. This represents almost 50 additional roundtrips per day when compared to historic truck traffic volumes. For analysis purposes, employee and truck traffic from operations at the energy center was distributed on roadways near the energy center (see Figure 3.13-1).

Table 3.13-7. Daily Trips from Operations

Activity	Estimated Roundtrips (vpd) ^a		
	Worker Trips ^b	Truck Trips	Total
Operation of the Meredosia Energy Center	105	88 ^c	131

^a. Estimation of trips due to the proposed project is based on the best available information. Small variations in the amount of trips may occur throughout the construction and operation of the project components.

^b. Assumes a carpool rate of 10 percent.

^c. **Since publication of the Draft EIS, the Alliance updated the project design. Under the current design, truck traffic is expected to decrease to 77 vehicles per day, which is within the conditions analyzed in this section.**

vpd = vehicles per day

Table 3.13-8 lists the 2011 average annual daily traffic and estimated LOS with the operational traffic from the proposed energy center facilities for roadways connecting to population centers within 40 miles of the Meredosia Energy Center. Most roadways within the area would operate with little or no congestion (i.e., LOS A through C). Roadways that would have LOS ratings of D or E are primarily roadways that travel through more urban areas, which are subject to higher traffic volumes during peak travel hours. Table 3.13-8 highlights the segments along each roadway with the highest traffic volumes during peak period. These roadways would operate at or better than these LOS on segments with lower traffic volumes and during times other than the peak traffic period.

Table 3.13-8. Estimated Level of Service on Nearby Roadways during Meredosia Energy Center Operation (2017)

Map ID	Roadway	Begins	Ends	Existing AADT (2011) (vpd)	# of New Roundtrips per Day	AADT With Proposed Project (vpd)	Increase in AADT (percent)	One-Way Peak Hour Volume (vph)	Volume-to-Capacity Ratio (V/C)	Level of Service (2017) (LOS)
Local										
1	Washington Street	Cips Lane	IL-104	1,400	131	1,748	9	189	0.11	A
Destinations to the West										
2	IL-104	Washington Street	IL-99	2,550	18	2,742	1	296	0.17	B
3	IL-99	IL-104	US-24	6,200	6	6,591	0	712	0.42	D
4	IL-104	IL-99	IL-107	2,250	12	2,412	1	260	0.15	B
5	IL-107	IL-104	I-72	3,200	12	3,420	0	369	0.22	B
6	US-54	I-72	IL-106	5,300	67	5,758	1	622	0.37	C
Destinations to the East										
7	IL-104	Green Street	US-67	4,150	110	4,624	3	499	0.29	C
8	US-67	IL-104	IL-125	2,250	26	2,439	1	263	0.15	B
9	US-67	IL-125	IL-24	4,050	9	4,316	0	466	0.27	C
10	US-67	US-67	IL-78	6,700	77	7,264	1	784	0.46	D
11	IL-104	US-67	I-72 Business	2,300	22	2,486	1	268	0.16	B
12	IL-267	US-78	US-36	9,500	10	10,101	0	1091	0.64	E
13	IL-104	I-72 Business	IL-4	3,600	12	3,845	0	415	0.24	C
14	IL-106	IL-100	Old IL-36	1,550	8	1,660	0	179	0.11	A

AADT = average annual daily traffic; I-# = Interstate; IL-# = Illinois Highway; LOS = level of service; US-# = U.S. Highway; V/C = volume-to-capacity ratio; vpd = vehicles per day; vph = vehicles per hour

For comparison, Table 3.13-6 (see previous) lists the estimated LOS for the existing (2011), no-build (2015), construction (2015), and operational conditions. After construction ends, the conditions on Washington Street would return to LOS A. Although the roadway would operate at LOS A, there may be some queuing at nearby intersections during peak traffic periods. Adding increases to background traffic from anticipated natural growth, the busiest portions of IL-267 would likely change from LOS D to LOS E in the next few years with or without the proposed project. Although IL-99, US-67, and IL-267 roadways have LOS D or E under either the existing or the no-build conditions, traffic associated with the operation of the oxy-combustion facility at the Meredosia Energy Center would not be sufficient to change LOS on these roadways either initially or in the future.

Although traffic conditions would be indistinguishable from those without the FutureGen 2.0 Project, the project would constitute an incremental increase in traffic on these already congested roadways. Additionally, trucks transporting materials and wastes would be routed around the village of Meredosia by accessing the bypass road into the proposed facility. Therefore, impacts during operations are expected to be long term and minor.

Barge Traffic

The project design analyzed in the Draft EIS anticipated that Powder River Basin sub-bituminous coal would be the only material delivered by barge, which would require approximately 180 barge trips per year. Based on ongoing refinements in the project design since the release of the Draft EIS, the Alliance may decide to have the Illinois No. 6 bituminous coal and the Powder River Basin coal blended by an existing commercial coal handling facility in St. Louis, Missouri, with the entire volume delivered by barge. The barge would be unloaded via an existing unloading facility at the energy center. If elected, this option would require approximately 451 barge deliveries per year to transport blended coal to the energy center (see Section 2.4.4.1), resulting in one to two barge deliveries on a daily basis. Historically, the number of annual barge deliveries ranged between 140 and 500 over the past several years. Therefore, waterway capacity would be sufficient for the operation of the facility, and impacts are expected to be negligible.

Rail, Air, and Public Transportation

Operation of the oxy-combustion facility at the Meredosia Energy Center, the CO₂ pipeline, injection wells, and educational facilities would not change the operations for any airports, rail segments, or public transportation facilities.

CO₂ Pipeline

Operation and maintenance of the CO₂ pipeline would have negligible adverse effects. Pipeline patrolling would be by road, foot, and helicopter, contracted to specialist companies. These visual surveys would be conducted every two weeks and would look for signs of leaks and potential infrastructure concerns. The activities would be sparse and would extend primarily throughout rural areas where the roadways are free flowing and well below designed capacity. DOE reviewed the roads that might be affected, and none of the major roads within the pipeline corridor is near capacity (i.e., none has very high average annual daily traffic or LOS D through F) (Table 3.13-3). All would be able to handle the limited additional traffic from operation and maintenance activities. Traffic associated with operation and maintenance of the CO₂ pipeline would constitute less than 1 percent of the total traffic on any roadway in the pipeline corridor. Therefore, these activities would have long-term negligible adverse effects.

CO₂ Storage Study Area

Operation of the CO₂ injection well site(s) would have long-term negligible adverse effects. The operations phase, with active injection and monitoring, would begin in 2017, and end in 2022; however, commercial operations could continue beyond this period. The post-injection monitoring phase would begin in 2022 and continue in accordance with the UIC permits. **Under the dual-site scenario analyzed in the Draft EIS, approximately 20 employees would work at the surface facilities at the injection**

wells on a daily basis during normal shifts. **The updated single-site design currently proposed by the Alliance would require up to 15 operational employees at the surface facilities.** In addition, there would be two staff personnel (3 shifts per day, 7 days per week) onsite managing and monitoring pipeline operations and continually monitoring injection operations. All of these activities would cause some amount of traffic. In addition, the truck traffic from well maintenance would consist of approximately 20 vehicles associated with the maintenance rig, and there would be less than 40 liquid hauling trucks and up to 20, 20-yard roll-off dumpsters for each maintenance operation, **as analyzed in the Draft EIS for the dual-site scenario. It is anticipated that the current single-site scenario would require less than 20 liquid hauling trucks and 10 roll-offs for each workover.** Periodic well maintenance would involve actions to ensure proper functioning of the wells, and could include replacing and repairing tubing, packer, valves and sensors, repairing corroded casing, and remedial cementing.

These activities would be infrequent and extend primarily throughout rural areas where the roadways are free flowing and well below designed capacity. Traffic at the CO₂ injection well site(s) would constitute less than 1 percent of the total traffic on adjacent roadways. All roadways adjacent to the storage study area would have the capacity for all traffic associated with the operation of the CO₂ injection well site(s). These effects would be negligible.

If necessary, pull-offs would be installed and other upgrades would be provided to roads accessing the injection wells, to further reduce traffic congestion in the area. All local and IDOT requirements would be met for design and construction of pull-offs or other improvements to existing roadways within the CO₂ storage study area.

Educational Facilities

Operation of the educational facilities would have long-term negligible adverse effects. **For the two-building design analyzed in the Draft EIS,** the visitor and research center would be open 6 days per week for 9 hours per day and would employ 7 full-time employees, and approximately 10 outside researchers could be accommodated at a time. There would be between 10,000 and 20,000 annual visitors with a significant percentage being local students arriving in buses. This would equate to approximately 20 cars and/or 1 bus per day. The training facility would be open 12 hours per day, 6 days per week and would employ 15 full-time staff. **The updated one-building design would locate the visitor, research, and training facility at one building and would involve visitors, researchers, and operational personnel that would be similar to the two-building design analyzed in the Draft EIS.** All of these activities would cause some amount of traffic. However, traffic at the educational facilities would constitute less than 1 percent of the total traffic on any individual roadway in the area. The nature of effects would be similar to, but substantially less than, those outlined for the operation of the oxy-combustion facility, pipeline, or CO₂ injection wells. These effects would be negligible.

3.13.4 Impacts of the No Action Alternative

Under the no action alternative, DOE would not provide cost-shared funding for the FutureGen 2.0 Project. Although the Alliance may still elect to construct and operate the project in the absence of DOE cost-shared funding, for the purposes of the analysis in this EIS, DOE assumed the no action alternative is equivalent to the no-build alternative. Therefore, the project would not be constructed and there would be no change to transportation systems.

INTENTIONALLY LEFT BLANK

3.14 NOISE AND VIBRATION

3.14.1 Introduction

This section describes techniques used to analyze noise and vibration, and identifies current levels in the vicinity of the proposed project locations. This section also analyzes potential noise and vibration impacts on local receptors resulting from the construction and operation of the FutureGen 2.0 Project.

3.14.1.1 Region of Influence

The ROI for the noise environment of the FutureGen 2.0 Project was based on the estimated magnitude of noise generated by the project and baseline noise levels, which would affect how far away the noise might be heard. The ROI includes the areas within 0.5 mile (2,640 feet) of the Meredosia Energy Center, within 1,000 feet of the construction equipment and new stationary sources related to the pipeline and injection wells, and areas through which project-related vehicular traffic would pass (Cowan 1994).

3.14.1.2 Method of Analysis and Factors Considered

DOE analyzed noise levels generated by stationary and mobile sources for potential impacts to sensitive noise receptors. Noise levels were calculated based on widely-accepted noise principles and references, as described in this section. DOE assessed the potential for impacts to sensitive receptors based on whether the oxy-combustion facility, CO₂ pipeline, CO₂ injection wells, and educational facilities would:

- Conflict with any state or local noise ordinances;
- Cause perceptible increases in ambient noise levels at sensitive receptors during construction of the oxy-combustion facility, proposed pipeline and ROW, injection wells, and educational facilities—from either mobile or stationary sources;
- Cause long-term perceptible increases in ambient noise levels at sensitive receptors during operation of the proposed oxy-combustion facility, pipeline and ROW, injection wells, and educational facilities—from either mobile or stationary sources; or
- Cause excessive ground-borne vibration to persons or property.

Noise Principles

Noise is defined as any unwanted sound. The human ear experiences sound as a result of pressure variations in the air. The physical intensity or loudness level of noise sources is expressed quantitatively as the sound pressure level. Sound pressure levels are defined in terms of decibels (dB), which are measured on a logarithmic scale. Sound can be quantified in terms of its amplitude (loudness) and frequency (pitch). Frequency is measured in hertz, which is the number of cycles per second. The typical human ear can hear frequencies ranging from approximately 20 hertz to 20,000 hertz. Typically, the human ear is most sensitive to sounds in the middle frequencies (1,000 to 8,000 hertz) and is less sensitive to sounds in the low and high frequencies. Since the human ear cannot perceive all pitches or frequencies equally, measured noise levels in dB will not reflect the actual human perception of the loudness of the noise. Thus, the sound measures can be adjusted or weighted to correspond to a scale appropriate for human hearing. This adjusted scale, known as the A-weighted sound level in decibels (dBA), is useful for gauging and comparing the subjective loudness of sounds to humans. As shown in Table 3.14-1, the threshold of perception of the human ear is approximately 3 dB, a 5-dB change is considered to be clearly noticeable to the ear, and a 10-dB change is perceived as an approximate doubling (or halving) of the noise level (MPCA 1999). Sounds encountered in daily life and their approximate levels in dBA are provided in Table 3.14-2.

Table 3.14-1. Perceived Change in Decibel Level

Change in Sound Level	Perceived Change to the Human Ear
± 1 dB	Not perceptible
± 3 dB	Threshold of perception
± 5 dB	Clearly noticeable
± 10 dB	Twice (or half) as loud
± 20 dB	Fourfold (4x) change

Source: MPCA 1999
 dB = decibel

Table 3.14-2. Sound Level and Loudness of Typical Noises

Noise Level (dBA)	Description	Typical Sources
140	Threshold of pain	---
125	Uncomfortably Loud	Automobile assembly line
120	Uncomfortably Loud	Jet aircraft
100	Very Loud	Diesel truck
80	Moderately Loud	Motor bus
60	Moderate	Low conversation
40	Quiet	Quiet room
20	Very Quiet	Leaves rustling

Source: Liu and Lipták 1997
 dBA = A-weighted sound level in decibels

Ambient or background noise is a combination of various sources heard simultaneously. Noise levels for combinations of sounds are not combined by simple addition, but instead are based on the logarithmic scale (HUD 1985). As a result, the addition of two noises, such as a garbage truck (100 dBA) and a lawn mower (95 dBA), would result in a cumulative sound level of 101.2 dBA, not 195 dBA.

Noise levels decrease (attenuate) with distance from the source. The decrease in sound level from any single noise source normally follows the “inverse square law.” That is, the sound level change is inversely proportional to the square distance from the sound source. A generally accepted rule is that the sound level from a stationary source would drop approximately 6 dB each time the distance from the sound source is doubled. Sound level from a moving “line” source (e.g., a train or a roadway) would drop 3 dB each time the distance from the source is doubled. Noise levels may be further reduced by natural factors such as temperature and climate and are reduced by barriers, both man-made (e.g., sound walls) and natural (e.g., forested areas, hills, etc.) (FTA 2006).

The dBA noise metric describes steady noise levels; however, very few noises are, in fact, constant. Therefore, a noise metric, equivalent sound level (L_{eq}), has been developed. L_{eq} represents the average sound energy over a given period presented in dB.

There are a variety of measures used to describe the noise environment that take into account changes in noise levels over time, the time of day the noise is occurring, as well as the percentage of time noise is at a particular level. For example, $L_{eq}(h)$ is the equivalent sound level over 1 hour, day-night sound level (L_{dn} or DNL) is the 24-hour L_{eq} but with a 10 dB penalty added to nighttime noise levels (10 p.m. to

7 a.m.) to reflect the greater intrusiveness of noise experienced during this time, and L₅₀ and L₉₀ represent the levels exceeded 50 or 90 percent of the time, respectively.

Stationary Noise Sources

Stationary noise sources include construction-related equipment and any noise-generating equipment used for normal operations. DOE estimated potential noise levels at sensitive receptor locations resulting from stationary sources during construction and normal operations by identifying sound levels from dominant noise-producing equipment, summing anticipated equipment noise contributions, and applying fundamental noise attenuation principles (FTA 2006; Lamancusa 2009).

DOE did not consider the effects of meteorology, terrain, vegetation, or structures that can affect sound propagation (i.e., reduce sound levels) as these would be highly variable for each receptor location. Therefore, the results presented may be conservatively higher predictions of noise impacts. However, in the case of the injection well drill rigs, the mitigating principals of a noise-mitigation berm are discussed.

Mobile Noise Sources (Traffic Noise)

Mobile noise sources include light-duty vehicles (i.e., cars, pickup trucks, and sport utility vehicles), medium trucks (i.e., 2-axle, 6-wheel trucks), and heavy trucks (i.e., 3 or more axles) transporting workers and materials and wastes during the construction and operational phases. The level of highway traffic noise depends on numerous factors. Generally, the loudness of traffic noise is increased by heavier traffic volumes, inclined roads, higher speeds, and greater numbers of trucks. In addition, there are other, more complicated factors that affect the loudness or attenuation of traffic noise, such as distance, terrain, vegetation, and natural and man-made obstacles.

3.14.1.3 Regulatory Framework

Noise Regulatory Framework

In 1974, the USEPA provided information suggesting that continuous and long-term noise levels in excess of L_{dn} 65 dBA are normally unacceptable for noise-sensitive land uses such as residences, schools, churches, and hospitals (USEPA 1974). Similarly, the U.S. Department of Housing and Urban Development (HUD) established 65 dBA as a threshold for unacceptable noise levels for residential areas. HUD’s guidelines, shown in Table 3.14-3, categorize noise levels for proposed residential development as acceptable, normally unacceptable, and unacceptable (HUD 1985).

Table 3.14-3. U.S. Department of Housing and Urban Development Guidelines for Evaluating Sound Level Impacts on Residential Properties

Acceptability for Residential Use	Outdoor Guideline Levels
Acceptable	≤ 65 dBA
Normally Unacceptable	> 65 dBA to ≤ 75 dBA
Unacceptable	> 75 dBA

Source: HUD 1985
 dBA = A-weighted sound level in decibels

Construction activities on this project are not governed by either federal or state regulations; however, there are Illinois noise level standards pertaining to operational activities. The applicable IEPA regulations are set forth by the Illinois Pollution Control Board as noise limits for commercial and industrial noise sources and provide guidance for assessing compliance. The regulations are defined in the 35 IAC, Subtitle H, Chapter I, 901 *Sound Emissions Standards and Limitations for Property-Line Noise-Sources* (IPCB 2007). The IAC specifically lists the limits that different classifications of land can allowably experience based upon their land use. The three land classes are defined as follows:

- IAC Class A properties (residences) are considered the most sensitive property use.

- IAC Class B properties (businesses and services) are considered of mixed use.
- IAC Class C properties (utilities, manufacturing, industrial, and agricultural) are considered the least sensitive.

The Meredosia Energy Center is defined as Class C. The pipeline corridor passes through areas defined as Class A, Class B, and Class C. The injection well site(s) are considered Class C properties.

Noise is broken down into specific frequency bands (octave bands) that characterize the nature of the sound and identify which frequencies contain the most energy. Regulatory limits are established for each octave band. Furthermore, limits are established for both daytime and nighttime, with nighttime being more restrictive than daytime.

Table 3.14-4 presents the un-weighted dB permissible sound levels during day and nighttimes for sound emanating from a Class C land (the Meredosia Energy Center and the CO₂ injection well site(s)) to a receiving Class A land (nearby residential neighborhoods). Emanating sound levels at a residence are considered to be in compliance if they are below the regulatory thresholds for the frequencies listed in this table. There are no limits set for sound emanating from a Class C land onto a receiving Class C land. Per the Illinois Pollution Control Board Section 901.107, the permissible sound levels do not apply to equipment being used for construction.

Table 3.14-4. Permissible Sound Levels for Class C Land to Class A Land

Octave Band Center Frequency (hertz)	Daytime Sound Level ^a (decibel)	Nighttime Sound ^a Level (decibel)
31.5	75	69
63	74	67
125	69	62
250	64	54
500	58	47
1,000	52	41
2,000	47	36
4,000	43	32
8,000	40	32

Source: IPCB 2007

^a The Illinois Pollution Control Board states that no measurement of sound pressure levels shall be made less than 25 feet from a property-line-noise-source.

For assessment of traffic noise impacts the FHWA and IDOT use the L_{eq}(h) descriptor to estimate the degree of nuisance or annoyance arising from changes in traffic noise. IDOT and FHWA established noise abatement criteria (NAC) that provide a benchmark to assess the level at which noise becomes a clear source of annoyance for different land uses (see Table 3.14-5) (FHWA 1995). Category B, which represents moderately sensitive land uses, best describes the majority of the receptors around the energy center, along the pipeline corridor, and within the storage study area. The NAC for residential use (category B) is 67 dBA. As defined in the IDOT and FHWA noise abatement policies, traffic noise effects can occur under two separate conditions: (1) when noise levels are unacceptably high, or (2) when a proposed highway project would substantially increase the existing noise environment. Specifically, a traffic noise effect occurs when the predicted levels equal or approach the NAC (e.g., greater than 66 dBA for category B), or when predicted traffic noise levels exceed the existing noise levels by greater than 10

dba. The level of impact (i.e., negligible, minor, moderate, or significant) is determined on the basis of the total number of receptors affected, and the relative increase in noise for identified receptors.

Table 3.14-5. Noise Abatement Criteria

Activity Category	Description of Activity Category	NAC L _{eq} (h)
A	Land for which serenity and quiet are of extraordinary significance and serve an important public need, and where the preservation of those qualities is essential if the area is to continue to serve its intended purpose	57 (exterior)
B	Picnic areas, recreation areas, playgrounds, active sports areas, parks, residences, motels, hotels, schools, churches, libraries, and hospitals	67 (exterior)
C	Developed lands, properties, or activities not included in categories A or B	72 (exterior)
D	Undeveloped lands	NA
E	Residences, motels, hotels, public meeting rooms, schools, churches, libraries, hospitals, and auditoriums	52 (interior)

Sources: 23 CFR 772; FHWA 2006

L_{eq}(h) = equivalent sound level over 1 hour; NA = not applicable; NAC = noise abatement criteria

Vibration Principles and Regulatory Framework

Vibration refers to the oscillations or rapid linear motion of parts of a fluid or elastic solid whose equilibrium has been disturbed. Vibration can be caused by operating heavy farm or construction machinery, ground-breaking construction activities (e.g., drilling or excavating), trains on railways, operating equipment indoors, or slamming doors. Similar to noise, the sensitive receptors to outdoor vibrations include nearby residences, schools, hospitals, nursing home facilities, and recreational areas. Typically, the effects of vibration range from feeling the floor shake and rumbling sounds to minor structural damage. Vibration is often expressed in terms of the peak particle velocity, as inches per second or millimeters per second, when used to evaluate human annoyance and building damage impacts.

There are no federal standards for vibrations, however, various researchers and organizations have published guidelines. Table 3.14-6 presents guidelines to assess human perception and annoyance, and Table 3.14-7 presents guidelines for vibration damage to buildings.

Table 3.14-6. Guidelines for Potential Vibration Annoyance

Human Response	Maximum PPV (inches/second) ^a	
	Transient Sources	Continuous/Frequent/Intermittent Sources
Barely perceptible	0.04	0.01
Distinctly perceptible	0.25	0.04
Strongly perceptible	0.9	0.10
Severe	2.0	0.4

Source: Jones and Stokes 2004

^a. Transient sources create a single isolated vibration event, such as blasting or drop balls. Continuous/frequent/intermittent sources include impact pile drivers, pogo-stick compactors, crack-and-seat equipment, vibratory pile drivers, and vibratory compaction equipment. DOE assumes that trenchless boring operations would be categorized as continuous/frequent/intermittent sources.

PPV = peak particle velocity

Table 3.14-7. Thresholds for Potential Vibration Damage

Structure and Condition	Maximum PPV (inches/second) ^a	
	Transient Sources	Continuous/Frequent/ Intermittent Sources
Extremely fragile historic buildings, ruins, ancient monuments	0.12	0.08
Fragile buildings	0.2	0.4
Historic and some old buildings	0.5	0.25
Older residential structures	0.5	0.3
New residential structures	1.0	0.5
Modern industrial/commercial buildings	2.0	0.5

Source: Jones and Stokes 2004

^a Transient sources create a single isolated vibration event, such as blasting or drop balls. Continuous/frequent/intermittent sources include impact pile drivers, pogo-stick compactors, crack-and-seat equipment, vibratory pile drivers, and vibratory compaction equipment. DOE assumes that trenchless boring operations would be categorized as continuous/frequent/intermittent sources.

PPV = peak particle velocity

The DOT Federal Transit Administration (FTA) published guidelines to perform vibration impact assessments for proposed projects that may involve transit activities. The methodology applies a screening approach based on the distance between sensitive receptors and the source of vibration. According to the FTA, if the distance between source and receptor is greater than 200 feet, it is reasonable to conclude that no further analysis of vibration impacts is necessary (FTA 2006).

3.14.2 Affected Environment

3.14.2.1 Meredosia Energy Center

As shown in Figure 3.14-1, the Meredosia Energy Center property and surrounding areas are predominantly classified as IAC Classes A, B, and C. The nearest Class A land is the residential area of Meredosia to the north and east of the proposed facility. The land designated as Class B, found mainly to the north of the energy center property, includes warehouses, general sales or services, the boat launch and recreational areas, the campground, and a potentially historic train depot. Class C land found in the project area includes the roadways, unused railroad ROW, agricultural land, and manufacturing facilities to the east and south of the energy center. Also, the Meredosia Energy Center itself and properties in Pike County located to the west (across the Illinois River) are consistent with Class C land. The Meredosia Energy Center can be characterized as a developed, industrial site.

Existing dominant noise sources in the vicinity of the Meredosia Energy Center mainly consist of equipment and vehicle noise related to the operations of the energy center; noise associated with the adjacent grain elevator operations at the Cargill facility located to the north of the energy center site; vehicular traffic on Old Naples Road, South Washington Street, and IL-104; and rail traffic on the Norfolk Southern rail line providing access to the industrial sites to the south of the Meredosia Energy Center.

Figure 3.14-1 presents the class designations of the properties to the north and east of the energy center. The Meredosia Energy Center site is currently a Class C property. Residences primarily to the east and north of the energy center are considered as Class A. The properties to the south and to the west (across the river) are industrial and thus Class C.



Figure 3.14-1. Noise Class Designations for Properties Adjacent to Meredosia Energy Center

There are 137 residences within 0.5 mile of the project site. These residences are located to the north and east of the site, primarily within the boundary of the village of Meredosia. No other sensitive receptors (schools or hospitals) have been identified within 0.5 mile of the energy center. There are two schools (the Meredosia-Chambersburg Elementary and High School) 0.5 to 1 mile to the northeast of the site (Beacon 2011), but no hospitals in the general vicinity. The two schools are within 500 feet of IL-104, a major transportation access route.

DOE measured sound levels at seven sites adjacent to the Meredosia Energy Center and IL-104 in May 2011 (PHE 2011). The noise monitoring sites (Site #1 through Site #7) are described and summarized below in Table 3.14-8. Figure 3.14-2 depicts the locations of the seven noise monitoring sites in relation to the Meredosia Energy Center.

Table 3.14-8. Summary of Noise Monitoring Sites

Noise Monitoring Site ID #	Description	Distance from Site to Noise Source (feet)			Dominant Noise Sources
		MEC	Cargill	Nearest Roadway	
1	Southeast corner of IL-104 & Yeck Road	7,700	6,600	25 (IL-104)	Truck traffic on IL-104; light duty vehicle traffic on IL-104
2	Adjacent to Elementary School	3,500	1,800	120 (IL-104)	Truck traffic on IL-104; school yard activity; light duty vehicle traffic on IL-104
3	Adjacent to South Washington Street near IL-104	2,500	350	25 (South Washington Street) 270 (IL-104)	Cargill facility; Trucks on South Washington Street
4	Near Railroad Street	900	1,100	75 (Railroad Street)	Cargill facility; Meredosia Energy Center
5	South Washington Street near Meredosia Energy Center entrance	1,300	1,800	25 (South Washington Street)	Cargill facility; Trucks on South Washington Street; Meredosia Energy Center
6	Old Naples Road near Yeck Road	2,600	4,200	25 (Old Naples Road)	Cargill facility; Trucks on Old Naples Road; Meredosia Energy Center
7	Coal storage pile monitoring	900	2,700	900 (Coal Pile)	Dozers on coal pile; Cargill facility; Meredosia Energy Center

Source: PHE 2011
 Cargill = Cargill, Inc.; IL-# = Illinois State Route; MEC = Meredosia Energy Center

Sites #1 and #2 are representative of receptors along IL-104. Sites #4 and #5 are representative of the closest houses to the north (Site #4) and east (Site #5). Sites #3 and #6 are approximately 2,500 feet away from the noisy elements at the Meredosia Energy Center and also reflective of traffic noise from South Washington Street (Site #3) or Old Naples Road (Site #6). It is important to note that the Cargill facility, near the center of Meredosia, is the largest noise source at Sites #3, #4, #5, and #6. At Site #3, which is only 350 feet east of the Cargill noise generators, the noise environment is totally dominated by Cargill.



Figure 3.14-2. Noise Monitoring Sites

The Meredosia Energy Center contains a total of six boilers (B-1 through B-6) and four turbine units (Units 1 through 4). Units 1 and 2 (Boilers B-1, B-2, B-3, and B-4) were not operating during the noise monitoring.

During the noise monitoring, the Meredosia Energy Center operated in three different scenarios:

Scenario 1: For most of the time, only Unit 3 and the fans associated with it were operational. This is described as the first scenario, and the baseload operating condition.

Scenario 2: Under the second scenario, two dozers were operating on the coal storage pile. During this special event, noise levels were monitored at Site #7. This additional noise was added to the baseload condition of continuous Unit 3 operation.

Scenario 3: Under the third scenario, Unit 4 was also operating. During this scenario, noise levels were monitored at Sites #4, #5, and #6. This additional noise was added to the baseload condition of continuous Unit 3 operation.

Table 3.14-9 presents the range of L_{eq} measured at the noise monitoring sites, and the scenarios and time periods under which they were monitored. Subsequent to the noise monitoring that occurred in May 2011, the Meredosia Energy Center suspended operation (at the end of 2011). The noise monitoring results presented herein serve to describe the historical conditions; however, after suspension of operations at the Meredosia Energy Center, the ambient noise would not include the activities under the three scenarios listed above.

The nighttime noise monitoring was conducted at the three monitoring sites adjacent to the Meredosia Energy Center: Site #4 at Railroad Street, Site #5 at South Washington Street, and Site #6 at Old Naples Road. There were numerous instances of noise levels exceeding the state code limits for particular octave bands (hertz levels) at each of these locations (PHE 2011). The following three nighttime noise locations and conditions were monitored:

- Site #4 was representative of the homes to the north of the Meredosia Energy Center on Railroad and Pearl streets. At Site #4 the dominant noise source was Cargill. Other noise sources were the Meredosia Energy Center and occasional traffic on Railroad and Pearl streets, along with environmental noise such as rustling leaves.
- Site #5 was representative of noise levels at the homes east of the Meredosia Energy Center. This location was quieter than Site #4 since it is further from Cargill, though Cargill was still the dominant noise source at this site, with cricket noise also constantly present. Other sources included the intermittent traffic on South Washington Street and the Meredosia Energy Center.
- Site #6 was the noisiest of the three sites during the overnight monitoring. While crickets provided a source of continuous noise, numerous extraneous noises were also observed, including a train, barking dogs, heavy truck, etc.

The daytime noise monitoring was conducted at all seven monitoring sites (#1 through #7) under a variety of scenarios and times of day (see Table 3.14-9). There were numerous instances of noise levels exceeding the state code limits for particular octave bands (hertz levels) at each of these locations (PHE 2011). The following five daytime noise locations and conditions were monitored:

- Site #3 was located near the intersection of IL-104 and South Washington Street, and diagonally across the street from the Meredosia Post Office on South Washington Street. The largest sound source, by a significant margin, was the Cargill grain facility. The Cargill facility routinely exceeded the standards for 250; 500; 1,000; 2,000; and 4,000 hertz, with occasional additional exceedances in 125 and 8,000 hertz ranges.

Table 3.14-9. Existing Ambient Sound Levels at the Monitoring Sites

Noise Monitoring Site	Nighttime Monitoring		Daytime Monitoring	
	Scenario / Time Period	Range of L _{eq} (dBA)	Scenario / Time Period	Range of L _{eq} (dBA)
1			Scenario 1 7:00 a.m.–12:00 p.m.	59.4–64.6
2			Scenario 1 7:00 a.m.–12:00 p.m.	51.3–65.9
3			Scenario 1 7:00 a.m.–5:15 p.m.	66.4–67.3
4	Scenario 1 12:00 a.m.–1:00 a.m.	45.1–46.9	Scenario 1 8:00 p.m.–9:00 p.m.	48.8–50.5
			Scenario 3 11:15 a.m.–12:30 p.m.	53.9–54.6
5	Scenario 1 12:15 a.m.–1:00 a.m.	39.0–53.5	Scenario 1 7:00 a.m.–9:00 a.m.	50.8–55.9
			Scenario 1 7:00 p.m.–8:00 p.m.	46.4–52.2
			Scenario 3 11:15 a.m.–12:30 p.m.	52.9–56.7
6	Scenario 1 12:00 a.m.–1:00 a.m.	44.9–58.4	Scenario 1 7:00 a.m.–9:00 a.m.	48.7–55.4
			Scenario 1 3:00 p.m.–8:00 p.m.	44.0–68.0
			Scenario 3 11:15 a.m.–12:30 p.m.	52.6–60.9
7			Scenario 2 1:39 p.m.–2:04 p.m.	54.7–59.8

Source: PHE 2011

dBA= A-weighted sound level in decibels; L_{eq} = equivalent sound level

- Site #4 was located north of the Meredosia Energy Center, near the homes on Railroad and Pearl streets. Monitoring was conducted during time periods when the Unit 4 fans were in operation and during time periods when Unit 4 fans were not in operation. The Meredosia Energy Center was noticeably louder when Unit 4 was in operation, with the largest increases observed in the deeper octaves (31.5 to 250 hertz). The exceedances noted in the 4,000 hertz octave band were due to Cargill, not the Meredosia Energy Center. When Unit 4 was not in operation, Cargill was the loudest noise source. When Unit 4 was in operation, the Meredosia Energy Center became very nearly as loud as Cargill.
- Site #5 was located to the east of the Meredosia Energy Center. Monitoring was conducted during time periods when the Unit 4 fans were in operation and when the Unit 4 fans were not in operation. Cargill was a more apparent continuous noise source than the Meredosia Energy Center during all monitored time periods. The widely scattered exceedances in the 1,000 and 2,000 hertz octave bands were caused by a combination of Cargill and heavy truck pass-bys, not the Meredosia Energy Center.

- Site #6 was located to the southeast of the Meredosia Energy Center. Monitoring was conducted during time periods when Unit 4 fans were in operation and when Unit 4 fans were not in operation. Cargill was a more apparent continuous noise source than the Meredosia Energy Center during all monitored time periods. The widely scattered exceedances in the 1,000 and 2,000 hertz octave bands were caused by a combination of heavy truck pass-bys and Cargill.
- Site #7 was located closest to the storage piles, on the Meredosia Energy Center property. This site was monitored to evaluate typical energy center operational noise associated with two bulldozers moving coal on the coal storage pile. The monitoring session was divided into three parts reflecting a low, average, and high amount of activity on the coal pile. There were various octave band exceedances during the monitoring session, though all these exceedances were in the octave bands that the Cargill facility dominates. At the adjacent property lines, the coal pile activity did not contribute to any noise exceedances.

Sites #1 and #2 were located along the IL-104 corridor in Meredosia. The following were the only two sites that were not influenced by Cargill:

- Site #1, located 25 feet off IL-104 on the south side of the roadway, is representative of receptors along IL-104 outside the village of Meredosia. Variations in noise levels were primarily caused by the changing volumes of heavy trucks.
- Site #2 was located on the lower speed portion of IL-104 in the village of Meredosia. It was positioned at the set-back of the Meredosia Elementary School. The even wider variations in noise levels were caused by changing levels of activity in the school yard, fluctuating volumes of heavy trucks, and variations in community noise adjacent to the site, such as lawn mowers.

3.14.2.2 CO₂ Pipeline

The potential pipeline route from the energy center to the injection wells would pass primarily through rural sparsely-populated land, which has relatively quiet noise levels. The route would, however, cross state and local highways that pass through or border rural communities, which introduce additional sources of noise, at least intermittent peaks, above those expected in rural environments. Noise measurements were conducted as part of the assessment of potential impacts associated with improvements to US-67 between Jacksonville and Macomb, Illinois, which crossed the proposed pipeline corridor to the injection wells. Existing noise levels ranged from 44 to 67 dBA along the proposed highway route (IDOT 2002). Along the highways, periodic noise levels could spike to 86 dBA due to heavy trucks passing at 55 miles per hour (Cowan 1994).

3.14.2.3 CO₂ Storage Study Area

The storage study area is located in an agricultural area in the northeastern corner of Morgan County. As such, the site is classified as a Class C property per the state of Illinois noise control regulations. The Alliance contracted with Patrick Engineering, Inc. to conduct an assessment to determine the potential for noise and vibration impacts to surrounding receptors at the location of the stratigraphic well. The report, which was limited to the construction of the well pad and drilling of the well, documents ambient noise levels at nearby receptor locations. Ambient nighttime noise levels were determined to be 38 dBA, averaged over 1 hour on the night of April 27, 2011. The maximum noise level was 58 dBA and the minimum was 31 dBA (Patrick 2011). The nearest sensitive receptor to the stratigraphic well site is approximately 1,570 feet away.

3.14.2.4 Educational Facilities

The Alliance anticipates that the visitor, research, and training facilities would be located in or near Jacksonville, Illinois. The Alliance is working with local stakeholders to identify the locations that would best serve the functions of these facilities. Because the locations of the educational facilities are unknown,

DOE cannot characterize the existing noise environment specifically. However, it is likely that the facilities would be located in a semi-urban to urban area, near a road with existing traffic, surrounded by other businesses and services that generate moderate levels of urban noise, likely within the range of 46 to 55 dBA.

3.14.2.5 Existing Traffic Noise (for All Project Components)

The maximum design year peak-hour L_{eq} traffic noise levels expected in the vicinity of the project were predicted using FHWA’s Traffic Noise Model 2.5. Predicted noise levels for the maximum analysis year and current noise levels were compared to determine if traffic noise impacts can be expected from the proposed project (FHWA 2004). Notably, peak traffic does not always equate to peak noise, but it is the best available information at the time of the analysis and the assumption is reasonable given the predicted LOS. Noise from the roadways within the study area would neither (1) equal or exceed the NAC, nor (2) exceed the existing noise levels by 10 dBA.

Table 3.14-10 lists the $L_{eq}(h)$ during the peak travel period adjacent to state roadways connecting population centers within 40 miles to the Meredosia Energy Center. The highest annual average daily traffic and subsequently the highest $L_{eq}(h)$ along each segment were used to reflect worst-case baseline conditions. All roadways within the pipeline corridor operate with sound levels below the NAC. All segments would operate at or below these levels on portions with lower traffic volumes, at distances further than 100 feet from the centerline, and at times outside of the peak traffic period.

Table 3.14-10. Estimated Sound Levels Adjacent to Nearby Roadways - Existing Conditions

Roadway	Segment Begins	Segment Ends	$L_{eq}(h)$ (dBA) Existing ^a
Washington Street	Cips Lane	IL-104	48.7
IL-104	Washington Street	IL-99	51.2
IL-99	IL-104	US-24	55.0
IL-104	IL-99	IL-107	50.6
IL-107	IL-104	I-72	52.1
US-54	I- 72	IL-106	54.4
IL-104	Green Street	US-67	53.3
US-67	IL-104	IL-125	50.6
US-67	IL-125	IL-24	53.2
US-67	US-67	IL-78	55.4
IL-104	US-67	I-72 Business	50.7
IL-267	US-78	US-36	56.9
IL-104	I-72 Business	IL-4	52.6
IL-106	IL-100	Old IL- 36	48.9
IL-100	Green Street	US-67	50.6

^a. Traffic noise levels predicted using FHWA’s Traffic Noise Model 2.5 (FHWA 2004), assuming a distance of 100 feet from centerline. dBA = A-weighted sound level in decibels; FHWA = Federal Highway Administration; I-# = interstate, IL-# = Illinois State Route; $L_{eq}(h)$ = equivalent sound level over 1 hour; US-# = U.S. Highway

3.14.3 Impacts of Proposed Action

DOE assessed the potential for impacts to sensitive receptors in the ROI based on whether the FutureGen 2.0 Project would result in any of the effects identified in Section 3.14.1.2.

3.14.3.1 Construction Impacts

Meredosia Energy Center

Ambient noise levels within the vicinity of the Meredosia Energy Center would increase due to construction of the oxy-combustion facility and associated infrastructure. The construction phase for the oxy-combustion facility, including initial demolition, is estimated to occur over a period of approximately 42 months beginning in 2014, and extending through the middle of 2017. However, construction would be substantially completed within 30 months, and the last 12 months of construction would overlap with a 1-year commissioning and startup effort.

During construction, various mixes of construction equipment would be used and would thus generate different noise levels. The USEPA derived average noise levels for various phases of industrial construction projects, including ground clearing, excavation and grading, foundations, building construction, and finishing work. These construction activities are based on the number of each type of equipment typically present, and the combined average noise levels during construction activities (Bolt et al. 1971). Table 3.14-11 presents these common noise levels that would be associated with the construction of the project components at the Meredosia Energy Center.

Table 3.14-11. Common Noise Levels Associated with Outdoor Construction

Equipment	Typical Noise Level at 50 feet (dBA)	Noise Level at 500 feet (dBA)	Noise Level at 1,000 feet (dBA)
Ground Clearing	84	64	58
Excavation, Grading	89	69	63
Foundations	78	58	52
Building Construction	85	65	59
Finishing	89	69	63
Rock Drilling (Pipeline Only)	98	78	72

Source: Bolt et al. 1971

dBA = A-weighted sound level in decibels

According to the estimated noise levels presented in Table 3.14-11, the loudest average levels during normal industrial construction activities would range from 78 to 89 dBA (at 50 feet) depending on the stage of construction, and would dissipate with distance. If two of these activities occurred simultaneously (e.g., grading of the stormwater management system and building construction of the oxy-combustion facility), the cumulative noise level could be approximately 90.5 dBA (at 50 feet). Although the temporary impact areas during construction could briefly extend to the fence lines of the nearest residential properties (as shown in Figure 2-14 and Figure 2-15), DOE assumed the closest residences are approximately 900 feet from the main energy center noise sources (see Noise Monitoring Site #4 in Table 3.14-9). At 900 feet distance, the construction noise level for simultaneous activities could be heard at 65.4 dBA, which is slightly above the level deemed as acceptable for residences by HUD (65 dBA) (see Table 3.14-3), and below the NAC benchline level of 67 dBA for residences (see Table 3.14-5). Construction of the new roadway to the barge unloading area, as well as barge unloading events, would generate noise levels similar to those presented in Table 3.14-11, thus impacting the few residences in close proximity to the barge unloading area and access road (see Section 2.4.3.2 for further discussion of the barge unloading activities). These construction noises could have a minor to moderate impact on the

few nearest residences; however, due to the nature of construction, the noise would be intermittent and temporary until the construction phase is over.

The majority of construction activities would occur during daytime hours Monday through Saturday, with occasional additional construction hours if required to complete critical construction activities. Although construction noise is exempt from Illinois Pollution Control Board noise regulations, to the extent practicable, the Alliance would make efforts to minimize the impacts from construction noise by using proper machinery operation techniques and properly maintaining machinery.

DOE anticipates negligible vibration impacts to sensitive receptors, since no residences are located within 200 feet of the proposed construction activities. According to the FTA, if the distance between source and receptor is greater than 200 feet, it is reasonable to conclude that no further analysis of vibration impacts is necessary (FTA 2006).

CO₂ Pipeline

Construction of the potential pipeline would consist of site clearing, excavation, trenching, pipe laying, and finishing work. These activities would require the use of heavy-duty construction equipment (e.g., trenching equipment, trucks, graders, backhoes, excavators, and portable generators). Use of this equipment would likely result in moderate impacts with temporary increases in ambient noise levels in the immediate area of the construction sites. The sound levels resulting from linear facility construction activities would vary greatly depending on such factors as the types of activities being performed and equipment being used. The USEPA derived average noise levels from typical public works, sewer, and trenches construction activities based on the number of each type of equipment typically present and the combined average noise levels during construction activities (Bolt et al. 1971). Table 3.14-11 presents these estimated noise levels that would be associated with pipeline construction, which would include ground clearing, excavation and grading, and potentially rock drilling.

The loudest average levels during normal pipeline construction (excluding rock drilling) would range from approximately 84 to 89 dBA at 50 feet. Noise levels would range from 64 to 69 dBA at 500 feet and 58 to 63 dBA at 1,000 feet from the construction site. Trenchless pipe-boring techniques such as jack and bore techniques and horizontal directional drilling may be required to construct pipeline under water features, roadways, and other obstacles. Use of rock drills for these techniques could result in sound levels around 78 and 72 dBA at 500 and 1,000 feet, respectively. Noise generated by construction activities of the pipeline would be naturally attenuated (reduced) by trees and vegetation or masked by noise from other man-made activities, such as traffic on adjacent roadways. Therefore, actual noise levels may be lower than predicted.

DOE analyzed two routes (the southern route and the northern route) for the pipeline to the injection wells (see Figure 2-18). Table 3.14-12 presents the number of sensitive receptors that could be impacted from the pipeline construction. **As explained in Sections 2.5.1.1 and 3.0, the Alliance identified the southern pipeline route as the proposed route, and is no longer considering the northern route alternative; however, DOE carries through the impact analysis from the Draft EIS, presenting both routes for comparison purposes. Further, the Alliance subsequently identified the location of the injection well site (as discussed in Section 2.5.2.1) and established pipeline routing for the entire southern route to the proposed location of the injection wells. Because the northern route is no longer being considered, DOE maintains the Draft EIS analysis for the northern pipeline route using hypothetical end-of-pipeline alignments through the storage study area.**

As shown in Table 3.14-12, there are 20 residences within 500 feet of the southern route; there are 21 residences, 2 cemeteries, and no churches within 1,000 feet of the southern route. Within 500 feet of the northern route, there are 15 residences, 1 cemetery, and 1 church.

Table 3.14-12. Number of Sensitive Receptors within 500 and 1,000 Feet of Pipeline Right-of-Way

Pipeline Route Options	No. of Residences within 500 Feet ^{a,b}	No. of Residences within 1,000 Feet ^{a,c}
Southern Route ^d	20	41
Northern Route ^e	18	25

- ^a. Counts are based on a review of aerial images and, therefore, should be considered estimates.
- ^b. The predicted dBA levels for receptors located 500 feet from construction site without and with **trenchless boring techniques** are 69 and 78 dBA, respectively.
- ^c. The predicted dBA levels for receptors located 1,000 feet from construction site without and with **trenchless boring techniques** are 63 and 72 dBA, respectively. **The number of sensitive receptors within 1,000 feet includes the sensitive receptors within 500 feet.**
- ^d. **Between the distance of 500 to 1,000 feet of the southern route, there are two cemeteries: New Salem and Tippet William. The Ebenezer church and cemetery, discussed in the Draft EIS, are now farther than 1,000 feet due to recent proposed route realignments.**
- ^e. Within 500 feet of the northern route, there is one cemetery (Grace Cemetery) and one church (St. Paul Lutheran Church). **The portion of the northern route within the storage study area is analyzed using a range of reasonable hypothetical end-of-pipeline spurs as presented in the Draft EIS (see Section 3.0 for further discussion). This table includes the most conservative numbers from that analysis.**

The majority of the construction is expected to occur during a period of **4 to 5 months** with 10-hour workdays Monday through Saturday. There would be approximately 150 to 300 construction workers required for the pipeline construction.

The use of trenchless pipe-boring techniques at various locations along the proposed pipeline route would produce louder, non-typical construction noise impacts. The Alliance intends to use either jack and bore techniques or horizontal directional drilling to install the pipeline under roads, railroads, waterbodies, and water-sensitive areas (e.g., wetlands) to minimize impacts. Jack and bore operations require an excavation on each side of the bore, which serve as jacking and receiving pits for the boring equipment. Horizontal directional drilling is a steerable trenchless method of installing pipeline using a surface-launched drilling rig, with minimal impact on the surrounding area. **The Alliance intends to use trenchless pipe-boring techniques in 37 locations along the southern route (some borings cross multiple surface features).**

Using these trenchless pipe-boring techniques under roads and railroads would allow the roads and railroad tracks to remain operational during construction of the pipeline. This operation is anticipated to take less than 12 hours to install the pipeline at each of the proposed road locations. The use of jack and bore techniques or horizontal directional drilling for pipeline construction under wetlands and perennial streams would eliminate the need for earth-moving activities and thus protect the sensitive eco-systems from construction impacts. Trenching may still be used to cross dry stream channels. Where horizontal directional drilling is required, the hole drilling machinery may operate continuously (24 hours per day) for approximately 1 to 4 days depending on the distance. Continuous operation would be necessary in order to maintain hole stability and to prevent damage to the specialized equipment. Any adverse effects that would occur would be of a temporary nature and cease with completion of the jack and bore or horizontal directional drilling activities.

The predicted dBA levels both without and with trenchless techniques would be 69 and 78 dBA, respectively, for receptors located 500 feet from the construction site. The predicted dBA levels would be 63 and 72 dBA, respectively, for receptors located 1,000 feet away. Due to the linear nature of pipeline construction, the location of the construction site would be transient as the pipe-laying progresses. The noise impacts from construction would be moderate, short term, and intermittent.

Not accounting for natural attenuation, receptors at distances greater than approximately 830 feet during typical pipeline construction, or approximately 2,330 feet during trenchless boring activities, would hear the construction noise at levels below 65 dBA, which is the limit deemed normally acceptable to residential receptors (see Table 3.14-3) (HUD 1985).

Vibration created by trenchless drilling operations would be below 0.2 inches per second and could be perceptible to residents depending on the distance of the residents to the construction site. However, vibration levels would be below limits for potential structural damage (Jones and Stokes 2004).

CO₂ Storage Study Area

Since publication of the Draft EIS, the Alliance identified the location of the injection well site (as discussed in Section 2.5.2.1). Primary sources of noise during construction of the injection well facilities would be from site preparation activities and a drill rig with supporting equipment (e.g., compressors, boosters, pumps, and diesel engines). The general construction of the drill pad, buildings and associated infrastructure, and access roads could generate noise levels that would range from 78 to 89 dBA (at 50 feet) due to construction equipment noises listed in Table 3.14-11.

The drilling of the injection wells would occur over a continuous, 24-hour duration, 7 days per week, for approximately **100 days per well**, and because of the duration, would be the dominant noise source. Noise would be generated from the equipment associated with the drilling as well as the construction vehicle motors and back-up beeps. The Alliance would construct earthen noise berms surrounding three sides of the well pad to mitigate the noise impact during this period.

On October 5, 2011, the Alliance began the drilling of a geological stratigraphic well within the storage study area (not part of the proposed action). This stratigraphic well is intended to provide scientific understanding of the geological conditions within the storage study area, to be used to determine the suitability and capacity of the location for the FutureGen 2.0 Project CO₂ injection wells. The construction techniques and drilling equipment used for the stratigraphic well are similar to those that would be used for the injection wells. To mitigate noise impacts from the drilling activities, the Alliance constructed noise mitigation berms to the west and north of the drill rig site. In November 2011, the Alliance conducted a noise study to monitor the noise levels resulting from the drilling operations (Patrick 2011). DOE expects that the noise levels measured during the drilling of the stratigraphic well are representative of noise levels that would be generated during construction of the injection wells.

Ambient noise levels were measured in April 2011 at the nearest residence, located 1,570 feet northwest from the stratigraphic well drilling location (Patrick 2011). Table 3.14-13 presents these ambient sound measurements.

Table 3.14-13. Ambient Sound Measurements at Nearest Residence to Stratigraphic Well

Time	Measured Sound Level ^a			Wind	
	Average (dBA)	Maximum (dBA)	Minimum (dBA)	Speed (mph)	Direction
Nighttime	37.9	57.6	31.1	9.2	W
Daytime	36.7	57.8	31.4	7	SW

Source: Patrick 2011

^a Measurements taken April 27 and 28, 2011. Measurements taken at the Beilschmidt homestead property located 1,570 feet northwest of the stratigraphic well location. Readings taken 5 feet above ground level using Reed C-322 Sound Level Meter, with accuracy of ±1.5 dBA. dBA = A-weighted sound level in decibels; mph = miles per hour; SW = southwest; W = west

Drilling noise levels were measured in November 2011 at various distances and directions from the drill rig, as shown in Figure 3.14-3 and Table 3.14-14. According to data measured during the noise study, the berm reduced the noise level at the receptors by over approximately 12.8 dBA.



Source: Patrick 2011
ft = feet; SP = sound point

Figure 3.14-3. Sound Measurement Locations at Stratigraphic Well

Table 3.14-14. Sound Measurements at Various Distances and Directions from Stratigraphic Well during Drilling Activities

Distance (feet) from Active Drill Rig	Location	Average Daytime Sound Level (dBA) ^a	Average Nighttime Sound Level (dBA) ^a	Notes
3,925	Sound Point 1	44	43	Car noise excluded
2,764	Sound Point 2	39	33	
1,987	Sound Point 4	45	33	Wind gusts ^b
1,570	Sound Point 3	36	36	Nearest residence ^b
1,230	Sound Point 5	42	50	
413	Sound Point 12	63	Not measured	
322	Sound Point 11	49	Not measured	Shielded by berm ^b
303	Sound Point 10	54	Not measured	Shielded by berm ^b
207	Sound Point 8	72	Not measured	
170	Sound Point 7	75	Not measured	
166	Sound Point 6	67	Not measured	
99	Sound Point 9	69	Not measured	

Source: Patrick 2011

^a. Measurements taken November 2011. Readings taken 5 feet above ground level using Reed C-322 Sound Level Meter, with accuracy of ±1.5 dBA.

^b. A noise mitigation berm stood between the drilling area and the receptor point. The western berm was 10 feet high, located between points #8 and #10; the northern berm was 15 feet high, located between points #7 and #11.

dBA = A-weighted sound level in decibels

General construction activities prior to drilling are estimated to generate noise levels that can reach approximately 89 dBA at a distance of 50 feet, and drilling activities for the injection wells could generate 98 dBA at a distance of 50 feet based on typical noise levels for rock drilling (see Table 3.14-11). The distances to the sensitive receptors are currently unknown, as the exact locations of the injection wells have not yet been selected. To evaluate the potential for impacts to sensitive receptors when the site locations are chosen, DOE estimated anticipated noise levels from the construction and drilling activities for distances at 500 and 1,000 feet from the well, with and without noise mitigation berms. The estimates are based on typical rock drilling noise levels as well as proportional estimates based on noise levels measured during the drilling of the stratigraphic well (see Table 3.14-15).

As shown in Table 3.14-15, residences over 1,000 feet away from general non-drilling construction activities (without noise mitigation measures) and from drilling activities (with a noise berm in place) would experience short-term minor to moderate impacts as the noise levels would be above the typical rural ambient level, but still below the acceptable level of 65 dBA, as recommended by HUD for residential areas (HUD 1985).

The noise study data from the drilling of the stratigraphic well indicates that at approximately 1,570 feet from the well, with the noise berms in place, the sound level during drilling activities would be approximately equal to the ambient noise level (36 dBA) as measured at this distance in April 2011 (Patrick 2011).

Table 3.14-15. Estimated Sound Levels at Various Distances from Injection Well Construction

	Typical Noise Level at 50 feet (dBA)	Noise Level at 500 feet (dBA)	Noise Level at 1,000 feet (dBA)
General Construction Equipment Noise (not including drilling) ^a	89	69	63
Drilling Noise ^b	NA	78 (62)	72 (54)
Drilling Noise Attenuated with Mitigation Berm ^c	NA	66 (50)	60 (42)

^a. The general construction equipment noise level was calculated without consideration of a noise mitigation berm (see Table 3.14-11).

^b. Values not in parentheses are drilling noise levels based on published typical rock drilling noise levels (98 dBA at 50 feet, see Table 3.14-11). Values in parentheses are drilling noise levels estimated on a proportional basis from the noise data measured during drilling of the stratigraphic well (see Table 3.14-14).

^c. According to data measured during the noise study, the berm reduced the noise level at the receptors by over approximately 12.8 dBA (conservatively rounded down to 12 dBA).

dBA = A-weighted sound level in decibels; NA = not applicable

Ground vibrations from well drilling activities are expected to have negligible impact to nearby structures. A typical value for ground vibrations from drilling activities is 0.089 inches per second, measured at a distance of 25 feet from the source (FTA 2006). The lowest vibration damage threshold for continuous vibrations, applicable to extremely fragile historic buildings, is 0.08 inches per second (see Table 3.14-7). DOE estimates¹ that drilling vibrations would decay to below this threshold at a distance of approximately 30 feet from the source. Therefore, any structures located farther than 30 feet from the drilling activity would not experience damaging levels of ground vibration. Further, **using the thresholds presented in Table 3.14-6, for a continuous source**, DOE estimates that vibrations from well drilling would be imperceptible to humans beyond a distance of **200 feet** from the drilling location. **DOE estimates that the nearest dwellings are located at a distance of over 900 feet from the end of the pipeline at the injection well site.** Thus, DOE expects negligible impacts to sensitive receptors due to vibrations from the drilling.

The Alliance would be required to install monitoring wells as a condition of its UIC permits (see Section 2.5.2.4). The quantity and location of the monitoring wells would be based on the UIC permitting process and the results of the geologic stratigraphic study. Related noise and vibration impacts would be similar to those described for the construction of the injection wells.

Educational Facilities

For the worst-case scenario, in which the educational facilities would be newly constructed buildings, construction activities could involve ground clearing, excavation and grading, foundations, building construction, and finishing work. The typical noise levels of these activities could range from 78 to 89 dBA (see Table 3.14-11) (Bolt et al. 1971). With multiple items of equipment operating concurrently, noise levels could be relatively high during daytime periods at locations within several hundred feet of the active construction sites. The specific locations of the facilities are currently unknown, though they are anticipated to be located in the urban area of Jacksonville. Although construction-related noise would have moderate adverse impacts on nearby sensitive receptors, the effects would be temporary in nature and would end upon completion of the construction. Contractors would typically limit construction to occur primarily during normal weekday business hours, and would properly maintain construction equipment mufflers. If the educational facilities were instead located in renovated buildings, construction noise impacts would be lower.

¹ The following equation was used to calculate vibration levels (Jones and Stokes 2004):

$$\text{Peak Particle Velocity (PPV)} = 0.089 * (25/D)^{1.1}, \text{ where } D \text{ is the distance in feet from the source to the receptor.}$$

Traffic Noise during Construction (For All Project Components)

Ambient noise levels along the primary construction traffic routes would likely increase as a result of construction-related vehicles entering or leaving a particular construction site, as well as construction workers commuting to and from the construction sites. See Section 3.13, Traffic and Transportation, for a discussion about the number of vehicles accessing the site and impacts from traffic.

Short-term negligible adverse effects on the noise environment would be expected due to construction traffic. Each roadway was modeled, assuming no special noise abatement measures would be incorporated, and the roadway sections were assumed to be at-grade. It was assumed that the peak-hour volumes and corresponding speeds for trucks and automobiles would result in the noisiest conditions. Noise predictions of $L_{eq}(h)$ for representative receptors within 328 feet of nearby roadways appear in Table 3.14-16.

Table 3.14-16. Estimated Sound Levels Adjacent to Nearby Roadways - Proposed Project

Roadway	Segment Begins	Segment Ends	$L_{eq}(h)$ (dBA) ^a			
			Existing	No Action	Construction	Operation
Washington Street	Cips Lane	IL-104	48.7	48.9	51.8	49.4
IL-104	Washington Street	IL-99	51.2	51.5	51.8	51.5
IL-99	IL-104	US-24	55.0	55.3	55.3	55.3
IL-104	IL-99	IL-107	50.6	50.9	51.2	50.9
IL-107	IL-104	I-72	52.1	52.4	52.6	52.4
US-54	I-72	IL-106	54.4	54.6	54.7	54.7
IL-104	Green Street	US-67	53.3	53.6	54.6	53.8
US-67	IL-104	IL-125	50.6	50.9	51.3	50.9
US-67	IL-125	IL-24	53.2	53.4	53.6	53.4
US-67	US-67	IL-78	55.4	55.6	56.1	55.7
IL-104	US-67	I-72 Business	50.7	50.9	51.5	51.0
IL-267	US-78	US-36	56.9	57.1	57.2	57.2
IL-104	I-72 Business	IL-4	52.6	53.0	53.1	53.0
IL-106	IL-100	Old IL-36	48.9	49.3	49.4	49.3
IL-100	Green Street	US-67	50.6	50.9	50.9	50.9

^a Traffic noise levels predicted using FHWA's Traffic Noise Model 2.5 (FHWA 2004), assuming a distance of 328 feet (100 meters) from centerline.

dBA = A-weighted sound level in decibels; FHWA = Federal Highway Administration; I-# = interstate, IL-# = Illinois State Route; $L_{eq}(h)$ = equivalent sound level over 1 hour; US-# = U.S. Highway

During construction, there would be only a slight increase in the level of traffic noise for receptors adjacent to nearby roadways when compared to the no action alternative. No residences or other land uses identified equal or approach the NAC for category B of 67 dBA, or would have an increase of greater than 10 dBA. These changes in noise would not even be barely perceptible when compared to existing conditions.

3.14.3.2 Operational Impacts

Meredosia Energy Center

The proposed project would include new sources of noise resulting from the operation of the oxy-combustion facility. The project would involve replacing existing Boiler 6 (of Unit 4) with a new oxy-combustion boiler (Boiler 7), and adding various other project features including booster fans, compressors, material unloading areas, etc., as discussed in Section 2.4.1. The new oxy-combustion boiler would utilize some of the existing energy center features, including existing noise sources such as the coal handling systems and the Unit 4 steam turbine and generator. As discussed in Chapter 2, all other boilers of the Meredosia Energy Center have been removed from service. Thus, the operational noise at the Meredosia Energy Center during the proposed project would result from the FutureGen 2.0 Project components, along with other third-party actions occurring on the property as discussed in Section 4.3, Potential Cumulative Impacts, including a new substation run by Ameren Transmission Company of Illinois, and use of the oil storage tanks by Sunrise Ag Energy, LLC.

DOE measured ambient noise levels in 2011 during operation of the Meredosia Energy Center as discussed in Section 3.14.2.1 (PHE 2011). Scenario 3 of the 2011 noise study involved operation of Units 3 and 4, along with two dozers operating on the coal storage pile. DOE assumes that the new operations under the proposed project would be similar to this operational Scenario 3, though smaller in magnitude. This assumption is based on the proposed oxy-combustion facility generating capacity (approximately 168 MWe) being smaller than the previous system operating during the noise monitoring (approximately 369 MWe). Specifically from a noise perspective, the new system would operate one turbine (for Unit 4) instead of two (for Units 3 and 4), and the coal storage pile operations would likely continue to have one to two dozers in use, though the frequency and duration of the dozer usages would change depending on the amount of coal required.

Sensitive-receptor Sites #4 and #5 (shown in Figure 3.14-2) are representative of the closest residences to the project site, and Site #2 is the location of the nearest elementary school. According to the noise study in 2011, the Cargill facility, near the center of Meredosia, is the most significant contributor to the ambient noise levels at Sites #3, #4, #5, and #6, and the IL-104 is the most significant contributor to noise at Sites #1 and #2. Therefore, considering that noise from the Meredosia Energy Center would either remain the same or be reduced from historical levels, the ambient noise levels at these receptor locations are expected to stay at approximately the same level in comparison to historical levels. Similarly, noise levels are expected to stay at the same level in comparison to ambient conditions after the suspension of the energy center operations at the end of 2011, since local noise levels are and will continue to be dominated by the existing Cargill facility and the highway. There would, however, be an increase in truck noise in the near vicinity of the energy center due to increased usage of trucks for coal delivery under the proposed project, compared to the historical use of barges as the primary means for coal delivery. The volume of truck traffic transporting feedstock (mainly coal and limestone) and removing wastes (mainly fly ash and bottom ash) would total **less than** 88 daily roundtrips. This represents almost 50 additional roundtrips per day when compared to historic truck traffic volumes. See Section 3.13, Traffic and Transportation, for a discussion of the number of trucks and barges anticipated during operations. Overall, the project would result in minor, long-term noise impacts to noise receptors.

Upon final design and selection of equipment for the oxy-combustion and CO₂ capture system, potential noise mitigation measures may be incorporated. These could include sound enclosures or sound dampening materials or equipment, as appropriate.

DOE anticipates that any increase in vibration due to operation of the oxy-combustion facility would be negligible.

CO₂ Pipeline

The potential pipeline would be buried except where the pipeline would cross a vertical rock outcropping and where it would be necessary to come to the surface for valves and metering. Potential noise impacts from aboveground equipment are anticipated to be negligible during operations.

CO₂ Storage Study Area

Operations at the injection well site(s) would consist of pumping CO₂ underground and maintaining the injection wells. The noise-generating equipment at the injection well site(s) under normal operating conditions would be dominated by the **well annulus maintenance and monitoring systems** and typical heating, ventilation, and air conditioning systems. The **well annulus maintenance and monitoring system** would be located inside the **equipment room of the site control and maintenance building**, which would attenuate the noise levels. Under emergency conditions, there could also be operation of a backup emergency generator(s) capable of producing 1,111 kW (generating approximately 81 dBA), and emergency exhaust fans. This emergency equipment would be operated rarely and only for short durations. If a conservative level of 81 dBA is assumed, the noise at 500 feet away would be heard as 61 dBA, which is below the HUD acceptable level of 65 dBA. Since the nearest sensitive receptors at the injection well site(s) are expected to be farther than 500 feet away, the noise impacts from operational equipment at the injection well site(s) would be minor.

During maintenance, certain activities such as acidizing and swabbing could temporarily increase sound levels equal to or less than those presented in Table 3.14-11 for general construction noise. If conducted, these activities would likely take place during initial drilling activities or annual workover activities. Additionally, the occasional transport of by-products generated during maintenance activities, would also contribute to temporary increases in noise. However, these sources would have a minimal impact on the local noise levels. Due to the temporary nature of the maintenance activities and the small volume of vehicles accessing the sites, noise impacts are considered negligible to moderate, depending on the distance to the nearest receptors.

Educational Facilities

Operational noise from stationary sources at the educational facilities would be negligible. The only likely outdoor source of noise would possibly be the **backup generator and the** heating, ventilation, and air conditioning units.

Traffic Noise during Operations (For All Project Components)

Noise would be generated by mobile sources during operations, including employee and truck traffic at the energy center, injection wells, and educational facilities. The primary source of noise from mobile sources during operations of the proposed project would be the trucks transporting feedstock (mainly coal and limestone) and removing wastes (mainly fly ash and bottom ash) from the Meredosia Energy Center. See Section 3.13, Traffic and Transportation, for a discussion about the number of vehicles accessing the project sites and impacts from traffic.

DOE anticipates minimal impacts to the noise environment from mobile noise sources due to operations of the proposed project. Table 3.14-16 presents noise predictions of $L_{eq}(h)$ for representative receptors within 328 feet of nearby roadways during energy center operations. There would be only a slight increase in the level of traffic noise for receptors adjacent to nearby roadways when compared to the no action alternative. These changes in noise would be barely perceptible when compared to existing conditions.

3.14.4 Impacts of the No Action Alternative

Under the no action alternative, DOE would not provide cost-shared funding for the FutureGen 2.0 Project. Although the Alliance may still elect to construct and operate the project in the absence of DOE cost-shared funding, for the purposes of the analysis in this EIS, DOE assumed that the no action

alternative is equivalent to a no-build alternative. Therefore, the project would not be constructed and there would be no change to noise and vibration.

3.15 UTILITIES

3.15.1 Introduction

This section describes the existing utility systems that may be affected by the construction and operation of the FutureGen 2.0 Project, including potable and process water supply, wastewater treatment, electricity, and natural gas, as well as the associated direct and indirect impacts that may occur.

3.15.1.1 Region of Influence

The ROI for utility systems includes the existing public utility infrastructure and facilities that would provide service to the FutureGen 2.0 Project, including potable and non-potable water, wastewater, electricity, and natural gas. The ROI also includes existing pipelines, transmission lines, and other utility lines that lie within or cross the proposed project areas in Morgan County. Utility systems that may be affected are located primarily in Morgan County.

3.15.1.2 Method of Analysis and Factors Considered

The estimated utility consumption for the FutureGen 2.0 Project was compared to the existing utility demand to determine whether the proposed project would strain any of the existing utility systems. The potential for impacts to utility systems were assessed based on whether the proposed project would directly or indirectly:

- Impact the effectiveness of existing utility infrastructure or cause temporary failure;
- Affect the capacity and distribution of local and regional utility suppliers to meet the existing or anticipated demand; or
- Require public utility system upgrades.

3.15.1.3 Regulatory Framework

The Public Utilities Act (220 ILCS 5) and the regulations of the Illinois Commerce Commission regulate public utilities in Illinois. These laws do not apply to utilities run by municipalities or rural electric Co-Ops, which are governed by local ordinances or by their own rules. The service area of the Illinois Rural Electric Cooperative includes the majority of the ROI, including the village of Meredosia, the city of Jacksonville, and the area encompassed by the CO₂ pipeline corridor. The service area of the Menard Electric Cooperative includes the area encompassed by the proposed CO₂ storage study area. The Midwest Independent Transmission System Operator is the Regional Transmission Organization responsible for reliability coordination and regional planning for electrical transmission.

Illinois regulations state that an entity acting in the capacity of a utility must obtain a permit issued by an officer of the elected governing body before entering a highway ROW (92 IAC 530); and that any entity connecting to a public potable water supply requires a permit (35 IAC 174).

3.15.2 Affected Environment

3.15.2.1 Meredosia Energy Center

Water Usage

According to the Meredosia Water Department, the Meredosia Water Plant serves approximately 450 users within the village of Meredosia. The Meredosia Water Plant pumps approximately 65,000 gpd to its service area and has an overall capacity to provide 500,000 gpd. The Meredosia Water Plant currently operates at 13 percent of its total capacity and has approximately 435,000 gpd of additional capacity for public water supply (Hull 2011).

The Meredosia Energy Center has historically used well water as its source for drinking water as well as for freeze protection of the bottom ash pond piping during the winter months when necessary.

Information on well water usage at the Meredosia Energy Center and surrounding areas is covered in Section 3.5, Groundwater. The energy center has historically utilized city water from the Meredosia Water Plant for fire protection and Unit 4 floor wash. Since the suspension of operations at the end of 2011, the energy center has greatly reduced its well water usage as only minimal amounts of drinking water are required by the few maintenance and security personnel onsite, and city water is only required for general maintenance.

Process water was historically supplied to the Meredosia Energy Center from a combination of well water and river water sources. Information on well water usage for process water at the Meredosia Energy Center and surrounding areas is discussed in Section 3.5, Groundwater. Historic demand on the Illinois River for process water at the Meredosia Energy Center is discussed in Section 3.6, Surface Water.

Wastewater

The village of Meredosia sewer system routes sanitary sewage to three large evaporative settling ponds north of Meredosia. According to the Meredosia Water Department, the settling ponds have sufficient available capacity for future demands (Hull 2012b).

Historically, the Meredosia Energy Center generated wastewater from both sanitary facilities and industrial processes. Sanitary wastewater was collected and routed to a single point of discharge to the village of Meredosia sewer system. Process wastewater was either recycled as practicable or treated onsite and discharged to the Illinois River. Process wastewater was not discharged to a public wastewater treatment facility.

Since the suspension of operations at the Meredosia Energy Center, only a minimal amount of wastewater is generated by the few maintenance and security personnel onsite.

Electricity

Prior to suspension of operations, the nominal rated generating capacity of the combined four generating units at Meredosia Energy Center was 549 MWe. A portion of this generating capacity was used to power the energy center facilities. Existing electrical infrastructure is located onsite, including medium and low voltage systems, transmission towers, and substations.

Since the suspension of operations at the Meredosia Energy Center, the site has required a limited supply of electricity for building maintenance.

Natural Gas

Prior to suspension of operations, Ameren Illinois provided natural gas to the Meredosia Energy Center via a natural gas substation on the north end of the energy center property, which is fed by an existing natural gas pipeline that runs under the Illinois River. The pipeline supplied fuel for Boiler 6 ignition and additional minor plant processes.

Since the suspension of operations at the Meredosia Energy Center, the site does not require natural gas with the exception of potential use for the back-up generator at the microwave tower.

3.15.2.2 CO₂ Pipeline, CO₂ Storage Study Area, and Educational Facilities

Water Usage

The North Morgan County Water Co-Op currently supplies water to approximately 520 users in the area of the CO₂ pipeline and storage study area and pumps approximately 90,000 gpd. The North Morgan County Water Co-Op has the capacity to pump 2 mgd and is currently operating at 4.5 percent capacity.

The North Morgan County Water Co-Op buys their water from the Jacksonville Water Department, which supplies water to the city of Jacksonville from the Jacksonville Water Plant. The Jacksonville Water Plant currently pumps approximately 3.5 to 4 mgd, has the capacity to pump approximately 9 mgd, and is currently operating at 44 percent capacity (Cole 2011).

Wastewater

The Jacksonville Sewer Plant provides service to residents within Jacksonville. The Jacksonville Sewer Plant has the capacity to process 7.57 mgd, but has the capability of increasing capacity to 15 mgd during wet weather. The Jacksonville Sewer Plant currently processes approximately 5.0 mgd and operates at 66 percent of normal (i.e., dry weather) capacity. The sewer plant serves a residential population of approximately 24,000 residents (City of Jacksonville 2012c).

There is no public wastewater treatment system serving the rural portions of the ROI that encompass the CO₂ pipeline corridor or storage study area. Septic tanks are primarily utilized in these areas.

Electricity

The service area of the Illinois Rural Electric Cooperative includes the city of Jacksonville and the area encompassed by the CO₂ pipeline corridor (Shelby Electric Cooperative 2011). Ameren Illinois also provides electricity throughout the ROI (Jacksonville Municipal Department 2012).

Electricity in the vicinity of the CO₂ storage study area is currently provided by Menard Electric Cooperative from a three-phase 12.5-kV line running along the west side of Morgan County Road (CR) 123. The nearest Menard Electric Cooperative substation is approximately 3.5 miles east of the CO₂ storage study area at the intersection of Riley Road and CR 18W in western Sangamon County.

Natural Gas

Ameren Illinois provides natural gas service within the ROI (Jacksonville Municipal Department 2012).

3.15.3 Impacts of Proposed Action

3.15.3.1 Construction Impacts

Impacts to public utility systems would occur from increased demand and could potentially impact a utility system's ability to provide sufficient service for its users. Existing utilities infrastructure could inadvertently be damaged or have service disrupted during construction of the FutureGen 2.0 Project. The potential for accidental damage or service disruption during construction would vary based on proposed construction methods and proximity to existing utility systems, but would be greatest during trenching activities.

To minimize the possible interference with existing overhead or underground utility lines, all proposed construction ROWs would have sufficient width to allow for the safe use of construction equipment and installation of proposed project-related infrastructure and facilities. Specifically, crossings of other pipelines (i.e., not the CO₂ pipeline) and other underground utilities would require a minimum of 12 inches of separation; the minimum separation may be increased to 24 inches where considered prudent. Existing pipelines would be under-crossed unless over-crossing is specifically permitted by the pipeline owner. The Alliance would ensure that alignments of existing utilities (e.g., electric, telephone, cable, water, gas, and sewer) would be located and demarcated prior to construction, and coordination with affected utility providers would continue throughout final engineering and design. Also, where appropriate, the Alliance would implement measures (e.g. vacuum excavation) to decrease the potential for construction equipment, particularly trenching equipment, to sever or damage existing underground lines. Should a disruption of an existing utility service occur in the event of a construction accident, it is anticipated that impacts would be short term and minor.

Meredosia Energy Center

Water Usage

During construction, potable water for workers, as well as any water requirements for construction activities, would be provided by either existing wells at the Meredosia Energy Center or water tanks transported onsite via trucks. For purposes of analysis, it is assumed that water for the tanks would be supplied by the Meredosia Water Plant. An estimated average demand of 15 gpd of potable water per employee would be consumed during construction of the oxy-combustion facility. Based on a peak of

500 workers at the height of construction at the Meredosia Energy Center, maximum daily water consumption during construction would be 7,500 gpd. If water tanks supply all potable water needs for construction, the Meredosia Energy Center would require 1.7 percent of the Meredosia Water Plant's current unused capacity. Water demand would not exceed available capacity of the Meredosia Water Plant and impacts to potable water providers are expected to be short term and negligible.

The Alliance currently does not plan to construct additional water lines; however, in the future, they may extend the existing city water line onsite to provide water needs. This would not adversely impact the village of Meredosia public water utilities.

Wastewater

Sanitary wastewater during construction would be generated by workers onsite. Based on typical sanitary wastewater generation rates for construction projects, 15 gpd of sanitary wastewater generation per employee during construction is assumed (Liu and Lipták 1997). Based on a peak of 500 workers at the height of construction, maximum daily sanitary wastewater generation would be 7,500 gpd. Portable toilets and hand-wash stations would be provided for construction workers and serviced regularly. The ultimate sanitary wastewater disposal would be determined during the construction phase; however, it is assumed that the sanitary wastewater would be disposed of at permitted sewage treatment facilities with sufficient capacity, and would not adversely impact local utilities. Impacts to wastewater treatment providers would be short term and negligible.

The Alliance currently does not plan to construct additional sewer lines; however, in the future, they may re-route the sanitary wastewater piping on the energy center site. This would not adversely impact the village of Meredosia sewer system.

Electricity

The construction of upgrades to the existing electrical infrastructure at the Meredosia Energy Center would be necessary. New electrical equipment and connections would be installed to provide power to the various components of the oxy-combustion facility. Existing overhead transmission and distribution lines would be re-routed, which would require the demolition of existing towers and construction of new towers. Impacts from the demolition and construction of these electrical structures would occur solely on the project site and would not disrupt local utilities' ability to provide service.

It is assumed that electricity needs during construction would be provided by the public electrical grid (i.e., a local utility) to be spot supplemented by portable generators. Overall utility impacts from electricity usage during construction would be negligible.

Natural Gas

The Alliance does not anticipate a need for natural gas during construction nor any construction involving natural gas lines; therefore, no impacts to natural gas providers would occur.

CO₂ Pipeline, CO₂ Storage Study Area, and Educational Facilities

Water Usage

During construction of the CO₂ pipeline, injection wells, and educational facilities, it is assumed that potable water would be provided via water tanks transported to the sites by trucks. For purposes of analysis, DOE assumed that water tanks for construction of the CO₂ pipeline and injection well site(s) would be filled by the North Morgan County Water Co-Op (which purchases its water from the Jacksonville Water Department) and directly from the Jacksonville Water Department for construction of the educational facilities. **For the dual-site scenario analyzed in the Draft EIS, which is no longer under consideration by the Alliance, construction activities would require up to 355 workers for construction at the CO₂ pipeline and injection well sites and 87 workers for the construction of educational facilities.** Based on an average of 15 gpd of potable water usage per worker, an estimated 5,325 gpd of potable water would be required from the North Morgan County Water Co-Op for

construction at the CO₂ pipeline and injection well sites, and an estimated 1,305 gpd of potable water would be required from the Jacksonville Water Department for construction of the educational facilities. This demand would represent less than 1 percent of unused capacity for the North Morgan County Water Co-Op and Jacksonville Water Department.

The updated design for the single-site scenario currently proposed by the Alliance would require up to 335 workers for construction at the CO₂ pipeline and injection well sites, and 47 workers for construction of the educational facilities. Based on an average of 15 gpd of potable water usage per worker, an estimated 5,025 gpd of potable water would be required from the North Morgan County Water Co-Op for construction at the CO₂ pipeline and injection well sites, and an estimated 705 gpd of potable water would be required from the Jacksonville Water Department for construction of the educational facilities. This demand would still represent less than 1 percent of unused capacity for the North Morgan County Water Co-Op and Jacksonville Water Department. Therefore, impacts from potable water needs during construction of the CO₂ pipeline, injection well site(s), and educational facilities would be negligible.

The CO₂ pipeline would undergo hydrostatic testing prior to operation. Water sources for hydrostatic testing have not been identified; however, if a public utility is utilized, impacts would be temporary (i.e., less than two days). Water would be trucked to the pipeline via tanks and would only be sourced from local utilities with sufficient capacity. Impacts to local water utilities from hydrostatic testing would be temporary and minor.

Water would be required for the drilling of the injection and monitoring wells. Volumes needed for construction of the injection wells would be greater than the amount used for drilling the stratigraphic well because of the larger well diameters. **For the dual-site scenario analyzed in the Draft EIS, up to 4.8 million gallons of water would be required to drill two vertical injection wells. The updated design for the single-site scenario currently proposed by the Alliance would require four horizontal injection wells to be drilled, and would require up to 8.68 million gallons of water.** DOE estimates the maximum volume each injection well would require would be approximately 1,330,000 gallons of water for drilling fluids and cement preparation, and another 840,000 gallons of water to account for zones of lost circulation. Thus, the total water demand per well drilled would be approximately 2.17 million gallons. Assuming a drilling duration of 100 to 120 days, between 18,000 and 21,700 gpd of water would be required to drill each well. The monitoring wells would likely require an amount less than this, since they would be smaller in diameter and shallower than the injection wells. The water for construction of the injection and monitoring wells would be supplied by water trucks using water from the North Morgan County Water Co-Op and from other nearby sources. If the North Morgan County Water Co-Op were to supply all water needed, drilling of each injection well would require between 1 and 1.25 percent of its daily un-used capacity. Overall, construction impacts to water utilities would be short term and minor.

Wastewater

During construction of the CO₂ pipeline, injection well site(s), and educational facilities, sanitary wastewater would be generated by construction workers. **For the dual-site scenario analyzed in the Draft EIS, a maximum of 442 employees would be employed during the construction phase. Assuming that 15 gpd of sanitary wastewater would be generated per worker, a maximum total of 6,630 gpd of sanitary wastewater would be generated during construction for the CO₂ pipeline, injection well site(s), and educational facilities. The updated design for the single-site scenario currently proposed by the Alliance would require a maximum of 382 employees during construction. Assuming the same 15 gpd per worker generation rate for sanitary wastewater, a maximum total of 5,730 gpd of sanitary wastewater would be generated during construction of the CO₂ pipeline, injection well site(s), and educational facilities.**

Portable toilets and hand-wash stations would be provided for construction workers. These self-contained portable units would be serviced regularly and the effluent would be collected and hauled to permitted sewage treatment facilities by licensed waste transporters. For purposes of this analysis, DOE assumed that all sanitary wastewater would be trucked offsite to the Jacksonville Sewer Plant. Under this scenario, a demand of less than 1 percent of the Jacksonville Sewer Plant's available capacity would occur; therefore, negligible impacts would be anticipated. Spent hydrotest water from CO₂ pipeline hydrostatic testing would be discharged to local waterways under an NPDES permit from the IEPA or to an existing treatment facility. If hydrotest water is discharged to a treatment facility, a permitted facility with sufficient capacity would be utilized and impacts to local utilities would be negligible.

During construction of the wells, excess fluids generated during drilling, discarded water used in the cementing process, and spent drilling mud from mud change-outs would be discharged to lined earthen pits at the construction site. For purposes of this analysis, DOE assumed that wastewater would be transported offsite by licensed waste transporters and disposed of at permitted sewage treatment facilities with sufficient capacity, and would not adversely impact local utilities.

Electricity

Electricity needs during construction for the CO₂ pipeline, injection well site(s), and educational facilities would be provided by portable generators and would not impact local utilities.

Natural Gas

No natural gas would be required for construction; therefore, no impacts to natural gas providers would occur.

3.15.3.2 Operational Impacts

Meredosia Energy Center

Water Usage

Water from the Meredosia Water Plant would be utilized for fire protection and the oxy-combustion boiler floor wash. Approximately **5,000** gpd of Meredosia Water Plant water would be used during operations.

The Alliance plans to use onsite wells for drinking water purposes during operation of the FutureGen 2.0 Project at the Meredosia Energy Center, though use of city water may be considered in the future. If city water is used for potable water, the estimated maximum of 115 employees could consume up to 1,725 gpd of water.

At a maximum, the use of city water for fire protection, floor wash, and possibly potable water for employees would represent less than 1 percent of the Meredosia Water Plant's unused capacity, and impacts would be negligible.

Process water would not impact utilities as it would be supplied by a combination of well water and river water sources during operation. Impacts on well water usage are discussed in Section 3.5, Groundwater. River water impacts are discussed in Section 3.6, Surface Water.

Wastewater

Process wastewater would be generated from process contact wastewater, noncontact cooling water (once-through and tower blowdown), backwash from the intake screen, and oily effluent from floor and equipment drains. Process wastewater generated from operation of the oxy-combustion facility at the Meredosia Energy Center would be treated onsite and discharged to the Illinois River and, therefore, would not impact any public wastewater treatment facility. Impacts from treated process wastewater are discussed in Section 3.6, Surface Water.

Sanitary wastewater would be collected and routed to a single point of discharge to the Meredosia sewer system, which discharges to settling ponds north of the village. An annual average discharge of **5,000** gpd

of sanitary wastewater would be anticipated. This daily amount of additional discharge to the settling ponds would have negligible impacts on system capacity.

Electricity

Gross electrical generation from operation of the FutureGen 2.0 Project would be approximately 168 MWe. The proposed auxiliary electric power demand to operate the Meredosia Energy Center would be less than 69 MWe. This would result in a net output of at least 99 MWe of electricity.

No impacts to public electric utility providers are anticipated as a result of operation of the Meredosia Energy Center.

Natural Gas

Natural gas would be required for heating purposes during operations. This would be supplied by the existing natural gas pipeline serving the oxy-combustion facility and would be less than historical levels of natural gas consumption, because natural gas would no longer be utilized for boiler startups. Overall impacts to natural gas utilities would be negligible.

CO₂ Pipeline, CO₂ Storage Study Area, and Educational Facilities

Water Usage

During operation of the CO₂ injection well site(s), potable water for the surface facilities would be supplied by the North Morgan County Water Co-Op via **an extension of its 4-inch line along Beilschmidt Road. For the dual-site scenario analyzed in the Draft EIS, which is no longer under consideration by the Alliance**, 21 employees per day would be employed at the CO₂ injection well site(s), and assuming a 15-gpd consumption rate of potable water, 315 gpd of water would be consumed during operations. This would represent a less than 1 percent increase in the capacity of the North Morgan County Water Co-Op. **The updated design for the single-site scenario currently proposed by the Alliance would require up to 15 employees per day. Assuming a similar 15-gpd per worker consumption rate of potable water, 225 gpd of water would be consumed during operations. This would still represent a less than 1 percent increase in the capacity of the North Morgan County Water Co-Op;** therefore, impacts to public water utilities would be long term but negligible.

Potable water use for the educational facilities is projected at 15 gpd for each employee and 10 gallons per visitor. **Under the original design analyzed in the Draft EIS, one building would house the visitor and research center, while a second building would house the training facility;** annual potable water use would be 270,000 gallons, or approximately 740 gpd, for the visitor and research center and 215,000 gallons, or approximately 590 gpd, for the training facility. Thus, the total potable water use by the educational facilities would be 1,330 gpd. **Under the current conceptual design, all visitor, research, and training facilities would be housed in one building, and approximately 485,000 gallons of water would be used per year. Regardless of the scenario, potable water would be supplied by the Jacksonville Water Department and would represent less than 1 percent of available capacity;** therefore, impacts to water utilities would be long term but negligible.

No process water would be required to operate the CO₂ injection well site(s) or educational facilities. Hydrostatic testing may be required every 3 to 5 years for maintenance of the CO₂ pipeline. Water for hydrostatic testing would be obtained from available sources and trucked to the testing sites with negligible impacts on local water utilities.

Wastewater

Sanitary wastewater generated at the CO₂ injection well site(s) would be disposed onsite and would not impact local wastewater utilities.

The sanitary wastewater generation by the educational facilities is projected at 15 gpd for each employee and 10 gallons per visitor. **Under the original design analyzed in the Draft EIS, one building would house the visitor and research center, while a separate building would house the training facility;**

annual sanitary wastewater generation would be 270,000 gallons, or approximately 740 gpd, for the visitor and research center and 215,000 gallons, or approximately 590 gpd, for the training facility. Thus, total sanitary wastewater generation from the educational facilities would be 1,330 gpd. **Under the current conceptual design, all visitor, research, and training facilities would be housed in one building, and approximately 485,000 gallons of sanitary wastewater would be generated per year. Regardless of the scenario, the Alliance intends to site the educational facilities within the service area of the Jacksonville Sewer Plant. The predicted sanitary discharge by the facilities would represent a less than 1 percent demand on the available capacity of Jacksonville Sewer Plant; therefore, impacts to wastewater utilities would be long term but negligible.**

Electricity

Based on electric power availability, valves for the mainline block valves would be operated by electric motor or gas-over-oil hydraulic actuators. A 6-hour uninterruptible power supply for critical instrumentation would be provided for these structures along the CO₂ pipeline. **Backup power generation would be provided in case of longer duration outages.**

During operation of the injection wells, meter station data would be transported to the site control building through the SCADA telecommunication network. Utilities for monitoring wells are assumed to be wireless; however, if electrical lines are constructed to reach each monitoring well site, a negligible increase in electricity consumption would occur during operations. **An alternative for supplying electricity to monitoring wells would be photovoltaic solar panels with batteries at each monitoring well location.**

Since publication of the Draft EIS, DOE obtained additional information on changes to existing utility infrastructure that would be needed to supply electricity to the injection site. Surface facilities at the injection wells **for the dual-site scenario, which would include** the two 710 horsepower booster pumps, would require approximately 1.1 MWe (or approximately 800 MWh per month) **of electricity per year. The updated single-site scenario currently proposed by the Alliance would require approximately 9,000 kWh of electricity per year.** Menard Electric Cooperative has analyzed the impact to their system to supply electricity to the surface facilities. **If the building requires three-phase electrical service, there would be new above-ground wooden poles and wires placed along Martin Road from Negus Road to the site, a distance of one mile. If the building can be served with single-phase electrical service, the service would be from the existing line at the corner of Beilschmidt Road and Martin Road.**

Under the original scenario of one building housing the visitor and research center and a separate building housing the training facility, the educational facilities would require a total annual energy use of 435,000 kWh and 400,000 kWh, respectively. **Under the current conceptual design, all visitor, research, and training facilities would be housed in one building, and approximately 830,000 kWh of electricity per year would be used. Regardless of scenario,** preliminary energy modeling shows that the facilities could use less than these amounts. Electricity would be provided by existing sources within Jacksonville and the additional demand is not anticipated to impact local utilities.

Backup power at the surface facilities of the CO₂ injection wells would be provided by a diesel generator and would be sufficient to operate all of the surface facility buildings functions.

Natural Gas

The educational facilities may use natural gas for space and water heating. **Under the original scenario of one building housing the visitor and research center and a separate building housing the training facility,** the maximum annual usages were projected to be 8,000 therms for the visitor and research center and 2,000 therms for the training facility. **Under the current conceptual design, all visitor, research, and training facilities would be housed in one building, and maximum annual usage is projected to be 15,300 therms per year. Regardless of scenario,** natural gas would be provided via connections to

existing gas pipelines within Jacksonville and would result in long-term but negligible impacts to natural gas utilities. **DOE assumes that connections to existing natural gas supply infrastructure would be readily available in and around the city of Jacksonville.**

Backup power to the educational facilities would be provided by a natural gas-fueled generator. **The capacity of the generator would be sufficient to operate all building functions during an outage.**

3.15.4 Impacts of the No Action Alternative

Under the no action alternative, DOE would not provide cost-shared funding for the FutureGen 2.0 Project. Although the Alliance may still elect to construct and operate the project in the absence of DOE cost-shared funding, for the purposes of the analysis in this EIS, DOE assumed the no action alternative is equivalent to the no-build alternative. Therefore, the project would not be constructed and there would be no change to utilities. Because the Meredosia Energy Center suspended operations at the end of 2011, the no action alternative would not restore electrical generating capacity at the facility.

INTENTIONALLY LEFT BLANK

3.16 COMMUNITY SERVICES

3.16.1 Introduction

This section describes the community services potentially directly and indirectly affected by the construction and operation of the FutureGen 2.0 Project, including emergency response, law enforcement, fire protection, healthcare services, and local school systems, as well as the anticipated impacts from the proposed project.

3.16.1.1 Region of Influence

The ROI for community services includes Morgan, Brown, Cass, Pike, and Scott counties. These are the counties in which DOE expects almost all construction and operations workers would live, and they are the counties that would primarily provide law enforcement, fire, and emergency services needed as a result of the FutureGen 2.0 Project. The proposed project would occur entirely within Morgan County, which is the county where community services would be most affected.

Morgan County adjoins Brown, Cass, Pike, and Scott counties. Morgan County is also bordered by Greene, Sangamon, and Macoupin counties; however, these three counties are relatively farther away from the sites of the proposed project; therefore, community services in these three counties are not anticipated to be impacted by the proposed project and were not analyzed.

3.16.1.2 Method of Analysis and Factors Considered

To evaluate the effects of the FutureGen 2.0 Project on community services, DOE considered the potential impacts of the proposed project on existing service levels, response times, and other performance objectives.

Potential impacts were assessed based on whether construction and operation of the proposed project would:

- Displace, impede effective access to, or increase demand beyond available capacities of emergency response services, fire protection, law enforcement, healthcare facilities, and school systems in the ROI; or
- Conflict with local and regional plans for emergency response services, fire protection, law enforcement, healthcare facilities, or school systems.

3.16.1.3 Regulatory Framework

Community services are generally regulated by county and municipal governments based on state and national standards and guidelines. Local planning commissions (or regional agencies) are responsible for studying the needs and conditions of a region and for developing strategies that enhance the region's community services. Capacities and effective access to community services are addressed in regional plans and municipal ordinances. Local governments also have primary responsibility for response to and recovery from disasters and emergencies. The Morgan County Regional Planning Commission is responsible for regional planning in Morgan County (Morgan County 2012). The IEMA assists local governments when their capabilities are exceeded (IEMA 2011).

3.16.2 Affected Environment

3.16.2.1 Meredosia Energy Center, CO₂ Pipeline, CO₂ Storage Study Area, and Educational Facilities

The Meredosia Energy Center, CO₂ pipeline corridor, and the CO₂ storage study area are located in Morgan County. The educational facilities are expected to be located in or near Jacksonville, Illinois, which is also in Morgan County.

Emergency Response

The IEMA is responsible for preparing Illinois for natural, man-made, or technological disasters, hazards, or acts of terrorism, and assists local governments when their capabilities are exceeded (IEMA 2011). The IEMA maintains the Illinois Emergency Operations Plan and coordinates the state's disaster mitigation, preparedness, response, and recovery programs and activities (IEMA 2010). The IEMA maintains a 24-hour Communication Center and State Emergency Operations Center. The State Emergency Operations Center leads crisis/consequence management response and operations to notify, activate, deploy, and employ state resources.

The IEMA supports disaster stricken communities, however, historically has not included emergency medical services, fire services, technical rescue, urban search and rescue, or hazardous materials operations teams. The Mutual Aid Box Alarm System works in partnership with the IEMA to mobilize local emergency medical, municipal fire, and special operations assets in order to provide a comprehensive statewide mutual aid response system (MABAS 2011). During an emergency, system alarms provide speed of response by emergency resources. The Mutual Aid Box Alarm System's emergency resources include approximately 1,000 of the state's 1,200 fire departments; 35,000 of Illinois' 40,000 firefighters; more than 1,500 fire stations; 2,495 engine companies; 469 ladder trucks; 1,100 ambulances (mostly paramedic capable); 297 heavy rescue squads; and 788 water tenders (MABAS 2011). An additional 1,000 emergency vehicles are provided by fire/emergency medical services reserve units. The Mutual Aid Box Alarm System also offers 42 specialized operations teams for hazardous materials, as well as certified fire investigators that can be "packaged" as teams for larger incidents requiring complicated and time-consuming efforts for any single agency.

A volunteer ambulance service provides emergency response in Meredosia. Response times average between 5 to 10 minutes. Two ambulance providers operate in the city of Jacksonville (Lifestar and American), as well as paramedic services that operate from Passavant Area Hospital in Jacksonville. Emergency response services in Meredosia and Jacksonville are categorized as sufficient (Werries 2012; Kluge 2012).

Fire Protection

There are 8 fire departments in Morgan County and a total of 25 fire stations in Brown, Cass, Pike, and Scott counties. The Meredosia Fire Department is located less than 1 mile from the energy center in the village of Meredosia. The city of Jacksonville is served by the Jacksonville Fire Department. The Jacksonville Fire Department also provides fire protection services outside of the city limits to residences or private entities that purchase a rural fire protection contract. For those residences or entities that do not purchase a rural fire protection contract, the nearest volunteer fire department is dispatched to the incident (Kluge 2012). Table 3.16-1 summarizes fire protection statistics within the ROI.

Table 3.16-1. Fire Department Statistics

Region	Fire Departments	Active Firefighters (Career)	Personnel per 1,000 Population (Active Career)	Active Firefighters (Volunteer)	Personnel per 1,000 Population (Active Volunteer)
United States	48,978	325,111	1.1	596,948	1.9
Illinois	1,809	15,300	1.2	15,205	1.2
Brown County	4	0	0	73	10.5
Cass County	6	6	0.4	80	5.9
Morgan County	8	25	0.7	85	2.4
Pike County	12	0	0	216	13.1
Scott County	3	0	0	67	12.5

Sources: USCB 2010d; USFA 2012

Note: The National Fire Department Census is a voluntary program and does not include all fire departments in the United States.

Law Enforcement

Morgan County is served by the Morgan County Sheriff’s Office, District 9 of the Illinois State Police, and six police departments located in Chapin, Franklin, Jacksonville, Meredosia, South Jacksonville, and Waverly, Illinois. Ten Police Departments, four Sheriff’s Offices, and Districts 9 and 20 of the Illinois State Police serve Brown, Cass, Pike, and Scott counties (ISP 2009; ISP 2012) (see Table 3.16-2).

Full-time civilian and sworn law enforcement personnel ratios are lower in the ROI than in the state and United States; however, the crime rates in the ROI are substantially lower, indicating an adequate existing level of law enforcement services (see Table 3.16-3).

Table 3.16-2. Law Enforcement Employee Information

Region	Full-Time Personnel (Civilian and Sworn)	Full-Time Personnel (Civilian and Sworn) per 1,000 Population
United States	1,021,456	3.5
Illinois	47,326	3.7
Brown County	15	2.3
Cass County	23	1.7
Morgan County	99	2.8
Pike County	35	2.1
Scott County	9	1.7

Sources: ISP 2009; FBI 2009

Table 3.16-3. Crime Statistics

Region	Total Crime Index Offenses	Crime Rate per 100,000 Population
United States	10,639,369 ^a	3,465.5
Illinois	425,720	3,299.8
Brown County	78	1,186.7
Cass County	280	2,062.8
Morgan County	707	2,005.6
Pike County	102	617.5
Scott County	44	849.3

Sources: ISP 2009; FBI 2011

^a Sufficient data are not available to estimate national totals for arson; therefore, this total excludes arson.

Note: Crime offense includes murder, criminal sexual assault, robbery, aggravated assault/battery, burglary, theft, motor vehicle theft, and arson.

Healthcare Services

The Passavant Area Hospital, located in Jacksonville, is the only hospital in Morgan County. There is one hospital located in the adjacent counties, Pittsfield’s Illini Community Hospital, located in Pike County. There are no hospitals in Brown, Cass, or Scott counties (IDPH 2011). Table 3.16-4 lists healthcare statistics in the ROI.

Table 3.16-4. Healthcare Statistics

Region	Hospital Beds	Hospital Beds per 1,000 Population
United States	756,274	2.5
Illinois	31,491	2.5
Brown County	0	0
Cass County	0	0
Morgan County	121	3.4
Pike County	25	1.5
Scott County	0	0

Sources: USCB 2010d; Health Resources and Services Administration 2011; IDPH 2012; American Hospital Directory 2011

Local School System

There are 21 public schools and 5 private schools in Morgan County, with total 2009–2010 school year enrollments of 5,176 and 551 students, respectively.

The adjacent counties of Brown, Cass, Pike, and Scott have a total of 32 public schools and 3 private schools (there are no private schools in Pike or Scott counties). The 2009–2010 total school year enrollment was 6,990 for public schools and 202 for private schools. Tables 3.16-5 and 3.16-6 list public and private school statistics in the ROI. Average student to teacher ratios in both public and private schools are substantially lower than in Illinois and the United States, indicating an adequate level of educational services in these schools.

Table 3.16-5. Public School Statistics

Region	Schools	Average Student to Teacher Ratio
United States	98,817	16.1
Illinois	4,405	16.0
Brown County	3	14.4
Cass County	11	12.9
Morgan County	21	11.9
Pike County	13	12.0
Scott County	5	12.1

Sources: NCES 2011a; NCES 2012

Table 3.16-6. Private School Statistics

Region	Schools	Average Student to Teacher Ratio
United States	33,366	10.7
Illinois	1,733	12.0
Brown County	1	9.6
Cass County	2	8.1
Morgan County	5	9.5
Pike County	0	NA
Scott County	0	NA

Sources: NCES 2011b; NCES 2012
 NA = not applicable

3.16.3 Impacts of Proposed Action

3.16.3.1 Construction Impacts

The construction schedule and workforce anticipated for the oxy-combustion facility, CO₂ pipeline, CO₂ injection wells, and educational facilities are described in respective sections of Chapter 2. The **Draft EIS analyzed the** need for up to 942 construction workers for the proposed project, which would be limited in duration but would likely cause a small influx of temporary residents. **The current design of the proposed project would require approximately 882 construction workers.** DOE anticipates that most of the potential workers for the construction phase would already reside in the ROI as included in the county labor pools; however, some construction workers with specialized training, and workers employed by contractors from outside the ROI, would be brought into the area. Most workers would be expected to commute to the construction sites on a daily basis, while some would relocate to the area for the duration of the construction period. Section 3.18, Socioeconomics, addresses the potential influx of temporary construction workers and the effects on population and housing.

Meredosia Energy Center, CO₂ Pipeline, CO₂ Storage Study Area, and Educational Facilities

Emergency Response

Section 3.17, Human Health and Safety, addresses the potential for accidents and injuries during construction for the FutureGen 2.0 Project based on projects comparable in size and scope. Emergencies during construction of the proposed project would not be expected to increase the demand for emergency services beyond current available capacity. As discussed in Section 3.16.2.1, the ROI is served by an adequate emergency staff locally, supplemented by services throughout Illinois that would be available for local response. Therefore, the potential impacts to emergency services during construction of project components would be negligible.

Section 3.13, Traffic and Transportation, discusses the potential increase in automobile accidents as a result of increased truck traffic during construction, which could affect the demand for emergency services and response times. The overall impact on emergency response due to increased traffic in the area would be negligible.

Fire Protection

Construction of the FutureGen 2.0 Project would involve the use of flammable and combustible materials that could pose an increased risk of fire or explosion. However, the probability of a significant fire or explosion during construction is very low, as described in Section 3.17, Human Health and Safety. The Illinois fire departments within the ROI have the capacity and are equipped to respond to a major fire

emergency during construction at the Meredosia Energy Center, CO₂ pipeline, injection wells, and educational facilities. All fire departments within the ROI are members of the state's mutual aid agreement, and any of these fire departments would be available to assist in a fire emergency if needed. Any incidents that may occur during construction for the proposed project would not increase the demand for fire protection services beyond the available capacity of currently existing services, nor would construction activities displace any fire protection facilities, conflict with local and regional plans for fire protection services, or impede access for fire protection services. Thus, potential impacts to fire protection services due to construction of the proposed project would be negligible.

Law Enforcement

As discussed in Section 3.18, Socioeconomics, construction jobs created by the proposed project could cause a small increase in temporary residents within the ROI; however, most construction workers are expected to be drawn from county labor pools and would already reside within the ROI. An increase in temporary residents would result in additional calls for service. Given the adequate existing capacity, law enforcement services could accommodate the temporary increase in population. Construction for the proposed project would not displace any law enforcement facilities, impact law enforcement access, or conflict with local and regional plans for law enforcement services. Therefore, potential impacts to law enforcement due to construction of the project would be negligible.

Healthcare Services

The five-county ROI ratio of 1.9 beds per 1,000 residents is lower than the Hill-Burton Act standard of 4.5 hospital beds per 1,000 residents and the state and national averages of 2.5 hospital beds per 1,000 residents, mainly because Brown, Cass, and Scott counties lack hospital facilities. However, Morgan County has 3.4 beds per 1,000 residents, which is higher than the state and national averages. Although the project could result in a temporary increase in residents possibly requiring medical care, such an increase is not anticipated to adversely affect the existing LOS at local hospitals. It is anticipated that the two nearest hospitals would be capable of meeting the healthcare service needs that would arise during construction. Construction for the FutureGen 2.0 Project also would not displace any healthcare facilities, impact access to healthcare, or conflict with local and regional plans for healthcare services. Therefore, potential impacts to healthcare services due to construction of the project would be negligible.

The Hill-Burton Act of 1946 established the objective standard for the number of hospitals, beds, types of beds, and medical personnel needed for every 1,000 people. The Hill-Burton standard is 4.5 beds per 1,000 residents (E-Notes 2011).

Local School System

As noted above, DOE anticipates that most of the potential workers for the construction phase would already reside in the ROI as included in the county labor pools. Due to the temporary nature of the construction phase of the proposed project, it is unlikely that construction workers who reside outside of the ROI would permanently relocate their families, including school-age children, to the ROI. It is more likely that temporary workers who permanently reside outside of the ROI would seek short-term lodging for themselves during the work week. In addition, construction of the proposed project would not displace school facilities or conflict with local and regional plans for school system capacity or enrollment. As a result, potential impacts to local school systems due to construction would be negligible.

3.16.3.2 Operational Impacts

Prior to suspension of operations at the end of 2011, the energy center employed approximately 57 personnel. Since the suspension of operations, a few maintenance and security personnel are onsite, as needed. The operations phase of the proposed project **analyzed in the Draft EIS** would employ approximately 130 to 158 full-time equivalent (FTE) employees (i.e., permanent and contract employees) as described for the oxy-combustion facility, CO₂ injection wells, and educational facilities in respective sections of Chapter 2. **The current design of the proposed project would employ approximately 124 to 152 FTE employees.** Most of these workers would already reside in the ROI, while others would

commute or relocate to the ROI. Section 3.18, Socioeconomics, addresses the potential influx of permanent workers and the effects on population and housing.

Meredosia Energy Center, CO₂ Pipeline, CO₂ Storage Study Area, and Educational Facilities

Emergency Response

Section 3.17, Human Health and Safety, addresses the potential for accidents and injuries during operation of the FutureGen 2.0 Project based on comparable projects of size and scope. Emergencies during operations would not be expected to increase the demand for emergency services beyond the current available capacities described in Section 3.16.2.1. In addition, a comprehensive statewide mutual aid response system is in place to notify, activate, and deploy emergency response resources to the ROI in the event of an emergency. The operation of the project would not displace any emergency response facilities, conflict with local and regional plans for emergency response services, or impede access to emergency response services. Therefore, the potential impacts to emergency services during operations would be negligible.

Section 3.13, Traffic and Transportation, discusses the potential increase in automobile accidents as a result of increased truck traffic due to operations, which could affect the demand for emergency services and response times. The overall impact on emergency and disaster response due to increased traffic in the area would be negligible.

Section 3.17, Human Health and Safety, describes the risks of catastrophic accidents and intentionally destructive acts during operations of the FutureGen 2.0 Project. The risks to public health and safety are considered to be very low, and the emergency response capabilities are expected to be adequate to address these risks.

Fire Protection

Operation of the proposed project would involve the use of flammable and combustible materials that pose an increased risk of fire or explosion at the project site; however, the probability of a significant fire or explosion is very low as described in Section 3.17, Human Health and Safety. Prior to operation of the proposed project, copies of the MSDSs (that provide the information needed to allow the safe handling of hazardous substances) for the process materials and chemicals to be stored and used would be provided to the local fire departments. The Illinois fire departments within the ROI have the capacity and are equipped to respond to a major fire emergency. All fire departments within the ROI are members of the state's mutual aid agreement and any of these fire departments would be available to assist in a fire emergency if needed. Operation of the proposed project would not displace any fire protection facilities, nor would it conflict with local and regional plans for fire protection services. Any incidents that may occur during operation for the proposed project would not increase the demand on fire protection services beyond the available capacity of existing services. Thus, the potential impact to fire protection services due to operations would be negligible.

Law Enforcement

A small potential increase in population as a result of operations of the FutureGen 2.0 Project would have a negligible effect on the ratio of law enforcement officers per 1,000 residents. In addition, the average crime rate in the five-county ROI is less than half of the state and national averages, indicating that existing law enforcement services are appropriately staffed and would be capable of handling any small long-term increase in population. Operation of the proposed project would not displace or impede access to any law enforcement facilities, nor would it conflict with local and regional plans for law enforcement services. Therefore, potential impacts to law enforcement due to operations would be negligible.

Healthcare Services

Currently, healthcare capacity within the five-county ROI is 1.9 hospital beds per 1,000 residents, which is lower than the Hill-Burton Act standard and state and national averages, mainly because Brown, Cass,

and Scott counties lack hospital facilities. However, Morgan County has 3.4 beds per 1,000 residents, which is higher than the state and national averages. Although the project could result in a slight increase in residents possibly requiring medical care, such an increase is not anticipated to adversely affect the existing LOS at local hospitals even if all positions were filled by newcomers to the ROI with their families. Operations for the proposed project would not displace any healthcare facilities or conflict with local or regional plans for healthcare or emergency services. Therefore, potential impacts on healthcare services due to operations would be negligible.

Local School System

Operations for the proposed project could result in the permanent relocation of families to the ROI and cause slight increases in the number of school-aged children. Because most workers are expected to be hired from within the labor pool of the ROI, only a small number of families with school-age children are expected to relocate to the ROI. Existing school facilities within Morgan County would have the capacity to accommodate the anticipated small increase in enrollment that may result from the proposed project, because class sizes in the ROI are currently smaller than the averages in the state and United States as discussed in Section 3.16.2.1. In addition, operation of the proposed project would not displace school facilities or conflict with local and regional plans for school system capacity or enrollment. Therefore, potential impacts on local schools due to operations would be negligible.

3.16.4 Impacts of the No Action Alternative

Under the no action alternative, DOE would not provide cost-shared funding for the proposed action. Although the Alliance may still elect to construct and operate the project in the absence of DOE cost-shared funding, for the purposes of the analysis in this EIS, DOE assumed that the no action alternative is equivalent to a no-build alternative. Therefore, the proposed action would not be constructed and there would be no changes in demand on community services.

3.17 HUMAN HEALTH AND SAFETY

3.17.1 Introduction

This section describes the affected environment as it relates to occupational and human health and safety, and health and safety risks that could be associated with the FutureGen 2.0 Project. The section includes information on health and safety regulations, toxicity characteristics for relevant gases, worker safety and injury data, and data on populations that could potentially be affected. Health and safety risks were estimated based on the current design of the project, applicable DOE Guidance (DOE 2002; DOE 2004), applicable safety and spill prevention regulations, and expected operating procedures. DOE also considered federal, state, and local health and safety regulations, as well as industrial codes and standards that would govern work activities during construction and operation of the project to protect the health and safety of the workers and the public.

3.17.1.1 Region of Influence

The ROI for human health, safety, accidents, and intentional destructive acts was determined based on maximum reasonably foreseeable accident release scenarios (i.e., the maximum release scenarios) and the area that could potentially be impacted by such releases. The ROI for potential releases from operation of the oxy-combustion facility was estimated to be 2 miles from the Meredosia Energy Center boundary. This distance was determined based on the maximum predicted distance for potential adverse health effects that could result from an accidental release of gases from the site. A distance of 2 miles from the centerline of the Alliance's proposed pipeline corridor was used as the ROI for the CO₂ pipeline, which was considered the distance within which a person could experience any adverse effects from an accidental pipeline release. As indicated in the impact analysis presented in Section 3.17.3, the actual distance at which adverse effects could occur would likely be substantially less than 2 miles. DOE considered an ROI for the injection well site(s) of 2 miles from the wells, representing the expected maximum lateral distance of the underground CO₂ plume. The Alliance used data collected from the stratigraphic well to model the CO₂ plume in support of the UIC permitting process. DOE used the modeling data to validate the ROI estimate for the maximum release scenarios, which showed that the maximum lateral distance of the plume after 20 years of injection and 50 years of post-injection migration would be less than 2 miles (Appendix G, Geological Report).

3.17.1.2 Method of Analysis and Factors Considered

DOE assessed the potential for impacts to human health and safety, based on whether the FutureGen 2.0 Project would cause:

- Worker health risks due to industrial accidents, injuries, or illnesses during construction and normal operating conditions;
- Human health risks due to accidental releases of CO₂ or other trace gases associated with captured CO₂ during transport, active CO₂ injection and storage activities, and following closure of the injection wells; or
- Human health risks due to intentional destructive acts.

Potential worker safety impacts were estimated based on national workplace injury, illness, and fatality rates. These rates were obtained from the U.S. Bureau of Labor Statistics and are based on similar industry sectors. The rates were applied to the numbers of employees anticipated during construction and operation of the project. From these data, the projected numbers of total recordable cases, lost work day cases, and fatalities were calculated.

For chemical hazards, DOE considered a full range of potential accident scenarios, including the maximum release scenario. Potential accident scenarios were considered for each aspect of the oxy-combustion facility, the CO₂ pipeline, CO₂ injection wells, and operational and post-injection releases

from the formations used for the injection and storage of CO₂. Chemical hazards, as well as other health and safety risk factors, were not considered a concern for the educational facilities based on the nature of activities expected at these facilities. The potential impacts from intentional destructive acts were evaluated based on the analysis of the maximum release from these scenarios.

Accidents considered by DOE address concerns related to the potential release of CO₂ and trace co-constituents that may be present, and related health effects that could occur from exposure. Each release scenario was carefully reviewed to determine the predicted frequency for which such an event could occur. DOE considered engineering design and controls, as well as available industry safety statistics, when determining the predicted frequency for each type of accident and release. See Section 3.17.1.3 for descriptions of frequency categories.

DOE used modeling results to assess potential health effects that could occur both for workers and the general public. To determine the nature of potential health effects, DOE compared potential exposure concentrations with health criteria published by USEPA, OSHA, and other industry groups (e.g., American Industrial Hygiene Association). See Section 3.17.1.3 for descriptors of health effects and published health criteria.

Potential exposure concentrations at receptor locations were calculated by running industry standards or USEPA-approved air quality computer models. Each accident (release) scenario was evaluated through computer modeling to determine exposure concentrations at various distances from the point of release. Dense gases such as the captured CO₂ were simulated using the SLAB model (Ermak 1990). The appropriate acute toxicity endpoints (presented in Section 3.17.1.4) were used to identify levels of exposure to chemicals that have the potential to result in adverse effects as a consequence of the exposure. CO₂ is heavier than air and can asphyxiate persons located adjacent to a pipeline puncture or rupture, so this scenario would cause an acute health risk. Therefore, the potential for CO₂ as a dense gas to accumulate in low areas or subsurface spaces is discussed with respect to the releases evaluated and the setting of the energy center, pipeline, and injection wells.

DOE used the SLAB model (Ermak 1990) and the pipeline-walk methodology to evaluate health effects resulting from potential releases of CO₂ and trace co-constituents such as hydrogen sulfide, sulfur dioxide, and sulfur trioxide that could be present in the CO₂ stream in very low levels from the pipeline and proposed injection wells during operation.¹ Under normal operations, the concentrations of the trace gases would be low and below the exposure criteria. However, DOE simulated the release of higher concentrations for the purposes of evaluating maximum release scenarios. DOE also considered various atmospheric (weather) conditions as part of the analysis. For each scenario, DOE used the modeling results and population data (based on 2010 U.S. Census block population densities) for the areas that could be impacted by a release to estimate the number of individuals that could potentially be affected and the types of effects that could occur.

Air dispersion modeling was used to predict the concentrations of CO₂ and trace gases in air to estimate the potential for exposure and impacts to human receptors. The concentrations of CO₂ and trace gas in releases to the atmosphere from the CO₂ pipeline and the injection wells were simulated using the SLAB model. The SLAB model simulates both normal and dense gases using thermodynamic properties, including supercritical CO₂. The pipeline-walk methodology, developed for and used in a previous DOE project (DOE 2007a; DOE 2007b), was used to evaluate the effects of the gas phase releases along the

¹ The CO₂ acceptance specification provided by the Alliance indicates that the CO₂ stream from the oxy-combustion facility into the CO₂ pipeline would contain less than 25 parts per million of total sulfur (see Table 3.17-7). For purposes of analysis, total sulfur content was evaluated as sulfur dioxide and sulfur trioxide based on the ratio of estimated emissions from the oxy-combustion facility. The sulfur dioxide was estimated at 7.9 parts per million and sulfur trioxide as 16.9 parts per million, so that the total was less than 25 parts per million. Under average operating conditions, the sulfur emissions are expected to be less, with negligible sulfur trioxide emissions and low sulfur dioxide emissions. No detectible amounts of hydrogen sulfide would be expected.

entire length of the pipeline and to calculate the number of individuals hypothetically exposed to CO₂ and trace gases from simulated pipeline ruptures and punctures. This method involves incrementally analyzing release points at approximately 1,000-foot segments of the pipeline for the range of meteorological conditions likely to occur at each point. There are five main steps in the pipeline-walk method for pipeline rupture and puncture release scenarios:

- **Step 1. Summarize meteorological conditions that affect vapor plume transport.** The meteorological data are used to estimate the proportion of time over a year that each atmospheric state occurs (all combinations of 16 wind directions and 7 stability conditions, for a total of 112 cases).
- **Step 2. Simulate the area potentially affected by a pipeline release.** The SLAB model is used to determine the surface area of the potential impact zone for each of the defined atmospheric states. Separate runs are performed for each potential health-effect level and exposure period for the rupture and puncture scenarios.
- **Step 3. Estimate population affected for each atmospheric state.** The polygons representing the areal extent of each predicted exposure zone for each simulation are superimposed onto a map of the population density data at a point along the pipeline route. The population within the estimated vapor (atmospheric) plume area is computed for each census block and then summed if more than one block could be affected.
- **Step 4. Determine the expected number of individuals potentially affected at the specified release points.** The affected population in each exposure zone is next multiplied by the proportion of the time (relative importance) that exposure to a given zone could occur. This process is repeated for each of the defined atmospheric states (a total of 112 cases to represent all 16 wind directions and 7 stability classes). Since all the atmospheric state cases sum to one, the sum of these products provides the expected number of affected individuals at any selected point along the pipeline.
- **Step 5. Characterize the potential exposure along the entire pipeline.** Tabular and graphical summaries of the expected number of affected individuals at points along the pipeline provide a comprehensive summary of potential health effects from a hypothetical pipeline release.

The pipeline-walk routine was repeated for each criteria concentration and exposure duration for the full set of increments at an approximate spacing of 1,000 feet along the entire pipeline route. Separate simulations using the SLAB model were made if the volume in a pipeline segment would change due to a different length between mainline block valves.

For potential releases during active injection, the SLAB model was used to estimate the CO₂ concentrations in air and the extent of a resulting atmospheric CO₂ plume due to a release both from a vertical and a horizontal injection well. Steps 3 through 5 of the pipeline-walk routine were conducted at multiple locations to represent the effects of different well locations and to estimate the expected number of people potentially affected.

Human health risks resulting from intentionally destructive acts were addressed in conjunction with the risk analysis described in the following subsection.

3.17.1.3 Risk Analysis

To evaluate the risk of each accident scenario, DOE considered both the likelihood of the scenario occurring and the potential consequences for that scenario. The likelihood of each scenario has been characterized in terms of frequency based on available industry data. The consequence of each scenario was characterized in terms of potential health effects based either on physical injury or on effects from chemical exposure using available exposure criteria. The proposed operational period for the FutureGen

2.0 Project is 20 years; however, for risk assessment, DOE assumed a conservative operational period of 30 years.

The frequency of an accident is the chance that the accident might occur and is typically discussed in terms of the number of occurrences over a period of time. For example, the frequency of occurrence for an accident that can be expected to happen once every 50 years, or one accident divided by the 50-year period, is 2×10^{-2} per year. DOE classified each accident scenario into frequency categories:

- **Possible:** Accidents estimated to occur one or more times in 100 years of facility operations (frequency $\geq 1 \times 10^{-2}$ per year);
- **Unlikely:** Accidents estimated to occur between once in 100 years and once in 10,000 years of facility operations (frequency from 1×10^{-2} to 1×10^{-4} per year);
- **Extremely Unlikely:** Accidents estimated to occur between once in 10,000 years and once in 1 million years of facility operations (frequency from 1×10^{-4} to 1×10^{-6} per year); and
- **Incredible:** Accidents estimated to occur less than once in 1 million years of facility operations (frequency $< 1 \times 10^{-6}$ per year).

The potential consequences of an accident are the range of potential health effects that could occur as a result of the accident. DOE characterized these effects using established criteria as either:

- **Transient and reversible adverse effects:** Headache, dizziness, sweating, and/or vague feelings of discomfort;
- **Irreversible or serious adverse effects:** Breathing difficulties, increased heart rate, convulsions, and/or coma; or
- **Life-threatening effects.**

DOE's Subcommittee on Consequence Actions and Protective Assessments has developed a database of protective action criteria (PAC) to provide criteria for determining the potential health effects from exposure to accidents. The current version of the PAC database is Revision 27 (SCAPA 2012). The criteria for a given chemical are selected in the following order from criteria set by government and industry groups: (1) Acute Exposure Guideline Levels set by the USEPA, (2) Emergency Response Planning Guidelines (ERPG) acute toxicity endpoints set by the American Industrial Hygiene Association, and (3) Temporary Emergency Exposure Limits (TEELs) set by the Subcommittee on Consequence Actions and Protective Assessments. The PACs that correspond to the three levels of health effects (transient adverse, irreversible adverse, or life-threatening) are as follows:

- **PAC-1:** The maximum airborne concentration below which it is believed nearly all individuals could be exposed for up to 1 hour without experiencing other than mild *transient adverse health effects* or perceiving a clearly defined objectionable odor.
- **PAC-2:** The maximum airborne concentration below which it is believed nearly all individuals could be exposed for up to 1 hour without experiencing or developing *irreversible* or other serious health effects or symptoms that could impair an individual's ability to take protective action.
- **PAC-3:** The maximum airborne concentration below which it is believed nearly all individuals could be exposed for up to 1 hour without experiencing or developing *life-threatening health effects*.

3.17.1.4 Potential Health Effects of CO₂ (and other captured gas constituents)

Table 3.17-1 provides health risk criteria for the public and the workers for exposure to CO₂, hydrogen sulfide, sulfur dioxide, and sulfur trioxide. Table 3.17-2 provides the concentrations of CO₂, hydrogen sulfide, sulfur dioxide, and sulfur trioxide that are not likely to cause adverse effects to humans (including sensitive subgroups) for longer exposure periods (up to a lifetime). Long-term criteria for low levels of CO₂ have not been established because CO₂ is an acute health hazard, rather than a chronic health hazard. Studies have found no evidence of any adverse health impact from long-term exposure to low levels (below 1 percent) of CO₂ (IPCC 2005).

No health effects to the general public, including susceptible individuals, are expected to occur at CO₂ concentrations of 5,000 parts per million or less. This concentration represents the “no effect” level (TEEL-0 limit), or the level below which there would be minimal or no risk of adverse effects (DOE 2008a). Health effects from inhalation of concentrations of CO₂ gas higher than 5,000 parts per million can range from headache, dizziness, sweating, and vague feelings of discomfort to breathing difficulties, increased heart rate, convulsions, coma, and possibly death. Exposure to a concentration of 5,000 parts per million up to 30,000 parts per million for 1 hour or less, constitutes PAC-1 exposure, possibly resulting in mild, reversible effects. Exposure to concentrations above 30,000 parts per million but less than 50,000 parts per million constitutes PAC-2 exposure, possibly resulting in irreversible adverse effects.² The PAC-3 level is 50,000 parts per million. These levels are based on TEEL limits, since no Acute Exposure Guideline Levels or ERPGs have been adopted for CO₂.

Table 3.17-1. Potential Health Effects from Exposure to CO₂ and Trace Gases

Gas	Potential Health Effects ^a	Health Protective Criteria Concentrations – Public ^b (ppmv)	Health Protective Criteria Concentrations – Workers ^c (ppmv)	ERPG Criteria Concentrations – Public ^d (ppmv)
CO ₂	No health effects	Less than 5,000		NA
	Transient and reversible adverse	5,000 to 30,000 (1 hour)	PEL: 5,000 (8 hours)	NA
	Irreversible adverse	Above 30,000 (1 hour)	IDLH: 40,000 (30 minutes)	NA
	Life-threatening	Above 50,000 (1 hour)		NA
H ₂ S	No health effects	Less than 0.33	PEL: 20 Ceiling PEL: 50 Maximum (10 minutes once in 8 hours)	Less than 0.1
	Transient and reversible adverse	Above 0.51 (1 hour) Above 0.33 (8 hours)		0.1 (1 hour)
	Irreversible adverse	Above 27 (1 hour) Above 17 (8 hours)	IDLH: 100 (30 minutes)	Above 30 (1 hour)
	Life-threatening	Above 50 (1 hour) Above 31 (8 hours)		Above 100 (1 hour)
SO ₂	No health effects	Less than 0.20	PEL: 5 (8 hours)	Less than 0.3
	Transient and reversible adverse	Above 0.20 (1 hour) Above 0.20 (8 hours)		0.3 (1 hour)
	Irreversible adverse	Above 0.75 (1 hour) Above 0.75 (8 hours)	IDLH: 100 (30 minutes)	3 (1 hour)
	Life-threatening	Above 30 (1 hour) Above 9.6 (8 hours)		25 (1 hour)

² The criteria for CO₂ changed in February 2012, so that at present the PAC-1 and PAC-2 levels are assigned to the same concentration, 30,000 parts per million (SCAPA 2012).

Table 3.17-1. Potential Health Effects from Exposure to CO₂ and Trace Gases

Gas	Potential Health Effects ^a	Health Protective Criteria Concentrations – Public ^b (ppmv)	Health Protective Criteria Concentrations – Workers ^c (ppmv)	ERPG Criteria Concentrations – Public ^d (ppmv)
SO ₃	No health effects	Less than 0.06		Less than 0.6
	Transient and reversible adverse	Above 0.06 (1 hour) Above 0.06 (8 hours)	PEL: NA	
	Irreversible adverse	Above 2.61 (1 hour) Above 2.61 (8 hours)		3 (1 hour)
	Life-threatening	Above 48.07 (1 hour) Above 27.94 (8 hours)	IDLH: NA	36.1 (1 hour)

^a Transient adverse health effects include symptoms such as headache, dizziness, sweating, or vague feelings of discomfort; irreversible or serious adverse health effects include symptoms such as breathing difficulties, increased heart rate, convulsions, or coma; life-threatening health effects include symptoms that could be fatal.

^b Based on PAC for CO₂ for exposure time of 1 hour or less established by DOE’s Subcommittee on Consequence Actions and Protective Assessments as TEELs (SCAPA 2012). PACs for H₂S and SO₂ are based on USEPA’s Acute Exposure Guideline Levels (AEGl) for multiple time periods varying from 10 minutes up to 8 hours. PACs for SO₃ are based on interim AEGlS (USEPA 2012g).

PAC-1, AEGl-1: The airborne concentration of a substance above which it is predicted that the general population, including susceptible individuals, could experience discomfort, irritation, or certain asymptomatic, non-sensory effects; however, these effects are not disabling and are transient and reversible upon cessation of exposure (SCAPA 2012; USEPA 2012g).

PAC-2, AEGl-2: The airborne concentration of a substance above which it is predicted that the general population, including susceptible individuals could experience irreversible or other serious, long-lasting, adverse health effects or an impaired ability to escape (SCAPA 2012; USEPA 2012g).

PAC-3, AEGl-3: The airborne concentration of a substance above which it is predicted that the general population, including susceptible individuals, could experience life-threatening health effects or death (SCAPA 2012; USEPA 2012g).

^c Permissible exposure limits (PELs) are legally enforceable standards established by the U.S. Occupational Safety and Health Administration (OSHA 2012). Immediately dangerous to life or health (IDLH) levels are recommended criteria established by the National Institute of Safety and Health (NIOSH 2005), designed to allow a worker to escape within 30 minutes.

^d Defined by the AIHA, ERPGs provide estimates for concentration ranges ‘below which nearly all individuals could be exposed for up to 1-hour and not experience or develop the stated level of effects as a consequence of exposure to the chemical in question.’ Values obtained from AIHA 2011. DOE policy is to use AEGlS if they are available, or if not, then ERPGs, then TEELs (SCAPA 2012).

AIHA = American Industrial Hygiene Association; CO₂ = carbon dioxide; ERPG = Emergency Response Planning Guidelines; H₂S = hydrogen sulfide; IDLH = immediately dangerous to life or health; NA = not applicable; PAC = protective action criteria; PEL = permissible exposure limit; ppmv = parts per million by volume; SO₂ = sulfur dioxide; SO₃ = sulfur trioxide; TEEL = Temporary Emergency Exposure Limit

Table 3.17-2. Longer Duration Criteria for CO₂ and Trace Gases Not Likely to Cause Appreciable Health Risks to Humans

Gas	RfC (ppm)	Acute MRL (ppm)	Intermediate MRL (ppm)	Chronic MRL (ppm)
CO ₂	None established	None established	None established	None established
H ₂ S	0.0014	0.07	0.02	None established
SO ₂	None established	0.01	None established	None established
SO ₃	None established	None established	None established	None established

Sources: ATSDR 2012 (acute, intermediate, and chronic MRLs); USEPA 2012h (H₂S RfC)

Note: MRLs are estimates of the daily human exposure to a hazardous substance that is likely to be without appreciable risk of adverse non-cancer health effects for three different exposure periods: acute MRL for 1 to 14 days, intermediate MRL for 14 to 365 days, and a chronic MRL for 365 days and longer.

CO₂ = carbon dioxide; H₂S = hydrogen sulfide; MRL = Minimal Risk Levels; ppm = parts per million; RfC = reference concentration (estimates of daily inhalation exposure likely to cause no appreciable risk of deleterious effects to humans, including sensitive subgroups, during a lifetime); SO₂ = sulfur dioxide; SO₃ = sulfur trioxide

The OSHA permissible exposure limit (PEL) and American Conference of Governmental Industrial Hygienists threshold limit value for CO₂ (based on an 8-hour time-weighted average) are both 5,000 parts per million. The PEL is the legal limit established by OSHA for exposure of an employee, expressed in

terms of a time-weighted average, which is the average exposure over a specified period of time. This means that for limited periods a worker may be exposed to concentrations higher than the PEL, so long as the average concentration over 8 hours remains lower. The threshold limit value is a concentration at which it is believed a worker can be exposed day after day for a working lifetime without adverse health effects. The American Conference of Governmental Industrial Hygienists' short-term exposure limit (STEL) is 30,000 parts per million (3 percent in air). The short-term exposure limit is a concentration which is believed workers can be exposed to routinely for a short period of time without suffering significant effects, but it should not occur more than 4 times per day and not longer than 15 minutes each time.

There are no 8-hour Acute Exposure Guideline Levels for longer-term exposure to CO₂. Therefore, for the pipeline puncture releases, anticipated CO₂ concentrations from the modeling were compared to values of 5,000 parts per million (i.e., the OSHA time-weighted average value for 8 hours); 20,000 parts per million; and 40,000 parts per million based on information from the USEPA (2000). The 20,000 and 40,000 parts per million exposure values are based on physiological tolerance times and are used in guidelines for the protection of firefighters that could be exposed to CO₂ from fire suppressant systems (USEPA 2000). Exposure to 20,000 parts per million for several hours can result in headache, tiredness, and shortness of breath upon mild exertion, and exposures up to 40,000 parts per million can result in increased blood pressure and dizziness (IPCC 2005). The concentration of 40,000 parts per million is also the immediately dangerous to life or health criterion, which was established to allow workers up to 30 minutes to escape.

3.17.1.5 Relevant Safety Factors and Statistics

Occupational Injury Data

Occupational injury and fatality data from the U.S. Bureau of Labor Statistics are presented in Tables 3.17-3 and 3.17-4. This data provides the injury or illness rates and fatality rates for utility-related construction and natural gas distribution. These rates are expressed in terms of injury or illness per 100 worker-years (or 200,000 hours) for total recordable cases, lost work day cases, and fatalities. Note these rates are used for estimating potential impacts. However, the characteristics and associated pipeline risks are different for CO₂ and natural gas.

Table 3.17-3. Occupational Injury Data for Related Industries in United States in 2010

Industry	2010 Average Annual Employment (thousands)	Total Recordable Case Rate (per 100 workers)	Lost Work Day Case Rate (per 100 workers)
Utility System Construction	384.5	3.5	1.1
Non-Residential Construction	665.2	2.9	0.8
Oil and Gas Pipeline Construction	91.9	1.7	0.5
Electric Power Generation	174.6	1.2	0.6

Source: USBLS 2012a

Table 3.17-5 shows safety incidents between 1992 and 2011 involving natural gas, CO₂, and other hazardous liquid pipelines in the United States. CO₂ pipelines have not resulted in any fatalities and injuries are rare; the annual incident frequency is 0.062 per 100 miles per year based on incident data from DOT's Office of Pipeline Safety (OPS 2012a). The major cause of failure in serious incidents considering all pipelines is damage (puncture or rupture) during excavation of existing pipelines for repair or for new pipelines (OPS 2012b). For CO₂ pipelines, weld failures and equipment leaks such as relief valves were the cause of most incidents (OPS 2012c). The incident rate for natural gas pipelines is 0.027 per 100 miles, but unlike CO₂ pipelines, fatalities have occurred.

Table 3.17-4. Fatality Data for Related Industries in United States in 2010

Industry	Fatality Rate (per 100,000 FTE workers)
Utilities	2.5
Construction	9.5
Natural Gas Distribution	3 fatalities in 2010
Electric Power Generation	5 fatalities in 2010

Sources: USBLS 2012b; USBLS 2012c (natural gas and electric power generation)
FTE = full-time equivalent

Table 3.17-5. Pipeline Safety Record in United States (1992 through 2011)

Pipelines	Natural Gas ^a	Hazardous Liquids ^b	CO ₂
Length (miles) ^c	312,290	179,042	4,560
All Incidents ^d	1,702	5,379	57
Fatalities ^d	43	41	0
Injuries ^d	221	170	1
Property Damage	\$1,505,473,000	\$2,707,529,000	\$1,910,000
Incidents/100 miles/year	0.027	0.15	0.062

Sources: OPS 2012a (incident data); OPS 2012d

^a Natural gas data includes onshore transmission and gathering lines.

^b CO₂ pipeline data have been separated from onshore hazardous liquid pipeline data. Mileage for types of hazardous liquid pipelines listed separately only through 2010, but used as 2011 mileage for incident calculation. Hazardous liquid pipeline mileage in 2010 for HVL was 64,870 and for non-HVL Petroleum-related pipelines was 120,102.

^c Based on Office of Pipeline Safety Data through 2011. Mileage data posted May 31, 2012.

^d Number of incidents

CO₂ = carbon dioxide; HVL = hazardous volatile liquid

Pipeline Safety Data

DOT's Office of Pipeline Safety administers and enforces the rules and regulations regarding CO₂ pipeline transport. States also may regulate pipelines under partnership agreements with the Office of Pipeline Safety. The rules are designed to protect the public and the environment by ensuring safety in pipeline design, construction, testing, operation, and maintenance. In pipelines that carry captured CO₂ for injection, other gases may be captured and transported as well (e.g., hydrogen sulfide or sulfur dioxide), and could affect risks posed to human health and the environment.

In 2011, there were 312,290 miles of pipelines in the United States transporting natural gas in onshore transmission and gathering lines and over 2.1 million miles of distribution lines for natural gas (OPS 2012d). Crude oil, other petroleum products, and other hazardous liquids were transported in 179,042 miles of pipelines. There were 4,560 miles of CO₂ pipelines in the United States in 2011 (OPS 2012d), of which most were used for enhanced oil recovery projects. The characteristics and pipeline transportation risks for CO₂ and natural gas or petroleum products are different. For example, CO₂ is expected to be transported by pipeline as a supercritical fluid with a density of approximately 70 to 90 percent of that of liquid water. If a leak develops along a pipeline, a portion of the escaping fluid would quickly expand to a gas, while the remainder would form a solid (i.e., dry-ice snow). CO₂ gas is approximately 50 percent heavier than air and would disperse horizontally following the ground contours. In contrast, natural gas in a pipeline is lighter than supercritical CO₂ and is more likely to disperse

upwards. Natural gas is also highly flammable and poses the risk of explosion, compared to CO₂, which is not flammable.

DOE used the Office of Pipeline Safety data to estimate CO₂ pipeline failure rates and the probabilities of pipeline release incidents for the proposed FutureGen 2.0 Project. Incident data from 1991-2011 from the online library of the Office of Pipeline Safety (OPS 2012a) were used to calculate the frequency and probability of pipeline ruptures and punctures. Six of the 57 incidents that occurred from 1991-2011 with the largest CO₂ releases (> 4,000 barrels) were designated as rupture-type releases. Using the total length of CO₂ pipelines involved (4,560 miles), the annual rupture failure frequency was calculated as 6.26×10^{-5} (miles-year)⁻¹. Ten of the next largest releases from the existing CO₂ pipelines had losses of CO₂ between 300 and 4,000 barrels. The remaining incidents had releases of less than 100 barrels, although three incidents had CO₂ losses less than 0.1 barrels and 1 incident had no loss information. The annual puncture failure frequency was calculated as 1.04×10^{-4} (miles-year)⁻¹. The annual pipeline failure frequencies and the probability of at least one failure over a conservative 30-year operational period were calculated assuming the probability of failure to be exponentially distributed with the hazard rate equal to the product of the failure frequency and the pipeline length.

Potential Industrial Hazards

The Meredosia Energy Center would store and use certain process chemicals such as ferric chloride, polymer, salt solution, sodium hydroxide, acid, caustic, antiscalant, sodium bisulfate, detergent, and sodium hydroxide. The storage and handling of toxic or flammable materials would be conducted in compliance with USEPA and OSHA regulations and the National Fire Protection Association's "Guide on Hazardous Materials" (NFPA 2010). The FutureGen 2.0 Project is not expected to store chemicals on the "List of Substances" (40 CFR 68.130) in amounts that would exceed the threshold quantities that would trigger the need for a Risk Management Plan.

The oxy-combustion facility is expected to have two liquid oxygen tanks, which are considered to be the features most likely to pose the greatest risks to health and safety from an accident during facility operations. Liquid oxygen is oxygen gas that has been purified and cooled to become a cryogenic liquid. Oxygen is classified as hazardous under OSHA's Hazard Communication Standard, 29 CFR 1910.1200, but is not listed as a regulated toxic gas or liquid subject to the USEPA Risk Management Program (USEPA 2009c).

The potential hazards from contact with liquid oxygen include the following (Air Liquide 2007; Praxair 2007):

- Oxygen is a strong oxidizer and is incompatible with organic materials including hydrocarbons (i.e., could result in a reaction that causes fire or explosion).
- Contact with combustible materials can cause fire or explosion.
- Oxygen is non-flammable, but can accelerate combustion of other materials including clothing or asphalt.
- Contact with skin, eyes, or ingestion can result in severe frostbite or freezing of tissues.
- Release of liquid oxygen from a tank results in rapid expansion to a large volume of gas, which can allow pressure to build-up if the gas leak occurs in a confined area.

In addition, the air separation unit would have three vents for the discharge of nitrogen gas removed from the air. Nitrogen-rich gas that is depleted of oxygen can present an asphyxiation hazard if the gas is not properly vented and dispersed.

3.17.2 Affected Environment

3.17.2.1 Meredosia Energy Center

The ROI for potential releases from operation of the oxy-combustion facility extends 2 miles from the Meredosia Energy Center boundary; the ROI is the distance within which an individual could experience any adverse effects from an accidental release of gases from the site. The eastern portion of this ROI overlaps with the ROI for the pipeline corridor as depicted in Figure 3.17-1. The ROI includes the village of Meredosia within Morgan County, which is part of U.S. Census Tract 9514. The 2-mile radius extends to the west into Pike County (U.S. Census Tract 9524) and to the northwest into Brown County (U.S. Census Tract 9704) (HUD 2010). The 2010 population density by census block for the Meredosia Energy Center ROI, and the western portion of the CO₂ pipeline, is shown in Figure 3.17-1.

Census data including population and sensitive receptor information are presented in Table 3.17-6 from the 2010 U.S. Census. Sensitive receptors include young children, the elderly, and those living in poverty (inadequate access to healthcare). The numbers of persons below the federal poverty level are provided by census tract, not by specific blocks. One elementary school, a high school, and a technical school are located within the ROI (Schools List 2011). No licensed daycare providers within the ROI for the energy center were identified (Daycare Centers List 2011). The nearest daycare centers are located in nearby towns including Beardstown to the north, Jacksonville to the east, and Winchester to the southeast.

Table 3.17-6. Meredosia Energy Center Region of Influence Demographics

Census Block Group	2010 Population ^a	Sensitive Receptors		
		Persons in Poverty ^b	Children Under 5 Years Old ^a	Adults 65 and Older ^a
9514003	1,342	312	90	212
9514002	760	312	35	121
9524001	743	456	53	103
9704003	1,006	193	54	188

^a U.S. Department of Commerce, Census Bureau Block Group Table P1 2010 population and Table P12 age data (USCB 2011a).

^b Profile of General Demographic Characteristics (DP-1), Census Tract 2000 (2010 data not yet available) (USCB 2000).

Downtown Meredosia is located north of the Meredosia Energy Center on the east side of the Illinois River. Meredosia had a population of 1,044 in 2010 (USCB 2011b). There are no other towns or villages within the ROI around the energy center. As discussed in Section 3.2, Climate and Greenhouse Gases, the closest available source for atmospheric data is the Springfield Capital Airport located approximately 48.2 miles to the northeast. A wind rose of this data is presented in Figure 3.2-1.

3.17.2.2 CO₂ Pipeline

The proposed 30-mile pipeline would connect the oxy-combustion facility to the injection wells. Figures 3.17-1 and 3.17-2 illustrate the Alliance’s ROI for the proposed pipeline route to the storage study area, nearby towns, and population densities in the surrounding areas. Population densities are based on the 2010 Census (USCB 2011a). **Portions of the pipeline route could move slightly as a result of final project design and to accommodate landowner requests. However, the final pipeline route would be substantially similar and impacts would be consistent with those addressed in this section.**

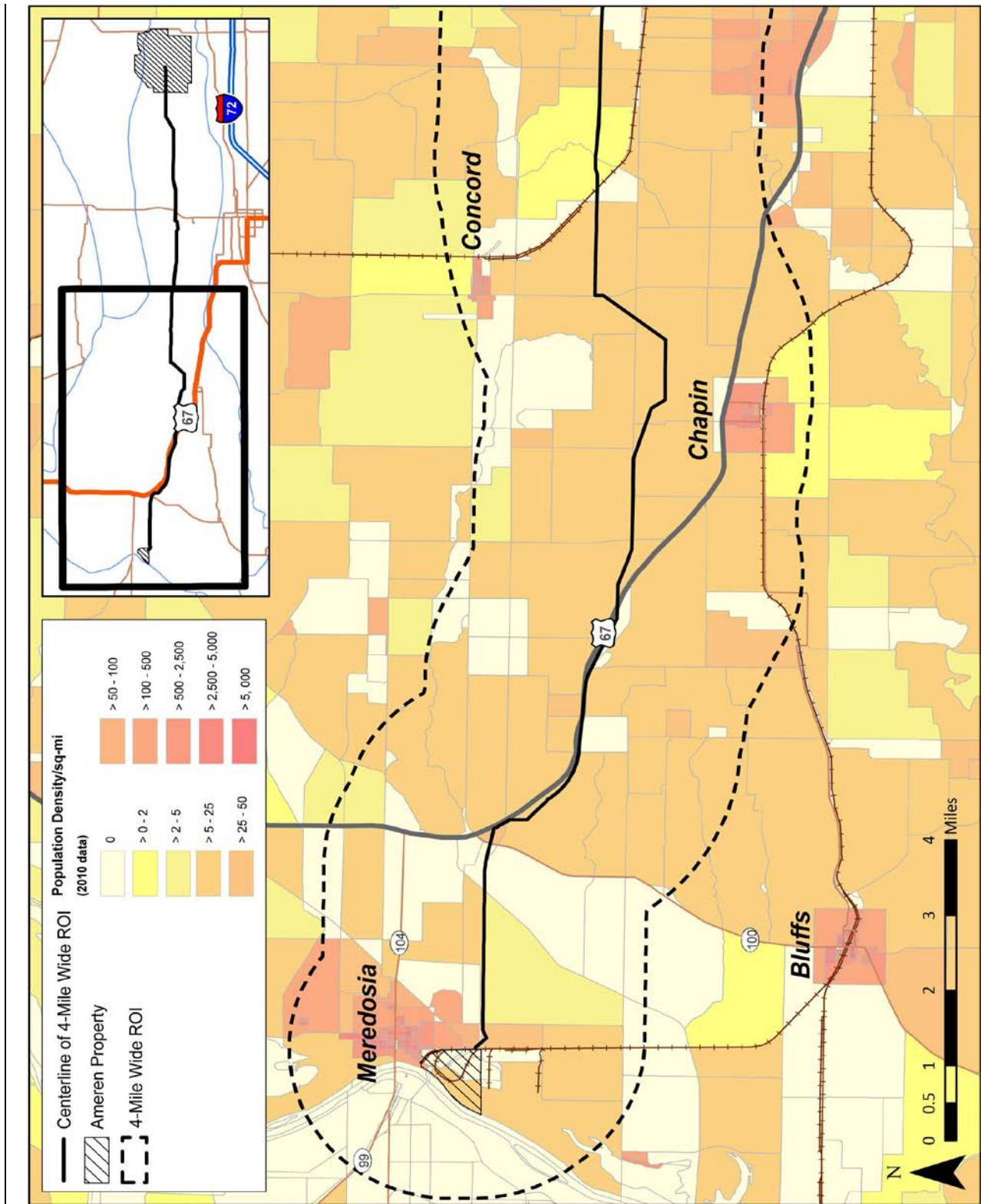

Source: USCB 2011a
 ROI = Region of Influence

Figure 3.17-1. 2010 Population Density in Vicinity of Meredosia Energy Center and Western Part of Pipeline Route to CO₂ Storage Study Area

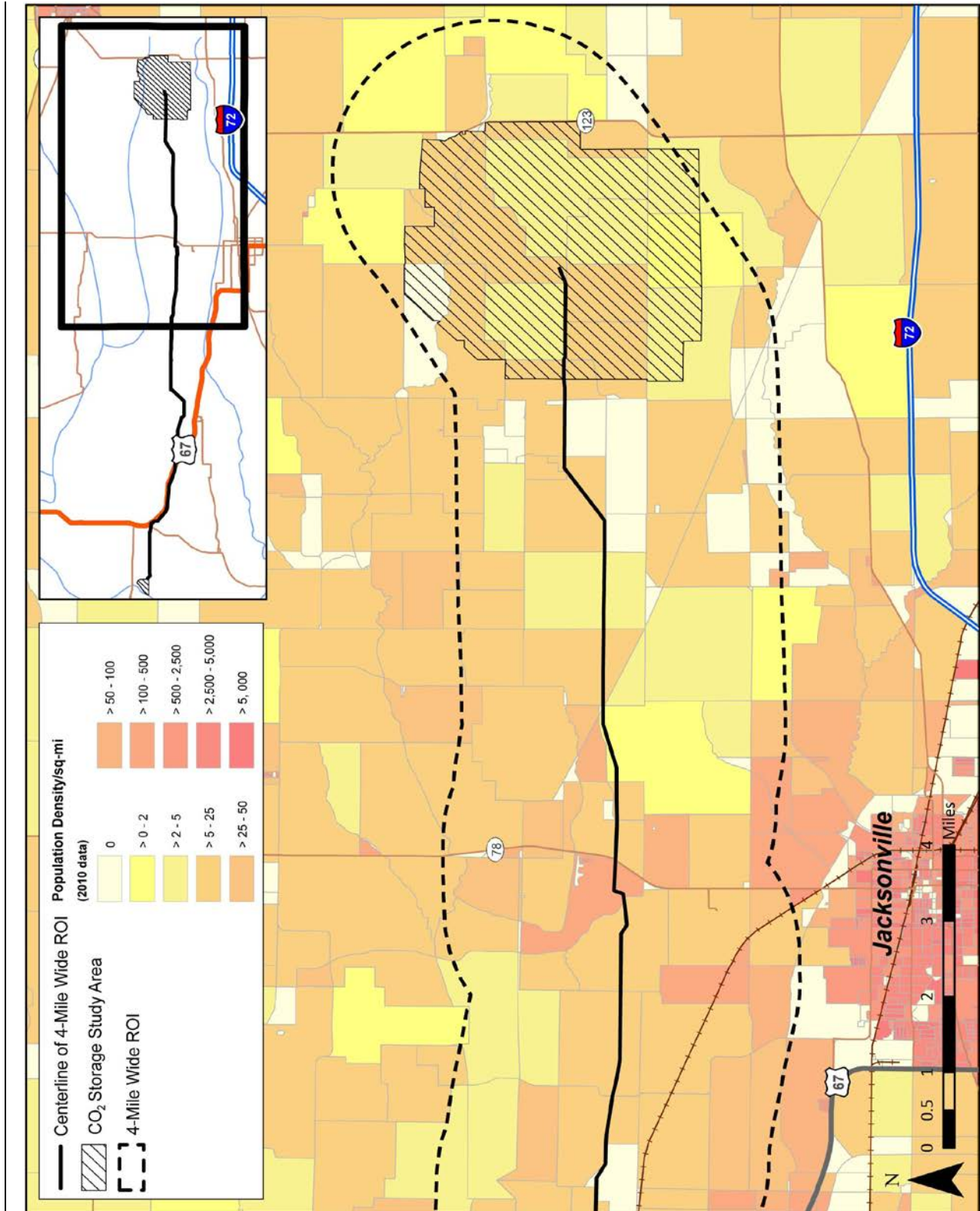

Source: USCB 2011a
 CO₂ = carbon dioxide; ROI = Region of Influence

Figure 3.17-2. 2010 Population Density in Vicinity of Eastern Part of Pipeline Route and CO₂ Storage Study Area in Morgan County

The town of Chapin and the small town of Concord are both within the ROI. Chapin is located approximately 11.4 miles east-southeast of the Meredosia Energy Center and has a 2010 population of 512. Concord is located approximately 10 miles east of the energy center and has a 2010 population of 167. Jacksonville, which is the closest population center (2010 population of 19,446), is located approximately 21.4 miles east-southeast of the Meredosia Energy Center and 6 miles southwest of the CO₂ storage study area. Jacksonville is approximately 1 mile outside of the ROI (see Figure 3.17-2).

3.17.2.3 CO₂ Storage Study Area

The CO₂ storage study area and injection wells are described in detail in Section 2.5.2. As shown in Figure 3.17-2, the nearest town to the storage study area is Jacksonville, located approximately 6 miles to the southwest of the edge of the proposed area. The Alliance evaluated several injection well configurations using both vertical and horizontal wells at one or two injection well sites within the study area. The Alliance's original configuration was for two vertical injection wells to be located on separate injection well pads located 0.5 to 1 mile apart. The project design originally planned for an annual injection of 1.2 million tons (1.1 million metric tons) of CO₂ over a 30-year period. After consideration of site-specific data from the stratigraphic well, the Alliance is currently proposing to construct and operate up to four horizontal injection wells at one injection well site for the annual injection of 1.2 million tons (1.1 million metric tons) of CO₂ over a 20-year period (a total of 24 million tons [22 million metric tons]) in the Mt. Simon Formation. All four horizontal wells would originate from a common drilling pad, but would operate independently of each other (i.e., separate wellheads). The injection well pad would also accommodate one or two monitoring wells.

The maximum subsurface plume size is estimated to be **approximately** 4,000 acres within the **6,800-acre** CO₂ storage study area. The expected maximum radius of the CO₂ plume from the injection wells would be 2 miles, as determined by the computer modeling completed by the Alliance for the currently proposed injection well configuration of four horizontal wells (see Appendix G, Geological Report). The 2010 population density within the storage study area varies between 2 to 5 people per square mile and 5 to 25 people per square mile.

3.17.2.4 Educational Facilities

The educational facilities are expected to be located in or near the city of Jacksonville, Illinois, in Morgan County. The proposed site or sites for the educational facilities would be areas that have been previously disturbed, with utilities (e.g., electricity, telecommunications, water, and sewer) located on or immediately adjacent to the site or sites. These educational facilities could involve new construction, renovation of existing structures, or a combination of new construction and renovation. Although the exact location is currently unknown, it is not anticipated that the facilities would be sited in a location that would potentially impact the human health of workers or the general public from physical or chemical hazards.

3.17.3 Impacts of Proposed Action

This section addresses the possible impacts to human health and safety (workers and public) as a result of the construction and operation of the oxy-combustion facility, the CO₂ pipeline, the CO₂ injection wells, and the educational facilities. The analysis of construction impacts is based on accident statistics for similar industries and the impacts are a function of the number of workers and the duration of the work. The analysis does not take into account the BMPs, including safety training and procedures, that would be implemented by the Alliance as described in Chapter 2 and in Section 4.2, Measures to Mitigate Adverse Impacts. These practices would be expected to reduce the potential for construction accidents to the fullest extent possible.

The analysis of impacts related to the operation of the FutureGen 2.0 Project assumes the maximum potential exposure of workers and members of the public to hazardous materials and CO₂ if an accident were to occur. For the oxy-combustion facility at the Meredosia Energy Center, these impacts relate to the

accidental release of liquid oxygen from onsite storage tanks, which is the accident determined to have the greatest potential human health impacts at the energy center. For the CO₂ pipeline, potential impacts relate to those resulting from exposure to CO₂ and trace gases as a result of a pipeline *puncture* (such as from the tooth of an excavator) or from a *rupture* (such as from a faulty weld). For the injection wells, potential impacts relate to exposures from both a small-scale release event, such as a CO₂ leak from an unknown well, and a large-scale, catastrophic event (i.e., an immediate, one-time release), such as a well failure or an earthquake. No health and safety impacts would be expected as a result of the operation of the educational facilities.

The health and safety analysis recognizes that, absent an accident, the construction and operation of the FutureGen 2.0 Project would not have adverse impacts on human health and safety. Further, with respect to potential accidents, the analysis does not take into account the myriad actions that have been undertaken by the Alliance to discover potential release pathways, such as existing groundwater and oil and gas wells or geologic faults, or protective measures that would be built into the design and operation of the oxy-combustion facility, pipeline, and injection facilities. Such measures, as described in Chapter 2 and Section 4.2, Measures to Mitigate Adverse Impacts, include hydrostatic testing of the pipeline prior to operation, automatic sensors and alarms, warning signs, remotely-operated and manual block valves to stop flow, extensive monitoring activities along the pipeline and at the CO₂ injection wells, and safety training and procedures. These measures would be expected not only to reduce the potential for exposure, but also to significantly reduce the volume of hazardous materials and CO₂ to which workers and the public could be exposed and the time of exposure if an accident or unexpected event were to occur. The analysis also discusses the very low probability that any of the initiating events may occur.

3.17.3.1 Construction Impacts

Meredosia Energy Center, CO₂ Pipeline, CO₂ Storage Study Area, and Educational Facilities

Construction of the proposed project would have minor short-term impacts. The number of construction workers for the oxy-combustion facility at the Meredosia Energy Center is expected to have a peak of 500 construction and craft workers on any given day in June through December 2015. The incident rate for potential construction accidents was presented in Section 3.17.1.5. Based on incident rates for utility system construction, the number of lost work days during construction of the oxy-combustion facility is estimated to be 2.8 during peak construction and could potentially total to 10.3 days over the entire construction period with no fatalities. Construction of the CO₂ pipeline, injection wells, and educational facilities would require a total of approximately 300 to 425 construction workers, and would potentially result in 2.2 lost work days. As a result, a total of 12.5 lost work days could occur over the entire construction period for all project components. No fatalities would be expected. **Since publication of the Draft EIS, the Alliance continued to develop its conceptual and preliminary designs for the proposed project. The design changes resulted in a reduction in the number of construction workers required for the CO₂ pipeline, injection wells, and educational facilities to approximately 230 to 380 workers. The reduction in construction workers would result in a reduction in the potential lost work days.**

3.17.3.2 Operational Impacts

Meredosia Energy Center

Potential health and safety impacts during normal operation of the oxy-combustion facility would generally be limited to workers directly involved in facility operation and maintenance, and would be related primarily to worker injuries that are typical of similar industrial facilities. Based on the industry-specific incident data presented in Tables 3.17-3 and 3.17-4, the upper bound for annual total recordable cases would be 1.4 with less than one lost work day for facility workers. In addition, based on these data no fatalities would be expected to occur over the operating life of the facility.

As described in Section 3.1, Air Quality, modeling of air pollutant emissions from the oxy-combustion facility indicates that the emissions would not exceed significant impact levels and are therefore considered de minimis. Therefore, adverse health effects from facility air emissions are not expected to occur.

DOE evaluated the potential for accidents at the oxy-combustion facility and determined that the greatest potential for human health impacts could result from an accidental release of liquid oxygen from either of the two onsite storage tanks or releases from the three nitrogen vents of the air separation unit.

The nitrogen removed from the air by the air separation unit would be vented to the atmosphere as a gas, which would promote its upward movement and dispersion as it mixes with ambient air. The discharged gas would be expected to be at atmospheric pressure with a temperature range of 32 to 140°F (Air Liquide 2013). As oxygen deficiency or enrichment is a recognized hazard of the air separation process, the air separation unit would be designed to ensure all oxygen-deficient or oxygen-enriched streams vented to the atmosphere are compliant with industry codes. The design would follow guidelines for minimum heights above the ground, based on the diameter of the vent, its discharge rate, and pressure and temperature conditions (e.g., AIGA 2010). As a result, air separation unit vents would be directed toward safe locations away from any areas where workers could be present and thereby preventing potential asphyxiation hazards. In addition, workers would be required to wear oxygen monitors and comply with requirements regarding confined space entry when working within the air separation unit.

The oxy-combustion facility is expected to have two liquid oxygen tanks, each with a capacity of 236 cubic meters. The liquid oxygen tanks would operate at a pressure of 1-5 psig and temperature of approximately -297°F. As shown in the site diagram (see Figure 2-8), the tanks (cylinders) would be 75 feet long, located approximately 25 feet east of the lime preparation building.

The frequency of an accident involving liquid oxygen tanks is considered to be extremely unlikely (1.4×10^{-6} per year) based on a 1997 survey of 11,760 tank years at production sites, and 712,000 tank years at customer sites for liquid oxygen, nitrogen, and argon tanks in Europe (EIGA 2004). A review of tank failures concluded that ductile tearing is more likely than collapse, corrosion, excessive deformation, or brittle fracture. A tear in the tank is likely to result in a leak, rather than failure of an entire tank wall. Based on actual accidents that have occurred worldwide, the most common cause of releases were refilling operations, where a valve failed or the operator made an error during the refilling process. Eight of the 12 accidents where liquid oxygen leaked occurred during filling operations. Two other accidents involved improper venting, and one involved corrosion of parts of the valve system. Several accidents occurred due to improper procedures during or after the original leak, rather than mechanical failure. Injuries, fatalities, and property damage that occurred were primarily from associated fires following the leak.

To evaluate a release from one of the liquid oxygen tanks, DOE reviewed and scaled the results of an existing simulation for a release from a tank with 1,000 metric tons of liquid oxygen. This simulation included a tank leak through a 6-inch nozzle, forming a liquid pool followed by a vapor cloud. By scaling this simulation to the liquid oxygen tank size at the Meredosia Energy Center, DOE estimated that a vapor cloud with 25 percent oxygen could extend approximately 150 feet from the release location. Based on the proposed location of the liquid oxygen tanks, a release from either tank would remain within the energy center property. The frequency of an accident at one of two tanks is 2.8×10^{-6} per year and the probability of one accident over a conservative 30-year operational period is 8.4×10^{-5} . It is expected that consequences related to the accidental release of liquid oxygen from the tanks and associated exposure would be limited to workers that are within 150 feet of liquid oxygen tanks, and that no offsite consequences would occur. Under these circumstances, workers within 150 feet of the release could experience minor to serious injuries by exposure to extreme temperatures (e.g., frost bite). Other physical injuries could occur if any oxygen-fueled fires were to ensue after the leak had occurred. No long-term impacts to the public would be expected from a tank release.

Precautions to prevent accidents include the use of appropriate design and materials for liquid oxygen tanks, compliance with OSHA 1910.104 regulations on allowable distances from flammable and combustible materials, proper siting of equipment and signage to alert workers of the potential hazards, and training and equipment to handle oxygen-fueled fires.

CO₂ Pipeline

This section includes a detailed analysis of accidental release scenarios in consideration of the population densities along both the southern and northern pipeline routes. **The southern (proposed) route extends to the proposed injection site. The northern route is delineated to the western border of the CO₂ storage study area and then analyzed based on hypothetical end-of-pipeline routes (spurs) to the injection wells as described in Section 2.5.1.1. The analysis presented in this section has been updated from the Draft EIS to reflect refinements in the pipeline routes and to evaluate 10-mile pipeline segments for both a nominal 12-inch diameter pipe and a nominal 10-inch diameter pipe.**

DOE assessed the potential impacts of a maximum release scenario by evaluating the release of CO₂ with trace gases at the concentration limits set in the Alliance’s minimum CO₂ pipeline acceptance specifications (see Table 3.17-7). The total sulfur content was evaluated as sulfur dioxide and sulfur trioxide based on the ratio of estimated emissions from the oxy-combustion facility. The sulfur dioxide was estimated at 7.9 parts per million and sulfur trioxide as 16.9 parts per million, so that the total was less than 25 parts per million. Under average operating conditions, these components are expected to be significantly lower with less than 1 part per million total sulfur and negligible hydrogen sulfide content.

Table 3.17-7. Alliance Minimum CO₂ Pipeline Acceptance Specifications

Component	Quantity
Carbon Dioxide (CO ₂)	97 percent dry basis
Inert constituents	1 percent
Trace constituents	2 percent
Oxygen (O ₂)	≤ 20 ppm
Total sulfur	≤ 25 ppm
Mercury (Hg)	≤ 2 ppb ^a
Hydrogen sulfide (H ₂ S)	< 20 ppm ^b
Water vapor	≤ 30 lb/mmscf

^a. SDWA standard.

^b. Standard specification for pipeline quality CO₂. However, no detectible amounts of H₂S are expected in the CO₂ stream from the Meredosia Energy Center.

Note: The CO₂ stream could contain other trace metals, which would not be known until additional design work is completed.

CO₂ = carbon dioxide; H₂S = hydrogen sulfide; Hg = mercury; lb/mmscf = pounds per million standard cubic feet; O₂ = oxygen; ppb = parts per billion; ppm = parts per million; SDWA = Safe Drinking Water Act

Pipeline Accident Scenarios and Release Simulations

Two accidental release scenarios (pipeline rupture and puncture) are considered the most likely type of pipeline accidents that could cause the release of larger volumes of CO₂ and trace components. A pipeline *rupture* release would occur if the pipeline were completely severed, for example by heavy equipment during excavation activities. A rupture could also result from a longitudinal running fracture of a pipe section or a seam-weld failure. In these cases, the entire contents of the pipeline between the two nearest

control valve stations (which are expected to be fitted with automatic and manual shut-off valves) could be discharged from the severed pipeline within minutes. **As explained in Section 2.5.1.2, the conceptual design currently proposed by the Alliance assumes there would be one mainline block valve at the Meredosia Energy Center, one at the injection site, and two in between. Therefore, the analysis in the Final EIS assumed a maximum distance of 10 miles between control valve stations. Based on modeling, the duration of the release resulting from a pipeline rupture would be approximately 5 minutes for a nominal 12-inch diameter pipe and 9 minutes for a nominal 10-inch diameter pipe.**

For the purpose of the analysis, a pipeline *puncture* release is defined as a 3-inch by 1-inch hole that could be made by a tooth of an excavator. In such a case, all of the contents in the pipeline between the two nearest control valve stations would discharge into the atmosphere, but the release would occur over a period of several hours, as the opening is small relative to the total volume, and the pressure would decline as the fluid escapes. **Based on modeling, the duration of a release from a pipeline puncture would be approximately 3.3 hours for a nominal 12-inch diameter pipe and 3.9 hours for a nominal 10-inch diameter pipe.**

Captured CO₂ may be transported as a supercritical fluid, such that its density resembles a liquid but it expands to fill space like a gas. If CO₂ were released from a pipe, it would expand rapidly as a gas and, depending on temperature and pressure, could include both liquid and solid (i.e., dry ice) phases. Supercritical CO₂ has a very low viscosity but is denser than air. A potential release of CO₂ through an open orifice in the pipeline with a gas moving at the speed of sound is referred to as choked or critical flow (Bird et al. 2006). In the rupture scenario, the escaping gas from the pipeline is assumed to escape as a horizontal jet at ground level, which is typically the highest consequence event for heavier-than-air gases (Hanna and Drivas 1987).³

Potential releases to the atmosphere represent the primary exposure pathway considered in the exposure analysis. The receptor groups likely to be exposed by releases from pipelines or aboveground equipment at the energy center or injection wells would be onsite workers and the general public in the immediate vicinity of these sites at the time of an accident. In addition to the potential health effects of a release, which would be dependent on the exposure concentrations and local meteorological conditions at the time of a release, individuals near a ruptured or punctured pipeline or wellhead would likely also be affected by the physical forces from the accident itself, including the release of gases at high flow rates and at very high speeds. People involved at the location of an accidental release would be potentially affected, possibly due to a combination of effects, such as physical trauma, asphyxiation (displacement of oxygen in a small confined place), or frostbite from the rapid expansion of CO₂ (e.g., 3,000 psi to 15 psi).

The SLAB model was used to simulate releases from a rupture and a puncture of the pipeline. The Alliance's **proposed** southern pipeline route (see Figure 2-18) was simulated since it is closer to populated areas, and would therefore produce a more conservative analysis than the northern pipeline route option. DOE's analysis assumes that the control valves would close under an accident scenario, limiting the potential releases to the amount of CO₂ contained in the affected pipeline segment. **The Alliance is designing the pipeline with either a nominal 12-inch diameter or a nominal 10-inch diameter. The nominal 12-inch diameter pipeline would have an outer diameter of 12.75 inches and an inner diameter of 12.09 inches. The nominal 10-inch diameter pipeline would have an outer diameter of 10.75 inches and an inner diameter of 10.14 inches.**

The **normal operating** temperature of the CO₂ in the pipeline would vary between the CO₂ capture facility and the injection wells from approximately 90°F to 72.2°F. **For the nominal 12-inch diameter pipeline**, pipeline simulations were conducted using 2,100 psig and 90°F. **However, the most recent**

³ Studies show that a sudden release from a buried pipeline would more likely escape at roughly a 20 degree angle (McGillivray and Wilday 2009). However, SLAB has the capability of modeling either a horizontal or a vertical release. DOE assumed a horizontal jet for pipeline releases and a vertical jet for injection well releases. Assuming a horizontal jet for a pipeline release introduces another layer of conservatism to the analysis.

design information indicates that the conditions may differ at the delivery station (pressure of 1,874 psig and temperature of 72.2°F), so a sensitivity analysis was performed using these conditions. For the nominal 10-inch diameter pipeline, the case with the highest CO₂ density was used for the simulations (i.e., at a pressure of 1,335 psig and temperature of 70°F). The CO₂ would be transported in a dense (fluid) state under any of these conditions. If a pipeline release were to occur, part of the dense fluid would be converted to a dry-ice snow form, which would then slowly sublimate (i.e., change from a solid phase directly to a vapor phase). The percent of CO₂ released as a vapor is estimated to be 73.7 percent. The transport of the vapor phase in the atmosphere was simulated using SLAB and the results compared to appropriate health criteria.

Seven meteorological stability classes, as defined in Table 3.17-8, and all 16 different wind directions were used for the simulations based on local data from the Springfield Capital Airport National Weather Service Station between 2005 and 2009 (IEPA 2011f). As shown in the wind rose diagram (see Figure 3.2-1), calm conditions occurred approximately 2.1 percent of the time. The predominant wind direction is from the south approximately 12 percent of the time. While the wind blows from all directions, the next most common direction is from the northwest at approximately 7 percent of the time. Wind directions between due north and due east occurred less than 5 percent of the time in any one direction. The average wind speeds used in the SLAB simulations varied from 3 to 39 feet per second as shown in Table 3.17-9.

Table 3.17-8. Pasquill Meteorological Stability Classes

Stability Class	Description
A	Extremely unstable conditions
B	Moderately unstable conditions
C	Slightly unstable conditions
D	Neutral conditions
E ^a	Slightly stable conditions
F	Calm, stable conditions
G ^a	Extremely stable conditions

Source: Turner 1994

^a. Classes E and G would not be used for the FutureGen 2.0 Project pipeline or wells.

Table 3.17-9. Meteorological Conditions Used in SLAB Simulations

Condition	F1	A1	B2	C4	D7	D10	D12
Pasquill Category	F	A	B	C	D	D	D
Average Wind Speed (ft/s)	3	3	7	13	23	33	39
Percent of Time that Condition Occurs	2.1	16.3	27.2	30	20.1	3.6	0.7

ft/s = feet per second

Simulations were conducted to determine the impact zone where workers and the public could be exposed to concentrations from pipe ruptures and punctures for the PAC for CO₂, hydrogen sulfide, sulfur dioxide, and sulfur trioxide (see Table 3.17-1). Maximum exposure concentrations and related distances were determined by modeling a 15-minute period for pipe *ruptures* because the calculated release duration would be less than 10 minutes. Additional simulations were then conducted for 30-minute and 60-minute time intervals to determine the distances within which exposure criteria concentrations would be

exceeded. Distances at which exposure would occur from a pipeline *puncture* release would be less than those experienced under a pipeline rupture, as the gas would be released more slowly and over a much longer duration. As a result, DOE used the USEPA Acute Exposure Guideline Levels (AEG) for 8 hours (AEG-1 to AEG-3; see Table 3.17-1) for assessing the potential effects related to this release type. Worker guidelines for 8 hours were used for CO₂, since AEGs are not available.

DOE simulated releases from 10-mile pipeline segments for both a nominal 12-inch diameter pipe and nominal 10-inch diameter pipe. The base case simulation for the nominal 12-inch diameter pipe was conducted for the following conditions: pressure at 2,100 psig and temperature at 90°F. A sensitivity case for the nominal 12-inch diameter pipe was simulated using the estimated conditions at the delivery station (pressure of 1,874 psig and temperature of 72.2°F). Under lower pressure and temperature conditions, CO₂ would take longer to be released from the pipe and the vapor plume extent would be slightly different; however, these changes had only a limited effect on the simulated number of individuals potentially affected by a release. The simulation for the nominal 10-inch diameter pipe was conducted using a pressure of 1,335 psig and a temperature of 70°F. Table 3.17-10 shows the estimated distances for base case conditions that a given exposure concentration plume could extend out from hypothetical pipeline releases both for a nominal 12-inch diameter pipe and for a nominal 10-inch diameter pipe.

Table 3.17-10. Simulated Vapor Plume Transport Distances for Pipeline Releases

Release Type	Exposure Duration	Criteria ^a (ppm)	Distance (feet)	Meteorological Condition ^b	Distance (feet)	Meteorological Condition ^b
CO₂			12-inch Diameter (nominal)		10-inch Diameter (nominal)	
Rupture	15 minutes	5,000	10,078	F1	8,583	F1
	15 minutes	30,000	781	F1	1,001	F1
	15 minutes	50,000	376	F1	473	F1
	30 minutes	40,000	214	D12	245	D10
	60 minutes	5,000	1,419	F1	1,769	F1
	60 minutes	30,000	128	D12	152	D12
	60 minutes	50,000	63	D12	79	D12
Puncture	8 hours	5,000	1,095	F1	980	F1
	8 hours	20,000	172	F1	161	F1
	8 hours	40,000	66	F1	61	F1
H₂S			12-inch Diameter (nominal)		10-inch Diameter (nominal)	
Rupture	15 minutes	0.51	8,903	F1	7,613	F1
	15 minutes	27	680	F1	907	F1
	15 minutes	50	389	F1	622	F1
	30 minutes	100	54	D7, D10	49	A1
	60 minutes	0.51	4,066	F1	3,691	F1
	60 minutes	27	155	F1	375	F1
	60 minutes	50	54	D7, D10, D12	49	F1
Puncture	8 hours	0.33	1,300	F1	1,080	F1
	8 hours	17	105	F1	87	F1
	8 hours	31	73	F1	62	F1
SO₂			12-inch Diameter (nominal)		10-inch Diameter (nominal)	
Rupture ^c	15 minutes	0.20	6,377	F1	5,158	F1
	15 minutes	0.75	2,942	F1	2,314	F1

Table 3.17-10. Simulated Vapor Plume Transport Distances for Pipeline Releases

Release Type	Exposure Duration	Criteria ^a (ppm)	Distance (feet)	Meteorological Condition ^b	Distance (feet)	Meteorological Condition ^b
SO₂ (continued)			12-inch Diameter (nominal)		10-inch Diameter (nominal)	
Rupture ^c	15 minutes	30	75	F1	55	B2
	30 minutes	100	12	F1	15	B2
	60 minutes	0.20	2,822	F1	2,201	F1
	60 minutes	0.75	1,172	F1	827	F1
	60 minutes	30	12	F1	20	B2
Puncture	8 hours	0.20	689	F1	574	F1
	8 hours	0.75	309	F1	256	F1
	8 hours	9.6	16	A1	15	A1
SO₃			12-inch Diameter (nominal)		10-inch Diameter (nominal)	
Rupture ^c	15 minutes	0.06	16,215	F1	13,481	F1
	15 minutes	2.61	1,893	F1	1,457	F1
	15 minutes	48.07	100	F1	59	B2
	60 minutes	0.06	8,152	F1	6,466	F1
	60 minutes	2.61	686	F1	231	F1
	60 minutes	48.07	12	F1	20	B2
Puncture	8 hours	0.06	1,918	F1	1,590	F1
	8 hours	2.61	178	F1	158	F1
	8 hours	27.94	12	B2	11	B2

^a. See Section 3.17.1.3 and Table 3.17-1 for description of potential health effects and protective health criteria concentrations. **Section 3.17.1.4 also provides information on how the respective criteria and time durations are considered in this analysis.**

^b. Meteorological condition for longest distance case.

^c. **Results for non-calm conditions would extend to distances of about a factor of 5 less than the calm conditions (F1), which occur about 2.1 percent of the time.**

CO₂ = carbon dioxide; H₂S = hydrogen sulfide; ppm = parts per million; SO₂ = sulfur dioxide; SO₃ = sulfur trioxide

The potential vapor plume from a pipe rupture or puncture scenario would be small in areal extent, and its position would depend on the wind direction, speed, and stability conditions at the time of the release. The rapid release of high-pressure CO₂ from the pipeline would result in a relatively narrow band of CO₂ extending laterally in the immediate vicinity of the release point. The rapid decompression of the CO₂ would result in extreme cooling at the rupture site, with the rapid formation of CO₂ liquids, solids (i.e., dry ice), and gases in the immediate vicinity. In the immediate discharge zone, phase changes would subsequently occur (i.e., from solid or liquid to gas). With distance, the CO₂ gas would expand and disperse as the pressure reduced and it mixed with ambient air. A significant amount of noise, similar to a jet engine, would likely be generated by the event and subsequent rapid release of the CO₂.

Maximum Reasonably Foreseeable Pipeline Rupture Scenario

People in the vicinity of the rupture would be most susceptible to harm due largely to potential physical effects related to high-pressure and the velocity of the release, as well as from exposure to extreme temperature drops that could cause frost-bite. In addition, high concentrations of CO₂ would be present in the narrow band of CO₂ escaping from the rupture site. Immediate life threatening effects related to asphyxiation from short-term exposure to these high concentrations (i.e., **within minutes of exposure to CO₂ at concentrations that exceed 100,000 parts per million by volume**), **could occur within this band up to distances of 267 feet and 314 feet from the rupture for nominal 12-inch diameter and 10-inch diameter pipeline scenarios, respectively.** However, people would likely be able to flee the areas with high concentration due to the visual, physical, and audible signs associated with the event. Within a 30-

minute period workers would likely need to use respiratory protection within **214 feet and 245 feet respectively**, the distance within which the National Institute for Safety and Health declares the concentration could exceed levels immediately dangerous to life or health; and workers would likely need other personal protective equipment for freezing conditions near the discharge point.

The potential for exposure and risk to the public would primarily occur as the CO₂ expands and disperses creating a vapor plume. The potential maximum reasonably foreseeable accident scenario or exposure distances would occur with a pipeline rupture under calm meteorological conditions, as it would take a longer period of time for CO₂ concentrations to dissipate under calm conditions. Based on the modeling results presented in Table 3.17-10 **and the health effects criteria presented in Table 3.17-1**, there would be no **adverse** effects to the general public from a rupture beyond a distance where CO₂ concentrations would exceed 5,000 parts per million. Over a 60-minute time period after a rupture, under calm meteorological conditions, **this distance could extend from the rupture to 1,419 feet and 1,769 feet for the release of gases, respectively, from nominal 12-inch diameter and 10-inch diameter pipeline**. Transient effects, which include temporary symptoms such as headache, dizziness, sweating, and/or vague feelings of discomfort, could occur within these distances. Irreversible or serious adverse effects could occur **within exposure distances of 128 feet and 152 feet, respectively, with the potential for life-threatening effects from exposures within 63 feet or 79 feet, respectively, for the nominal 12-inch diameter and 10-inch diameter pipeline**.

Federal regulations (49 CFR 195) require CO₂ pipelines to be located no closer than 50 feet from occupied residences. The Alliance pipeline siting criteria includes an intended minimum distance of 150 feet from any occupied structure; but it is possible that a shorter distance would be deemed necessary in order to avoid a sensitive environmental resource or to accommodate the request of an affected landowner. Based on the 1-hour public health criteria (see Table 3.17-1), life-threatening health effects would not occur at a distance greater than 150 feet for rupture of either the 10- or 12-inch diameter pipelines. However, irreversible adverse health effects could occur for the rupture of the 10-inch diameter pipeline within 152 feet under meteorological condition D12. In addition, the 30-minute worker based health criteria (i.e., Immediate Danger to Life or Health levels) could be exceeded at a distance greater than 150 for the rupture of the 10-inch diameter pipeline under meteorological conditions D10 and D12. Meteorological conditions D10 and D12 only occur 3.6 and 0.7 percent of the time, respectively. Under all other meteorological conditions, the estimated distance within which serious adverse health effects could occur would be less than 150 feet.

Under normal operating conditions hydrogen sulfide is not expected to be present in measurable concentrations in the pipeline, and no effects would occur from hydrogen sulfide exposure regardless of the distance from a release. However, for purposes of analysis, DOE considered the potential health risks from exposure to releases from a rupture or puncture assuming hydrogen sulfide is present in the CO₂ gas at the limit of the Alliance's CO₂ acceptance specification. No health effects from hydrogen sulfide exposure (based on the 1-hour exposure criteria) could occur beyond 4,066 feet (0.77 mile) or 3,691 feet (0.7 mile), respectively, for the nominal 12-inch diameter and 10-inch diameter pipeline scenarios. Irreversible or serious adverse effects from hydrogen sulfide could occur within exposure distances (1-hour) of 155 feet and 375 feet respectively. The potential for life-threatening effects could occur from exposures (1-hour) within 54 feet or 49 feet, respectively. However, the distances for hydrogen sulfide exposure are considered to be very conservative based on the expected absence of hydrogen sulfide in measurable concentrations during normal operations.

No health effects (for the 1-hour exposure criteria) related to either sulfur dioxide or sulfur trioxide exposure, respectively, would occur beyond 2,822 feet (0.5 mile) or 8,152 feet (1.5 miles) from the release point based on the nominal 12-inch diameter pipeline scenario. These distances are for calm conditions that occur about 2.1 percent of the time; the distances would be less by a factor of about five for all other meteorological conditions. Irreversible or serious adverse effects from sulfur

dioxide or sulfur trioxide, respectively, could occur within exposure distances of 1,172 feet and 686 feet based on the nominal 12-inch diameter pipeline scenario. The potential for life-threatening effects could occur from exposures to sulfur dioxide or sulfur trioxide within 20 feet, based on the nominal 10-inch diameter pipeline scenario, or within 12 feet for the 12-inch pipeline scenario. However, the actual sulfur dioxide and sulfur trioxide concentrations in the pipeline would be much lower, under average operating conditions, than the values shown in Table 3.17-7; therefore, concentration plumes would likely not extend as far as predicted.

Maximum Reasonably Foreseeable Pipeline Puncture Scenario

People in the vicinity of the puncture would be most susceptible to harm due largely to potential physical effects related to high-pressure and the velocity of the release, as well as from exposure to extreme temperature drops which could cause frost-bite. In addition, high concentrations of CO₂ would be present in the narrow band of CO₂ escaping from the puncture site. Immediate life threatening effects related to asphyxiation from short-term exposure to these high concentrations (i.e., exposure to CO₂ at concentrations that exceed 100,000 parts per million by volume) could occur within this band up to **distances of approximately 18 or 19 feet for the nominal 12-inch diameter and 10-inch diameter pipeline scenarios, respectively.** However, people would likely be able to flee the areas with high concentration due to the visual, physical, and audible signs associated with the event.

The potential for exposure and risk to the public would primarily occur as the CO₂ expands and disperses creating a vapor plume. The potential maximum reasonably foreseeable accident scenario or exposure distances would occur with a pipeline puncture under calm meteorological conditions as it would take a longer period of time for CO₂ concentrations to dissipate under calm conditions. Exposure concentrations and distances would be less for a pipeline puncture than a rupture; however, exposure durations could be longer as the release would occur over a longer period of time (i.e., several hours). Based on the 8-hour exposure criteria, no health effects related to CO₂ exposure would occur **beyond 1,095 feet and 980 feet, respectively, for the nominal 12-inch diameter and 10-inch diameter pipeline scenarios.** However, transient adverse effects could occur within these distances. The distance within which life-threatening effects could occur based on worker exposure criteria for CO₂ **would be 66 feet and 61 feet, respectively, for the nominal 12-inch diameter and 10-inch diameter pipelines scenarios.** The Alliance pipeline siting criteria includes **an intended** minimum distance of 150 feet from any occupied structure, which is greater than the distance for life-threatening effects.

Potential transient adverse health effects related to hydrogen sulfide, sulfur dioxide, and sulfur trioxide for puncture releases from **nominal 12-inch diameter or 10-inch diameter pipeline scenarios, respectively, could occur within: 1,300 feet and 1,080 feet for hydrogen sulfide; 689 feet and 574 feet for sulfur dioxide; and 1,918 feet and 1,590 feet for sulfur trioxide.** Potential irreversible or serious adverse health effects related to hydrogen sulfide, sulfur dioxide, and sulfur trioxide for respective releases from **nominal 12-inch diameter and 10-inch diameter pipeline scenarios could occur within: 105 feet and 87 feet for hydrogen sulfide; 309 feet and 256 feet for sulfur dioxide; and 178 feet and 158 feet for sulfur trioxide.** Potential life-threatening effects related to hydrogen sulfide, sulfur dioxide, and sulfur trioxide for respective pipeline segment releases could occur within: **73 feet and 62 feet for hydrogen sulfide; 16 feet and 15 feet for sulfur dioxide; and 12 feet and 11 feet for sulfur trioxide.** However, the distances for hydrogen sulfide, sulfur dioxide, and sulfur trioxide exposures are considered to be very conservative, as under normal operating conditions these components are not expected to be present in measurable concentrations.

Pipeline Walk Method Risk Analysis

The pipeline-walk method and the population density data were used to estimate the expected numbers of people that could be affected by hypothetical ruptures or punctures based on the percent of time that a vapor plume of CO₂ or the trace gases would be transported by the wind in all 16 different directions at varying speeds and for all the stability classes listed in Table 3.17-8. Table 3.17-11 presents the estimated

maximum number of people potentially affected by exposure to CO₂ and the trace gases at various criteria concentrations, resulting from a hypothetical pipeline release for both a rupture and puncture for the **nominal 12-inch diameter or the 10-inch diameter pipeline**. The estimated number of people is a calculated number based on the population density within each hypothetical plume given the full range of meteorological conditions that could occur multiplied by the percent of time that each of those conditions could occur. For CO₂, a pipeline rupture or puncture would not result in one or more persons being affected by CO₂ concentrations of 30,000 parts per million or greater (i.e., the threshold for which irreversible adverse effects could occur). The number of people estimated to be within the zone where a concentration of 5,000 parts per million (i.e., the threshold for which transient adverse effects could occur) ranges from less than one up to **eight** people. One individual or less could be affected if the release were to occur in rural areas, up to **five** people if the release were to occur near Meredosia, and up to **eight** people if the release were to occur near Jacksonville. For all release locations, people nearby at the time of the release could experience physical effects, in addition to effects from the CO₂ or trace gases.

Table 3.17-11. Estimated Number of People Affected by CO₂ and Trace Gases from the Hypothetical Pipeline Releases

Release Type	Exposure Duration	Criteria (ppm) (Exposure Level)	Number of People Potentially Affected	
			12-inch Diameter (nominal)	10-inch Diameter (nominal)
Due to CO₂			12-inch Diameter (nominal)	10-inch Diameter (nominal)
Rupture	15 minutes	5,000	5 ^{a-7} ^b (8 ^c)	3 ^{a-6} ^b
	15 minutes	30,000	0	0
	15 minutes	>30,000	0	0
	15 minutes	50,000	0	0
Puncture	8 hours	5,000	0	0
	8 hours	20,000	0	0
	8 hours	40,000	0	0
Due to H₂S			12-inch Diameter (nominal)	10-inch Diameter (nominal)
Rupture	15 minutes	0.51	1 ^{a,b}	1 ^{a,b}
	15 minutes	27	0	0
	15 minutes	50	0	0
Puncture	8 hours	0.33	0	0
	8 hours	17	0	0
	8 hours	31	0	0
Due to SO₂			12-inch Diameter (nominal)	10-inch Diameter (nominal)
Rupture	15 minutes	0.20	0	0
	15 minutes	0.75	0	0
	15 minutes	30	0	0
Puncture	8 hours	0.20	0	0
	8 hours	0.75	0	0
	8 hours	9.6	0	0
Due to SO₃			12-inch Diameter (nominal)	10-inch Diameter (nominal)
Rupture	15 minutes	0.06	1-3 ^{a,b}	1-3 ^{a,b}
	15 minutes	2.61	0	0
	15 minutes	48.07	0	0
Puncture	8 hours	0.06	0	0
	8 hours	2.61	0	0
	8 hours	27.94	0	0

^a In the vicinity of Meredosia.

^b Near Jacksonville.

^c Near Jacksonville for the delivery station conditions for the nominal 12-inch diameter pipe

CO₂ = carbon dioxide; H₂S = hydrogen sulfide; ppm = parts per million SO₂ = sulfur dioxide; SO₃ = sulfur trioxide

Based on the pipeline-walk analysis, the general public would not be subjected to irreversible, adverse effects of hydrogen sulfide from a pipeline rupture or puncture (**unless an individual was close to the release**), because the area of the vapor plume would be small. However, up to one person could experience transient effects from hydrogen sulfide exposure if a **rupture** were to occur near Meredosia or Jacksonville, but less than one person would be expected to experience transient effects if a release were to occur along the rural portion of the pipeline route for **either the nominal 12-inch or 10-inch diameter pipeline scenarios**. The general public is not expected to be affected by exposure to sulfur dioxide in the event of pipeline ruptures or punctures. **For sulfur trioxide, up to 3 people could experience transient effects such as temporary respiratory discomfort from a rupture but no irreversible, serious effects. These results are very conservative, since the sulfur dioxide and sulfur trioxide concentrations in the pipeline during normal operation are expected to be much less than the upper limits of the Alliance's CO₂ acceptance specification.** The estimation of the number of people potentially affected by a vapor plume considers the percent of time that the different meteorological conditions occur and the percent of time that the wind blows toward more populated areas. Thus, the potential impacts to the public from a release are anticipated to be negligible to minor short-term effects such as irritation or discomfort from hydrogen sulfide odors.

The annual frequency of a rupture on the proposed 30-mile pipeline to the injection wells in Morgan County is estimated at 1.88×10^{-3} (0.00188). The probability of at least one rupture over a 30-year operating period is estimated to be 5.5×10^{-2} (0.055). The annual frequency of a puncture on the proposed 30-mile pipeline to the injection wells is estimated at 3.13×10^{-3} (0.00313). The probability of a puncture over a 30-year operating period is estimated to be 8.97×10^{-2} (0.0897). Based on the estimated frequencies of pipeline punctures or ruptures, both types of releases on the pipeline to the injection wells are considered unlikely (frequency from 1×10^{-2} to 1×10^{-4} per year or from one in 100 years to one in 10,000 years).

CO₂ Storage Study Area

Since publication of the Draft EIS, the Alliance selected the single-site scenario with four horizontal wells as its proposed option and identified the location of the injection well site (as discussed in Section 2.5.2.1). DOE estimates that the nearest dwelling is located approximately 900 feet from the end of the pipeline at the injection well site. The CO₂ storage study area is located in a sparsely populated region, with a population density of 2 to 5 people per square mile in part of the study area and 5 to 25 people per square mile in the remaining portion (see Figure 3.17-3).

The Alliance evaluated different injection well configurations using both vertical wells (**dual-site scenario**) and horizontal wells (**single-site scenario**) within the CO₂ storage study area as described in Section 2.5.2.3. The extent of the subsurface CO₂ plume for the two vertical well (**dual-site**) scenario, **which is no longer under consideration by the Alliance**, was estimated to be approximately 4,000 to 5,000 acres within the 6,800-acre study area. For the currently proposed horizontal well scenario (**single-site**), the lateral extent of the subsurface plume after 20 years of the injection period and 50 years of the post-injection period was estimated as **approximately** 4,000 acres from subsurface modeling of the horizontal injection system using the STOMP-CO₂ simulator (Appendix G, Geological Report).

Although an injection well failure would be extremely unlikely, DOE used the SLAB model to simulate a surface release from both vertical and horizontal injection wells. The releases were modeled as vertical or horizontal jets, assuming gas compositions similar to those used for the pipeline (see Table 3.17-7). The toxicity analysis used the PAC criteria applicable to the public for exposure duration of 1 hour or less (15 minutes for a well failure) and acute worker safety guidelines listed in Table 3.17-1. **DOE estimated potential health risks from exposure to releases from the injection well assuming that trace gases (sulfur dioxide, sulfur trioxide, and hydrogen sulfide) are present in the CO₂ gas at the limit of the Alliance's CO₂ acceptance specification. However, under normal operating conditions these trace gases are not expected to be present in measurable concentrations in the pipeline. The details of DOE's modeling and analysis are presented below.**

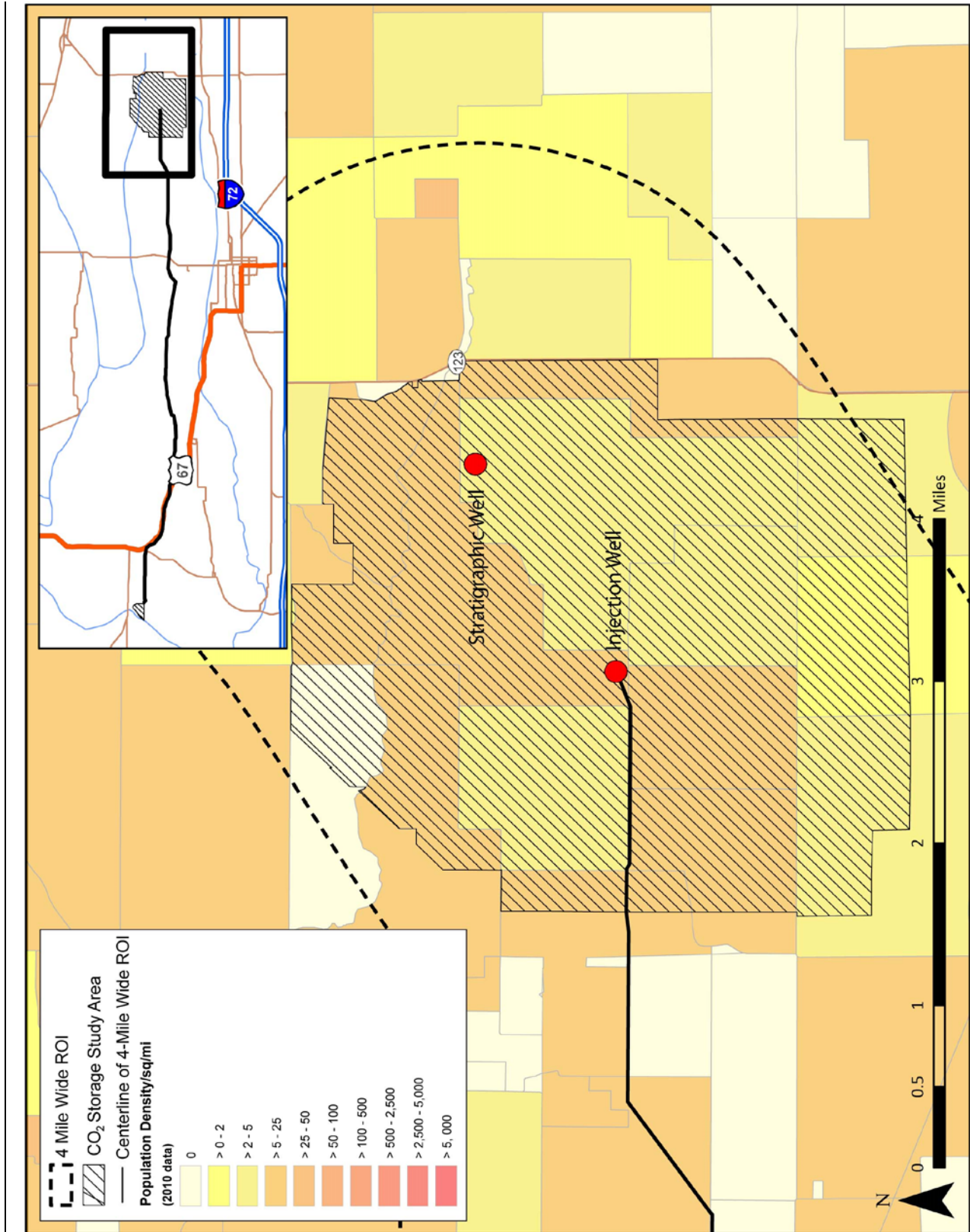

CO₂ = carbon dioxide; ROI = Region of Influence; sq/mi = square mile

Figure 3.17-3. Population Density in Vicinity of Area of Injection Well Site(s)

Two Vertical Injection Wells Scenario

As noted above, the Alliance is no longer considering a two-vertical injection well scenario. However, the following analysis was prepared for the Draft EIS and is included here as a comparison with the Alliance’s proposed four-horizontal injection well scenario. The simulations for the two vertical injection well scenario assumed a well depth of 4,400 feet, which is the expected base of the screened (perforated) interval for injection into the Mt. Simon Formation. Table 3.17-12 shows the furthest distances that CO₂ and trace gas criteria-level vapor plumes are predicted to migrate from a hypothetical injection well failure and the meteorological stability class associated with the maximum distance. Based on the SLAB simulations, CO₂ concentrations greater than 5,000 parts per million averaged over a 15-minute period would occur at less than 92 feet from the injection wells. The furthest distance that higher CO₂ concentrations of 30,000 parts per million could extend due to a release from a well is less than 10 feet. The furthest distance that a vapor plume with hydrogen sulfide of 27 parts per million (the condition where irreversible, adverse effects could be experienced) is 518 feet under calm conditions or less than 112 feet under other conditions. For both sulfur dioxide and sulfur trioxide, a vapor plume with concentrations that could result in adverse effects would be expected to occur at distances less than 200 feet, which is the protected area around each injection well.

Table 3.17-12. Simulated Vapor Plume Transport Distances for Vertical Injection Well

Chemical	Exposure Duration	Criteria (ppm)	Distance (feet)	Meteorological Condition ^a
CO ₂	15 minutes	5,000	92	D12
	15 minutes	30,000	8	D12
	15 minutes	50,000	2	F1
	15 minutes	40,000	4	D12, D10, D7
	30 minutes	5,000	33	F1
	60 minutes	5,000	2	F1
H ₂ S	15 minutes	0.51	4,940	F1
	15 minutes	27	518	F1
	15 minutes	50	347	F1
	30 minutes	100	121	D7
SO ₂	15 minutes	0.20	138	F1
	15 minutes	0.75	57	A1
	15 minutes	30	5	C4
SO ₃	15 minutes	0.06	1,180	F1
	15 minutes	2.61	32	F1
	15 minutes	48.07	5	C4

^a Meteorological condition for longest distance case.

CO₂ = carbon dioxide; H₂S = hydrogen sulfide; ppm = parts per million; SO₂ = sulfur dioxide; SO₃ = sulfur trioxide

Based on the pipeline-walk analysis method, no nearby residents would be affected by an injection well release of CO₂ or trace gases from a well 4,400 feet deep. Based on the SLAB simulations of releases to the air, the areal extent of a vapor plume, if a leak occurred during operation of the wells, was estimated by the model to be small (e.g., 0.02 acre for a vapor plume with CO₂ equal to 5,000 parts per million or 0.6 acres for a vapor plume with hydrogen sulfide equal to 0.51 parts per million but less than 0.01 acre for a plume equal to 27 parts per million). The estimation of the number of people potentially affected by a vapor plume considers the percent of time that all different meteorological conditions occur and the percent of time that the wind blows in each of the 16 possible directions, some of which may be toward more populated areas. There are expected to be a total of 15 people working at the injection well facility in the daytime during the work week, and 3 people present at night and on weekends. All the workers are expected to be inside one of the buildings most of the time, which would provide additional protection if a

leak occurred from one of the wells. The potential impacts to workers from a well release are expected to be short-term, negligible to minor effects, since the release duration from a well is estimated to be less than 15 minutes and alarms would immediately sound. The potential impacts to the public are expected to be negligible because they are unlikely to be close to the injection well sites, which would be surrounded by a controlled access area. Thus, the public could experience only short-term, transient effects such as headaches or irritation from odors if present within an impact zone from a well failure at the time of a release (see Table 3.17-12).

Four Horizontal Injection Wells Scenario

As now proposed by the Alliance, the horizontal injection well scenario involves up to four separate horizontal wells installed on one pad, but oriented along a different azimuth. This scenario aligns with the injection well configuration currently proposed by the Alliance as described in Appendix G, Geological Report. Each well would consist of a vertical section to a depth of approximately 3,150 feet through the Potosi Formation, at which point the hole would begin to turn from a vertical to horizontal orientation. At a true vertical depth of approximately 4,030 feet, the hole would be horizontal and extend in two of the wells to approximately 1,500 feet and in the remaining two wells to approximately **2,500** feet. The volumes in the longest horizontal well of **2,500** feet long for all the options were computed using the inner diameters of each casing or tubing string and the estimated temperature and pressure of the CO₂ fluid from the pipeline. Two bounding cases were simulated with the SLAB model: (1) the smallest volume using injection tubing with an inner diameter of 3.0 inches for the entire well and (2) an open hole with production casing (6.5-inch diameter) in place for the vertical portions of the well and open hole (9.5-inch diameter) for the turned and horizontal portions of the well. The duration of hypothetical releases from these two well designs differ, but are both estimated to be less than 10 minutes.

The SLAB model was used to simulate CO₂, hydrogen sulfide, sulfur dioxide, and sulfur trioxide at the same concentrations as for the vertical injection wells and pipeline. The predicted vapor plume transport distances for the horizontal injection well cases are shown in Table 3.17-13. Based on the pipeline-walk analysis method, no nearby residents would be affected by an injection well release of CO₂ or trace gases from either of the two bounding cases for the horizontal wells. The estimation of the number of people potentially affected by a vapor plume considers the percent of time that all different meteorological conditions occur and the percent of time that the wind blows in each of the 16 possible directions, some of which may be toward more populated areas. The potential impacts to workers would be similar to the estimated effects from a release from the vertical injection well described above. The potential impacts to the public are expected to be negligible, because members of the public are unlikely to be close to the pad where the surface completion of the injection wells are located, which would be surrounded by a controlled access area. The estimated distances where adverse, transient effects could occur from trace gases **for a 1-hour exposure period** was greater than 500 feet only for hydrogen sulfide, sulfur dioxide, and sulfur trioxide under calm conditions for the open-hole completion case, **and for sulfur trioxide under calm conditions for the injection well with tubing**. For these exposures, the public could experience only short-term, transient effects such as headaches or irritation from odors if present within an impact zone from a well failure at the time of a release (see Table 3.17-13). **Thus, using conservative, upper-bound concentrations of trace gases in the pipeline, DOE estimated that adverse, transient effects from exposure to these gases could occur at distances greater than 500 feet under calm conditions, in the event of a release from the injection wells under the single-site, horizontal injection well scenario. However, since the injection well site would be located in a sparsely populated area and these gases would not be present in measurable concentrations under normal operating conditions, impacts from any release are expected to be negligible.**

Table 3.17-13. Simulated Vapor Plume Transport Distances for Horizontal Injection Well

Chemical	Exposure Duration	Criteria (ppm)	Injection Tubing		Open Hole Completion	
			Distance (feet)	Meteorological Condition ^a	Distance (feet)	Meteorological Condition ^a
CO ₂	15 minutes	5,000	114	F1	540	F1
	15 minutes	30,000	12	D12	49	D12
	15 minutes	50,000	7	D12	19	D12
	15 minutes	40,000	9	D12	29	F1
	30 minutes	5,000	44	F1	205	F1
	60 minutes	5,000	18	D12	87	D12
H ₂ S	15 minutes	0.51	685	F1	2,018	F1
	15 minutes	27	48	F1	197	F1
	15 minutes	50	34	F1	124	F1
	30 minutes	100	15	F1	36	F1
	60 minutes	0.51	301	F1	940	F1
SO ₂	15 minutes	0.20	441	F1	1,220	F1
	15 minutes	0.75	176	F1	443	F1
	15 minutes	30	6	B2	11.5	B2
	60 minutes	0.20	164	F1	547	F1
SO ₃	15 minutes	0.06	976	F1	3,369	F1
	15 minutes	2.61	31	A1	83	C4
	15 minutes	48.07	6	B2	8	D7
	60 minutes	0.06	532	F1	1,278	F1

^a. Meteorological condition for longest distance case.

CO₂ = carbon dioxide; H₂S = hydrogen sulfide; ppm = parts per million; SO₂ = sulfur dioxide; SO₃ = sulfur trioxide

Experience and Potential for CO₂ Release from Wells

Injection wells have been used in the natural gas storage industry for 100 years (Benson 2009) and for enhanced oil recovery for over 40 years (NETL 2013c). NETL (2012b) recently compiled information on injection wells into a Best Practices Guide covering well siting, design, construction, monitoring, and closure. The annual frequency of a potential failure in one injection well at a given site was estimated based on experience with existing injection wells as 2.02×10^{-5} per year (0.0000202 per year) (IEA 2006a). Two vertical wells are one option to be used for the FutureGen 2.0 Project. The annual frequency of a potential failure in either of the two vertical wells is estimated to be 4.04×10^{-5} per year (0.0000404 per year). The estimated probability of a potential failure in either of the two wells over a 30-year operating period would be 1.21×10^{-3} (0.00121). Based on the estimated frequency of a potential well failure, such an occurrence is considered extremely unlikely, which was defined as 1×10^{-4} per year to 1×10^{-6} per year or between once in 10,000 years and once in 1 million years.

No separate frequencies for releases from horizontal wells were identified. Horizontal injection wells have been used at four large-scale carbon storage projects: the Sleipner site beneath the North Sea, the In-Salah site beneath the Algerian desert, the Snøhvit Site beneath the Barents Sea, and the Weyburn-Midale site in Saskatchewan. In 2010, Det Norske Veritas stated that “so far there has been no report of significant leakage of stored CO₂ out of the storage formations in any of the current projects” (DNV 2010). The likelihood of a release from the deep horizontal portion of the well is considered to be less than from the vertical portion. One benefit of using horizontal injection wells is that multiple wells can be directionally drilled from a common pad, limiting the surface footprint. However, in a recent Best Practices manual for Carbon Storage Systems and Well Management Activities, the author noted that using multilateral wells requires “significant modeling to maintain adequate reservoir conditions and minimal impact to adjacent formations” (NETL 2013b).

Educational Facilities

The educational facilities are expected to be located in the vicinity of Jacksonville. Health and safety related impacts are not expected during the operation of these facilities, as hazardous or toxic materials would not be used or stored at these locations, nor would these facilities be located in close proximity to the pipeline or injection wells.

3.17.3.3 Post-Injection Impacts

This section addresses potential releases of CO₂ and associated trace gases from the subsurface both after their injection into the subsurface storage zone and after injection operations have ceased. The geology of the target CO₂ storage formation is described in Section 3.4, Geology. Detailed subsurface plume modeling was conducted by the Alliance with STOMP-CO₂ for the currently proposed injection well configuration of four horizontal injection wells for the 20-year injection period. The modeling estimated that the plume would grow to a size of **approximately** 4,000 acres after a 50-year post injection period (Alliance 2013). As a result, DOE used a subsurface plume area of 4,000 acres in the analysis of hypothetical post-injection releases.

The evaluation of the potential effects from post-injection releases from the subsurface storage formation was conducted using the following tools:

- An Analog database for a previous DOE project (DOE 2007b). The database includes site characteristics of natural CO₂ reservoir and operating CO₂ storage or EOR sites; results from studies performed at other CO₂ storage locations and from sites with natural CO₂ accumulations to estimate or measure releases; and results of release estimates for risk assessments at other sites (e.g. two Australian proposed CO₂ storage sites in Hooper et al. 2005) for characterizing the nature of potential risks associated with surface leakage due to caprock seal failures, faults, and fractures. The database was also used to predict CO₂ release rates based on similarities with the proposed storage reservoir.

- USEPA's SCREEN3 model (USEPA 1995c) was used to estimate the resulting CO₂ air concentrations if post-injection releases occurred from slow leaks at low flow rates through abandoned wells or seepage through the caprock and overlying formations. The predicted air concentrations were used to estimate the potential for exposure and any resulting impacts on workers, offsite residents, and sensitive receptors.
- Review of recent risk assessment literature was also conducted to identify additional information such as the Vulnerability Evaluation Framework for Geologic Sequestration of Carbon Dioxide (USEPA 2008b) and the Best Practices for Risk Analysis and Simulation for Geologic Storage of CO₂ (NETL 2013d). These documents address potential release pathways.

DOE considered potential releases that could cause acute effects (high concentration over a short duration) and chronic effects (low concentration over a longer duration). Three scenarios could potentially cause acute effects: (1) upward leakage through the CO₂ injection wells following closure; (2) upward leakage through a deep oil and gas (or other type) well; and (3) upward leakage through undocumented, abandoned, or poorly constructed deep wells. Six scenarios could potentially cause chronic effects: (1) upward leakage through caprock and seals by gradual failure; (2) release through existing faults due to effects of increased pressure; (3) release through induced faults due to local over-pressure conditions; (4) upward leakage through the CO₂ injection wells; (5) upward leakage through deep oil and gas (or other type) wells; and (6) upward leakage through undocumented, abandoned, or poorly constructed wells. Such releases could occur during injection, but are discussed in this separate section.

Table 3.17-14 summarizes the types of potential post-injection releases considered in this analysis. The fluxes (the amounts of CO₂ that would flow through a unit area per unit time) for these releases were estimated based on the characteristics of the Mt. Simon Formation and information on the local geologic setting compared to the sites included in the database and information on wells near the injection area. This approach was used in the EIS for a previous carbon capture and storage project (DOE 2007b). Not all potential release pathways apply to the FutureGen 2.0 Project injection wells.

The target injection zone for geologic storage is the Mt. Simon Formation, which is described in Section 3.4, Geology. The caprock for this **project consists of two members of the 479-foot thick Eau Claire Formation, the Lombard and Provisto, located at depths of 3,425 through 3,838 feet at the stratigraphic well.** The Mt. Simon Formation is underlain by a 13-foot thick conglomerate zone and Precambrian granite, which was reached at a depth of **4,416** feet in the stratigraphic well. The planned injection zone is between the depths of 4,000 and **4,400** feet into the Mt. Simon Formation, which is classified as a hypersaline aquifer with estimated total dissolved solids of approximately **47,500** parts per million. Thus, it is not considered to be a protected USDW per USEPA UIC regulations, which protect groundwater with less than 10,000 milligrams per liter total dissolved solids.

The characteristics that were used to develop the input data for the modeling of potential releases are discussed here. Key properties of the target injection zone include depth, thickness, porosity, permeability, and the caprock. Evidence that the Mt. Simon Formation is a feasible injection zone was provided by the Midwest Geological Sequestration Consortium Phase III Large-Scale Field Test. This DOE partnership is using CO₂ from Archer Daniels Midland Company's fuel-grade ethanol production facility in Decatur, Illinois, and has been injecting 1,000 tons per day since November 2011 via an injection well into the Mt. Simon Formation. The purpose of the Archer Daniels Midland project is to demonstrate the ability of the Mt. Simon Formation to accept and retain approximately 1.1 million tons (1.0 million metric tons) of injected CO₂ over a 3-year period (DOE 2008b).

Table 3.17-14. Potential Types of Releases from CO₂ Storage Study Area

Release Scenario	Exposure Duration	Potential Volume	Initial Release to
Upward leakage through the caprock due to catastrophic failure and quick release	Short term	Variable, could be large	Air
Upward leakage through the caprock due to gradual failure and slow release	Long term	Small	Air, Groundwater
Upward leakage through the CO ₂ injection wells after injection ceased	Short term and long term	Variable, could be large, a large release would be easier to detect thus limiting the duration	Air, Groundwater
Upward leakage through deep oil and gas wells	Short term and long term	Variable, could be large	Air, Groundwater
Upward leakage through undocumented, abandoned, or poorly constructed wells	Short term and long term	Variable, could be large	Air, Groundwater
Release through existing faults due to the effects of increased pressure	Long term	Variable, could be large	Air, Groundwater
Release through induced faults due to the effects of increased pressure	Long term	Variable, could be large	Air, Groundwater
Lateral or vertical leakage into non-target aquifers	Long term	Variable	Groundwater

CO₂ = carbon dioxide

The top of the Mt. Simon Formation was found at a depth of **3,900** feet and was **500** feet thick in the FutureGen 2.0 Project stratigraphic well. The base of this well as completed was 4,826 feet; a schematic diagram of the planned injection well design and the formations encountered in the stratigraphic well are shown in Figure 2-25. The Mt. Simon Formation is Cambrian in age and varies from fine to coarse-grained sandstone, and is described as quartz sandstone with 95 percent quartz with a low content of calcium, iron, and magnesium. The cement included feldspar, clay, and mica. Permeability in four core samples from this study obtained from depths of 4,000 to 4,150 feet from Illinois, but not the FutureGen 2.0 Project site, ranged from less than 10 to 350 millidarcies at depths of 4,100 to 4,150 feet (O'Connor and Rush 2005). The porosity ranged from 11 to 12.5 percent within this same interval. The porosities are similar to those in other parts of the Mt. Simon Formation within the Illinois Basin (Finley 2005). The early STOMP-CO₂ modeling of the Mt. Simon Formation for the FutureGen 2.0 Project used values for horizontal permeability of 37 to 417 millidarcies and porosity of 9.6 to 17.1 percent. The salinity of the Mt. Simon Formation brine was measured as **47,500** milligrams per liter. The overlying formation above the Mt. Simon Sandstone is the Cambrian-age Eau Claire Formation. While this formation is described as shale in other parts of the Illinois Basin, the formation in the stratigraphic well consists of thin sandstone at the base, overlain by a 257-foot thick dolomite, followed by a 156-foot thick siltstone. In addition, there are a series of overlying secondary seals including **214** feet of the regional Franconia Dolomites above the Eau Claire Formation. There are over 1,400 feet of dolomite between the top of the Eau Claire and the base of the St. Peter Sandstone, which is the lowest formation classified by USEPA, but not by Illinois, as a drinking water source. Above the St. Peter Sandstone, there are multiple shale layers, comprising a total of 1,412 feet of shale and limestone.

Factors that affect the potential for releases from the storage formation include the presence of faults that cut the caprock(s), active seismicity, deep wells from past oil and gas operations, and abandoned or poorly constructed wells. There are oil fields east of the planned injection zone, gas fields to the southwest, and a gas storage site southwest of Waverly approximately 16 miles from the Alliance's stratigraphic well and approximate center of the CO₂ study area AoR (ISGS 2012d). There are **22** oil and gas wells within the **25-square mile study area identified in the Alliance's UIC permit applications**, although two of the wells are shallow producing gas wells that are 334 and 342 feet deep (see Table 3.4-

1). Three of the oil and gas wells near the estimated location of the injection wells were deeper (1,205 to 1,530 feet deep). Thus, there would be 2,470 feet or more between the existing wells and the top of the planned injection zone and 2,388 feet between the bottom of these wells and the top of the target injection formation. While none of the known deep wells extends deep enough to penetrate the Eau Claire Formation (the primary caprock formation), at a depth of approximately 3,425 feet, or the injection zone, potential releases from unknown, poorly constructed, and abandoned deep wells were evaluated as a precaution. One of the deep oil and gas wells was listed as dry and abandoned but was not listed as plugged as were the other two deep wells. The nearest producing gas wells were in the southern part of the CO₂ storage study area, approximately 3.6 miles southwest of the stratigraphic well for the FutureGen 2.0 Project. However, these two wells were both relatively shallow (i.e., 334 and 342 feet deep). Most of the water wells in the AoR are shallow, and have depths ranging from 19 feet to 115 feet. However, there are two deeper wells with depths of 405 feet and 1,056 feet, which are still more than 2,900 feet above the injection zone.

The nearest major fault system is the Wabash Valley System. The site is approximately 156 miles northeast of one identified fault in this system (ISGS 2012e). There are no known surface ruptures on the faults within the Wabash Valley area (Obermeier and Crone 1994). The injection area is also outside of the area identified as having liquefaction features caused by unknown faults in the Wabash Valley System, which do not extend to the surface and may be associated with the Precambrian basement (Crone and Wheeler 2000). There are two smaller faults, but neither is close to the storage area (Nelson 1995). One fault is located west of the La Salle Anticline, which is approximately 68 miles to the northeast of the proposed injection area and the other fault is located west of the Salem Anticline and is approximately 85 miles from the proposed injection area. The general seismic activity of the region is low near the CO₂ storage study AoR, with a 2 percent probability of a seismic event with a peak acceleration of 8 to 10 percent of the gravity coefficient within the next 50 years (USGS 2012b). Past earthquakes of 4.5 magnitudes have occurred mostly in the southern part of the state, although the nearest earthquake was centered approximately 25 miles to the northeast (ISGS 2009). Because of low seismic activity and the lack of faults near the injection ROI, potential releases along faults are not expected for the Mt. Simon Formation and were therefore not modeled.

The information summarized above on the site conditions and the experiences at other sites from the Analog database were used to identify the likelihood of potential releases and estimated flux rates for the releases. Table 3.17-15 shows the subsurface release flux rates and durations pertinent to potential releases from the likely injection zone. The rate of slow leakage through the caprock and other formations was estimated using data from the Farnham Dome Site in Utah, which has natural CO₂ in sandstone and dolomite overlain by an interbedded limestone, shale and siltstone cap. Migration of CO₂ through the 1,080 feet of dolomite layers between the Eau Claire Formation and into the lowest USDW, the St. Peter Sandstone, is considered unlikely to result in a release of gas to the ground surface. The SCREEN3 model was used to simulate the resulting ambient air concentrations for CO₂ due to gradual, slow seepage of gases through the caprock and other overlying formations. The slow seepage rates were allowed to continue during the modeling run for an extended period up to 5,000 years as a conservative estimate because small leaks could be harder to detect.

DOE used a time period of 5,000 years based on modeling of CO₂ storage sites such as the Weyburn site in Saskatchewan, where “after 5,000 years modeling determined that a free supercritical CO₂ dense gas phase will no longer exist, having been effectively trapped” (Preston et al. 2005). The modeling results showed that there was a 95 percent probability that 98.7-99.5 percent of the initial CO₂-in-place would remain stored in the geosphere for 5,000 years and the likelihood of movement beyond this time period was very low (IEA 2005). Thus, a frequency of occurrence was estimated over 5,000 years for these natural pathways. The frequency unit was listed as 1/5,000 year per event, since the diffuse flux could occur over the entire spatial extent of the subsurface plume.

The frequency for a rapid release through the caprock was estimated as $<1 \times 10^{-6}$, since an eruptive release in sedimentary basins has not occurred due to natural pathways (IEA 2006b) and modeling studies of CO₂ discharges concluded that there are self-limiting features that prevented an eruptive release powered solely by mechanical energy stored in an accumulation of non-condensable gas, without substantial contributions from thermal energy (Pruess 2006). A higher frequency of 1×10^{-4} was used for gradual releases through the caprock, since low diffuse fluxes have occurred in some natural CO₂ areas (e.g. Klusman 2003). However, the proposed target formation for the FutureGen 2.0 Project, the Mt. Simon Formation, has a thick caprock and multiple secondary seals consisting of thick shale and dolomite seals, so a higher frequency than 1×10^{-4} for diffuse leaks was not used for this site. Atmospheric releases of trace gases are unlikely for this release mechanism, because the trace gases in the injected fluid would dissolve in the brine or groundwater in the various layers. Thus, the trace gases would be unlikely to reach the land surface from slow seepage through multiple saturated formations.

Since there are no known nearby faults or overpressure zones, neither of these pathways was simulated. The frequency for leaks along faults due to regional overpressure was estimated as 1×10^{-5} , as used in the risk assessments for two Australian candidate geologic storage sites in the Latrobe Valley (Hooper et al. 2005) and in previous DOE projects (DOE 2007b). The same frequency was also used for leakage along faults due to local overpressure. The duration for the faults was 30 years, corresponding to the originally proposed active injection period, when pressure in the reservoir is increasing. The analysis was not re-run for the currently proposed 20-year injection period, since it serves as a conservative upper bound for the impact analysis. The frequency unit is shown as 1/5,000 year per fault, since there could be multiple faults within the storage site, although not at this site. Leakage along unknown structural or stratigraphic connections was assigned the same frequency as faults. Lateral migration to a non-target aquifer was assigned a frequency of 1×10^{-6} , as used for leakage through a permeable zone in a seal (Hooper et al. 2005). The duration of these types of releases is estimated as 100 years to allow time for “the pressure-perturbed system to relax and return to an equilibrium state, generally long after injection ceases” (Birkholzer et al 2009). Modeling results for the injection into the Mt. Simon Formation show an increase in pressure during active injection, and then show a decrease to 90 percent within the first 100 years (Appendix G, Geological Report). The frequency unit is shown as 1/5,000 year per zone, since there could be multiple higher permeability zones within the storage site, although not at this site.

Potential leakage from the CO₂ injection wells after injection ceased and from unknown abandoned or poorly constructed deep wells either during active injection or after injection ceased were also simulated using SCREEN3, because the flux rates were low and the CO₂ gas would not be supercritical. Potential CO₂ and trace gas releases at a low flux rate through deep wells were analyzed, although releases of trace gases are less likely. Table 3.17-15 also shows the subsurface release flux rates and durations pertinent to potential releases from wells. A potential future leak through an injection well after injection ceased was based on 1 percent of the amount injected per well into a vertical well on an annual basis for the high rate and 0.01 percent of the amount for the low rate. Following injection, leakage along the vertical portion of a horizontal well is more likely, so this is an upper bound. The high rate for the abandoned wells used was five times the low injection well rate, since they could be older wells with potential damage to the cement used to close the wells, so that the hole diameter could be larger. One-half of the high rate was used as the low rate for abandoned wells. No deep oil or gas wells were simulated, since the known wells and producing reservoirs are shallower than the Mt. Simon Formation, as discussed previously.

The frequency for leaking injection wells during the operational period was estimated as 2×10^{-5} per year-well. This frequency was decreased to 1×10^{-5} per year-well for the injection wells following operation, since these would be new wells constructed for CO₂ injection. The duration of the leaks was estimated based on the time to detect a leak and repair the well, a week for high rates to a year for low rates in the future when the locations of the injection wells could be uncertain. The frequency for leaks from abandoned or deep oil and gas wells, since these wells are likely to be older and constructed as standard industrial wells, was set as 1×10^{-3} for leaking wells (Hooper et al. 2005). For leaking abandoned or

undocumented wells that may not have been properly plugged, the duration of 100 years was used to represent the time when reservoir pressure would be elevated. The frequency unit for wells is 1/year-well, since the likelihood of leaks along this pathway is a function of the number of wells within the estimated subsurface CO₂ plume area.

Table 3.17-15. Potential Subsurface CO₂ Releases from Wells and Subsurface Storage Formation

Mechanism	Frequency	Frequency Units	Flux Rate (μmol/m ² -s)	Flux Area (acres)	Duration (years)
Leakage via Upward Migration through Caprock due to Gradual and Slow Release	1x10 ⁻⁴	1/5,000 year-event	0.13-0.97	4,000 acres (6.25 sq mi)	5,000
Leakage via Upward Migration through Caprock due to Catastrophic Failure and Rapid Release	< 1x10 ⁻⁶	1/5,000 year-event	NS ^a	NS	5,000
Leakage through Existing Faults due to Increased Pressure (regional overpressure)	1x10 ⁻⁵	1/5,000 year-fault	NS ^b	NS	30
Leakage through Induced Faults due to Increased Pressure (local overpressure)	1x10 ⁻⁵	1/5,000 year-fault	NS ^b	NS	30
Leakage into Non-target Aquifers due to unknown Structural or Stratigraphic Connections	1x10 ⁻⁵	1/5,000 year-zone	NS ^c	4,000 acres (6.25 sq mi)	100
Leakage into Non-target Aquifers due to Lateral Migration from Target Zone	1x10 ⁻⁶	1/5,000 year-zone	NS ^c	4,000 acres (6.25 sq mi)	100
Leaks from CO ₂ Injection Wells after Injection Ceases, high rate	1x10 ⁻⁵	1/year-well	5,500 MT/yr	0.011	0.02 (1 week)
Leaks from CO ₂ Injection Wells after Injection Ceases, low rate	1x10 ⁻⁵	1/year-well	550 MT/yr	0.011	1 year
Leaks from Deep Oil and Gas Wells, high rate	1x10 ⁻³	1/year-well	NA	NA	NA
Leaks from Deep Oil and Wells, low rate	1x10 ⁻³	1/year-well	NA	NA	NA
Leaks from Deep Abandoned or Undocumented Wells, high rate	1x10 ⁻³	1/year-well	2,750 MT/yr	0.073	0.02 (1 week)
Leaks from Deep Abandoned or Undocumented Wells, low rate	1x10 ⁻³	1/year-well	275 MT/yr	0.073	100

^a. Not simulated since release mechanism is considered extremely unlikely (10⁻⁴ to 10⁻⁶).

^b. Not simulated since no faults near estimated plume area.

^c. Not simulated since would not result in emissions to atmosphere.

Note: 1 μmol/m²-s = 3.807 g/m²-day, used to represent a flux rate of CO₂ through the ground surface.

μmol/m²-s = micromole per square meter per second; CO₂ = carbon dioxide; g/m²-day = grams per square meter per day; MT/yr = million tons per year; NA = not applicable since release would not reach ground surface; NS = not simulated; sq mi = square mile; year-event = per year per event; year-fault = per year per fault; year-well = per year per well; year-zone = per year per zone

The estimated air concentrations from SCREEN3 due to potential subsurface releases are shown in Table 3.17-16 and Table 3.17-17. The risk ratios were calculated by dividing each exposure concentration for CO₂ or a trace gas by the pertinent criteria. A risk ratio of less than one indicates that there is no hazard from that exposure concentration, and all risk ratios were found to be substantially less than one as

shown in the tables. Risk ratios are used to evaluate potential toxic effects; they are not used to evaluate carcinogenic effects. The gases evaluated here are not carcinogens. The comparison to the pertinent acute and chronic criteria for CO₂, hydrogen sulfide, sulfur dioxide, and sulfur trioxide indicated that no exceedances at a distance of 300 feet are likely to occur. Most of the risk ratios were less than 0.1 indicating minimal potential for effects from gaseous releases. Thus, no effects to the general public are expected to occur from post-injection releases by these pathways.

Table 3.17-16. Potential Acute Human Health Effects within 300 Feet of Post-injection Releases

Release Scenario	Gas	Effects			Exposures Concentration (ppmv)	Risk Ratio ^a
		Criteria (ppmv)		Type		
Upward leakage through the CO ₂ injection wells after injection ceases (days)	CO ₂	5,000	PEL (8 hours)	No appreciable health effects	41.89	0.0084
	H ₂ S	0.33	AEGL-1 (8 hours)	Above this level adverse effects possible	0.0011	0.0033
		0.07	Acute MRL (1-14 days)	Above this level serious effects possible	0.0011	0.016
	SO ₂	0.2	AEGL-1 (8 hours)	Above this level adverse effects possible	0.00023	0.00115
		0.01	Acute MRL (1-14 days)	Above this level serious effects possible	0.00023	0.023
	SO ₃	0.06	AEGL-1 (8 hours)	Above this level adverse effects possible	0.00041	0.0068
Upward leakage through undocumented, abandoned, or poorly constructed wells (days) ^b	CO ₂	5,000	PEL (8 hours)	No appreciable health effects	139.0	0.028
	H ₂ S	0.33	AEGL-1 (8 hours)	Above this level adverse effects possible	0.0036	0.011
		0.07	Acute MRL (1-14 days)	Above this level serious effects possible	0.0036	0.05
	SO ₂	0.2	AEGL-1 (8 hours)	Above this level adverse effects possible	0.00075	0.0037
		0.01	Acute MRL (1-14 days)	Above this level serious effects possible	0.00075	0.075
	SO ₃	0.06	AEGL-1 (8 hours)	Above this level serious effects possible	0.0014	0.023

^a. Risk ratios were calculated by dividing each exposure concentration for CO₂ or a trace gas by the pertinent criteria. A risk ratio of less than one indicates that there is no hazard from that exposure concentration.

^b. Deep oil and gas wells were not simulated, since not considered to be likely exposure pathway at this site.

AEGL = acute exposure guideline level; CO₂ = carbon dioxide; H₂S = hydrogen sulfide; MRL = minimal risk level; PEL = permissible exposure limit; ppmv = parts per million volume; SO₂ = sulfur dioxide; SO₃ = sulfur trioxide

Table 3.17-17. Potential Chronic Human Health Effects within 300 Feet of Post-injection Releases

Release Scenario	Gas	Effects			Exposures	Risk Ratio ^a
		Criteria (ppmv)		Type	Concentration (ppmv)	
Upward leakage through caprock and seals, gradual failure and slow release	CO ₂	5,000	PEL (8 hours)	No appreciable health effects	4.95	0.001
	H ₂ S	0.02	Intermediate MRL (14-365 days)	Above this level, serious effects possible	0.00013	0.0065
		0.0014	RfC (lifetime)	No appreciable health effects including sensitive subgroups	0.00013	0.093
	SO ₂	0.01	MRL (1-14 days)	Above this level, serious effects possible	0.000027	0.0027
	SO ₃	0.06	AEGL-1 (8 hours)	Above this level, adverse effects possible	0.000049	0.00082
Upward leakage through the CO ₂ injection wells after injection ceases	CO ₂	5,000	PEL (8 hours)	No appreciable health effects	4.19	0.00084
	H ₂ S	0.02	Intermediate MRL (14-365 days)	Above this level, serious effects possible	0.00011	0.0055
		0.0014	RfC (lifetime)	No appreciable health effects including sensitive subgroups	0.00011	0.078
	SO ₂	0.01	MRL (1-14 days)	Above this level, serious effects possible	0.000023	0.0023
	SO ₃	0.06	AEGL-1 (8 hours)	Above this level, adverse effects possible	0.000041	0.00068
Upward leakage through abandoned or undocumented, well(s) ^a	CO ₂	5,000	PEL (8 hours)	No appreciable health effects	13.90	0.0028
	H ₂ S	0.02	Intermediate MRL (14-365 days)	Above this level, serious effects possible	0.00036	0.018
		0.0014	RfC (lifetime)	No appreciable health effects including sensitive subgroups	0.00036	0.26
	SO ₂	0.01	MRL (1-14 days)	Above this level, serious effects possible	0.000075	0.0075
	SO ₃	0.06	AEGL-1 (8 hours)	Above this level, adverse effects possible	0.00014	0.0023

^a Risk ratios were calculated by dividing each exposure concentration for CO₂ or a trace gas by the pertinent criteria. A risk ratio of less than one indicates that there is no hazard from that exposure concentration.

^b Deep oil and gas wells were not simulated, since they were not considered to be likely exposure pathways at this site.

AEGL = acute exposure guideline level; CO₂ = carbon dioxide; H₂S = hydrogen sulfide; MRL = minimal risk level; PEL = permissible exposure limit; ppmv = parts per million volume; RfC = reference concentration; SO₂ = sulfur dioxide; SO₃ = sulfur trioxide

Potential Radon Releases

A potential concern that has been brought up with geologic storage of CO₂ is displacement of radon gas from the injection formation or other formations into which the CO₂ might migrate. This is more of a concern where the radon in homes exceeds the USEPA action level for radon of 4 picocuries per liter.

Morgan County is located in Zone 1 as defined by USEPA (USEPA 2012i), which has a potential to exceed this criteria (IEMA 2009). In Morgan County, a total of 40 homes have been tested, of which 28 were above 4 picocuries per liter (IEMA 2012a). Mitigation systems were implemented in 11 homes in the county, in the Jacksonville area, and in the southeastern corner of the state (IEMA 2012b). None of the mitigation systems were in the proposed area for injection. Due to the thick caprock above the injection formation (479-foot Eau Claire Formation) and multiple low permeability dolomite and shale formations between the caprock and the glacial deposits, it is considered unlikely that the CO₂ could displace additional radon in the shallow formations.

3.17.4 Intentional Destructive Acts

As with any United States energy infrastructure, the proposed FutureGen 2.0 Project facilities could potentially be the target of terrorist attacks or sabotage. However, the potential for such attacks on coal-fueled power plants has not been identified as a threat of comparable magnitude to the concerns about the vulnerability of nuclear power plants to terrorist attacks (Behrens and Holt 2005).

Although risks of sabotage or terrorism cannot be quantified because the probability of an attack is not known, the potential environmental effects of an attack can be estimated. Such effects may include localized impacts from releases of harmful materials or gases at the Meredosia Energy Center and associated facilities, similar to those that could occur as a result of an accident or a natural disaster. To evaluate the potential impacts of sabotage or terrorism, failure scenarios are analyzed without specifically identifying the cause of failure mechanism. For example, a truck running over an injection wellhead would result in a wellhead failure, regardless of whether this was done intentionally or through mishap. Releases of harmful chemicals can occur due to failure of a component, human error, a combination of both, or from external events such as plane or rail accidents (e.g., delivery of hazardous chemicals to the site), seismic events, or other natural events such as high winds, tornadoes, floods, ice storms, and natural or human-caused fires. Therefore, the accident analysis conducted for this EIS evaluates the outcome of catastrophic events without determining the motivation behind the incident. The accident analyses included potential releases from accidents at the energy center, CO₂ pipeline, and injection wells. These accidents could also be representative of the impacts from a sabotage or terrorism event.

Release scenarios evaluated included: liquid oxygen tank leaks, pipeline rupture or puncture, and injection well failure as described previously. Evaluations of hypothetical releases indicate the following potential impacts:

- The most likely individuals to be affected by releases from the energy center equipment or tanks are onsite workers. The estimated number of workers during operations is 87 to 115 people, although not all would be present at any given time in proximity to an incident. A failure of the liquid oxygen tanks at the Meredosia Energy Center was evaluated as a potential impact to workers due to fires or frostbite. The initial vapor cloud from such a release was estimated to be within the energy center property.
- CO₂ and trace gases could be dispersed into the air and migrate downwind from pipeline ruptures or punctures or injection well failures. The number of individuals from the general population potentially experiencing transient effects from a release event of CO₂ **would be less than one. For a release event from the pipeline or injection wells that includes the trace gases hydrogen sulfide, sulfur dioxide, or sulfur trioxide the number of individuals experiencing transient effects is estimated to be three or less.** However, under normal operating conditions, the concentration of trace gases are expected to be lower than simulated, in which case there would be no effects from the trace gases to the general public.
- Under the highest consequence scenarios, onsite workers would be the individuals most at-risk of injury or death if near a release at the energy center, pipeline, or injection wells.

3.17.5 Impacts of the No Action Alternative

Under the no action alternative, DOE would not provide cost-shared funding for the FutureGen 2.0 Project. Although the Alliance may still elect to construct and operate the project in the absence of DOE cost-shared funding, for the purposes of the analysis in this EIS, DOE assumed the no action alternative is equivalent to the no-build alternative. Therefore, the project would not be constructed and there would be no change in the status quo with respect to human health and safety conditions within the ROI.

3.18 SOCIOECONOMICS

3.18.1 Introduction

This section addresses the socioeconomic conditions most likely to be affected by the construction and operation of the FutureGen 2.0 Project. The discussion presents the region's demographics, economy, sales and tax revenues, per capita and household incomes, sources of income, and housing availability. This section also addresses potential direct and indirect impacts on socioeconomics resulting from the proposed project.

3.18.1.1 Region of Influence

The ROI for socioeconomics includes Morgan County (in which project components would be located) as well as the surrounding counties of Brown, Cass, Pike, and Scott.

3.18.1.2 Method of Analysis and Factors Considered

DOE performed the socioeconomic impact analysis in this EIS in the following sequence: (1) DOE reviewed data from the U.S. Census Bureau to determine population and employment trends within the ROI; and (2) DOE overlaid the project, including community services and other impacts identified in other sections of this EIS, onto these existing trends to determine potential socioeconomic impacts. It is likely that workers would reside in the primary population centers surrounding the energy center site. Overall, economic benefits would occur throughout the ROI.

DOE assessed the potential for impacts, both beneficial and adverse, based on whether the proposed project would:

- Displace existing population or demolish existing housing;
- Alter projected rates of population growth;
- Affect the housing market;
- Displace existing businesses;
- Affect local businesses and the economy;
- Displace existing jobs; or
- Affect local employment or the workforce.

3.18.2 Affected Environment

The Meredosia Energy Center is located in Morgan County and is surrounded by Brown, Cass, Pike, and Scott counties. For the counties potentially impacted by the FutureGen 2.0 Project, Table 3.18-1 compares the population information, Table 3.18-2 presents the housing data, and Table 3.18-3 presents the employment and income information.

3.18.2.1 Meredosia Energy Center, CO₂ Pipeline, CO₂ Storage Study Area, and Educational Facilities

Population and Housing

Population

Table 3.18-1 provides population information for the counties potentially affected by the FutureGen 2.0 Project. The Meredosia Energy Center and the injection well site(s) are located in Morgan County. Brown, Cass, Pike, and Scott counties (see Figure 3.19-1) surround Morgan County and could also be impacted socioeconomically by the program.

Morgan County had a total population of 35,547 in 2010 (USCB 2010e) and lost population as did other counties in the ROI since 2000, while the state population increased. In 2010, the total population for the five counties within the ROI was approximately 77,911 (USCB 2010e). The 2010 population of Illinois was 12,830,632 persons, representing a 3.3 percent increase from 2000 (USCB 2010e). The 2010 United States estimated population was 308,745,538, representing a 9.7 percent increase from 2000. Based on the trends within the region, the population is anticipated to grow at a slower rate than the United States and Illinois. These trends reflect a continuing decline in the population of northern Midwest rural areas with the nationwide shift in population to sunbelt states.

Approximately 24.3 percent of United States residents and 24.3 percent of Illinois residents were under the age of 18 in 2009, versus 21 percent of the population in Morgan County and 16.8, 24.9, 22.3, and 22.7 percent in Brown, Cass, Pike, and Scott counties, respectively (USCB 2010e). Approximately 12.4 percent of Illinois residents and 12.9 percent of United States citizens were over the age of 64 in 2009 versus 16.2 in Morgan County and 11.8, 15.6, 19.3, and 18.4 percent in Brown, Cass, Pike, and Scott counties, respectively (USCB 2010e); therefore, Morgan County and most surrounding counties give indications of an older population compared to the state and nation.

As discussed in Chapter 2, the Meredosia Energy Center suspended operations at the end of 2011. No substantial population changes are expected to result from the suspension of the facility.

Housing

Table 3.18-2 provides total housing and vacant units for the counties potentially affected by the FutureGen 2.0 Project. In 2010, there were 15,515 existing housing units in Morgan County and 34,223 within the ROI as a whole (USCB 2010f). Of the existing housing units within the ROI, 3,897 units were vacant, with Morgan County accounting for 1,411 of those units (USCB 2010f). The rental vacancy rate is 28.4 percent in Morgan County and 20.7 percent within the ROI.

As discussed in Chapter 2, the Meredosia Energy Center suspended operations at the end of 2011. There would be no changes in housing expected due to the suspension of the Meredosia Energy Center.

Table 3.18-1. Population Data

Jurisdiction	Total Population	Under 18 (percent)	65 and over (percent)	Persons per Household	Population Change 2000 to 2010 (percent)
Brown	6,937	16.8	11.8	2.09	-0.2
Cass	13,642	24.9	15.6	2.56	-0.4
Morgan	35,547	21.0	16.2	2.23	-2.9
Pike	16,430	22.3	19.3	2.34	-5.5
Scott	5,355	22.7	18.4	2.22	-3.3
All Above Counties	77,911	21.7	16.5	NA	-2.7
Illinois	12,830,632	24.6	12.4	2.62	3.3
United States	308,745,538	24.3	12.9	2.60	9.7

Source: USCB 2010f
 NA = not applicable

Table 3.18-2. Housing within the Region of Influence

Jurisdiction	Total Housing Units	Vacant Housing Units	Homeowner Vacancy Rate (percent)	Rental Vacancy Rate (percent)
Brown	2,462	363	3.3	12.7
Cass	5,836	566	6.0	24.7
Morgan	15,515	1,411	4.6	28.4
Pike	7,951	1,312	1.9	13.9
Scott	2,459	245	4.1	15.9
All Above Counties	34,223	3,897	3.7	20.7
Illinois	5,292,016	512,387	2.4	7.3
United States	129,969,653	17,324,523	2.4	7.4

Source: USCB 2010f

Regional Economy (Income, Workforce, and Unemployment)

Table 3.18-3 provides information about the workforce and per capita and median household incomes for the counties potentially affected by the FutureGen 2.0 Project. In 2010, the unemployment rate was 13.4 percent for the ROI and 9.4 percent for Morgan County, compared to an unemployment rate of 8.9 percent in both the United States and Illinois (USBLS 2011). Thus, the unemployment rate within Morgan County and the ROI is higher than that for Illinois and the United States.

In 2009, Morgan County had a median household income of \$42,672 and a per capita income of \$23,404 (USCB 2010a). The median household income for the entire ROI was \$42,855 and the per capita income was \$21,620 (USCB 2010a). In comparison, the median household income for the United States was \$52,221 and the per capita income was \$27,041 (USCB 2010a). The state of Illinois had a median household income of \$53,974 and a per capita income of \$28,469 (USCB 2010a). Based on 2009 Census data, both Morgan County and counties within the ROI have per capita incomes lower than both Illinois and the United States.

The Meredosia Energy Center employed 57 people prior to its suspension of operations at the end of 2011. Since the suspension of operations, all 57 positions were eliminated. Currently, only security personnel work at the energy center, with a few Ameren employees onsite from time to time to perform maintenance.

Table 3.18-3. Employment and Income Data

Jurisdiction	Labor Force (estimate)	Percent Unemployed	Per Capita Income	Median Household Income
Brown	3,572	5.1	\$16,866	\$42,134
Cass	7,793	7.8	\$19,440	\$41,828
Morgan	17,750	9.4	\$23,404	\$42,672
Pike	8,780	8.8	\$20,590	\$38,191
Scott	2,756	9.7	\$27,800	\$49,450
All Above Counties	40,651	8.6	NA	NA
Illinois	6,532,900	8.9	\$28,469	\$53,974
United States	152,635,000	8.9	\$27,041	\$52,221

Sources: USCB 2010a; USBLS 2011
 NA = not applicable

3.18.3 Impacts of Proposed Action

3.18.3.1 Construction Impacts

Meredosia Energy Center

Population and Housing

There would be a negligible to minor impact on population and housing from construction of the oxy-combustion facility at the Meredosia Energy Center. To the extent impacts occur, they are expected to be short term and generally beneficial to the ROI.

The need for construction workers would be limited to the estimated 42-month construction period. Between 100 and 300 workers would be needed for the first 12 months; 300 to 500 workers for the second 12 months; 200 to 425 workers for the third 12 months; and up to 75 workers for the final 6 months. Work would peak **for approximately 7 months**, with approximately 400 to 500 construction and craft workers at the site on any given day.

Within the five-county ROI, an estimated 2,173 workers were employed in the construction industry between 2006 and 2010 (USCB 2010g). Based on the number of unemployed individuals in each of the counties within the ROI and the percentage of construction workers within each county, roughly 100 to 200 construction workers are presumed to be unemployed within the ROI and available to work on the project. Although DOE anticipates that most of the potential workers for the construction phase would already reside in the ROI, additional workers would be needed from outside the ROI. These workers would be expected to commute to the construction site on a daily basis (e.g., from the Springfield metropolitan area), while others may relocate to the area for the duration of the construction period. Therefore, a minor, temporary increase in population may occur.

The minor temporary increase in population would affect local housing demand commensurately and would have a minor beneficial short-term impact on the housing market. The ROI has approximately 3,897 vacant housing units, with Morgan County accounting for approximately 1,411 of these units. Even if all the construction workers relocated to the area, ample housing would be available. Depending upon the percentage of construction jobs that would be filled by existing residents, the increase of employees from outside the ROI could increase the occupancy rate for vacant housing units and hotels within the ROI. This would result in a positive, direct impact for the rental market and hotel industry within the ROI. Additionally, area residents may rent available rooms to supplement their household incomes, thereby contributing to a beneficial effect.

Economy and Employment

There would be a moderate, short-term, beneficial impact to the economy and employment within the ROI from construction at the Meredosia Energy Center. Construction of the facility would directly create up to 500 full-time and part-time construction jobs over the proposed 42-month duration of the effort. These workers would be paid consistent with wages in the area for similar trades. Direct, short-term impacts to employment would occur from jobs related to construction. Indirect employment (e.g., restaurant and other services staff) from incidental spending due to this increase in jobs may also be created in the ROI.

DOE used the Regional Input-Output Modeling System II (RIMS II), which was developed for the U.S. Department of Commerce, Bureau of Economic Analysis, to evaluate the indirect economic impact on employment from constructing the Meredosia Energy Center. RIMS II provides two types of multipliers, final-demand and direct-effect, for estimating the impacts of changes on employment. An estimate of the change in the total number of jobs in the region's economy was calculated by multiplying the initial change in jobs by a direct-effect employment multiplier. By adding up to 500 FTE construction positions, the analysis showed that 577 secondary jobs would be created as a result of the construction of the oxy-combustion facility at the Meredosia Energy Center (BEA 2012). This would reduce the unemployment rate in the region and temporarily benefit the regional economy and employment.

Therefore, a moderate, short-term beneficial impact on employment rates and income would occur within the ROI during the construction period.

The purchase of building materials, construction supplies, and construction equipment, as well as spending by the construction workers, would add income to the local economy. These expenditures commonly include gasoline, automobile servicing, food and beverages, laundry, and other retail purchases undertaken in the immediate area because of convenience and access during the course of the business day. Therefore, a short-term, beneficial impact to economic activity within the ROI would occur during the construction period.

No displacement of existing businesses would be expected as a result of construction for the project.

Taxes and Revenue

There would be a moderate, short-term, beneficial impact to taxes and revenue within the ROI from construction of the oxy-combustion facility at the Meredosia Energy Center.

Construction of the project would generate revenue through state and local taxes over the duration of the effort. Local entities would benefit from temporarily increased sales tax revenues resulting from project-related spending on payroll and construction materials. It is anticipated that construction workers would spend their wages on short-term housing, food, and other personal items within the ROI. Additional sales tax revenues could result from taxes that are embedded in the price of consumer items such as gasoline. Therefore, an indirect and beneficial, short-term impact could be expected for the local economy from increased spending and related sales tax revenue.

CO₂ Pipeline and CO₂ Storage Study Area

Although the Alliance selected the southern route as its proposed route, the route could ultimately deviate slightly as a result of final project design and continuing coordination with landowners. However, the same siting criteria would be followed and impacts would be consistent with those addressed in this section. In addition, since the publication of the Draft EIS, the Alliance updated the design of the injection well site(s) to a single-site scenario that contains all four horizontal wells and surface facilities at one site (see Section 2.5.2.2). This design update resulted in a change to the number of construction workers required for the project. This section discusses the number of jobs created for both the original and revised designs. Additionally, the Alliance identified a proposed property for the injection well site as discussed in Section 2.5.2.1.

Population and Housing

There would be a negligible to minor impact on population and housing from construction of the CO₂ pipeline for either the southern or northern route, and for construction of the CO₂ injection well site(s). To the extent impacts would occur, they are expected to be short term and generally beneficial to the ROI. The acquisition of ROWs for construction of the pipeline would not require the displacement of population or demolition of existing housing. **The acquisition of the proposed injection well site (see Section 2.5.2.1 and Figure 2-20) would require the demolition of a vacant house. This acquisition would be conducted as a voluntary acquisition as specified in the Uniform Relocation Act (49 CFR 24). Because the house is currently vacant, its demolition would not displace population nor affect the regional housing market.**

Between 150 and 300 workers would be needed for the construction of the pipeline and approximately 55 workers would be needed for the construction of the injection well **facilities for the dual-site scenario analyzed in the Draft EIS and no longer under consideration by the Alliance. The updated design currently proposed by the Alliance would require the same number of construction workers for the pipeline, but the number of workers required for construction of the single-site scenario would decrease to approximately 35.** Construction workers mainly would come from within Morgan County and would be hired from county labor pools. Within the five-county ROI, an estimated 2,173 workers were employed in the construction industry from 2006 to 2010 (USCB 2010g). Based on the number of

unemployed individuals in each of the counties within the ROI and the percentage of construction workers within each county, roughly 100 to 200 construction workers are presumed to be unemployed within the ROI. A smaller number of temporary construction workers with specialized training, and workers employed by contractors from outside the ROI, would also likely be employed to construct the pipeline. Some of these workers would be expected to commute to the construction site on a daily basis, while others may relocate to the area for the duration of the construction period. Therefore, a negligible to minor, temporary increase in population may occur.

The minor temporary increase in population would increase local housing demand commensurately and would have a negligible beneficial short-term impact on the ROI's housing market as described above for the Meredosia Energy Center, because ample housing is available. Depending upon the percentage of construction jobs that would be filled by existing residents, the increase of employees from outside the ROI could increase the occupancy rate for vacant housing units and hotels within the ROI. This would result in a positive, direct impact for the rental market and hotel industry within the ROI. Additionally, area residents may rent available rooms to supplement their household incomes, thereby contributing to a beneficial effect.

Economy and Employment

There would be a moderate, short-term, beneficial impact to the economy and employment within the ROI from construction of the CO₂ pipeline along either the southern or northern route, and for construction of the CO₂ injection well site(s).

Construction of the CO₂ pipeline would directly create up to 300 full-time and part-time construction jobs and the construction of the injection well sites **for the dual-site scenario, which is no longer under consideration by the Alliance**, would directly create up to 55 full-time jobs over the proposed construction period, for a total of approximately 355 jobs. **Construction of the single-site scenario injection wells currently proposed by the Alliance would require fewer construction workers and result in a total of approximately 335 full-time jobs for construction of the pipeline and injection wells.** These workers would be paid consistent with wages in the area for similar trades. Direct, short-term impacts to employment would occur from jobs related to construction. Indirect employment (e.g., restaurant and service staff) from incidental spending due to this increase in jobs may also be created in the ROI.

By adding 150 to 300 FTE construction positions, the RIMS II analysis showed that approximately 173 to 346 secondary jobs would be created as a result of construction of the CO₂ pipeline (BEA 2012). By adding 55 FTE construction positions **for the originally proposed dual-site scenario**, the RIMS II analysis showed that up to 63 secondary jobs would be created as a result of construction of the injection well site(s) (BEA 2012). **For the single-site scenario currently proposed by the Alliance, the 35 FTE construction workers for the injection wells would create approximately 40 secondary jobs. The additional jobs** would reduce the unemployment rate in the region and temporarily benefit the economy and employment in the ROI. Therefore, a moderate, short-term beneficial impact on employment rates and income would occur within the ROI during the construction period. Additional short-term, beneficial effects on the economy in the ROI would result from purchases of materials, supplies, and services during construction, as described above for the Meredosia Energy Center.

No existing businesses or jobs are expected to be displaced by acquisition of ROWs or construction of the pipeline.

Taxes and Revenue

There would be a moderate, short-term, beneficial impact to taxes and revenue within the ROI from construction of the CO₂ pipeline and the CO₂ injection well site(s).

Construction of the project would generate revenue through state and local taxes over the duration of the effort. Local entities would benefit from temporarily increased sales tax revenues resulting from project-

related spending on payroll and construction materials. It is anticipated that construction workers would spend their wages on short-term housing, food, and other personal items within the ROI. Additional sales tax revenues could result from taxes that are embedded in the price of consumer items such as gasoline. Therefore, an indirect and beneficial short-term impact could be expected for the local economy from increased spending and related sales tax revenue.

Educational Facilities

Population and Housing

There would be a negligible to minor impact on population and housing from construction of the educational facilities in Morgan County. To the extent impacts occur, they are expected to be short term and generally beneficial to the ROI. The acquisition of property for construction of the educational facilities would not require the displacement of population or demolition of existing housing.

As analyzed in the Draft EIS, approximately 87 workers would be needed for the design and construction of the educational facilities in Morgan County for the two-building design. In comparison, the current one-building design would require approximately 47 design and construction employees. Construction workers would come mainly from within the county and would be hired from local county labor pools as described above for the CO₂ pipeline and CO₂ injection well site(s). Even if all workers were hired externally and relocated to the ROI, the effect on population and housing in the ROI would be negligible and temporary.

Economy and Employment

There would be a minor, short-term, beneficial impact to economy and employment within the ROI from construction of the educational facilities in Morgan County.

Construction of the **two-building design for the educational facilities analyzed in the Draft EIS** would directly create up to 87 full-time construction jobs over the proposed construction period. **The current one-building design would create up to 47 full-time construction jobs.** These workers would be paid consistent with wages in the area for similar trades. Direct, short-term impacts to employment would occur from jobs related to construction. Indirect employment (e.g., restaurant staff) from incidental spending due to this increase in jobs may also be created in the ROI.

By adding up to 87 FTE construction positions **for the two-building design**, the RIMS II analysis showed that up to 100 secondary jobs would be created as a result of construction of the educational facilities (BEA 2012). **Since the current one-building design of the educational facilities would require only 47 FTE construction positions, approximately 55 secondary jobs would be created.** **The additional jobs** would reduce the unemployment rate in the region and temporarily benefit the economy and employment in the ROI. Therefore, a minor, short-term beneficial impact on employment rates and income would occur within the ROI during the construction period. Also, as described above for the CO₂ pipeline and CO₂ injection well site(s), secondary spending during the construction effort on materials and supplies, as well as by workers for food and services, would result in short-term, beneficial impacts on economic activity.

As described in Sections 2.5.3 and 3.0, since the release of the Draft EIS, discussions between the Alliance and Jacksonville civic authorities have focused on a potential site for the educational facilities in Jacksonville, but the specific locations for the educational facilities currently remain unknown. Potential displacement of any business that may be associated with the siting of the educational facilities would be appropriately addressed and compensated through agreement between the Alliance and Jacksonville civic authorities.

Taxes and Revenue

There would be a minor, short-term, beneficial impact to taxes and revenue within the ROI from construction of the educational facilities in Morgan County.

The project would generate revenue through state and local taxes over the duration of construction. Local entities would benefit from temporarily increased sales tax revenues as described above for the CO₂ pipeline and CO₂ injection well site(s). Therefore, an indirect and beneficial, short-term impact could be expected for the local economy from increased spending and related sales tax revenue.

3.18.3.2 Operational Impacts

Meredosia Energy Center

Population and Housing

There would be a negligible to minor impact on population and housing in the ROI from operation of the Meredosia Energy Center. The project would require approximately 87 to 115 full-time employees. It is anticipated that most of the employees would be drawn from the workforce residing within the ROI. Housing for any workers relocating to the area would likely be distributed between owned and rental accommodations.

Even if all of the required staff relocated to the ROI, the increase in population would be very small. Based on the 2010 estimated population and the average household size (2.5 people per household) within the ROI, the relocation of 87 to 115 employees could result in a population increase of 218 to 288 people, representing a 0.28 to 0.37 percent increase in population within the five-county ROI. Any influx of employees from outside the ROI could increase the occupancy rate for vacant housing units within the ROI. Ample housing exists within the ROI to support this increase in population. The ROI has approximately 3,897 vacant housing units, with Morgan County accounting for approximately 1,411 of these units. If all 87 to 115 employees relocated to the ROI, this would represent only a 2.2 to 3.0 percent decrease in available housing.

Economy and Employment

A moderate long-term, beneficial impact to economy and employment would occur within the ROI from operation of the Meredosia Energy Center. The operational phase of the project would have annual operation and maintenance needs that would benefit the ROI. Local contractors could be hired to complete specialized maintenance activities that could not be undertaken by permanent staff, and items such as repair materials, water, and chemicals could be purchased within the ROI. This would have a beneficial impact on the economy in the ROI.

The operational phase of the project would also have a direct and beneficial impact on employment by creating approximately 87 to 115 permanent jobs in the ROI. These new jobs would represent a 3.2 to 4.2 percent decrease in the unemployed workforce of the ROI. In addition, operation of the Meredosia Energy Center could replace many of the 57 jobs that were lost following the suspension of operations at the facility in 2011.

Each new operational job created by the project would generate secondary jobs, both indirect and induced. An indirect job supplies goods and services directly to the project. An induced job results from the spending of additional income from indirect and direct employees. By adding up 87 to 115 FTE permanent jobs, the RIMS II analysis showed that approximately 107 to 142 secondary jobs would be created as a result of operation of the Meredosia Energy Center (BEA 2012). This would further reduce the unemployed workforce in the region by an additional 3.9 to 5.2 percent and benefit the economy and employment in the region. Therefore, a moderate, beneficial impact on employment rates and income would occur within the ROI during operations. No existing businesses or jobs would be displaced by energy center operations.

The Illinois Commerce Commission approved a 20-year power purchase agreement for the FutureGen 2.0 Project as discussed in Section 2.4.4.5 (Illinois Commerce Commission 2013a). As part of the approval process, the cost of the FutureGen 2.0 Project was independently evaluated against a cost benchmark designed to protect Illinois ratepayers. The costs were estimated to be less than the cost benchmark. Under the power purchase agreement, Ameren and Commonwealth

Edison (an Exelon subsidiary) would enter into contracts with the Alliance to purchase the electricity generated by the FutureGen 2.0 Project. The average monthly bill impact for residential customers serviced by either Ameren or Commonwealth Edison is estimated to be less than \$1.50 per month. Customers of rural electric cooperatives would see no impact to their monthly electric bills.

Taxes and Revenue

There would be a long-term, beneficial impact to taxes and revenue within the ROI from operation of the Meredosia Energy Center. The estimated 87 to 115 employees who would fill new jobs created by the project could generate income tax revenues, as well as sales and use tax revenues within the ROI. Local entities would benefit from increased sales tax revenues resulting from spending on payroll, supplies, and materials. Therefore, an indirect and beneficial long-term impact could be expected for the local economy from increased spending and related sales tax revenue.

CO₂ Pipeline and CO₂ Storage Study Area

Although the Alliance selected the southern route as its proposed route, the route could ultimately deviate slightly as a result of final project design and coordination with landowners. However, the same siting criteria would be followed and impacts would be consistent with those addressed in this section. In addition, since the publication of the Draft EIS, the Alliance updated the design of the injection wells to a single-site scenario that contains all four horizontal wells and surface facilities at one site (see Section 2.5.2.2). Although the design update resulted in a change to the number of operational workers, this section discusses the number of jobs created for both the original and revised designs. Additionally, the Alliance identified a proposed property for the injection well site as discussed in Section 2.5.2.1.

Population and Housing

There would be a negligible impact to population and housing from operation of the CO₂ pipeline and CO₂ injection well site(s). Operation of the injection well sites **for the original dual-site scenario** would increase the number of employees by approximately 21 full-time positions. **The updated design for the single-site scenario currently proposed by the Alliance would create approximately 10 to 15 full-time positions.** Even if all of the staff relocated to the ROI, the increase in population would be very small. Based on an analysis comparable to that described above for the Meredosia Energy Center, the relocation of **up to 21** employees could result in an **increase of up to 0.03** percent in population within the five-county ROI and cause a **reduction of up to 0.5** percent in available housing.

Economy and Employment

There would be a minor, long-term, beneficial impact to the economy and employment within the ROI from operation and maintenance needs for the CO₂ pipeline and CO₂ injection well site(s). Local contractors could be hired to complete specialized maintenance activities that could not be undertaken by permanent staff, and items such as repair materials, water, and chemicals could be purchased within the ROI.

The operational phase of the project would also have a direct and beneficial impact on employment by creating approximately 21 permanent jobs in the ROI **for the dual-site scenario analyzed in the Draft EIS.** **The updated design for the single-site scenario currently proposed by the Alliance would create approximately 10 to 15 full-time positions.** These new jobs would represent a **decrease of up to 0.8** percent in the unemployed workforce of the ROI, and each new operations job created by the project would generate secondary jobs, both indirect and induced, as described above for the Meredosia Energy Center.

By adding **up to 21** FTE permanent jobs, the RIMS II analysis showed that **up to** approximately 18 secondary jobs would be created as a result of operation of the injection well site(s) (BEA 2012). This may further reduce the unemployed workforce and benefit the economy and employment in the region.

Taxes and Revenue

There would be a long-term, beneficial impact to taxes and revenue within the ROI from operation and maintenance of the injection well site(s). The estimated 21 employees who would fill new jobs created by the **dual-site scenario** could generate income tax revenues, as well as sales and use tax revenues within the ROI. In addition, sales tax would be levied on materials and supplies purchased for energy center operations. **The single-site scenario currently proposed by the Alliance would also have a long-term beneficial impact on taxes and revenues, although to a slightly lesser extent given the slightly lower number of employees.**

Educational Facilities

Population and Housing

There would be a negligible impact to population and housing from operation of the educational facilities. Operation of the educational facilities would require approximately 22 new full-time positions. Even if all of the staff relocated to the ROI, the increase in population would be very small. Based on an analysis comparable to that described above for the Meredosia Energy Center, the relocation of 22 employees with families could result in a 0.07 percent increase in population within the five-county ROI and cause a 0.6 percent reduction in available housing.

Economy and Employment

There would be a minor, long-term, beneficial impact to the economy and employment within the ROI from operation of the educational facilities. Daily spending by employees for food and services would positively affect the area, as would spending for materials and supplies to support facilities' operations. By attracting visitors interested in the technologies applied at the Meredosia Energy Center and the injection well site(s), the educational facilities would benefit the regional economy indirectly. Visitors would likely purchase food and refreshments at nearby establishments and utilize other services in the ROI.

The operational phase of the project would have a direct and beneficial impact on employment by creating approximately 22 permanent jobs in the ROI. These new jobs would represent a 0.8 percent decrease in the unemployed workforce within the ROI, and each new operations job created by the project would generate secondary jobs, both indirect and induced, as described above for the Meredosia Energy Center.

By adding 22 FTE permanent jobs (15 for the training facility and 7 for the visitor and research center), the RIMS II analysis showed that approximately 24 secondary jobs (15 due to the training facility and 9 due to the visitor and research center) would be created as a result of the operation of the educational facilities (BEA 2012). This would further reduce the unemployed workforce of the ROI by 0.9 percent and benefit the economy and employment in the region.

Taxes and Revenue

There would be a long-term, beneficial, impact to taxes and revenue within the ROI from operation of the educational facilities. The estimated 22 employees who would fill new jobs created by the operation of the educational facilities could generate income tax revenues, as well as sales and use tax revenues within the ROI. In addition, sales tax would be levied on materials and supplies purchased for operation of the educational facilities.

3.18.4 Impacts of the No Action Alternative

Under the no action alternative, DOE would not provide cost-shared funding for the FutureGen 2.0 Project. Although the Alliance may still elect to construct and operate the project in the absence of DOE cost-shared funding, for the purposes of the analysis in this EIS, DOE assumed that the no action alternative is equivalent to a no-build alternative. Therefore, the project would not be constructed and

there would be no change to socioeconomic conditions, as well as no potential benefits from the construction and operation of the energy center, CO₂ pipeline, injection wells, and educational facilities.

INTENTIONALLY LEFT BLANK

3.19 ENVIRONMENTAL JUSTICE

3.19.1 Introduction

This section identifies low-income and minority communities potentially affected by the construction and operation of the FutureGen 2.0 Project and analyzes potential direct and indirect impacts on environmental justice resulting from the proposed project.

3.19.1.1 Region of Influence

The proposed project would be located in Morgan County, which is surrounded by Brown, Cass, Pike, and Scott counties. The ROI was selected to include the census tracts and block groups that would be most directly affected by the construction and operation of FutureGen 2.0 Project components. These include the land areas within a 5-mile radius around the Meredosia Energy Center, and the land areas affected by the CO₂ pipeline corridor, the CO₂ storage study area, and the educational facilities. This land area includes all or part of Brown, Cass, Morgan, Pike, and Scott counties (see Figure 3.19-1). The compositions of minorities and low-income residents within these areas were considered in comparison to the compositions of minorities and low-income residents in the general population of Morgan County, adjacent counties (Brown, Cass, Pike, and Scott), the state of Illinois, and the United States in accordance with CEQ guidelines for purposes of identifying the potential for disproportionately adverse impacts.

3.19.1.2 Method of Analysis and Factors Considered

Census data to support environmental justice analyses typically are compiled at the census tract level and the block group level. DOE used block group data to characterize minority populations and census tract data to characterize low-income populations.

The analysis for environmental justice in this EIS was performed as follows. First, DOE collected demographic information from the U.S. Census Bureau to characterize low-income and minority populations. DOE then used potential environmental, socioeconomic, and health impacts identified in other sections of this EIS to assess potential impacts to environmental justice communities that could occur with the proposed construction and operation of the project. Finally, DOE utilized the CEQ's December 1997 Environmental Justice Guidance (CEQ 1997), which provides guidelines regarding whether human health effects on minority or low-income populations are disproportionately high and adverse. Under this guidance, agencies are advised to consider the following three factors to the extent possible:

- Whether the risks or rates of health effects (which may include bodily impairment, infirmity, illness, or death) are significant (as considered by NEPA), or above generally accepted norms;
- Whether the risk or rate of hazard exposure by a minority population, low-income population, or Native American tribe to an environmental hazard is significant (as considered by NEPA) and appreciably exceeds or is likely to appreciably exceed the risk or rate to the general population or other appropriate comparison group; and
- Whether health effects occur in a minority population, low-income population, or Native American tribe affected by cumulative or multiple adverse exposures from environmental hazards.

DOE assessed the potential for impacts based on whether the proposed project would:

- Cause a significant and disproportionately high and adverse effect on a minority population; or
- Cause a significant and disproportionately high and adverse effect on a low-income population.

3.19.1.3 Regulatory Framework

EO 12898, “Federal Actions to Address Environmental Justice in Minority Populations and Low-Income Populations,” provides that “each federal agency shall make achieving environmental justice part of its mission by identifying and addressing, as appropriate, disproportionately high and adverse human health or environmental effects of its programs, policies, and activities on minority populations and low-income populations” (EO 12898).

DOE (2012) defines “environmental justice” as:

The fair treatment and meaningful involvement of all people—regardless of race, ethnicity, and income or education level—in environmental decision making. Environmental Justice programs promote the protection of human health and the environment, empowerment via public participation, and the dissemination of relevant information to inform and educate affected communities. Department of Energy Environmental Justice programs are designed to build and sustain community capacity for meaningful participation for all stakeholders in Department of Energy host communities.

In its guidance for the consideration of environmental justice under NEPA, the CEQ defines a “minority” as an individual who is American Indian or Alaskan Native, Black or African American, Asian, Native Hawaiian or Pacific Islander, Hispanic or Latino. CEQ characterizes a “minority population” as existing in an affected area where the percentage of defined minorities exceeds 50 percent of the population, or where the percentage of defined minorities in the affected area is meaningfully greater (25 percent higher) than the percentage of defined minorities in the general population or other appropriate unit of geographic analysis. The CEQ guidance further recommends that low-income populations in an affected area should be identified using data on income and poverty from the U.S. Census Bureau (CEQ 1997). Low-income populations are populations where households have an annual household income below the poverty threshold, which was \$17,050 for a family of four at the time of the 2000 Census (HHS 2000) and \$22,050 for a family of four at the time of the 2010 Census (HHS 2010).

3.19.2 Affected Environment

3.19.2.1 Meredosia Energy Center

Minority Populations

As shown in Table 3.19-1 and Figure 3.19-1, the majority of the population within Morgan County, in which the Meredosia Energy Center is located, is white (90.9 percent), as compared to the state of Illinois (71.5 percent) and the United States (72.4 percent). The overall population in Morgan County is generally less racially and ethnically diverse (less than 10 percent non-white) than the general population of the state and far more homogeneous than the United States; therefore, a “minority population” as defined by CEQ does not exist in Morgan County. The percentage of minority individuals living in Census Tract 9514, in which the Meredosia Energy Center is located, is 1.5 percent (USCB 2010f). This is lower than the percentages in Morgan County, the state as a whole, and the United States (USCB 2010e).

As discussed in Chapter 2, the Meredosia Energy Center suspended operations at the end of 2011. The minority population distribution in the area is not expected to change as a result of the suspension of operations at the Meredosia Energy Center.

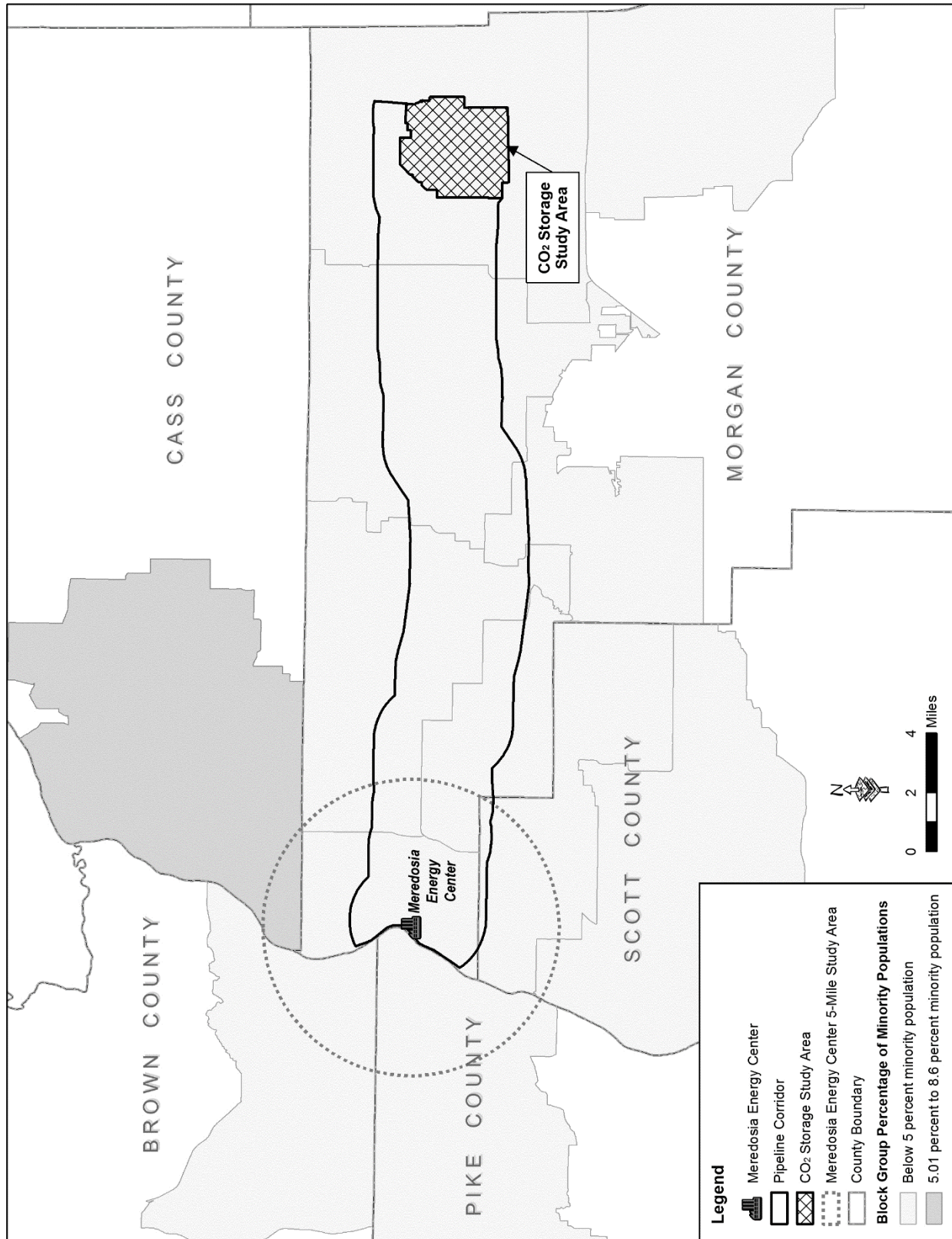

CO₂ = carbon dioxide

Figure 3.19-1. Minority Populations within the FutureGen 2.0 Project Area

Table 3.19-1. County, State, and National Population and Low-Income Distributions (2010)

Jurisdiction	Total Population	White (percent)	Black (percent)	American Indian/ Alaska Native (percent)	Asian (percent)	Native Hawaiian/ Pacific Islander (percent)	Hispanic or Latino (all races) (percent)	Low-income (2009 values) (percent)
Brown	6,937	76.1	18.5	0.2	0.0	0.6	5.8	15.9
Cass	13,642	86.3	3.1	0.3	0.3	Z	16.8	12.5
Morgan	35,547	90.9	6.0	0.2	0.5	Z	2.0	14.1
Pike	16,430	96.9	1.7	0.2	0.2	Z	1.0	17.1
Scott	5,355	98.6	0.2	0.2	0.2	0.0	0.8	10.4
Illinois	12,830,632	71.5	14.5	0.3	4.6	0.0	15.8	13.3
United States	308,745,538	72.4	12.6	0.9	4.8	0.2	16.3	14.3

Source: USCB 2010e

Note: Some of the minority population counted themselves as more than one ethnic background or as “other,” thus the counts do not add up to 100 percent.

Z = Denotes a value greater than zero but less than half unit of measure shown

Low-Income Populations

Table 3.19-1 compares the minority percentages and low-income percentages of all counties in the ROI with those of the state of Illinois and the United States in general. Figure 3.19-2 presents the low-income population distributions within the FutureGen 2.0 Project area. The percentage of low-income individuals within Morgan County (14.1 percent), in which the Meredosia Energy Center is located, is generally comparable to the percentage in the state (13.3 percent) and slightly lower than the United States (14.3 percent) percentage (see Table 3.19-1). The other counties within the ROI are comparable to Morgan County, with Brown and Pike counties having a slightly higher percentage of low-income individuals (15.9 percent and 17.1 percent, respectively) than Illinois and the United States; and Cass and Scott counties having a slightly lower percentage of low-income individuals (12.5 percent and 10.4 percent, respectively) than Illinois and the United States. The percentage of low-income individuals living in Census Tract 9514, in which the Meredosia Energy Center is located, is 12.6 percent. This is lower than the percentages in Morgan County, the state as a whole, and the United States (USCB 2010g).

There are no anticipated changes in low-income populations that would be attributable to the suspension of operations at the Meredosia Energy Center.

3.19.2.2 CO₂ Pipeline, CO₂ Storage Study Area, and Educational Facilities

Minority Populations

No “minority population” as defined by the CEQ exists within the proposed CO₂ pipeline corridor from the energy center to the CO₂ storage study area or within the CO₂ storage study area. The percentages of minorities within the block groups comprising the CO₂ pipeline corridor and within the storage study area are 2 percent and 2.1 percent, respectively, which are lower than the percentages in Morgan County.

Depending on the location selected for the educational facilities, minority populations may exist nearby; however, given the demographics of Morgan County (90.9 percent white), the presence of CEQ-defined minority populations is unlikely.

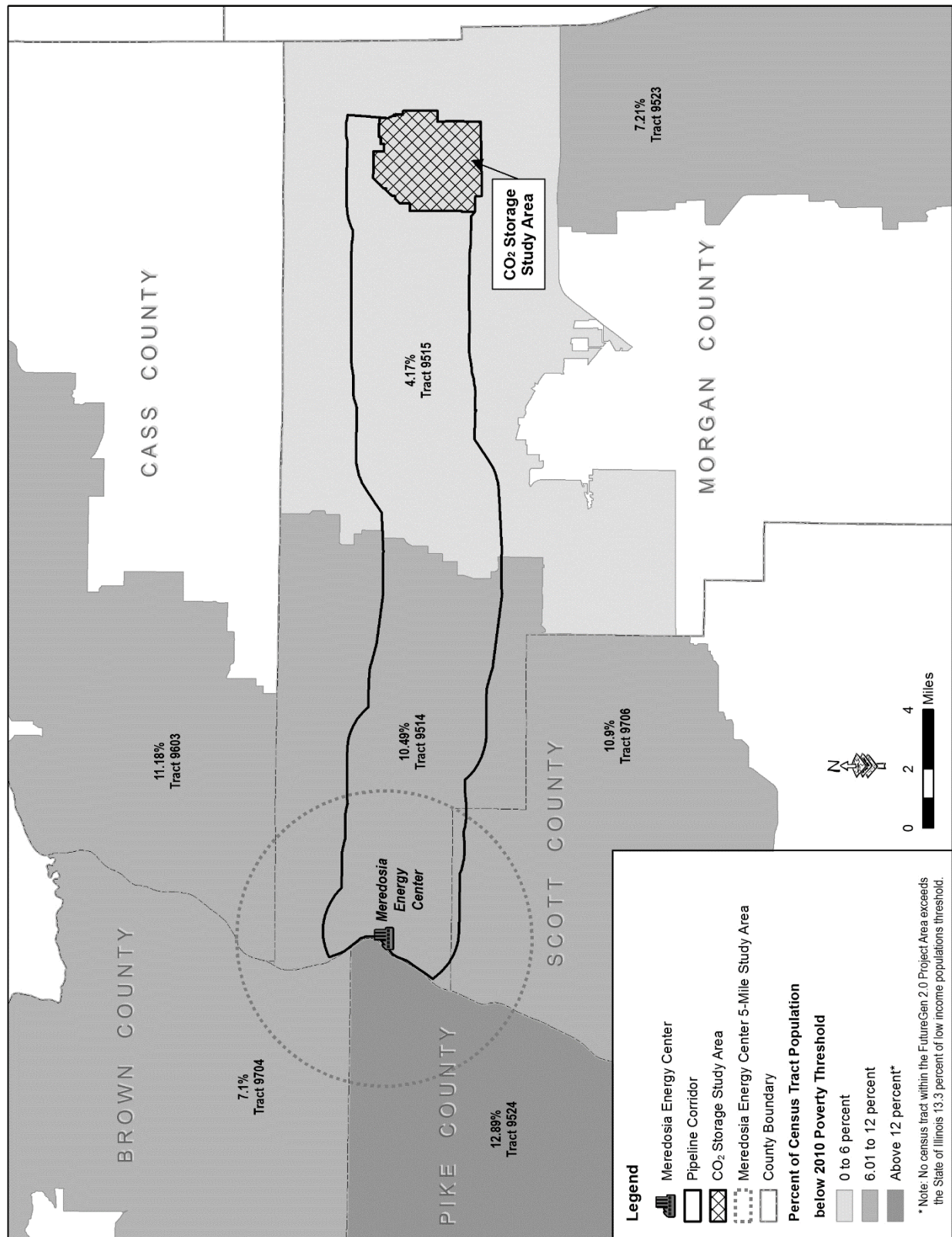

% = percent; CO₂ = carbon dioxide

Figure 3.19-2. Low-Income Populations within the FutureGen 2.0 Project Area

Low-Income Populations

The percentage of low-income individuals within Morgan County overall is 14.1 percent. This percentage is not substantially higher than the percentage in the state (13.3 percent) and is nearly the same as the percentage in the United States (14.3 percent) (see Table 3.19-1). The percentages of low-income individuals within the census tracts comprising the CO₂ pipeline corridor and storage study area are 8 percent and 4.2 percent, respectively. These are lower than the percentages for Morgan County, the state as a whole, and the United States (USCB 2010e). Depending on the location selected for the educational facilities, low-income populations may exist nearby.

3.19.3 Impacts of Proposed Action

3.19.3.1 Construction Impacts

Meredosia Energy Center

As discussed in Section 3.19.2.1, there are no areas of minority populations, as defined by EO 12898 and CEQ guidance, located within the ROI for the Meredosia Energy Center. Therefore, no disproportionately high and adverse impacts to minority populations are anticipated during construction for the proposed project.

No census tracts within the ROI have low-income populations that are proportionately greater than those of the general populations in Morgan County, surrounding counties, the state, and the United States; therefore, no disproportionately high and adverse impacts are anticipated to low-income populations. Construction impacts that may affect the local population, such as impacts to air quality, surface water, transportation, and noise, would be minor and temporary in nature (see Section 3.1, Air Quality; Section 3.6, Surface Water; Section 3.13, Traffic and Transportation; and Section 3.14, Noise and Vibration). Short-term beneficial impacts may include an increase in employment opportunities and potentially higher wages or supplemental income through jobs created during facility construction, as well as the opportunity for homeowners to rent rooms for temporary construction worker lodging (see Section 3.18, Socioeconomics).

Environmental justice impacts (or lack thereof) associated with the construction of the oxy-combustion facility at the Meredosia Energy Center would be the same when compared to both the historical baseline (prior operation of the energy center) and the projected baseline (post-suspension of operations at the energy center).

CO₂ Pipeline, CO₂ Storage Study Area, and Educational Facilities

As discussed in Section 3.19.2.2, there are no areas of minority populations, as defined by EO 12898 and CEQ guidance, located within the ROI for the CO₂ pipeline, the CO₂ storage study area, or the educational facilities. Therefore, no disproportionately high and adverse impacts to minority populations are anticipated.

The pipeline route could ultimately deviate slightly from the Alliance's proposed southern route as a result of final project design and continuing coordination with landowners; however, the same siting criteria would be followed and impacts would be consistent with those addressed in this section.

As discussed in Section 3.19.2.2, no census tracts within the ROI have low-income populations that are proportionately greater than those of the general populations in Morgan County, surrounding counties, the state, and the United States; therefore, no disproportionately high and adverse impacts are anticipated to low-income populations. Construction impacts that may affect the local population, such as impacts to air quality, surface water, transportation, and noise, would be minor and temporary in nature (see Section 3.1, Air Quality; Section 3.6, Surface Water; Section 3.13, Traffic and Transportation; and Section 3.14, Noise and Vibration). Short-term beneficial impacts may include an increase in employment opportunities and potentially higher wages or supplemental income through jobs created during facility construction, as well

as the opportunity for homeowners to rent rooms for temporary construction worker lodging (see Section 3.18, Socioeconomics).

3.19.3.2 Operational Impacts

Meredosia Energy Center

As described in Section 3.19.2.1, no areas of minority or low-income populations, as defined by EO 12898 and CEQ guidance, are located within the ROI for the Meredosia Energy Center. Aesthetics, transportation, noise, and socioeconomic impacts resulting from operations would not have a disproportionately high and adverse effect on minority and low-income populations (see Section 3.11, Aesthetics; Section 3.13, Traffic and Transportation; Section 3.14, Noise and Vibration; and Section 3.18, Socioeconomics).

The potential health risks from a pipeline rupture or puncture, or a catastrophic accident, terrorism, or sabotage are described in Section 3.17, Human Health and Safety. Census tracts and block groups in closest proximity to the Meredosia Energy Center would be most at risk in the event of a release resulting from an accident or intentional destructive act at the energy center. As described in Section 3.19.2.1, no minority or low-income populations exist in these census tracts and block groups at higher concentrations than in the general population. Therefore, no disproportionately high and adverse impacts to minority and low-income populations would be anticipated from an accident or intentional destructive act. A small, long-term, beneficial impact to low-income populations would be anticipated due to an increase in employment opportunities and potentially higher wage jobs associated with facility operation (see Section 3.18, Socioeconomics).

Environmental justice impacts (or lack thereof) associated with the operation of the Meredosia Energy Center are the same when compared to both the historical baseline and the projected baseline.

CO₂ Pipeline, CO₂ Storage Study Area, and Educational Facilities

As described in Section 3.19.2.2, no areas of minority or low-income populations, as defined by EO 12898 and CEQ guidance, are located within the ROI for the CO₂ pipeline, the CO₂ storage study area, or the educational facilities. Aesthetics, transportation, noise, and socioeconomic impacts resulting from operations would not have a disproportionately high and adverse effect on minority and low-income populations (see Section 3.11, Aesthetics; Section 3.13, Traffic and Transportation; Section 3.14, Noise and Vibration; and Section 3.18, Socioeconomics).

The potential health risks from a CO₂ pipeline rupture or puncture, or a catastrophic accident, terrorism, or sabotage involving the pipeline or CO₂ injection wells are described in Section 3.17, Human Health and Safety. Census tracts and block groups in closest proximity to the CO₂ storage study area and the associated CO₂ pipeline would be most at risk in the event of a release resulting from an accident or intentional destructive act along the pipeline or at the injection wells. As described in Section 3.19.2.2, no minority or low-income populations exist in these census tracts and block groups at higher concentrations than in the general population. Therefore, no disproportionately high and adverse impacts to minority and low-income populations would be anticipated from an accident or intentional destructive act.

Although the Alliance selected the southern route as the proposed route, it could ultimately deviate slightly as a result of final project design and coordination with landowners; however, the same siting criteria would be followed and impacts would be consistent with those addressed in this section. In addition, since the publication of the Draft EIS, the Alliance identified a proposed property for the injection well site (see Section 2.5.2.1). The proposed site is located within the CO₂ storage study area, and DOE believes that the analysis of impacts presented in the Draft EIS remains valid.

A small, long-term, beneficial impact to low-income populations would be anticipated due to an increase in employment opportunities and potentially higher wage jobs associated with the project operations.

3.19.4 Impacts of the No Action Alternative

Under the no action alternative, DOE would not provide cost-shared funding for the proposed FutureGen 2.0 Project. Although the Alliance may still elect to construct and operate the project in the absence of DOE cost-shared funding, for the purposes of the analysis in this EIS, DOE assumed the no action alternative is equivalent to the no-build alternative. Therefore, the project would not be constructed and there would be no adverse impact to environmental justice populations. In addition, the no action alternative would not provide the potential beneficial economic impacts associated with the proposed project.

4 SUMMARY OF ENVIRONMENTAL CONSEQUENCES

This chapter contains the following sections:

- Section 4.1, Comparative Impacts of Alternatives
- Section 4.2, Measures to Mitigate Adverse Impacts
- Section 4.3, Potential Cumulative Impacts
- Section 4.4, Incomplete and Unavailable Information
- Section 4.5, Irreversible and Irrecoverable Commitments
- Section 4.6, Relationship between Short-Term Uses of the Environment and Long-Term Productivity

4.1 COMPARATIVE IMPACTS OF ALTERNATIVES

As described in Chapter 2, the FutureGen 2.0 Project considers two alternatives: the no action alternative and the proposed action. Under the no action alternative, DOE would not provide cost-shared funding for the FutureGen 2.0 Project. Although the Alliance may still elect to construct and operate the project in the absence of DOE cost-shared funding, for the purposes of the analysis in the EIS, DOE assumed that the no action alternative is equivalent to a no-build alternative. The proposed project consists of the Oxy-Combustion Large Scale Test and the CO₂ Pipeline and Storage Reservoir as described in Section 2.5.

DOE evaluated the potential impacts of the no action alternative and the proposed action in relation to the baseline conditions. Detailed discussion of baseline conditions and potential impacts are provided in Chapter 3. Table 4.1-1 summarizes the potential impacts for each of the 19 resource areas for the no action alternative and for the proposed action.

The EIS uses the following descriptors to qualitatively characterize impacts on respective resources:

- **Beneficial** – The impacts would benefit the resource.
- **Negligible** – No apparent or measurable impacts are expected; may also be described as “none” if appropriate.
- **Minor** – The action would have a barely noticeable or measurable adverse impact on the resource.
- **Moderate** – The action would have a noticeable or measurable adverse impact on the resource. This category could include potentially significant impacts that would be reduced to a lesser degree by the implementation of mitigation measures.
- **Substantial** – The action would have obvious and extensive adverse effects that could result in potentially significant impacts on a resource despite mitigation measures.

Table 4.1-1. Summary of Environmental Impacts by Alternative for the FutureGen 2.0 Project

Criteria Considered	No Action	Proposed Project
Air Quality		
<p>Impacts were assessed based on whether the proposed project would:</p> <ul style="list-style-type: none"> Result in emissions of criteria pollutants or hazardous air pollutants that would exceed relevant air quality or health standards; Cause an adverse change in air quality related to the National Ambient Air Quality Standards or Illinois standards; Violate any federal or state permits; Affect visibility and regional haze in Class I areas; or Conflict with local or regional air quality management plans to attain or maintain compliance with the federal and state air quality regulations. 	<p>No Impacts.</p> <p>Baseline conditions would not change.</p>	<p>Construction: <i>Minor Adverse Impacts:</i> Construction of the proposed FutureGen 2.0 Project would result in short-term, minor, localized increased tailpipe and fugitive dust emissions. Because the proposed project would occur in an area listed as either in "attainment" or "unclassified" for all criteria pollutants, Clean Air Act conformity requirements are not applicable and thus there are no emissions thresholds that pertain to the construction phase of this project. Emissions would be concentrated at the construction sites and would steadily decrease with distance.</p> <p>Operations: <i>Minor Adverse Impacts:</i> Normal operations of the oxy-combustion facility would cause increases in air emissions over current conditions. Air emissions generated by operations of the project would not exceed relevant air quality standards when analyzed as an isolated project or when cumulatively combined with applicable regional sources. During normal operations, the gas quality control system would incorporate state-of-the-art flue gas scrubbing technology to minimize pollutant emissions from the stack. <i>Beneficial impacts</i> could result from overall lower emissions, as electricity generated by this project may displace electricity generated by traditional coal-fired power plants that emit significantly higher levels of pollutants.</p>
Climate and Greenhouse Gases		
<p>Impacts were assessed based on whether the proposed project would:</p> <ul style="list-style-type: none"> Cause an increase (or decrease) in GHG emissions of 75,000 tons per year (68,250 metric tons per year) CO₂-equivalent or more; or Threaten to violate federal, state, or local laws or requirements regarding GHG emissions. 	<p>No Direct Impacts.</p> <p>Indirect Adverse Impacts related to not furthering commercial-scale advanced oxy-combustion coal-based power generation technologies with CO₂ capture and sequestration.</p> <p>Further, without the project, regional electricity needs would likely be met by conventional coal- or natural gas-based electric power generation. Therefore,</p>	<p>Construction: <i>Minor Adverse Impacts:</i> Construction of the proposed FutureGen 2.0 Project would generate approximately 48,009 tons (43,688 metric tons) of CO₂ emissions over the multi-year construction period.</p> <p>Operations: <i>Beneficial Impacts:</i> The capture and geological storage of GHG emissions by the project would produce a beneficial cumulative effect on a national and global scale. Operation of the project components would result in up to approximately 169,701 tons per year (154,283 metric tons per year) of new CO₂ emissions (net after CO₂ capture and storage). The proposed project would capture and sequester approximately 1.2 million tons per year (1.1 million metric tons per year) of CO₂ emissions from the generation of 168 MWe (gross) electric power, which would generate approximately 90 percent lower GHG emissions compared to a similarly sized conventional coal-fired power plant, or approximately 70 percent lower compared to a natural-gas fired power plant. On September 20, 2013, the USEPA proposed a CO₂ emissions standard for new coal-based power plants that could require emissions to be as low as 1,000 pounds CO₂/MWh gross. The proposed oxy-combustion facility would emit approximately 295 pounds CO₂/MWh gross and would therefore meet this requirement if it were to be finalized. The reduction in CO₂ emissions resulting from the project would incrementally reduce the rate of GHG accumulation in the atmosphere and help to incrementally mitigate climate change related to atmospheric concentrations of GHGs. On a broader scale, successful implementation of the project may lead to widespread acceptance and deployment of oxy-combustion technology with geologic storage of CO₂, thus fostering a long-term</p>

Table 4.1-1. Summary of Environmental Impacts by Alternative for the FutureGen 2.0 Project

Criteria Considered	No Action	Proposed Project
Climate and Greenhouse Gases (continued)		
	regional GHG emissions would likely be greater in the absence of the proposed project.	reduction in the rate of CO ₂ emissions from power plants across the United States. Further, the project would demonstrate a path forward for future coal-powered generation facilities in light of more stringent standards, such as those proposed by the USEPA.
Physiography and Soils		
Impacts were assessed based upon whether the proposed project would: <ul style="list-style-type: none"> Result in permanent or temporary soil removal; Cause the permanent loss of prime farmland soil or farmland of statewide importance (through conversion to nonagricultural uses); Result in significant soil erosion; Cause soil contamination due to spills of hazardous materials; or Change soil characteristics and composition. 	No Impacts. Baseline conditions would not change.	Construction: <i>Minor Adverse Impacts:</i> Construction of the proposed FutureGen 2.0 Project would increase the potential for soil erosion and compaction, increase the amount of impermeable surfaces, and withdraw some prime farmland soils from agricultural production. Overall construction for the proposed project would disturb up to a maximum of 364 acres of soil classified as prime farmland. However, with the identification of the proposed injection well site as addressed in this Final EIS, the permanent loss of prime farmland would be approximately 14 acres (4 percent) for all associated facilities, as compared to less than 25 acres (7 percent) based on the original concept for the injection well facilities. All other prime farmland in the pipeline route could be restored to preconstruction use. Based on the revised site plan, construction at the Meredosia Energy Center would disturb up to a maximum of 95 acres of soils classified as farmland of statewide importance (of which 54 acres would be permanently converted for project use), as compared to 146 acres reported in the Draft EIS (79 acres permanently converted). However, these soils at the energy center are not currently used for agricultural purposes and likely are no longer suitable for agricultural use. Also, construction would affect 16 acres of Urban soils and 2 acres of hydric soils at the energy center. Operations: <i>Minor Adverse Impacts:</i> Based on the revised site layout, approximately 54 acres of soils classified as farmland of statewide importance would be permanently converted to uses for the Meredosia Energy Center (compared to 79 acres for the original layout). Also, approximately 14 acres of prime farmland soils would be permanently converted to project uses at the proposed injection well site (compared to less than 25 acres for the original injection well concept). DOE anticipates that the property above the CO ₂ pipeline would be returned to agricultural use after the construction period ends.
Geology		
Impacts were assessed based on whether the proposed project would: <ul style="list-style-type: none"> Cause or be damaged by geologic-related events (e.g., earthquake, landslides, sinkholes); 	No Impacts. Baseline conditions would not change; the stratigraphic well would be closed.	Construction: <i>Minor Adverse Impacts:</i> Construction at the Meredosia Energy Center and CO ₂ pipeline may require excavation of glacial materials. Construction of the injection wells would result in removal of geologic media through the drilling process. This process would not be unique to the area and would not affect the availability of local geologic resources.

Table 4.1-1. Summary of Environmental Impacts by Alternative for the FutureGen 2.0 Project

COMPARATIVE IMPACTS OF ALTERNATIVES

Criteria Considered	No Action	Proposed Project
Geology (continued)		
<ul style="list-style-type: none"> Reduce the value of mineral or petroleum resources or unique geologic formations, or render them inaccessible; Alter unique geologic formations resulting in the migration of geologically stored CO₂ through faults, compromised caprock, or other pathways such as abandoned or unplugged wells; Cause visible ground heave or upward vertical displacement of the ground surface; or Affect human exposure to radon gas. 		<p>Operations: <i>Minor Adverse Impacts:</i> Operation of the oxy-combustion facility and CO₂ pipeline would not affect geologic resources. At the injection wells, the potential of CO₂ migrating out of the injection zone is considered highly unlikely. Computer modeling conducted by the Alliance for their proposed injection well configuration of four horizontal wells installed at one injection well site predicted that the CO₂ plume would expand to encompass an area of approximately 4,000 acres within the CO₂ storage study area over the 20-year injection period. During injection, the Alliance would monitor the formation pressure to ensure that injection-induced seismicity would not occur. The Alliance would also follow a USEPA-approved MVA plan, and conduct extensive studies and monitoring to minimize this potential long-term impact. As required by the UIC permits, appropriate mitigation strategies would be implemented should such CO₂ migration be identified.</p>
Groundwater		
<p>Impacts were assessed based on whether the proposed project would:</p> <ul style="list-style-type: none"> Deplete groundwater supplies on a scale that would affect available capacity of a groundwater source for use by existing water rights holders, or interfere with groundwater recharge; Conflict with established water rights, allocations, or regulations protecting groundwater for future beneficial uses; Contaminate shallow aquifers due to chemical spills, well drilling or well completion failures; Conflict with regional or local aquifer management plans or the goals of governmental water authorities; or Contaminate USDWs through acidification of an aquifer due to migration of CO₂ or toxic metal dissolution and mobilization, displacement of naturally occurring 	<p>No Impacts. Baseline conditions would not change.</p>	<p>Construction: <i>Negligible Impacts:</i> Construction at the Meredosia Energy Center and pipeline corridor would not include onsite discharges to groundwater and would follow the updated National Pollutant Discharge Elimination System permit and Spill Prevention, Control, and Countermeasure plans to minimize any potential for groundwater contamination. Construction of the injection wells would follow the construction plan in the UIC permits so that local groundwater aquifers would not be impacted from drilling.</p> <p>Operations: <i>Minor Adverse Impacts:</i> Operation of the Meredosia Energy Center would withdraw approximately 124,000 gallons of groundwater per day from three onsite groundwater wells, which is less than the historical use at the energy center site (between 212,000 and 982,000 gpd), and less than 4 percent of the historical use by the industrial plants in the Meredosia area. The potential for groundwater contamination would be minimized during operations by implementing a Spill Prevention, Control, and Countermeasure Plan and implementing the procedures in the National Pollutant Discharge Elimination System permit. Operation of the pipeline would have negligible impacts as it would not be expected to affect groundwater. At the injection wells, the potential for CO₂ migration upward through fractures in the caprock seal is considered highly unlikely, and extensive vertical movement into drinking water aquifers would not be expected. As part of the UIC permit applications (submitted in early 2013), the Alliance provided an MVA plan, which presents the procedures that the Alliance would use to monitor and contain the CO₂ within the injection zone.</p>

4.1-4

DOE/EIS-0460
FINAL ENVIRONMENTAL IMPACT STATEMENT

FUTUREGEN 2.0 PROJECT
SUMMARY OF ENVIRONMENTAL CONSEQUENCES

Table 4.1-1. Summary of Environmental Impacts by Alternative for the FutureGen 2.0 Project

Criteria Considered	No Action	Proposed Project
Groundwater (continued)		
brine (saline groundwater) due to CO ₂ injection, or chemical spills, well drilling, well development, or well failures.		
Surface Water		
<p>Impacts were assessed based on whether the proposed project would:</p> <ul style="list-style-type: none"> • Alter stormwater discharges, which could adversely affect drainage patterns, flooding, erosion, and sedimentation; • Alter or damage existing farmland drainage infrastructure; • Alter infiltration rates, which could affect (substantially increase or decrease) the volume of surface water that flows downstream; • Conflict with applicable stormwater management plans or ordinances; • Violate any federal, state, or regional water quality standards or discharge limitations; • Modify surface waters such that water quality no longer meets water quality criteria or standards established in accordance with the Clean Water Act, state regulations, or permits; or • Change the availability of surface water resources for current or future uses. 	<p>No Impacts.</p> <p>Baseline conditions would not change.</p>	<p>Construction: <i>Minor Adverse Impacts:</i> Construction of the oxy-combustion facility and barge unloading facility has the potential to increase sedimentation in the Illinois River and increase the potential for surface water contamination from material spills. Although the Alliance's current plans for unloading equipment would avoid potential impacts to the bank or bottom of the Illinois River, the EIS maintains the options evaluated in the Draft EIS as representing appropriate upper bounds for the barge unloading operations during construction of the oxy-combustion facility. If the Alliance undertakes activities related to the barge unloading facility that would disturb the river bottom, then water quality could be reduced by increased turbidity and sedimentation during streambed disturbance. While all perennial streams and the majority of intermittent streams would be avoided using trenchless technologies for pipeline construction, trenching could occur during pipeline construction at certain ephemeral and intermittent streams that are seasonally-dry at the time of construction. However, these features would be restored to pre-construction conditions after construction activities were completed. Construction of the injection well site(s) could increase the potential for contamination from material spills.</p> <p>Operations: <i>Minor Adverse Impacts:</i> Based on refinements in design since publication of the Draft EIS, the project would withdraw an estimated 13.6 mgd from the Illinois River for oxy-combustion facility operations and discharge 10.6 mgd of treated effluents (representing increases from the estimated 11.4 mgd withdrawal and 9 mgd discharge analyzed in the Draft EIS for the original design). However, the surface water withdrawals and discharges for operations would be approximately 94 percent less than the average 217 mgd withdrawal and 189 mgd discharge during historical operations at the energy center. There would be no operational impacts associated with the barge area, as this area would be returned to pre-existing conditions after construction activities at the Meredosia Energy Center were completed. The proposed project would increase the potential for stormwater runoff due to increased impervious area at the proposed oxy-combustion facility site and would increase the potential for contamination from material spills. Operation of the pipeline and injection well site(s) would not affect surface water, other than increasing the potential of material spills during maintenance.</p>

Table 4.1-1. Summary of Environmental Impacts by Alternative for the FutureGen 2.0 Project

Criteria Considered	No Action	Proposed Project
Wetlands and Floodplains		
<p>Impacts were assessed based on whether the proposed project would:</p> <ul style="list-style-type: none"> • Cause filling of wetlands or otherwise alter drainage patterns that would affect wetlands; • Cause wetland type or classification conversions due to alterations of land cover attributes; • Alter a floodway or floodplain or otherwise impede or redirect flows such that human health, the environment, or personal property could be affected; • Conflict with applicable flood management plans or ordinances; or • Conflict with the Federal Emergency Management Agency's national standard for floodplain management (i.e., maximum allowable increase of water surface elevation of 1 foot for a 1 percent annual chance [100-year recurrence interval] flood event). 	<p>No Impacts.</p> <p>Baseline conditions would not change.</p>	<p>Construction: <i>Negligible to Minor Adverse Impacts:</i> No impacts to wetlands would occur at the Meredosia Energy Center as a result of the proposed project. Although the Alliance's current plans for unloading equipment would avoid potential impacts to the bank or bottom of the Illinois River, the EIS maintains the options evaluated in the Draft EIS as representing appropriate upper bounds for the barge unloading operations during construction of the oxy-combustion facility. If the Alliance undertakes activities related to the proposed barge unloading facility that would disturb the river bottom, then temporary impacts would occur resulting in potential increased sedimentation of the Illinois River.</p> <p>For the CO₂ pipeline, the southern route operational ROW contains no NWI-mapped wetlands, but may contain up to 0.5 acre of freshwater wetlands based on a wetland delineation performed by the Alliance in spring 2013; the northern route, which is no longer being considered by the Alliance, contains 0.2 acre of NWI-mapped open water wetlands. While all wetlands, perennial streams, and the majority of intermittent streams would be avoided using trenchless technologies, trenching could occur during pipeline construction at certain ephemeral and intermittent streams which are seasonally-dry at the time of construction. Construction of the pipeline at these locations, which although dry may still be considered USACE-jurisdictional features, would cause temporary disturbance of the dry stream channel bed and would be restored after construction activities were completed. In addition to the above, the wetland delineation conducted by the Alliance also identified a 0.03-acre area of hydric soils located in an active agricultural field within the southern pipeline route that would be crossed using traditional trenching. Although this feature possesses the characteristics of a wetland, it is not expected to be considered jurisdictional by the USACE. No impacts to wetlands are anticipated at the CO₂ injection well site(s).</p> <p>Construction within the 100-year floodplain would primarily occur only in areas that are currently developed at the Meredosia Energy Center; therefore, additional impacts are not expected. If the Alliance undertakes activities related to the proposed barge unloading facility as analyzed in the Draft EIS, temporary placement of facilities within the 100-year floodplain would occur during construction, and the area would be returned to pre-construction conditions after construction activities are completed. Construction of the CO₂ pipeline would cross 100-year floodplains and may result in small ancillary structures being placed in the 100-year floodplain, resulting in minor impacts. Construction at the CO₂ injection well site(s) is not anticipated to impact floodplains; as per the siting criteria, these areas would be avoided.</p> <p>Operations: <i>Negligible to Minor Adverse Impacts:</i> There would be no operational impacts to wetlands as maintenance of the ROW (e.g., mowing or vegetation clearing) would not occur within wetland areas. Mainline block valves would be placed on either side of streams and other wetland features, as needed.</p>

Table 4.1-1. Summary of Environmental Impacts by Alternative for the FutureGen 2.0 Project

Criteria Considered	No Action	Proposed Project
Biological Resources		
<p>Impacts were assessed based on whether the proposed project would:</p> <ul style="list-style-type: none"> • Cause displacement of terrestrial or aquatic communities or loss of habitat; • Diminish the value of habitat for wildlife or plants; • Cause a decline in native wildlife populations; • Interfere with the movement of native resident or migratory wildlife species; • Conflict with applicable management plans for terrestrial, avian, and aquatic species and their habitat; • Cause the introduction of noxious or invasive plant species; • Diminish the value of habitat for fish species (including altering drainage patterns causing displacement of fish species or interfering with movement of native resident fish species); • Cause a decline in native fish populations; • Adversely affect endangered, threatened, or other special status species; or • Cause adverse modification to designated critical habitat of a federally-listed species. 	<p>No Impacts.</p> <p>Baseline conditions would not change.</p>	<p>Construction: <i>Minor to Moderate Adverse Impacts:</i> The Alliance originally anticipated the need to clear approximately 33 acres of forested area at the energy center and 8 acres for the southern pipeline route. However, through ongoing refinements in the site plan at the energy center and the use of trenchless boring techniques during pipeline construction, the Alliance expects to reduce the amount of forested area cleared to a maximum of 9 acres at the energy center and 6 acres for construction of the southern pipeline route.</p> <p>Although the Alliance's current plans for unloading equipment at the energy center would avoid potential impacts to the bank or bottom of the Illinois River, the Final EIS maintains the options evaluated in the Draft EIS as representing appropriate upper bounds for the barge unloading operations during construction of the oxy-combustion facility. If the Alliance undertakes the barge unloading activities analyzed in the Draft EIS, there could be a disturbance to riverbed sediments and a release of buried contaminants, including polychlorinated biphenyls and mercury. This release could have an adverse impact on local and downstream aquatic resources, including protected species.</p> <p>DOE is preparing a Biological Assessment addressing the three federally-listed species for which suitable habitat occurs in the project area: the Indiana bat, decurrent false aster, and eastern prairie fringed orchid. Indiana bat habitat surveys were completed in spring-summer 2013 at the energy center and southern pipeline route. Decurrent false aster surveys were conducted during flowering in late summer 2013 where potential habitat was identified in the project area. Initial surveys for the eastern prairie fringed orchid determined that the soil types are unsuitable and no individuals were found. Based on the progress of the Biological Assessment, DOE believes that the proposed action is not likely to adversely affect any of the listed species. The Biological Assessment, when submitted, will provide DOE's final determination and will identify measures as appropriate to minimize impacts on federally-listed species. Forested areas along the pipeline and at the energy center would be cleared between September and February to avoid disturbing the Indiana bat and migratory birds.</p> <p>Operations: <i>Minor Adverse Impacts:</i> During operation, the 50-foot wide CO₂ pipeline operational ROW would be kept free of woody vegetation to permit access for inspection and maintenance activities. This would leave the vegetation in the operational ROW in a persistent herbaceous state, creating a permanent habitat conversion in areas that were previously forested. Clearing of forested areas would cause a small degree of habitat fragmentation. In total, the proposed southern route as refined after release of the Draft EIS would result in the loss of up to 6 acres of forested lands (compared to 8 acres in the original layout). The northern CO₂ pipeline route, which is no longer being considered by the Alliance, would result in the loss of up to 22 acres of forested lands. Due to the comparatively small areas of</p>

Table 4.1-1. Summary of Environmental Impacts by Alternative for the FutureGen 2.0 Project

Criteria Considered	No Action	Proposed Project
Biological Resources (continued)		
		forest to be permanently converted, these potential fragmentation effects would be minor.
Cultural Resources		
<p>Impacts were assessed based on whether the proposed project would cause the loss, isolation, or alteration of:</p> <ul style="list-style-type: none"> Archaeological resources listed or eligible for the National Register of Historic Places (NRHP) listing; Historic sites or structures listed or eligible for NRHP listing, either directly or by introducing visual, audible, or atmospheric elements that would adversely affect the historic resource; Native American resources, including graves, remains, and funerary objects, either directly or by introducing visual, audible, or atmospheric elements that would adversely affect the resource's use; Paleontological resources listed or eligible for listing as a National Natural Landmark; or Cemeteries. 	<p>No Impacts. Baseline conditions would not change.</p>	<p>Construction: <i>Negligible Adverse Impacts:</i> DOE has not identified any cultural resources that would be impacted by the project. However, any potential impacts to cultural resources would be avoided or mitigated in accordance with a Programmatic Agreement between the DOE, the Alliance, and the SHPO. The proposed injection well site identified after publication of the Draft EIS would require demolition of a single, abandoned dwelling that was constructed between 1959 and 1963. This structure is not unique in the region and appears to lack the necessary degree of architectural merit or historical relevance to be considered as potentially eligible for listing on the National Register of Historic Places. In addition, other historic resources within the applicable area of potential effects would not be expected to incur any apparent or measurable impacts as the project would not be expected to alter the setting or other aspects of integrity of these resources. The project would not introduce visual, atmospheric, or audible elements that diminish the integrity of the resource's significant historic features.</p> <p>Operations: <i>No Impacts:</i> Operation of the proposed project would not be expected to have an adverse impact on cultural resources.</p>
Land Use		
<p>Impacts were assessed based on whether the proposed project would:</p> <ul style="list-style-type: none"> Be incompatible with land use adjacent to the Meredosia Energy Center and within and adjacent to the CO₂ pipeline corridor, CO₂ storage study area, and associated components and facilities; Result in land use restrictions on adjacent properties; or 	<p>No Impacts. Baseline conditions would not change.</p>	<p>Construction: <i>Minor Adverse Impacts:</i> Since there are no applicable zoning and land use plans in unincorporated Morgan County, construction of the proposed project would not conflict with any designated county zoning plans. The educational facilities in the city of Jacksonville would be designed to abide by the existing zoning and comprehensive plan.</p> <p>The Meredosia Energy Center property offers sufficient infrastructure to support most of the construction activities required for the oxy-combustion facility. Additional land area outside of the energy center would be used for construction staging and equipment laydown, but that land area would only be temporarily impacted as it would revert back to its original condition after construction. Impacts due to construction of the CO₂ pipeline and injection well site(s) would be negligible to minor. Short-term impacts</p>

Table 4.1-1. Summary of Environmental Impacts by Alternative for the FutureGen 2.0 Project

Criteria Considered	No Action	Proposed Project
Land Use (continued)		
<ul style="list-style-type: none"> Conflict with regional or local land use plans and zoning. 		<p>would result from temporarily restricting access and disrupting the ability to use the land for existing purposes (e.g., agricultural crops); land would be returned to its original condition after construction to the extent practicable. Long-term impacts would occur in areas that require conversion of land, such as vegetated land, for the pipeline ROW and for the CO₂ injection well site(s). Construction of the educational facilities in the city of Jacksonville would have negligible impacts since the Alliance would follow stipulations of the Jacksonville Zoning Ordinance.</p> <p>Operations: <u>Negligible Adverse Impacts:</u> Operation of the oxy-combustion facility would not conflict with any designated county zoning plans. Additionally, operation of the oxy-combustion facility would be compatible with the developed, industrial land use within and adjacent to the Meredosia Energy Center; therefore, impacts would be negligible. Impacts due to operation of the CO₂ pipeline and injection well site(s) would be negligible to minor. Most of the land along the pipeline is agricultural and would continue to be used for agricultural purposes during operations. Operation of the injection well site(s) would result in minor impacts associated with permanently removing less than 25 acres of mostly agricultural land from existing use. To the extent practicable, the Alliance would avoid net reductions in agricultural land. To replace acreages of land potentially removed from agricultural use due to the project, the Alliance would designate land that is currently not farmed as agricultural land. Land potentially placed into new agricultural use would be in the immediate vicinity of land taken out of agricultural use. Operation of the educational facilities in the city of Jacksonville would have negligible impacts since the Alliance would follow stipulations of the Jacksonville Zoning Ordinance.</p>
Aesthetics		
<p>Impacts were assessed based on whether the proposed project would:</p> <ul style="list-style-type: none"> Block or degrade a scenic vista or viewshed; Degrade or diminish a federal, state, or local scenic resource; Change the area's visual resources; Create glare or illumination that would be obtrusive or incompatible with existing land use; or Create visual intrusions or visual contrasts affecting the quality of a landscape. 	<p>No Impacts.</p> <p>Baseline conditions would not change.</p>	<p>Construction: <u>Minor to Moderate Adverse Impacts:</u> Construction of the proposed FutureGen 2.0 Project would result in temporary minor adverse impacts from increased visibility of construction activities to nearby sensitive receptors, as well as from fugitive dust, transportation, and noise. Temporary moderate impacts would occur as a result of the lighting required to support well drilling on a 24-hour per day basis.</p> <p>Operations: <u>Minor Adverse Impacts:</u> Operations of the project would result in minor impacts to aesthetics from the introduction of new buildings to the viewshed, including a 450-foot stack and associated steam plume. Minor impacts would occur to the viewshed from new utility lines constructed to the injection well site(s), placement of pipeline markers along the CO₂ pipeline, and from the introduction of the new surface facilities at the injection well site(s). Additional minor impacts would occur from the permanent conversion of natural areas (i.e., forests or grasslands) to typically revegetated grass in the areas of the pipeline ROW and injection well site(s). Periodic vegetation clearing and other maintenance activities would also result in negligible impacts.</p>

Table 4.1-1. Summary of Environmental Impacts by Alternative for the FutureGen 2.0 Project

Criteria Considered	No Action	Proposed Project
Materials and Waste Management		
<p>Impacts were assessed based on whether the proposed project would:</p> <ul style="list-style-type: none"> • Cause new sources of construction materials and operational supplies to be developed, such as new mining areas, processing plants, or fabrication plants; • Affect the capacity of existing material suppliers and industries in the region; • Create wastes for which there are no commercially available disposal or treatment technologies; • Create the need for a hazardous waste treatment, storage, or disposal permit for the project; • Affect the capacity of waste collection services, and treatment, storage, and disposal facilities; • Create reasonably foreseeable conditions that would increase the risk of a hazardous waste release; or • Create reasonably foreseeable conditions that would increase the risk of a hazardous material release. 	<p>No Impacts. Baseline conditions would not change.</p>	<p>Construction: <i>Negligible Adverse Impacts:</i> Construction of the proposed FutureGen 2.0 Project would require the use of structural and other materials in quantities that would have negligible impact on local or regional supplies. Generation of construction wastes would be minimized through material management practices such as spill prevention for petroleum products and segregation of recyclable materials. Adequate disposal capacity exists in the region to handle any construction wastes that would be generated.</p> <p>Operations: <i>Minor to Moderate Adverse Impacts:</i> Based on the Alliance's refinements to the design since publication of the Draft EIS, project operation would require the following materials in larger quantities compared to the quantities analyzed in the Draft EIS: coal (approximately 745,000 tons per year, compared to 700,000 in the Draft EIS), hydrated lime (approximately 68,200 tons per year, compared to 43,000 in the Draft EIS), and trona (approximately 3,200 tons per year, compared to 800 in the Draft EIS). These and other materials required to operate the proposed project are widely available; their use in the project would not have a noticeable impact on local and regional supplies. The largest waste streams from operation of the project would consist of fly ash (approximately 200,000 tons per year) and bottom ash (approximately 14,000 tons per year, compared to 12,000 in the Draft EIS). The Meredosia Energy Center would attempt to sell fly ash by-product to local and regional businesses. Bottom ash, and any fly ash that is not beneficially reused, would be disposed of in permitted landfills. Disposal of these waste streams could have minor to moderate impact on local and regional disposal capacity.</p> <p>The project also has the potential to generate hazardous waste and non-hazardous municipal solid wastes from the oxy-combustion facility, CO₂ pipeline, injection well site(s), and educational facilities. These wastes would be collected and transported offsite for disposal in accordance with applicable regulations, and the amounts and types of waste generated would not substantially affect local and regional treatment and disposal capacity.</p>
Traffic and Transportation		
<p>Impacts were assessed based on whether the proposed project would:</p> <ul style="list-style-type: none"> • Substantially increase daily vehicular traffic on key roadway segments and thereby degrade the level of service to exceed traffic-handling capacity; • Substantially increase daily barge traffic on the Illinois River to exceed capacity and interfere with other users; or 	<p>No Impacts. Baseline conditions would not change.</p>	<p>Construction: <i>Minor Adverse Impacts:</i> Construction of the proposed FutureGen 2.0 Project would cause temporary and localized congestion, particularly on roadways close to the Meredosia Energy Center, and to a lesser extent, on roadways close to the other construction sites. However, construction would be temporary, and all roadways in the ROI have the capacity to accommodate traffic increases associated with the construction of all components of the proposed project without substantially degrading the level of service. Limited adverse effects due to additional barge traffic and offloading would be expected.</p>

Table 4.1-1. Summary of Environmental Impacts by Alternative for the FutureGen 2.0 Project

Criteria Considered	No Action	Proposed Project
Traffic and Transportation (continued)		
<ul style="list-style-type: none"> Conflict with regional or local transportation improvement plans. 		<p>Operations: <i>Minor Adverse Impacts:</i> Operation of the proposed FutureGen 2.0 Project would have long-term minor adverse effects on transportation resources resulting from increased vehicle and truck traffic. Operation would cause long-term but localized congestion, particularly on roadways close to the Meredosia Energy Center. The level of service would not change on any roadways during operations, when compared to a no-build scenario.</p> <p>Current design anticipates that Powder River Basin coal would be the only material delivered by barge, which would require approximately 180 barge trips per year. However, alternatively, the Alliance may decide to have the Illinois bituminous coal (IL No.6) and the Powder River Basin coal blended offsite at a commercial coal-handling facility. In that case the entire volume would be delivered by barge, amounting to approximately 451 barge deliveries per year to transport coal to the energy center (1 to 2 barge deliveries on a daily basis). Historically, the number of annual barge deliveries ranged between 140 and 500 over the past several years. Therefore, waterway capacity would be sufficient for the operation of the barges, and impacts are expected to be negligible. Potential deliveries of blended coal by barge would replace daily deliveries by truck.</p>
Noise		
<p>Impacts were assessed based on whether the proposed project would:</p> <ul style="list-style-type: none"> Conflict with any state or local noise ordinances; Cause perceptible increases in ambient noise levels at sensitive receptors during construction—from either mobile or stationary sources; Cause long-term perceptible increases in ambient noise levels at sensitive receptors during operations—from either mobile or stationary sources; or Cause excessive ground-borne vibration to persons or property. 	<p>No Impacts. Baseline conditions would not change.</p>	<p>Construction: <i>Minor to Moderate Adverse Impacts:</i> Construction noises at the Meredosia Energy Center could have a minor to moderate impact on the few nearest residences; however, due to the nature of construction, the noise would be intermittent and temporary until the construction phase is over.</p> <p>Construction of the pipeline would result in minor to moderate, short-term, and intermittent increases in noise and vibrations at receptors near the pipeline ROW due to construction equipment activity and increased truck traffic. Not accounting for natural attenuation, receptors at distances greater than approximately 830 feet during typical pipeline construction, or approximately 2,330 feet during trenchless boring activities, would hear the construction noise at levels below 65 dBA, which is the limit deemed as normally acceptable to residential receptors. At the injection well site(s), the primary sources of noise during construction would be from drilling the wells and construction of the supporting facilities. The drilling of the injection wells would occur over a continuous, 24-hour duration, 7 days per week, for approximately 100 days per well, and because of the duration, would be the dominant noise source. The Alliance would construct earthen noise berms around the well pad to mitigate the noise impact to the nearest residences during this period. Ground vibrations from well drilling activities are expected to have negligible impact to nearby structures.</p>

Table 4.1-1. Summary of Environmental Impacts by Alternative for the FutureGen 2.0 Project

Criteria Considered	No Action	Proposed Project
Noise (continued)		
		<p>Operations: <i>Minor Adverse Impacts:</i> During operations, noise from the Meredosia Energy Center would either remain the same or be reduced in comparison to historical energy center operations. Similarly, noise levels during operations are expected to stay at the same level in comparison to current (post-2011) ambient conditions, since local noise levels are and will continue to be dominated by the existing Cargill facility and the highway IL-104. There would, however, be an increase in truck noise in the near vicinity of the energy center due to increased usage of trucks for coal delivery under the proposed project, compared to the historical use of barges as the primary means for coal delivery. The volume of truck traffic transporting feedstock (mainly coal and limestone) and removing wastes (mainly fly ash and bottom ash) would total less than 88 daily roundtrips. This represents almost 50 additional roundtrips per day when compared to historic truck traffic volumes.</p> <p>Operations at the injection well site(s) under normal operating conditions would be dominated by typical heating, ventilation, and air conditioning systems. Since the nearest sensitive receptors at the injection well site(s) are expected to be farther than 500 feet away, the noise impacts from operational equipment at the injection well site(s) would be minor.</p>
Utilities		
<p>Impacts were assessed based on whether the proposed project would:</p> <ul style="list-style-type: none"> Impact the effectiveness of existing utility infrastructure or cause temporary failure; Affect the capacity and distribution of local and regional utility suppliers to meet the existing or anticipated demand; or Require public utility system upgrades. 	<p>No Impacts.</p> <p>Baseline conditions would not change.</p>	<p>Construction: <i>Minor Adverse Impacts:</i> Construction of the proposed FutureGen 2.0 Project would result in increased demand for potable and process water, increased generation of wastewater, and increased electricity consumption. In addition, the placement of new electrical lines would be required to support operation of the proposed project. Construction-related impacts to water supplies would be short term and minor, while construction-related impacts to wastewater treatment would be negligible. Overall impacts to utilities during construction would be minor.</p> <p>Operations: <i>Minor Adverse Impacts:</i> Operation of the oxy-combustion facility would result in demand for potable and process water, generation of wastewater, and electricity consumption and generation. Existing utilities have adequate capacity to handle additional demands. Operation of the injection well site(s) and educational facilities would result in increased demand for potable water and electricity, and increased generation of wastewater. Operations impacts to water supplies would be negligible. Overall impacts to utilities during operations would be minor.</p>

Table 4.1-1. Summary of Environmental Impacts by Alternative for the FutureGen 2.0 Project

Criteria Considered	No Action	Proposed Project
Community Services		
<p>Impacts were assessed based on whether the proposed project would:</p> <ul style="list-style-type: none"> Displace, impede effective access to, or increase demand beyond available capacities of emergency response services, fire protection, law enforcement, healthcare facilities, and school systems in the ROI; or Conflict with local and regional plans for emergency response services, fire protection, law enforcement, healthcare facilities, or school systems. 	<p>No Impacts. Baseline conditions would not change.</p>	<p>Construction: <i>Negligible Adverse Impacts:</i> A temporary workforce of approximately 900 based on the updated design would be required during peak construction of the proposed project (a slight reduction from the Draft EIS). These workers would likely be drawn from the existing workforce of the area; however, an undeterminable number of workers and associated families may relocate to the area temporarily. Existing community services (i.e., law enforcement, emergency response, hospitals, and education) are expected to be adequate to address the needs of the population in the ROI, including project personnel and their dependents. Existing emergency response capabilities are expected to be adequate to address potential accidents and other risks. Negligible impacts on community services would be expected.</p> <p>Operations: <i>Negligible Adverse Impacts:</i> Long-term operation of the project would require approximately 124 to 152 new employees based on the updated design (a slight reduction from the Draft EIS). It is likely that these workers would be drawn from the existing workforce of the area; however, an undeterminable number of workers and associated families may relocate to the area permanently. Existing community services (i.e., law enforcement, emergency response, hospitals, and education) are expected to be adequate to address the needs of the population in the ROI, including project personnel and their dependents. Existing emergency response capabilities are expected to be adequate to address potential accidents and other risks. Negligible impacts on community services would be expected.</p>
Human Health and Safety		
<p>Impacts were assessed based on whether the proposed project would:</p> <ul style="list-style-type: none"> Increase worker health risks due to industrial accidents, injuries, or illnesses during construction and normal operating conditions; Increase public health risks due to accidental releases of CO₂ or other trace gases associated with captured CO₂ during transport, active geologic storage activities, and following closure of the injection wells; or Increase public health risks due to intentional destructive acts. 	<p>No Impacts. Baseline conditions would not change.</p>	<p>Construction: <i>Minor Adverse Impacts:</i> The potential for worker injuries would be present during construction of the proposed FutureGen 2.0 Project. Based on the incident rate for utility system construction, the number of lost work days is estimated to be 12.5 or less over the entire construction period for all project components.</p> <p>Operations: <i>Minor Adverse Impacts:</i> Accidents and lost work days during operation of the oxy-combustion facility could occur. The two liquid oxygen tanks at the facility pose the highest potential consequences if an accident were to occur, which could affect workers but not the general public. However, such accidents are extremely unlikely to occur (i.e., the potential for an accident to occur is between once in 10,000 years and once in a million years).</p> <p>The potential for accidents involving the CO₂ pipeline are considered to be unlikely (i.e., the potential to occur between once in 100 years and once in 10,000 years). Workers in the vicinity of a pipeline puncture or rupture would be most susceptible to harm due largely to potential physical effects related to high-pressure and the velocity of the release, as well as from exposure to extreme temperature drops which could cause frostbite. In addition, high concentrations of CO₂ would be present in the narrow band</p>

Table 4.1-1. Summary of Environmental Impacts by Alternative for the FutureGen 2.0 Project

Criteria Considered	No Action	Proposed Project
<p>Human Health and Safety (continued)</p>		<p>of CO₂ escaping from the leak site. Immediate life threatening effects related to asphyxiation from short-term exposure to these high concentrations (i.e., exposure to CO₂ at concentrations that exceed 100,000 ppmv) could occur; however, workers would likely be able to flee the areas with high concentration due to the visual, physical, and audible signs associated with the event.</p> <p>A pipeline rupture or puncture would potentially cause exposure and risk to the public as the CO₂ expands and disperses creating a vapor plume. The potential maximum reasonably foreseeable accident scenario or exposure distances would occur with a pipeline rupture under calm meteorological conditions. There would be no effects to the general public from this type of rupture beyond a distance where CO₂ concentrations would exceed 5,000 parts per million, which over a 60-minute time period, could extend to a distance of up to 1,769 feet. Transient effects, which include temporary symptoms such as headache, dizziness, sweating, or vague feelings of discomfort, could occur within these distances. Exposure distances would be much shorter under meteorological conditions with wind levels greater than calm, when more air movement and subsequent chemical dissipation would occur.</p> <p>The Alliance's pipeline siting criteria includes an intended minimum distance of 150 feet from any occupied structure, which is greater than the distances at which exposures could result in serious adverse effects or life-threatening effects under meteorological conditions present more than 95 percent of the time. Under meteorological conditions D10 and D12, which occur only 3.6 and 0.7 percent of the time, respectively, irreversible or serious adverse effects associated with CO₂ exposures, could occur within exposure distances of up to 152 feet from the rupture site, and the potential for life-threatening effects from exposures could occur within 79 feet.</p> <p>Potential health impacts from accidental releases of CO₂ from the horizontal injection wells, considered to be extremely unlikely events, could extend to 114 feet if injection tubing is used, or to 540 feet if not. Under the vertical well configuration, analyzed in the Draft EIS but no longer proposed by the Alliance, effects of CO₂ from a release would be limited in extent to 92 feet from the well site. Releases of CO₂ following the end of injection operations are not expected to result in ambient air concentrations above established health criteria; thus health effects to the public would not be expected.</p> <p>Potential health effects could occur from exposure to trace gases in the pipeline and injection wells (hydrogen sulfide, sulfur dioxide, and sulfur trioxide); however, under normal operating conditions these components are not expected be present in measurable concentrations. Note that the oxy-combustion process is not expected to produce measureable concentrations of hydrogen sulfide.</p> <p>Potential effects from catastrophic or intentional destructive acts are expected to be similar to the above impacts.</p>

Table 4.1-1. Summary of Environmental Impacts by Alternative for the FutureGen 2.0 Project

Criteria Considered	No Action	Proposed Project
Socioeconomics		
<p>Impacts were assessed based on whether the proposed project would:</p> <ul style="list-style-type: none"> • Displace existing population or demolish existing housing; • Alter projected rates of population growth; • Affect the housing market; • Displace existing businesses; • Affect local businesses and the economy; • Displace existing jobs; or • Affect local employment or the workforce. 	<p>No Impacts. Baseline conditions would not change.</p>	<p>Construction: <i>Beneficial Impacts:</i> Spending and employment for the proposed project would generally result in net beneficial impacts to socioeconomic conditions during construction. A temporary increase in population caused by a slight influx of construction workers from outside the ROI would not have an adverse impact on population and housing. There is adequate capacity in the region to meet the labor force demand and the project is expected to benefit the regional economy.</p> <p>Operations: <i>Beneficial Impacts:</i> Spending and employment for operations of the proposed project would generally result in net beneficial impacts to socioeconomic conditions. In addition, the potential influx of workers for project operations would not have a substantial effect on regional population and housing.</p>
Environmental Justice		
<p>Impacts were assessed based on whether the proposed project would:</p> <ul style="list-style-type: none"> • Cause a significant and disproportionately high and adverse effect on a minority population; or • Cause a significant and disproportionately high and adverse effect on a low-income population. 	<p>No Impacts. Baseline conditions would not change.</p>	<p>Construction: <i>Negligible Adverse Impacts:</i> No disproportionately high and adverse impacts to minority and low-income populations are anticipated during construction of the project.</p> <p>Operations: <i>Negligible Adverse Impacts:</i> No disproportionately high and adverse impacts to minority and low-income populations are anticipated during operation of the project.</p>

CO₂ = carbon dioxide; dBA = A-weighted sound level in decibels; DOE = U.S. Department of Energy; GHG = greenhouse gas; IDNR = Illinois Department of Natural Resources; mgd = million gallons per day; MVA = monitoring, verification, and accounting; MWe = megawatt electrical; MWh = megawatt hour; NRHP = National Register of Historic Places; ppmv = parts per million by volume; NWI = National Wetland Inventory; ROI = region of influence; ROW = right-of-way; SHPO = State Historic Preservation Office; UIC = Underground Injection Control; USACE = U.S. Army Corps of Engineers; USDW = underground sources of drinking water

INTENTIONALLY LEFT BLANK

4.2 MEASURES TO MITIGATE ADVERSE IMPACTS

4.2.1 Introduction

The CEQ NEPA regulations direct the lead agency for an EIS to “include appropriate mitigation measures not already included in the proposed action or alternatives” (40 CFR 1502.14(f)). The regulations further define “mitigation” (40 CFR 1508.20) to include:

- (a) *Avoiding the impact altogether by not taking a certain action or parts of an action.*
- (b) *Minimizing impacts by limiting the degree or magnitude of the action and its implementation.*
- (c) *Rectifying the impact by repairing, rehabilitating, or restoring the affected environment.*
- (d) *Reducing or eliminating the impact over time by preservation and maintenance operations during the life of the action.*
- (e) *Compensating for the impact by replacing or providing substitute resources or environments.*

Per established protocols, procedures, and requirements, the Alliance would comply with all applicable federal, state, or municipal regulations and ordinances, as well as associated permitting processes, through the implementation of standard operating procedures and BMPs. These are generally required by environmental regulatory mandates applicable to the design, construction, and operation of the project. The Alliance also incorporated additional measures into the project to reduce impacts. Therefore, as the lead agency for the EIS, DOE considers that these mitigation measures are “already included in the proposed action or alternatives” consistent with 40 CFR 1502.14(f). DOE has also explored the range of reasonable mitigation measures, beyond those included in the proposed action or alternatives. If DOE decides to proceed with the proposed action, the ROD will “state whether all practicable means to avoid or minimize environmental harm from the alternative selected have been adopted, and if not, why they were not” in conformance with the CEQ NEPA regulations (40 CFR 1505.2(c)). For those additional mitigation measures deemed appropriate in its ROD, DOE will adopt and describe a monitoring and enforcement program to ensure that the measures would be implemented (40 CFR 1505.2(c)).

4.2.2 Mitigation Measure Summary by Resource Area

This section provides a consolidated summary of the mitigation measures applicable to each environmental resource area, which are also described for each resource area in Chapter 3 of this EIS. For each resource area, both for the construction and operation phases, Table 4.2-1 summarizes the measures that would be implemented by the Alliance to comply with applicable laws, regulations, and ordinances, as well as additional measures that the Alliance would incorporate into the project to further reduce potential impacts. These are the measures that DOE considers to be already included in the proposed action. In a final grouping under construction and operation respectively for each resource area, Table 4.2-1 outlines possible additional measures identified to further reduce impacts. The Alliance will collect additional information about the efficacy and cost-effectiveness of other available mitigation measures during final design. If DOE decides to proceed with the proposed action after publication of the Final EIS, the ROD will identify any additional specific mitigation measures selected as appropriate for implementation and funding in conjunction with the proposed action, and DOE will state why other measures would not be adopted. The additional mitigation measures would be the subject of a monitoring and enforcement program for the implementation of the proposed action.

Table 4.2-1. Mitigation Measures for the Proposed FutureGen 2.0 Project

Resource	Mitigation Measures
Air Quality	<p><u>Construction</u></p> <p>Measures Required by Laws, Regulations, Permits, and Ordinances:</p> <ul style="list-style-type: none"> • Construct the project in compliance with the construction permit, which would stipulate applicable controls and practices to reduce potential emissions. • Cover dump trucks before traveling on public roads to reduce fugitive dust. <p>Measures Incorporated Into the FutureGen 2.0 Project to Reduce Impacts:</p> <ul style="list-style-type: none"> • Control vehicle speeds on roads and exposed areas to reduce fugitive dust. • Reduce equipment idle time to reduce vehicle and construction equipment emissions. • Sweep or remove spilled material from paved surfaces to reduce the potential for fugitive dust. • Maintain engines and equipment according to manufacturer’s specifications to reduce construction equipment emissions. • Remove excess soil from truck tires by installing exit tracking pads to reduce fugitive dust on public roads. • Revegetate disturbed areas as soon as possible after disturbance and consistent with the construction schedule to reduce fugitive dust. <p>Possible Additional Measures Identified to Further Reduce Impacts:</p> <ul style="list-style-type: none"> • Treat unpaved roads with water or surfactants to reduce fugitive dust. • Stage site construction to limit the amount of land area disturbed at any given time and reduce fugitive dust. • Resurface unpaved access roads with stone whenever appropriate to reduce fugitive dust. • Cover construction materials and stockpiled soils as needed and as feasible to reduce fugitive dust. • Use electricity from the grid if available to reduce the use of diesel or gasoline generators for operating construction equipment to reduce emissions. • Use a phased construction period to reduce pollutant concentrations from construction equipment and vehicle emissions. • Wet soils before loading into dump trucks to reduce fugitive dust during dry and windy conditions. • Wet soils prior to grading, backfilling, or compacting to reduce fugitive dust. • Wet soils prior to excavation during windy conditions to reduce fugitive dust. <p><u>Operations</u></p> <p>Measures Required by Laws, Regulations, Permits, and Ordinances:</p> <ul style="list-style-type: none"> • Operate the project in compliance with the energy center’s Title V air permit, which would stipulate applicable controls and practices to reduce emissions. • Develop and implement a site-specific monitoring, reporting, and verification plan for operation of the electric generating unit and/or fuel combustion sources per the Mandatory Greenhouse Gas Reporting Rule. • Operate in compliance with other operational permits and forthcoming regulations, as applicable to reduce emissions. <p>Measures Incorporated Into the FutureGen 2.0 Project to Reduce Impacts:</p> <ul style="list-style-type: none"> • Maintain operational equipment according to manufacturer’s specifications to reduce emissions. • Control idling of operational equipment while not in use to reduce emissions and/or use electric or low emissions vehicles, where practical. • Provide proper drainage systems to and from paved arterial roads to the injection wells to the extent heavy vehicle traffic is expected. <p>Possible Additional Measures Identified to Further Reduce Impacts:</p> <ul style="list-style-type: none"> • Use electricity from the grid if available to reduce the use of diesel or gasoline generators during operations to reduce emissions.

Table 4.2-1. Mitigation Measures for the Proposed FutureGen 2.0 Project

Resource	Mitigation Measures	
Climate and Greenhouse Gases	<p><u>Construction</u></p> <p>Measures Required by Laws, Regulations, Permits, and Ordinances:</p> <ul style="list-style-type: none"> • None <p>Measures Incorporated Into the FutureGen 2.0 Project to Reduce Impacts:</p> <ul style="list-style-type: none"> • Use appropriate BMPs to reduce equipment and vehicle emissions (including GHGs) by such practices as maintaining engines according to manufacturers' specifications, minimizing idling of equipment while not in use, and using electricity from the grid if available to reduce the use of diesel or gasoline generators for operating construction equipment. <p>Possible Additional Measures Identified to Further Reduce Impacts:</p> <ul style="list-style-type: none"> • None 	
	<p><u>Operations</u></p> <p>Measures Required by Laws, Regulations, Permits, and Ordinances:</p> <ul style="list-style-type: none"> • Develop and implement a USEPA-approved site-specific monitoring, reporting, and verification plan for CO₂ injection wells per Subpart RR of the Mandatory Reporting of Greenhouse Gases Rule. The plan would assure that the GHGs are being sequestered safely and according to design and permit requirements. <p>Measures Incorporated Into the FutureGen 2.0 Project to Reduce Impacts:</p> <ul style="list-style-type: none"> • Use appropriate BMPs to reduce equipment and vehicle emissions (including GHGs) by such practices as maintaining engines according to manufacturers' specifications and minimizing idling of equipment while not in use. <p>Possible Additional Measures Identified to Further Reduce Impacts:</p> <ul style="list-style-type: none"> • None 	
	Physiography and Soils	<p><u>Construction</u></p> <p>Measures Required by Laws, Regulations, Permits, and Ordinances:</p> <ul style="list-style-type: none"> • Develop and implement an IEPA-approved SWPPP (to address erosion prevention measures, sediment control measures, permanent stormwater management, dewatering, environmental inspection and maintenance, and final stabilization) as required by the IEPA, in accordance with a general NPDES permit for construction. The SWPPP would include erosion and sedimentation control measures recommended in the Illinois Urban Manual by the USDA/NRCS such as silt fences, sand bags, straw bales, trench plugs, and interceptor dikes to reduce soil erosion. • Develop and implement an SPCC plan during construction to reduce potential for an oil release to navigable waters of the U.S. The plan would outline the procedures to prevent spills and detail the emergency actions to be taken should a spill occur. The SPCC plan would also describe the methods that would be used to contain a spill before it could contaminate soils. In addition, oils stored in containers greater than 55-gallon drums needed for the implementation of the proposed project would be held in areas with secondary containment that would be sufficient to contain spills. • Bury the CO₂ pipeline to at least 4 feet underground, and in agricultural areas, at least 5 feet. An additional depth of cover would be provided at stream and road crossings, beneath drainage ditches, and beneath irrigation tiles.
		<p>Measures Incorporated Into the FutureGen 2.0 Project to Reduce Impacts:</p> <ul style="list-style-type: none"> • Implement the procedures outlined in the Agricultural Impact Mitigation Agreement (see Appendix H, Agricultural Mitigation) to reduce the impacts on agricultural lands along the proposed pipeline corridor. The mitigation procedures would include the following: <ul style="list-style-type: none"> • Contain surface disturbance from construction of the pipeline within the pipeline ROWs and implement BMPs to reduce rutting and compaction of the soils from vehicle and heavy equipment use. • Document the location of the irrigation systems, drainage tiles, sensitive soils, and the groundwater table. The pipeline would be placed at sufficient depth (e.g., 1-foot

Table 4.2-1. Mitigation Measures for the Proposed FutureGen 2.0 Project

Resource	Mitigation Measures
Physiography and Soils <i>(continued)</i>	<p>buffer) as to be below drain tiles and ensure that the pipeline would not be encountered or exposed by farming methods or excessive erosion.</p> <ul style="list-style-type: none"> • Replace subsoil over the top of the pipeline and cap with the reserved topsoil, then re-contour and revegetate the disturbed areas with species appropriate to the area. • Cover soil stockpiles and install silt and wind fences to reduce soil loss through erosion. • Use wattles/fiber rolls to reduce and disperse runoff velocity and capture sediment during pipeline construction. • Remove topsoil and temporarily store onsite separately from other excavated material, to preserve integrity of topsoil in temporarily disturbed areas during pipeline construction. • Compact stored topsoil to prevent or reduce erosion during pipeline construction. • Replace the topsoil as the uppermost soil layer following pipeline construction to maintain the soil profile and expedite vegetation growth. • Restore the pipeline construction site to its original grade to maintain appropriate contours and natural drainages. • The following BMPs would be employed as necessary, to mitigate and reduce potential impacts during pipeline construction in areas of severe slopes: <ul style="list-style-type: none"> • Avoid potential trouble areas, such as natural temporary drainage ways and unstable soils like high shrink-swell potential soils and highly erodible soils. • Avoid construction in areas that are close to streams and open waters to prevent the potential for sedimentation. • Where construction access road crossings of streams cannot be avoided, use appropriate temporary improvements at stream crossings (adhering to Section 404 permit requirements). • Clear as little vegetation as possible for construction, and replant vegetation as soon as possible in areas not permanently disturbed by construction to maintain protective cover and reduce erosion potential. • Preserve natural vegetation, where possible, to prevent soil erosion and sedimentation into adjacent waterbodies or wetlands. • Stabilize temporary access roads, haul roads, parking areas, laydown areas, material storage, and other onsite vehicle transportation routes immediately after grading to prevent erosion. • Apply straw, hay, or other suitable materials to the soil surface for stabilization. • Use temporary seeding and mulching, or matting to produce a quick ground cover to reduce erosion on exposed soils that may be redisturbed or permanently stabilized at a later date. • Use permanent seeding to establish perennial vegetative cover on disturbed areas to reduce erosion and decrease sediment yield from disturbed areas and to permanently stabilize disturbed areas.
	<p>Possible Additional Measures Identified to Further Reduce Impacts:</p>
	<ul style="list-style-type: none"> • None
	<p><u>Operations</u></p>
	<p>Measures Required by Laws, Regulations, Permits, and Ordinances:</p>
	<ul style="list-style-type: none"> • Develop and implement an SPCC plan, which would direct prevention, control, and response to releases of oils that could potentially contaminate soils.
	<p>Measures Incorporated Into the FutureGen 2.0 Project to Reduce Impacts:</p>
	<ul style="list-style-type: none"> • Implement a two-year monitoring and remediation period immediately following the initial operation of the pipeline or the completion of initial ROW restoration, whichever occurs last. Identify and address any remaining impacts associated with the pipeline construction that would require restoration. • Revegetate the operational ROW for the pipeline with vegetation that would increase soil stability and decrease the probability of soil erosion.
	<p>Possible Additional Measures Identified to Further Reduce Impacts:</p>
	<ul style="list-style-type: none"> • None

Table 4.2-1. Mitigation Measures for the Proposed FutureGen 2.0 Project

Resource	Mitigation Measures
Geology	<p><u>Construction</u></p> <p>Measures Required by Laws, Regulations, Permits, and Ordinances:</p> <ul style="list-style-type: none"> • Obtain UIC Class VI permits from the USEPA and construct the injection wells in accordance with Class VI well construction standards and UIC permit requirements to prevent movement of fluids into or between USDWs or other zones and prevent drilling mud from infiltrating shallower aquifers during the construction of the wells. <p>Measures Incorporated Into the FutureGen 2.0 Project to Reduce Impacts:</p> <ul style="list-style-type: none"> • Use CO₂-resistive cement in the injection and confining formations to prevent CO₂ leaks. • Install surface casing through the base of the lowermost USDW and cemented to the surface to maintain well integrity and to prevent the upward migration of CO₂. • Ensure a competent cement seal along the length of the injection wells through the caprock formation and into the top of the Mt. Simon Formation to maintain well integrity and to prevent upward migration of CO₂. <p>Possible Additional Measures Identified to Further Reduce Impacts:</p> <ul style="list-style-type: none"> • None <p><u>Operations</u></p> <p>Measures Required by Laws, Regulations, Permits, and Ordinances:</p> <ul style="list-style-type: none"> • Operate wells in accordance with the UIC permits, which would specify operating and monitoring criteria for the CO₂ injection to prevent the migration of CO₂ from the injection zone and to ensure the protection of USDWs. • Implement the MVA plan and use subsurface monitoring to assess the potential for migration of CO₂ out of the injection zone. • Conduct mechanical integrity testing on the injection wells by continuously monitoring injection pressure, flow rate, and injected volumes, and annular pressure and fluid volume. • Conduct annual testing using down-hole geophysical logs or surveys to verify CO₂ retention. Annual testing may decrease to once every 5 years with each successful test. • Temporarily halt CO₂ injection and assess the situation if well integrity issues are identified, if there are seismic effects, or if there are abnormal readings in order to ensure CO₂ retention in the reservoir. • Reevaluate the AoR at least every 5 years after the issuance of the UIC Class VI permits, as required under 40 CFR 146.84(b)(2)(i). This reevaluation would consider the volume of CO₂ that has been injected during the previous 5 years, the pressure at which it has been injected, and the resulting CO₂ plume, as determined by ongoing monitoring in accordance with the UIC permits. Any changes to the AoR as a result of the reevaluation could also trigger changes to the MVA monitoring protocol. <p>Measures Incorporated Into the FutureGen 2.0 Project to Reduce Impacts:</p> <ul style="list-style-type: none"> • Sample groundwater from up to 10 nearby farm/residential wells to verify that the project has no adverse environmental impacts. • Install a multi-level monitoring well to monitor the pressure and geochemical changes in the injection zone to assess the potential for excessive pressure build up and injection-induced seismicity. • Use remote sensing technology or install surface tiltmeters. <p>Possible Additional Measures Identified to Further Reduce Impacts:</p> <ul style="list-style-type: none"> • None
Groundwater	<p><u>Construction</u></p> <p>Measures Required by Laws, Regulations, Permits, and Ordinances:</p> <ul style="list-style-type: none"> • Develop and implement an SPCC plan during construction to reduce potential for groundwater contamination. The plan would outline the procedures to prevent spills and detail the emergency actions that would be implemented in the event that a spill occurs. The SPCC plan would also describe the methods that would be used to clean a spill before it could contaminate groundwater. In addition, petroleum products needed for the

Table 4.2-1. Mitigation Measures for the Proposed FutureGen 2.0 Project

Resource	Mitigation Measures
Groundwater (continued)	<p>implementation of the proposed project would be stored in areas with secondary containment that would be sufficient to contain spills.</p> <ul style="list-style-type: none"> • Comply with the design and construction standards specified in the Class VI UIC permits and the Well Works permit, which would require the use of CO₂-resistant cement casings at the base of each injection well to prevent leaks and ensure protection of groundwater resources. • During construction of the injection wells, implement Class VI injection well standards, and deep well BMPs, which would prevent drilling mud from infiltrating shallower aquifers. <p>Measures Incorporated Into the FutureGen 2.0 Project to Reduce Impacts:</p> <ul style="list-style-type: none"> • The Alliance would locate the injection wells using the siting criteria listed in Section 2.5.2.1, which includes avoiding major bodies of water and wetlands areas. These areas tend to have shallow groundwater tables and high infiltration rates, so avoiding these locations would also reduce the potential for impacts to shallow aquifers. <p>Possible Additional Measures Identified to Further Reduce Impacts:</p> <ul style="list-style-type: none"> • None <p>Operations</p> <p>Measures Required by Laws, Regulations, Permits, and Ordinances:</p> <ul style="list-style-type: none"> • Develop and implement an SPCC plan during operations to reduce potential for groundwater contamination. The plan would outline the procedures to prevent spills and detail the emergency actions that would be followed to respond to spills. The SPCC plan would also describe the methods that would be used to clean a spill before it could infiltrate the groundwater. In addition, petroleum products needed for the implementation of the proposed project would be stored in areas with secondary containment that would be sufficient to contain spills. • Comply with the terms of the UIC permits, which regulate CO₂ injection and storage. This includes complying with monitoring requirements to detect potential leaks and ensure protection of groundwater resources. <p>Measures Incorporated Into the FutureGen 2.0 Project to Reduce Impacts:</p> <ul style="list-style-type: none"> • Implement the MVA plan to assess the potential for the migration of CO₂ or brine into groundwater aquifers and, if needed, implement remedial measures. <p>Possible Additional Measures Identified to Further Reduce Impacts:</p> <ul style="list-style-type: none"> • Activities being considered in the MVA plan include: <ul style="list-style-type: none"> • Fluid sampling and pressure/temperature monitoring for early leak detection within the deepest permeable zone located directly above the primary confining zone. • Fluid sampling and pressure/temperature monitoring for leak detection and assessment of water-quality impacts to the lowermost USDW aquifer (St. Peter). • Regular groundwater sampling for early leak detection within shallow groundwater aquifers.
Surface Water	<p>Construction</p> <p>Measures Required by Laws, Regulations, Permits, and Ordinances:</p> <ul style="list-style-type: none"> • Comply with the CWA Section 404 permitting process to avoid, reduce, and mitigate potential impacts to waters of the U.S. during construction. Mitigation would follow the USACE Compensatory Mitigation Policy for Illinois and would be determined through coordination with both the USACE St. Louis and Rock Island Districts as applicable. • Comply with the NPDES and Section 401 Water Quality Certification permitting process via the IEPA to reduce and prevent potential impacts to waters of the U.S. during construction of the proposed project. • Develop and implement an IEPA-approved SWPPP (to address erosion prevention measures, sediment control measures, permanent stormwater management, dewatering, environmental inspection and maintenance, and final stabilization) as required by the IEPA, in accordance with a general NPDES Permit for construction. The

Table 4.2-1. Mitigation Measures for the Proposed FutureGen 2.0 Project

Resource	Mitigation Measures
Surface Water (continued)	<p>SWPPP would incorporate principles of the Illinois Urban Manual (AISWCD 2012) and would direct the mitigation of potential impacts from stormwater runoff and discharges during construction.</p> <ul style="list-style-type: none"> Pursuant to 40 CFR 112 of the CWA, the existing SPCC plan at the Meredosia Energy Center would be modified within six months of beginning construction to reflect new facility operations regarding the storage and managements of petroleum, oils, and other lubricants at the facility. The SPCC plan would implement measures to prevent releases of oil to adjacent surface waters, and would identify and determine response action procedures to reduce impacts in the event of a spill.
	<p>Measures Incorporated Into the FutureGen 2.0 Project to Reduce Impacts:</p>
	<ul style="list-style-type: none"> Use soil stabilization measures (e.g., seeding, mulching, or matting) to reduce erosion of soils exposed during construction to prevent sedimentation impacts to streams during storm events. Stabilize temporary access roads, haul roads, parking areas, laydown, material storage and other onsite vehicle transportation routes as soon as practicable after grading to reduce the erosion potential. Preserve natural vegetation as much as practicable, but especially in critical areas such as on steep slopes and in areas adjacent to watercourses, swales, or wetlands to reduce potential for sedimentation impacts to streams during storm events. Maximize use of existing roads in planning site access to reduce vegetation disturbance and the potential for erosion and sedimentation impacts to streams during storm events. Keep construction materials, debris, construction chemicals, construction staging, fueling, etc. at a safe distance from surface waters. Remove spoil, debris, piling, construction materials, and any other obstructions resulting from or used during construction as soon as practicable. These measures would reduce the potential for contamination of surface waters from accidental spills and would reduce the potential for construction debris to enter surface waters. Use trenchless technologies, such as horizontal directional drilling and jack and bore tunneling, for crossings of all waterbodies to avoid impacts to surface waters. In the event that trenching is used for crossings of dry stream (ephemeral and intermittent) channels, design pipeline crossings using the most direct route and construct water crossings during periods of low flow conditions to the extent practicable. Use crossing sites that have low, stable banks, a firm stream bottom, and minimal surface runoff when possible. These measures would reduce disturbance to streambeds and surface waters during pipeline installation. Any stormwater runoff exposed to the coal storage and ash area (including coal pile runoff, coal handling dust suppression water, coal handling equipment wash-down water, and stormwater from the coal yard) would be diverted to the new lined settling basin through berms and above-ground conveyance systems. The basin would be lined to detain water and provide settling for removal of suspended solids. After an appropriate detention time, the wastewater would flow to the wastewater treatment system for treatment and then would be discharged to the Illinois River in accordance with an NPDES permit.
	<p>Possible Additional Measures Identified to Further Reduce Impacts:</p>
	<ul style="list-style-type: none"> Where practical, consider weather and ground conditions when scheduling construction activities to reduce potential impacts to surface waters, such as erosion and the spread of contaminants that may be exacerbated by sheet flow during storm events.
	<p><u>Operations</u></p>
	<p>Measures Required by Laws, Regulations, Permits, and Ordinances:</p>
	<ul style="list-style-type: none"> The CWA requirement for the development and implementation of an SPCC plan during operation of the project would direct prevention, control, and response to releases of oil that could potentially contaminate surface waters. The project would operate under the existing (pending recently submitted modifications based upon project design changes) NPDES Permit (NPDES Permit IL0000116) which would impose monitoring requirements and effluent discharge

Table 4.2-1. Mitigation Measures for the Proposed FutureGen 2.0 Project

Resource	Mitigation Measures
Surface Water (continued)	<p>standards to protect water quality in the Illinois River.</p> <ul style="list-style-type: none"> In accordance with American Society of Mechanical Engineers Standard 31.44 (ASME 31.44) and 49 CFR 195, MLBVs would be installed along the CO₂ pipeline approximately every 10 miles to isolate and contain any leak and would also be installed on either side of major river crossings, at other waterbody crossings of more than 100 feet wide from high water mark to high water mark, and optionally at major road crossings. These measures would serve to prevent and reduce adverse impacts to surface waters in the unlikely event of a pipeline rupture. <p>Measures Incorporated Into the FutureGen 2.0 Project to Reduce Impacts:</p> <ul style="list-style-type: none"> Provide proper drainage systems to and from paved arterial roads to the injection wells to the extent heavy vehicle traffic is expected. <p>Possible Additional Measures Identified to Further Reduce Impacts:</p> <ul style="list-style-type: none"> Use water conservation measures to the maximum extent practicable (e.g., efficient landscaping and recycling wastewater).
Wetlands and Floodplains	<p>Construction</p> <p>Measures Required by Laws, Regulations, Permits, and Ordinances:</p> <ul style="list-style-type: none"> Avoid, reduce, and mitigate impacts to wetlands through the CWA 404 permitting process under the regulatory purview of the USACE St. Louis and Rock Island Districts as applicable. Develop and implement an IEPA-approved SWPPP (to address erosion prevention measures, sediment control measures, permanent stormwater management, dewatering, environmental inspection and maintenance, and final stabilization) as required by the IEPA, in accordance with a general NPDES permit for construction activities. The SWPPP would reduce potential indirect impacts to wetlands (including waters of the U.S.) during construction. Pursuant to 40 CFR 112 of the CWA, the existing SPCC plan at the Meredosia Energy Center would be modified within six months of beginning construction to reflect new facility operations regarding the storage and management of petroleum, oils, and other lubricants at the facility. The SPCC plan would implement measures to prevent releases of oil to adjacent surface waters (and associated wetlands), and would identify and determine response action procedures to reduce impacts in the event of a spill. Wetland mitigation would follow the Compensatory Mitigation Policy for Illinois and would be determined through coordination with USACE St. Louis and/or Rock Island Districts. Prior to construction, the Alliance would conduct a formal wetland delineation of the final proposed CO₂ pipeline route and the injection well site(s) to identify potential wetlands, including wetlands not mapped by the NWI, potentially affected by these proposed project components. This would also occur at the location of the educational facilities (as needed). Should project planning ultimately propose additional buildings or structures within mapped 100-year floodplains, the Alliance would construct these buildings in accordance with the IAC and Morgan County Floodplain Ordinance. <p>Measures Incorporated Into the FutureGen 2.0 Project to Reduce Impacts:</p> <ul style="list-style-type: none"> During construction of the proposed project, the construction contractor would monitor USACE estimates of river levels in the area and if flooding was likely or imminent, equipment would be moved out of the floodplain prior to any incidents of flooding to the extent practicable to protect lives of workers, property, and the neighboring properties that could be affected by obstructions to flood flows onsite. Use trenchless technologies, including horizontal directional drilling and jack and bore tunneling, for proposed crossings of all waterways and wetlands (except wetlands that occur within agricultural areas or dry ephemeral and intermittent stream channels) to avoid wetland impacts. During construction of the proposed pipeline, following trench digging and pipeline installation in wetlands that occur within agricultural areas or within dry ephemeral and intermittent stream channels, excavated wetland soils would be backfilled into the

Table 4.2-1. Mitigation Measures for the Proposed FutureGen 2.0 Project

Resource	Mitigation Measures
Wetlands and Floodplains <i>(continued)</i>	<p>trenches so that the deepest soils excavated would be returned as the deepest soils backfilled. This method of wetland soil backfilling would help maintain pre-construction wetland soil characteristics following construction.</p> <ul style="list-style-type: none"> • Keep construction materials, debris, construction chemicals, construction staging, fueling, etc. at a safe distance from wetlands and floodplains to prevent unintentional contamination and keep spill kits on hand to reduce response time in case of spills. • Avoid wetland areas within construction ROW to the extent practicable during the placement of equipment or materials. • Maximize the use of existing roads in planning site access to reduce vegetation disturbance and the potential for rutting and potential hydrology alternation to adjacent wetlands. <p>Possible Additional Measures Identified to Further Reduce Impacts:</p> <ul style="list-style-type: none"> • None <p>Operations</p> <p>Measures Required by Laws, Regulations, Permits, and Ordinances:</p> <ul style="list-style-type: none"> • The location and extent of onsite wetlands areas would be depicted on relevant facility maps and site plans as required to ensure that these areas are not inadvertently developed or disturbed. <p>Measures Incorporated Into the FutureGen 2.0 Project to Reduce Impacts:</p> <ul style="list-style-type: none"> • Permanently preserve wetland areas during facility operations through signage so that these areas are not inadvertently disturbed, mowed, or cleared of vegetation. Incorporate wetlands management activities into appropriate facility plans and SOPs, as needed (e.g., SPCC, SWPPP, pesticides application, etc.). • Locate the MLBVs on high ground, to the extent possible, to avoid floodplains and wetlands. <p>Possible Additional Measures Identified to Further Reduce Impacts:</p> <ul style="list-style-type: none"> • None
Biological Resources	<p>Construction</p> <p>Measures Required by Laws, Regulations, Permits, and Ordinances:</p> <ul style="list-style-type: none"> • DOE has been engaged in ongoing consultations with the USFWS and is preparing a Biological Assessment for submission to the USFWS that addresses the three federally-listed species for which suitable habitat occurs in the project area: the Indiana bat, decurrent false aster, and eastern prairie fringed orchid. Based on the progress of the Biological Assessment at publication of the Final EIS, DOE believes that the proposed action is not likely to adversely affect any of the listed species. The Biological Assessment, when submitted, will provide DOE's final determination and will identify measures as appropriate to minimize impacts to federally-listed species. The Biological Assessment would also support the USFWS in issuing its Biological Opinion for the project, if one is needed. • To avoid potential violations of the MBTA, the Alliance would perform initial land clearing activities and vegetative maintenance activities between September and February (outside of the migratory bird nesting season from April 1 to July 31) or would conduct a survey for migratory bird nests immediately prior to land clearing activities. Should any nests be found, the Alliance would either re-design the appropriate project component or alter the construction schedule to avoid the take of any individuals. • DOE conducted bald eagle surveys on the Meredosia Energy Center site in June 2013 and determined that there are no nesting bald eagles onsite. These results will be communicated to USFWS in the Biological Assessment. • If the Alliance undertakes activities related to the barge unloading facility that would disturb the river bottom, then prior to initiating construction within the proposed barge unloading area, a survey for the ebonyshell (a state-listed threatened species) would be performed by a qualified biologist. Should the species be found, the area would be avoided, if practicable, or coordination would occur with USFWS and IDNR to determine

Table 4.2-1. Mitigation Measures for the Proposed FutureGen 2.0 Project

Resource	Mitigation Measures
Biological Resources <i>(continued)</i>	<p>the appropriate course of action.</p> <ul style="list-style-type: none"> • A qualified biologist would conduct surveys for federal- and state-listed species in areas with appropriate habitat within the finalized CO₂ pipeline route and injection well site(s). Should any federal- or state-threatened or endangered species be found, the proposed project would be sited to avoid potential impacts, or coordination would occur with USFWS to determine the appropriate course of action. • To avoid potential violations of the Illinois Endangered Species Protection Act, and as requested by IDNR, a Conservation Plan would be developed and implemented for the Illinois chorus frog and any other protected species. The plan would summarize the measures that would be taken should any protected species be encountered during construction activities. <p>Measures Incorporated Into the FutureGen 2.0 Project to Reduce Impacts:</p> <ul style="list-style-type: none"> • Following publication of the Draft EIS, the Alliance reduced the acreage of forested areas that would be cleared at the Meredosia Energy Center and along the CO₂ pipeline route to avoid and minimize impacts on the Indiana bat and migratory birds. <p>Possible Additional Measures Identified to Further Reduce Impacts:</p> <ul style="list-style-type: none"> • Implement measures to avoid the spread of invasive plants, such as washing long-term construction equipment prior to being brought to the construction site to reduce the potential for introduction of invasive seeds that may have been picked up at other locations. <p>Operations</p> <p>Measures Required by Laws, Regulations, Permits, and Ordinances:</p> <ul style="list-style-type: none"> • In accordance with Section 316(b) of the CWA, maintain withdrawal rates for the river water intake at the Meredosia Energy Center at or below a maximum velocity of 0.5 feet per second to reduce the number of fish trapped against intake screens. <p>Measures Incorporated Into the FutureGen 2.0 Project to Reduce Impacts:</p> <ul style="list-style-type: none"> • None <p>Possible Additional Measures Identified to Further Reduce Impacts:</p> <ul style="list-style-type: none"> • None
Cultural Resources	<p>Construction</p> <p>Measures Required by Laws, Regulations, Permits, and Ordinances:</p> <ul style="list-style-type: none"> • Potential impacts to NHPA-protected cultural resources would be avoided or mitigated in accordance with the NHPA and as specified in the Programmatic Agreement executed by the DOE, the Alliance, and the SHPO (see Appendix B, Cultural Resources Consultation [B3]). <p>Measures Incorporated Into the FutureGen 2.0 Project to Reduce Impacts:</p> <ul style="list-style-type: none"> • Prior to the construction of the pipeline or the injection well site(s), steps described in the Programmatic Agreement would be undertaken to characterize the presence of cultural resources in areas that have not been disturbed or surveyed previously. Where possible, the CO₂ pipeline would follow existing road and utility ROWs. • Implement steps to take should cultural resources be discovered inadvertently during construction (inadvertent discovery procedures). <p>Possible Additional Measures Identified to Further Reduce Impacts:</p> <ul style="list-style-type: none"> • None <p>Operations</p> <p>Measures Required by Laws, Regulations, Permits, and Ordinances:</p> <ul style="list-style-type: none"> • None

Table 4.2-1. Mitigation Measures for the Proposed FutureGen 2.0 Project

Resource	Mitigation Measures
Cultural Resources <i>(continued)</i>	<p>Measures Incorporated Into the FutureGen 2.0 Project to Reduce Impacts:</p> <ul style="list-style-type: none"> • None <p>Possible Additional Measures Identified to Further Reduce Impacts:</p> <ul style="list-style-type: none"> • None
Land Use	<p><u>Construction</u></p> <p>Measures Required by Laws, Regulations, Permits, and Ordinances:</p> <ul style="list-style-type: none"> • Comply with pipeline siting protocol in 49 CFR 195 (“Transportation of Hazardous Liquids by Pipeline”) and 220 ILCS 20 Illinois Gas Pipeline Safety Act which require pipeline ROWs to avoid, as far as practicable, areas containing private dwellings, industrial buildings, and places of public assembly per 49 CFR 195.210 (“Pipeline Location”). The pipeline would not be located within 50 feet of any private dwelling, or any industrial building or place of public assembly in which persons work, congregate, or assemble, unless it is provided with at least 12 inches of soil cover in addition to that prescribed in 49 CFR 195.248 (“Cover Over Buried Pipeline”). • Obtain necessary legal ROW easements for utility corridors. • The Alliance would abide by stipulations of the Jacksonville Zoning Ordinance in locating the proposed educational facilities within the corporate limits of Jacksonville and contiguous territory within 1.5 miles beyond. Additionally, the Jacksonville comprehensive plan and future land use plans would be used during site coordination and selection, and the Alliance would coordinate with the Jacksonville Regional Economic Development Corporation during the site identification process. <p>Measures Incorporated Into the FutureGen 2.0 Project to Reduce Impacts:</p> <ul style="list-style-type: none"> • Adhere to IDOA Pipeline Construction Standards and Policies outlined in the Agricultural Impact Mitigation Agreement (see Appendix H, Agricultural Mitigation) to help preserve the integrity of any agricultural land that would be impacted by pipeline construction. • The Alliance would reduce potential impacts on agricultural production and land use within and adjacent to the ROW for the pipeline by conducting construction activities outside of the planting and growing seasons to the extent practicable. • To the extent practicable, the Alliance would locate the pipeline no closer than 150 feet from residences, which surpasses the 50-foot separation distance required by 49 CFR 195. Examples of when a shorter distance would be used (but not less than 50 feet as required by federal law) would include when necessary to avoid a sensitive environmental resource or at the request of an affected landowner. • To the extent practicable, the pipeline would be located along existing ROWs. In addition, access to the construction ROW for the pipeline would be provided from existing roads that cross the pipeline route to the extent practicable. • In cases where the pipeline would bisect a property, the pipeline would be designed to incorporate suitable crossings by placing the pipeline underground, engineering the pipeline to withstand the weight of typical rural or residential vehicles (i.e., cars, trucks, tractors), and maintaining property owner access throughout the entire property. • Potential impacts to agricultural land crossed by the pipeline would be mitigated by restoring the land to its original condition to the extent practicable and allowing the current land use to resume after construction. • Arrangements would be made between landowners and the Alliance to reduce the long-term impacts on agricultural land use or other activities around the proposed injection facilities. • To the extent practicable, avoid net reductions in agricultural land, including taking measures to replace lands taken out of agricultural use with land that can be placed into agricultural use. Land placed into new agricultural use would be in the immediate vicinity of land taken out of agricultural use. <p>Possible Additional Measures Identified to Further Reduce Impacts:</p> <ul style="list-style-type: none"> • None

Table 4.2-1. Mitigation Measures for the Proposed FutureGen 2.0 Project

Resource	Mitigation Measures
Land Use <i>(continued)</i>	<p><u>Operations</u></p> <p>Measures Required by Laws, Regulations, Permits, and Ordinances:</p> <ul style="list-style-type: none"> • None <p>Measures Incorporated Into the FutureGen 2.0 Project to Reduce Impacts:</p> <ul style="list-style-type: none"> • Utility and transportation corridors would be maintained in accordance with ROW provisions that would incorporate the objectives of the Agricultural Impact Mitigation Agreement with IDOA for the avoidance of impacts on agricultural lands. <p>Possible Additional Measures Identified to Further Reduce Impacts:</p> <ul style="list-style-type: none"> • The Alliance would reduce potential impacts on agricultural production and land use within and adjacent to the operational ROW for the pipeline by conducting maintenance activities outside of the planting and growing seasons to the extent practicable.
Aesthetics	<p><u>Construction</u></p> <p>Measures Required by Laws, Regulations, Permits, and Ordinances:</p> <ul style="list-style-type: none"> • None <p>Measures Incorporated Into the FutureGen 2.0 Project to Reduce Impacts:</p> <ul style="list-style-type: none"> • To the extent practicable, the CO₂ pipeline would be sited at a minimum distance of 150 feet from the nearest residence, which is 100 feet further than what is federally mandated under 49 CFR 195. This would reduce aesthetic impacts from construction noise and traffic and the visible impact of the pipeline ROW. Examples of when a shorter distance would be used (but not less than 50 feet as required by federal law) would include when necessary to avoid a sensitive environmental resource or at the request of an affected landowner. • To the extent practicable, light pollution would be reduced. • Revegetate the site where possible. <p>Possible Additional Measures Identified to Further Reduce Impacts:</p> <ul style="list-style-type: none"> • None <p><u>Operations</u></p> <p>Measures Required by Laws, Regulations, Permits, and Ordinances:</p> <ul style="list-style-type: none"> • None <p>Measures Incorporated Into the FutureGen 2.0 Project to Reduce Impacts:</p> <ul style="list-style-type: none"> • Use of outdoor security and site lighting would be implemented that is low in height, shielded so that the light is not directed skyward, and of minimal brilliance to illuminate the intended area and meet the intended purpose at that location (e.g., parking lots, signs, walkways, and safety and work areas). • Structures, wellheads, safety barriers, and other surface structures in agricultural areas would be designed to have limited visual impact and have a design compatible with other agricultural structures. • Visitor, research, and training facilities would be designed to be compatible with adjacent community structures, including appropriate landscaping and utilities. <p>Possible Additional Measures Identified to Further Reduce Impacts:</p> <ul style="list-style-type: none"> • None
Materials and Waste Management	<p><u>Construction</u></p> <p>Measures Required by Laws, Regulations, Permits, and Ordinances:</p> <ul style="list-style-type: none"> • Transport construction materials and wastes in accordance with DOT and IDOT regulations pertaining to proper packaging, labeling, and response to releases. • Manage wastes in compliance with RCRA regulations pertaining to storage, labeling, containment, and disposal. • Develop and implement an SPCC plan per the Oil Pollution Prevention regulation under

Table 4.2-1. Mitigation Measures for the Proposed FutureGen 2.0 Project

Resource	Mitigation Measures
<p>Materials and Waste Management <i>(continued)</i></p>	<p>the CWA to prevent, control, and respond to releases of oil.</p> <p>Measures Incorporated Into the FutureGen 2.0 Project to Reduce Impacts:</p> <ul style="list-style-type: none"> • Reduce the storage of hazardous materials and generation of hazardous wastes at construction sites to the extent practicable. • Remove construction and demolition waste materials from construction sites on a regular basis and recycle whenever possible. • Restrict use of oil, solvents, and other hazardous materials to designated areas equipped with spill containment measures (e.g., secondary containment) appropriate to the hazard and volume of material being stored on the construction site. • Cover hazardous material storage areas. • Include adequate valving, interlocks, safety systems (fogging, foaming, secondary containment, berms, spill prevention, instrumentation, ambient monitoring systems, alarms, etc.) in the design and engineering of reagent and other chemical feed storage systems. • Install process drains, sumps, and secondary containment structures to capture any inadvertent spills, leaks, and washdown of the area and/or equipment. • Synthetic (plastic) sheeting (30-mil thick or greater) would be laid down beneath mud pits (steel tanks) and associated circulation equipment, including mud pumps to prevent releases of drilling fluids to the ground surface. The drilling contractor would also install a synthetic liner beneath the rig (rig underliner). • The drilling contractor would maintain an inventory of absorbent materials (e.g., pads and booms) in order to respond to any release of engine oil, hydraulic oil, diesel fuel, gasoline, antifreeze, drilling fluids or any other contaminants as a result of the driller's activities. • Any spills involving fuel or other liquid or dry chemicals would be cleaned up immediately, including any affected soil. Used spill cleanup materials as well as any affected soil would be contained and disposed of properly. <p>Possible Additional Measures Identified to Further Reduce Impacts:</p> <ul style="list-style-type: none"> • None <p>Operations</p> <p>Measures Required by Laws, Regulations, Permits, and Ordinances:</p> <ul style="list-style-type: none"> • Conduct transportation of materials and wastes in accordance with DOT regulations pertaining to proper packaging, labeling, and response to releases. • Manage wastes in compliance with RCRA regulations pertaining to storage, labeling, containment, and disposal. • Develop and implement an SPCC plan per the Oil Pollution Prevention regulation under the CWA to prevent, control, and respond to releases of oil during operations. <p>Measures Incorporated Into the FutureGen 2.0 Project to Reduce Impacts:</p> <ul style="list-style-type: none"> • Perform refueling, lubrication, and degreasing of vehicles and heavy equipment in designated areas. <p>Possible Additional Measures Identified to Further Reduce Impacts:</p> <ul style="list-style-type: none"> • None
<p>Traffic and Transportation</p>	<p>Construction</p> <p>Measures Required by Laws, Regulations, Permits, and Ordinances:</p> <ul style="list-style-type: none"> • Comply with local and IDOT requirements during design and construction of any new roadways, improvements to existing roadways, and any pipeline construction activities that could potentially impact public roads. <p>Measures Incorporated Into the FutureGen 2.0 Project to Reduce Impacts:</p> <ul style="list-style-type: none"> • Install speed control signs and/or speed sensing devices on public roads that would experience significant project-related traffic and as needed to control speed. • Route and schedule construction vehicle traffic to reduce conflicts with other traffic, with

Table 4.2-1. Mitigation Measures for the Proposed FutureGen 2.0 Project

Resource	Mitigation Measures
Traffic and Transportation <i>(continued)</i>	<p>a particular emphasis on reducing disruptions to residents along access roads and farm traffic.</p> <p>Possible Additional Measures Identified to Further Reduce Impacts:</p> <ul style="list-style-type: none"> • Strategically locate staging areas to reduce traffic impacts. • Equip construction vehicles with backing alarms, two-way radios, and ‘Slow Moving Vehicle’ signs where appropriate. • Coordinate with local authorities regarding the movement of oversized loads, construction equipment, and materials via both land and water. • Coordinate with local authorities to implement detour plans, warning signs, and traffic diversion equipment to improve traffic flow and road safety during any construction-related traffic disruptions. <p><u>Operations</u></p> <p>Measures Required by Laws, Regulations, Permits, and Ordinances:</p> <ul style="list-style-type: none"> • None <p>Measures Incorporated Into the FutureGen 2.0 Project to Reduce Impacts:</p> <ul style="list-style-type: none"> • Install hard surface roads from main arterials to and from the injection well site(s) or other facilities that would be subject to significant project traffic. • Develop a visitor transportation plan, including measures that would ensure visitor access to the energy center and CO₂ injection well site(s) while minimizing the volume of vehicle traffic. • Complete road, parking, and access upgrades essential to community and visitor safety in the proximity of the visitor, research, and training facilities. <p>Possible Additional Measures Identified to Further Reduce Impacts:</p> <ul style="list-style-type: none"> • None
Noise	<p><u>Construction</u></p> <p>Measures Required by Laws, Regulations, Permits, and Ordinances:</p> <ul style="list-style-type: none"> • None <p>Measures Incorporated Into the FutureGen 2.0 Project to Reduce Impacts:</p> <ul style="list-style-type: none"> • During construction of the injection wells, noise mitigation berms would be constructed around the drill rig site to reduce noise levels at nearby receptors during drilling operations. <p>Possible Additional Measures Identified to Further Reduce Impacts:</p> <ul style="list-style-type: none"> • To the extent practical, onsite project construction work that would generate noise would be limited to daylight hours when people are generally less sensitive to noise. • The Alliance would evaluate potential mitigation measures to ensure that noise effects to sensitive receptors remain less-than-significant, particularly due to the 24-hour operational schedule associated with pipeline trenchless boring techniques and injection well drilling. <p><u>Operations</u></p> <p>Measures Required by Laws, Regulations, Permits, and Ordinances:</p> <ul style="list-style-type: none"> • None <p>Measures Incorporated Into the FutureGen 2.0 Project to Reduce Impacts:</p> <ul style="list-style-type: none"> • None <p>Possible Additional Measures Identified to Further Reduce Impacts:</p> <ul style="list-style-type: none"> • None

Table 4.2-1. Mitigation Measures for the Proposed FutureGen 2.0 Project

Resource	Mitigation Measures
Utilities	<p><u>Construction</u></p> <p>Measures Required by Laws, Regulations, Permits, and Ordinances:</p> <ul style="list-style-type: none"> • None <p>Measures Incorporated Into the FutureGen 2.0 Project to Reduce Impacts:</p> <ul style="list-style-type: none"> • To reduce the possible interference with existing overhead or buried utility lines, proposed construction ROWs would have sufficient width to allow for the safe addition of construction equipment and proposed project-related infrastructure and facilities. Specifically, crossings of other types of pipelines and other underground utilities would require a minimum of 12 inches of separation; the minimum separation may be increased to 24 inches where considered prudent. • Existing pipelines would be under-crossed unless over-crossing is specifically permitted by the pipeline owner. • Alignments of existing utilities (e.g., electric, telephone, cable, water, gas, and sewer) would be located and demarcated prior to construction and coordination with affected utility providers would continue throughout final engineering and design (including coordination with planned Illinois Rivers Transmission Project; see Section 4.3, Potential Cumulative Impacts). <p>Possible Additional Measures Identified to Further Reduce Impacts:</p> <ul style="list-style-type: none"> • Controls such as vacuum extraction of trenches in select areas proximal to buried utilities would decrease the potential for construction equipment, particularly trenching equipment, to sever or damage existing underground lines. <p><u>Operations</u></p> <p>Measures Required by Laws, Regulations, Permits, and Ordinances:</p> <ul style="list-style-type: none"> • None <p>Measures Incorporated Into the FutureGen 2.0 Project to Reduce Impacts:</p> <ul style="list-style-type: none"> • None <p>Possible Additional Measures Identified to Further Reduce Impacts:</p> <ul style="list-style-type: none"> • None
Community Services	<p><u>Construction</u></p> <p>Measures Required by Laws, Regulations, Permits, and Ordinances:</p> <ul style="list-style-type: none"> • None <p>Measures Incorporated Into the FutureGen 2.0 Project to Reduce Impacts:</p> <ul style="list-style-type: none"> • None <p>Possible Additional Measures Identified to Further Reduce Impacts:</p> <ul style="list-style-type: none"> • Assess the sufficiency of local first responders to support project needs and develop and implement a plan to fill any identified gaps. <p><u>Operations</u></p> <p>Measures Required by Laws, Regulations, Permits, and Ordinances:</p> <ul style="list-style-type: none"> • None <p>Measures Incorporated Into the FutureGen 2.0 Project to Reduce Impacts:</p> <ul style="list-style-type: none"> • None <p>Possible Additional Measures Identified to Further Reduce Impacts:</p> <ul style="list-style-type: none"> • None

Table 4.2-1. Mitigation Measures for the Proposed FutureGen 2.0 Project

Resource	Mitigation Measures
Human Health and Safety	<p><u>Construction</u></p> <p>Measures Required by Laws, Regulations, Permits, and Ordinances:</p> <ul style="list-style-type: none"> • SOPs for the design and construction of the pipeline and injection wells that are specified by federal and state regulations would be followed, including 49 CFR 195 and the UIC regulations for Class VI injection wells. <p>Measures Incorporated Into the FutureGen 2.0 Project to Reduce Impacts:</p> <ul style="list-style-type: none"> • Comply with applicable well drilling and construction industry standards developed by the ANSI/ASSE and the API. • Incorporate BMPs related to the design and operation of the CO₂ pipeline and injection wells to reduce the potential risk to the general public, which address: (1) selection and siting of suitable geologic storage formations; (2) designing, constructing, permitting, operating, and closing injection wells; and (3) developing monitoring and verification programs. • Pipeline materials would involve use of a high strength material at low temperatures with a coating to prevent external corrosion, cathodic protection, and an abrasion-resistant coating of 40 mils under road and rail crossings and where the pipe is directionally drilled. • Industry standards would be followed for pipeline valves, fittings, and flanges (e.g. ANSI 900). • The pipeline would be buried to a depth of 4 feet, instead of the required 3 feet under 49 CFR 195, and to a depth of 5 feet in agricultural areas where required by the IDOA. These measures decrease the potential for contact with the pipeline during excavation by third-party equipment. • Pressure testing of the CO₂ pipeline would be conducted prior to project startup. • Injection well materials would include use of corrosion-resistant steel and CO₂-resistant cements. <p>Possible Additional Measures Identified to Further Reduce Impacts:</p> <ul style="list-style-type: none"> • None
	<p><u>Operations</u></p> <p>Measures Required by Laws, Regulations, Permits, and Ordinances:</p> <ul style="list-style-type: none"> • Comply with the UIC permits. <p>Measures Incorporated Into the FutureGen 2.0 Project to Reduce Impacts:</p> <ul style="list-style-type: none"> • To the extent practicable, the Alliance would locate the CO₂ pipeline no closer than 150 feet from residences, which is 100 feet further than what is federally mandated under 49 CFR 195. The additional distance would reduce the potential for exposure to a vapor plume in the event of a puncture or rupture of the pipeline. • Monitoring of the injection wells is expected to include the installation of deep vertical seismic profiling wells to track the lateral and vertical migration of the CO₂ within the target formation, pressure and temperature sensors in the injection wells and target formation, and shallow and deep monitoring wells above the primary confining layer to detect any migration before it reaches any usable aquifers. • BMPs for the injection wells are expected to include measurement of the pressure in the well and formation and a leak detection system for the well. • MLBVs would be automatic, but would have the capability of manual operation. • A SCADA system would be used to monitor the pressure, flow, and other parameters in the pipeline. <p>Possible Additional Measures Identified to Further Reduce Impacts:</p> <ul style="list-style-type: none"> • None

Table 4.2-1. Mitigation Measures for the Proposed FutureGen 2.0 Project

Resource	Mitigation Measures
Socio-economics	<u>Construction</u>
	Measures Required by Laws, Regulations, Permits, and Ordinances:
	<ul style="list-style-type: none"> • None
	Measures Incorporated into the FutureGen 2.0 Project to Reduce Impacts:
	<ul style="list-style-type: none"> • None
	Possible Additional Measures Identified to Further Reduce Impacts:
	<ul style="list-style-type: none"> • None
	<u>Operations</u>
	Measures Required by Laws, Regulations, Permits, and Ordinances:
	<ul style="list-style-type: none"> • None
Measures Incorporated into the FutureGen 2.0 Project to Reduce Impacts:	
<ul style="list-style-type: none"> • None 	
Possible Additional Measures Identified to Further Reduce Impacts:	
<ul style="list-style-type: none"> • None 	
Environmental Justice	<u>Construction</u>
	Measures Required by Laws, Regulations, Permits, and Ordinances:
	<ul style="list-style-type: none"> • None
	Measures Incorporated into the FutureGen 2.0 Project to Reduce Impacts:
	<ul style="list-style-type: none"> • None
	Possible Additional Measures Identified to Further Reduce Impacts:
	<ul style="list-style-type: none"> • None
	<u>Operations</u>
	Measures Required by Laws, Regulations, Permits, and Ordinances:
	<ul style="list-style-type: none"> • None
Measures Incorporated into the FutureGen 2.0 Project to Reduce Impacts:	
<ul style="list-style-type: none"> • None 	
Possible Additional Measures Identified to Further Reduce Impacts:	
<ul style="list-style-type: none"> • None 	

ANSI = American National Standards Institute; AoR = Area of Review; API = American Petroleum Institute; ASSE = American Society of Safety Engineers; BMP = best management practice; CFR = Code of Federal Regulations; CO₂ = carbon dioxide; CWA = Clean Water Act; DOE = U.S. Department of Energy; DOT = U.S. Department of Transportation; GHG = greenhouse gas; IAC = Illinois Administrative Code; IDOT = Illinois Department of Transportation; IDNR = Illinois Department of Natural Resources; IDOA = Illinois Department of Agriculture; IEPA = Illinois Environmental Protection Agency; ILCS = Illinois Compiled Statutes; MBTA = Migratory Bird Treaty Act; MLBV = mainline block valve; MVA = monitoring, verification, and accounting; NHPA = National Historic Preservation Act; NETL = National Energy Technology Laboratory; NPDES = National Pollutant Discharge Elimination System; NRCS = Natural Resource Conservation Service; NWI = National Wetland Inventory; RCRA = Resource Conservation Recovery Act; ROW = right-of-way; SCADA = supervisory control and data acquisition; SHPO = State Historic Preservation Office; SOP = standard operating procedure; SPCC = Spill Prevention, Control, and Countermeasures; SWPPP = Stormwater Pollution Prevention Plan; UIC = Underground Injection Control; U.S. = United States; USACE = U.S. Army Corps of Engineers; USDA = U.S. Department of Agriculture; USDW = underground source of drinking water; USEPA = U.S. Environmental Protection Agency; USFWS = U.S. Fish and Wildlife Service

INTENTIONALLY LEFT BLANK

4.3 POTENTIAL CUMULATIVE IMPACTS

4.3.1 Background

Compliance with NEPA requires an analysis of cumulative impacts for each alternative (40 CFR 1508.25(c)(3)). Cumulative impacts are the collective result of the incremental impacts of an action that, when added to the impacts of other past, present, and reasonably foreseeable future actions, would affect the same resources, regardless of what agency or person undertakes those actions (40 CFR 1508.7). Cumulative impacts can result from actions that have individually minor impacts but that collectively impose significant impacts over a period of time. DOE considers a reasonably foreseeable action to be a future action that has a realistic expectation of occurring. These include, but are not limited to, actions under analysis by a regulatory agency, proposals being considered by state or local planners, plans that have begun implementation, or future actions that have been funded.

Humans have been altering the area in which the FutureGen 2.0 Project would be constructed and operated since people began settling the region more than 7,000 years ago (Illinois State Museum 2012). In combination with natural processes, these past and ongoing activities have produced the affected environment, which is described in detail in Chapter 3 of this EIS. The impacts of the proposed project on the existing environment are also described in Chapter 3. In this section, DOE describes the potential for cumulative impacts of the project and reasonably foreseeable future actions in the region that would or could affect the same environmental resources. The following subsections describe the process DOE used to identify potential cumulative impact issues and the reasonably foreseeable future development actions potentially occurring in the area.

4.3.2 Analysis Methodology

DOE analyzed potential cumulative impacts on environmental resources within the ROIs defined for respective resource areas in Chapter 3. Depending on the resource area, the ROI consists of a human community or political boundary (e.g., a county, city, or neighborhood); an area based on typical natural resource boundaries (e.g., a watershed or defined ecological region); a resource as described on a regional, national, or global level (e.g., air quality within an AQCR); or an area of effect dependent on locations of project disturbances (e.g., the footprint of disturbance for the CO₂ pipeline ROW). Instances where the ROI was defined as an area of project disturbance in Chapter 3 also generally include areas of disturbance anticipated for the foreseeable future actions.

DOE assigned levels of importance for potential cumulative impacts on respective environmental resources by beginning with the potential impacts of the FutureGen 2.0 Project on each environmental resource, as described in Chapter 3. Cumulative impacts relate to the incremental effects of multiple actions occurring in the same ROI; therefore, DOE next considered other ongoing and foreseeable actions affecting the same ROI for each resource that would add incrementally to the potential impacts of the FutureGen 2.0 Project. Finally, DOE considered public comments received during scoping **and the public comment period**, the interests of governmental and nongovernmental organizations, and past experience with other similar proposed projects in assigning levels of importance to a resource subject. Accordingly, DOE considered the potential for cumulative impacts affecting resource subjects as high, intermediate, or low in importance, based on the criteria discussed below.

DOE considered cumulative impacts affecting a resource to be of **high** importance if the following occurred:

- The incremental effect of the FutureGen 2.0 Project alone as analyzed in Chapter 3 would cause a significant impact in the context of NEPA review and analysis.
- An analysis of cumulative impacts for this issue would be necessary to support a reasoned decision among the alternatives.

- Society, in general, has a history or record of being concerned about this type of cumulative impact and two or more of the factors of intermediate importance are present.

DOE considered cumulative impacts affecting a resource to be of **intermediate** importance if the following occurred:

- The incremental addition by the FutureGen 2.0 Project to the impacts of other foreseeable actions may cause a regulatory/resource threshold or physical limit (e.g., utility capacity) to be exceeded or approach an exceedance, and this effect would be significant from the viewpoint of NEPA review, federal decision-making, and public disclosure.
- There is a governmental organization or nationally recognized nongovernmental organization that has a history or record of being concerned about the potential cumulative effect.
- The cumulative effect issue was raised during the scoping process by either a governmental organization or by more than one nongovernmental entity or person, and the particular issue is not irrelevant or inconsequential in federal decision-making.
- The issue is indicated to be important judging by the fact that one or more governmental or nongovernmental organizations have published statistics or trends on the issue.

DOE considered cumulative impacts affecting a resource to be of **low** importance if the following occurred:

- The potential impact does not exhibit any of the indicators listed in the two categories above.
- The FutureGen 2.0 Project would contribute no impacts, negligible impacts, or would result only in beneficial impacts.

By applying the above criteria to the environmental resources analyzed in Chapter 3, and considering the potential impacts of the FutureGen 2.0 Project as described therein, DOE assigned the levels of importance to resource subjects as listed in Table 4.3-1.

Table 4.3-1. Levels of Importance of the Potential for Cumulative Impacts by Resource

Environmental Resource	Level of Importance	Principal Basis for Level of Importance
Air Quality	Intermediate	Government and nongovernmental organizations have a history of concern about potential cumulative effects of air emissions and have published statistics and identified trends on the issue.
Climate and Greenhouse Gases	High	An analysis of cumulative impacts would be necessary to support a reasoned decision for the proposed project, because effects on global climate are recognized to be cumulative in nature.
Physiography and Soils	Intermediate	Government and nongovernmental organizations have a history of concern about potential cumulative effects on prime farmland soils in the region.
Geology	High	An analysis of cumulative impacts would be necessary to support a reasoned decision for the proposed project, because cumulative effects of geologic CO ₂ storage from multiple sources in the same geologic formation have regional implications and the public has a history of concern about the issue.
Groundwater	Intermediate	The cumulative effects of geologic CO ₂ storage on groundwater aquifers were raised by governmental and nongovernmental organizations during the scoping process, and the issue is not inconsequential to the DOE decision.

Table 4.3-1. Levels of Importance of the Potential for Cumulative Impacts by Resource

Environmental Resource	Level of Importance	Principal Basis for Level of Importance
Surface Water	Intermediate	Government and nongovernmental organizations have a history of concern about potential cumulative effects on surface waters and have published statistics and identified trends on the issue.
Wetlands and Floodplains	Intermediate	Government and nongovernmental organizations have a history of concern about potential cumulative effects on wetlands and floodplains and have published statistics and identified trends on the issue.
Biological Resources	Intermediate	Government and nongovernmental organizations have a history of concern about potential cumulative effects on biological resources, especially listed species.
Cultural Resources	Intermediate	Government and nongovernmental organizations have a history of concern about potential cumulative effects on historic, archaeological, and architectural resources.
Land Use	Intermediate	Government and nongovernmental organizations have a history of concern about potential cumulative effects on land use and regional planning.
Aesthetics	Intermediate	Government and nongovernmental organizations have a history of concern about potential cumulative effects on regional aesthetics.
Materials and Waste Management	Intermediate	Government and nongovernmental organizations have a history of concern about potential cumulative effects on material suppliers and waste disposal facilities. The FutureGen 2.0 Project would incrementally add substantial quantities of solid wastes to regional generation rates.
Traffic and Transportation	Intermediate	The incremental additions by the FutureGen 2.0 Project to the impacts of other foreseeable actions may affect traffic capacity on local roadways.
Noise and Vibration	Intermediate	Government and nongovernmental organizations have a history of concern about potential cumulative effects from noise and vibration.
Utilities	Low	The FutureGen 2.0 Project would contribute negligible impacts incrementally to the effects on utility systems and providers.
Community Services	Low	The FutureGen 2.0 Project would contribute negligible impacts incrementally to the effects on community services.
Human Health and Safety	Intermediate	The cumulative effects of CO ₂ transport and geologic storage on human health and safety were raised by governmental and nongovernmental organizations during the scoping process, and the issue is not inconsequential to the DOE decision.
Socioeconomics	Low	The FutureGen 2.0 Project would contribute net beneficial impacts to the effects on socioeconomic conditions.
Environmental Justice	Low	The FutureGen 2.0 Project would not have a disproportionate adverse effect on minority and low-income populations and would not contribute incrementally to environmental justice impacts.

CO₂ = carbon dioxide; DOE = U.S. Department of Energy

DOE focused the cumulative impacts analysis for the FutureGen 2.0 Project in this EIS on the resources considered as having high or intermediate potential for cumulative effects in Table 4.3-1. These resources and potential impacts are described further in Section 4.3.4. The two environmental resources considered to have a high potential for cumulative impacts, Climate and GHGs and Geology, are discussed in greater detail at the end of that section.

DOE considered the following four environmental resources as having a **low** potential for cumulative impacts:

- Utilities
- Community Services
- Socioeconomics
- Environmental Justice

In the case of each of these resources, the low potential for cumulative impacts is based on the negligible to beneficial impacts caused by the FutureGen 2.0 Project, which would result in no substantive incremental effects when added to the impacts of ongoing and foreseeable future actions. As cumulative impacts are not expected for these four resources identified as having a low level of importance, they are not discussed further in the cumulative impact analysis for this EIS.

4.3.3 Foreseeable Future Actions Considered

For this cumulative impacts analysis, the predicted environmental effects of specific actions were considered together with those of the FutureGen 2.0 Project to produce a description of the combined or cumulative environmental impacts. To identify specific actions that might impose cumulative environmental effects in the region, DOE sought information on specific projects, developments, or activities, which might have effects on environmental resources that would overlap with those of the FutureGen 2.0 Project. This effort included a search for electric power projects, CO₂ geologic storage projects, large industrial facilities, transportation projects, large commercial developments, municipal projects, and other such projects in the Morgan County area. DOE focused primarily on actions within a 30-mile radius of FutureGen 2.0 Project components, while also considering the ROI established for each respective resource area. DOE also searched for foreseeable future energy-related projects beyond this radius that could have a potential cumulative impact on air quality, climate and GHGs, and geology. Seven reasonably foreseeable projects were identified as described in Table 4.3-2.

Table 4.3-2. Reasonably Foreseeable Future Actions Considered

Action	Location	Distance to Project Feature	Description	Available Documentation
Illinois Rivers Transmission Project	Meredosia, IL	On Meredosia Energy Center property Within 10 miles of CO ₂ pipeline and injection wells (estimated)	Ameren Transmission Company is proposing to construct a 330-mile, 345-kV transmission line that would extend from Palmyra, Missouri, to the border with Indiana by Terre Haute. Although the route for the transmission line has not yet been finalized, negotiations are currently underway with Ameren Transmission Company for the purchase of land for the Illinois Rivers Transmission Project adjacent to the southern border of the land currently reserved for the FutureGen 2.0 Project. This area encompasses approximately 50 acres.	http://www.ilriverstransmission.com/
Truck Unloading Facility	Meredosia, IL	On Meredosia Energy Center property	Recently, the existing fuel oil terminal at the Meredosia Energy Center was sold to Sunrise Ag Energy, LLC, a private third-party entity. This sale included the fuel oil storage tanks, the current unloading facility, and the pipeline connecting these two features, as well as a parcel of land directly south of the fuel oil storage tanks. The land south of the tanks includes the meadow located south of the ash haul road between the closed fly ash pond to the west and the wooded area to the east. The new ownership plans to construct a new truck unloading facility on the parcel of land south of the storage tanks. Fuel would be transported to the tanks by river vessels and would then be distributed from the tanks to trucks. The trucks would traverse between the chemical plant and the energy center; not through the energy center property.	
Illinois Route 104 Bridge Replacement	Meredosia, IL	Less than 1 mile (from Meredosia Energy Center)	The purpose of this project is to replace a structurally deficient bridge (Illinois Route 104 bridge) over the Illinois River in Meredosia. The alternative selected (Alternative #3) would include constructing a new bridge approximately 255 feet north of the existing bridge. The existing bridge is situated approximately 0.5 mile north of the proposed oxy-combustion facility. Construction is anticipated to begin in spring 2015.	http://www.meredosiaillinoisriverbridge.com/Home_welcome.aspx and http://www.meredosiaillinoisriverbridge.com/page_include/EnvironmentalDocs.htm

Table 4.3-2. Reasonably Foreseeable Future Actions Considered

Action	Location	Distance to Project Feature	Description	Available Documentation
US-67 Improvements	Meredosia, IL area	3 miles (from Meredosia Energy Center) Less than 1 mile (from CO ₂ pipeline)	The purpose of this project is to provide a modern highway from Macomb to Jacksonville and improve transportation continuity and efficiency, enhance economic stability and development, and upgrade rural access. The construction schedule is not currently available but is underway near the project area ¹ .	http://www.dot.state.il.us/desenv/rt67impact/us67_hp.html and http://www.dot.state.il.us/us67/index.html
Taylorville Energy Center	Taylorville, IL	45 miles (southeast of CO ₂ storage study area)	The purpose of the Taylorville Energy Center is to construct a 730-megawatt IGCC electric generation facility that would capture at least 50 percent of the CO ₂ stream for local geologic storage (Mt. Simon Formation) or be used in enhanced oil recovery activities at another location. The Taylorville Energy Center had an option for local CO ₂ storage near Taylorville, Illinois; however, the project has been placed on indefinite hold pending state legislative action. The Taylorville Energy Center planned to inject 2.3 million tons (2.1 million metric tons) of CO ₂ per year near the new plant.	http://energy.gov/nepa/eis-0430-taylorville-energy-center-taylorville-illinois
Midwest Geological Sequestration Consortium Phase III Large-Scale Field Test (i.e., Illinois Basin-Decatur Project)	Decatur, IL	60 miles (east of CO ₂ storage study area)	The purpose of the project is to demonstrate the ability of the Mt. Simon Formation to accept and retain approximately 1.1 million tons (1.0 million metric tons) of injected CO ₂ over a 3-year period. Construction included a CO ₂ compression/dehydration facility, one injection well, monitoring and verification wells, and associated infrastructure (pipeline, ductwork, etc.). CO ₂ is being obtained from Archer Daniels Midland's existing fuel-grade ethanol production facility. Construction is completed and CO ₂ injection began in November 2011. The CO ₂ injection rate at this location is approximately 1,100 tons per day (1,000 metric tons per day).	http://energy.gov/sites/prod/files/nepa/nepa_documents/RedDont/EA-1626-FEA-2008.pdf and http://www.netl.doe.gov/publications/press/2011/111121_co2_injection.html

¹ <http://www.gettingaroundillinois.com/gai.htm?mt=ann>

Table 4.3-2. Reasonably Foreseeable Future Actions Considered

Action	Location	Distance to Project Feature	Description	Available Documentation
Industrial Carbon Capture and Sequestration Area 1 Project	Decatur, IL	60 miles (east of CO ₂ storage study area)	The purpose of this project is to demonstrate large-scale CO ₂ sequestration (the ability of the Mt. Simon Formation to accept and retain 1.0 million tons per year (0.9 million metric tons per year) of CO ₂ injected over a period of 2.5 years) with construction of a CO ₂ compression/dehydration facility, one injection well, one monitoring well, and associated infrastructure (pipeline, etc.). This builds upon research performed for the MGSC Phase III Large-Scale Field Test (described above), increasing CO ₂ injection to a larger scale. CO ₂ would be obtained from Archer Daniels Midland's existing fuel-grade ethanol production facility. Construction has commenced with injection anticipated to begin in 2013. The injection well for this project would be located on an adjacent parcel to the injection well for the MGSC Phase III Large-Scale Field Test, and would inject CO ₂ at a rate of approximately 2,200 tons per day (2,000 metric tons per day).	http://www.adm.com/en-US/responsibility/2011CR/Pages/carbon_sequestration.aspx and http://www.netl.doe.gov/publications/ot hers/nepa/Final%20EA-%20ADM.pdf

CO₂ = carbon dioxide; IGCC = Industrial Carbon Capture and Sequestration; IL = Illinois; kV = kilovolt; MGSC = Midwest Geological Sequestration Consortium

4.3.4 Cumulative Impacts

4.3.4.1 Summary of Cumulative Impacts

DOE determined potential cumulative impacts on individual resource areas by combining the anticipated impacts of the FutureGen 2.0 Project with other foreseeable future projects, as listed in Table 4.3-2, using publicly available information on those projects. The effects of past actions are already encompassed within the affected environment as described in Chapter 3 of this EIS; however, a general description of the history of development in the region follows for the purpose of summarizing trends.

Historically, the general area of the proposed project consisted of bottomland deciduous forests and swamp forests, upland mixed oak forests, and extensive prairie grassland communities. Following European settlement, the natural land cover and vegetation communities have been considerably altered for agricultural uses with more than 75 percent of the land area currently used as cropland or pastureland. There is some oil and gas production, and some areas have been affected by extensive surface and underground coal mining; however, historical mining activity peaked about a century ago. The area contains numerous perennial streams and rivers with major waterways, such as the Illinois River, having a large influence on the surrounding landscape (Commission for Environmental Cooperation 2011). There are relatively small scattered municipalities, with Jacksonville being the largest in Morgan County, though urban land covers are not extensive in the area.

Native Americans had first settled the region and began farming nearly 7,000 years before the first European settlers began arriving in Morgan County in 1818 (the year Illinois gained statehood) (Illinois State Museum 2012). Jacksonville was established as the Morgan County seat in 1825, and the attraction of fertile Illinois soils brought settlers to the area at a fast pace. In the early 1830s, Jacksonville was the most populous municipality in the state. In the 1850s, the Jacksonville area grew considerably, primarily on the continued expansion of agricultural activities, including the production of wheat, pork, and cattle, and the expansion of railroad access, which provided means to transport local products and import from other areas of the country. During the 1900s, numerous businesses started operation in Morgan County, which were mainly associated with agricultural activities. Numerous non-agricultural manufacturing businesses were also developed in Morgan County, primarily in the Jacksonville area, such as the Eli Bridge Company, the world's oldest manufacturer of Ferris wheels and other amusement rides, and the current Pactiv, LLC manufacturing facility, which produces a number of plastic storage and waste management products (City of Jacksonville 2012d).

The overall population of Morgan County has remained relatively constant since 1900, which reflects the agrarian nature of the area. The population of the county was approximately 36,400 in 1900 and 35,500 in 2010 and has not fluctuated below 33,500 or above 37,500 during that time; the high occurred in 1910 (USCB 1994; USCB 2010e). Thus, the historic trend of land alteration from natural cover types to human altered types was likely related primarily to the rate at which agricultural lands were developed. Typically, agricultural activities involve the conversion of naturally vegetated areas to stands of monolithic crops (e.g., corn and soybeans). In the case of animal grazing in pastureland, the activities of the animals generally make areas unsuitable for typical native vegetation through directly consuming plants and trampling on and compacting soils. In addition, agricultural activities occurring near surface waters can have substantial negative effects on surface waters through nonpoint source pollution caused by use of fertilizers, herbicides, and pesticides as well as the generation of animal wastes.

Table 4.3-3 describes cumulative impacts on each resource area that DOE assigned as having high or intermediate potential for cumulative environmental impacts. The impact analyses presented in Table 4.3-3 use the same characterizations for impacts (beneficial, negligible, minor, moderate, and substantial) as defined in Section 4.1, Comparative Impacts of Alternatives. The table is followed by discussions of Climate and Greenhouse Gases as well as Geology, which are the only resource areas considered to be of high importance with respect to potential cumulative impacts.

Table 4.3-3. Summary of Cumulative Impacts

Resource Area	Pertinent Historical Information and Impacts of Past Actions	Contribution of Proposed Project (as described in Chapter 3 and summarized in Section 4.1)	Contribution of Reasonably Foreseeable Future Actions	Cumulative Impacts
Level of Importance – High				
<p>Climate and Greenhouse Gases (See Section 4.3.4.2 for further discussion)</p>	<p>GHGs in the atmosphere absorb solar energy that would be emitted back into space if they were not present, which results in the planet being warmer than it would otherwise be (known as the “greenhouse effect”). During the past century, humans have substantially added to the amount of GHGs in the atmosphere, mainly by burning fossil fuels. The added gases, primarily CO₂ and methane, increase the natural greenhouse effect and likely contribute to an increase in global average temperature and related climate changes.</p> <p>Overall, climate change would affect economic activities, people’s behavior, environmental conditions, and infrastructure globally. Potential impacts may include: rising sea levels, increases in heat waves, increases in number and intensity of extreme weather events, and increases in drought conditions and wildfires.</p>	<p>The oxy-combustion facility would result in a net decrease in GHG emissions compared to equivalent generation by a conventional coal or natural gas power plant. The capture and geologic storage of existing GHG emissions by the project would produce a beneficial cumulative effect on a national and global scale. The proposed project would reduce CO₂ emissions from the generation of 168 MWe (gross) of electric power by at least 1.2 million tons (1.1 million metric tons) per year compared to conventional coal and natural gas combustion plants without CO₂ capture and storage. This reduction would incrementally reduce the rate of GHG accumulation in the atmosphere and help to incrementally mitigate climate change related to atmospheric concentrations of GHGs. On a broader scale, successful implementation of the project may lead to widespread acceptance and deployment of oxy-combustion technology with geologic storage of CO₂, thus fostering a long-term reduction in the rate of CO₂ emissions from power plants across the United States.</p>	<p>Based on a review of environmental documents available (see Table 4.3-2), none of the reasonably foreseeable future actions would be expected to generate GHGs in significant amounts during operation. Activities related to the construction of these projects could result in a temporary increase in GHG emissions, but the amounts would be negligible compared to regional and national emissions rates. Both the Archer Daniels Midland and Taylorville Energy Center projects would reduce GHGs that would otherwise be emitted during operations.</p> <p>Overall, it is likely that GHG emissions globally will continue to increase for some time, thus exacerbating the potential for adverse climate change-related impacts. Any strategies to curtail global climate change will require a global approach to controlling GHG emissions.</p>	<p>The oxy-combustion facility would result in a net decrease in GHG emissions compared to equivalent generation by a conventional coal or natural gas power plant. Further, the successful implementation of the project may lead to widespread acceptance and deployment of oxy-combustion technology with geologic storage of CO₂, thus fostering a beneficial long-term reduction in the rate of CO₂ emissions from power plants across the United States. It is currently impossible to determine the exact nature and magnitude of the resulting effect on the global or regional climate. See Section 3.2, Climate and Greenhouse Gases, for further information.</p> <p>Other projects in the ROI that would include combustion of additional fossil fuels or other sources of GHG emissions (e.g., the Illinois Route 104 Bridge Replacement Project) would cumulatively emit additional incremental amounts of GHGs within the ROI. Compared to regional and national GHG emissions rates, cumulative impacts would be low; their effect on the regional and global climate is currently indeterminable.</p> <p>Potential climate change impacts that would affect the proposed FutureGen 2.0 Project and other</p>

Table 4.3-3. Summary of Cumulative Impacts

Resource Area	Pertinent Historical Information and Impacts of Past Actions	Contribution of Proposed Project (as described in Chapter 3 and summarized in Section 4.1)	Contribution of Reasonably Foreseeable Future Actions	Cumulative Impacts
Climate and Greenhouse Gases <i>(continued)</i>				reasonably foreseeable future actions may include water supply disruptions due to more severe and frequent drought and hazardous conditions or disruptions of construction of operational activities due to more frequent or severe weather. See Section 4.3.4.2 for further discussion.
Geology (See Section 4.3.4.3 for further discussion)	<p>The sedimentary bedrock in central and southern Illinois was formed within the Illinois Basin, which stretches from northwest Illinois to Kentucky and Tennessee. Glacial and modern alluvial deposits are draped over the bedrock formations, and create the topographic relief while providing the source material for soils. The Mt. Simon, Eau Claire, and St. Peter formations are laterally extensive bedrock formations that stretch through the Illinois Basin and are found in deep well cores throughout Illinois.</p> <p>There are three historical oil and gas fields in Morgan County: the Prentice field, which is located south of Ashland, has 25 oil and gas wells and is located approximately 1.5 miles east of the CO₂ storage study area; the Jacksonville field, located directly east of the city of Jacksonville, contains more</p>	<p>There would be negligible to minor impacts from construction to the geologic resources, primarily from displacing or moving glacial materials for cut and fill procedures.</p> <p>There would be minor impacts during operation, as 1.2 million tons (1.1 million metric tons) per year of CO₂ is injected into the Mt. Simon Formation. The presence of primary and secondary confining zones and the use of multiple monitoring and verification procedures would ensure that the CO₂ is stored safely within the injection zone formations.</p>	<p>There would be no noticeable impact to the geologic resources from the Illinois Route 104 Bridge Replacement, US-67 improvements, or the Illinois Rivers Transmission Project based on a review of associated environmental documentation (see Table 4.3-2).</p> <p>There are two geologic CO₂ storage projects located in Decatur, 60 miles east of the FutureGen 2.0 CO₂ storage study area. The MGSC Phase III Large-Scale Field Test and ICCS Area 1 would be injecting into the Mt. Simon Formation. Also, the proposed Taylorville Energy Center may include geologic CO₂ storage in the Mt. Simon Formation approximately 45 miles from the FutureGen 2.0 CO₂ storage study area. The CO₂ plumes for these projects would not overlap with the plume as modeled for the</p>	<p>Negligible cumulative impacts would be expected from construction of the proposed project and the foreseeable future actions, as most of the impacts would be related to the earthmoving needed for each and would not overlap.</p> <p>There would be minor cumulative effects on regional geology from operation of the proposed project and other CO₂ storage projects in the Illinois Basin. The respective CO₂ plumes would not interact, because they would only extend for a few miles or less at each injection well. Although the CO₂ pressure front could extend tens of miles from large-scale injection well sites in open aquifer systems (Zhou and Birkholzer 2011), pressure would decrease with distance from the injection wells, and there are no fault systems between the proposed project and Decatur or Taylorville. Capacity estimates predict that the Illinois Basin and the Mt. Simon Formation could safely accommodate 20</p>

Table 4.3-3. Summary of Cumulative Impacts

Resource Area	Pertinent Historical Information and Impacts of Past Actions	Contribution of Proposed Project (as described in Chapter 3 and summarized in Section 4.1)	Contribution of Reasonably Foreseeable Future Actions	Cumulative Impacts
Geology <i>(continued)</i>	than 75 wells and is located approximately 3 miles south of the CO ₂ storage study area; and the Waverly field natural-gas storage site in the southeast corner of Morgan County, located approximately 15 miles south of the CO ₂ storage study area.		FutureGen 2.0 Project. None of the other projects are anticipated to affect the FutureGen 2.0 Project with respect to geologic resources.	individual storage projects, each injecting 5.5 million tons (5 million metric tons) per year of CO ₂ for 50 years, which is well above the capacity of the projects described here (Zhou and Birkholzer 2011). See Section 4.3.4.3 for further discussion.
Level of Importance – Intermediate				
Air Quality	Currently, the ROI is an attainment area for all criteria pollutants. There are ambient air monitors within 50 miles of the project. Monitoring results show ambient concentrations for all criteria pollutants below the NAAQS. Therefore, by definition, the effects on air quality from all previous activities have been less than significant in this area. This includes the historical operation of the energy center.	This project would result in increased emissions of all criteria pollutants when compared to post-suspension conditions at the energy center; however, emissions would be at a much lower level when compared to historical conditions. Emissions increases resulting from construction would be temporary and would end with the construction phase. The proposed energy center emissions would not cause regional criteria pollutant concentrations to exceed the NAAQS.	Cumulative increases in concentrations of air pollutants would continue to remain below the NAAQS. No large-scale projects or proposals have been identified that would jeopardize the attainment status of the region.	The proposed project, when combined with all operations in the region, would not cause or contribute to a violation of the NAAQS or interfere with the attainment status of the region. It is further not expected that the proposed project, when combined with past, present, and reasonably foreseeable actions, would lead to an exceedance of the NAAQS or change in attainment status of the region. Therefore, cumulative effects on air quality would not be significant.
Physiography and Soils	A principal issue relating to Physiography and Soils regionally is the potential effect on prime farmland soils, which are extensive throughout Illinois. In Morgan County, the total land for farming has increased from 306,000 acres in 1997 to 321,000 acres in 2007. The average farm size also increased from 372 to 433 acres (USDA 1999; USDA	The FutureGen 2.0 Project would have minor impacts on Physiography and Soils, predominantly related to the increased potential for soil erosion and the temporary displacement of farmland during construction activities. There would also be permanent loss of farmland soil use within the fenced area of the CO ₂ injection well site(s) and other permanent surface structures (e.g.,	Based on available environmental documentation (see Table 4.3-2) all of the reasonably foreseeable future actions would cause an increased potential for erosion through soil disturbance, as earthmoving activities would be required during construction. Prime farmland soils would likely be displaced, particularly for the US-67 improvements, as	Incrementally, in combination with other ongoing and foreseeable actions, the FutureGen 2.0 Project would have a minor cumulative impact to the soil resources of the region. The amount of permanently affected prime farmland soils would be a negligible percentage of the soils in Illinois, and a very small amount of the soils in Morgan County, particularly when compared to the increase in

Table 4.3-3. Summary of Cumulative Impacts

Resource Area	Pertinent Historical Information and Impacts of Past Actions	Contribution of Proposed Project (as described in Chapter 3 and summarized in Section 4.1)	Contribution of Reasonably Foreseeable Future Actions	Cumulative Impacts
Physiography and Soils <i>(continued)</i>	2009).	access roads). In total, approximately 122 acres of soil would be permanently removed as a result of the proposed project, as summarized in Section 4.1, Comparative Impacts of Alternatives. The main impacts on Physiography and Soils would be generally confined to the areas disturbed during construction for the proposed project.	the road would be expanded from the existing structures. The impacts related to the Illinois Route 104 Bridge Replacement Project and Illinois Rivers Transmission Project would likely be lower, because the projects would be in previously disturbed areas (bridge replacement), or would only displace small footprints over the overall corridor (Illinois Rivers Transmission Project).	farmland acreage that has occurred in the county in recent decades. Most of the disturbed soils would also occur on industrial property, directly adjacent to roads, or in previously disturbed areas.
Groundwater	Groundwater use in Illinois is primarily from shallow sand and gravel aquifers, shallow bedrock aquifers, and occasionally deep (>500 feet) bedrock aquifers (ISWS 2012). Municipal users in northern Illinois withdraw groundwater from the St. Peter and Mt. Simon Formations, which have lower total dissolved solids concentrations and are located closer to the surface than in the south. In Morgan County, the majority of public and industrial groundwater use is from the Illinois River Basin aquifer, although individual users may withdraw from shallow, unconnected aquifers. The recharge capacity for the area around Meredosia is very high, because the aquifer is hydraulically connected to the Illinois River in highly permeable sand and gravel	The FutureGen 2.0 Project would have minor impacts on groundwater resources within the ROI. New and existing groundwater wells onsite would be used at low flow rates (less than 0.2 mgd) to support construction needs and would likely be supplemented by water trucked to the site from the village of Meredosia. Therefore, adverse impacts to the local aquifer, which is connected to the Illinois River, are expected to be temporary and minor. The impacts to groundwater during energy center operations would be minor, as the Meredosia Energy Center would withdraw water at lower rates compared to historical facility operations. The presence of confining zones and the use of multiple monitoring and verification procedures would ensure that the CO ₂ is stored safely within the injection zone formations and away from the	All of the projects would require some water use, mainly for employee consumption and to reduce fugitive dust emissions. It is anticipated that water would be trucked in from off the construction sites or supplied by nearby water utilities, and would not substantially impact the current groundwater capacity locally. The MGSC Phase III Large-Scale Field Test and ICCS Area 1 Project, as well as the potential Taylorville Energy Center, would also be injecting CO ₂ into the Mt. Simon Formation subject to the same UIC permitting process intended to protect potable groundwater resources as applicable to the proposed project.	There would be minor cumulative impacts to groundwater resources from constructing the proposed project in combination with other reasonably foreseeable future actions. Both the FutureGen 2.0 Project and the Illinois Route 104 Bridge Replacement Project would obtain water locally in the Meredosia area during construction, but the combined requirements would not substantially affect local groundwater capacity. Other construction projects would likely require trucking in groundwater from available sources, which would occur at different times and not impose substantial overlapping demands. There would be negligible cumulative impacts to groundwater from the operations of the proposed project and the other planned or potential CO ₂ storage

Table 4.3-3. Summary of Cumulative Impacts

Resource Area	Pertinent Historical Information and Impacts of Past Actions	Contribution of Proposed Project (as described in Chapter 3 and summarized in Section 4.1)	Contribution of Reasonably Foreseeable Future Actions	Cumulative Impacts
Groundwater (continued)	deposits (IEPA 2011c). In Morgan County, the Mt. Simon aquifer is not a USDW because it has total dissolved solids concentrations of 48,000 milligrams/liter. The St. Peter aquifer is a federally defined USDW because it has total dissolved solids concentrations less than 10,000 milligrams/liter; however, it is not considered as a source for potable water in the county.	deepest USDW; therefore, no impacts to groundwater from the operation of the CO ₂ injection wells would occur.		<p>projects in Decatur and Taylorville. The CO₂ plume for FutureGen 2.0 would not overlap with the plumes of other projects based on modeling results.</p> <p>The shallow groundwater aquifers are not directly connected, so any near-surface contamination from material spills during construction or operation would not add incrementally to the impacts at other project sites.</p>
Surface Water	The Lower Illinois River Basin, within which the project components are located and which serves as the ROI for the project, encompasses nearly 18,000 square miles. More than 85 percent of the land use within the Lower Illinois River Basin is agricultural. The most common surface water quality problems include excess sedimentation and nutrients from farming impacts as well as toxic chemicals and low dissolved oxygen resulting from urban stormwater and treated sewage discharges.	Minor impacts from the proposed project may result in increased sedimentation (turbidity) of surface water features resulting from soil erosion during earth-moving activities associated with construction. These impacts would be mitigated through the use of best management practices and adherence to permit conditions, as applicable. Horizontal directional or jack and bore drilling would be utilized for perennial streams and certain intermittent streams (those with flowing or standing water at the time of construction) encountered during the CO ₂ pipeline installation, which would minimize impacts and disturbance of these features. Trenching would occur within ephemeral and intermittent stream channels encountered during installation of the CO ₂ pipeline which are seasonally dry at the time of construction. Such features would	<p>Development of the Illinois Route 104 Bridge Replacement Project would cause minor construction impacts, including soil erosion and increased sedimentation. Demolition of the current bridge, depending on the method used, could result in minor to significant short-term impacts to water quality through the introduction and removal of debris.</p> <p>The US-67 improvements would require four to six surface water crossings within the ROI. The crossings would result in minor impacts occurring during construction, operation, and maintenance. Impacts include soil erosion and sedimentation; loss of streambanks through culverts; increased stormwater runoff via increased impervious surfaces; salt and sand spray and runoff during snow and ice</p>	<p>The addition of the FutureGen 2.0 Project in combination with current and reasonably foreseeable future projects would not result in any substantial cumulative impacts to surface water quality.</p> <p>Minor, short-term cumulative adverse impacts would be expected for surface water quality during construction and operation of the reasonably foreseeable future actions and the FutureGen 2.0 Project due to increased sedimentation (turbidity) of surface water features resulting from soil erosion during earth-moving activities associated with construction and from stormwater discharges associated with operations. These impacts would be mitigated to the extent possible through the use of best management practices and adherence to permit conditions, as applicable.</p>

Table 4.3-3. Summary of Cumulative Impacts

Resource Area	Pertinent Historical Information and Impacts of Past Actions	Contribution of Proposed Project (as described in Chapter 3 and summarized in Section 4.1)	Contribution of Reasonably Foreseeable Future Actions	Cumulative Impacts
<p>Surface Water <i>(continued)</i></p>		<p>be restored to their original conditions after construction; therefore, impacts would be minor and temporary.</p> <p>Similarly, only minor impacts to surface water would be expected during operations and would include water quality impacts to local streams from stormwater runoff generated at these facilities. Adequately designed stormwater collection and distribution systems and pollution prevention measures would reduce or eliminate the potential for these operational impacts to surface water resources.</p>	<p>removal.</p> <p>The Illinois Rivers Transmission Project would consist of a linear power transmission line installation across the ROI; however, very minor impacts to surface water are anticipated. The utility lines would be overhead design and tower construction footprints would be small and selective. The spacing and variability of tower placement would allow surface water features to be avoided. The clearing and maintenance of vegetation along the route should have negligible impacts on surface water features. Construction equipment may result in negligible to minor temporary impacts to surface waters through sedimentation and erosion.</p> <p>None of the other projects are expected to interact with the FutureGen 2.0 Project with respect to surface water impacts.</p>	<p>None of the foreseeable actions in combination with the FutureGen 2.0 Project are expected to have long-term cumulative adverse impacts on surface waters greater than those described in Chapter 3.</p>
<p>Wetlands and Floodplains</p>	<p>Prior to European settlement, it is estimated that wetlands covered more than 8 million acres of Illinois, of which approximately 10 percent remain (Suloway and Hubbell 1994). Throughout the conterminous United States, the rate of wetland loss has declined in recent decades. In</p>	<p>As a result of the FutureGen 2.0 Project, no wetlands would be directly altered or filled at the Meredosia Energy Center or within the CO₂ storage study area. For the CO₂ pipeline, the southern route could impact up to 0.03 acre of agricultural wetlands (likely non-jurisdictional), while the northern route operational</p>	<p>Based on available environmental documentation (see Table 4.3-2) development of the US-67 improvements would cause approximately 32 acres of wetland loss (IDOT 2002). Development of the Illinois Route 104 Bridge Replacement Project would cause approximately 4 acres of</p>	<p>Development of the US-67 improvements and the Illinois Route 104 Bridge Replacement Project would cause a relatively small amount of wetland loss. The FutureGen 2.0 Project would not be expected to contribute to wetland loss in the area.</p> <p>The US-67 improvements, Illinois</p>

Table 4.3-3. Summary of Cumulative Impacts

Resource Area	Pertinent Historical Information and Impacts of Past Actions	Contribution of Proposed Project (as described in Chapter 3 and summarized in Section 4.1)	Contribution of Reasonably Foreseeable Future Actions	Cumulative Impacts
<p>Wetlands and Floodplains <i>(continued)</i></p>	<p>the time period of 2004 – 2009, the overall area of freshwater wetlands increased, though different wetland types experienced different results (e.g., gains in ponds and continued loss of forested wetlands) (Dahl 2011).</p> <p>Following European settlement in Illinois, waterways served as the focal point of growth and commerce; consequently, in many areas, homes, buildings, businesses, and entire communities have been developed in floodplains. Currently, it is estimated that, in Illinois, over 250,000 buildings are located in floodplains. This development has the effect of increasing flood hazards for people and property in those floodplains as well as increasing flood hazards in other areas (IDNR 2006).</p>	<p>ROW contains 0.2 acre of open water wetland. Jurisdictional wetlands (with the exception of seasonally-dry ephemeral and intermittent streams as discussed in Section 3.6, Surface Water) would not be disturbed by the project through the use of trenchless technology; therefore, no direct impacts would be expected. In dry streambeds where trenching does occur, impacts would be minor and temporary, as such features would be restored to their original conditions after pipeline installation.</p> <p>Negligible long-term impacts to floodplains would be expected, as no structures would be located within floodplains. Some areas of impervious surfaces may be developed in floodplains at the Meredosia Energy Center, which could cause a negligible adverse impact by reducing the flood storage capacity of the area.</p> <p>During construction, the periodic presence of moored barges during materials unloading may represent very short-term obstructions to normal flood flows if a flooding event were to occur; however, it is assumed that materials deliveries would not occur during such an event.</p>	<p>wetland loss (IDOT 2011).</p> <p>Development of the US-67 improvements would include crossing a number of floodplains including those associated with the Illinois River; no significant adverse impacts would occur due to use of design measures to provide adequate waterway openings (IDOT 2002). Development of the Illinois Route 104 Bridge Replacement Project would cause a minimal increase in flood heights; however, this would not result in significant adverse impacts on flood hazards (IDOT 2011).</p> <p>None of the other projects are expected to interact with the FutureGen 2.0 Project with respect to wetland and floodplain impacts.</p>	<p>Route 104 Bridge Replacement Project, and the FutureGen 2.0 Project may have some effect on floodplains of the Illinois River; however, the FutureGen 2.0 Project would not be expected to cause any long-term impacts.</p> <p>The FutureGen 2.0 Project would not add incrementally to potential impacts on wetlands and floodplains. Required permitting for impacts on flood hazards would greatly minimize the potential for any significant flood hazard impacts to occur as a result of any future floodplain development in the area.</p>

Table 4.3-3. Summary of Cumulative Impacts

Resource Area	Pertinent Historical Information and Impacts of Past Actions	Contribution of Proposed Project (as described in Chapter 3 and summarized in Section 4.1)	Contribution of Reasonably Foreseeable Future Actions	Cumulative Impacts
Biological Resources	<p>Prior to European settlement, the land cover in the Morgan County area consisted primarily of forest and prairie terrestrial vegetated habitats. A relatively small amount of land cover consisted of open water, predominantly in the major river systems. Since European settlement, the vast majority of pre-existing terrestrial habitats have been converted to agricultural use. Currently, the terrestrial landscape is dominated by cropland, with relatively much smaller areas of grassland and forest. The overall area of open water has reduced slightly since pre-settlement times, though human modification of some major features (e.g., damming) has altered their characteristics considerably (IDNR 2001).</p>	<p>The FutureGen 2.0 Project would have minor impacts on Biological Resources based on the fact that no protected species are anticipated to be affected on the Meredosia Energy Center property. Also, surveys for protected species would be performed in areas that would potentially be disturbed along the CO₂ pipeline route and coordination with the USFWS and IDNR would be conducted to ensure that potential impacts would be avoided or appropriately mitigated. The loss of potential wildlife habitat would be relatively small as summarized in Section 4.1, Comparative Impacts of Alternatives. The main impacts on Biological Resources would be generally confined to the areas disturbed during construction for the proposed project.</p>	<p>Based on available environmental documentation (see Table 4.3-2) development of the US-67 improvements would cause a loss of approximately 340 acres of natural habitats (e.g., forest and grassland). Potential impacts to decurrent false aster, Patterson's bindweed (<i>Stylisma pickeringii</i>), and Illinois chorus frog are possible, though impacts would ultimately be avoided or mitigated (IDOT 2002).</p> <p>Development of the Illinois Route 104 Bridge Replacement Project would cause a loss of approximately 7 acres of forested habitat. No impacts to protected species would be expected; a survey for Illinois chorus frog showed none present in potential disturbance areas. A portion of the Meredosia National Wildlife Refuge would be crossed by the bridge; however, USFWS has agreed to a land exchange to mitigate the loss of land (IDOT 2011).</p> <p>None of the other projects are expected to interact with the FutureGen 2.0 Project with respect to biological resources impacts.</p>	<p>Development of the US-67 improvements and the Illinois Route 104 Bridge Replacement project would involve the loss of natural terrestrial wildlife habitat and, potentially, small degrees of aquatic habitat degradation causing minor impacts of vegetation loss and associated animal habitat loss/degradation. The FutureGen 2.0 Project contribution would be minor and would not cause substantial cumulative impacts.</p> <p>Development of the US-67 improvements has the potential to impact protected species; however, consultation with regulators and conservation planning has been performed, thus, no impacts to protected species populations would be expected.</p> <p>The FutureGen 2.0 Project is in the process of consultation and conservation planning, and it is expected that, if necessary, any potential impacts would be mitigated to acceptable levels. No adverse impacts on protected species populations would occur.</p> <p>Any cumulative adverse impacts are anticipated to be minor.</p>

Table 4.3-3. Summary of Cumulative Impacts

Resource Area	Pertinent Historical Information and Impacts of Past Actions	Contribution of Proposed Project (as described in Chapter 3 and summarized in Section 4.1)	Contribution of Reasonably Foreseeable Future Actions	Cumulative Impacts
Cultural Resources	Historically, the quality and quantity of cultural resources in the ROI has been diminished by land development.	The FutureGen 2.0 Project would result in the disturbance of previously undisturbed land along the pipeline corridor and in the CO ₂ storage study area. Surveys would be conducted prior to construction activities. Appropriate mitigation (avoidance or recovery) would be implemented. The Meredosia Energy Center is a previously disturbed site and it is not anticipated that cultural resources would be present.	Each of the reasonably foreseeable future actions may cause some degree of cultural resource disturbance. Thus, minor cumulative impacts would be expected on cultural resources.	Based on the project's planned mitigation and implementation of a Programmatic Agreement, a low likelihood of cumulative adverse effects to cultural resources is expected.
Land Use	Land use in Morgan County is largely agricultural and rural, which is consistent with much of the state of Illinois. The Meredosia Energy Center is located in an industrial area south of the village of Meredosia. The industrial development has been present for the past century. The proposed CO ₂ pipeline and injection wells would be located in northern Morgan County, which has traditionally been dominated by agricultural land use.	Construction and operation of the oxy-combustion facility would cause short-term minor impacts and negligible long-term impacts since construction would be consistent with the industrial nature of the Meredosia Energy Center. Temporary, minor impacts would occur due to the short-term change in land use during the construction phase. Such land would be restored to its original state after construction. Permanent, minor impacts would occur due to conversion of land use, such as vegetated land, for portions of the pipeline ROW and the CO ₂ injection wells and associated surface facilities.	A portion (approximately 3.75 miles) of Alternative E of the US-67 improvements project would require the same stretch of existing ROW on US-67 as the FutureGen 2.0 Project southern pipeline route. Additionally, there would be a possibility for induced development as increased travel along the expanded highway could lead to further commercial and retail development. The Illinois Route 104 River Bridge Replacement Project would realign a portion of Illinois Route 104 on the east side of the river away from Meredosia's downtown area approximately one-half block to the north. The Illinois Rivers Transmission Project would construct a	Improvements to a portion of US-67 commenced on June 17, 2011, and are planned to be completed by the end of 2013. The FutureGen 2.0 Project is anticipated to begin construction in 2014, so it is unlikely that both project schedules would coincide and require construction in the same ROW along US-67 at the same time. The FutureGen 2.0 Project would not contribute incrementally to any induced development along the highway attributable to the US-67 improvement project. Most of the Illinois Route 104 bridge alignment would stay within its existing corridor but a portion will change land use from residential and commercial to transportation use. The new alignment would also convert some agricultural land adjacent to the existing roadway to transportation use. The land area affected by the

Table 4.3-3. Summary of Cumulative Impacts

Resource Area	Pertinent Historical Information and Impacts of Past Actions	Contribution of Proposed Project (as described in Chapter 3 and summarized in Section 4.1)	Contribution of Reasonably Foreseeable Future Actions	Cumulative Impacts
Land Use <i>(continued)</i>			<p>330-mile transmission line that would likely cross the Illinois River at Meredosia and involve portions of land in Morgan County.</p> <p>None of the other projects are expected to interact with the FutureGen 2.0 Project with respect to land use impacts.</p>	<p>Illinois 104 Bridge Replacement Project is not within the project area for the FutureGen 2.0 Project, but is within Morgan County. The FutureGen 2.0 Project would not contribute incrementally to cumulative impacts on land use conversions and compatibility with surrounding land uses.</p> <p>Both the Illinois Rivers Transmission Project and the FutureGen 2.0 Project would require acquisition of easements for the transmission lines and CO₂ pipeline, respectively. Therefore, it is likely that some land within Morgan County would subject to ROW easements as a result of both projects, which would cause a minor cumulative effect on land use. In areas where a transmission line or pipeline would be constructed on agricultural land, the Illinois Department of Agricultural guidelines would be followed, and cumulative effects on compatibility with surrounding land uses would be minor.</p>
Aesthetics	<p>Construction of the Meredosia Energy Center began in 1941. The 526-foot-tall chimney stack was built in 1979. Other industrial structures have been constructed and operated in the village for the past century.</p> <p>Northern Morgan County has traditionally been farmland or open land with few residences</p>	<p>During construction, temporary minor adverse impacts would occur from increased visibility of construction activities to nearby sensitive receptors, as well as from fugitive dust, transportation, and noise. Temporary moderate impacts would occur as a result of drilling of the injection wells on a 24-hour per day, 7-day per week</p>	<p>Construction of the Illinois Route 104 Bridge Replacement could result in adverse aesthetic impacts to residences in the village of Meredosia as a result of increased visibility of construction activity and traffic.</p> <p>Although a specific route has not been determined, siting and construction of the Illinois</p>	<p>Moderate cumulative impacts to the local viewshed could occur to sensitive receptors in Meredosia as a result of increased visibility of large construction equipment and processes during the construction of the FutureGen 2.0 Project and the replacement of the Illinois 104 Meredosia Bridge. These include the combined nuisance effects of</p>

Table 4.3-3. Summary of Cumulative Impacts

Resource Area	Pertinent Historical Information and Impacts of Past Actions	Contribution of Proposed Project (as described in Chapter 3 and summarized in Section 4.1)	Contribution of Reasonably Foreseeable Future Actions	Cumulative Impacts
<p>Aesthetics <i>(continued)</i></p>	<p>or structures. There are no designated scenic vistas in any part of the proposed project area.</p>	<p>basis, which would require lighting during the overnight hours. During operation, minor impacts would occur from the introduction of a new 450-foot stack to the viewshed, as well as the associated steam plume. Minor impacts to the viewshed would occur from new utility lines constructed to the injection well site(s), as well as from the introduction of the new surface facilities at the injection wells.</p>	<p>Rivers Transmission Project could result in adverse impacts due to increased visibility of surface structures (i.e., utility infrastructure) in a typically rural, flat portion of Morgan County. None of the other projects are expected to interact with the FutureGen 2.0 Project with respect to aesthetics impacts.</p>	<p>traffic congestion, dust generation during construction, and overnight lighting, as well as the introduction of new, permanent infrastructure to the viewshed (stack, bridge, and overhead utilities). The Illinois Rivers Transmission Project could result in minor cumulative impacts as a result of increased visibility of utility infrastructure in typically flat areas when combined with the visual impacts from the utility infrastructure that would be constructed under the FutureGen 2.0 Project.</p>
<p>Materials and Waste Management</p>	<p>In general, construction and process materials used in energy generation have been common and relatively easy to acquire for years. Landfills and other waste disposal facilities in the area of the project have had sufficient past disposal capacities to meet increasing waste disposal needs that generally coincide with historic land development trends. Coal has been mined commercially within the United States, including within the states of Illinois and Wyoming, for many years, and the available reserves are considered abundant to serve the foreseeable energy needs of the nation. The impacts of coal mining are well-known and</p>	<p>The FutureGen 2.0 Project would obtain coal from existing commercial mines in Illinois and the Powder River Basin (Wyoming), which have adequate capacity to meet the needs of the project without requiring changes in mining operations. The operation of the oxy-combustion facility would generate approximately 200,000 tons of fly ash and bottom ash per year, over a 20-year period. The Alliance would seek opportunities for beneficial reuse of the ash, including recycling; however, any ash that cannot be beneficially reused would be disposed of in a commercial non-hazardous solid waste landfill. Disposal of the volume of ash that would be generated from the project could</p>	<p>Several of the reasonably foreseeable future actions involve construction of new facilities and infrastructure, or modifications and improvements to existing facilities and infrastructure. Therefore, it is likely that they would generate wastes that could potentially be disposed of within the ROI, and therefore, negatively impact available landfill capacity. However, these impacts would be limited to the period of construction and would not be expected to exceed landfill capacity within the ROI. Operation of the reasonably foreseeable projects would not result in the generation of hazardous or non-hazardous</p>	<p>The FutureGen 2.0 Project would add incrementally to the nationwide demands for coal but without substantially affecting the available capacities or operations at existing mines. Minor to moderate adverse cumulative impacts on regional landfill capacity could occur as a result of the proposed project and the foreseeable future projects. Generation of construction-related wastes from these projects, when combined with fly ash and bottom ash generated by the proposed project, could reduce landfill capacity available to local municipalities and businesses. These adverse impacts could be mitigated through beneficial reuse of some of the major waste streams generated by the</p>

Table 4.3-3. Summary of Cumulative Impacts

Resource Area	Pertinent Historical Information and Impacts of Past Actions	Contribution of Proposed Project (as described in Chapter 3 and summarized in Section 4.1)	Contribution of Reasonably Foreseeable Future Actions	Cumulative Impacts
Materials and Waste Management <i>(continued)</i>	documented.	<p>have potential negative impacts on landfill capacity. Given the existing disposal capacity in the ROI, the severity of these impacts is anticipated to be negligible.</p> <p>Generation of other types of waste during construction and operation would have a negligible impact on hazardous and non-hazardous waste treatment and disposal capacity in the ROI.</p>	wastes in quantities that could have an adverse impact on regional landfill capacity.	<p>proposed project.</p> <p>None of the foreseeable actions in combination with the FutureGen 2.0 Project are expected to have long-term cumulative adverse impacts on waste disposal capacity greater than those described in Chapter 3.</p>
Traffic and Transportation	<p>Overall, the development of transportation resources generally followed the historic trend of land development, particularly with respect to the increased use of motor vehicles and railways. The areas potentially affected by the project generally consist of rural land uses, including agriculture and associated rural residences.</p> <p>Historically, the Meredosia Energy Center received Illinois coal by truck with substantially higher traffic volumes than in recent years.</p>	<p>During construction, traffic would increase at the energy center, along the CO₂ pipeline corridor, and within the CO₂ storage study area due to additional construction vehicles and traffic delays near the proposed sites. These effects would be temporary in nature and would end with completion of the construction phase.</p> <p>During operations, all roadways in the area would have the capacity to accommodate the additional operational traffic generated at the energy center. The pipeline and CO₂ injection wells would not generate substantial traffic during their operation, and transportation-related effects associated with these activities would be negligible.</p> <p>Incremental changes to traffic volumes would have no appreciable effect on overall traffic in the area when compared to existing conditions.</p>	<p>There are no foreseeable future projects anticipated to generate significant volumes of traffic in the vicinity of the energy center. However, the recent purchase of the fuel oil tanks at the Meredosia Energy Center by Sunrise Ag Energy, LLC, and the plan to construct a new truck loading facility, will increase truck traffic in the vicinity. Based on the size of the facility, any increase in traffic would result in negligible impacts.</p> <p>Neither the Illinois Route 104 Bridge Replacement Project nor the US-67 improvements would have long-term significant adverse effects to traffic and transportation following completion. These infrastructure improvement projects would be expected to improve traffic conditions in the area. However, both projects would have short-term adverse</p>	<p>Cumulative impacts associated with transportation and traffic would be minor. The introduction of a temporary increase in traffic during construction would be easily accommodated by the existing road systems with only minor temporary disruptions.</p> <p>Operation of the oxy-combustion facility, the CO₂ pipeline, and the CO₂ injection wells would have minor effects as a relatively small number of commuting employees and support trucks would be added.</p> <p>No large-scale projects or proposals have been identified that, when combined with the project, would cause impacts on traffic substantially greater than those described for the proposed project in Chapter 3.</p>

Table 4.3-3. Summary of Cumulative Impacts

Resource Area	Pertinent Historical Information and Impacts of Past Actions	Contribution of Proposed Project (as described in Chapter 3 and summarized in Section 4.1)	Contribution of Reasonably Foreseeable Future Actions	Cumulative Impacts
Traffic and Transportation <i>(continued)</i>			impacts on traffic during construction.	
Noise and Vibration	<p>The historical noise environment around the Meredosia Energy Center has included industrial noises from boilers, turbines, generators, fans, and heavy truck, vehicle, railroad, and barge traffic.</p> <p>The noise environment of the region through which the pipeline would travel, as well as the CO₂ storage study area, has generally followed the historical trend of land development, particularly with respect to the increased presence and use of motor vehicles and railways. The areas potentially affected by the project generally consist of farmlands and rural residential areas.</p>	<p>Construction of the oxy-combustion facility would have negligible to minor short-term impacts from increased sound levels on sensitive receptors. Also, the operation of the facility would have negligible long-term impacts on nearby receptors.</p> <p>Construction of the CO₂ pipeline and injection and monitoring wells would have minor to moderate impacts on sensitive receptors from increased sound levels as well as potentially perceptible vibrations due to trenchless boring techniques used to install the pipeline, and drilling of the wells. Sensitive receptors near these activities would likely experience elevated noise and vibration levels temporarily.</p> <p>Operation of the oxy-combustion facility would likely result in minor increases in sound levels for sensitive receptors compared to post-2012 conditions, but with no noticeable change from historical conditions when the energy center was operational. Operation of the pipeline would create no increase in noise levels.</p>	<p>Temporary increases in noise to sensitive receptors in the vicinity would occur during construction of the reasonably foreseeable future actions, including those projects that may occur within 1 mile of the Meredosia Energy Center, such as the Illinois Rivers Transmission Project, the Illinois Route 104 Bridge Replacement Project and the US-67 improvements.</p> <p>Operational noise impacts would be associated with any increased traffic resulting from these infrastructure improvements.</p> <p>None of the other projects are expected to interact with the FutureGen 2.0 Project with respect to noise impacts.</p>	<p>Cumulative impacts associated with noise would be negligible. It is highly unlikely that any of the reasonably foreseeable future actions would occur at the same location and at the same time as the proposed project; however, if they did overlap, there would be a minor cumulative impact of increased noise temporarily during construction activities. No cumulative impact in operational noise would be anticipated.</p>

Table 4.3-3. Summary of Cumulative Impacts

Resource Area	Pertinent Historical Information and Impacts of Past Actions	Contribution of Proposed Project (as described in Chapter 3 and summarized in Section 4.1)	Contribution of Reasonably Foreseeable Future Actions	Cumulative Impacts
Human Health and Safety	<p>The Meredosia Energy Center included four units, of which three were coal-fired and one, Unit 4, was oil-fired. The units came on-line in June 1948, 1949, 1960, and 1975 (Ameren 2013). At the end of 2011, operations were suspended at the Meredosia Energy Center. Prior to suspension, the energy center employed 57 workers to operate the four units. The Alliance is in the process of acquiring Unit 4, and plans to repower this unit as an oxy-combustion facility that would produce 168 MWe of electricity, while capturing at least 90 percent of the flue gas CO₂ during steady-state operation.</p>	<p>The short-term effects on worker safety during construction and operations for the proposed project would be minor. Workers, but not the general public, could be affected by a potentially significant accident at the facility, such as an accident involving the two liquid oxygen tanks; but statistically such accidents are extremely unlikely to occur (i.e., potential to occur between once in 10,000 years and once in a million years).</p> <p>The potential for accidents involving pipeline operations is considered unlikely statistically (i.e., potential to occur between once in 100 years and once in 10,000 years). Potential impacts from injection well operations are considered to be extremely unlikely events (as defined above) and a release of CO₂ following the end of injection operations is not expected to result in ambient air concentrations above established health criteria; thus health effects to the public would not be anticipated as a result of CO₂ pipeline or injection operations.</p>	<p>The planned projects on or adjacent to the energy center property, such as the Illinois Rivers Transmission Project and the truck unloading facility, create the potential for additional workers to be affected if a serious accident were to occur at the energy center or along the pipeline close to the energy center. These facilities may also increase traffic in the area, which could affect the safety of hazardous material delivery vehicles accessing the energy center.</p> <p>None of the other projects are expected to interact with the FutureGen 2.0 Project with respect to human health and safety impacts.</p>	<p>None of the foreseeable future actions would add incrementally to the potential impacts of the FutureGen 2.0 Project to an extent that long-term cumulative adverse impacts on human health and safety would be considerably greater than those described in Chapter 3.</p>

> = less than; CO₂ = carbon dioxide; GHG = greenhouse gas; ICCS = Industrial Carbon Capture and Storage; IDNR = Illinois Department of Natural Resources; mgd = million gallons per day; MGSC = Midwest Geological Sequestration Consortium; MMT = million metric tons; MWe = megawatt electrical; NAAQS = National Ambient Air Quality Standards; ROI = region of influence; ROW = right of way; US-# = U.S. Highway; UIC = Underground Injection Control; USDW = underground source of drinking water; USFWS = U.S. Fish and Wildlife Service

4.3.4.2 Climate and Greenhouse Gases

Impacts of Greenhouse Gases on Climate

Climate is usually defined as the “average weather” of a region, or more scientifically as the statistical description of a region’s weather in terms of the means and variability of relevant parameters over periods ranging from months to thousands of years. The relevant parameters include temperature, precipitation, wind speed and direction, and dates of meteorological events such as first and last frosts, beginning and end of rainy seasons, and appearance and disappearance of pack ice.

GHGs in the atmosphere absorb energy that would otherwise radiate into space; anthropogenic (human-caused) releases of these gases could result in warming that would eventually alter global climate (IPCC 2007). Potential impacts of GHGs on climate are essentially cumulative impacts, because no single source of GHG emissions is substantial enough to affect climate independently. In addition, CO₂, the primary anthropogenic GHG, tends to mix quickly and evenly throughout the lower atmosphere; therefore, it is currently not possible to predict the effect of increases or decreases in GHG emissions from an individual source on regional or global climate.

Changes in climate are difficult to detect because of the complex variability in natural meteorological patterns over long periods of time and across broad geographical regions. There is much uncertainty regarding the extent of global climate change caused by anthropogenic GHGs and the appropriate strategies for stabilizing the concentrations of GHGs in the atmosphere. The World Meteorological Organization and United Nations Environment Programme established the Intergovernmental Panel on Climate Change to provide an objective source of information about global warming and climate change. The panel’s reports are generally considered an authoritative source of information on these issues.

According to the Intergovernmental Panel on Climate Change Fourth Assessment Report, “*Warming of the climate system is unequivocal, as is now evident from observations of increases in global average air and ocean temperatures, widespread melting of snow and ice and rising global average sea level*” (IPCC 2007). The report found that the global average surface temperature has increased by approximately 1.3°F in the last 100 years; global average sea level has risen approximately 6 inches over the same period; and cold days, cold nights, and frosts over most land areas have become less frequent during the past 50 years. The report concluded that most of the temperature increase since the middle of the 20th century “*is very likely due to the observed increase in anthropogenic [GHG] concentrations.*”

The 2007 report estimated that, at present, CO₂ accounts for approximately 77 percent of the global warming potential attributable to anthropogenic releases of GHGs, with the vast majority (74 percent) of this CO₂ coming from the combustion of fossil fuels. Although the report considers a wide range of future scenarios regarding GHG emissions, CO₂ would continue to contribute more than 70 percent of the total warming potential under all of the scenarios. The Intergovernmental Panel on Climate Change therefore believes that further warming is inevitable, but that this warming and its effects on climate could be mitigated by stabilizing the atmosphere’s concentration of CO₂ through the use of (1) “low-carbon technologies” for power production and industrial processes; (2) more efficient use of energy; and (3) management of terrestrial ecosystems to capture atmospheric CO₂ (IPCC 2007).

Environmental Impacts of Climate Change

The Intergovernmental Panel on Climate Change and the United States Global Change Research Program (formerly the U.S. Climate Change Science Program) have examined the potential environmental impacts of climate change at global, national, and regional scales. The Intergovernmental Panel on Climate Change report states that, in addition to increases in global surface temperatures, the impacts of climate change on the global environment may include:

- More frequent heat waves, droughts, and fires;
- Rising sea levels and coastal flooding;

- Melting glaciers, ice caps, and polar ice sheets;
- More severe hurricane activity and increases in frequency and intensity of severe precipitation;
- Spread of infectious diseases to new regions;
- Loss of wildlife habitats; and
- Heart and respiratory ailments from higher concentrations of ground-level ozone (IPCC 2007).

On a national scale, average surface temperatures in the United States have increased, with the last decade being the warmest in more than a century of direct observations (CCSP 2008). Potential impacts on the environment attributed to climate change observed in North America include:

- Extended periods of high fire risk and large increases in burned area;
- Increased intensity, duration, and frequency of heat waves;
- Decreased snow pack, increased winter and early spring flooding potentials, and reduced summer stream flows in the western mountains; and
- Increased stress on biological communities and habitat in coastal areas (IPCC 2007).

The United States Global Change Research Program recently reported the following impacts and trends in the Midwest region of the United States, including Illinois, associated with climate change (USGCRP 2009):

- During the summer, public health and quality of life will be negatively affected by increasing heat waves, reduced air quality, and increasing insect and waterborne diseases. In the winter, warming will have mixed impacts.
- The likely increase in precipitation in winter and spring, more heavy downpours, and greater evaporation in summer would lead to more periods of both floods and water deficits.
- While the longer growing season provides the potential for increased crop yields, increases in heat waves, floods, droughts, insects, and weeds will present increasing challenges to managing crops, livestock, and forests.
- Native species are very likely to face increasing threats from rapidly changing climate conditions, pests, diseases, and invasive species moving in from warmer regions.

Addressing Climate Change

Concern regarding the relationship between GHG emissions from anthropogenic sources and changes to climate has led to a variety of federal, state, and regional initiatives and programs aimed at reducing or controlling GHG emissions from human activities as discussed in Section 3.2, Climate and Greenhouse Gases.

Because climate change is considered a cumulative global phenomenon, it is generally accepted that any successful strategy to address climate change must rest on a global approach to controlling these emissions. In other words, imposing controls on one industry or in one country is unlikely to be an effective strategy. In addition, because GHGs remain in the atmosphere for a long time, and industrial societies will continue to use fossil fuels for at least the next 25 to 50 years, climate change cannot be avoided. As the Intergovernmental Panel on Climate Change report states: “*Societies can respond to climate change by adapting to its impacts and by reducing [GHG] emissions (mitigation), thereby reducing the rate and magnitude of change*” (IPCC 2007).

According to the Intergovernmental Panel on Climate Change, there is a wide array of adaptation options. While adaptation will be an important aspect of reducing societies' vulnerability to the impacts of climate change over the next two to three decades, "*adaptation alone is not expected to cope with all the projected effects of climate change, especially not over the long term as most impacts increase in magnitude*" (IPCC 2007). Therefore, it will also be necessary to mitigate climate change by stabilizing the concentrations of GHGs in the atmosphere. Stabilizing atmospheric concentrations will require societies to reduce their annual emissions. The stabilization concentration of a particular GHG is determined by the date that annual emissions of the gas start to decrease, the rate of decrease, and the persistence of the gas in the atmosphere. The Intergovernmental Panel on Climate Change report predicts the magnitude of climate change impacts for a range of scenarios based on different stabilization levels of GHGs. "*Responding to climate change involves an iterative risk management process that includes both mitigation and adaptation, taking into account actual and avoided climate change damages, co-benefits, sustainability, equity, and attitudes to risk*" (IPCC 2007).

Climate Change, Greenhouse Gases, and the Proposed FutureGen 2.0 Project

The capture and geological storage of GHG emissions by the FutureGen 2.0 Project would produce a beneficial cumulative effect on a national and global scale. Use of the oxy-combustion process combined with CO₂ injection and permanent underground storage would remove approximately 1.2 million tons (1.1 million metric tons) per year of CO₂ that would otherwise be emitted to the atmosphere, while producing 168 MWe of electricity. CO₂ emissions from the Meredosia Energy Center would decrease from historical levels of 1.4 million tons (1.3 million metric tons) per year or more to approximately 0.2 million tons (0.1 million metric tons) per year. Over its 20 year operational lifespan, the FutureGen 2.0 Project would remove a total of approximately 24 million tons (22 million metric tons) of CO₂ in the production of electricity from coal.

These reductions in emissions alone would not appreciably reduce global concentrations of GHG emissions. However, these emissions changes would incrementally affect (reduce) the atmosphere's concentration of GHGs, and, in combination with past and future emissions from all other sources, contribute incrementally to future change in atmospheric concentrations of GHGs. At present, there is no methodology that would allow DOE to estimate the specific effects (if any) this increment of change would produce near the project area or elsewhere. On a broader scale, successful implementation of the project may lead to widespread acceptance and deployment of oxy-combustion technology with geologic storage of CO₂, thus fostering a long-term reduction in the rate of CO₂ emissions from power plants across the United States.

4.3.4.3 Geology

The potential for cumulative impacts associated with geological resources relates to the use of the Mt. Simon Formation as a repository for injected CO₂. Besides the FutureGen 2.0 Project, there are three operational or planned CO₂ storage projects using the Mt. Simon Formation for the geologic storage of CO₂. One carbon capture project has been proposed at Taylorville, Illinois, and two projects (Illinois Basin-Decatur and Illinois Industrial Carbon Capture and Storage) are located at the Archer Daniels Midland plant in Decatur, Illinois. The Illinois Basin-Decatur project has been operating for the past year, injecting 367,000 tons (333,000 metric tons) per year as part of a 3-year injection test (NETL 2012c). The Illinois Industrial Carbon Capture and Storage project would expand the geologic CO₂ storage facility to accommodate commercial-scale carbon sequestration capacity by capturing and geologically storing 1 million tons (0.9 million metric tons) of CO₂ annually from the company's ethanol facility. The Archer Daniels Midland plant is located approximately 60 miles east of the FutureGen 2.0 CO₂ storage study area. The Taylorville Energy Center project included a plan for local CO₂ storage just north of Taylorville, Illinois; however, the project has been placed on indefinite hold pending state legislative action. The Taylorville Energy Center planned to inject 2.3 million tons (2.1 million metric tons) of CO₂ per year adjacent to the new Taylorville Energy Center which would be located approximately 45 miles southeast of the FutureGen 2.0 CO₂ storage study area.

The maximum modeled CO₂ underground plume radius for the Illinois Basin-Decatur project is projected to be approximately 2,000 feet after 100 years (DOE 2008c). The Illinois Industrial Carbon Capture and Storage project used the projected pressure front radius for the AoR (2 miles), which would include the predicted CO₂ plume radius of 5,900 feet (DOE 2008c). If the Taylorville Energy Center project were to proceed and inject CO₂, the plume was projected to occupy approximately 20 square miles. The FutureGen 2.0 Project would inject 1.2 million tons (1.1 million metric tons) of CO₂ annually, which would result in a plume size of **approximately 4,000 acres (6.25 square miles)**. DOE has estimated that the CO₂ storage capacity for the Mt. Simon Formation is approximately **12 to 165 billion tons (11 to 150 billion metric tons)** of CO₂ (NETL 2012a). Pressure studies have modeled 20 projects injecting a total of 100 million tons (91 million metric tons) per year for 50 years, in the central Illinois Basin, representing one-third of the total current emissions from large stationary CO₂ sources in the region (Zhou and Birkholzer 2011). The project sites were assumed to be approximately 30 miles apart, and the model showed that not only could the Mt. Simon Formation contain the CO₂, the pressure changes stayed within the fractional buildup thresholds deemed safe by the natural gas entities in the region thus causing no increase in potential for induced seismicity (Zhou and Birkholzer 2011).

Given the substantial spatial separation predicted for the CO₂ plumes from the FutureGen 2.0 Project and the other three CO₂ injection and storage projects, the overall seismic stability of the region, and the CO₂ storage capacity of the Mt. Simon Formation, negligible cumulative impacts would be expected.

4.4 INCOMPLETE AND UNAVAILABLE INFORMATION

Under NEPA, federal agencies must disclose incomplete or unavailable information if such information is essential to a reasoned choice among alternatives in an EIS, and must obtain that information if the overall costs of doing so are not exorbitant (40 CFR 1502.22). If the agency is unable to obtain the information because overall costs are exorbitant or because the means to obtain it are not known, the agency must do the following:

- Affirmatively disclose that such information is unavailable;
- Explain the relevance of the unavailable information;
- Summarize existing credible scientific evidence that is relevant to the agency's evaluation of significant adverse impacts on the human environment; and
- Evaluate the impacts based upon theoretical approaches or research methods generally accepted in the scientific community.

Since publication of the Draft EIS, the Alliance continued to develop its conceptual and preliminary designs for the oxy-combustion facility, CO₂ pipeline, injection well facilities for permanent geologic CO₂ storage, and educational facilities. The Final EIS reflects the changes that have been made as more information became available and has been edited throughout as appropriate to incorporate the updated information and to describe effects on the analysis of impacts. The principal changes between the Draft and Final EIS are also outlined in Table S-1 of the Summary. DOE has revised the balance of this section as appropriate to update the status of information identified as unavailable or incomplete when the Draft EIS was published.

This section discloses areas where information was unavailable or incomplete during preparation of the Draft EIS and discusses its relevance to the range of environmental impacts. **As stated above, the section has been updated to reflect the status of information at publication of the Final EIS.** The FutureGen 2.0 Project continues to be in the preliminary design phase, and certain aspects of the project are still under development or otherwise evolving. As a result, some details regarding project plans and design are in development and were incomplete and unavailable during Draft EIS preparation, **and some aspects have remained incomplete or unavailable during preparation of the Final EIS.** To account for uncertainties caused by incomplete and unavailable information, DOE developed bounding conditions and assumptions based on the most current and available data and project plans in evaluating the range of potential impacts that could occur under the proposed project, consistent with the fourth item in the bulleted list in the first paragraph above. **To the extent that information became available after publication of the Draft EIS, DOE updated and refined the analysis of impacts appropriately throughout this Final EIS. However, for cases in which uncertainties remain about project details, DOE considers that the bounding conditions analyzed in the Draft EIS appropriately reflect the upper limits of anticipated impacts.**

Project features and their relevance to the resource-level analysis presented in this **Final EIS** include:

- Oxy-Combustion Large Scale Test Design. Initial design plans and air permitting documents for the FutureGen 2.0 Project were based on a 200-MWe system. The Alliance subsequently determined that a 168-MWe capacity system would be more appropriate and **revised the design during preparation of the Draft EIS.** DOE based its analyses **in the Draft EIS** on updated project design characteristics reflecting the 168-MWe system for all the project components with the exception of the air quality analysis. Because the construction air permit application for the 168-MWe system had not yet been prepared, DOE based its air quality analysis **for the Draft EIS** on the **prior** construction air permit application for the 200-MWe system. That evaluation provided a conservative estimate, or upper bound, for potential impacts. **Since publication of the**

Draft EIS, the Alliance prepared and submitted a revised construction permit application in June 2013 for the updated design of the energy center. Accordingly, DOE updated Section 3.1, Air Quality, in the Final EIS to present estimated air emissions based on the 168-MWe design, as well as the updated analyses contained in the revised construction permit application.

- Oxy-Combustion Large Scale Test General Arrangement and Site Plan. Details related to site grading and site drainage for the FutureGen 2.0 Project at the Meredosia Energy Center were still under development when the Draft EIS was prepared. To assess the potential for physical impacts at the energy center, DOE used generalized disturbance area maps provided by the Alliance and Ameren. These maps depict boundaries within which development would occur, and thus provide a conservative, or upper bound, estimate of potential impacts. Design details beyond general location were also unavailable for the proposed stormwater management basins. DOE considered potential impacts related to this feature based on its general location, sensitive features present near that location, and measures that would be taken by the Alliance and Ameren with respect to the sensitive features. These topics are addressed in Section 3.6, Surface Water, and Section 3.7, Wetlands and Floodplains. **Based on discussion and comments from USFWS, DOE undertook measures to reduce the amount of forested land that would be cleared for the project as discussed in Section 2.4.3. Through ongoing refinements in site plans by the Alliance, the amount of forested acreage that could be lost would likely be substantially lower than the upper bound identified in the Draft EIS (i.e., 33 acres at the Meredosia Energy Center). With current site plans, the impacts could range from less than 1 acre to as many as 9 acres of forested lands as discussed in Section 3.8, Biological Resources.**
- CO₂ Pipeline Routes. The Alliance identified two potential pipeline routes to the CO₂ storage study area, the southern route (preferred) and the northern route (alternative), both within a 4-mile wide pipeline corridor. The Alliance was still in the process of planning the pipeline route as the Draft EIS was prepared, and portions of the proposed routes could be adjusted within the 4-mile corridor to avoid sensitive features or to address other constraints. Because access to the proposed pipeline ROWs was not available during Draft EIS preparation, field studies for cultural resources, sensitive biological species, and wetlands were unavailable at the time. In addition, pipeline routes within the CO₂ storage study area were not yet defined in the absence of specific injection well locations and, therefore, DOE used hypothetical routes to develop the potential range of impacts. Thus, for the Draft EIS, DOE relied on data available within the pipeline corridor and prospective ROWs and the CO₂ storage study area (e.g., federal and state mapping data) to determine the likely presence of resources and the potential range of impacts that could occur. **After extensive field work and coordination with landowners, the Illinois SHPO, IDNR, and USACE, the Alliance defined the southern pipeline route as the most likely pipeline route to the injection well location. The route was selected in consideration of landowners' interests, constructability, access to existing ROWs, and the desire to avoid sensitive environmental resources, such as wetlands, cultural resources, forest land, and threatened or endangered species and their habitats. For the Final EIS, DOE revised Section 2.5.1 to explain the selection of the southern pipeline route and updated all figures that depict the pipeline routes. DOE also updated all resource sections in the Final EIS that quantify impacts along the pipeline route.**
- CO₂ Injection and Monitoring Wells. The Alliance was in the process of preparing permit applications for the UIC Class VI injection wells during Draft EIS preparation. Because this aspect of the project was still in progress when the Draft EIS was prepared, the specific locations of the proposed injection and monitoring wells within the CO₂ storage study area were not yet identified. As a result, DOE used conceptual design data, proposed footprints, and siting criteria to assess the potential impacts given the resources present in the CO₂ storage study area. These

topics are addressed in Section 3.3, Physiography and Soils; Section 3.6, Surface Water; Section 3.7, Wetlands and Floodplains; Section 3.8, Biological Resources; Section 3.9, Cultural Resources; and Section 3.10, Land Use. **The Alliance submitted the UIC permit applications for the Class VI injection wells (March 2013, revised May 2013) while the Draft EIS was being prepared for publication, although the final siting and configuration of the injection wells must be approved by USEPA in the issuance of the UIC permits. DOE updated Section 2.5.2 in the Final EIS to incorporate the current design data, which is compared to the bounding data already presented in the Draft EIS. The Alliance also has negotiated with local landowners to acquire additional rights to subsurface pore space and ensure that the CO₂ plume would not affect subsurface rights of non-participating landowners. As a result of these efforts, the size of the CO₂ storage study area expanded to 6,800 acres, with the additional 1,500 acres located south and west of the study area boundary in the Draft EIS. Based on the latest modeling, however, the subsurface plume extent would remain as estimated in the Draft EIS (approximately 4,000 acres). Since publication of the Draft EIS, the Alliance also revised the injection well configuration from a dual-site scenario to a single-site scenario. Additional details about the injection well site configuration currently proposed by the Alliance were made available for the Final EIS as follows:**

- **The single-site scenario would require only one building to house the surface facilities. Since the dual-site scenario, which is no longer under consideration by the Alliance, would require as many as four buildings distributed between two sites, the area of disturbance for construction and operations would be larger than for the single-site scenario. Therefore, analysis in the Final EIS is bounded conservatively by the dual-site scenario (i.e., multiple-building design) as analyzed in the Draft EIS.**
- **The land area impacted by single-site scenario would be reduced in comparison to the dual-site scenario, because the Alliance would locate all injection wells and infrastructure at one location requiring less land area. Additionally, the length and acreage required for access roads would be reduced for the single-site scenario. Although impacts associated with the currently proposed single-site scenario would be less, the analysis in the Final EIS is bounded conservatively by the dual-site scenario as analyzed in the Draft EIS.**
- **Details about the monitoring well network for the single-site scenario were not available for the Draft EIS but were added to the Final EIS. Although the monitoring wells for the single-site scenario currently proposed by the Alliance would require less land area, the analysis in the Final EIS is bounded conservatively by the dual-site scenario as analyzed in the Draft EIS.**
- Educational Facilities. The Alliance had not identified the specific location of the proposed educational facilities during Draft EIS preparation; however, the general location was expected to be in the vicinity of Jacksonville, Illinois. DOE considered the Alliance's conceptual design and the siting criteria that would be used for locating the facilities in order to evaluate the range and types of potential impacts that could occur from this project component. These potential impacts are addressed in each resource section of Chapter 3 as appropriate. **Since publication of the Draft EIS, the Alliance modified its plans such that the current conceptual design assumes that the visitor, research, and training facilities would be housed in a single building, rather than two separate buildings. These changes are described in Section 2.5.3 of the Final EIS. However, since design concepts are still in development, the Final EIS evaluates impacts associated with the educational facilities based on the more conservative conceptual design in the Draft EIS for multiple educational buildings.**

As indicated above, DOE evaluated the potential range of impacts based upon the best available information for the FutureGen 2.0 Project and information on affected environment that could reasonably be obtained. In the absence of design data or specific location data for a project feature, DOE developed a range of potential impacts based on conceptual design data, siting criteria, other available project plans and commitments, and available baseline data for each resource area. DOE's analysis was conducted in order to provide a range of potential impacts, including an upper bound, so as to provide decision-makers with information that would support a reasoned choice among the alternatives. **DOE concluded that the impacts of the FutureGen 2.0 Project are appropriately described in this Final EIS and that the range of potential impacts would remain within the upper bounds defined.**

4.5 IRREVERSIBLE AND IRRETRIEVABLE COMMITMENTS

This section describes the amounts and types of resources that would be irreversibly or irretrievably committed for the FutureGen 2.0 Project. A resource commitment is considered *irreversible* when primary or secondary impacts from its use limit concurrent or future use options. Irreversible commitment applies primarily to nonrenewable resources such as minerals or cultural resources, and to those resources that are renewable only over long time spans, such as soil productivity or mature forests. A resource commitment is considered *irretrievable* when the use or consumption of the resource is neither renewable nor recoverable for use by future generations. Irretrievable commitment applies to the loss of production, harvest, or natural resources. Once consumed, the resource is no longer available for future generations.

A resource commitment is irreversible when primary or secondary impacts from its use limit concurrent or future use options and is irretrievable when its use or consumption is neither renewable nor recoverable for use by future generations.

The principal resources that would be committed by the proposed project are the lands required for the construction and operation of the proposed oxy-combustion facility, CO₂ pipeline, injection wells, and the educational facilities. Other resources that would be committed to the project include construction materials (e.g., steel and concrete), process materials (e.g., trona and **hydrated** lime), and fuels (e.g., coal and natural gas) used for construction and operations. In addition, the proposed project would commit the Mt. Simon Formation beneath Morgan County to permanent use for geologic storage of CO₂.

Surface lands would be irreversibly committed throughout the approximately 20-year operational life of the proposed project. After this time and upon future decommissioning, proposed project components could be removed and the surface lands again made available to be re-used for another purpose.

At the Meredosia Energy Center, all of the land required for the operation of the oxy-combustion facility is currently owned by Ameren and would be purchased by the Alliance. Therefore, there would be no loss of these lands, as they would be used for their current purpose. Onsite construction laydown areas would be leased for the duration of construction. The proposed CO₂ pipeline would be constructed and operated by the Alliance. Construction ROWs such as laydown areas would be leased or used pursuant to short-term easements with landowners. Operational ROWs would be acquired through long-term easements with landowners. Lands used for agricultural production could be returned to that use after completion of pipeline construction. The Alliance would purchase the land required for the injection wells and associated infrastructure and the subsurface pore space into which the CO₂ would be injected. Land required for monitoring wells would be purchased or leased by the Alliance depending on the type of monitoring well and landowner preference.

The proposed CO₂ pipeline ROW would be co-located along or within existing highway ROWs to the greatest extent practicable. For the remainder of the CO₂ pipeline ROW, temporary easements would be required during construction, and permanent easements would be maintained for the operation of the CO₂ pipeline. The CO₂ pipeline ROW would not preclude farming once construction was complete. Lands currently being used for agriculture could be returned to agricultural use with few restrictions after completion of construction. Hence, agricultural lands within the temporary and permanent easements for the CO₂ pipeline would not be considered irretrievably committed. However, the loss of agricultural use of these lands during the construction period would be an irreversible commitment.

Natural habitat would be lost primarily where the CO₂ pipeline ROWs would cross forested areas, mainly along streams and associated surface waters within the forested areas. The CO₂ pipeline ROWs would result in the removal of up to 8 acres of forested areas along the southern route and **22** acres of forested areas along the northern route during construction, which would be converted to, and maintained as, grasslands over the 20-year operational life of the proposed project. The remainder of existing forested areas removed during construction would be allowed to revert back to forest through natural succession. At the end of the project's 20-year life, the operational ROW could revert back to forest through natural

succession as well. However, the removal of forested area is considered an irreversible commitment because of the long time period required for a forest to re-establish.

The land that would be occupied by the CO₂ injection wells, associated facilities, and access roads would be irreversibly committed throughout the 20-year operational life of the project. Once CO₂ injection operations are completed, some wells and equipment at the injection well site(s) may still be used for long-term monitoring purposes. Nevertheless, after removal of surface facilities, the land could return to other productive uses.

Considerable amounts of water used to operate the FutureGen 2.0 Project would also be irreversibly committed (e.g., evaporated to the atmosphere rather than discharged back to surface or groundwater). The FutureGen 2.0 Project would use up to **3.0** mgd of process water from the Illinois River that would be committed for the 20-year operational life of the oxy-combustion facility. Approximately **13.6** mgd of water would be taken from the river and cycled through the cooling towers where some of the water would evaporate. The balance (**10.6** mgd) would be treated and returned to the Illinois River.

During operation, up to **0.1** mgd of groundwater would be used from onsite wells at the Meredosia Energy Center. Well water would be used for steam cycle demineralizer influent, coal-handling dust suppression, and potable water. Village of Meredosia water may also be used for potable water and fire protection. Because the project would not discharge any project-related water directly back to groundwater, the groundwater used would not be available for other uses. However, stormwater would be discharged to groundwater via the stormwater management basin or evaporated via the lined settling basin (refer to Section 2.4.2.2 for additional details).

Other resources that would be committed to the project include materials and energy resources used for construction and operation. Material and energy resources committed for the project would include construction materials (e.g., steel, concrete), electricity, and fuel (e.g., diesel, gasoline). All energy used during construction and operation would be irretrievable. During operation, up to **1,224** tons of bituminous coal, **816** tons of sub-bituminous coal, **187** tons of **hydrated** lime, and **8.9** tons of trona would be used on a daily basis, which would be irretrievably committed. These resources would not be available for use by future generations.

The FutureGen 2.0 Project also would consume natural gas for heating purposes during operations. Although the amount of natural gas used would be negligible in relation to regional supplies, it would be irretrievably committed. The auxiliary electric power demand to operate the oxy-combustion facility would total 69 MWe. Although the oxy-combustion facility would irretrievably consume electricity during operation, it would generate approximately 168 MWe of electricity, which would not otherwise be generated.

As described above, the project would result in irreversible (i.e., lost for a period of time) commitments of primarily renewable natural resources. The project would also result in an irretrievable (i.e., permanently lost) commitment of portions of geologic storage formations, energy, material resources, and fuel.

4.6 RELATIONSHIP BETWEEN SHORT-TERM USES OF THE ENVIRONMENT AND LONG-TERM PRODUCTIVITY

This section describes the relationship and tradeoffs between the short-term uses of the environment for the FutureGen 2.0 Project and the project's long-term benefits. Short-term uses of the environment would include the activities and associated impacts during the construction and 20-year operational lifespan of the proposed project. Potential impacts to various resources have been described throughout Chapter 3. Potential environmental impacts would include:

- Air quality impacts resulting from criteria pollutant and fugitive dust emissions, as described in Section 3.1, Air Quality;
- Erosion and sedimentation impacts on surface waters during construction, and impacts to the Illinois River and local aquifers from withdrawal of water to support operations, as described in Section 3.3, Physiography and Soils; Section 3.6, Surface Water; and Section 3.5, Groundwater;
- Vegetation and wildlife habitat impacts caused by land-clearing activities, as described in Section 3.7, Wetlands and Floodplains; and Section 3.8, Biological Resources;
- Aesthetic and land use changes affecting nearby residents, as described in Section 3.10, Land Use; and Section 3.11, Aesthetics;
- Traffic impacts during construction due to temporary detours and the movement of heavy equipment, plus increased traffic on local roadways during construction and operation, as described in Section 3.13, Traffic and Transportation; and
- Noise impacts from construction activities and operations, as described in Section 3.14, Noise and Vibration.

The FutureGen 2.0 Project would use environmental resources, consume products and energy, produce wastes and emissions, and occupy land. The project would consume resources including coal, surface water, groundwater, and natural and manufactured products during its planned 20-year operational life. The **Draft EIS estimated that the** project would use up to 285 acres of land in Morgan County, Illinois, for the operation of the oxy-combustion facility on the Meredosia Energy Center site, the permanent CO₂ pipeline ROWs, the injection and monitoring well sites, and the educational facilities. **The current design would impact less land area; however, this Final EIS maintains the values analyzed in the Draft EIS as the conservative bounding conditions.** See Chapter 2 for a discussion of the proposed project components. Upon future decommissioning of proposed project components, DOE assumes the structures could be removed and that the land could be made available for other purposes.

The project would enhance short-term productivity in the region through the direct, indirect, and induced creation of construction jobs during the construction of the oxy-combustion facility, the pipeline, injection wells, and educational facilities. In addition, the project would have a long-term beneficial impact on the local economy, employment, and tax base over its operational life as a result of the permanent jobs that would be created, plus the indirect and induced jobs created as a result of these permanent jobs (see Section 3.18, Socioeconomics).

Another long-term benefit of the project would be the achievement of lower emissions of GHGs in comparison to conventional coal-fueled power plants by capturing and geologically storing CO₂. During average annual operating conditions, the project is expected to generate **approximately 168 MWe** of electricity from coal combustion, with a near-zero emissions technology designed to capture at least 90 percent of the CO₂ that would otherwise be emitted to the atmosphere **during steady-state operation**.

On a broader scale, the widespread acceptance and employment of oxy-combustion technology with geologic storage could foster an overall long-term reduction in the rate of CO₂ emissions from power

plants across the United States, thereby reducing national GHG emissions. If the proposed project is successful, the short-term use of land, materials, water, and energy to construct and operate the project would have long-term positive impacts on reducing GHG emissions both in the United States and globally (see Section 3.2, Climate and Greenhouse Gases).

In summary, the short-term uses of the local environment do not represent substantial commitments of resources and would not cause substantial adverse impacts. In exchange for these short-term uses and associated effects, a substantial long-term benefit to the regional, national, and global environment may be achieved through the commercial-scale demonstration of technologies that can generate and distribute electricity using fossil fuels with substantially reduced GHG emissions.

5 REGULATORY AND PERMIT REQUIREMENTS

CEQ regulations for NEPA Part 1502 Section 1502.25 states that, to the fullest extent possible, agencies shall prepare draft EISs concurrently with and integrated with environmental impact analyses and related surveys and studies required by environmental review laws and EOs. It also requires a draft EIS list all federal permits, licenses, and other entitlements that must be obtained in implementing the proposed project. The following table contains relevant regulatory and permit requirements for the construction and operation of the FutureGen 2.0 Project. The table identifies relevant federal regulatory requirements considered within the EIS including federal regulations and EOs, state regulations and permitting requirements, and local regulations and permitting requirements.

Table 5-1. Relevant Regulatory and Permit Requirements for the Proposed Project

Statute, Regulation, Order	Description
Federal Regulations and Permitting	
Acid Rain Permit Program 40 Code of Federal Regulations (CFR) 72	<p>Acid Deposition Control. The purpose of this part is to establish certain general provisions and the operating permit program requirements for affected sources and affected units under the Acid Rain Program, pursuant to Title IV of the Clean Air Act (CAA), 42 U.S. Code (USC) 7401, <i>et seq.</i>, as amended by Public Law 101-549 (November 15, 1990).</p> <p>Establishes limitations on sulfur dioxide (SO₂) and nitrogen oxides (NO_x) emissions, permitting requirements, monitoring programs, reporting and record keeping requirements, and compliance plans for emissions sources. This Title requires that emissions of SO₂ from utility sources be limited to the amounts of allowances held by the sources.</p> <p>The Acid Rain permit was incorporated into the CAA Permit Program (CAAPP) permit which was appealed in its entirety upon issuance in 2005. Resolution of CAAPP permit appeal is ongoing and will result in issuance of a renewed Acid Rain Permit.</p> <p>Ameren applied for renewal of the Acid Rain Permit (Title IV of CAA) on 6/4/2008; however, Illinois Environmental Protection Agency (IEPA) at its discretion delayed renewal of the Acid Rain Permit in conjunction with CAAPP appeals.</p>
American Indian Religious Freedom Act of 1978 42 USC 1996	<p>This Act ensures the protection of sacred locations and access of Native Americans to those sacred locations and traditional resources that are integral to the practice of their religions. Although no sacred locations and traditional resources have been identified in any areas that would be affected by the FutureGen 2.0 Project, such locations or resources could be inadvertently discovered during construction activities.</p>
Bald and Golden Eagle Protection Act 16 USC 668-668d	<p>Prohibits "taking" bald or golden eagles, including their parts, nests, or eggs. The Act defines "take" as pursue, shoot, shoot at, poison, wound, kill, capture, trap, collect, molest or disturb. Prohibits the disturbance of a bald or golden eagle to a degree that causes, or is likely to cause: 1) injury to an eagle, 2) a decrease in its productivity, by substantially interfering with normal breeding, feeding, or sheltering behavior, or 3) nest abandonment, by substantially interfering with normal breeding, feeding, or sheltering behavior.</p>

Table 5-1. Relevant Regulatory and Permit Requirements for the Proposed Project

Statute, Regulation, Order	Description
<p>Chemical Accident Prevention Act 40 CFR 68 and Section 112(r) of the Clean Air Act Amendments</p>	<p>This Act requires stationary sources having more than a threshold quantity of the specific regulated toxic and flammable chemicals to develop a Risk Management Plan for submittal to the U.S. Environmental Protection Agency (USEPA), which then makes the information publicly available. The Risk Management Plan must include:</p> <ul style="list-style-type: none"> • A hazard assessment that details the potential effects of an accidental release, an accident history of the last 5 years, and an evaluation of the worst-case and alternative accidental releases; • A prevention program that includes safety precautions and maintenance, monitoring, and employee training; and • An emergency response program that spells out emergency health care, employee training measures, and procedures for informing the public and response agencies (e.g., the fire department) should an accident occur. <p>The plan must be updated and resubmitted to the agency every 5 years.</p> <p>Under the Illinois Accidental Release Prevention Program, the Alliance could be required to comply with the Chemical Accident Provisions because the energy center could have the potential to emit covered substances at levels above the accidental release threshold quantities.</p>
<p>Clean Air Act</p>	<p>The CAA authorizes the USEPA to delegate permitting, administrative, and enforcement duties to state governments, while USEPA retains oversight responsibilities. The IEPA has been delegated permitting authority under the CAA. The CAA programs and regulations that are or could be applicable to the FutureGen 2.0 Project are:</p> <ul style="list-style-type: none"> • Acid Rain Program/Permit (Title IV) • CAA Operating Permit (Title V) • Clean Air Interstate Rule (CAIR) • Compliance Assurance Monitoring Rule • Greenhouse Gas (GHG) Tailoring Rule • National Emission Standards for Hazardous Air Pollutants (NESHAPs) and Mercury and Air Toxics (MATS) (part of Title I) • New Source Performance Standards (NSPSs) (part of Title I) • Prevention of Significant Deterioration (PSD) Permit (part of Title I) • Regional Haze Rule <p>Each of these CAA requirements is addressed in this table.</p>
<p>Clean Air Act, Title V (Air Operating Permit) 40 CFR 70</p>	<p>CAA Title V provides the basis for the Operating Permit Program and establishes permit conditions, including monitoring and analysis, inspections, certification, and reporting. Authority for implementation of the permitting program is delegated to the state of Illinois.</p>

Table 5-1. Relevant Regulatory and Permit Requirements for the Proposed Project

Statute, Regulation, Order	Description
Clean Air Interstate Rule 40 CFR 96	<p>On March 10, 2005, USEPA issued the Clean Air Interstate Rule (CAIR). This rule provides states with a solution to the problem of power plant pollution that drifts from one state to another. CAIR covers 27 eastern states and the District of Columbia. The rule uses a cap and trade system to reduce the target pollutants – SO₂ and NO_x.</p> <p>A December 2008 court decision found flaws in CAIR, but kept CAIR requirements in place temporarily while directing USEPA to issue a replacement rule. On July 6, 2011, the USEPA finalized the Cross State Air Pollution Rule (CSAPR), which was intended to replace CAIR. However, on August 21, 2012, the U.S. Court of Appeals struck down the USEPA's CSAPR. As a result, CAIR remains in effect.</p>
Clean Water Act, Title IV 40 CFR 104 through 140	<p>Focuses on improving the quality of water resources by providing a comprehensive framework of standards, technical tools, and financial assistance to address the many causes of pollution and poor water quality, including municipal and industrial wastewater discharges, polluted runoff from urban and rural areas, and habitat destruction.</p> <p>Applicable Sections:</p> <ul style="list-style-type: none"> • Section 303(d) and 305(b). Section 303(d) of the Clean Water Act (CWA) requires states to identify and develop a list of impaired waterbodies where technology-based and other required controls have not provided attainment of water quality standards. Section 305(b) of the CWA requires states to assess and report the quality of their waterbodies. In 2008, Illinois combined their 303(d) and 305(b) list into one report referred to as the Integrated Report. The report identifies those waterbodies that are impaired and do not meet designated uses, and establishes total maximum daily loads for pollutants of concern. • Section 401 - Certification. Provides states with the opportunity to review and approve, condition, or deny all federal permits or licenses that might result in a discharge to state or tribal waters, including wetlands. The major federal permit subject to Section 401 review is a Section 404 permit. Every applicant for a Section 404 permit must request state certification that the proposed activity would not violate state or federal water quality standards. In Illinois, there are 26 specific nationwide permits for which a Section 401 certification has been categorically issued per the U.S. Army Corps of Engineers (USACE), including Nationwide Permit 12. • Section 402 - National Pollutant Discharge Elimination System (NPDES) Permit. Requires sources to obtain permits to discharge effluents and stormwater to surface waters. The CWA authorizes USEPA to delegate permitting, administrative, and enforcement duties to state governments, while USEPA retains oversight responsibilities. The state of Illinois has been delegated NPDES authority and therefore would issue the NPDES permit. • Section 404 <ul style="list-style-type: none"> ○ Permits for Dredged or Fill Material. Regulates the discharge of dredged or fill material in the jurisdictional wetlands and waters of the U.S. The USACE has been delegated the responsibility for authorizing these actions. ○ Nationwide Permit 12 Utility Line Activities. Authorizes the construction, maintenance, and repair of utility lines and the associated excavation, backfill, or bedding for the utility lines in all waters of the U.S. The USACE has been delegated the responsibility for authorizing these actions.

Table 5-1. Relevant Regulatory and Permit Requirements for the Proposed Project

Statute, Regulation, Order	Description
Compliance Assurance Monitoring Rule 40 CFR 64 35 Illinois Administrative Code (IAC) 201	<p>The rule applies to facilities that have emissions units located at major sources subject to Title V air quality permitting and that use control devices to achieve compliance with emissions limits. A Compliance Assurance Monitoring Plan is required as part of the initial application for a Title V Operating Permit. The rule requires that these facilities monitor the operation and maintenance of their control equipment to evaluate the performance of their control devices and report if they meet established emissions standards. If these facilities find that their control equipment is not working properly, the rule requires them to take action to correct any malfunctions and to report such instances to the appropriate enforcement agency (i.e., state and local environmental agencies).</p> <p>Six exemptions apply. The rule does not apply to emissions limitations and standards that: (1) are contained in post 1990 rules, (2) specify a continuous compliance determination method, (3) are related to stratospheric ozone requirements, (4) are included in the Acid Rain program, (5) apply solely under an emissions trading program, or (6) are included in an emissions cap that meets the requirements of 40 CFR 70.4(b)(13). Because existing standards would require continuous monitoring of NO_x, SO₂, and particulate matter (PM), compliance assurance monitoring would not apply to these pollutants. The project does not include add-on controls for carbon monoxide (CO) or for VOCs and therefore these pollutants would not be subject to compliance assurance monitoring.</p>
Compliance with Floodplain and Wetland Environmental Review Requirements. Title 10 Part 1022	<p>Establishes policy and procedures for discharging the U.S. Department of Energy's (DOE's) responsibilities under EO 11988 and EO 11990, including DOE policy regarding the consideration of floodplain and wetland factors in DOE planning and decision-making; and DOE procedures for identifying proposed projects located in a floodplain or wetland, providing opportunity for early public review of such proposed projects, preparing floodplain or wetland assessments, and issuing statements of findings for actions in a floodplain.</p>
Emergency Planning and Community Right-to-Know Act of 1986 42 USC 11001 <i>et seq.</i>	<p>Requires that inventories of specific chemicals used or stored onsite be reported on a periodic basis. The project would process or otherwise use substances subject to the Act's reporting requirements, such as sulfuric acid.</p>
Endangered Species Act 16 USC 1536 <i>et seq.</i> Enacted by Public Law 93-205, Endangered Species Act of 1973 (16 USC 1531 <i>et seq.</i>)	<p>Section 7 – Interagency Cooperation. Requires any federal agency authorizing, funding, or carrying out any action to ensure that the action is not likely to jeopardize the continued existence of any endangered species or threatened species or result in the destruction or adverse modification of critical habitat of such species. Under Section 7 of the Act, DOE has consulted with the U.S. Fish and Wildlife Service (USFWS) and the Illinois Department of Natural Resources (IDNR).</p> <p>Section 10 – Exceptions. An Incidental Take Permit allows for the taking of a species incidental to an otherwise lawful act. This permit is required when non-federal activities would result in the take of threatened or endangered species. Each permit application must be accompanied by a Habitat Conservation Plan, which ensures that the effects of the authorized incidental take are adequately minimized and mitigated. If such a permit is required, DOE would consult with the USFWS.</p>

Table 5-1. Relevant Regulatory and Permit Requirements for the Proposed Project

Statute, Regulation, Order	Description
Farmland Protection Policy Act 7 USC 4201 <i>et seq.</i> 7 CFR 658	Directs federal agencies to identify and quantify adverse impacts of federal programs on farmlands. The Act's purpose is to minimize the number of federal programs that contribute to the unnecessary and irreversible conversion of agricultural land to non-agricultural uses. In compliance with the Act and regulations promulgated pursuant to the Act, DOE has undertaken the following actions: <ul style="list-style-type: none"> • Identified and taken into account the adverse effects of the proposed project on the preservation of farmland; • Considered alternative actions, as appropriate, that could lessen adverse effects; and • Ensured that the proposed project, to the extent practicable, would be compatible with state and units of local government programs, as well as private programs and policies to protect farmland. The DOE will coordinate with the Illinois Department of Agriculture to complete the farmland impact analysis.
Fish and Wildlife Conservation Act 16 USC 2901 <i>et seq.</i>	Encourages federal agencies to conserve and promote conservation of non-game fish and wildlife species and their habitats.
Fish and Wildlife Coordination Act 16 USC 661 <i>et seq.</i>	Requires federal agencies undertaking projects affecting water resources to consult with the USFWS and the state agency responsible for fish and wildlife resources. These agencies are to be sent copies of this Draft Environmental Impact Statement (EIS) and their comments will be considered.
Greenhouse Gas Reporting Program 40 CFR 98	The Consolidated Appropriations Act, 2008 (H.R. 2764; Public Law 110–161) directed the USEPA to develop a mandatory reporting rule for GHG emissions. The rule became effective December 29, 2009, and includes requirements for 31 emissions source categories, including electric generation and general combustion sources. On December 1, 2010, USEPA finalized new rules that amend the Greenhouse Gas Reporting Rule (GGRR). The new rules require reporting of emissions data from additional sources, including facilities that inject and store CO ₂ underground for the purposes of geologic sequestration (Subpart RR). Subpart RR reporting requirements went into effect on December 31, 2010.
Greenhouse Gas Tailoring Rule 40 CFR 51, 52, 70, and 71	This rule limits applicability of GHG emissions standards under the CAA to new and modified stationary sources that emit more than 75,000 tons per year (68,250 metric tons) of CO ₂ equivalents (beginning January 2, 2011). If GHG emissions exceed the threshold, the GHG emissions would be subject to best available control technology and other relevant requirements that apply to PSD permits. Because this project includes contemporaneous and creditable decreases in GHG emissions, the project is not subject to PSD for GHG.
Mercury and Air Toxics rule (also known as Utility Maximum Achievable Control Technology [MACT] rule) 40 CFR 63 Subpart UUUUU	On February 16, 2012, the USEPA finalized the NESHAPs from Coal- and Oil-Fired Electric Utility Steam Generating Units (EGUs) under 40 CFR 63, Subpart UUUUU, otherwise known as the MATS rule (or Utility MACT). New and existing facilities would be subject to the rule. This rule replaces the 2005 Clean Air Mercury Rule. The proposed project is categorized as an EGU and would therefore be subject to this regulation.

Table 5-1. Relevant Regulatory and Permit Requirements for the Proposed Project

Statute, Regulation, Order	Description
Migratory Bird Treaty Act 16 USC 703 <i>et seq.</i>	Protects birds that have common migration patterns between the United States and Canada, Mexico, Japan, and Russia. The Act regulates the take and harvest of migratory birds. The USFWS will review this EIS to determine whether the activities analyzed would comply with the requirements of the Migratory Bird Treaty Act.
National Emission Standards for Hazardous Air Pollutants 40 CFR 61 and 63 35 IAC 201 35 IAC 232	Non-criteria pollutants that can cause serious health and environmental hazards are termed hazardous air pollutants (HAPs) or air toxics. The NESHAPs apply primarily to new and existing sources in source categories designated by the USEPA. Specific NESHAPs apply to major sources of HAPs defined to be major (i.e., emitting a single HAP in excess of 10 tons per year or an aggregate emissions rate of over 25 tons per year of any combination of regulated HAPs). However, USEPA has also promulgated several NESHAPs which apply to area sources of HAPs (less than major source levels of HAPs). The emergency generators at the energy center would be subject to 40 CFR 63 Subpart ZZZZ, "National Emission Standards for Hazardous Air Pollutants for Stationary Reciprocating Internal Combustion Engines." The auxiliary boiler would be subject to 40 CFR 63 Subpart DDDDD, "National Emission Standards for Hazardous Air Pollutants for Industrial, Commercial, and Institutional Boilers and Process Heaters at Major Sources."
National Environmental Policy Act (NEPA) 42 USC 4321 <i>et seq.</i>	This EIS is being prepared to comply with NEPA, the federal law that requires agencies of the federal government to study the possible environmental impacts of major federal actions significantly affecting the quality of the human environment.
National Historic Preservation Act 36 CFR 800 16 USC 470 <i>et seq.</i>	Under Section 106, the head of any federal agency having direct or indirect jurisdiction over a proposed federal or federally-assisted undertaking in any state and the head of any federal department or independent agency having authority to license any undertaking shall, prior to the approval of the expenditure of any federal funds on the undertaking or prior to the issuance of any license, as the case may be, take into account the effect of the undertaking on any district, site, building, structure, or object that is included in or eligible for inclusion in the National Register. The head of any such federal agency shall afford the Advisory Council on Historic Preservation established under Title II of the Act a reasonable opportunity to comment with regard to such undertaking.
National Pollutant Discharge Elimination System 42 USC 1342 <i>et seq.</i> 35 IAC 309	Authorized under the CWA, the NPDES program requires sources to obtain permits to discharge effluents and stormwater to surface waters. Under this program, permit modifications are required if discharge effluents are altered. The CWA authorizes USEPA to delegate permitting, administrative, and enforcement duties to state governments, while it retains oversight responsibilities. The state of Illinois has been delegated NPDES authority and therefore would issue an NPDES permit for the project. The proposed project would discharge treated industrial wastewater to surface waters under NPDES Permit No. IL0000116. This NPDES Permit (IL0000116), which was renewed September 30, 2011, is valid for the next five years. A modification to this permit was submitted to IEPA on June 20, 2013, based upon project design changes which occurred after the Draft EIS was released; approval is currently pending. Pending future design changes, this permit may require additional revision prior to the project discharging wastewater.

Table 5-1. Relevant Regulatory and Permit Requirements for the Proposed Project

Statute, Regulation, Order	Description
New Source Performance Standards 40 CFR 60	The NSPS are technology-based standards applicable to new, modified and reconstructed stationary sources of regulated air emissions in certain source categories. Where the National Ambient Air Quality Standard (NAAQS) emphasize air quality in general, the NSPS focus on particular sources of approximately 70 industrial source categories or sub-categories of sources (e.g., fossil fuel-fired generators, grain elevators, steam generating units) that are designated by size as well as type of process. NSPS standards have been developed and would apply to the oxy-combustion boiler, the auxiliary fuel oil fired boiler, and the emergency generator. NSPS standards have also been promulgated for coal processing plants and certain portions of the Meredosia Energy Center coal handling system may fall under the coal processing plant standards after modification for this project.
Noise Control Act 42 USC 4901 <i>et seq.</i>	Directs federal agencies to carry out programs in their jurisdictions “to the fullest extent within their authority” and in a manner that furthers a national policy of promoting an environment free from noise that jeopardizes health and welfare.
Notice to the Federal Aviation Administration 14 CFR 77	The Federal Aviation Administration (FAA) must be notified and informed of proposed lighting for any structures more than 200 feet high pursuant to 14 CFR 77. The FAA would then determine if the structures would or would not be an obstruction to air navigation. Subsequent construction notification(s) are required to be submitted to the FAA.
Occupational Safety and Health Act 29 USC 651 <i>et seq.</i>	Compliance with OSHA would be required according to OSHA standards. Applicable Rules: <ul style="list-style-type: none"> • OSHA General Industry Standards (29 CFR 1910) • OSHA Construction Industry Standards (29 CFR 1926) • OSHA sets permissible exposure limits for chemicals allowed for workers over an 8-hour period at facilities. Energy center employees would be instructed in worker protection and safety procedures, and would be provided appropriate personal protective equipment pursuant to the contractor’s and/or energy center’s safety program.
Oil Pollution Prevention Rule 40 CFR 112	This Rule requires a Spill Prevention, Control, and Countermeasures (SPCC) plan if the energy center stores more than 1,320 gallons of oil onsite aboveground (or more than 42,000 gallons of oil onsite belowground). The rule is applicable to the project based on the proposed storage of diesel fuel and potential use of large transformers that hold more than 1,320 gallons of mineral oil.
Pollution Prevention Act 42 USC 13101 <i>et seq.</i>	Establishes a national policy for waste management and pollution control that focuses first on source reduction, and then on environmentally safe waste recycling, treatment, and disposal. EO 13101, “Greening the Government through Waste Prevention, Recycling, and Federal Acquisition”, and EO 13148, “Greening the Government through Leadership in Environmental Management”, provide guidance to agencies to implement the Pollution Prevention Act. DOE requires specific goals to reduce the generation of waste. DOE would implement a pollution prevention plan by incorporating such waste-reducing activities as ordering construction materials in correct sizes and numbers, resulting in very small amounts of waste; and implementing best management practices to reduce the volume of waste generated and reuse waste wherever possible.

Table 5-1. Relevant Regulatory and Permit Requirements for the Proposed Project

Statute, Regulation, Order	Description
Prevention of Significant Deterioration (Clean Air Act Title I) 40 CFR 52.21	<p>The PSD Program involves a pre-construction review and permit process for construction and operation of a new or modified major stationary source of air emissions in attainment areas. A major source is a source for which the amount of any one regulated pollutant emitted is equal to or greater than thresholds of 100 tons per year for sources which are part of the 28 categories defined by the PSD rule or 250 tons per year for all other source categories. Regulated air pollutants include PM, VOC, GHGs, SO₂, NO_x, and CO. Authority for implementation of the Title I PSD program has been delegated to IEPA.</p> <p>The construction permit application for the proposed project quantifies and analyzes the estimated operational emissions, and concludes that the proposed project would not require a PSD permit; however, the construction permit application has not yet been approved by IEPA (Ameren 2013).</p>
Regional Haze Rule CAA Section 169	<p>In July 1999, the USEPA published the Regional Haze Rule to address visibility impairment in our nation's largest national parks and wilderness ("Class I") areas. The Regional Haze Rule required states to develop Best Available Retrofit Technology (BART) standards for combustion sources constructed between 1962 and 1977 which have the potential to emit greater than 250 tons per year of regional haze pollutants. These standards were to be developed on a case-by-case basis. Facilities constructed after 1977 were subject to NSPS standards for boilers and BART was not required. Therefore, the FutureGen 2.0 Project would not be required to conduct a Class I area impact analysis under the Regional Haze Rule.</p>
Resource Conservation and Recovery Act (RCRA) 40 CFR 239 through 299	<p>Regulates the treatment, storage, and disposal of hazardous wastes. Project participants would be required to identify any residues that require management as hazardous waste under RCRA (40 CFR 261). For some waste streams, this includes testing waste samples using the toxic characteristic leaching procedure or other procedures that measure hazardous waste characteristics.</p> <p>Applicable Title: Title II, Subtitle C - Hazardous Waste Management, provides for a regulatory system to ensure the environmentally sound management of hazardous wastes from the point of origin to the point of final disposal. Title II, Subtitle D - State or Regional Solid Waste Plans, requires state and local government to establish a regulatory framework for the proper management and disposal of non-hazardous solid wastes.</p>
Rivers and Harbors Act of 1989 33 USC 401, 403, 407	<p>Section 10 of the Rivers and Harbors Act requires authorization from the USACE for the construction of any structure in or over any navigable water of the U.S., the excavation/dredging or deposition of material in these waters or any obstruction or alteration in "navigable water". Structure or work outside the limits defined as navigable waters of the U.S. require a Section 10 permit if the structure or work affects the course, location, condition, or capacity of the waterbody.</p> <p>The Alliance is currently discussing the applicability of this requirement with the USACE.</p>
Safe Drinking Water Act 42 USC 300 <i>et seq.</i>	<p>Gives USEPA the responsibility and authority to regulate public drinking water supplies by establishing drinking water standards, delegating authority for enforcement of drinking water standards to the states, and protecting aquifers from hazards such as injection of wastes and other materials into wells. The USEPA has primacy over Class VI injection wells, which are used for geologic sequestration of CO₂. USEPA regulations for the Underground Injection Control (UIC) program of the Safe Drinking Water Act are codified at 40 CFR 146.</p>

Table 5-1. Relevant Regulatory and Permit Requirements for the Proposed Project

Statute, Regulation, Order	Description
Transportation of Hazardous Liquids by Pipeline 49 CFR 195	Specifies safety standards and reporting requirements for pipeline facilities used in the transportation of hazardous liquids or CO ₂ . This includes pipeline location standards to avoid private dwellings, industrial buildings, and places of public assembly, stipulations for pipeline depth and right-of-way (ROW) requirements. This Act established the Office of Pipeline Safety (OPS), which is part of the Pipeline and Hazardous Materials Safety Administration. OPS maintains a pipeline incident database and also requires pipeline annual operator reports. OPS develops safety guidelines for pipelines. The 1992 amendments, particularly Section 601 Safety, expanded the authority of OPS to evaluate safety and environmental protection related to siting and operation of natural gas, oil, and hazardous liquid pipelines.
Underground Injection Control Permit 40 CFR 146	Construction and operation of CO ₂ injection wells for geologic storage would require the issuance of UIC permits in accordance with 40 CFR 146 under the Safe Drinking Water Act. The USEPA currently has the authority to issue and administer the Class VI permits required for large-scale injection of CO ₂ . The Alliance submitted the UIC permit applications to the USEPA in March 2013, with a subsequent revision in May 2013.
Executive Orders	
Executive Order 13175 <i>Consultation and Coordination with Indian Tribal Governments</i>	Directs federal agencies to establish regular and meaningful consultation and collaboration with tribal governments in the development of federal policies that have tribal implications, to strengthen United States government-to-government relationships with Indian tribes, and to reduce the imposition of unfunded mandates on tribal governments.
Executive Order 13432 <i>Cooperation Among Agencies in Protecting the Environment With Respect to Greenhouse Gas Emissions From Motor Vehicles, Nonroad Vehicles, and Nonroad Engines</i>	EO issued (May 2007) to reduce GHG emissions from motor vehicles, nonroad vehicles, and nonroad engines.
Executive Order 12898 <i>Federal Actions to Address Environmental Justice in Minority Populations and Low-Income Populations</i>	Requires federal agencies to identify and address, as appropriate, disproportionately high and adverse human health or environmental effects of its programs, policies, and activities on minority populations and low-income populations.
Executive Order 13514 <i>Federal Leadership in Environmental, Energy and Economic Performance</i>	EO (issued October 2009) to make reduction of GHG emissions a priority for federal agencies. In October 2010, the CEQ finalized guidance establishing government-wide requirements for federal agencies in calculating and reporting greenhouse emissions associated with agency operations.

Table 5-1. Relevant Regulatory and Permit Requirements for the Proposed Project

Statute, Regulation, Order	Description
Executive Order 11988 <i>Floodplain Management;</i> Executive Order 11990 <i>Protection of Wetlands</i>	EO 11988, "Floodplain Management", directs federal agencies to establish procedures to ensure that they consider potential effects of flood hazards and floodplain management for any action undertaken. Agencies are to avoid impacts to floodplains to the extent practical. EO 11990, "Protection of Wetlands", requires federal agencies to avoid short- and long-term impacts to wetlands if a practical alternative exists. DOE regulation 10 CFR 1022 establishes procedures for compliance with these EOs. Where no practical alternatives exist to development in floodplain and wetlands, DOE is required to prepare a floodplain and wetlands assessment discussing the effects on the floodplain and wetlands, and consideration of alternatives. In addition, these regulations require DOE to design or modify its actions to minimize potential damage in floodplains or harm to wetlands. DOE is also required to provide opportunity for public review of any plans or proposals for actions in floodplains and new construction in wetlands. A statement of findings from the assessment will be included with the ROD.
Executive Order 13148 <i>Greening the Government through Leadership in Environmental Management</i>	Makes the head of each federal agency responsible for ensuring that all necessary actions are taken to integrate environmental accountability into agency day-to-day decision-making and long-term planning across all agency missions, activities, and functions.
Executive Order 13101 <i>Greening the Government through Waste Prevention, Recycling, and Federal Acquisition</i>	Directs federal agencies to incorporate waste prevention and recycling in each agency's daily operations and work to increase and expand markets for recovered materials through preference and demand for environmentally preferable products and services.
Executive Order 13007 <i>Indian Sacred Sites</i>	Directs federal agencies, to the extent permitted by law and not inconsistent with agency missions, to avoid adverse effects to sacred sites and to provide access to those sites to Native Americans for religious practices. This Order directs agencies to plan projects to provide protection of and access to sacred sites to the extent compatible with the project.
Executive Order 13112 <i>Invasive Species</i>	Directs federal agencies to prevent the introduction of or to monitor and control invasive (non-native) species, to provide for restoration of native species, to conduct research, to promote educational activities, and to exercise care in taking actions that could promote the introduction or spread of invasive species.
Executive Order 11514 <i>Protection and Enhancement of Environmental Quality</i>	This EO directs federal agencies to continuously monitor and control activities to protect and enhance the quality of the environment. The EO also requires agencies to develop procedures to ensure the fullest practical provision of timely public information and the understanding of federal plans and programs with potential environmental impacts, and to obtain the views of interested parties. DOE promulgated regulations (10 CFR 1027) and issued DOE Order 451.1b, "National Environmental Policy Act Compliance Program", to ensure compliance with this EO. Because the proposed project is a federal action that requires NEPA analysis, DOE must comply with Order 451.1b.

Table 5-1. Relevant Regulatory and Permit Requirements for the Proposed Project

Statute, Regulation, Order	Description
Executive Order 13186 <i>Responsibilities of Federal Agencies to Protect Migratory Birds</i>	Requires federal agencies to avoid or minimize the negative impacts of their actions on migratory birds, and to take active steps to protect birds and their habitats. <ul style="list-style-type: none"> • Directs each federal agency taking actions having or likely to have a negative impact on migratory bird populations to work with the USFWS to develop an agreement to conserve those birds. • Directs agencies to avoid or minimize impacts to migratory bird populations, take reasonable steps that include restoring and enhancing habitat, prevent or abate pollution affecting birds, and incorporate migratory bird conservation into agency planning processes whenever possible. • Requires environmental analyses of federal actions to evaluate effects of those actions on migratory birds, to control the spread and establishment in the wild of exotic animals and plants that could harm migratory birds and their habitats, and either to provide advance notice of actions that could result in the take of migratory birds or to report annually to the USFWS on the numbers of each species taken during the conduct of agency actions.
Executive Order 12856 <i>Right-to-Know Laws and Pollution Prevention Requirements</i>	Directs federal agencies to reduce and report toxic chemicals entering any waste stream, improve emergency planning, response, and accident notification, and encourage the use of clean technologies and testing of innovative prevention technologies. In addition, this Order states that federal agencies are persons for purposes of the Emergency Planning and Community Right-to-Know Act, which requires agencies to meet the requirements of the Act.
Executive Order 13423 <i>Strengthening Federal Environmental, Energy, and Transportation Management</i>	EO 13423 directs federal agencies to conduct their environmental, transportation, and energy related activities in an environmentally, economically, and fiscally sound, integrated, continuously improving, efficient, and sustainable manner.
Illinois State Regulations and Permitting	
Accommodation of Utilities on Right-of-Way 92 IAC 530	A public entity acting in the capacity of a utility must obtain a permit issued by an officer of the elected governing body.
Air Pollution Control Construction and Operating Permits 35 IAC 201 35 IAC 203	An IEPA construction permit is required prior to construction. Because this project would occur in an attainment area, the project would be subject to either a PSD permit or a minor source permit, depending on the air emissions. The construction permit typically allows operation for a period of up to 12 months following initial startup, during which all permit-required emissions source testing, emissions monitoring verification, and preparation of the CAAPP operating permit application would be conducted. The operating permit would then provide ongoing regulatory compliance conditions for the facility following construction.
Archaeological and Paleontological Resources Protection Act 20 Illinois Compiled Statutes (ILCS) 3435	Under the Archaeological and Paleontological Resources Protection Act, individuals are prohibited from disturbing (collecting, destroying, defacing, etc.) archaeological and paleontological resources on public lands in Illinois. This law is also known as the Public Lands Act. Violations of this Act are subject to civil penalties relating to either the misdemeanor or felony charges.
Boiler and Pressure Vessel Safety Act 41 IAC 120	Under the Boiler and Pressure Vessel Safety Act, no boiler, except those exempted by the Act, can be installed unless it has been constructed and inspected in conformity with the applicable section of the American Society of Mechanical Engineers (ASME) Code and is inspected and registered in accordance with the requirements of the Act.

Table 5-1. Relevant Regulatory and Permit Requirements for the Proposed Project

Statute, Regulation, Order	Description
<p>Carbon Dioxide Transportation and Sequestration Act Illinois Public Act 097-0534</p>	<p>Specifies the process for obtaining a certificate of authority from the Illinois Commerce Commission by owner or operator of a CO₂ pipeline that is operated to transport CO₂ for underground storage or EOR.</p>
<p>Cemetery Protection Act 765 ILCS 835</p>	<p>The Cemetery Protection Act makes it illegal to vandalize, obliterate, or desecrate a burial ground (cemetery), park, memorial, grave marker, vegetation, or surroundings (fences, curbs, etc.) dedicated to the deceased. Under this law, specific criminal penalties are provided for and increase in severity relative to degree of the offense.</p>
<p>Certificate of Public Convenience and Necessity Section 3-105 and 8-406 of the Illinois Public Utilities Act</p>	<p>A certificate would be required if the FutureGen Industrial Alliance, as the operator of the energy center, was determined to be a public utility. At this time, it is not expected that a certificate would be required.</p>
<p>Construction in Floodways of Rivers, Lakes, and Streams 17 IAC 3700</p>	<p>IDNR issues permits for construction projects that may impact the flood carrying capacity of the rivers, lakes, and streams. These rules affect all streams and lakes except those in northeastern Illinois regulated under Part 3708. All construction activities in the floodways of streams in urban areas where the stream drainage area is 1 square mile or more or in rural areas where the stream drainage area is 10 square miles or more must be permitted by the Division prior to construction.</p>
<p>Regulation of Public Waters 17 IAC 3704</p>	<p>IDNR issues permits for activities in the public waters of the state. The public waters may generally be described as the commercially navigable lakes and streams of the state and the backwater areas of those streams. The Division reviews proposed activities in public waters to ensure that the public's rights are not diminished by the activity. Activities that require review are not limited to construction. A permit is issued to demonstrate that the activity does not diminish the public's rights.</p>
<p>Rivers, Lakes, and Streams Act and Floodway Construction Rules 615 ILCS 5</p>	<p>The purpose of this Statewide Permit is to authorize the construction of underground pipeline and utility crossings, which have insignificant impact on those factors under the jurisdiction of the Department of Natural Resources, Office of Water Resources. This permit applies to all directionally bored pipeline and utility crossings placed beneath the beds of all Illinois rivers, lakes, and streams under the Department's jurisdiction. This permit also applies to other pipeline and utility crossings placed beneath the beds of all Illinois rivers, lakes, and streams under the Department's jurisdiction except those in Part 3708.</p>
<p>General Permit for Construction Storm Water Discharge IEPA NPDES Permit No. ILR10 35 IAC, Subtitle C, Chapter 1</p>	<p>Construction sites that disturb one acre or more are required to have coverage under the NPDES general permit for stormwater discharges from construction site activities. When the construction activity is completed and all disturbed areas are stabilized, the responsible party must submit a Notice of Termination in order to end coverage under the General Permit.</p>
<p>Human Skeletal Remains Protection Act 20 ILCS 3440 17 IAC 4170</p>	<p>Under the Human Skeletal Remains Protection Act, any person who discovers human skeletal remains shall promptly notify the coroner. It is unlawful for any person, either by himself or through an agent, to knowingly disturb human skeletal remains, grave markers, or grave artifacts in unregistered graves protected by this Act unless such person obtains a permit issued by the Illinois Historic Preservation Agency.</p>

Table 5-1. Relevant Regulatory and Permit Requirements for the Proposed Project

Statute, Regulation, Order	Description
Hydrostatic Test Water Discharge Permit - NPDES General Permit 35 IAC Subtitle C, Chapter 1	This permit would be obtained from the IEPA, Division of Water Pollution Control under the NPDES Program. This permit would regulate hydrostatic test water discharge and construction dewatering to waters of the state. No trench dewater permit would be required for the proposed project unless contaminated soil/water and discharge would flow to an uncontaminated source.
Illinois Clean Coal Portfolio Standard Law 20 ILCS 3855	The law creates a framework for developing clean-coal power projects with CO ₂ capture and storage, requiring emissions from these electric generation facilities to be as clean as natural gas generators. To qualify as a clean coal facility under this legislation, new coal-fueled power plants that begin operations between 2016 and 2017, must capture and store 70 percent of carbon emissions, and after 2017, must capture and store 90 percent of the carbon emissions the facility would otherwise emit. Facilities must also incorporate power generating equipment that limit regulated pollutants (SO ₂ , NO _x , CO, particulates, and mercury) from combustion of the synthetically-produced feedstock to levels that are no higher than combined cycle, natural gas-fired plants. The law requires electric utilities and other electric retail suppliers in Illinois to purchase up to 5 percent of their electricity from clean coal facilities. It also entitles one initial clean coal facility with a final air permit to 30-year purchase agreements for the sale of its output.
Illinois Department of Agriculture	Developed recommended pipeline construction standards to help preserve integrity of agricultural land and reduce impacts from pipelines such as deeper burial to 5 feet under agricultural areas with tile drains.
Illinois Elevator Safety Rules 41 IAC 1000	The Illinois Elevator Safety Rules assures that conveyances are correctly and safely installed and operated within the state by regulating the installation, construction, operation, inspection, testing, maintenance, alteration, and repair of elevators, dumbwaiters, escalators, moving sidewalks, platform lifts, stairway chairlifts, and automated people movers, and by licensing personnel and businesses that work on these conveyances. The project would install an elevator.
Illinois Emergency Management Agency Act 20 ILCS 3305	This Act set up the Illinois Emergency Management Agency and procedures for planning and handling natural disasters and man-made emergencies. Title 29: Emergency Services, Disasters, and Civil Defense specifies the agency's work related to emergency planning, incident reporting for releases of extremely hazardous or hazardous chemicals above specified reportable quantities. This agency maintains information on radon in the state.
Illinois Emergency Planning and Right to Know Act 430 ILCS 100	Provides for state implementation of federal statutes related to reporting of hazardous chemicals stored onsite and notification requirements if a release occurs to offsite areas.
Illinois Endangered Species Act 17 IAC 1075	This Act requires a consultation process be undertaken with the IDNR to determine the potential impact of a facility on state threatened, endangered, or special concern species. Such consultation is underway for the project. This documentation will be included in the Final EIS.
Illinois Environmental Protection Act 415 ILCS 5	Supplements and strengthens existing criminal sanctions regarding environmental damage by enacting specific penalties for injury to public health and the environment. Establishes a unified, state-wide program supplemented by private remedies to restore, protect, and enhance the quality of the environment. Assures that adverse effects upon the environment are fully considered and borne by those who cause them.

Table 5-1. Relevant Regulatory and Permit Requirements for the Proposed Project

Statute, Regulation, Order	Description
Illinois Executive Order 2006-11	Illinois State EO issued (October 2006) to initiate a long-term strategy by the state to combat global climate change, and build on the steps the state has already taken to reduce greenhouse emissions. The Order created the Illinois Climate Change Advisory Group (ICCAG) to consider a full range of policies and strategies to reduce GHGs in Illinois and make recommendations to the Governor (IEPA 2011).
Illinois Farmland Preservation Act 8 IAC 700	Illinois Department of Agriculture policy to promote the protection of Illinois farmland from unnecessary conversion and degradation.
Illinois Gas Pipeline Safety Act 220 ILCS 20	Establishes minimum safety standards for the transportation of gas and for the pipeline facilities. Applies to the design, installation, inspection, testing, construction, extension, operation, replacement, and maintenance of pipeline facilities.
Illinois Historic Resources Preservation Act 20 ILCS 3420	Consultation with the Illinois SHPO is required if historic properties could be located within the project area. Such consultation is underway; DOE, the Alliance, and the Illinois SHPO are parties to a Programmatic Agreement that covers such activities (see Appendix B, Cultural Resources Consultation [B3]).
Illinois Interagency Wetland Policy Act 20 ILCS 830	Establishes a state goal that there be “no overall net loss of the state’s existing wetland acres or their functional values due to state supported activities.” To accomplish this goal, the Act established a review process for all projects being pursued by a state agency or being accomplished with state funds that have the potential to adversely affect a wetland. If it is determined an impact is going to occur, the entity requesting approval must prepare a compensation plan that details how it will compensate for the impact. All compensation plans must be approved by IDNR.
Interconnection Agreement	If an interconnection agreement is required with an owner of a transmission system, approval by the Illinois Commerce Commission may be required.
Permit for Groundwater Monitoring Wells 77 IAC 920	The Illinois Department of Public Health, Environmental Health Division and local health departments review water well installation plans, issue permits for new well construction, and inspect wells.
Potable Water Supply Connection Permits 35 IAC 174	A construction permit would be required to connect to a public potable water supply. Any entity obtaining a construction permit must also obtain an operating permit prior to being placed in service. There is an existing connection from the Meredosia Energy Center to the village of Meredosia water supply. This would continue to be used for the FutureGen 2.0 Project. However, this would not require a new permit since the connection already exists. A permit could be required for the proposed educational facilities.
IEPA Division of Public Water Supplies, Construction Permit	
IEPA Division of Public Water Supplies, Permit Section, Operating Permit, IL532-0140 PWS 037	
Sound Emissions Standards and Limitations for Property-Line Noise-Sources 35 IAC 901	Includes classifications of land according to use, which are applied to noise emissions regulations. The Code categorizes land use into Land Class A, B, and C depending on type (i.e., developed, agricultural, vegetated, etc.). Illinois regulations list the maximum noise limits that different classifications of land use can experience. The regulations identify un-weighted (decibel) permissible sound levels during day and nighttime for sound emanating from a Class C land (e.g., industrial) to a receiving Class A land (e.g., residential) and are presented in Table 3.14-4.

Table 5-1. Relevant Regulatory and Permit Requirements for the Proposed Project

Statute, Regulation, Order	Description
Wastewater Facility Construction Approval 415 ILCS 5	Design and construction of wastewater treatment systems at the Meredosia Energy Center would require review and approval by the IEPA.
Local Regulations and Permitting	
Sanitary Holding System Permit Morgan County Private Sewage Disposal Ordinance Section 2.1 – 2.8	A permit is required for the installation of any holding tank system. Installation and operation of a holding tank system would be in accordance with 77 IAC 905. The duration of use for holding tank systems is restricted to one year; however, a permit variance can be applied for to extend this time limit if it is anticipated that use of the tank would last beyond one year.

ASME = American Society of Mechanical Engineers; BART = Best Available Retrofit Technology; CAA = Clean Air Act; CAAPP = Clean Air Act Permit Program; CAIR = Clean Air Interstate Rule; CEQ = Council on Environmental Equality; CO = carbon monoxide; CO₂ = carbon dioxide; CFR = Code of Federal Regulations; CSAPR = Cross State Air Pollution Rule; CWA = Clean Water Act; DOE = U.S. Department of Energy; EGU = Electric Utility Steam Generating Units; EIS = Environmental Impact Statement; EO = Executive Order; EOR = enhanced oil recovery; FAA = Federal Aviation Administration; GGRR = Greenhouse Gas Reporting Rule; GHG = greenhouse gas; HAP = hazardous air pollutant; IAC = Illinois Administrative Code; ICCAG = Illinois Climate Change Advisory Group; IDNR = Illinois Department of Natural Resources; IEPA = Illinois Environmental Protection Agency; ILCS = Illinois Compiled Statutes; MACT = Maximum Achievable Control Technology; MATS = Mercury and Air Toxics; NAAQS = National Ambient Air Quality Standard; NEPA = National Environmental Policy Act; NESHAP = National Emission Standards for Hazardous Air Pollutants; NO_x = nitrogen oxides; NPDES = National Pollutant Discharge Elimination System; NSPS = new source performance standard; OPS = Office of Pipeline Safety; OSHA = Occupational Safety and Health Administration; PM = particulate matter; PSD = Prevention of Significant Deterioration; RCRA = Resource Conservation and Recovery Act; ROD = Record of Decision; ROW = right-of-way; SO₂ = sulfur dioxide; SPCC = Spill Prevention, Control, and Countermeasures; UIC = Underground Injection Control; USACE = U.S. Army Corps of Engineers; USC = U.S. Code; USEPA = U.S. Environmental Protection Agency; USFWS = U.S. Fish and Wildlife Service; VOC = volatile organic compound

INTENTIONALLY LEFT BLANK

6 REFERENCES

- 7 USC (United States Code) 4201-4209. "Farmland Protection Policy." U.S. Federal Government, *U.S. Code*.
- 8 IAC (Illinois Administrative Code) 700. "Farmland Preservation Act." State of Illinois, *Administrative Code*.
- 10 CFR (*Code of Federal Regulations*) 1021. "National Environmental Policy Act Implementing Procedures." U.S. Department of Energy, *Code of Federal Regulations*.
- 16 USC 470. "National Historic Preservation Act of 1966." U.S. Federal Government, *U.S. Code*.
- 17 IAC 3700. "Construction in Floodways of Rivers, Lakes and Streams." State of Illinois, *Administrative Code*.
- 20 ILCS (Illinois Compiled Statutes) 3410. "Illinois Historic Preservation Act." Accessed October 26, 2012 at <http://www.ilga.gov/legislation/ilcs/ilcs3.asp?ActID=370&ChapterID=5>.
- 20 ILCS 3420. "Illinois State Agency Historic Resources Preservation Act." Accessed October 26, 2012 at <http://www.ilga.gov/legislation/ilcs/ilcs3.asp?ActID=372&ChapterID=5>.
- 20 ILCS 3435. "Archaeological and Paleontological Resources Protection Act." Accessed October 26, 2012 at <http://www.ilga.gov/legislation/ilcs/ilcs3.asp?ActID=375&ChapterID=5>.
- 20 ILCS 3440. "Human Skeletal Remains Protection Act." Accessed October 26, 2012 at <http://www.ilga.gov/legislation/ilcs/ilcs3.asp?ActID=376&ChapterID=5>.
- 23 CFR 772. "Procedures for Abatement of Highway Traffic Noise and Construction Noise." Federal Highway Administration, *Code of Federal Regulations*.
- 35 IAC 174. "Delegation of Construction and Operating Permit Authority for Sanitary and Combined Sewers and Water Main Extensions." State of Illinois, *Administrative Code*.
- 35 IAC 243. "Air Quality Standards." State of Illinois, *Administrative Code*.
- 35 IAC 302. "Water Quality Standards." State of Illinois, *Administrative Code*.
- 36 CFR 800. "Protection of Historic Properties." Advisory Council on Historic Preservation, *Code of Federal Regulations*.
- 40 CFR 50. "National Primary and Secondary Ambient Air Quality Standards." U.S. Environmental Protection Agency, *Code of Federal Regulations*.
- 40 CFR 51.166. "Prevention of Significant Deterioration of Air Quality." U.S. Environmental Protection Agency, *Code of Federal Regulations*.
- 40 CFR 52. "Approval and Promulgation of Implementation Plans." U.S. Environmental Protection Agency, *Code of Federal Regulations*.
- 40 CFR 60. "Standards of Performance for New Stationary Sources." U.S. Environmental Protection Agency, *Code of Federal Regulations*.
- 40 CFR 63 Subpart UUUUU. "National Emission Standards for Hazardous Air Pollutants: Coal- and Oil-Fired Electric Utility Steam Generating Units." U.S. Environmental Protection Agency, *Code of Federal Regulations*.

- 40 CFR 81. “Designation of Areas for Air Quality Planning Purposes.” U.S. Environmental Protection Agency, *Code of Federal Regulations*.
- 40 CFR 93. “Determining Conformity of Federal Actions to State or Federal Implementation Plans.” U.S. Environmental Protection Agency, *Code of Federal Regulations*.
- 40 CFR 98. “Mandatory Greenhouse Gas Reporting.” U.S. Environmental Protection Agency, *Code of Federal Regulations*.
- 40 CFR 146. “Subpart H-Criteria and Standards Applicable to Class VI Wells.” U.S. Environmental Protection Agency, *Code of Federal Regulations*.
- 40 CFR 1500-1508. “National Environmental Policy Act Implementing Regulations.” The Council on Environmental Quality, *Code of Federal Regulations*.
- 42 USC 4321-4370. “National Environmental Policy Act.” U.S. Federal Government, *U.S. Code*.
- 42 USC 4332. “Cooperation of Agencies; Reports; Availability of Information; Recommendations; International and National Coordination of Efforts.” U.S. Federal Government, *U.S. Code*.
- 42 USC 7409. “National Primary and Secondary Ambient Air Quality Standards. Promulgation.” U.S. Federal Government, *U.S. Code*.
- 49 CFR 195. “Transportation of Hazardous Liquids by Pipeline.” Pipeline and Hazardous Materials Safety Administration, U. S. Department of Transportation, *Code of Federal Regulations*.
- 53 FR 45858. “50 CFR Part 17. Endangered and Threatened Wildlife and Plants; Determination of Threatened Status for *Boltonia decurrens* (Decurrent False Aster).” U.S. Department of the Interior, Fish and Wildlife Service, *Federal Register* [Volume 53, Number 219]. November 14, 1988.
- 54 FR 39857. “50 CFR Part 17. Endangered and Threatened Wildlife and Plants; Determination of Threatened Status for Eastern and Western Prairie Fringed Orchids.” U.S. Department of the Interior, Fish and Wildlife Service, *Federal Register* [Volume 54, Number 187]. September 28, 1989.
- 67 FR 31129. “40 CFR Part 232. Final Revisions to the Clean Water Act Regulatory Definitions of “Fill Material” and “Discharge of Fill Material.”” Department of the Army, Corps of Engineers, *Federal Register* [Volume 67, Number 90]. May 9, 2002.
- 71 FR 42840. “Notice of Intent to Prepare an Environmental Impact Statement for Implementation of the FutureGen Project.” U.S. Department of Energy, *Federal Register* [Volume 71, Number 145]. July 28, 2006.
- 72 FR 19015. “Draft Indiana Bat Recovery Plan, First Revision; Draft Survey Protocol.” U.S. Fish and Wildlife Service, *Federal Register* [Volume 72, Number 92]. April 16, 2007.
- 74 FR 35174. “Record of Decision, FutureGen Project.” U.S. Department of Energy, *Federal Register* [Volume 74, Number 137]. July 20, 2009.
- 75 FR 35128. “Hazardous and Solid Waste Management System; Identification and Listing of Special Wastes; Disposal of Coal Combustion Residuals From Electric Utilities; Proposed Rule.” U.S. Environmental Protection Agency, *Federal Register* [Volume 75, Issue 118]. June 21, 2010.
- 75 FR 75060. “Mandatory Reporting of Greenhouse Gases: Injection and Geologic Sequestration of Carbon Dioxide; Final Rule.” U.S. Environmental Protection Agency, *Federal Register* [Volume 75, Issue 230]. December 1, 2010.

- 75 FR 77230. "Federal Requirements Under the Underground Injection Control (UIC) Program for Carbon Dioxide (CO₂) Geologic Sequestration (GS) Wells." Final Rule. 40 CFR 124, 144, 145, 146 and 147. U.S. Environmental Protection Agency, *Federal Register* [Volume 75, Issue 237]. December 10, 2010.
- 76 FR 29728. "Notice of Intent to Prepare an Environmental Impact Statement and Notice of Potential Floodplain and Wetlands Involvement for the FutureGen 2.0 Program." U.S. Department of Energy, *Federal Register* [Volume 76, Number 99]. May 23, 2011.
- 78 FR 26004. "Notice of Availability; Draft Environmental Impact Statement for the FutureGen 2.0 Project." U.S. Department of Energy, *Federal Register* [Volume 78, Issue 86]. May 3, 2013.**
- 78 FR 26027. "Environmental Impacts Statements; Notice of Availability." U.S. Environmental Protection Agency, *Federal Register* [Volume 78, Issue 86]. May 3, 2013.**
- 92 IAC 530. "Accommodation of Utilities on Right-Of-Way." State of Illinois, *Administrative Code*.
- 220 ILCS 5. "Public Utilities Act." Accessed September 14, 2012 at <http://www.ilga.gov/legislation/ilcs/ilcs5.asp?DocName=&ActID=1277&ChapterID=23&SeqStart=&SeqEnd=&Print=True>.
- 765 ILCS 835. "Cemetery Protection Act." State of Illinois, *Administrative Code*.
- AIGA (Asia Industrial Gases Association). 2010. Safe Location of Oxygen and Inert Gas Vents. Singapore. AIGA 067/10.
- AIHA (American Industrial Hygiene Association). 2011. "2011 ERPG/WEEL Handbook Current ERPGTM Values (2011)." Accessed July 24, 2012 at <http://www.aiha.org/INSIDEAIHA/GUIDELINEDEVELOPMENT/ERPG/Pages/default.aspx>.
- Air Liquide. 2007. Material Safety Data Sheet (MSDS) for Liquid Oxygen. MSDS No. 10075. Issued December 31, 2007.
- Air Liquide. 2013. ASU Emissions and Effluents Summary. Process Datasheet. 7979-020-ASU PDS-111-LR.
- Airnow. 2011. "Air Quality Index (AQI)-A Guide to Air Quality and Your Health." Accessed March 10, 2011 at <http://www.airnow.gov/index.cfm?action=aqibasics.aqi>.
- AISWCD (Association of Illinois Soil and Water Conservation Districts). 2012. "Illinois Urban Manual." Online manual. Accessed November, 29, 2012 at <http://www.aiswcd.org/IUM/contents.html>.
- Alliance (FutureGen Alliance). 2007. Press Release. FutureGen Alliance Selects Mattoon, Illinois as the Final Site for the First-of-a-kind, Near-Zero Emissions Coal-fueled Power Plant. December 18, 2007.
- Alliance. 2010. FutureGen Industrial Alliance, Inc. Request for Site Proposals for FutureGen 2.0 CO₂ Storage Hub Site. October 25, 2010.
- Alliance. 2012. FutureGen 2.0 Oxy-combustion Coal-fueled Power Plant with Carbon Capture Pre-FEED Design and Cost Report. Phase I Final Technical Report Prepared for U.S. Department of Energy, National Energy Technology Laboratory. May 23, 2012.
- Alliance. **2013a.** FutureGen 2.0 Pipeline and Regional CO₂ Storage Reservoir Project Conceptual Design Report. August 2011, **Revised May 2013, Addendum (May 2013).**
- Alliance. 2013b. Field Activity Plan: ERT Field Evaluation, FutureGen 2.0 Morgan County Carbon Sequestration Site. June 2013.**

- Ambrose, W.A., S. Lakshminarasimhan, M.H. Holtz, V. Núñez-López, S.D. Hovorka, and I. Duncan. 2008. "Geologic factors controlling CO₂ storage capacity and performance: case studies based on experience with heterogeneity in oil and gas reservoirs applied to CO₂ storage." *Environmental Geology*. 54(8):1619-1633.
- Ameren. 2012. Construction Permit Application for a Proposed Project at a CAAPP Source, FutureGen 2.0 Repowering Project at the Meredosia Energy Center. Prepared for Illinois Environmental Protection Agency. February 6, 2012.
- Ameren. 2013. Construction Permit Application for a Proposed Project at a CAAPP Source, FutureGen 2.0 Repowering Project at the Meredosia Energy Center. Prepared for Illinois Environmental Protection Agency. June 18, 2013.**
- American Hospital Directory. 2011. "American Hospital Directory-Hospital Statistics by State." Updated April 6, 2011. Accessed August 8 2012 at http://www.ahd.com/state_statistics.html.
- Anliker, M.A. and D.M. Woller. 1998. Potential Ground-Water Resources for Springfield, Illinois. Contract Report 627. Illinois State Water Survey, Hydrology Division. Champaign, Illinois. May 1998.
- ASME (American Society of Mechanical Engineers). 2012. Pipeline Transportation Systems for Liquid and Slurries. B31.4-2012.**
- ATSDR. 2012. "ATSDR Minimum Risk Levels List." Updated February 2012. Accessed MRL List July 14, 2012 at <http://www.atsdr.cdc.gov/mrls/index.asp>.
- Audubon Society. 2012. "Mississippi Flyway." Accessed August 22, 2012 at <http://conservation.audubon.org/mississippi-flyway>.
- Babcock & Wilcox. 2010. Technical Considerations for Oxycombustion Flue Gas Conditioning. Technical Paper BR-1842. Presented to EPRI Power Plant Air Pollutant Control Mega Symposium. Baltimore, Maryland. August 30 – September 2, 2010.**
- Battelle. 2011a. Environmental Information Volume Biological Resources Section. Prepared for FutureGen Alliance. October 2011.
- Battelle. 2011b. Environmental Information Volume. Cultural Resources Section. Prepared for FutureGen Alliance. June 2011.
- BEA (Bureau of Economic Analysis). 2012. RIMS II, An essential tool for regional developers and planners. User guide and total multipliers data. U.S. Department of Commerce, Bureau of Economic Analysis, Washington, DC.
- Beacon. 2011. "Beacon-Morgan County, IL." Online Morgan County Geographic Information System mapping application. Updated April 14, 2011. Accessed December 28, 2011 at <http://beacon.schneidercorp.com/>.
- Beacon. 2013. "Beacon-Morgan County, IL." Online Morgan County Geographic Information System mapping application. Updated July 22, 2013. Accessed July 23, 2013 at <http://beacon.schneidercorp.com/>.**
- Behrens, C. and M. Holt. 2005. Nuclear Power Plants: Vulnerability to Terrorist Attacks. Report for Congress, U.S. Library of Congress, Congressional Research Service. Order Code RS21131. Updated February 4, 2005.

- Bell, A.H. 1961. *Underground Storage of Natural Gas in Illinois*. Circular 318. Illinois State Geological Survey. Urbana, Illinois. 1961.
- Benson, S.M. 2009. *Steps to Accelerate Deployment of CCS Storage*. Presentation at Eighth Annual Conference on Carbon Capture & Sequestration. Pittsburgh, PA. May 4-7, 2009.
- Berg, R.C., J.P. Kempton, and K. Cartwright. 1984. *Potential for Contamination of Shallow Aquifers in Illinois*. Circular 532. Illinois Department of Energy and Natural Resources, State Geological Survey Division. Champaign, Illinois. 1984, Reprinted 1994.
- Berger, P.M., W.R. Roy, and E. Mehnert. 2009. "Geochemical Modeling of Carbon Sequestration, MMW, and EOR in the Illinois Basin." *Energy Procedia*. 1(1):3437-3444.
- Bird, R.B., W.E. Stewart, and E.N. Lightfoot. 2006. *Transport Phenomena*, 2nd Edition. John Wiley & Sons, New York, New York. 2007.
- Birkholder, J.T., and Q. Zhou. 2009. "Basin-scale hydrogeologic impacts of CO₂ storage: Capacity and regulatory implications." *International Journal of Greenhouse Gas Control*. 3(6):745-756.**
- Birkholzer, J.T., Q. Zhou, and C.F. Tsang. 2009. "Large-scale impact of CO₂ storage in deep saline aquifers: A sensitivity study on pressure response in stratified systems." *International Journal of Greenhouse Gas Control*. 3(2):181-194.
- Blueplanet. 2011. "World Climates." Accessed March 31, 2011 at <http://www.blueplanetbiomes.org/climate.htm>.
- Boden, T.A., G. Marland, and R.J. Andres. 2012. "Global, Regional, and National Fossil-Fuel CO₂ Emissions." Carbon Dioxide Information Analysis Center, Oak Ridge National Laboratory, U.S. Department of Energy. Accessed October 1, 2012 at http://cdiac.ornl.gov/trends/emis/tre_glob_2009.html.
- Bolt, Beranek, and Newman. 1971. *Noise from Construction Equipment and Operations, Building Equipment, and Home Appliances*. U.S. Environmental Protection Agency, Office of Noise Abatement and Control. Washington, D.C. December 31, 1971.
- Borgonie, G., A. Garcia-Moyano, D. Litthauer, W. Bert, A. Bester, E. van Heerden, C. Moller, M. Erasmus, and T.C. Onstott. 2011. "Nematoda From the Terrestrial Deep Subsurface of South Africa." *Nature*. 474(7349):79-82. June 2, 2011.
- Bowen, B.R., R.L. Ochoa, N.D. Wilkens, J. Brophy, T.R. Lovell, N. Fischietto, C.R. Medina, and J. A. Rupp. 2011. "Depositional and diagenetic variability within the Cambrian Mount Simon Sandstone: Implications for carbon dioxide sequestration." *Environmental Geosciences*. 18(2):69-89.
- Brower, R.D., A.P. Visocky, I.G. Krapac, B.R. Hensel, G.R. Peyton, J.S. Nealson, and M. Guthrie. 1989. *Evaluation of Underground Injection Industrial Waste in Illinois*. Illinois Scientific Surveys Joint Report 2. Illinois State Geological Survey, Department of Energy and Natural Resources. Champaign, Illinois.
- CCSP (Climate Change Science Program). 2008. *Scientific Assessment of the Effects of Global Change on the United States – Summary and Findings*. May 2008.
- CEQ (Council on Environmental Quality). 1997. "Environmental Justice Guidance under the National Environmental Policy Act" Executive Office of the President. Washington, D.C. December 10, 1997.

- CEQ. 2010a. "Draft NEPA Guidance on Consideration of the Effects of Climate Change and Greenhouse Gas Emissions." Executive Office of the President. February 18, 2010.
- CEQ. 2010b. "Guidance for Federal Greenhouse Gas Accounting and Reporting | The White House." Executive Office of the President. Washington, D.C. October 6, 2010.
- City of Jacksonville. 2002. "City of Jacksonville, Illinois-Comprehensive Plan." Adopted May 2002. Accessed August 8, 2012 at <http://www.jacksonvilleil.com/vertical/Sites/%7BDB68511E-E929-445F-86EA-BF8BABF6AE06%7D/uploads/%7B9E29EDFC-ADAC-4655-9DC5-C59F10330B2C%7D.PDF>.
- City of Jacksonville. 2012a. "Water Supply Information – Jacksonville." Accessed November 12, 2012 at http://www.jacksonvilleil.govoffice2.com/index.asp?Type=B_BASIC&SEC={F662B303-6E24-437F-AD33-7C66A0480361}.
- City of Jacksonville. 2012b. "Zoning Ordinance & Zoning Map-Jacksonville." Accessed August 7, 2012 at http://www.jacksonvilleil.com/index.asp?Type=B_BASIC&SEC={B9F8DDD8-9C91-4E87-AC5E-399C977531F8}.
- City of Jacksonville. 2012c. "Wastewater Treatment Plant - Jacksonville." Accessed September 18, 2012 at http://www.jacksonvilleil.com/index.asp?Type=B_BASIC&SEC=%7B97288BE8-54C8-4220-B1EB-514629859C41%7D.
- City of Jacksonville. 2012d "History of Jacksonville-Jacksonville." Accessed December 5, 2012 at http://www.jacksonvilleil.govoffice2.com/index.asp?Type=B_BASIC&SEC={A69B0752-CE5B-46E8-8CA9-E297734325BB}.
- Cluff, R. M., D.R. Dickerson. 1982. "Natural Gas Potential of the New Albany Shale Group (Devonian-Mississippian) in Southeastern Illinois." *Society of Petroleum Engineers Journal*. April 1982. 219-300.
- Cole, A. 2011. Personal Communication with Alex Cole, Water Attendant, North Morgan Water Cooperative. September 2, 2011.
- Colman, J.A., and R.F. Sanzolone. 1991. Surface Water-Quality Assessment of the Upper Illinois River Basin in Illinois, Indiana, and Wisconsin: Geochemical Data for Fine-Fraction Streambed Sediment from High- and Low-Order Streams, 1987. U.S. Geological Survey. Urbana, Illinois. Open-File Report 90-571.
- Commission for Environmental Cooperation. 2011. North American Terrestrial Ecoregions – Level III. April 2011. Accessed June 26, 2012 at ftp://ftp.epa.gov/wed/ecoregions/pubs/NA_TerrestrialEcoregionsLevel3_Final-2june11_CEC.pdf.
- Cowan, J.P. 1994. "Chapter 5, Noise Regulations, Guidelines, and Ordinances." In *Handbook of Environmental Acoustics*. John Wiley & Sons, Inc. New York, New York.
- Crone, A.J. and R.L. Wheeler. 2000. Data for Quaternary Faults, Liquefaction Features, and Possible Tectonic Features in the Central and Eastern United States and the Rocky Mountain Front. Open-File Report 00-0260.U.S. Department of Interior, U.S. Geological Survey.
- Dahl, T.E. 2011. Status and Trends of Wetlands in the Conterminous United States 2004 to 2009. U.S. Department of the Interior, Fish and Wildlife Service. Washington, D.C. 108 pp.
- Daycare Centers List. 2011. "Daycare centers near Meredosia and Jacksonville, Illinois." Accessed August 2011 at <http://www.yellowpages.com>.

- DNV (Det Norske Veritas). 2010. CO₂ Storage –Is it safe? Towards large-scale implementation of CCS. Research and Innovation. Høvik, Norway. Position Paper 06-2010.
- DOE (U.S. Department of Energy). 2002. Recommendations for Analyzing Accidents under the National Environmental Policy Act. U.S. Department of Energy, Environment, Safety and Health. July 2002.
- DOE. 2004. Recommendations for the Preparation of Environmental Assessment and Environmental Impact Statements, Second Edition. U.S. Department of Energy, Environment, Safety and Health. December 2004.
- DOE. 2006. Coal Combustion Waste Management at Landfills and Surface Impoundments, 1994-2004. U.S. Department of Energy, Office of Scientific and Technical Information. Oak Ridge, Tennessee. DOE/PI-0004. August 2006.
- DOE. 2007a. FutureGen Project Final Environmental Impact Statement. U.S. Department of Energy, National Energy Technology Laboratory. DOE/EIS-0394. November 2007.
- DOE. 2007b. Final Risk Assessment Report for the FutureGen Project Environmental Impact Statement. Revision 2. U.S. Department of Energy, National Energy Technology Laboratory. October 2007. Prepared by Tetra Tech, Inc. Lafayette CA.
- DOE. 2008a. DOE Handbook Temporary Emergency Exposure Limits for Chemicals: Methods and Practice. U.S. Department of Energy. DOE-HDBK-1046-2008. August 2008.
- DOE. 2008b. Finding of No Significant Impact, Midwest Geological Sequestration Consortium (MGSC) Phase III Large-Scale Test Environmental Assessment. U.S. Department of Energy, National Energy Technology Laboratory. November 28, 2008.
- DOE. 2008c. Final Environmental Assessment Midwest Geological Sequestration Consortium (MGSC) Phase III Large-Scale Field Test Phase, Decatur Illinois. U.S. Department of Energy, National Energy Technology Laboratory. DOE/EA-1626. October 2008.
- DOE. 2011a. Final Environmental Assessment Industrial Carbon Capture and Sequestration (ICCS) Area 1 Project. CO₂ Capture From Biofuels Production and Sequestration into the Mt. Simon Sandstone. Archer Daniels Midland Company, Decatur, Illinois. U.S. Department of Energy, National Energy Technology Laboratory. DOE/EA-1828. April 2011.
- DOE. 2011b. Mountaineer Commercial Scale Carbon Capture and Storage Project, Draft Environmental Impact Statement. U.S. Department of Energy, National Energy Technology Laboratory. DOE/EIS-0445D. February 2011.
- DOE. 2012. “DOE - Office of Legacy Management - EJ Definition and Policy.” Accessed at October 10, 2012 at http://www.lm.doe.gov/Office_of_the_Director/Environmental_Justice/EJ_Definition_and_Policy.aspx.
- Douglas, D. 2011. Personal Communication with Dusty Douglas, Morgan County Regional Planning Commission. April 8, 2011.
- E-Notes. 2011. “Hill-Burton Act (1946): Major Acts of Congress.” Accessed September 30, 2011 at <http://www.enotes.com/major-acts-congress/hill-burton-act/>.
- EIA (U.S. Energy Information Administration). 2009. Annual Energy Outlook 2009 with Projections to 2030. U.S. Department of Energy, Office of Integrated Analysis and Forecasting. Washington, D.C. DOE/EIA-0383. March 2009.

- EIA. 2011. Emissions of Greenhouse Gases in the United States 2009. March. U.S. Department of Energy, Independent Statistics and Analysis. Washington, D.C. March 2011.
- EIA. 2012. Annual Energy Outlook 2012, with Projections to 2035. U.S. Department of Energy, Office of Integrated Analysis and Forecasting. Washington, D.C. DOE/EIA-0383. June 2012.
- EIGA (European Industrial Gases Association). 2004. Prevention of Major Accidents, Guidance on Compliance with Seveso II Directive. Brussels, Belgium. IGC Doc 60/04/E.
- Ellsworth, W. L., S.H. Hickman, A.L. Lleons, A. McGarr, A.J. Michael, and J. L. Rubinstein. 2012. Are Seismicity Rate Changes in the Midcontinent Natural or Manmade? Seismological Society of America Annual Meeting Abstract. April 18, 2012.
- ENVCAP (Environmental Compliance Assistance Platform). 2011. "TSD & Recycling Facilities Locator." Accessed July 28, 2011 at www.envcap.org/statetools/tsdf/tsdf2.cfm
- EO (U.S. Executive Order) 12898. February 11, 1994. Federal Actions to Address Environmental Justice in Minority Populations and Low-Income Populations. *Federal Register* [Volume 59, Number 32]. February 16, 1994.
- EO 13432. May 14, 2007. Cooperation Among Agencies in Protecting the Environment with Respect to Greenhouse Gas Emissions from Motor Vehicles, Nonroad Vehicles, and Nonroad Engines. *Federal Register* [Volume 72, Number 94]. May 16, 2007.
- EO 13514. October 5, 2009. Federal Leadership in Environmental, Energy and Economic Performance. *Federal Register* [Volume, 74. Number 194]. October 8, 2009.
- Ermak, D. L. 1990. "User's Manual for SLAB: An Atmospheric Dispersion Model for Denser-Than-Air Releases." Atmospheric and Geophysical Sciences Division, University of California, Lawrence Livermore National Laboratory. UCRL-MA-105607. June 1990. Accessed October 27, 2010 at <http://www.epa.gov/scram001/models/nonepa/SLAB.PDF>.
- Etheridge, D.M., L.P. Steele, R.L. Langenfelds, R.J. Francey, J.-M. Barnola, and V.I. Morgan. 1996. "Natural and anthropogenic changes in atmospheric CO₂ over the last 1000 years from air in Antarctic ice and firn." *Journal of Geophysical Research*. 101:4115-4128. Data updated July 20, 2010. Accessed September 25, 2012 at http://www.ncdc.noaa.gov/paleo/icecore/antarctica/law/law_data.html.
- FAA (U.S. Federal Aviation Administration). 2012. "AirNav: Airport Search Results." Accessed November 30, 2012 at <http://www.airnav.com/cgi-bin/airport-search>.
- Farzan, H. 2011. Development of Cost Effective Oxy-Combustion Retrofitting for Coal-Fired Boilers. Final Report for April 1, 2006 through December 31, 2010.
- FBI (Federal Bureau of Investigation). 2009. "Crime in the United States, Police Employee Data, 2009." Accessed October 4, 2011 at <http://www2.fbi.gov/ucr/cius2009/police/index.html>.
- FBI. 2011. "Table 1, Crime in the United State by Volume and Rate per 100,000 Inhabitants, 1990-2009." Accessed October 7, 2011 at http://www2.fbi.gov/ucr/cius2009/data/table_01.html.
- FEMA (U.S. Federal Emergency Management Agency). 2009. Flood Insurance Rate Map, Morgan County Illinois and Incorporated Areas, Panel 4 of 350. Map Number 17137C0004D. Effective August 18, 2009.

- FEMA. 2011. "National Flood Hazard Panel Layer." State of Illinois GIS Shapefile. U.S. Federal Emergency Management Agency, Washington, DC. Map Service Center request submitted March 29, 2011, at <http://www.msc.fema.gov>.
- FHWA (Federal Highway Administration). 1995. Highway Traffic Noise Analysis and Abatement Policy and Guidance. U.S. Department of Transportation, Federal Highway Administration. Washington, D.C. June 1995.
- FHWA. 2004. FHWA "TNM V25 - Traffic Noise Model – Noise- Environment – FHWA." Accessed December 3, 2012 at http://www.fhwa.dot.gov/environment/noise/traffic_noise_model/tnm_v25/.
- FHWA. 2006. "Highway Traffic and Construction Noise – Problem and Response - Regulations And Legislation, Regulations, & Guidance." Accessed December 3, 2012, at http://www.fhwa.dot.gov/environment/noise/regulations_and_guidance/probresp.cfm#t9.
- Finley, R. 2005. An Assessment of Geological Carbon Sequestration Options in the Illinois Basin. Final Report for Midwest Geological Sequestration Consortium under US DOE Contract DE-FC26-03NT41994. Illinois State Geological Survey. Champaign, Illinois. December 31, 2005.
- Flora of North America. undated. "Melanthium virginicum in Flora of North America @efloras.org." Accessed March 25, 2011 at http://www.efloras.org/florataxon.aspx?flora_id=1&taxon_id=220008304.
- Frohlich, C. C. Hayward, B. Stump, and E. Potter. 2011. "The Dallas-Fort Worth Earthquake Sequence: October 2008 through May 2009." *Bulletin of the Seismological Society of America*. 101(1):327-340.
- FTA (Federal Transit Administration). 2006. Transit Noise and Vibration Impact Assessment. Federal Transit Administration, Office of Planning and Environment. Washington, D.C. FTA-VA-90-1003-06. May 2006.
- Gibb, J.P., D.C. Noel, W.C. Bogner, and R.J. Schict. 1979. Groundwater Conditions and River-Aquifer Relationships along the Illinois Waterway. Illinois State Water Survey. Urbana, IL. 1979.
- Griffith, C.A., D.A. Dzombak, and G.V. Lowry. 2011. "Physical and chemical characteristics of potential seal strata in regions considered for demonstrating geological saline CO₂ sequestration." *Environmental Earth Sciences* 64(4): 925-948.
- Hajic, E.R. and D.S. Leigh. 1985. Geomorphology and Limited Cultural Resource Investigation of the Meredosia Village and Meredosia Lake Levee and Drainage Districts, Scott, Morgan, and Cass Counties, Illinois. U.S. Army Corps of Engineers. St. Louis, Missouri. St. Louis District Cultural Resource Management Report 17. April 1985.
- Hanna, S. R. and P. J. Drivas. 1987. *Guidelines for use of Vapor Cloud Dispersion Models*. Center for American Institute of Chemical Engineers. New York, New York.
- Health Resources and Services Administration. 2011. "HRSA Data Warehouse – Report Tool, Basic Health Professional Shortage Area (HPSA) Report for Primary Medical Care." Accessed December 6, 2011 at http://datawarehouse.hrsa.gov/HGDWReports/RT_App.aspx?rpt=HH.
- Herkert, J.E., and J.E. Ebinger, editors. 2002. Endangered and Threatened Species of Illinois: Status and Distribution, Volume 1 – Plants. Illinois Endangered Species Protection Board. Springfield, Illinois.
- HHS (U.S. Department of Health and Human Services). 2000. "2000 HHS Poverty Guidelines." Accessed August 28, 2012 at <http://aspe.hhs.gov/poverty/figures-fed-reg.shtml>.

- HHS. 2010. "August 2010 HHS Poverty Guidelines." Accessed August 28, 2012 at <http://aspe.hhs.gov/poverty/10poverty.shtml>.
- Hill, S.R. 2006. Conservation Assessment for the Fibrous-Rooted Sedge. Illinois Natural History Survey. Center for Wildlife and Plant Ecology Technical Report 2006 (7). June 30, 2006.
- Holzman. 2010. Analysis of Cooling Tower Impacts at IL 104 Alternative #9 due to Meredosia Energy Center. Prepared for Illinois Department of Transportation, Division of Highways, Region 4, District 6 by M.I. Holzman and Associates, LLC. Springfield, Illinois. July 2010.
- Hooper, B., L. Murray, and C. Gibson-Polle, eds. 2005. Latrobe Valley CO₂ Storage Assessment, Final Report. Cooperative Research Centre for Greenhouse Gas Technologies. Melbourne, Australia. RPT05-108. November 2005.
- HUD (U.S. Housing and Urban Development). 1985. The Noise Guidebook. Department of Housing and Urban Development, Office of Environment and Energy. HUD-953-CPD. March 1985.
- HUD. 2010. "HUD Census Tract Map." Online GIS map application. Accessed August 4, 2010 at <http://209.48.228.153/qctmap.html#>.
- Hull, D. 2011. Personal Communication with Dusty Hull, Water Superintendent, Meredosia Water Plant. July 13, 2011.
- Hull, D. 2012a. Personal Communication with Dusty Hull, Water Superintendent, Meredosia Water Plant. August 31, 2012.
- Hull, D. 2012b. Personal Communication with Dusty Hull, Water Superintendent, Meredosia Water Plant. August 15, 2012.
- IDNR (Illinois Department of Natural Resources). 1997. Embarras River Area Assessment – Volume 3: Living Resources. Illinois Department of Natural Resources, Critical Trends Assessment Program.
- IDNR. 1998. Big Rivers Area Assessment – Volume 3: Living Resources. Illinois Department of Natural Resources, Critical Trends Assessment Program.
- IDNR. 2000. Kaskaskia River Area Assessment – Volume 3: Living Resources. Illinois Department of Natural Resources, Critical Trends Assessment Program.
- IDNR. 2001. Lower Sangamon River Area Assessment – Volume 3: Living Resources. January. Illinois Department of Natural Resources, Critical Trends Assessment Program.
- IDNR. 2003. La Moine River Area Assessment – Volume 3: Living Resources. Illinois Department of Natural Resources, Critical Trends Assessment Program.
- IDNR. 2006. Floodplain Management – Local Floodplain Administrator's Manual. Illinois Department of Natural Resources, Office of Water Resources. March 2006.
- IDNR. 2009a. 100-Year Floodplain in Illinois. Illinois Department of Natural Resources, Office of Water Resources. August 6, 2009.
- IDNR. 2009b. "Illinois Natural Areas Inventory (INAI) Sites by County. Illinois Department of Natural Resources." August 2009. Accessed September 11, 2012 at https://dnr.state.il.us/conservation/naturalheritage/pdfs/inai_list_by_co_aug2009.pdf.
- IDNR. 2011. Illinois Threatened and Endangered Species by County. Illinois Department of Natural Resources, Division of Natural Heritage. Updated September 12, 2011.

- IDNR. 2012. "Fishing in Illinois. The Illinois River Fact Sheet." Accessed September 24, 2012 at <http://www.ifishillinois.org/profiles/rivers&creeks/Illinois/IllinoisRiv.html>.
- IDOA (Illinois Department of Agriculture). 2012. Agricultural Impact Mitigation Agreement between the FutureGen Industrial Alliance and the Illinois Department of Agriculture in Illinois, Pertaining to the Construction of up to a 12-inch Carbon Dioxide Pipeline and Related Appurtenances. January 20, 2012.
- IDOT (Illinois Department of Transportation). 2002. *Final Environmental Impact Statement U.S. 67 (FAP 310) Between Jacksonville and Macomb*. Illinois Department of Transportation. FHWA-IL-EIS-00-02-F. May 2002. Accessed June 26, 2012 at <http://www.dot.state.il.us/desenv/rt67impact/cover.pdf>.
- IDOT. 2006. "Illinois Railroad Map." Illinois Department of Transportation, Office of Planning and Programming. January 2006. Accessed July 27, 2012 at <http://www.dot.il.gov/officialrailmap.pdf>.
- IDOT. 2011. Environmental Assessment, Illinois Route 104 (FAP Route 745) over Illinois River, Village of Meredosia, Morgan & Pike Counties, Illinois. Illinois Department of Transportation, Division of Highways, Region 4, District 6. Job #: D96-016-08. April 2011.
- IDOT. 2012a. FY 2007-2012 Proposed Highway Improvement Program, Highway District 6. Illinois Department of Transportation, Region 4, District 6.
- IDOT. 2012b. "Getting Around Illinois - Average Daily Traffic Counts." Online GIS map application. Accessed July 26, 2012 at <http://www.gettingaroundillinois.com/gai.htm?mt=aadt>.
- IDOT. 2012c. "Illinois High Speed Rail –Chicago to St. Louis: 2010 Construction Map." Accessed December 4, 2012 at http://www.idothsr.org/pdf/trt_construction_location.pdf.
- IDPH (Illinois Department of Public Health). 2011. "Licensed Illinois Hospitals by City." July 5, 2011. Accessed November 9, 2011 at www.idph.state.il.us/healthcarefacilities/Hospitals_by_City.pdf.
- IDPH. 2012. "Illinois Hospital Report Card and Consumer Guide to Health Care." Accessed February 15, 2012 at www.healthcarereportcard.illinois.gov.
- IEA (International Energy Agency). 2005. IEA GHG Weyburn CO₂ Monitoring & Storage Project. IEA Greenhouse Gas R&D Programme. Cheltenham, United Kingdom.
- IEA. 2006a. Natural Releases of CO₂. IEA Greenhouse Gas R&D Programme. Cheltenham, United Kingdom.
- IEA. 2006b. Safe Storage of CO₂: Experience from the Natural Gas Storage Industry. IEA Greenhouse Gas R&D Programme. Technical Study Report Number: 2006/2. January 2006.
- IEMA (Illinois Emergency Management Agency). 2009. The ABC's of Radon in Illinois. Illinois Emergency Management Agency. IEMA 012-20,000. May 2009.
- IEMA. 2010. Illinois Emergency Operations Plan, Basic Plan and Emergency Support Function Annexes. Illinois Emergency Management Agency. September 2010.
- IEMA. 2011. "Welcome to IEMA | About IEMA." Accessed November 30, 2011 at <http://www.iema.illinois.gov/iema/about/>.
- IEMA. 2012a. "Illinois County by Zip Code % Greater than 4pCi/L." Accessed August 15, 2012 at <http://www.radon.illinois.gov/iema/radon/MeasurementMaps/Morgan.pdf>.

- IEMA. 2012b. "Number of Mitigation Systems in Country by Zip Code." Accessed August 15, 2012 at <http://www.radon.illinois.gov/iema/radon/MitigationMaps/Morgan.pdf>.
- IEPA (Illinois Environmental Protection Agency). 2009. Illinois Annual Air Quality Report 2008. Illinois Environmental Protection Agency, Bureau of Air. Springfield, Illinois. November 2009.
- IEPA. 2010a. Illinois Annual Air Quality Report 2009. Illinois Environmental Protection Agency, Bureau of Air. Springfield, Illinois. November 2010.
- IEPA. 2010b. "Category 5- 303(d) List." In *Draft Illinois Integrated Water Quality Report and Section 303(d) List-2010*. Illinois Environmental Protection Agency, Bureau of Water. Accessed February 23, 2011 at <http://www.epa.state.il.us/water/tmdl/303d-list.html>.
- IEPA. 2011a. 4th Annual Air Quality Report, Illinois 2010. Illinois Environmental Protection Agency, Bureau of Air. Springfield, Illinois. December 2011.
- IEPA. 2011b. "Illinois Climate Change Advisory Group." Accessed April 6, 2011 at <http://www.epa.state.il.us/air/climatechange/>.
- IEPA. 2011c. Illinois EPA's Ash Impoundment Strategy Progress Report. Illinois Environmental Protection Agency, Water Pollution Control. October 2011.
- IEPA. 2011d. Reissued NPDES Permit Number IL0000116 to Ameren Energy Generating Company. Illinois Environmental Protection Agency, Division of Water Pollution Control. Issued September 30, 2011.
- IEPA. 2011e. Hazardous Waste Generation and Management, 1987-2009. Illinois Environmental Protection Agency, Bureau of Land. Springfield, Illinois.
- IEPA. 2011f. Meteorological Data and Wind Rose for Station #93822 Springfield Capital Airport. November 16, 2011.
- IEPA. 2012a. "Appendix A-2: Illinois' 2012 303(d) List, Alphabetically by Water Body Name." In *Illinois Integrated Water Quality Report and Section 303(d) List – Volume I: Surface Water – 2012*. Illinois Environmental Protection Agency, Bureau of Water. March 7, 2012.
- IEPA. 2012b. "Non-Special Waste Certification Fact Sheet-Illinois EPA-Bureau of Land." Accessed September 17, 2012 at <http://www.epa.state.il.us/land/waste-mgmt/non-special-waste.html>.
- IEPA. 2012c. Nonhazardous Solid Waste Management and Landfill Capacity in Illinois: 2011. Illinois Environmental Protection Agency, Bureau of Land. July 2012.
- IHPA (Illinois Historic Preservation Agency). 2011a. SHPO Concurrence Letter for *Phase I Cultural Resources Survey for the Site Characterization Locale*. June 1, 2011.
- IHPA. 2011b. SHPO Concurrence Letter for *Phase I Cultural Resources Survey for the Soil Gas Monitoring Locations*. November 29, 2011.
- ILGA (Illinois General Assembly). 2009. "Public Act 95-1027, effective date June 1, 2009. SB 1987 Clean Coal Portfolio Standard Law. Amendment to the Illinois Power Agency Act 20 ILCS 3855, effective date August 28, 2007." Accessed April 6, 2011 at <http://www.ilga.gov/legislation/publicacts/95/095-1027.htm>.
- Illinois Commerce Commission. 2013a. Illinois Commerce Commission On Its Own Motion, Phase 2 of the initial approvals for FutureGen Industrial Alliance, Inc. Docket Number: 13-0034. June 26, 2013.**

Illinois Commerce Commission. 2013b. FutureGen Industrial Alliance, Inc. Application for a Certificate Authorizing the Construction and Operation of a Carbon Dioxide Pipeline. Case Number: 13-0252. March 29, 2013.

Illinois EO (Executive Order) 2006-11. 2006. Illinois Executive Order on Climate Change and Greenhouse Gas Reduction. October 5, 2006.

Illinois State Museum. 2012 “Illinois Agriculture-People.” Accessed December 3, 2012 at <http://www.museum.state.il.us/exhibits/agriculture/htmls/people/index.html>.

IPCB (Illinois Pollution Control Board). 2007. Environmental Regulations for the State of Illinois; State of Illinois, Title 35 of the Illinois Administrative Code, Subtitle H, Part 901: Sound Emission Standards and Limitations for Property Line Noise Sources. Last amended January 2007. Accessed July 8, 2011 at <http://www.ipcb.state.il.us/SLR/IPCBandIEPAEnvironmentalRegulations-Title35.asp>.

IPCC (Intergovernmental Panel on Climate Change). 2005. IPCC Special Report on Carbon Dioxide Capture and Storage. Prepared by Working Group III of the Intergovernmental Panel on Climate Change [B. Metz, O. Davidson, H.C. de Coninck, M. Loos and L.A. Meyer (eds.)]. Cambridge University Press, Cambridge, United Kingdom and New York, New York. 2005.

IPCC. 2007. Climate Change 2007: Synthesis Report. Contribution of Working Groups I, II and III to the Fourth Assessment Report of the Intergovernmental Panel on Climate Change. Geneva, Switzerland.

IPCC. 2011. IPCC Special Report on Renewable Energy Sources and Climate Change Mitigation. Prepared by Working Group III of the Intergovernmental Panel on Climate Change [O. Edenhofer, R. Pichs-Madruga, Y. Sokona, K. Seyboth, P. Matschoss, S. Kadner, T. Zwickel, P. Eickemeier, G. Hansen, S. Schlömer, C. von Stechow (eds.)]. Cambridge University Press, Cambridge, United Kingdom and New York, New York.

ISGS (Illinois State Geological Survey). 1995a. “Structural Features in Illinois - 1995 - Line Features (Axial or Flexure) of Anticlines, Synclines and Monoclines.” ISGS GIS Database GISDB_BEDGEO.IL_Struct_Feat_Clines_1995_Ln. Illinois State Geological Survey, Champaign, Illinois. GIF accessed September 11, 2012 at <http://www.isgs.illinois.edu/nsdihome/browse/statewide/structclinesb.gif>.

ISGS. 1995b. “Structural Features in Illinois – 1995 – Faults.” ISGS GIS Database GISDB_BEDGEO.IL_Struct_Feat_Faults_1995_Ln. Illinois State Geological Survey, Champaign, Illinois. GIF accessed September 11, 2012 at <http://www.isgs.illinois.edu/nsdihome/browse/statewide/structfaultsb.gif>.

ISGS. 2004. Generalized Statewide Location of Major Bedrock, Sand and Gravel, and Potential Shallow Aquifers in Illinois. Vector digital data from ISGS GIS database. Illinois State Geological Survey, Champaign, Illinois. Available online at <http://www.isgs.illinois.edu/>.

ISGS. 2005. Bedrock Geology of Illinois. Compiled by D.R. Kolata. Illinois State Geological Survey, Champaign, Illinois. Illinois Map 14. 2005.

ISGS. 2009. “Historical Earthquakes of Illinois (magnitude 4.5 or greater).” Accessed May 2, 2012 at <http://www.isgs.uiuc.edu/research/earthquake-hazards/eq-of-il-big.shtml>.

ISGS. 2011a. “Quaternary Deposits 8.5x11 map series.” Accessed February 25, 2011 at <http://www.isgs.illinois.edu/sections/quat/deposit-map.shtml>.

- ISGS. 2011b. "Loess Thickness Map." Accessed July 12, 2011 at http://www.isgs.illinois.edu/maps-data-pub/pdf-files/loess_thickness.pdf.
- ISGS. 2011c. Preliminary Environmental Site Assessment Final Report. Illinois State Geological Survey Report for the Environmental Assessment, Illinois Route 104 (FAP Route 745). IDOT Job #: D96-016-08. ISGS 1739V. February 8, 2011.
- ISGS. 2012a. "Physiographic Divisions of Illinois." Accessed December 6, 2012 at <http://www.isgs.illinois.edu/maps-data-pub/publications/pdf-files/physio-w-color-8x11.pdf>.
- ISGS. 2012b. "Illinois Oil and Gas Resources Internet Map Service." Illinois State Geological Survey. Champaign, Illinois. Query performed and data downloaded September 6, 2012 at <http://www.isgs.illinois.edu/sections/oil-gas/launchims.shtml>.
- ISGS. 2012c. "Illinois Water Well Internet Map Service." Illinois State Geological Survey. Champaign, Illinois. Query performed and data downloaded September 6, 2012 at <http://www.isgs.illinois.edu/maps-data-pub/wwdb/launchims.shtml>.
- ISGS. 2012d. "Map of oil and gas fields and natural gas storage areas." Accessed May 2, 2012 at <http://moulin.isgs.uiuc.edu/ILOIL/webapp/ILOIL.html>.
- ISGS. 2012e. "ISGS –Earthquake Maps." Accessed May 2, 2012 at <http://www.isgs.uiuc.edu/research/earthquake-hazards/earthquake-maps.shtml>.
- ISP (Illinois State Police). 2009. Section II- Crime Index Offense/Crime Rate Data. In *Crime in Illinois 2009*. Illinois State Police, Illinois Uniform Crime Reporting Program.
- ISP. 2012. "District Quick Finder." Accessed February 13, 2012 at www.isp.state.il.us/districts/districtfinder.cfm.
- ISWS (Illinois State Water Survey). 1996. "One-Hundred and Five-Hundred Year Floodzones for Unincorporated Areas in Illinois." ISGS GIS Database GISDB_HYDRO_IL_Flood_Zones_1986_Py. Illinois State Water Survey, Champaign, Illinois. Downloaded May 2011 at <http://www.isgs.illinois.edu/>.
- ISWS. 2012. "ISWS-Illinois Water Supply Planning: Water Supply-Ground Water." Accessed September 12, 2012 at <http://www.isws.illinois.edu/wsp/wsground.asp>.
- ISWS. 2013. "Illinois State Water Survey-Climate Data-Results, University of Illinois at Urbana-Champaign." Illinois State Climatologist Data. Data Results for station 114442 (Jacksonville). Accessed March 25, 2011 and February 4, 2013 at <http://www.isws.illinois.edu/data/climatedb/data.asp>.
- Jacksonville Municipal Department. 2012. Personal Communication with Jacksonville Municipal Department. August 15, 2012.
- Jones and Stokes. 2004. Transportation- and Construction-Induced Vibration Guidance Manual. (J&S 02-039.) Sacramento, CA. Prepared for California Department of Transportation, Noise, Vibration, and Hazardous Waste Management Office, Sacramento, California. June 2004.
- Journal Courier. 2010. "Virginia primed for new water plant." *Journal Courier*. May 24, 2010.
- Journal Courier. 2011. "Timetable on boil order unchanged." *Journal Courier*. June 25, 2011.
- Kluge, R. 2012. Personal Communication with Rick Kluge, Fire Chief, Jacksonville Fire Department. August 8, 2012.

- Klusman, R.W. 2003. "A geochemical perspective and assessment of leakage potential for a mature carbon dioxide-enhanced oil recovery project and as a prototype for carbon dioxide sequestration; Rangely field, Colorado." *American Association of Petroleum Geologists Bulletin*. 87(9):1485-1507.
- Kottek, M., J. Grieser, C. Beck, B. Rudolf, and F. Rubel. 2006. "World Map of Köppen-Geiger Climate Classification updated." *Meteorologische Zeitschrift*. 15(3):259-263.
- Lamancusa, J. 2009. "Noise Control – Outdoor Sound Propagation." Pennsylvania State University, Department of Mechanical and Nuclear Engineering. July 20, 2009. Accessed May 3, 2011 at http://www.mne.psu.edu/lamancusa/me458/10_osp.pdf.
- Leetaru, H.E. and J.H. McBride. 2009. "Reservoir uncertainty, Precambrian topography, and carbon sequestration in the Mt. Simon Sandstone, Illinois Basin." *Environmental Geosciences*. 16(4):235-243.
- Lemieux, J.-M. 2011. "Review: The potential impact of underground geological storage of carbon dioxide in deep saline aquifers on shallow groundwater resources." *Hydrology Journal*. 19:757-778.
- Lichvar, R.W. 2012. The National Wetland Plant List. Cold Regions Research and Engineering Laboratory. Hanover, NH. ERDC/CRREL TR-12-11. October 2012.**
- Liu, D. and Lipták, B. 1997. *Environmental Engineers' Handbook*. 2nd Edition. Lewis Publishers.
- Liu, F., P. Lu, C. Zhu, and Y. Xiao. 2011. Coupled Reactive Flow and Transport Modeling of CO₂ Sequestration in the Mount Simon Sandstone Formation, Midwest, USA. Presentation at AAPG Annual convention and Exhibition. Houston, TX. April 10-13, 2011.**
- Liu, F., P. Lu, C. Griffith, S.W. Hedges, Y. Soong, H. Hellevang, and C. Zhu. 2012. "CO₂-brine-caprock interaction: Reactivity experiments on Eau Claire shale and a review of relevant literature." *International Journal of Greenhouse Gas Control*. 7:153-167.**
- Liu, Q. and M.M. Maroto-Valer. 2011. "Parameters affecting mineral trapping of CO₂ sequestration in brines." *Greenhouse Gases Science and Technology*. 1:211-222.
- MABAS (Mutual Aid Box Alarm System). 2011. "About MABAS-IL Home." Accessed December 2, 2011 at <http://portal.mabas-il.org/AboutMABAS/Pages/MABASOverview.aspx>.
- Massachusetts v. U.S. Environmental Protection Agency. 2007. 549 U.S. 497 (2007).
- McColpin, G.R. 2009. "Surface Deformation Monitoring As a Cost Effective MMV Method." *Energy Procedia*. 1:2079-2086.
- MDNR (Missouri Department of Natural Resources). 2012. "Bonne Terre-DNR." Air Monitoring Data from the Bonne Terre Site. Division of Environmental Quality, Environmental Services Program. Accessed March 15, 2012 at <http://www.dnr.mo.gov/env/esp/aqm/bonne-terre.htm>.
- MGA (Midwestern Governors Association). 2012. "Midwestern Governors Association – Initiatives - CCS Task Force." Accessed November 28, 2012 at <http://www.midwesterngovernors.org/CCS.htm>.
- MGSC (Midwest Geological Sequestration Consortium). 2012. "Midwest Geological Sequestration Consortium." Accessed November 28, 2012 at <http://sequestration.org/>.
- Midwest Technology Assistance Center. 2009. Groundwater Availability at Versailles, Illinois (Brown County). Midwest Technology Assistance Center.

- Minnis A.M., S.D. Sipes, and D.J. Gibson. 2006. Analysis of Illinois Plants in Need of Conservation – a Supplement to the Comprehensive Wildlife Conservation Plan. Department of Plant Biology and Center for Ecology, Southern Illinois University Carbondale. May 31 2006.
- Missouri Department of Conservation. 2011. “Illinois Chorus Frog.” Accessed March 25, 2011 at <http://mdc.mo.gov/discover-nature/field-guide/illinois-chorus-frog>.
- Morgan County. 2009. Morgan County Flood Damage Prevention Ordinance. August 3, 2009.
- Morgan County. 2012. “Regional Planning Commission.” Access August 31, 2012 at <http://www.morgan-county-il.com/Regional-Planning-Commission.html>.
- Morozova, D., M. Zettlitzer, A. Vieth, and H. Würdemann. 2010. “Microbial Community Response to the CO₂ Injection and Storage in the Saline Aquifer, Ketzin, Germany.” *Geophysical Research Abstracts*. 12:EGU2010-11146-1.
- MPCA (Minnesota Pollution Control Agency). 1999. A Guide to Noise Control in Minnesota. Acoustical Properties, Measurement, Analysis, Regulation. Minnesota Pollution Control Agency, Noise Program. Saint Paul, Minnesota. March 1999.
- National Cooperative Soil Survey. 2006. “Official Series Description – PLAINFIELD Series.” October 2006. Accessed March 21, 2011 at <http://www2.ftw.nrcs.usda.gov/osd/dat/P/PLAINFIELD.html>
- NatureServe. 2010. “NatureServe Explorer.” Online database. Accessed October 3, 2012 at <http://www.natureserve.org/explorer/>.
- Naymik, T.G., and M.J. Barcelona. 1981. “Characterization of a Contaminant Plume in Ground Water, Meredosia, Illinois.” *Ground Water*. 19 (5):517-526.
- NCDC (National Climate Data Center). 2011a. “Average Relative Humidity.” Accessed November 13, 2012 at <http://www1.ncdc.noaa.gov/pub/data/ccd-data/relhum11.txt>.
- NCDC. 2011b. Storm Events Database. Accessed March 25, 2011 and July 5, 2011 at <http://www.ncdc.noaa.gov/stormevents/ftp.jsp>.
- NCDC. 2013. “Summary of Monthly Normals 1981-2010.” Accessed February 5, 2013 at <http://www.ncdc.noaa.gov/cdo-web/#t=secondTabLink>.
- NCES (National Center for Education Statistics). 2011a. Numbers and Types of Public Elementary and Secondary Schools From the Common Core of Data: School Year 2009–10. U.S. Department of Education, National Center for Education Statistics. NCES 2011-345. April 2011.
- NCES. 2011b. Characteristics of Private Schools in the United States: Results From the 2009–10 Private School Universe Survey. U.S. Department of Education, National Center for Education Statistics. NCES 2011-339. May 2011.
- NCES. 2012. “School Search, Public School Districts and Private Schools, 2009-2010 School Year.” National Center for Education Statistics. Accessed February 15, 2012 at <http://nces.ed.gov/>.
- Nelson, W. J. 1995. “ISGS-Fault Systems of Illinois and Neighboring States.” Figure 2. Fault map for Illinois and neighboring states. In *Illinois State Geological Survey Bulletin 100*. Updated September 9, 2009. Accessed May 2, 2012 at <http://www.isgs.uiuc.edu/research/earthquake-hazards/earthquake-maps.shtml>.
- NETL (National Energy Technology Laboratory). 2008. Pulverized Coal Oxycombustion Power Plants. DOE/NETL-2007/1291. Volume 1: Bituminous Coal to Electricity. Final Report. Revision, August 2008.

- NETL. 2010a. 2010 Carbon Sequestration Atlas of the United States and Canada, Third Edition. November 2010.
- NETL. 2010b. Understanding the Impact of CO₂ Injection on the Subsurface Microbial Community in an Illinois Basin CCS Reservoir: Integrated Student Training in Geoscience and Geomicrobiology. Project Fact Sheet FE0002421. July 2010.
- NETL. 2012a. 2012 Carbon Utilization and Storage Atlas, Fourth Edition. December 2012.**
- NETL. 2012b. Best Practices for: Monitoring, Verification, and Accounting of CO₂ Stored in Deep Geologic Formations - 2012 Update. Second Edition. DOE/NETL-2012/1568. October 2012.
- NETL. 2012c. Archer Daniels Midland Company: CO₂ Capture from Biofuels Production and Storage into the Mt. Simon Sandstone. Industrial Carbon Capture and Storage Project Facts. Project Fact Sheet ARRA1547. March 2012.
- NETL. 2013a. DOE/NETL Advanced Carbon Dioxide Capture R&D Program: Technology Update. May 2013. Accessed August 27, 2013 at <http://www.netl.doe.gov/technologies/coalpower/ewr/pubs/CO2Handbook/CO2-Capture-Tech-Update-2013-Chapters.pdf>.**
- NETL. 2013b. Best Practices for: Carbon Storage Systems and Well Management Activities. DOE/NETL-2013/1604. 2013 Revised Edition. April 2013.**
- NETL. 2013c. Best Practices for: Site Screening, Site Selection, and Initial Characterization for Storage of CO₂ in Deep Geologic Formations. DOE/NETL-2013/1605. 2013 Revised Edition. June 2013.**
- NETL. 2013d Best Practices for: Risk Analysis and Simulation for Geologic Storage of CO₂. DOE/NETL-2013/1603. 2013 Revised Edition. June 2013.**
- NFPA (National Fire Protection Association). 2010. *Guide to Hazardous Materials*, 14th Edition. Edited by Guy R. Colonna, PE. National Fire Protection Association. Quincy, Massachusetts. 2010.
- NIOSH (National Institute of Occupational Safety and Health). 2005. "CDC-Immediately Dangerous to Life or Health Concentrations (IDLHs): Chemical Listings and Documentation." Accessed April 23, 2012 at <http://www.cdc.gov/niosh/idlh/intridl4.html>.
- NOAA (National Oceanic and Atmospheric Administration). 2011. "Trends in Atmospheric Carbon Dioxide." Recent Mauna Loa CO₂. Accessed April 6, 2011 at <http://www.esrl.noaa.gov/gmd/ccgg/trends/>.
- NOAA. 2012. "Earth System Research Laboratory/Global Monitoring Division FTP Data Finder." Accessed September 30, 2012 at <http://www.esrl.noaa.gov/gmd/dv/data/>.
- NOAA Fisheries Service. 2012. "About National Marine Fisheries Service." Accessed September 5, 2012 at <http://www.nmfs.noaa.gov/aboutus/aboutus.html>.
- NPS (National Park Service). 2011. "NPS: Explore Nature-Air Resources Division-Class I Locations." Air Resources Division. Accessed March 10, 2011 at <http://www.nature.nps.gov/air/Maps/classILoc.cfm>.
- NRC (National Research Council). 2012. *Induced Seismicity Potential in Energy Technologies*. The National Academies Press, Washington, D.C. 2012.
- O'Connor, W.K. and G.E. Rush. 2005. CO₂ Flood Tests on Whole Core Samples of the Mt. Simon Sandstone, Illinois Basin. Office of Fossil Energy, Albany Research Center. Albany, Oregon. DOE/ARC-2005-013.

- Obermeier, S.F. and Crone, A.J., compilers. 1994. "Fault number 1024, Wabash Valley liquefaction features in Quaternary fault and fold database of the United States." U.S. Geological Survey. Accessed May 2, 2012 at <http://earthquake.usgs.gov/regional/qfaults>.
- Oldenburg, C.M. 2012. "The risk of induced seismicity: is cap-rock integrity on shaky ground?" Editorial. *Greenhouse Gases Science and Technology*. 2:217-218.
- Oldenburg, C.M., and A.P Rinaldi. 2011. "Buoyancy Effects on Upward Brine Displacement Caused by CO₂ Injection." *Transportation Porous Medium*. 87:525-540.
- Ong, C. 2012. Personal communication with Cliff White, DOE, Gregg Hagerty, URS, Lucy Swartz, Alliance, Thomas Anderson, PNNL, Amanda Stegen, PNNL, Fred Carey, PHE and Anthony Becker, PHE. "FG2 – FWS and DNR meetings." February 21, 2012.
- Onuma, T. and S. Ohkawa. 2009. "Detection of surface deformation relates with CO₂ injection by DInSAR at In Salah, Algeria." *Energy Procedia*. 1:2177-2184.
- OPS (Office of Pipeline Safety). 2012a. "PHMSA: Stakeholder Communications. All Reported Pipeline Incidents 1992-2011." Pipeline and Hazardous Materials Safety Administration, Office of Pipeline Safety. Accessed July 17, 2012 at <http://primis.phmsa.dot.gov/comm/reports/safety/AllPSI.html?nocache=4194>.
- OPS. 2012b. "PHMSA: Stakeholder Communications." Significant Pipeline Incidents by Cause. Pipeline and Hazardous Materials Safety Administration, Office of Pipeline Safety. Accessed February 23, 2012 at January 2012 http://primis.phmsa.dot.gov/comm/reports/safety/SerPSIDet_1992_2011_US.html?nocache=7008.
- OPS. 2012c. "PHMSA-Data & Statistics – Distribution, Transmission, and Liquid Accident and Incident Data." Pipeline Safety Detailed Incident Online Database for Natural Gas and Hazardous Liquid pipelines, including CO₂ pipelines. Pipeline and Hazardous Materials Safety Administration, Office of Pipeline Safety. Accessed August 9, 2012 at <http://phmsa.dot.gov/portal/site/PHMSA/menuitem.ebdc7a8a7e39f2e55cf2031050248a0c/?vgnextoid=fdd2dfa122a1d110VgnVCM1000009ed07898RCRD&vgnnextchannel=3430fb649a2dc110VgnVCM1000009ed07898RCRD&vgnnextfmt=print>.
- OPS. 2012d. "PHMSA-Accident Incident and Mileage Summary Statistics-Natural Gas Transmission, Gas Distribution, and Hazardous Liquid Pipeline Annual Mileage." Pipeline and Hazardous Materials Safety Administration, Office of Pipeline Safety. Accessed July 17, 2012 at <http://phmsa.dot.gov/portal/site/PHMSA/menuitem.ebdc7a8a7e39f2e55cf2031050248a0c/?vgnextoid=036b52edc3c3e110VgnVCM1000001ecb7898RCRD&vgnnextchannel=3b6c03347e4d8210VgnVCM1000001ecb7898RCRD&vgnnextfmt=print>.
- OSHA (Occupational Safety and Health Administration). 2012. "Table Z-1 Limits for Air Contaminants. – 1910.1000 Table Z-1." and "Table Z-2 – 1910.1000 Table Z-2." Accessed March 8, 2012 at http://www.osha.gov/pls/oshaweb/owadisp.show_document?p_table=STANDARDS&p_id=9992 and http://www.osha.gov/pls/oshaweb/owadisp.show_document?p_table=STANDARDS&p_id=9993.
- Patrick. 2011. Sound Measurements at the Morgan County Characterization Well. Patrick Engineering for the FutureGen Alliance. November 28, 2011.
- Pew Center. 2011. "Illinois Governor signs legislation to reduce emissions from coal power plants." Accessed April 6, 2011 at <http://www.pewclimate.org/node/6363>.

- PHE (Potomac-Hudson Engineering). 2011. Meredosia Power Station, Ambient Noise Monitoring Report 2011. Potomac-Hudson Engineering, Inc. for FutureGen Alliance. May 2011.
- Piskin, K. and R.E. Bergstrom. 1975. Glacial Drift in Illinois: Thickness and Character. Illinois State Geological Survey Circular 490. Revision of Circular 416. State of Illinois, Department of Registration and Education. Urbana, Illinois.
- Prairie Archaeology & Research. 2012a. FutureGen 2.0 Project. Environmental Information Volume, Cultural Resources Section. May 2012.
- Praxair. 2007. Material Safety Data Sheet for Oxygen, Refrigerated Liquid. P-4637-H. December 2007.
- Preston C., M. Monea, W. Jazrawi, K. Brown, S. Whittaker, D. White, D. Law, R. Chalaturnyk, and B. Rostron. 2005. "IEA GHG Weyburn CO₂ Monitoring and storage project." *Fuel Processing Technology*. 86(14-15):1547-1568.
- Pruess, K. 2006. "On Leakage from Geologic Storage Reservoirs of CO₂." *Proceedings of CO2SC Symposium 2006*. Lawrence Berkeley National Laboratory, Berkeley, California, March 20-22, 2006.
- Public Law 97-98. Farmland Protection Policy Act. U.S. Department of Agriculture Environmental Compliance Library. December 21, 1981.
- Public Law 111-5. "American Recovery and Reinvestment Act of 2009." 123 Stat. 115. February 17, 2009. Accessed April 5, 2011 at http://frwebgate.access.gpo.gov/cgi-bin/getdoc.cgi?dbname=111_cong_bills&docid=f:h1enr.pdf.
- Römkens, M.J.M., R.A. Young, J.W.A. Posen, D.K. McCool, S.A. El-Swaify, and J.M. Bradford. 1996. "Chapter 3. Soil Erodibility Factor (K)" In Renard, K.G., G.A. Foster, D.K. Weissles, D.K. McCool, and D.C. Yoder, coordinators. *Predicting Soil Erosion by Water: A Guide to Conservation Planning With the Revised Universal Soil Loss Equation (RUSLE)*. U.S. Department of Agriculture, Agriculture Handbook No. 703. July 1996.
- Salinger, B. 2013. Personal Communication with Bonnie Salinger, City of Meredosia. February 1, 2013.
- SCAPA (Subcommittee on Consequence Actions and Protective Assessments). 2012. Table 2: Protective Action Criteria (PAC) Rev 27, Based on Applicable 60-minute AEGLs, ERPGs, or TEELs. February 2012.
- Schools List. 2011. Schools in Meredosia. Accessed at <http://illinois.hometownlocator.com/features/cultural,class,school,scfips,17137.cfm>.
- Shelby Electric Cooperative, Inc. 2011. "Electric Cooperatives of Illinois." Accessed September 2, 2011 at <http://shelbyelectric.coop/About/StateCooperativeSystem.asp>.
- Singh, K.P., G.S. Ramamurthy, and I.W. Seo. 1988. 7-Day 10-Year Low Flows of Streams in the Rock, Spoon, La Moine, and Kaskaskia Regions, Illinois State Water Survey Division, Surface Water Section. Contract Report 440. February 1988.
- Smithsonian. 2012. "Astragalus distortus." Accessed November 29, 2012 at <http://botany.si.edu/DCflora/flowergallery/gallery.cfm?mychoice=Astragalus%20distortus&genspe=Astragalusdistortus>.
- Soil Survey Division Staff. 1993. *Soil Survey Manual*. National Soil Conservation Service. U.S. Department of Agriculture Handbook 18.

- Soil Survey Staff. 2011a. "Farmland Classification-Morgan County, Illinois." Web Soil Survey. U.S. Department of Agriculture, Natural Resources Conservation Service. Accessed March 3, 2011 at <http://websoilsurvey.nrcs.usda.gov/app/WebSoilSurvey.aspx>.
- Soil Survey Staff. 2011b. "Web Soil Survey." U.S. Department of Agriculture, National Resources Conservation Survey. Accessed March 21, 2011 at <http://websoilsurvey.nrcs.usda.gov/app/WebSoilSurvey.aspx>.
- Stover, C.W., G. Reagor, and S.T. Algermissen. 1984. United States earthquake data file. U.S. Geological Survey. Open-File Report 84-225.
- Suckale, J. 2010. "Moderate-to-large seismicity induced by hydrocarbon production." *The Leading Edge*. 29(3):310-319.
- Suloway, L. and M. Hubbell. 1994. Wetland Resources of Illinois: An Analysis and Atlas. Illinois Natural History Survey Special Publication 15. Champaign, Illinois. July 1991.
- Swezey, C.S. 2009. Stratigraphy and Petroleum Systems of the Illinois Basin, U.S.A. U.S. Geological Survey Scientific Investigations Map 3068.
- Thomas, D.L. 1999. "Illinois River." In *Illinois Natural History Survey Annual Report 1998-1999*. Illinois Department of Natural Resources, Illinois Natural History Survey. Accessed March 22, 2011 at http://www.inhs.illinois.edu/resources/annualreports/98_99/illriv.html.
- Turner, B.D. 1994. *Workbook Of Atmospheric Dispersion Estimates: An Introduction to Dispersion Modeling*, 2nd edition. Lewis Publishers, Boca Raton, Florida.
- U.S. Cities. 2012. "Jacksonville Illinois Profile and Resource Guide, City or Community of Jacksonville, Illinois." Accessed January 23, 2012 at <http://www.usacitiesonline.com/ilcountyjacksonville.htm#statistics>.
- U.S. Department of State. 2011. "Appendix L – Pipeline Temperature Effects Study." In *Final Environmental Impact Statement for the Keystone XL Project*. August 26, 2011.
- USACE (U.S. Army Corps of Engineers). 1998. "Illinois Waterway Navigational Chart No. 28." Accessed March 9, 2011 at <http://www2.mvr.usace.army.mil/NIC2/Documents/chart28.pdf>.
- USACE. 2007. Illinois River Basin Restoration Comprehensive Plan with Integrated Environmental Assessment. Rock Island District. March 2007.
- USACE. 2010. Regional Supplement to the Corps of Engineers Wetland Delineation Manual: Midwest Region (Version 2.0). Engineer Research and Development Center. ERDC/EL TR-10-16. August 2010.**
- USAF (United States Air Force). 2003. Air Emissions Inventory Guidance Document for Stationary Sources at Air Force Installations. United States Air Force Institute for Environment, Safety and Occupational Health Risk Analysis. Brooks Air Force Base, Texas. May 1999, Revised December 2003.
- USBLS (U.S. Bureau of Labor Statistics). 2011. Illinois County Unemployment Rate Rankings, Not Seasonally Adjusted. Bureau of Labor Statistics. August 2011.
- USBLS. 2012a. "Table 1. Incidence rates of nonfatal occupational injuries and illnesses by industry and case types, 2010." U.S. Department of Labor, Bureau of Labor Statistics. Updated October 2010. Accessed July 16, 2012 at <http://www.bls.gov/iif/oshwc/osh/os/ostb2813.pdf>.

- USBLS. 2012b. "Fatal occupational injuries, total hours worked, and rates of total occupational injuries for civilian workers by selected worker characteristics, occupations, and industries, 2010." U.S. Department of Labor, Bureau of Labor Statistics. Accessed February 23, 2012 at http://www.bls.gov/iif/oshwc/cfoi/cfoi_rates_2010hb.pdf.
- USBLS. 2012c. "Table A-1. Fatal occupational injuries by industry and event or exposure, All United States, 2010." U.S. Department of Labor, Bureau of Labor Statistics. Accessed July 16, 2012 at <http://www.bls.gov/iif/oshwc/cfoi/cftb0250.pdf>.
- USCB (U.S. Census Bureau). 1994. "Population of Counties by Decennial Census: 1900 to 1990." U.S. Census Bureau, Population Division. October 14, 1994. Accessed December 5, 2012 at <http://www.census.gov/population/cencounts/1900-90.txt>.
- USCB. 2000. "DP-1: Profile of General Demographic Characteristics: 2000, Geographic area: Morgan County, Illinois." U.S. Census Bureau, American FactFinder. Accessed August 4, 2011 at http://factfinder.census.gov/home/saff/main.html?_lang=en.
- USCB. 2010a. "2010 Census Interactive Population Search." Accessed August 1, 2012 at <http://2010.census.gov/2010census/popmap/>.
- USCB. 2010b. "2006-2010 American Community Survey 5-Year Estimates, Meredosia, Illinois." U.S. Census Bureau, American Fact Finder. Accessed February 7, 2012 at <http://factfinder2.census.gov/>.
- USCB. 2010c. "Jacksonville (city) QuickFacts from the U.S. Census Bureau." U.S. Census Bureau, QuickFacts Database. Accessed April 11, 2012 at <http://quickfacts.census.gov/qfd/states/17/1738115.html>.
- USCB. 2010d. 2010 Census Redistricting Data (Public Law 94-171) Summary File, Tables P1 and H1. Accessed February 13, 2011 at <http://www2.illinois.gov/census/Pages/Census2010Data.aspx>.
- USCB. 2010e. "2010 State and County QuickFacts." U.S. Census Bureau, Accessed October 13, 2011 at <http://quickfacts.census.gov>.
- USCB. 2010f. "Profile of General Population and Housing Characteristics: 2010. 2010 Demographic Profile Data, Census Tract 9514, Morgan County, Illinois." U.S. Census Bureau, American Fact Finder. Accessed August 28 2012 at <http://factfinder2.census.gov/faces/nav/jsf/pages/searchresults.xhtml?refresh=t>.
- USCB. 2010g. "Selected Economic Characteristics, 2006-2010 American Community Survey 5-Year Estimates. Demographic Profile 03 – Morgan County, IL Census Tract 9514." U.S. Census Bureau, American Fact Finder. Accessed August 28, 2012 at <http://factfinder2.census.gov/faces/nav/jsf/pages/searchresults.xhtml?refresh=t>.
- USCB. 2011a. "Population density and population characteristics from Census 2010 National Summary File of Redistricting Data (PL 94-171), Detailed Tables, Table P1 Population Data, Illinois and Table P12 population age characteristics." Data Accessed August 8, 2011 at <http://factfinder2.census.gov/faces/nav/jsf/pages/index.xhtml>.
- USCB. 2011b. "Table 3. Annual Estimates of the Resident Population for Incorporated Place in Illinois: April 1, 2010 to July 1, 2011." U.S. Census Bureau, Population Division. Accessed July 24, 2012 at <http://quickfacts.census.gov/qfd/states/170001k.html>.
- USDA (U.S. Department of Agriculture). 1999. "Table 1. County Summary Highlights: 1997." In *1997 Census of Agriculture. United States Summary and State Data, Volume 1*. Geographic Area Series, Part 51. AC97-A-51. March 1999.

- USDA. 2009. "Table 1. County Summary Highlights: 2007." In *2007 Census of Agriculture. United States Summary and State Data, Volume 1*. Geographic Area Series, Part 51. AC-07-A-51. Updated December 2009.
- USDA. 2011. "NSSH Part 622 | NRCS Soils." National Soil Survey Handbook, Part 430-VI. U.S. Department of Agriculture, Natural Resources Conservation Service. Updated January 24, 2011. Accessed March 25, 2011 at <http://soils.usda.gov/technical/handbook/>.
- USDA. 2012. "Part 618- Soil Properties and Qualities | NRCS Soils." National Soil Survey Handbook, Part 618.51. U.S. Department of Agriculture, Natural Resources Conservation Service. Updated January 24, 2011. Accessed August 20, 2012 at <http://soils.usda.gov/technical/handbook/>.
- USDA/NRCS (U.S. Department of Agriculture and Natural Resources Conservation Service). 2001. National Landcover Dataset – Illinois. U.S. Department of Agriculture, National Cartography and Geospatial Center. Texas. 2001.
- USDA/NRCS. 2012. Soil Survey Geographic (SSURGO) database for Morgan County, Illinois. U.S. Department of Agriculture, Natural Resources Conservation Service. Texas. 2012.**
- USDOI/USGS (U.S. Department of the Interior and U.S. Geological Survey). 1994. National Water Quality Assessment Program – The Lower Illinois River Basin. NAWQA Fact Sheet. FS 94-018. September 1994.
- USEPA (U.S. Environmental Protection Agency). 1974. Information on Levels of Environmental Noise Requisite to Protect Public Health and Welfare within Adequate Margin of Safety. U.S. Environmental Protection Agency, Office of Noise Abatement and Control. Washington, D.C. March 1974.
- USEPA. 1993. EPA's Map of Radon Zones, Illinois. U.S. Environmental Protection Agency. Office of Radiation and Indoor Air. September 1993.
- USEPA. 1995a. "Section 13.2.3, Heavy Construction Operations." In *Compilation of Air Pollutant Emission Factors (AP-42) 5th Edition, Volume I*. Accessed September 1, 2011 at <http://www.epa.gov/ttnchie1/ap42/ch13/final/c13s02-3.pdf>.
- USEPA. 1995b. Memorandum: Calculating Potential to Emit (PTE) for Emergency Generators. U.S. Environmental Protection Agency, Office of Air Quality Planning and Standards. September 6, 1995.
- USEPA. 1995c. SCREEN3 Model User's Guide. Report U.S. Environmental Protection Agency, Office of Air Quality Planning and Standards. Research Triangle Park, NC. EPA-454/B-95-004. September 1995.
- USEPA. 1998. Characterization of Building-Related Construction and Demolition Debris in the United States. U.S. Environmental Protection Agency, Municipal and Industrial Solid Waste Division. EPA530-R-98-010. June 1998.
- USEPA. 2000. Carbon Dioxide as a Fire Suppressant: Examining the Risks. U.S. Environmental Protection Agency, Office of Air and Radiation. EPA430-R-00-002. February 2000.
- USEPA. 2005a. Methodology to Estimate the Transportable Fraction (TF) of Fugitive Dust Emissions for Regional and Urban Scale Air Quality Analyses. Updated August 3, 2005.
- USEPA. 2005b. Examination of the Multiplier Used to Estimate PM_{2.5} Fugitive Dust Emissions from PM₁₀.

- USEPA. 2008a. "NONROAD Model (nonroad engines, equipment, and vehicles) Modeling and Inventories." 2008 NONROAD Model. Updated November 26, 2012. Accessed on November 28, 2012 at <http://www.epa.gov/otaq/nonrdmdl.htm>.
- USEPA. 2008b. Vulnerability Evaluation Framework for Geologic Sequestration of Carbon Dioxide. U.S. Environmental Protection Agency. EPA430-R-08-009. July 10, 2008.
- USEPA. 2009a. "Endangerment and Cause or Contribute Findings for Greenhouse Gases under Section 202(a) of the Clean Air Act." Accessed April 5, 2011 at <http://www.epa.gov/climatechange/endangerment.html>.
- USEPA. 2009b. Frequently Asked Questions about Global Warming and Climate Change: Back to Basics. U.S. Environmental Protection Agency, Office of Air and Radiation. EPA-430-R08-016. April 2009.
- USEPA. 2009c. Risk Management Program Guidance for Offsite Consequence Analysis. U.S. Environmental Protection Agency, Office of Solid Waste and Emergency Response. EPA 550-B-99-009. Updated March 2009.
- USEPA. 2010a. Median Life, Annual Activity, and Load Factor Values for Nonroad Engine Emissions Modeling. NR-005d. U.S. Environmental Protection Agency, Office of Transportation and Air Quality. EPA420-R-10-016. July 2010.
- USEPA. 2010b. Exhaust and Crankhouse Emission Factors for Nonroad Engine Modeling Compression-Ignition. NR-009d. U.S. Environmental Protection Agency, Office of Transportation and Air Quality. EPA-420-R-10-018. July 2010.
- USEPA. 2010c. Memorandum: Guidance Concerning the Implementation of the 1-hour NO₂ NAAQS for Prevention of Significant Deterioration Program. U.S. Environmental Protection Agency, Office of Air Quality Planning and Standards. June 29, 2010.
- USEPA. 2010d. Memorandum: Guidance Concerning the Implementation of the 1-hour SO₂ NAAQS for Prevention of Significant Deterioration Program. U.S. Environmental Protection Agency, Office of Air Quality Planning and Standards. August 23, 2010.
- USEPA. 2010e. Final Rule: Prevention of Significant Deterioration and Title V Greenhouse Gas Tailoring Rule. Fact Sheet. May 2010.
- USEPA. 2010f. General Technical Support Document for Injection and Geologic Sequestration of Carbon Dioxide: Subparts RR and UU. U.S. Environmental Protection Agency, Office of Air and Radiation. November 2010.
- USEPA. 2010g. "Primary Distinguishing Characteristics of Level III Ecoregions of the Continental United States." July 2010. Accessed September 6, 2012 at ftp://ftp.epa.gov/wed/ecoregions/us/Eco_Level_III_descriptions.doc.
- USEPA. 2011a. "Illinois State Implementation Plan." Accessed on March 10, 2011 at <http://yosemite.epa.gov/r5/r5ard.nsf/SIPs%20View%20By%20State%20Main%20View!OpenView&Start=1&Count=30&Expand=1.19.1.1#1.19.1.1>.
- USEPA. 2011b. "Currently Designated Nonattainment Areas for All Criteria Pollutants | Green Book | US EPA." Updated April 21, 2011. Accessed June 1, 2011, at <http://www.epa.gov/air/oaqps/greenbk/anc1.html#ILLINOIS>.
- USEPA. 2011c. "IDEA Query Results." Enforcement and Compliance History Online (ECHO). Accessed July 5, 2011 at http://www.epa-echo.gov/echo/compliance_report_air.html.

- USEPA. 2011d. "Select Geographic Area | AirData | US EPA." Accessed May 31, 2011 at <http://www.epa.gov/air/data/geosel.html>.
- USEPA. 2011e. "Greenhouse Gas Reporting Program | Regulatory Initiatives | Climate Change U.S. EPA." Accessed April 4, 2011 at <http://www.epa.gov/climatechange/emissions/ghgrulemaking.html>.
- USEPA. 2011f. "Regulations & Standards | Transportation and Climate | US EPA." Accessed April 5, 2011 at <http://www.epa.gov/otaq/climate/regulations.htm#1-1>.
- USEPA. 2011g. "EPA New Source Review Regulatory Actions." Accessed April 5, 2011 at <http://www.epa.gov/nsr/actions.html>.
- USEPA. 2011h. "Clean Air Act Permitting for Greenhouse Gas Emissions – Final Rules. Fact Sheet." Accessed April 5, 2011 at <http://www.epa.gov/nsr/actions.html#2011>.
- USEPA. 2011i. "SDWIS Search | Envirofacts | US EPA." Updated April 26, 2011. Accessed April 26, 2011 at http://oaspub.epa.gov/enviro/sdw_report_v2.first_table?pws_id=IL1370300&state=IL&source=Groundwater&population=1041&sys_num=0.
- USEPA. 2011j. "Lower Illinois Watershed – 07130011 | Surf Your Watershed | US EPA." Accessed February 25, 2011 at http://cfpub.epa.gov/surf/huc.cfm?huc_code=07130011.
- USEPA. 2011k. Proposed Regulations to Establish Requirements for Cooling Water Intake Structures at Existing Facilities. Fact Sheet. U.S. Environmental Protection Agency, Office of Water. EPA-820-F-11-002. March 2011.
- USEPA. 2011l. "NEPAssist." Online environmental resource mapping application. Accessed August 1, 2011 at <https://ssoprod.epa.gov/sso/jsp/NEPALogin.jsp>.
- USEPA. 2011m. Clean Water Act NPDES Permitting Determinations for the Thermal Discharge and Cooling Water Intake Structures at Merrimack Station in Bow, New Hampshire. NPDES Permit No. NH0001465.
- USEPA. 2011n. "Coal Combustion Residuals | Industrial Waste | US EPA." Accessed August 11, 2011 at <http://www.epa.gov/osw/nonhaz/industrial/special/fossil/coalashletter.htm>.
- USEPA. 2012a. "National Ambient Air Quality Standards (NAAQS) | Air and Radiation | US EPA." Updated July 16, 2012. Accessed July 25, 2012 at <http://www.epa.gov/air/criteria.html>.
- USEPA. 2012b. "MOVES (Motor Vehicle Emission Simulator) | Modeling and Inventories | US EPA." MOVES 2012b simulator information page. Updated June 25, 2012. Accessed July 25, 2012, at <http://www.epa.gov/otaq/models/moves/index.htm#generalinfo>.
- USEPA. 2012c. AP-42, Volume 1, Fifth Edition. Compilation of Air Pollutant Emission Factors. Volume 1: Stationary Point and Area Sources. Original publication January 1995, sections updated periodically. Accessed May 28, 2012 at <http://www.epa.gov/ttn/chief/ap42/index.html>.
- USEPA. 2012d. "Trends in Greenhouse Gas Emissions." In *Inventory of U.S. Greenhouse Gas Emissions and Sinks: 1990-2010*. EPA 430-R-12-001. April 15, 2012.
- USEPA. 2012e. "EPA Office of Water (OW): 303(d) Listed Impaired Waters NHD Indexed Dataset." U.S. Environmental Protection Agency, Office of Water. Accessed online December 2012 at <http://epamap32.epa.gov/radims/>.

- USEPA. 2012f. "EPA | Envirofacts Warehouse | FII." Facility Detail Report for Ameren Energy Generating Meredosia Power Station. Accessed November 28, 2012 at http://oaspub.epa.gov/enviro/fii_query_dtl.disp_program_facility?pgm_sys_id_in=ILD065236226.
- USEPA. 2012g. "Acute Exposure Guideline Level (AEGs) | US EPA." Updated April 23, 2012 Accessed April 23, 2012 for SO₃ at <http://www.epa.gov/oppt/aegl/pubs/rest153.htm>, H₂S at <http://www.epa.gov/oppt/aegl/pubs/results57.htm>, and SO₂ at <http://www.epa.gov/oppt/aegl/pubs/results86.htm>.
- USEPA. 2012h. "Integrated Risk Information System (IRIS) Database Inhalation Reference Concentration (RfC)." Accessed July 24, 2012 for H₂S at <http://www.epa.gov/iris/subst/0061.htm#inhalrfc>.
- USEPA. 2012i. "EPA Map of Radon Zones | Radon | US EPA." Updated September 11, 2012. Accessed November 27, 2012 at <http://epa.gov/radon/zonemap.html>.
- USEPA. 2013a. "Standards of Performance for Greenhouse Gas Emissions from New Stationary Sources: Electric Utility Generating Units." September 20, 2013. Accessed October 4, 2013 at <http://www2.epa.gov/sites/production/files/2013-09/documents/20130920proposal.pdf>.**
- USEPA. 2013b. Geologic Sequestration of Carbon Dioxide, Underground Injection Control (UIC) Program Class VI Well Site Characterization Guidance. U.S. Environmental Protection Agency, Office of Water. EPA 816-R-13-004. May 2013.**
- USEPA. 2013c. Geologic Sequestration of Carbon Dioxide, Underground Injection Control (UIC) Program Class VI Well Testing and Monitoring Guidance. U.S. Environmental Protection Agency, Office of Water. EPA 816-R-13-001. March 2013.**
- USFA (United States Fire Administration). 2012. "National Fire Department Census Database." Accessed February 13, 2012 at www.usfa.dhs.gov/applications/census.
- USFWS (U.S. Fish and Wildlife Service). 2010. "Bald Eagle Permit: Non-Purposeful Take Step-by-Step Guidance." Updated September 13, 2010. Accessed September 5, 2012 at <http://www.fws.gov/midwest/MidwestBird/eaglepermits/baeatake/step1.html>.
- USFWS. 2011a. "Wetlands Mapper." Online National Wetland Inventory mapping application. Accessed March 28, 2011 at <http://www.fws.gov/wetlands/Data/Mapper.html>.
- USFWS. 2011b. "Species Fact Sheet – Bald Eagle." U.S. Fish and Wildlife Service, Oregon Fish and Wildlife Office. Accessed June 6, 2011 at <http://www.fws.gov/oregonfwo/Species/Data/BaldEagle/>.
- USFWS. 2012a. "Classification of Wetlands and Deepwater Habitats of the United States." Vector Digital Data CONUS-wet_poly. U.S. Fish and Wildlife Service, Division of Habitat Resource Conservation. Washington, DC. Accessed June 2013 at <http://www.fws.gov/wetlands/>.**
- USFWS. 2012b. "Birds Protected by the Migratory Bird Treaty Act." Updated April 11, 2012. Accessed September 6, 2012 at <http://www.fws.gov/migratorybirds/RegulationsPolicies/mbta/taxolst.html>.
- USFWS. 2012c. "About the Refuge - Meredosia – U.S. Fish and Wildlife Service." Updated October 2, 2012. Accessed November 5, 2012 at <http://www.fws.gov/refuge/Meredosia/about.html>.
- USFWS. 2012d. Illinois Federally Endangered, Threatened, and Candidate Species. U.S. Fish and Wildlife Service, Midwest Region. Updated March 2012.

- USFWS. 2012e. "Sheepnose (a freshwater mussel) *Plethobasus cyphus*." March 2012. Accessed October 29, 2012 at <http://www.fws.gov/midwest/endangered/clams/sheepnose/pdf/SheepnoseFactSheetMarch2012.pdf>.
- USFWS. 2013. "2013 Indiana Bat Summer Survey Guidance Overview." April 29, 2013. Accessed April 30, 2013 at <http://www.fws.gov/midwest/endangered/mammals/inba/inbasummerurveyguidance.html>.**
- USGCRP (U.S. Global Change Research Program). 2009. "Regional Climate Impacts: Midwest." In *Global Change Impacts in the United States*. June 2009.
- USGS (U.S. Geological Survey). 2000a. "Lower Illinois River Basin NAWQA: Basin Information." Updated May 11, 2000. Accessed March 24, 2011 at <http://il.water.usgs.gov/proj/lirb/info/>.
- USGS. 2000b. "Lower Illinois River Basin: Network Design." Updated May 11, 2000. Accessed March 25, 2011 at http://il.water.usgs.gov/proj/lirb/gw/net_design/index.html.
- USGS. 2000c. "Lower Illinois River Basin: Surface Water." Updated May 11, 2000. Accessed November 29, 2012 at <http://il.water.usgs.gov/proj/lirb/sw/>.
- USGS. 2009a. "Water Data Report 2009. 05568500 Illinois River at Kingston Mines, Illinois." Accessed March 10, 2011 at http://waterdata.usgs.gov/il/nwis/annual/?referred_module=sw.
- USGS. 2009b. "Water Data Report 2009. 05586100 Illinois River at Valley City, Illinois." Accessed March 10, 2011 at http://waterdata.usgs.gov/il/nwis/annual/?referred_module=sw.
- USGS. 2010. "Water Data Report 2010. 05585500 Illinois River at Meredosia Illinois." Accessed March 10, 2011 at http://waterdata.usgs.gov/il/nwis/annual/?referred_module=sw.
- USGS. 2011a. "Water Quality Assessment of the Lower Illinois River Basin: Environmental Setting." Kelly A. Warner. Accessed March 11, 2011 at <http://il.water.usgs.gov/proj/lirb/pubs/esr/Environ.html>.
- USGS. 2011b. "USGS Surface-Water Data for Illinois." Accessed February 25, 2011 at <http://waterdata.usgs.gov/il/nwis/sw>.
- USGS. 2012a. "Probability of earthquake with $M > 5.0$ within 50 years & 50 km." Accessed August 28, 2010 at <http://geohazards.usgs.gov/eqprob/2009/index.php>.
- USGS. 2012b. "US Seismic Hazard 2008." Peak Ground Acceleration (%g) with 2% probability of exceedance in 50 years, national database. Accessed November 28, 2012 at <http://earthquake.usgs.gov/hazards/apps/map/>.
- USGS. 2013. "Illinois." Earthquake History. Accessed January 30, 2013 at <http://earthquake.usgs.gov/earthquakes/states/illinois/history.php>.
- USGS/USEPA (U.S. Geological Survey and U.S. Environmental Protection Agency). 2011. "National Hydrography Dataset." U.S. Geological Survey, in cooperation with the U.S. Environmental Protection Agency. Reston, Virginia. Accessed July 2011 at <http://nhd.usgs.gov/data.html>.
- Werries, S. 2012. Personal Communication with Scott Werries, Fire Chief, Meredosia Volunteer Fire Department. August 8, 2012.
- West Central Mass Transit. 2012. "West Central Mass Transit District Passenger Guidelines & Fare Schedule." Updated May 21, 2008. Accessed December 3, 2012 at <http://www.wcmt.org/morgan-scott-county.aspx>.

- Whitney, S.D., K.D. Blodgett, and R.E. Sparks. 1997. A Comprehensive Mussel Survey of the Illinois River, 1993-1995. Illinois Natural History Survey. Illinois Department of Natural Resources. Springfield, Illinois. December 1997. Updated February 27, 2010.
- Willman, H.B., E. Atherton, T.C. Buschbach, C. Collinson, J.C. Frey, M.E. Hopkins, J.A. Lineback, and J.A. Simon. 1975. Handbook of Illinois Stratigraphy. Illinois State Geological Survey Bulletin 95. Urbana, Illinois.
- Woller, D.M., and E.W. Sanderson. 1979. Public Groundwater Supplies in Morgan and Scott Counties. Illinois Institute of Natural Resources Bulletin 60-27. Urbana, Illinois.
- Woods, A.J., J.M. Omernik, C.L. Pederson, and B.C. Moran. 2006a. "Illinois Level III and IV Ecoregions." Accessed September 6, 2012 at ftp://ftp.epa.gov/wed/ecoregions/il/il_map.pdf.
- Woods, A.J., J.M. Omernik, C.L. Pederson, and B.C. Moran. 2006b. "Level III and IV Ecoregions of Illinois." September 2006. Accessed July 13, 2011 at ftp://ftp.epa.gov/wed/ecoregions/il/il_eco_desc.pdf.
- WRI (World Resources Institute). 2007. "Illinois Greenhouse Gas Inventory and Projections." February 22, 2007. Accessed October 1, 2012 at <http://www.epa.state.il.us/air/climatechange/documents/07-02-22/il-emissions-overview-v5.pdf>.
- WRI. 2012. "Climate Analysis Indicators Tool." Accessed September 30, 2012 at <http://www.google.com/publicdata/directory#!dp=World+Resources+Institute>.
- Zhou, Q., and J.T. Birkholzer. 2011. On scale and magnitude of pressure build-up induced by large-scale geologic storage of CO₂. *Greenhouse Gases Science and Technology*. 1:11-20.
- Zhou, Q., J.T. Birkholzer, E. Mehnert, Y.-F. Lin, and K. Zhang. 2010. Modeling Basin-and Plume-Scale Processes of CO₂ storage for Full-Scale Deployment. *Ground Water* 48(4):494-514.

INTENTIONALLY LEFT BLANK

7 FEDERAL, STATE, LOCAL, AND TRIBAL CONTACTS

Federal Agencies

Advisory Council on Historic Preservation, Office of Federal Agency Programs
Federal Energy Regulatory Commission, Office of Energy Projects
U.S. Army Corps of Engineers, Headquarters
U.S. Army Corps of Engineers, St. Louis District
U.S. Department of Agriculture, Agricultural Research Service
U.S. Department of Agriculture, Farm Service Agency
U.S. Department of Agriculture, Forest Service
U.S. Department of Agriculture, Natural Resources Conservation Service
U.S. Department of Agriculture, Rural Utilities Service
U.S. Department of Homeland Security, Federal Emergency Management Agency, Region V
U.S. Department of the Interior, Bureau of Indian Affairs, Midwest Region
U.S. Department of the Interior, Fish and Wildlife Service, Marion Ecological Services
U.S. Department of the Interior, Office of Environmental Policy and Compliance
U.S. Department of Transportation, Federal Highway Administration
U.S. Department of Transportation, Office of Transportation Policy, Environmental Team Leader
U.S. Environmental Protection Agency, Carbon Sequestration / Climate Change Lead, Region V
U.S. Environmental Protection Agency, Headquarters, Office of Federal Activities
U.S. Environmental Protection Agency, Office of Enforcement and Compliance Assurance, Region V

Illinois Agencies

Illinois Commerce Commission
Illinois Department of Agriculture, Director
Illinois Department of Commerce and Economic Opportunity, Director
Illinois Department of Commerce and Economic Opportunity, Office of Coal Development
Illinois Department of Natural Resources, Director
Illinois Department of Natural Resources, Division of Ecosystems and Environment
Illinois Department of Natural Resources, Division of Natural Heritage
Illinois Department of Natural Resources, Impact Assessment Section Manager
Illinois Department of Natural Resources, Office of Water Resources
Illinois Department of Public Health, Division of Environmental Health
Illinois Department of Transportation, Office of Planning and Programming
Illinois Environmental Protection Agency, Bureau of Air
Illinois Environmental Protection Agency, Bureau of Land
Illinois Environmental Protection Agency, Director
Illinois Historic Preservation Agency, State Historic Preservation Officer
National Governors Association, Natural Resources Committee

Local and Regional Agencies

City of Jacksonville, City Clerk
City of Jacksonville, Fire Department
City of Jacksonville, Mayor
City of Jacksonville, Police Department
City of Taylorville, Mayor
Morgan County Highway Department
Morgan County Regional Planning Commission
Village of Meredosia, Mayor

Native American Tribes

Absentee-Shawnee Tribe of Indians of Oklahoma
Citizen Potawatomi Nation
Delaware Nation, Oklahoma
Eastern Shawnee Tribe of Oklahoma
Forest County Potawatomi Community
Hannahville Indian Community
Ho-Chunk Nation of Wisconsin
Iowa Tribe of Kansas & Nebraska
Iowa Tribe of Oklahoma
Kaw Nation
Kickapoo Traditional Tribe of Texas
Kickapoo Tribe of Indians of the Kickapoo Reservation in Kansas
Kickapoo Tribe of Oklahoma
Match-e-be-nash-she-wish Band of Pottawatomi Indians of Michigan
Miami Tribe of Oklahoma
Nottawaseppi Huron Band of the Potawatomi, Michigan
Osage Nation
Peoria Tribe of Indians of Oklahoma
Pokagon Band of Potawatomi Indians
Prairie Band of the Potawatomi Nation
Sac and Fox Nation of Missouri in Kansas and Nebraska
Sac and Fox Nation of Oklahoma
Sac and Fox Tribe of the Mississippi in Iowa
The Shawnee Tribe

Other Organizations

Jacksonville Area Chamber of Commerce

Jacksonville Fire Department, Fire Chief
Jacksonville Municipal Department

Jacksonville Regional Economic Development Corporation

Meredosia Volunteer Fire Department, Fire Chief
Meredosia Water Plant, Water Superintendent
Morgan County GIS
North Morgan Water Cooperative, Water Attendant

8 DISTRIBUTION LIST

Federal Elected Officials

The Honorable Cheri Bustos
United States House of Representatives
(IL District 17)

The Honorable Rodney Davis
United States House of Representatives
(IL District 13)

The Honorable Richard Durbin
United States Senate

The Honorable Mark Kirk
United States Senate

The Honorable Adam Kinzinger
United States House of Representatives
(IL District 16)

The Honorable Aaron Schock
United States House of Representatives
(IL District 18)

The Honorable John Shimkus
United States House of Representatives
(IL District 15)

United States Senate and House of Representatives Committees

Appropriations Committees

The Honorable Barbara Mikulski, Chairman
Committee on Appropriations
United States Senate

The Honorable Richard Shelby, Ranking Member
Committee on Appropriations
United States Senate

The Honorable Dianne Feinstein, Chairman
Subcommittee on Energy and Water Development
Committee on Appropriations
United States Senate

The Honorable Lamar Alexander, Ranking Member
Subcommittee on Energy and Water Development
Committee on Appropriations
United States Senate

The Honorable Harold Rogers, Chairman
Committee on Appropriations
United States House of Representatives

The Honorable Nita Lowey, Ranking Member
Committee on Appropriations
United States House of Representatives

The Honorable Rodney P. Frelinghuysen, Chairman
Subcommittee on Energy and Water Development
Committee on Appropriations
United States House of Representatives

The Honorable Marcy Kaptur, Ranking Member
Subcommittee on Energy and Water Development
Committee on Appropriations
United States House of Representatives

Authorizing Committees

The Honorable Ron Wyden, Chairman
Committee on Energy and Natural Resources
United States Senate

The Honorable Lisa Murkowski, Ranking Member
Committee on Energy and Natural Resources
United States Senate

The Honorable Barbara Boxer, Chairman
Committee on Environment and Public Works
United States Senate

The Honorable David Vitter, Ranking Member
Committee on Environment and Public Works
United States Senate

The Honorable Fred Upton, Chairman
Committee on Energy and Commerce
United State House of Representatives

The Honorable Henry A. Waxman, Ranking Member
Committee on Energy and Commerce
United States House of Representatives

Native American Tribal Organizations

Mr. George Blanchard, Governor
Absentee-Shawnee Tribe of Indians of Oklahoma

Mr. John A. Barrett, Chairman
Citizen Potawatomi Nation

Ms. Tamara Francis, Cultural Preservation Director
Delaware Nation, Oklahoma

Mr. Kenneth Meshigaud, Chairperson
Hannahville Indian Community

Mr. Jon Greendeer, President
Ho-Chunk Nation of Wisconsin

Mr. David K. Sprague, Chairperson
Match-e-be-nash-she-wish Band of Potawatomi
Indians of Michigan

Mr. Timothy Rhodd, Chairman
Iowa Tribe of Kansas & Nebraska

Mr. Gary Pratt, Chairperson
Iowa Tribe of Oklahoma

Mr. Guy Munroe, Chairman
Kaw Nation

Mr. Gilbert Salazar, Chairman
Kickapoo Tribe of Oklahoma

Mr. Steve Cadue, Chairman
Kickapoo Tribe of Indians of the Kickapoo
Reservation in Kansas

Mr. Juan Garza, Jr., Chairman
Kickapoo Traditional Tribe of Texas

Mr. Douglas Lankford, Chief
Miami Tribe of Oklahoma

Mr. Homer A. Mandoka, Chairperson
Nottawaseppi Huron Band of the Potawatomi,
Michigan

Mr. John D. Red Eagle, Principal Chief
Osage Nation

Mr. John P. Froman, Chief
Peoria Tribe of Indians of Oklahoma

Mr. Matthew Wesaw, Chairman
Pokagon Band of Potawatomi Indians

Mr. Steve Ortiz, Chairman
Prairie Band of the Potawatomi Nation

Mr. Alvin Sanache, Chairman
Sac and Fox Tribe of the Mississippi in Iowa

Ms. Brigitte Robidoux, Chairperson
Sac and Fox Nation of Missouri in Kansas and
Nebraska

Mr. George Thurman, Principal Chief
Sac and Fox Nation of Oklahoma

Mr. Ron Sparkman, Chief
The Shawnee Tribe

Mr. Harold Frank, Chairman
Forest County Potawatomi Community

Ms. Glenna J. Wallace, Chief
Eastern Shawnee Tribe of Oklahoma

State Elected Officials

The Honorable Pat Quinn
Governor of Illinois

The Honorable Norine Hammond
Illinois State House of Representatives (District 93)

The Honorable Andrew Manar
Illinois State Senate (District 48)

The Honorable Sam McCann
Illinois State Senate (District 50)

The Honorable Raymond Poe
Illinois State House of Representatives (District 99)

The Honorable Chapin Rose
Illinois State Senate (District 51)

The Honorable Wayne Rosenthal
Illinois State House of Representatives (District 95)

The Honorable John Sullivan
Illinois State Senate (District 47)

The Honorable C.D. Davidsmeyer
Illinois State House of Representatives (District 100)

Federal Agencies

Mr. Mark Matusiak
Civil Works Policy and Policy Compliance Division
Office of Water Project Review
U.S. Army Corps of Engineers

Mr. Charles L. Walthall, National Program Leader
Office of National Programs, Natural Resources and
Sustainable Agricultural Systems
Agricultural Research Service
U.S. Department of Agriculture

Mr. Joe Carbone, Assistant Director for NEPA
Ecosystem Management Coordination
Forest Service
U.S. Department of Agriculture

Ms. Andrée DuVarney, National Environmental
Coordinator
Natural Resources Conservation Service
U.S. Department of Agriculture

Mr. Mark Plank, Federal Preservation Officer
Rural Utilities Service
U.S. Department of Agriculture

Mr. Matthew Ponish, National Environmental
Farm Service Agency
U.S. Department of Agriculture

Ms. Marthea Rountree
Office of Federal Activities
U.S. Environmental Protection Agency

Ms. Jarrad Kosa, NEPA Coordinator
Fish and Wildlife Service
U.S. Department of the Interior

Mr. Jeff Wright, Director
Office of Energy Projects
Federal Energy Regulatory Commission

Federal Agencies – Regional Offices

Mr. Tyson J. Zobrist, Project Manager
Regulatory Branch
St. Louis District
U.S. Army Corps of Engineers

Mr. Matt Mangan, Biologist
Marion Ecological Services Sub-Office
Fish and Wildlife Service
U.S. Department of the Interior

Mr. Ken Westlake, Chief
NEPA Implementation Section
Office of Enforcement and Compliance Assurance,
Region V
U.S. Environmental Protection Agency

Mr. Jeffrey McDonald, Carbon Sequestration /
Climate Change Lead, Region V
U.S. Environmental Protection Agency

State Agencies

Mr. Jonathan Feipel, Executive Director
Illinois Commerce Commission

Ms. Anne Haaker
Deputy State Historic Preservation Officer
Preservation Services Division
Illinois Historic Preservation Agency

Mr. Robert F. Flider, Director
Illinois Department of Agriculture

Mr. Bill Hoback, Deputy Director
Office of Coal Development
Illinois Department of Commerce and Economic
Opportunity

Mr. Adam Pollet, Director
Illinois Department of Commerce and Economic
Opportunity

Mr. Nicholas Mueller, Regional Environmental
Officer
Federal Emergency Management Agency, Region V
Department of Homeland Security

Mr. Marc Miller, Director
Illinois Department of Natural Resources

Mr. Arlan Juhl, P.E., Director
Office of Water Resources
Illinois Department of Natural Resources

Ms. Karen Miller
Impact Assessment Section Manager
Illinois Department of Natural Resources

Mr. Todd Rettig, Division Manager
Division of Ecosystems and Environment
Illinois Department of Natural Resources

Dr. LaMar Hasbrouck, Director
Division of Environmental Health
Illinois Department of Public Health

Mr. Chuck Ingersoll, Director
Office of Planning and Programming
Illinois Department of Transportation

Ms. Lisa Bonnett, Director
Illinois Environmental Protection Agency

Mr. David Bloomberg
Air Quality Planning Section, Division of Air
Pollution Control
Illinois Environmental Protection Agency

Mr. Steve Nightingale, P.E.
Permit Section, Bureau of Land
Illinois Environmental Protection Agency

Mr. Ed Bakowski
Illinois Environmental Protection Agency

Mr. Steve Chard
Illinois Department of Agriculture

Mr. Dick Berg
Illinois State Geological Survey

Mr. Tom Cox
Illinois Department of Transportation

Ms. Sallie Greenberg, Assistant Director
Advanced Energy Technology Initiative
Illinois State Geological Survey
Midwest Geological Carbon Sequestration
Consortium

Mr. Kevin Lesko
Illinois Environmental Protection Agency

Mr. Mike Murphy
Illinois Department of Commerce and Economic
Opportunity

Terry Savko
Illinois Department of Agriculture

Mr. John Negangard
Illinois Department of Transportation

Mr. Bob Smet
Illinois Environmental Protection Agency

Mr. Duane Pulliam
Illinois Department of Natural Resources

Regional and Local Officials and Agencies

The Honorable Larry Ferguson, Mayor
City of Arcola

The Honorable Andy Ezard, Mayor
City of Jacksonville

The Honorable Kenneth Scott, Mayor
Village of Meredosia

The Honorable Gordon Jumper, Mayor
Village of South Jacksonville

The Honorable Greg Brotherton, Mayor
City of Taylorville

The Honorable Daniel J. Kleiss, Mayor
City of Tuscola

Mr. Paul Schmitz, Chairman
Christian County Board

Ms. Laura Wilkinson, Vice Chairman
Christian County Board

Mr. Charles Knox, Chairman
Douglas County Board

Mr. Bill Meier, Chairman
Morgan County Commissioners

Mr. Bradley Zeller, Vice Chairman
Morgan County Commissioners

Mr. Dick Rawlings, Member
Morgan County Commissioners

Mr. Dusty Douglas
Morgan County Regional Planning Commission

Mr. Terry L. Denison, President
Jacksonville Regional Economic Development
Corporation

Mr. Matt Bernius, Village President
Village of Arthur

Mr. Bob Doan, Community Development
Coordinator
Arthur Area Economic Development Corporation

Ms. Ginny Fanning
Jacksonville Area Chamber of Commerce

Mr. John Clark, Supervisor
Arcola Township

Mr. Paul Faraci, Regional Manager
DCEO – Illinois Office of Regional Outreach, East
Central Office

Ms. Rachael Crane, Director
Arcola Chamber of Commerce

Mr. Don Munson
Douglas County Board

Mr. Dave McCabe, President
Moultrie County Board

Ms. Carly McCrory
Tuscola Economic Development Inc.

Ms. Stepheny McMahan, Director
Sullivan Chamber & Economic Development

Mr. Brian Moody, Executive Director
Tuscola Economic Development, Inc.

Ms. Mary L. Renner, Director
Christian County Economic Development
Corporation

Ms. Ann Short, Mayor
City of Sullivan

Mr. Steven D. Sipes, Mayor
City of Pana

Mr. Paul White
Jacksonville Area Chamber of Commerce

Mr. James Crane, County Engineer
Douglas County

Mr. Bob Crossman, Attorney
Village of Arthur

Mr. Andrew Bequette, Attorney
City of Tuscola

Mr. Jim Deere
City of Pana

Mr. Steve Helton, Road Commissioner
Village of Arthur

Mr. Charlie McGrew, County Sheriff
Douglas County Sheriff's Department

Mr. Gene Good, Fire Chief
Arthur Fire District

Mr. Steve Hettinger, Fire Chief
City of Tuscola

Mr. Drew Hoel, City Administrator
City of Tuscola

Mr. Les Huddle, Superintendent
Jacksonville School District #117

Mr. Jon Freeman
Cass-Morgan County Farm Bureau

Mr. Larry Budd, Alderman
City of Taylorville

Mr. Mike Lindenmeyer
Arcola Chamber of Commerce

Mr. Dan Little
Morgan County Board

Ms. Alta Long, Treasurer
City of Tuscola

Mr. Dick Bickel, Fire Chief
Arcola Fire District

Mr. Michael Smith, Superintendent
Tuscola School District

Ms. Judy Tighe, Executive Director
Jacksonville Main Street

Mr. Joe Victor
Douglas County

Mr. George Wineland, Assistant Chief
Tuscola Fire Department

Mr. Travis Wilson, Superintendent
Arthur School District

Mr. William Wagoner, City Administrator
City of Arcola

Nongovernmental Organizations

Mr. Randy Rawson, President
American Boiler Manufacturers Association

Ms. Pamela A. Lacey, Senior Managing Counsel
American Gas Association

Mr. Harry Ng, General Counsel
American Petroleum Institute

Ms. Joy Ditto
Vice President of Government Relations
American Public Power Association

Mr. Richard M. Loughery, Director
Environmental Activities
Edison Electric Institute

Ms. Vickie Patton, General Counsel
Environmental Defense Fund

Ms. Michele Nellenbach, Director
Natural Resources Committee
National Governors Association

Ms. Amanda Aspatore, Assistant General Counsel
Environmental Affairs
National Mining Association

Mr. Rae Cronmiller, Environmental Counsel
National Rural Electric Cooperative Association

Mr. Jim Lyon, Senior Vice President for
Conservation
National Wildlife Federation

Ms. Traci Barkley
Water Resources Scientist
Prairie Rivers Network
(National Wildlife Federation Regional Affiliate)

Mr. Ed Hopkins
Sierra Club

Mr. Jack Darin, Director
Sierra Club, Illinois Chapter

Mr. David Alberswerth
Senior Energy Policy Advisor
The Wilderness Society

Ms. Nada Culver, Senior Director
The Wilderness Society

Mr. Taylor McKinnon, Public Lands Campaign
Director
Center for Biological Diversity

Mr. Richard Liebert, Chairman
Citizens for Clean Energy, Inc.

Ms. Barbara Bauman Tyran, Director
Washington and State Relations
Electric Power Research Institute

Mr. Timothy Ballo, Senior Associate Attorney
Earthjustice

Mr. Eddie Johnston
Managing Director – Infrastructure
Gas Technology Institute

Mr. Erich Pica, President
Friends of the Earth

Mr. David Hawkins, Director
Climate Programs, Washington Office
Natural Resources Defense Council

Mr. Robert A. Beck, Executive Vice President
National Coal Council

Libraries

Arcola Public Library

Jacksonville Public Library

M-C River Valley Public Library District

Taylorville Public Library

Tuscola Public Library

Interested Parties

Mr. Dean Alger
Duke Energy Generating Services

Mr. Dean W. Applebee

Mr. Jeff Armstrong
WILS News

Ms. Kathy Atchling
Preedy Ballard

Ms. Ruby Ballad

Mr. Kyle Barry

Ms. Bonita Becker

Mr. Carl Becker

Ms. Jane Becker

Mr. Todd Becker

Mr. Weldon Becker

Ms. Vikkie Becker
Diversified Crop Insurance Service

Ms. Karen Bender, Associate Director
Office of Corporate Relations

Ms. Diane Bingaman

Mr. J.R. Blair

Ms. Joyce Blumenshine
Sierra Club

Ms. Patricia Boldt

Mr. Keith Bradbury
Franklin Bank

Mr. David Brown
FutureGen

Mr. Jack Brown
Christian County Generation

Mr. Chris Burger
Patrick

Mr. Chris Cain, Facility Manager
Lyondellbasell – Equistar Chemicals

Mr. Ron Carney

Mr. Tom Carney

Mr. Kenneth Carpenter

Mr. Willis E. Chupp

Alex Cole

Mr. W. Brian Cole

Jamie Cosgriff

Mr. Curt & Cindy Cravens

Clas Crawford

Mr. Jim Crum

Mr. Martin Culik
C12 Energy

Mr. Ron Cummings
IBEW

Mr. Robert Dahlmann

Mr. Mike Damler, President
TEDI

Mr. Andy Davenport

Mr. David Davenport

Mr. Phil Deal

Mr. Bob Denton, Facility Manager
Duke Energy Generating Services

Iris and Noel Dicks

Mr. Kevin Doellman
WICD-TV

Ms. Karyl Dressen

Mr. Aaron Dufelmeier
University of Illinois Extension

Mr. Jim Duncan

Ms. Ashley Durbin
TEDI

Ms. Catherine Edmiston

Mr. Jadon Evans

Mr. Rickey Ferguson

Mr. Randy Fisher

Mr. Duane Friend
University of Illinois Extension

Mr. Paul Friesema
Environmental Policy and Culture Program
Northwestern University

Mr. James Goldsborough
Goldsborough Electric, LLC

Ms. Lanette Goldsborough
Goldsborough Electric, LLC

Mr. Phil Gonet
Illinois Coal Association

Mr. Jeff Gonka
Tenaska

Mr. Tom Grojean
Grojean Realty and Insurance Agency

Mr. David L. Gross, Ph.D.

Mr. Robert Guennewig

Mr. Nestor F. Gutierrez
Buena Vista Farms

Kelly Hall

Mr. Roger Hardy

Mr. Fred W. Heilich

Mr. Fred Helmuth, President
West Prairie Water Company

Mr. Peter Hessler

Ms. Colleen Hester
MacMurray College

Mr. Mike Hilgerberg

Ms. Pamela Hondwickle

Mr. Bill Houlinhan

Trent and Dawn Huddleston
Elegant Occasion Bridal

Mr. Phil Jagucki
Schlumberger

Reg and Eleanor Jobisch

Mr. John Johnson

Mr. Richard A. Johnson

Mr. Reginald Jordan, Administrator
Pleasant Hill Healthcare

Mr. Mitchell Karr

Mr. Scott Kaufman

Mr. Ed Kindred

Mr. Kevin Klein

Mr. Thomas Klincar, President
John Wood Community College

Mr. Nick Kovatch
WLDS/WEAI News

Mr. Tim Landis
The State Journal-Register

Mr. Alan Lauher, President
Central Illinois Building and Construction Trades

Ms. Joan Lawrence

Ms. Colleen Lehmann
The Tuscola Journal

Mr. Scott Lensink, President
Lake Land College

Mr. Greg Lepper

Mr. Mike Long

Mr. Derek Markley, Special Assistant to the
President
Eastern Illinois University

Mr. Ernie Marsh
GSI

Mr. Gary Martin

Mr. Marvin L. Martin

Ms. Pam Martin
Illinois College

Ms. Patty Martin-Culling

Mrs. Susan Mattes

Mr. Roy Maul

Mr. Jim McCabe
WLDS/WEAI News

Mr. Doug McCumber, President
First National Bank of Arcola

Ms. Bree Meier

Mr. David Mercer, Correspondent
The Associated Press

Mr. Homer Miller

Ms. Kellie Miller

Mr. Emerson Moore

Ms. Norma Jean Moore

Mr. Albert Musch

Mr. Greg Neff

Ms. Betty Niemann

Mr. Jeffrey Niemann

Ms. Virginia Niemann

Mr. Larry Nolan

Mr. Jack Norman

Mr. Jim Oliver
The Farmers State Bank and Trust Company

Mr. Richard Ommen

Ms. Melissa Pantier
Illinois College

Ms. Kathryn F. Payser

Mr. Steve Perkins

Ms. Vicki Perkins

Dr. William Perry, President
Eastern Illinois University

Mr. Jeff Phillips

Mr. Jim Prescott
Tenaska

Ms. Beverly Pryor

Mr. David Pryor

Mr. Brad Pullen, Assistant Vice President
First Mid-Illinois Bank & Trust

Mr. Tom Ramage, President
Parkland College

Ms. Carolyn Randall
Uffelman Farms, Inc.

Mr. Johnny F. Rentz

Mr. Alan Rider

Mr. Bob Roads

Mr. Jake Russell
Journal-Courier

Ms. Patty Rykhuis

Ms. Becky Sandu

Ms. Marilyn Schutt

Mr. Garret Selinger
ICCS

Mr. Alan Shoemaker
Tuscola Stone Company

Mr. Gary Spurling
Christian County Generation

Ms. Kelly Staak

Mr. Mike Step, HSEQT Manager
Lyondellbasell – Equistar Chemicals

Mr. Axel Steuer
Illinois College

Ms. Sally Stock

Ms. Marsha R. Strader

Mr. Joe Strea
Parkland College

Mr. Joe Streit, Program Manager
Parkland – Business Training and Community
Education

Mr. Geoff Summerville
Summerville Enterprises

Ms. Karen E. Surratt

Mr. Ron Swager
PEI

Ms. Nadine Szczepanski
MacMurray College

Ms. Jan Terry
Lincoln Land Community College

Ms. Kathy Turner

Mr. Roger Ward

Ms. Rachel Wells
Illinois Times

Mr. Roger West
Carpenters Local 904

Mr. Dan Whalen

Mr. David Wirth

Mr. Allan Worrell
Chamber of Commerce

Mr. David Wortman

INTENTIONALLY LEFT BLANK

9 LIST OF PREPARERS

U.S. Department of Energy – National Energy Technology Laboratory

Cliff Whyte, P.E. – NEPA Compliance Officer, Document Manager

Thomas A. Sarkus – FutureGen Project Director

Jeffrey Hoffmann – Federal Project Manager

Nelson F. Rekos – Federal Project Manager

Potomac-Hudson Engineering, Inc.

Frederick J. Carey, P.E. – Project Manager
M.S., Environmental Engineering
B.S., Civil Engineering
20 years of experience in NEPA documentation and analysis.

Andrea Wilkes – Document Manager/Deputy Project Manager
M.A., Science Writing
B.S., Civil and Environmental Engineering
B.S., English Literature
27 years experience in environmental engineering, science writing, and NEPA documentation and analysis.

Cynthia Ong – Deputy Project Manager
M.S., Environmental Sciences
B.S., Civil Engineering
8 years of experience in general civil site design work, and NEPA documentation and analysis.

Melissa Sanford – Data Manager/Environmental Scientist
B.S., Meteorology
B.S., Business Management
5 years of experience in project coordination, environmental data quality analysis, technical reports, and NEPA documentation and analysis.

Anthony Becker – Environmental Scientist
M.S., Biology
B.S., Biology
5 years of experience in ecological investigations, and NEPA documentation and analysis.

Teresa Beltran – Executive Assistant
15 years of administrative experience.

Brian Boose – Senior Environmental Scientist
B.S., Biological Sciences/Ecology
23 years of experience in NEPA documentation and analysis, conducting NEPA training courses, wetlands delineations, threatened/endangered species surveys, habitat characterization, and permitting.

A. Brook Crossan, Ph.D., P.E. – Senior Environmental Engineer
Ph.D., Geophysical Fluid Dynamics
M.S., Mechanical Engineering
B.S., Mechanical Engineering
37 years of experience in NEPA documentation and analysis.

Paul DiPaolo – Environmental Scientist
B.S., Environmental Science and Policy
2 years of experience in NEPA documentation and analysis.

Robin Griffin – Senior Environmental Scientist
M.S., Environmental Management
B.A., English Composition
17 years of experience in NEPA documentation and analysis.

Joseph A. Grieshaber – Senior Environmental Scientist
M.B.A., Finance
M.S., Biology
B.S., Biology
36 years of experience, including 21 years of environmental management, and NEPA documentation and analysis.

Timothy Lavalley, P.E. – Senior Environmental Engineer
M.S., Civil and Environmental Engineering
B.S., Mechanical Engineering
20 years of experience in NEPA documentation and analysis.

Jamie Martin-McNaughton – Environmental Scientist
B.S., Geology-Biology
6 years of experience in geological field work, and NEPA documentation and analysis.

Erin J. McNutt – Environmental Scientist
M.S., Ecology
B.S., Conservation
2 years of experience in NEPA documentation and analysis.

Robert A. Naumann – Environmental Scientist
M.S., Environmental Science
B.S., Natural Resources
13 years of experience in environmental compliance, wetlands, and forestry, and NEPA documentation and analysis.

Samir A. Qadir – Environmental Scientist
M.S., Environmental Policy
B.S., Electronics and Telecommunications Engineering
8 years of experience in environmental analysis and program support, compliance audits, and NEPA documentation and analysis.

Christopher Rua – Environmental Scientist
B.S., Environmental Planning & Design
11 years of experience in site investigations, wetland and habitat surveys, and NEPA documentation and analysis.

Stacey Schueler – Environmental Scientist
B.S., Environmental Studies
9 years of experience in site remediation, natural resource studies, and NEPA documentation and analysis.

Deborah Shinkle – GIS Analyst
B.A., Environmental Studies
8 years of experience in data analysis and GIS experience on federal projects.

Rachel M. Spangenberg – Senior Environmental Scientist
B.S., Biology
23 years of experience in environmental compliance audits, and NEPA documentation and analysis.

Amanda Tyrell – Environmental Scientist
M.S., Environmental Sciences and Policy
B.S., Integrated Science and Technology
12 years of experience in environmental management, environmental due diligence, and NEPA documentation and analysis.

Debra Walker – Principal Scientist
B.S., Biology
35 years of experience in NEPA documentation and analysis.

Brian Whipple – Principal Engineer
M.S., Information Systems
B.S., Environmental Engineering
17 years of experience in environmental management, compliance audits, site assessments and remediation engineering projects, and NEPA documentation and analysis.

Tetra Tech, Inc. (Health Risk Assessment)

Karen Summers – Technical Lead
M.S., Geology
B.A., Geology
35 years of experience with NEPA documentation and analysis.

Carrie Munill – GIS Specialist
Graduate studies in Geography, GIS, and Spatial Statistics
B.S., Ecology and Evolutionary Biology
12 years of experience in GIS mapping and geography.

Kateryna Sayenko – Programmer and Modeler
M.S., Computer Science
10 years of programming and modeling experience including atmospheric and dense gas modeling.

Michael Unga – Principal Scientist and Modeler
Ph.D., Forest Science
M.S., Mechanical and Aerospace Engineering
B.S., Aeronautical and Astronautical Engineering
28 years of modeling experience including evaluation of CO₂ pipelines, tanks, and wells.

Disclosure Statement
Environmental Impact Statement
FutureGen 2.0 Project
DOE / EIS-0460D

CEQ Regulations at 40CFR 1506.5(c), which have been adopted by the DOE (10 CFR 1021), require contractors who will prepare an EIS to execute a disclosure specifying that they have no financial or other interest in the outcome of the project. The term “financial interest or other interest in the outcome of the project” for the purposes of this disclosure is defined in the March 23, 1981, guidance “Forty Most Asked Questions Concerning CEQ’s National Environmental Policy Act Regulations,” 46 FR 18026-18038 at question 17a and b.

“Financial interest or other interest in the outcome of the project” includes “any financial benefit such as a promise of future construction or design work in the project, as well as indirect benefits the contractor is aware of (e.g., if the project would aid proposals sponsored by the firm’s other clients).” See 46 FR 18026-18031.

In accordance with these requirements, the entity signing below hereby certifies as follows: (check either (a) or (b) and list items being disclosed if (b) is checked).

Financial Interest:

(a)	X	Has no past, present, or currently planned financial interest in the outcome of the project.
(b)		Has the following financial interest in the outcome of the project and hereby agrees to mitigate to the extent necessary to preclude a conflict prior to award of this contract:

- 1.
- 2.
- 3.

Contractual Interest:

(a)	X	Has no past, present, or currently planned financial interest in the outcome of the project.
(b)		Has the following financial interest in the outcome of the project and hereby agrees to mitigate to the extent necessary to preclude a conflict prior to award of this contract:

- 1.
- 2.
- 3.

FutureGen 2.0 Project

Organizational Interest:

(a)	X	Has no past, present, or currently planned financial interest in the outcome of the project.
(b)		Has the following financial interest in the outcome of the project and hereby agrees to mitigate to the extent necessary to preclude a conflict prior to award of this contract:

- 1.
- 2.
- 3.

Other Interest:

(a)	X	Has no past, present, or currently planned financial interest in the outcome of the project.
(b)		Has the following financial interest in the outcome of the project and hereby agrees to mitigate to the extent necessary to preclude a conflict prior to award of this contract:

- 1.
- 2.
- 3.

Certified by:



December 10, 2012

Signature

Date

Frederick J. Carey

Name & Title (Printed)

Potomac-Hudson Engineering, Inc.

Company

FutureGen 2.0 Project

Disclosure Statement
Environmental Impact Statement
FutureGen 2.0 Project
DOE / EIS-0460D

CEQ Regulations at 40CFR 1506.5(c), which have been adopted by the DOE (10 CFR 1021), require contractors who will prepare an EIS to execute a disclosure specifying that they have no financial or other interest in the outcome of the project. The term "financial interest or other interest in the outcome of the project" for the purposes of this disclosure is defined in the March 23, 1981, guidance "Forty Most Asked Questions Concerning CEQ's National Environmental Policy Act Regulations," 46 FR 18026-18038 at question 17a and b.

"Financial interest or other interest in the outcome of the project" includes "any financial benefit such as a promise of future construction or design work in the project, as well as indirect benefits the contractor is aware of (e.g., if the project would aid proposals sponsored by the firm's other clients)." See 46 FR 18026-18031.

In accordance with these requirements, the entity signing below hereby certifies as follows: (check either (a) or (b) and list items being disclosed if (b) is checked).

Financial Interest:

(a)	X	Has no past, present, or currently planned financial interest in the outcome of the project.
(b)		Has the following financial interest in the outcome of the project and hereby agrees to mitigate to the extent necessary to preclude a conflict prior to award of this contract:

- 1.
- 2.
- 3.

Contractual Interest:

(a)	X	Has no past, present, or currently planned financial interest in the outcome of the project.
(b)		Has the following financial interest in the outcome of the project and hereby agrees to mitigate to the extent necessary to preclude a conflict prior to award of this contract:

- 1.
- 2.
- 3.

FutureGen 2.0 Project

Organizational Interest:

(a)	X	Has no past, present, or currently planned financial interest in the outcome of the project.
(b)		Has the following financial interest in the outcome of the project and hereby agrees to mitigate to the extent necessary to preclude a conflict prior to award of this contract:

- 1.
- 2.
- 3.

Other Interest:

(a)	X	Has no past, present, or currently planned financial interest in the outcome of the project.
(b)		Has the following financial interest in the outcome of the project and hereby agrees to mitigate to the extent necessary to preclude a conflict prior to award of this contract:

- 1.
- 2.
- 3.

Certified by:

Karen V. Summers 12/10/2012
Signature Date

Karen V. Summers, Director
Name & Title (Printed)

Tetra Tech
Company

10 GLOSSARY

Term	Definition
100-Year Floodplain	Land that becomes or will become submerged by a flood that has a chance to occur every 100 years (1 percent annual chance of flooding).
500-Year Floodplain	Land that becomes or will become submerged by a flood that has a chance to occur every 500 years (0.2 percent annual chance of flooding).
7Q10	A method of measuring stream flow, calculated as the lowest stream flow for seven consecutive days that would be expected to occur once in 10 years.
A-Weighted Scale	Assigns weight to sound frequencies that are related to how sensitive the human ear is to each sound frequency.
Air Liquide Process & Construction, Inc. (Air Liquide)	An international company that has been involved in the development of oxy-combustion technologies for power generation with carbon capture for the past 10 years. For the FutureGen 2.0 Project, Air Liquide is responsible for developing complex components of the oxy-combustion facility, such as the air separation unit and the compression and purification unit.
Air Separation Unit	An integrated component of the oxy-combustion facility that will supply oxygen for the oxy-combustion boiler by separating oxygen and nitrogen from the air through a cold distillation process.
Alluvial	Relating to, composed of, or found in alluvium, which is defined as loose, unconsolidated soil or sediments, which have been eroded, reshaped by water in some form, and deposited in a non-marine setting.
Ambient	Of or relating to the conditions of the surrounding environment or atmosphere as it normally exists.
Ameren Energy Resources (Ameren)	An integrated energy commodity holding company, created in 2000 for providing energy solutions to the midwestern United States market. The original owner and operator of the Meredosia Energy Center, which was selected by the Department of Energy's clean coal power program to be the site for the FutureGen 2.0 Project.
Annual Average Daily Traffic	The total volume of vehicle traffic for a highway or road for a year divided by 365 days.
Aquifer	Underground geologic formation composed of permeable layers of rock or sediment that holds and transmits water.
Archaeological Resource	Any material remains of the past, which offer the potential for investigation, analysis, and contribution to the understanding of past human communities.
Area of Potential Effect	The geographic area or areas within which an undertaking may directly or indirectly cause alterations in the character or use of historic properties.

Term	Definition
Area of Review	Defined by the U.S. Environmental Protection Agency as the region surrounding the geologic sequestration project where underground sources of drinking water may be endangered by the injection activity.
Attainment Area	A geographic area that meets the National Ambient Air Quality Standards for a criteria pollutant.
Auxiliary Boiler	The boiler that would be used to provide steam to the plant that is needed during the startup process.
Babcock & Wilcox Power Generation Group, Inc. (Babcock & Wilcox)	An international company that designs, manufactures, and constructs steam generating systems and emissions control equipment for utilities and industry. Developing the boiler island and gas quality control system for the FutureGen 2.0 oxy-combustion facility.
Bedrock	Unweathered rock overlaid in most places by soil or rock fragments.
Best Management Practices	Methods, measures, or practices that are generally used in industry to prevent or reduce the contributions of pollutants to the environment.
Blowdown	The portion of steam or water removed from a boiler or recirculating cooling tower at regular intervals to prevent the excessive accumulation of dissolved and suspended materials.
Booster Pump Building	The building that would house the well injection pumps and associated flow meters, flow control valves, and variable speed drive cabinets (for the dual-site scenario only).
Bottom Ash	Coarse particles generated during the combustion of coal that fall by gravity to the bottom of the boiler.
Brine	Highly salty and heavily mineralized water that may contain heavy metal and organic contaminants.
Capillary Pressure	Additional pressure needed for a liquid or gas to enter a pore and overcome surface tension, or to cross the interface with an immiscible fluid (e.g., CO ₂ into brine).
Caprock	The geologic formation or formations that overlie the injection zone and act as a confining layer to prevent the upward vertical migration of CO ₂ out of the injection zone. Caprock is typically comprised of low permeability and porosity rock layers (typically shale, limestone, or dolomite) making it relatively impermeable.
Carbon Capture and Storage	The process of capturing CO ₂ and ultimately injecting it into underground geologic formations for secure storage. Sometimes referred to as carbon capture and sequestration.

Term	Definition
Carbon Dioxide	A greenhouse gas created by natural processes such as animal and plant respiration as well as from human activity such as the burning of fossil fuels.
Circulating Dry Scrubber	Scrubber used in the oxy-combustion gas quality control system to remove sulfur dioxide and sulfur trioxide from flue gas. Also called a circulating fluidized bed – flue gas desulfurization unit.
Compression and Purification Unit	Component of the oxy-combustion facility that purifies and compresses treated flue gas for delivery to the CO ₂ pipeline.
Cooling Tower	A structure that is used to provide cool water for the condensation of steam in the steam condenser, and to remove excess heat from other system processes (e.g., air separation and compression and purification units) by circulating the water along a series of panels through which cool air passes.
Cooling Water	Water that is heated as a result of being used to cool steam and condense it to water.
Criteria Pollutant	The Clean Air Act of 1970 required the U.S. Environmental Protection Agency to set air quality standards for common and widespread pollutants to protect human health and welfare. There are six criteria pollutants: ozone, carbon monoxide, sulfur dioxide, lead, nitrogen dioxide, and particulate matter.
Critical Habitat	A geographic area that contains features essential for the conservation of a threatened or endangered species that may require management and protection.
Cultural Resource	Archaeological resources, including prehistoric and historic archaeological sites; historic resources; cultural or historic landscapes or viewsheds; Native American resources; and paleontological resources.
Cumulative Impact	The impact on the environment that results from the incremental impact of the action when added to other past, present, and reasonably foreseeable future actions regardless of what agency (federal or non-federal) or person undertakes such other actions.
Day-Night Sound Level	A-weighted equivalent decibel level for a 24-hour period with an additional 10-decibel weighting imposed on the equivalent sound levels occurring during nighttime hours (10 p.m. to 7 a.m.).
De minimis	So small or minimal that it does not matter or the law does not take it into consideration.
Decibel	A unit for expressing the relative intensity of sounds on a logarithmic scale.
Demographics	The statistical data of a population, especially those showing average age, income, education, etc.

Term	Definition
Direct Contact Cooler Polishing System	Component of the oxy-combustion gas quality control system facility that removes moisture and sulfur dioxide from treated flue gas.
Direct Impact	Impact or effect that occurs at the same time and place.
Easement	The right of use over the property of another owner.
Effluent	Waste stream flowing into the atmosphere, surface water, groundwater, or soil.
Eminent Domain	The right of a government to appropriate private property for public use upon payment of its fair market value to the owner; private entities can be granted the right of eminent domain by a government for special purposes.
Emissions	Release of gases and particles into the atmosphere from various sources.
Endangered Species	A species, subspecies, or varieties in danger of extinction throughout all or a significant portion of their range. The federal list of endangered species can be found in 50 CFR 17.11 (wildlife), 50 CFR 17.12 (plants), and 50 CFR 222.23 (marine organisms). The Illinois Endangered Species Protection Board also maintains a list of endangered species regulated by the Illinois Department of Natural Resources.
Environmental Justice	The fair treatment and meaningful involvement of all people – regardless of race, ethnicity, and income or education level – in environmental decision-making. Environmental Justice programs promote the protection of human health and the environment, empowerment via public participation, and the dissemination of relevant information to inform and educate affected communities.
Ephemeral Stream	An ephemeral stream has flowing water only during, and for a short duration after, precipitation events in a typical year. Ephemeral streambeds are located above the water table year-round. Groundwater is not a source of water for the stream. Runoff from rainfall is the primary source of water for stream flow.
Fault	A subsurface fracture or discontinuity in geologic strata, across which there is observable displacement as a result of earth movement.
Floodplain	Flat or nearly flat land adjacent to a stream or river that experiences occasional or periodic flooding.
Flue Gas	Residual gases resulting from combustion that are vented to the atmosphere through a flue or chimney.
Fluvial	Refers to the processes associated with rivers and streams and the deposits and landforms created by them.

Term	Definition
Fly Ash	Fine particles generated during combustion that are collected by electrostatic precipitators or baghouses prior to discharge of the flue gas to the atmosphere.
Formation	The primary unit associated with formal geological mapping of an area. Geologic formations possess distinctive geologic features and can be combined into groups or subdivided into member or units.
Fugitive Dust	Airborne particulate matter typically associated with disturbance of unpaved haul roads, wind erosion of exposed surfaces, and other activities in which material is removed and redistributed.
FutureGen Industrial Alliance, Inc. (Alliance)	A non-profit organization created to benefit the public interest and the interests of science through research, development, and demonstration of near-zero emissions coal technology. Formed to partner with the Department of Energy on the FutureGen Initiative. Current members include Alpha Natural Resources, Inc.; Anglo American, SA; Joy Global, Inc.; Peabody Energy Corporation; and Xstrata PLC.
FutureGen Initiative	A \$1 billion, 10-year demonstration project initiated by President Bush in 2003 to create the world's first coal-based, zero emissions electricity and hydrogen power plant to support other federal initiatives, including the National Climate Change Technology Initiative (2001) and the Hydrogen Fuel Initiative (2003).
Gas Quality Control System	Collection of oxy-combustion facility components that treat flue gas generated during the combustion process to remove pollutants, recover heat, and prepare the gas for the compression and purification unit.
Greenhouse Gas	Gas that contributes to the greenhouse effect by absorbing and re-emitting infrared radiation and ultimately warming the atmosphere. Greenhouse gases include water vapor, carbon dioxide, ozone, methane, nitrous oxide, and several classes of halogenated substances that contain fluorine, chlorine, or bromine (including chlorofluorocarbons).
Hazardous Air Pollutant	Air pollutants that are not covered by ambient air quality standards, but may present a threat of adverse human health effects or adverse environmental effects, and are specifically listed in 40 CFR 61.01.
Hazardous Waste	Solid waste that exhibits at least one of four characteristics (ignitability, corrosivity, reactivity, or toxicity), or that is specifically listed by the U.S. Environmental Protection Agency as a hazardous waste; but is not specifically exempted in the U.S. Environmental Protection Agency regulations. Hazardous waste is regulated under the Resource Conservation and Recovery Act (RCRA) Subtitle C.
Historic Resource	Prehistoric or historic district, site, building, structure, or object included in, or eligible for inclusion in, the National Register of Historic Places.

Term	Definition
Hydrated Lime	A white powder obtained when lime (a mixture of calcium-containing inorganic materials, predominantly carbonates, oxides, and hydroxides) is heated and then mixed with water, or hydrated. Also known as calcium hydroxide. Among other uses, hydrated lime is an absorbent for the removal of acid gases.
Hydric Soil	A soil that is saturated, flooded, or ponded long enough during the growing season to develop anaerobic (oxygen-lacking) conditions that favor the growth and regeneration of water-adapted vegetation.
Hydrology	A science dealing with the properties, distribution, and circulation of water on the surface of the land, in the soil and the underlying rocks, and in the atmosphere.
Hydrostatic Testing	Testing that is conducted by filling a vessel (pipeline) with water and pressurizing it and then checking for pressure losses or deformation.
Indirect Impact	An impact that occurs later in time or farther removed in distance, but is still reasonably foreseeable.
Injection Well	A deep well used to inject supercritical CO ₂ into the injection zone for permanent geologic storage.
Injection Zone	A geologic formation, group of formations, or part of a formation that is of sufficient areal extent, thickness, porosity, and permeability to receive CO ₂ through an injection well or wells associated with a geologic sequestration project.
Integrated Gasification Combined Cycle	A process that uses synthesis gas derived from coal to drive a gas combustion turbine and exhaust gas from the gas turbine to generate steam from water to drive a steam turbine. This technology was considered under the original FutureGen Initiative; however, it is not a component of the proposed project.
Intermittent Stream	An intermittent stream has flowing water during certain times of the year, when groundwater provides water for stream flow. During dry periods, intermittent streams may not have flowing water. Runoff from rainfall is a supplemental source of water for stream flow.
Loam	A rich, friable soil containing a relatively equal mixture of sand and silt and a somewhat smaller proportion of clay.
Loess	Dust-like soil formed by the accumulation of wind-blown silt, comprised of clay, sand, and silt that is loosely cemented by calcium carbonate. It is usually homogenous and highly porous.
Low-Income Population	Identified where households have an annual income below the poverty threshold, which was \$22,050 for a family of four at the time of the 2010 Census.

Term	Definition
Mainline Block Valve	Design feature of a pipeline that blocks flow at a certain point so as to isolate and contain any line leak.
Minority	As defined by the Council on Environmental Quality, an individual who is American Indian or Alaskan Native; Black or African American; Asian; Native Hawaiian or Pacific Islander; or Hispanic or Latino.
Minority Population	Identified where either more than 50 percent of the population of the affected area is minority, or the affected area's minority population percentage is meaningfully greater than the minority population percentage in the general population or other appropriate unit of geographic analysis.
Mitigation Measure	Measures taken to reduce adverse impacts on the environment.
Mooring Dolphin	Freestanding structure above the water line used to secure vessels with ropes.
Moraine	Glacial deposits of unsorted and unstratified material.
Mt. Simon Formation	The Mt. Simon Formation is the major deep saline formation where CO ₂ from the Meredosia Energy Center would be injected through deep injection wells. The Mt. Simon Formation is the primary formation that makes up the injection zone.
National Ambient Air Quality Standards	Nationwide standards set up by the U.S. Environmental Protection Agency for widespread air pollutants, as required by Section 109 of the Clean Air Act. Currently, six pollutants are regulated: carbon monoxide, lead, nitrogen dioxide, ozone, particulate matter, and sulfur dioxide (i.e., the six criteria pollutants).
National Environmental Policy Act	Signed into law on January 1, 1970. U.S. statute that requires all federal agencies to consider the potential effects of proposed actions on the human and natural environment.
National Pollutant Discharge Elimination System	Provision of the Clean Water Act that prohibits discharge of pollutants into U.S. waters unless a permit allowing such a discharge is issued by the U.S. Environmental Protection Agency, a state, or where delegated, a tribal government on a Native American reservation.
National Register of Historic Places	The official list of the nation's historic places worthy of preservation. Authorized by the National Historic Preservation Act of 1966 and managed by the National Park Service. To be considered eligible, a property must meet the National Register Criteria for Evaluation, including the property's age, integrity, and significance.
No Action Alternative	The project baseline condition or future condition if no action is taken. Used to measure the effects of action alternatives.
Noise Abatement Criteria	Provides a benchmark to assess the level at which noise becomes a clear source of annoyance for different land uses.

Term	Definition
Oxy-Combustion	The combustion of coal with a mixture of manufactured oxygen and recycled flue gas, versus atmospheric air, resulting in a gas by-product primarily comprised of CO ₂ .
Paleontological Resource	Any fossilized remains, traces, or imprints of organisms, preserved in or on the earth's crust, that are of paleontological interest and that provide information about the history of life on earth.
Particulate Matter	Fine liquid or solid particles such as dust, smoke, mist, fumes, or smog, found in air or emissions.
Perennial Stream	Waterbody present at all seasons of the year.
Permissible Exposure Limit	The legal limit established by the Occupational Safety and Health Administration for exposure of an employee to hazardous substances. A permissible exposure limit is usually given as an 8-hour time weighted average exposure. This means that for limited periods a worker may be exposed to concentrations higher than the permissible exposure limit, so long as the average concentration over 8 hours remains lower.
pH	A measure of the relative acidity or alkalinity of a solution, expressed on a scale from 0 to 14 with the neutral point at 7. Acid solutions have pH values lower than 7, and basic (i.e., alkaline) solutions have pH values higher than 7.
Physiographic Region	A portion of the Earth's surface with a basically common topography and common morphology.
Pore Space	The spaces within a rock body that are unoccupied by solid material. Pore space refers to voids between grains or crystals in rock formations, including spaces caused by cracks. As part of the FutureGen 2.0 Project, the pore space would be used for permanent geologic storage of CO₂.
Potable Water	Water that is safe and satisfactory for drinking and cooking.
Prime Farmland	A special category of highly productive cropland that is recognized and described by the U.S. Department of Agriculture's Natural Resource Conservation Service and receives special protection under the Federal Farmland Protection Act.
Process Water Systems	The water intake structures and wells that would be used to supply water to the plant, and new water treatment systems to remove water impurities.
Programmatic Agreement	A document that spells out the terms of a formal, legally binding agreement between an agency and other state and/or federal agencies. Two basic kinds: (1) describes the actions that will be taken by the parties in order to meet their environmental compliance responsibilities for a specific project; (2) establishes a process through which the parties will meet their compliance responsibilities for an agency program, a category of projects, or a particular type of resource.

Term	Definition
Proposed Action	The activity, including the project and its related support activities, proposed to accomplish a federal agency's purpose and need.
Protective Action Criteria	Criteria for determining the potential health effects from exposure to accidents developed by the Department of Energy's Subcommittee on Consequence Actions and Protective Assessments.
Pulse Jet Fabric Filter	Component of the oxy-combustion gas quality control system facility that removes particulate matter (e.g., fly ash) from the flue gas discharged from the circulating dry scrubber.
Record of Decision	The formal concluding document of the National Environmental Policy Act process, which states the agency's decision, along with the rationale for its selection. Announced by a Notice of Availability in the <i>Federal Register</i> .
Region of Influence	Defines the geographic extent of the area to be analyzed in the environmental impact statement for potential impacts to each respective resource area.
Rip-Rap	Rock or other material used to armor shorelines, streambeds, bridge abutments, pilings, and other shoreline structures against scour, water, or ice erosion. It can be used on any waterway or water containment where there is potential for water erosion.
Saline	Water with high concentrations of salts (typically more than 10,000 parts per million dissolved solids), making it unsuitable for use.
Scoping	An early and open process for determining the scope of issues to be addressed and for identifying the significant issues related to a proposed action.
Scrubber	A device that removes noxious gases (such as sulfur dioxide) from flue gas by using absorbents suspended in a liquid solution.
Seismic	Pertaining to, characteristic of, or produced by earthquakes or earth vibrations.
Sensitive Receptor	Any specific resource (i.e., population or facility) that would be more susceptible to the effects of implementing the proposed action than would otherwise be. Includes, but is not limited to, asthmatics, children, and the elderly, as well as specific facilities, such as long-term health care facilities, rehabilitation centers, convalescent centers, retirement homes, residences, schools, playgrounds, and childcare centers.
Short-Term Exposure Limit	A concentration which workers can be exposed to routinely for a short period of time without suffering significant effects, but which should not occur more than four times per day and not longer than 15 minutes each time. Established by the American Conference of Governmental Industrial Hygienists.

Term	Definition
Site Control Building	The building that would house the major operational components of the pipeline and the injection well site(s), including the instruments for monitoring and controlling the injection wells, pipeline operations, and site access (for the dual-site scenario only) .
Site Control and Maintenance Building	The building that would house the major operational components of the pipeline and injection well site, including the instruments for monitoring, maintenance, and controlling the injection wells, pipeline operations, and site access (for the single-site scenario only).
Socioeconomics	An umbrella term that may refer broadly to the use of economics in the study of society. More narrowly, a discipline studying the reciprocal relationship between economic science on the one hand and social philosophy, ethics, and human dignity on the other.
Sound Pressure Level	The quantitative expression of the physical intensity or loudness level of noise sources.
Spur	The hypothetical end-of-pipeline route that would run from the end of the northern pipeline route (originating at the western edge of the CO ₂ storage study area) to hypothetical injection well sites within the CO ₂ storage study area used to support the impact analysis of the northern pipeline route in this document.
Stormwater Pollution Prevention Plan	A plan for stormwater discharge that includes erosion prevention measures and sediment controls that, when implemented, will decrease soil erosion on a parcel of land decreases offsite nonpoint pollution.
Stratigraphic Well	An exploratory well drilled for the purpose of gathering geologic information on the composition and relative position of rock strata of an area. The Alliance completed a stratigraphic well in the CO ₂ storage study area in December 2011 to collect data with which to characterize the geology and hydrogeology of the area to support the design and permitting of the project as well as the analysis of impacts in this environmental impact statement.
Supercritical CO₂	CO ₂ usually behaves as a gas in air or as a solid in dry ice. If the temperature and pressure are both increased (above its supercritical temperature of 88°F [31.1°C] and 73 atmospheres [1073 pounds per square inch]), it can adopt properties midway between a gas and a liquid, such that it expands to fill its container like a gas, but has a density like that of a liquid.
Supervisory Control and Data Acquisition	The communication system that would transmit information and data about pipeline performance.
Temporary Barge Unloading Facility	The existing boat ramp area located north of the Meredosia Energy Center and southwest of the village of Meredosia that would be used to unload a number of large modules for the construction of the oxy-combustion facility.

Term	Definition
Threshold Limit Value	A concentration, established by the American Conference of Governmental Industrial Hygienists, at which it is believed a worker can be exposed day after day for a working lifetime without adverse health effects.
Till	The unsorted sediment deposited directly below a glacier, which exhibits a wide range of particle sizes, from fine clay to rock fragments and boulders.
Topography	The relief features or surface configuration of an area.
Traditional Cultural Property	District, site, building, structure, or object that is valued by a community for the role it plays in sustaining the community's cultural integrity.
Tributary	A stream that flows to a larger stream or other body of water.
Trona	A naturally-occurring hydrated sodium carbonate mineral that is used in the gas quality control system to reduce sulfur trioxide concentrations in the flue gas and in the direct contact cooler polishing system to reduce sulfur dioxide at the compression and purification unit inlet.
Turbidity	The cloudiness or haziness of a fluid caused by individual particles (suspended solids) that are generally invisible to the naked eye, similar to smoke in air.
Viewshed	The land, water, cultural, and other aesthetic elements that are visible from a fixed vantage point.
Volatile Organic Compound	Chemical compounds that contain carbon and evaporate readily at ordinary, room-temperature conditions. As defined in 40 CFR 51.100(s), any compound of carbon that participates in atmospheric photochemical reactions, excluding carbon monoxide, carbon dioxide, carbonic acid, metallic carbides or carbonates, ammonium carbonate, and other organic compounds designated by the U.S. Environmental Protection Agency as having negligible reactivity.
Wastewater	A combination of liquid and water-carried wastes discharged from residences, commercial establishments, farms, and industrial facilities.
Water of the U.S.	A waterway regulated under the Clean Water Act because it is important for the preservation of navigable waterways and interstate commerce. Subject to federal jurisdiction and permitting under Section 404 of the Clean Water Act and includes all navigable waterways, their tributaries, as well as wetlands contiguous to and adjacent to those navigable waterways and tributaries.
Watershed	A land area bounded by topography that drains water to a particular stream, river, or entire river system.
Well Maintenance and Monitoring System Buildings	The buildings that would contain equipment to supply the injection well with fluid to maintain annulus pressurization in order to prevent leakage from the injection well (for the dual-site scenario only) .

Term	Definition
Wetland	Those areas that are inundated or saturated by surface water or groundwater at a frequency and duration sufficient to support, and that under normal circumstances do support, a prevalence of vegetation typically adapted for life in saturated soil conditions.