

Status of UFD Campaign International Activities in Disposal Research

Fuel Cycle Research & Development

*Prepared for
U.S. Department of Energy
Used Fuel Disposition
Jens Birkholzer
Lawrence Berkeley National Laboratory
September, 2012*

FCRD-UFD-2012-000295



DISCLAIMER

This information was prepared as an account of work sponsored by an agency of the U.S. Government. Neither the U.S. Government nor any agency thereof, nor any of their employees, makes any warranty, expressed or implied, or assumes any legal liability or responsibility for the accuracy, completeness, or usefulness, of any information, apparatus, product, or process disclosed, or represents that its use would not infringe privately owned rights. References herein to any specific commercial product, process, or service by trade name, trade mark, manufacturer, or otherwise, does not necessarily constitute or imply its endorsement, recommendation, or favoring by the U.S. Government or any agency thereof. The views and opinions of authors expressed herein do not necessarily state or reflect those of the U.S. Government or any agency thereof.

FCT Quality Assurance Program Document

Revision 1 8/19/2011

Appendix E FCT Document Cover Sheet

Name/Title of Deliverable/Milestone Status of UFD Campaign International Activities in Disposal Research
Work Package Title and Number CX International – LBNL
Work Package WBS Number FT-12LB081102
Responsible Work Package Manager 1.02.08.11
Jens Birkholzer
(Name/Signature)

Date Submitted 8/14/2012

Quality Rigor Level for Deliverable/Milestone QRL-3 QRL-2 QRL-1 N/A*
 Nuclear Data

This deliverable was prepared in accordance with Lawrence Berkeley National Laboratory
(Participant/National Laboratory Name)

QA program which meets the requirements of
 DOE Order 414.1 NQA-1-2000 Other

This Deliverable was subjected to:

Technical Review

Peer Review

Technical Review (TR)

Peer Review (PR)

Review Documentation Provided

- Signed TR Report or,
- Signed TR Concurrence Sheet or,
- Signature of TR Reviewer(s) below

Review Documentation Provided

- Signed PR Report or,
- Signed PR Concurrence Sheet or,
- Signature of PR Reviewer(s) below

Name and Signature of Reviewer

Hui-Hai Liu

***NOTE** In some cases there may be a milestone where an item is being fabricated, maintenance is being performed on a facility, or a document is being issued through a formal document control process where it specifically calls out a formal review of the document. In these cases, documentation (e.g., inspection report, maintenance request, work planning package documentation or the documented review of the issued document through the document control process) of the completion of the activity along with the Document Cover Sheet is sufficient to demonstrate achieving the milestone. QRL for such milestones may be also be marked N/A in the work package provided the work package clearly specifies the requirement to use the Document Cover Sheet and provide supporting documentation.

This page is intentionally blank.

CONTENTS

1. INTRODUCTION	1
2. INTERNATIONAL OPPORTUNITIES AND STRATEGIC CONSIDERATIONS	1
3. COOPERATIVE INITIATIVES	4
3.1 DECOVALEX Project	4
3.1.1 Introduction to the DECOVALEX Project	4
3.1.2 Overview of Modeling Tasks for DECOVALEX-2015	6
3.1.3 Task A: SEALEX Experiment at the Tournemire URL, France (Focus: EBS)	7
3.1.4 Task B1: HE-E Heater Test at Mont Terri URL, Switzerland (Focus: EBS and its interaction with NBS)	12
3.1.5 Task B2: EBS Experiment at Horonobe URL, Japan (Focus: EBS and its interaction with NBS)	14
3.1.6 Task C1: THMC Processes in Single Fractures (Focus: NBS)	16
3.1.7 Task C2: Bedrichov Tunnel Experiment, Czech Republic (Focus: NBS)	18
3.1.8 DECOVALEX Summary	20
3.2 Mont Terri Project	20
3.2.1 Introduction to the Mont Terri Project	20
3.2.2 FE Heater Test (Focus: both NBS and EBS)	25
3.2.3 Mine-by Test (Focus: NBS)	26
3.2.4 CI Cement-Clay Interaction Experiment (Focus: mostly EBS)	28
3.2.5 HG-A Experiment (Focus: mostly NBS)	30
3.2.6 DR-A Diffusion, Retention and Perturbation Experiment (Focus: NBS)	32
3.2.7 Mont Terri Summary	33
3.3 Colloid Formation and Migration Project	34
3.3.1 Introduction to the CFM Project	34
3.3.2 Colloid-Facilitated Radionuclide Tracer Test (Focus: NBS)	37
3.3.3 Radionuclide-Doped Bentonite Plug Transport Experiment (Focus: both NBS and EBS)	38
3.3.4 Colloid Formation and Migration Summary	39
3.4 SKB Task Forces	40
3.4.1 Bentonite Rock Interaction Experiment (BRIE) (Focus: Both NBS and EBS)	41
3.4.2 Long-Term Diffusion Sorption Experiment (LTDE-SD) (Focus: NBS)	43
3.4.3 Prototype Repository (Focus: Mostly EBS, also NBS)	44
3.4.4 Large-Scale Gas Injection Test (LASGIT) (Focus: Mostly EBS)	46
3.4.5 SKB Task Force Summary	47
3.5 Overview of International Cooperative Initiatives and Participating Countries	47
4. BILATERAL COLLABORATION OPPORTUNITIES	49
4.1 Experiments at HADES URL in Mol, Belgium	49
4.1.1 PRACLAY Test (Focus: mostly NBS, some EBS)	49
4.1.2 Radionuclide Migration Experiments (Focus: NBS)	51
4.2 Experiments at Grimsel Test Site, Switzerland	52
4.2.1 Full-Scale Engineered Barriers Experiment (FEBEX) (Focus: Mostly EBS)	53
4.2.2 Gas-Permeable Seal Test (GAST) (Focus: EBS)	54
4.3 Experiments at KURT URL, Korea	55
4.4 Other URL Opportunities	57

5.	OVERVIEW OF INTERNATIONAL DISPOSAL RESEARCH INVOLVING UFDC RESEARCHERS	60
5.1	Selection of R&D Tasks with Active International Collaboration.....	60
5.2	Brief Status of Work Package Activities Related to International Collaboration Initiatives.....	66
5.2.1	THM Modeling of FE Heater Test at Mont Terri (LBNL)	66
5.2.2	THM Modeling of HE-E Heater Test at Mont Terri (LBNL).....	69
5.2.3	HM Modeling of Mine-by Test at Mont Terri (LBNL)	69
5.2.4	Thermodynamic Modeling of the CI Experiment at Mont Terri (SNL)	72
5.2.5	DFN Modeling of the HG-A Experiment at Mont Terri (LBNL).....	72
5.2.6	Diffusion-Reaction Modeling of the DR-A Experiment at Mont Terri, (LBNL)	73
5.2.7	Interpretative Analysis of Colloid Migration and Radionuclide Transport for CFM Experiments (LANL).....	74
5.2.8	DFN Modeling of BRIE Experiment at Äspö Hard Rock Laboratory (LANL)	75
5.2.9	Using Environmental Tracers to Estimated Fracture Network Properties: Application to the Bedrichov Tunnel Experiment (SNL)	75
5.2.10	Work Plan for R&D Cooperation with KAERI at KURT (SNL)	76
6.	SUMMARY	78
7.	ACKNOWLEDGEMENTS	78
8.	REFERENCES	79

FIGURES

Figure 3-1. SEALEX Experiment at the Tournemire URL: Schematic setup of mini-tunnel with seal core and instrumentation (from Barnichon and Millard, 2012).....	9
Figure 3-2. SEALEX Experiment at the Tournemire URL: Layout of mini-tunnels and main gallery (from Barnichon and Millard, 2012)	9
Figure 3-3. SEALEX Experiment at the Tournemire URL: View of mini-tunnel from gallery after core emplacement (from Barnichon, 2011).....	10
Figure 3-4. SEALEX Experiment at the Tournemire URL: Planned experiments and schedule (from Barnichon, 2011)	10
Figure 3-5. Geological cross section of the Tournemire URL (from Barnichon, 2011).....	11
Figure 3-6. Schematic setup of HE-E Heater Test at Mont Terri URL (from Garitte et al., 2011)	12
Figure 3-7. HE-E Heater Test at Mont Terri URL: Photo of micro-tunnel before buffer emplacement (from Gaus et al., 2012).....	13
Figure 3-8. HE-E Heater Test at Mont Terri URL: Sensor placement, type, and numbers (from Gaus et al., 2012).....	13
Figure 3-9. HE-E Heater Test at Mont Terri URL: Measured and expected temperature over time at heater-buffer interface (from Gaus et al., 2012)	14
Figure 3-10. Planned design of Horonobe URL (from Sugita and Nakama, 2012).....	15
Figure 3-11. Planned design of EBS Experiment at Horonobe URL(from Sugita and Nakama, 2012).....	15
Figure 3-12. THMC behavior affects in a single fracture exposed to different external temperatures and varying stress conditions (from Yasuhara et al., 2006).....	17
Figure 3-13. Bohemian granitic massif in Czech Republic and water inflow evidence in the Bedrichov Tunnel (from Hokr and Slovak, 2011).....	19
Figure 3-14. Bedrichov Tunnel Experiment : Fault and fracture models at site (top) and tunnel (bottom) scale (Hokr and Slovak, 2011).....	19
Figure 3-15. 3D schematic of the Mont Terri URL with side galleries and drifts. Pink area shows newest gallery drilled for Mine-by Test and FE Heater Test (Bossart, 2012).	21
Figure 3-16. List of main Mont Terri URL experiments conducted during Phase 17 (July 2011 through June 2012), displayed with respect to relevancy during different repository stages (Bossart, 2012).....	23
Figure 3-17. Plan view of the Mont Terri URL with main experiments conducted during Phase 17 (July 2011 through June 2012) (Bossart, 2012).....	24
Figure 3-18. FE Heater Test at Mont Terri URL: Plan view of experiment setup and borehole layout (from Garitte, 2010).....	25
Figure 3-19. FE Heater Test at Mont Terri URL: Side view of experiment setup and heater layout (from Garitte, 2010).....	26
Figure 3-20. Schematic setup of Mine-by Test at Mont Terri showing location of selected boreholes for piezometer, extensometer, and inclinometer data (from Vietor et al., 2011).....	27

Figure 3-21. Mine-by Test at Mont Terri URL: Measurements of pore pressure relative to distance from advancing excavation front (from Vietor et al., 2011). Pore-pressure signals can be observed several meters before the advancing tunnel face.	27
Figure 3-22. Schematic setup of CI Experiment at Mont Terri URL (from Maeder and Schwyn, 2012).....	28
Figure 3-23. CI Experiment at Mont Terri URL: Sampling was conducted in two campaigns by drilling angled boreholes through the cement-bentonite-clay interfaces. The bottom photo shows borehole core with interfaces between Opalinus Clay (OPA), bentonite, and CEM-III (cement) (from Maeder and Schwyn, 2012).	29
Figure 3-24. CI Experiment at Mont Terri URL: SEM map indicating interface between concrete (top) and Opalinus Clay (bottom) (from Maeder and Schwyn, 2012).....	29
Figure 3-25. Schematic setup of HG-A Experiment at Mont Terri URL (from Marschall et al., 2012).....	30
Figure 3-26. HG-A Experiment at Mont Terri URL: Installation of packer system (from Marschall et al., 2012).	31
Figure 3-27. HG-A Experiment at Mont Terri URL: Discrete fracture model of EDZ (from Marschall et al., 2012).	31
Figure 3-28. Layout of the DI-A Diffusion Experiment at Mont Terri URL, showing main features of the down-hole and surface equipment (from Wersin et al., 2004; 2008).....	32
Figure 3-29. Schematic illustration of the CFM field test bed at Grimsel Test Site (from Reimus, 2012).....	35
Figure 3-30. CFM field test bed at Grimsel Test Site: Tunnel packer system used to isolate the MI shear zone (from http://www.grimsel.com/gts-phase-vi/cfm-section/cfm-site-preparation). Small disks with tubing issuing from them (inside yellow packer) are “surface packers” that seal the tunnel wall and collect water from inflow points. Tunnel diameter is 3.5 meters.	36
Figure 3-31. CFM field test bed at Grimsel Test Site: Tracer transport pathways and flow distances in the MI shear zone in all tracer tests (2001-present).	36
Figure 3-32. Colloid-Facilitated Radionuclide Tracer Test at Grimsel Test Site: Normalized breakthrough curves of all tracers in CFM Tracer Test 12-02 (from Reimus, 2012).	38
Figure 3-33. Layout of Äspö HRL and location of main experiments.....	40
Figure 3-34. Schematic stages of the BRIE Experiment at Äspö HRL (Bockgård et al., 2012).....	42
Figure 3-35. BRIE Experiment at Äspö HRL: The test niche and five boreholes (distance 1.5 m) used for initial characterization and selection of BRIE site (SKB, 2011b)	42
Figure 3-36. Schematic setup of LTDE-SD at Äspö HRL (SKB, 2011a).....	43
Figure 3-37. Schematic layout of Prototype Repository at Äspö HRL (SKB, 2011a, 2011b).....	44
Figure 3-38. Prototype Repository at Äspö HRL: Photo of excavated deposition hole.....	45
Figure 3-39. LASGIT Experiment at Äspö HRL (from Cuss, 2010).....	46
Figure 4-1. Layout of the HADES URL in Mol, Belgium (from Li, 2011).....	50
Figure 4-2. Layout of the PRACLAY <i>In Situ</i> Experiment at HADES URL (from Li, 2011).....	50

Figure 4-3. PRACLAY <i>In Situ</i> Experiment at HADES URL: Configuration of boreholes for pressure, stress, displacement, and water chemistry measurements (from Li, 2011).....	51
Figure 4-4. PRACLAY <i>In Situ</i> Experiment at HADES URL: Photo on left shows hydraulic seal from the outside, with an access hole to the right which soon will be closed. Photo on right was taken from access hole into the heater gallery section, which is currently being backfilled.	51
Figure 4-5. Schematic of CP1 Diffusion Experiment at HADES URL (from Maes et al., 2011)	52
Figure 4-6. 3D view of layout of the Grimsel Test Site in Switzerland (NAGRA, 2010).....	53
Figure 4-7. Schematic cross section of the FEBEX Test at Grimsel Test Site (based on Birkholzer et al., 2012).	54
Figure 4-8. FEBEX Test at Grimsel Test Site: Photos taken during the construction phase of the FEBEX test.	54
Figure 4-9. GAST Experiment at Grimsel Test Site: Schematic picture of repository seal design with 8-10 m long sand/bentonite plug in between two gravel packs and a concrete plug for reinforcement (from http://www.grimsel.com/gts-phase-vi/gast/gast-introduction).	55
Figure 4-10. Layout of the KURT URL in Daejeon, Korea (KAERI, 2011).....	56
Figure 4-11. Layout of the Mizunami Underground Research Laboratory in Japan, and photo of tunnel shaft construction (from http://www.jaea.go.jp/04/tono/miu_e/)	57
Figure 4-12. View of one of the underground tunnels at Gorleben site at the 840 m level (from BMWi, 2008).....	58
Figure 4-13. Layout of the Onkalo URL in Finland (from Äikäs, 2011).....	59
Figure 4-14. Layout of the LSMHM URL at Bure, France (from Lebon, 2011).....	59
Figure 5-1. TOUGH-FLAC numerical grids used in design simulations for FE Heater Test at Mont Terri URL (from Liu et al., 2012).	68
Figure 5-2. Layout of the heater borehole of the HE-D Heater Test at Mont Terri URL (from Garitte and Gens, 2012).	70
Figure 5-3. Displacement variation (magnitude) at points around the ED-B Tunnel at Mont Terri (from Liu et al., 2012).	71
Figure 5-4. Failure type in the EDZ surrounding the ED-B Tunnel at Mont Terri simulated by TPHM (tension failure marked by RED color and shear failure marked by BLUE color) (from Liu et al., 2012).	71
Figure 5-5. Conceptual model of the EDZ in the tunnel walls at Mont Terri URL induced by stress redistribution after excavation (from Bossart et al., 2004).	72
Figure 5-6. Example simulations with RBSN method and discrete fracture network tool. Evolution of shrinkage cracking in a plan view of a 3D claystone slab: (a) initial configuration; (b) early stage; (c) intermediate stage; and (d) late stage (from Liu et al., 2012). At the late stage, when the fracture developments are stabilized, some of the fractures tend to seal and larger patches are eventually formed. The arrows in the figure indicate the location of the sealing behavior that occurred.	73
Figure 5-7. Colloid-Facilitated Radionuclide Tracer Test at Grimsel Test Site: Numerical model matches to the ¹³⁷ Cs and colloid breakthrough curves (Reimus, 2012).....	75

TABLES

Table 2-1. Summary of SNF and HLW Management Programs in Other Countries.....	2
Table 3-1. Modeling Test Cases for DECOVALEX-2015 (from Jing and Hudson, 2011)	8
Table 3-2. Participation of International Programs in Cooperative Initiatives Related to URLs: Status 2012	48
Table 5-1. Participation of International Programs in Cooperative Initiatives Related to URLs: Status 2012. The FEP ranking is based on Tables 7 and 8 in Nutt (2011). Table entries are sorted by URL.....	61
Table 5-2. Current or Planned Work Package Activities with International Collaboration and Focus on URL Experiments (sorted by URL)	67
Table 5-3. Summary of FY12 Work Packages Activities with International Collaboration and Focus on URL Experiments.....	77

ACRONYMS

ANDRA	National Radioactive Waste Management Agency, France
ANL	Argonne National Laboratory, USA
BGR	Federal Inst. for Geosciences & Natural Resources, Germany
BMT	Benchmark Test
BMWi	Bundesministerium für Wirtschaft und Arbeit, Germany
CAS	Chinese Academy of Sciences, China
CFM	Colloid Formation and Migration Project
CRR	Colloid and Radionuclide Retardation Project
CIEMAT	Centro Investigaciones Energéticas Medioambientales y Tecnológicas, Spain
CRIEPI	Central Research Institute of Electric Power Industry, Japan
DOE	Department of Energy, USA
EBS	Engineered Barrier System
EDRAM	International Association for Environmentally Safe Disposal of Radioactive Waste
EDZ	Excavation Damage Zone (or Excavation Disturbed Zone)
ENRESA	National Radioactive Waste Corporation, Spain
ENSI	Swiss Federal Nuclear Safety Inspectorate, Switzerland
FEPs	Features, events, and processes
FZK	Forschungszentrum Karlsruhe, Germany
GRS	Gesellschaft für Anlagen- und Reaktorsicherheit mbH, Germany
GTS	Grimsel Test Site, Switzerland
GWFTS	Groundwater Flow and Transport Task Force, Sweden
HLW	High-Level Waste
HMC	Hydro-mechanical-chemical
IAEA	International Atomic Energy Agency
IC	Imperial College of London, UK
IRSN	Institut de Radioprotection et de Sûreté Nucléaire, France
JAEA	Japan Atomic Energy Agency, Japan
JFCS	U.S.–Korea Joint Fuel Cycle Studies
JNEAP	U.S.–Japan Nuclear Energy Action Plan
KAERI	Korea Atomic Energy Research Institute, Republic of Korea
KTH	Royal Institute of Technology, Sweden

LANL	Los Alamos National Laboratory, USA
LBNL	Lawrence Berkeley National Laboratory, USA
NAGRA	National Cooperative for the Disposal of Radioactive Waste, Switzerland
NBS	Natural Barrier System
NE	DOE Office of Nuclear Energy, USA
NEA	Nuclear Energy Agency
NDA	Nuclear Decommissioning Authority, UK
NRC	Nuclear Regulatory Commission, USA
NWMO	Nuclear Waste Management Organization, Canada
OECD	Organization for Economic Co-operation and Development
PA	Performance Assessment
PEBS	Long-term Performance of the Engineered Barrier System, European Union
PSI	Paul Scherrer Institute, Switzerland
PUNT	U.S.–China Peaceful Uses of Nuclear Energy
RAWRA	Radioactive Waste Repository Authority, Czech Republic
SA	Safety Assessment
SCK-CEN	Belgian Nuclear Research Centre, Belgium
SKB	Swedish Nuclear Fuel and Waste Management, Sweden
SNF	Spent Nuclear Fuel
SNL	Sandia National Laboratories, USA
SNU	Seoul National University, Korea
Swisstopo	Federal Office of Topography, Switzerland
TC	Test Case
THC	Thermo-hydro-chemical
THM	Thermo-hydro-mechanical
THMC	Thermo-hydro-mechanical-chemical
UFD	DOE Office of Used Fuel Disposition Research and Development, USA
UFDC	Used Fuel Disposition Campaign, USA
URL	Underground Research Laboratory

1. INTRODUCTION

While the United States research program for geologic disposal of high-level radioactive waste over the past decades focused solely on an open tunnel emplacement in unsaturated densely fractured tuff, several international organizations have made significant progress in the characterization and performance evaluation of other disposal design options and host rock characteristics, most of which were very different from those studied in the U.S. As a result, areas of direct collaboration between the U.S. Department of Energy's (DOE) and international geologic disposal programs were quite limited during that time.

Recently, the decision by DOE to no longer pursue the geologic disposal of high-level radioactive waste and spent fuel at the Yucca Mountain site has shifted the nation's focus to disposal design options and geologic environments similar to those being investigated by other nations. DOE started to recognize that close international collaboration is a beneficial and cost-effective strategy for advancing disposal science and, in FY12, embarked on a comprehensive effort to identify international collaboration opportunities, to interact with international organizations and advance promising collaborations, and to plan/develop specific R&D activities in cooperation with international partners. This report describes the active collaboration opportunities available to U.S. researchers as a result of this effort, and presents specific cooperative research activities that have been recently initiated within DOE's disposal research program. The focus in this report is on those opportunities that provide access to field data (and respective interpretation/modeling), and/or may allow participation in ongoing and planned field experiments.

2. INTERNATIONAL OPPORTUNITIES AND STRATEGIC CONSIDERATIONS

Recognizing the benefits of international collaboration in the common goal of safely and efficiently managing the back end of the nuclear fuel cycle, DOE's Office of Nuclear Energy (NE) and its Office of Used Fuel Disposition Research and Development (UFD) have developed a strategic plan to advance cooperation with international partners (UFD 2012). Internationally, geologic disposal programs are at different maturation states, ranging from essentially "no progress" in some countries, to selected sites and pending license applications in others. Table 2-1 summarizes the status of spent nuclear fuel (SNF) and high-level waste (HLW) management programs in several countries. The opportunity exists to collaborate at different levels, ranging from providing expertise to those countries "behind" the U.S. to sharing information and expertise with those countries that have mature programs (*Used Fuel Disposition Campaign International Activities Implementation Plan, FCRD-USED-2011-000016 REV 0, November 2010* [Nutt, 2010]). Working with other countries optimizes limited resources by integrating knowledge developed by researchers across the globe (UFD, 2012).

Table 2-1. Summary of SNF and HLW Management Programs in Other Countries

Country	Material to be Disposed	Centralized Storage	Geologic Environments	URL	Site-Selection	Anticipated Start of Repository Operations
Finland	SNF		Granite, Gneiss, Grandiorite, Migmatite	ONKALO (Granite)	Site at Olkiluoto Selected	2020
Sweden	SNF	CLAB - Oskarshamn	Granite	Aspo (Granite)	Site at Osthhammar Selected	2023
France	HLW and ILW		Argillite and Granite	Bure (Argillite)	Site near Bure Selected	2025
Belgium	HLW		Clay/Shale	Mol (clay)	Not Initiated	~2040
China	HLW		Granite		Preliminary Investigations Underway - Beishan in Gobi Desert	~2050
Switzerland	HLW	Wulenlingen (ZWILAG)	Clay and Granite	Mont Terri (Clay) Grimsel (Clay)	Initiated	No sooner than 2040
Japan	HLW		Granite and Sedimentary	Mizunami (Granite) Hornonobe (Sedimentary)	Initiated	No Decision Made
Canada	SNF		Granite and Sedimentary	Pinawa (Granite) - being decommissioned	Initiated	No Decision Made
United Kingdom	HLW and ILW		Undecided		Initiated	No Decision Made
Germany	HLW, SNF, heat generating ILW	Gorleben and Ahaus	Salt	Gorleben (Salt)	On Hold	No Decision Made
Republic of Korea	SNF	Envisioned	Granite	Korea Underground Research Tunnel (Granite, Shallow)	Not Initiated	No Decision Made
Spain	No Decision Made	Siting Process Initiated	Granite, Clay, Salt		Not Initiated	No Decision Made

Source: Nuclear Waste Technical Review Board, 2009. Survey of National Programs for Managing High-Level Radioactive Waste and Spent Nuclear Fuel

UFD’s strategic plan lays out two interdependent areas of international collaboration (UFD 2012). The first area is cooperation with the international nuclear community through participation in international organizations, working groups, committees, and expert panels. Such participation typically involves conference and workshop visits, information exchanges, reviews, and training and education. Recent or ongoing NE work in this area has been summarized in *Used Fuel Disposition Campaign International Activities Implementation Plan (FCRD-USED-2011-000016 REV 0, November 2010* [Nutt, 2010]). Examples include multinational activities, such as under IAEA (e.g., review activities, conference participation, and education), OECD/NEA (e.g., participation in annual meetings, Integration Group for the Safety Case membership, NEA Thermochemical Database, NEA’s Clay Club, NEA’s Salt Club), and EDAM (International Association for Environmentally Safe Disposal of Radioactive Waste). NE also actively supports bilateral agreements such as PUNT (U.S.–China Peaceful Uses of Nuclear Energy), JNEAP (U.S.–Japan Nuclear Energy Action Plan), and the U.S.–Germany Memorandum of Understanding for Cooperation in the Field of Geologic Disposal of Radioactive Wastes. UFD will continue participation in and/or support of ongoing international collaborations in this first area, will assess their benefits, and will identify the need for expanding or extending their scope. New activities and agreements may be developed with an eye towards the objectives and R&D needs of the United States (UFD, 2012).

The second area of international collaboration laid out in the strategic plan involves active R&D participation of U.S. researchers within international projects or programs (UFD, 2012). The established cooperative mechanisms discussed above provide vehicles for the UFD to manage or sponsor active R&D collaboration. By active R&D, it is meant here that U.S. researchers work closely together with international scientists on specific R&D projects relevant to both sides. With respect to geologic disposal of radioactive waste, such active collaboration provides direct access to information, data, and expertise on various disposal options and geologic environments that have been collected internationally over the past decades. Many international programs have

operating underground research laboratories (URLs) in clay/shale, granite, and salt environments, in which relevant field experiments have been and are being conducted. Depending on the type of collaboration, U.S. researchers can participate in planning, conducting, and interpreting experiments in these URLs, and thereby get early access to field studies without having *in situ* research facilities in the United States.

UFD considers this second area, active international R&D, to be very beneficial to the program, i.e., helping to efficiently achieve the program's long-term goals of conducting "experiments to fill data needs and confirm advanced modeling approaches" (by 2015) and of having a "robust modeling and experimental basis for evaluation of multiple disposal system options" (by 2020). Advancing opportunities for active international collaboration with respect to geologic disposal has therefore been the primary focus of UFD's international activities in FY12. An effort was made to collect information on international opportunities that complement ongoing disposal R&D within the UFD, help identify those activities that provide the greatest potential for substantive technical advances, interact with international organizations and programs to help advance specific collaborations, and to initiate specific R&D activities in cooperation with international partners. This report describes the active collaboration opportunities available to U.S. researchers today and presents the current status of specific cooperative research activities within the UFD. The focus is on such opportunities that provide access to field data (and respective interpretation/modeling) and/or may allow participation in ongoing and planned URL field experiments.

Active collaboration can be achieved under different working models. One option stems from informal peer-to-peer interaction with international R&D organizations. Several U.S. scientists involved in the Used Fuel Disposition Campaign (UFDC), most of which are associated with DOE's national laboratories, have close relationships with their international counterparts, resulting from workshops and symposia meetings, or from active R&D collaboration outside of UFD. Continued UFD support for participation of U.S. researchers in relevant international workshops, meetings, and symposia will help to foster discussion and expand such relationships.

Other working models for active collaboration require that DOE becomes a formal member in international initiatives before R&D collaboration can take place. Following a discussion of several international collaboration opportunities and recommendations made in Birkholzer (2011), DOE has recently joined three international cooperation initiatives as a formal partner, the DECOVALEX Project, the Mont Terri Project, and the Colloid Formation and Migration Project. Section 3 of this report gives a comprehensive overview of these initiatives and describes the various opportunities arising from DOE's membership, with focus on those providing access to international URL field experiments. Outside of the above initiatives, UFD scientists can also collaborate with individual international disposal programs, which may or may not require formal bilateral agreements. Section 4 presents international disposal programs that are open to bilateral collaboration with U.S. researchers, without requiring membership fees or other long-term commitments on behalf of DOE.

The benefit of international collaboration needs to be evaluated in the context of the open R&D issues that can be addressed through collaborative scientific activities. Open R&D issues with respect to NBS behavior are summarized in UFD reports (e.g., *Natural System Evaluation and*

Tool Development – FY10 Progress Report, August 2010 [Wang, 2010]); specific R&D issues related to clay/shale host rock are discussed, for example, in Tsang et al. (2011). EBS-related R&D items have also been considered in previous progress reports (e.g., Jove-Colon et al., 2010). All R&D gaps identified in these reports have been evaluated in consideration of their importance to the safety case in a recently conducted roadmap exercise (*Used Fuel Disposition Campaign Disposal Research and Development Roadmap, FCRD-USED-2011-000065 Rev 0, March 2011; Tables 7 and 8;* [Nutt, 2011]). The ranking of features, events, and processes (FEPs) in this roadmap report founded the basis for identifying the most relevant and promising international opportunities. Section 5.1 describes the planning exercise conducted by UFD which led to the selection of a set of R&D activities that align with current goals, priorities, and funded plans of UFD. The current status of these activities is described in Section 5.2.

Given the focus of this report on geologic disposal research and international collaboration opportunities linked to underground research laboratories, most of the R&D activities described below align with the objectives of the NBS and the EBS work packages of UFD. As for the NBS, the report is heavy on clay/shale and crystalline rock collaboration opportunities. (There is only one URL in salt host rock outside of the U.S., near Gorleben in Germany. Due to political resistance, research activities at Gorleben had been suspended for about a decade; the research program on salt has just recently been restarted in Germany.) As for the EBS, the report looks mainly into buffer/backfill and seal behavior, and the interaction of these materials with other EBS components and the surrounding host rock.

3. COOPERATIVE INITIATIVES

This section gives a comprehensive overview of three international cooperation initiatives, the DECOVALEX Project, the Mont Terri Project, and the Colloid Formation and Migration Project. These are international initiatives that DOE has recently joined as a formal partner. A description of SKB Task Forces is also included, though DOE has not decided yet whether it would seek official membership. As mentioned before, the focus is on initiatives that foster active research with other international disposal programs, provide access to field data (and respective interpretation/modeling), and/or may allow participation in ongoing and planned field experiments.

3.1 DECOVALEX Project

3.1.1 Introduction to the DECOVALEX Project

The DECOVALEX Project is an international research collaboration for advancing the understanding and mathematical modeling of coupled thermo-hydro-mechanical (THM) and thermo-hydro-chemical (THC) processes in geological systems. DECOVALEX is an acronym for “Development of Coupled Models and their Validation against Experiments.” Starting in 1992, the project has made important progress and played a key role in the development of numerical modeling of coupled processes in fractured rocks and buffer/backfill materials. The project has been conducted by research teams supported by a large number of radioactive-waste-management organizations and regulatory authorities, including those of Canada, China, Finland, France, Japan, Germany, Spain, Sweden, UK, South Korea, Czech Republic, and the USA.

Through this project, in-depth knowledge has been gained of coupled thermo-hydro-mechanical (THM) and thermo-hydro-chemical (THC) processes associated with geologic repositories for high-level radioactive waste, as well as numerical simulation models for their quantitative analysis. The knowledge accumulated from this project, in the form of a large number of research reports and international journal and conference papers in the open literature, has been applied effectively in the implementation and review of national radioactive-waste-management programs in the participating countries. A good overview of the project is given in Tsang et al. (2009).

The DECOVALEX Project has been typically conducted in separate 3-4 year project phases. Each phase features a small number (typically three to six) modeling tasks of importance to radioactive waste disposal. Modeling tasks can either be Test Cases (TC) or Benchmark Tests (BMT). TCs are laboratory and field experiments that have been conducted by one of the project partners and are then collectively studied and modeled by DECOVALEX participants. BMTs involve less complex modeling problems, often targeted at comparing specific solution methods or developing new constitutive relationships. Numerical modeling of TCs and BMTs, followed by comparative assessment of model results between international modeling teams, can assist both to interpret the test results and to test the models used. While code verification and benchmarking efforts have been undertaken elsewhere to test simulation codes, the model comparison conducted within the DECOVALEX framework is different because (a) the modeling tasks are often actual laboratory and field experiments, and (b) DECOVALEX engages model comparison in a broad and comprehensive sense, including the modelers' choice of interpretation of experimental data, boundary conditions, rock and fluid properties, etc., in addition to their choice of simulators. Over the years, a number of large-scale, multiyear field experiments have been studied within the project (e.g., the Kamaishi THM Experiment, FEBEX, and the Yucca Mountain drift-scale heater test). Thus, the project provides access to valuable technical data and expertise to DECOVALEX partner organizations; this is particularly useful in disposal programs that are starting their research on certain disposal or repository environments and have no URLs. DECOVALEX has a modeling focus, but with a tight connection to experimental data.

To participate in a given DECOVALEX phase, interested parties—such as waste management organizations or regulatory authorities—need to formally join the project and pay an annual fee that covers the cost of administrative and technical matters. In addition to this fee, participating (funding) organizations provide funding to their own research teams to work on some or all of the problems defined in the project phase. Representatives from the funding organizations form a Steering Committee that collectively directs all project activities.

DOE was a DECOVALEX funding organization for several project phases, but decided to drop out in 2007 with the increasing focus on the license application for Yucca Mountain. When the U.S. R&D program shifted to other disposal options and geologic environments, a renewed DOE engagement with DECOVALEX was suggested in 2011 (Birkholzer, 2011) as a logical step for advancing collaborative research with international scientists. DOE leadership realized that a renewed DECOVALEX participation would provide UFDC researchers access to relevant field data from international programs and would allow them to work collaboratively with international scientists on analyzing and modeling these data. To evaluate the benefits of joining the upcoming DECOVALEX phase for the years 2012 through 2015, referred to as

DECOVALEX–2015, UFDC representatives participated in planning workshops held in Helsinki (April 2011) and Oskarshamn (November 2011). It turned out that the modeling test cases and experimental data sets proposed for DECOVALEX-2015 were highly relevant to UFDC’s R&D objectives, and a decision was made in early 2012 that DOE would formally join the DECOVALEX-2015 project as a funding organization. In April 2012, the kick-off workshop for DECOVALEX-2015 was hosted by DOE and held at Lawrence Berkeley National Laboratory in Berkeley, California.

3.1.2 Overview of Modeling Tasks for DECOVALEX-2015

Three main modeling tasks were defined for DECOVALEX-2015, all of which involve experimental data from experiments conducted in URLs (Table 3-1):

- **Task A:**
SEALEX Experiment: A long-term test of the hydraulic (sealing) performance of a swelling bentonite core (5 m long) in a mini tunnel (60 cm diameter) at the Tournemire URL in France, organized by IRSN (France)

- **Task B:**
B1) HE-E Heater Test: Studies of bentonite/rock interaction to evaluate sealing and clay barrier performance, in a micro-tunnel at the Mont Terri URL, organized by PEBS (European Union project); and
B2) EBS Experiment: Studies of the thermo-hydro-mechanical-chemical (THMC) behavior of the EBS under heating conditions in both the early resaturation and post-closure stage of the repository and its interaction with the clay host rock, in a vertical emplacement hole at the Horonobe URL organized by JAEA (Japan)

- **Task C:**
C1) THMC Modeling of Rock Fractures: Modeling of laboratory experiments on THMC impacts on fracture flow, organized by Imperial College (Great Britain); and
C2) Bedrichov Tunnel Experiment: Interpretation of inflow patterns and tracer transport behavior in fractured granite, organized by NAWRA (Czech Republic)

Of the three main modeling tasks, or five sub-tasks, Tasks A, B1, and B2 are mostly relevant to the EBS work package of UFDC; both target the behavior of clay-based backfill and sealing materials in interaction with clay host rock, at ambient (Task A) and heated conditions (Task B1 and B2). Task C1 and C2, the Rock Fracture THMC Study and the Bedrichov Tunnel Experiment, are mostly relevant to the NBS work package of UFDC. Details on Tasks A, B1, B2, C1, and C2 are given in Sections 3.1.3 through 3.1.7 below.

The current funding organizations for DECOVALEX-2015 are:

BGR	Federal Inst. for Geosciences & Natural Resources	Germany
CAS	Chinese Academy of Sciences	China
DOE	Department of Energy	United States
ENSI	Swiss Federal Nuclear Safety Inspectorate	Switzerland
IRSN	Inst. for Radiological Protection & Nuclear Safety	France
JAEA	Japan Atomic Energy Agency	Japan

KAERI	Korean Atomic Energy Research Institute:	Korea
NDA	Nuclear Decommissioning Authority	Great Britain
NRC	Nuclear Regulatory Commission	United States
RAWRA	Radioactive Waste Repository Authority	Czech Republic

These organizations intend to participate in the three modeling tasks as follows:

- Task A: IRSN, NDA, NAWRA
- Task B: BGR, CAS, DOE, ENSI, JAEA, KAERI, NRC
- Task C: CAS, DOE, NDA, possibly NRC, RAWRA

This means that each modeling task is being investigated by four or more modeling groups, which ensures in-depth collaboration and model comparison between several international research teams. More details on each task are provided in the following sub-sections.

3.1.3 Task A: SEALEX Experiment at the Tournemire URL, France (Focus: EBS)

The SEALEX experiment aims at investigating the long-term HM behavior and hydraulic performance of swelling clay-based seals (Figure 3-1). A suite of experiments is being conducted in several 60 cm diameter mini-tunnels (5 m long) (Figures 3-2 and 3-3) that are exposed to nominal conditions, different technological choices for seal mixtures and emplacement, and altered situations (e.g., forced resaturation or not; loss of mechanical confinement or not) (Figure 3-4). Forced resaturation can lead to heterogeneous saturation and porosity/permeability fields within the bentonite core, and hence the possibility of clay-core erosion due to flow channeling. The experiments will test these hydraulic parameters and their spatial distribution via state-of-the-art measurement technology (e.g., wireless sensors installed within the core to limit preferential flow along cables). Hydraulic tests (pulse tests and constant load tests) will eventually be conducted to determine the overall hydraulic properties (permeability, leaks) of the seals, for different representative conditions. While not decided yet, IRSN considers adding one particular test to the experimental plan that would evaluate HMC behavior with concrete/steel and concrete/bentonite interaction.

The SEALEX experiments are conducted at the Tournemire URL in the south of France. This site is characterized by a subhorizontal indurated argillaceous claystone layer 250 m thick. A railway tunnel, constructed in 1881 through the argillaceous formation, is 2 km long, 6 m high, and 4.7 m wide, and was excavated using a pneumatic tool. In 1996 and 2003, additional research tunnels were excavated off the main railway tunnel. Thus, this facility allows study of near-field rock behavior in indurated clay with different time periods of exposure to the atmosphere, namely 130, 15, and 8 years, respectively (Rejeb and Cabrera, 2006) (Figure 3-5).

Table 3-1. Modeling Test Cases for DECOVALEX-2015 (from Jing and Hudson, 2011)

	Task A	Task B		Task C	
Task No.		Task B1	Task B2	Task C1	Task C2
Task Title	Sealex	HE-E Heater Test	EBS experiment	THMC Fracture	Bedrichov Tunnel
Proponent	IRSN	PEBS	JAEA	IC	RAWRA
Main topic	EBS & EBS-rock interaction	EBS & EBS-rock interaction	EBS & EBS-rock interaction	NBS, Fundamental study on flow & transport	NBS, Flow & transport in fractured crystalline rocks
Relevance to repository development	Excavation, sealing & post-closure	Sealing & post-closure	Excavation, sealing & post-closure	Site characterization through to safety assessment	Site characterization and safety assessment
Processes	HMC	THM	THMC	THMC	HMC
Test time	2011–2015+	2011–2015 and beyond	2014–2015+	Data obtained, published data & literature support	Basic characterization completed, tracer tests planned
Host rock	Clay	Clay	Sedimentary rock	Granite and other hard rocks	Granite
Test site	Tournemire, France	Mont Terri, Switzerland	Horonobe, Japan	Laboratory tests	Czech Republic
Relevance to other rock types	Argillaceous but applies to all types of host rocks using EBS	Argillaceous but applies to all types of host rocks using EBS	Sedimentary but applies to all types of host rocks using EBS	Applies to all types of host rocks	Specific to crystalline but principles can be applied to other rocks
BMT or TC	TC	TC	TC	BMT	BMT/TC
Impact on PA/SA	Important for EBS, PA & total system SA	Important for EBS PA & total system SA	Important for EBS PA & total system SA	Important for scientific basis of radioactive waste disposal	Important for site characterization and total system SA
Special features	Intimate interaction with D-2015 for modeling and testing	Intimate interaction with PEBS project for follow-up of the test	Intimate interaction with D-2015 for modeling and testing	Published data & literature support	Intimate interaction with D-2015 for tracer test design
Group leader	IRSN	PEBS	JAEA	IC	RAWRA

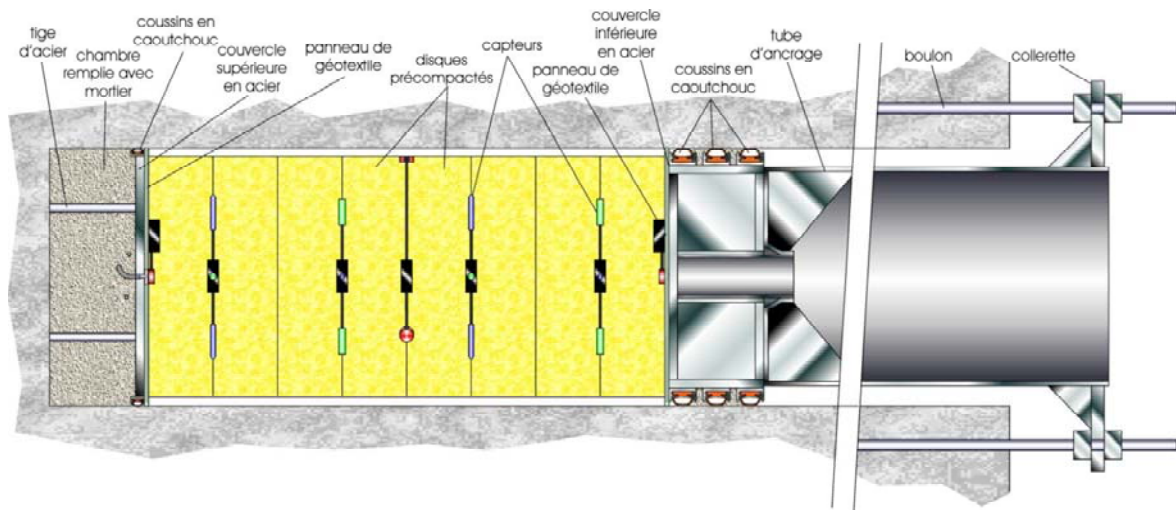

Figure 3-1. SEALEX Experiment at the Tournemire URL: Schematic setup of mini-tunnel with seal core and instrumentation (from Barnichon and Millard, 2012)

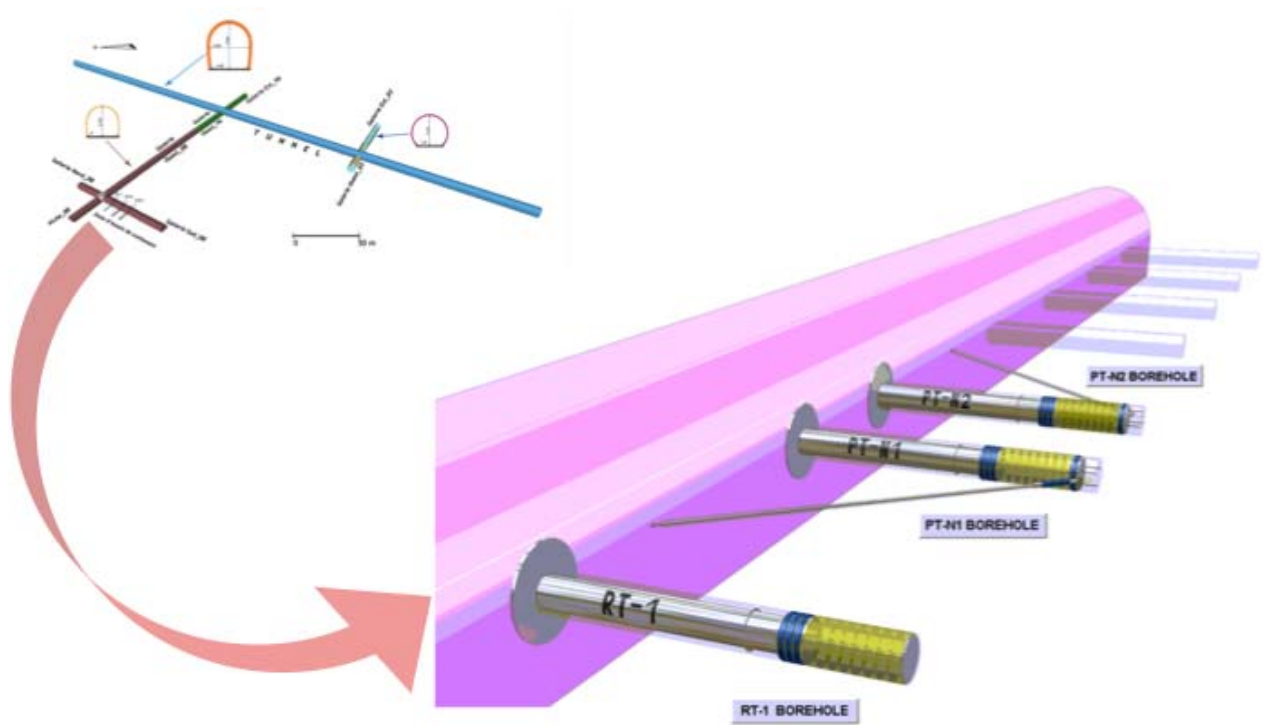

Figure 3-2. SEALEX Experiment at the Tournemire URL: Layout of mini-tunnels and main gallery (from Barnichon and Millard, 2012)



Figure 3-3. SEALEX Experiment at the Tournemire URL: View of mini-tunnel from gallery after core emplacement (from Barnichon, 2011)

	Reference Tests	Performance Tests	Intra-core geometry Core conditioning Composition (MX80/sand)	Core view	Altered conditions	Emplacement date
Base case	RT-1	PT-N1	Monolithic disks Precompacted (70/30)		No	12/2010 06/2011
Variations / Base case	-	PT-A1	Monolithic disks Precompacted (70/30)		Confinement loss	06/2012
	-	PT-N2	Disks + internal joints (4/4) Precompacted (70/30)		No	12/2011
	RT-2	PT-N3	Pellets/powder In situ compacted (100/0)		No	12/2012 06/2013
	-	PT-N4	Monolithic disks Precompacted (20/80)		No	12/2013

Figure 3-4. SEALEX Experiment at the Tournemire URL: Planned experiments and schedule (from Barnichon, 2011)

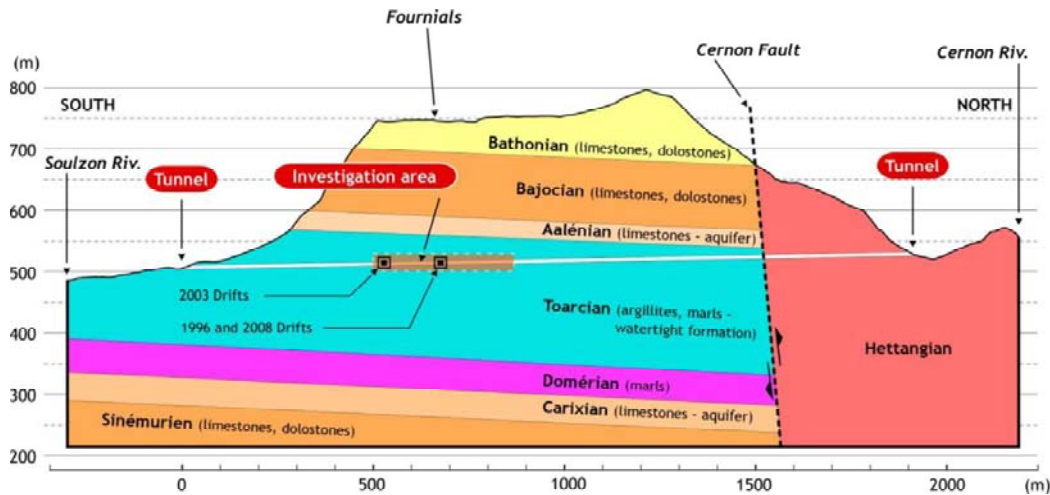

Figure 3-5. Geological cross section of the Tournemire URL (from Barnichon, 2011)

The main objectives of the Sealex *in situ* tests are to evaluate the influence of relevant parameters with respect to the overall hydraulic performance of swelling bentonite cores in the long term for normal situations. The main scientific issues considered are:

- Investigation of the conditions related to the URL site, especially hydraulic and mechanical processes such as evolution of an excavation damage zone (EDZ), hydraulic performance of seals, and processes at bentonite-rock interfaces;
- Investigation of the hydraulic performance of the bentonite-rock interface over the long term, such as forced saturation effects, bentonite core swelling, sealing performance of the bentonite-rock interfaces; and
- Investigation of the generation of gas

The test program is divided into reference tests and performance tests. The reference tests will be performed mainly for quantifying the coupled hydro-mechanical fields inside the bentonite cores, characterized by stress, swelling pressure, pore pressure, and relative humidity, measured by high quality intra-core wireless instrumentation. The performance tests consider mainly hydraulic tests (pulse tests, constant pressure tests) to determine the overall permeability fields and leaking of the bentonite cores, under alternative testing and core representation conditions. A progressive parametric testing approach has been designed to perform the reference and performance tests with alternative bentonite core characteristics, instrument designs, and installation conditions of the cores. For the DECOVALEX-2015 project, the participating research teams perform numerical simulations of the saturation phase of the Sealex *in situ* tests with different testing conditions, and the coupled hydro-mechanical behavior of the bentonite/rock interfaces and intra-core (rock) regions with initial values of void ratios.

3.1.4 Task B1: HE-E Heater Test at Mont Terri URL, Switzerland (Focus: EBS and its interaction with NBS)

The HE-E Heater Test at the Mont Terri URL focuses on the THM behavior of bentonite barriers in the early nonisothermal resaturation stage and the THM interaction with Opalinus Clay (see Section 4 for more information on the Mont Terri URL). Comparison between model results and *in situ* measurements will allow for model validation. The main scientific issues considered are the thermal evolution, buffer resaturation (including *in situ* determination of the thermal conductivity of bentonite and its dependency on saturation), pore-water pressure in the near field, the evolution of swelling pressures in the buffer, and water exchange between the EBS and the surrounding clay rock.

Because the HE-E Heater Test is conducted in a micro-tunnel (at 1:2 scale) (Figures 3-6 and 3-7), it is considered a validation, not a demonstration experiment. The heater test involves two types of bentonite buffer materials, one consisting of bentonite pellets, the other made of a bentonite-sand mixture. A dense instrumentation network that had already been in place in the host rock surrounding the micro-tunnel (from a previous experiment testing the impact of ventilation on the clay host rock) was improved (up to 40 piezometers in total); various sensors were also placed into the buffer material (Figure 3-8). Heating started in the summer of 2011 and will continue for at least three years. The heater-buffer interface is heated to a maximum of 140°C, and a temperature of 60–70°C is expected at the buffer-rock interface (Figure 3-9).

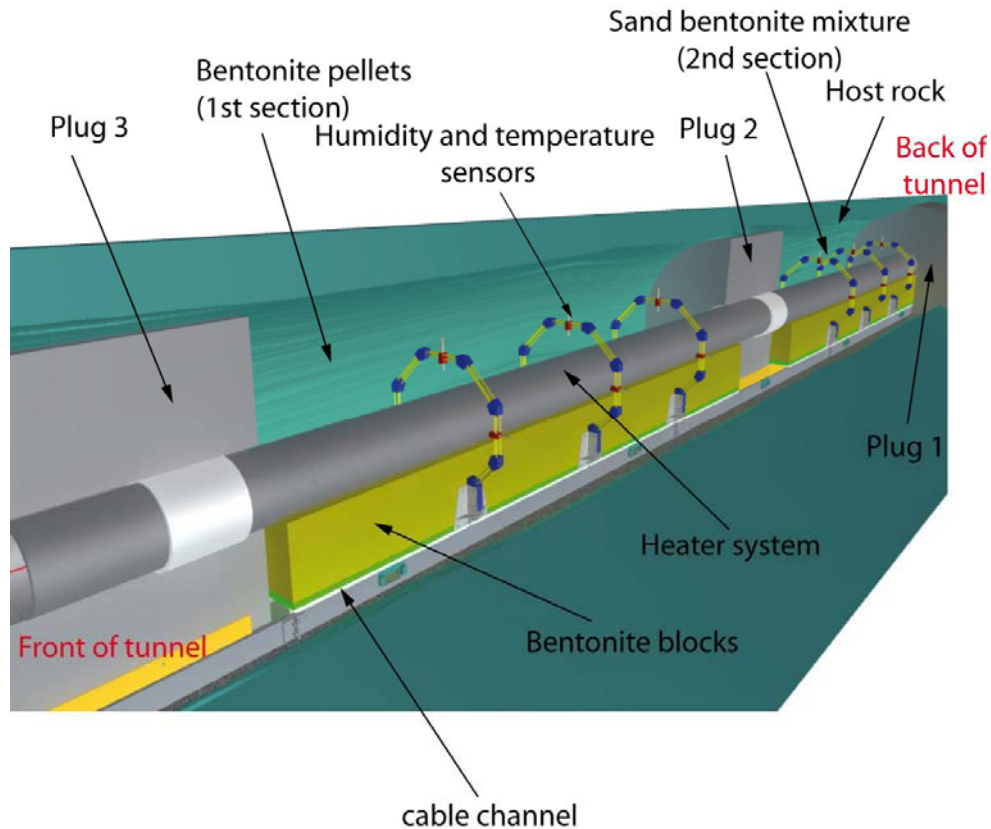

Figure 3-6. Schematic setup of HE-E Heater Test at Mont Terri URL (from Garitte et al., 2011)



Figure 3-7. HE-E Heater Test at Mont Terri URL: Photo of micro-tunnel before buffer emplacement (from Gaus et al., 2012)

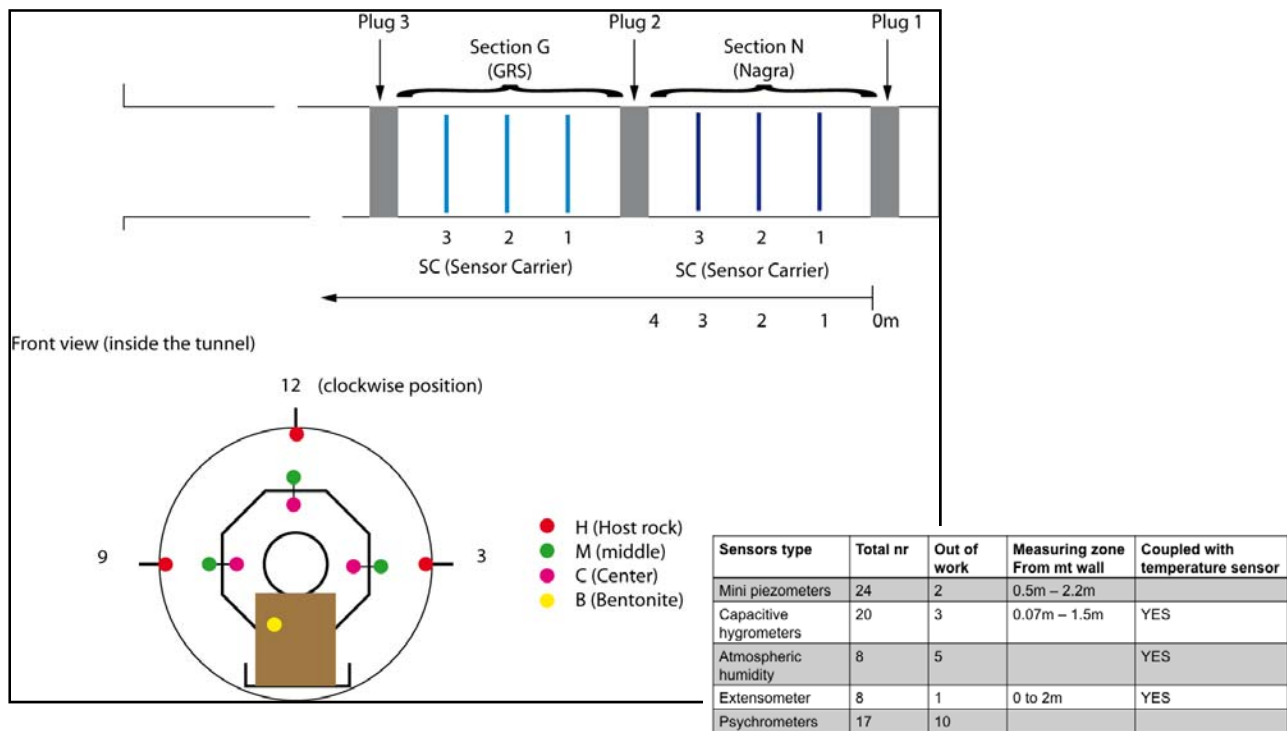

Figure 3-8. HE-E Heater Test at Mont Terri URL: Sensor placement, type, and numbers (from Gaus et al., 2012)

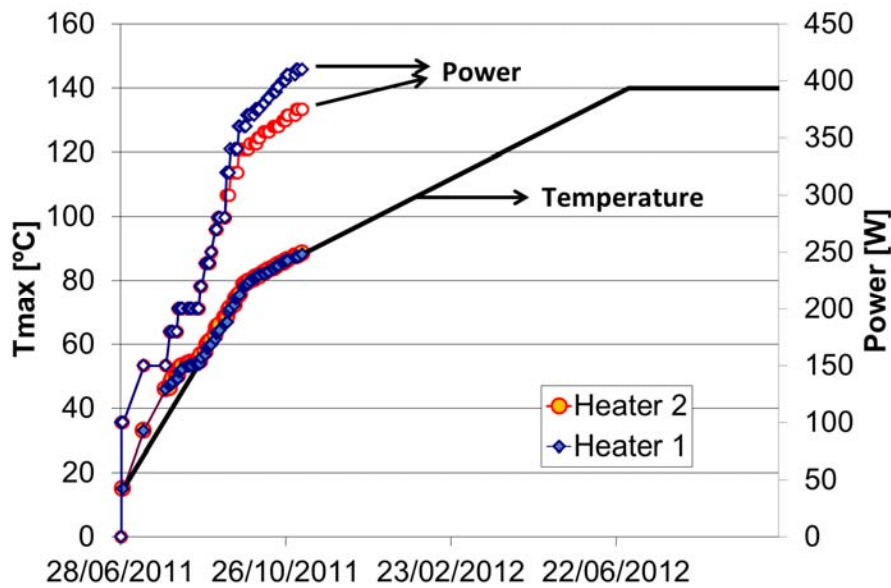

Figure 3-9. HE-E Heater Test at Mont Terri URL: Measured and expected temperature over time at heater-buffer interface (from Gaus et al., 2012)

3.1.5 Task B2: EBS Experiment at Horonobe URL, Japan (Focus: EBS and its interaction with NBS)

The planned EBS Experiment at Horonobe URL investigates the THMC behavior of the EBS under heating conditions in both the early resaturation and post-closure stage of the repository and its interaction with the host rock. Comparison between model results and *in situ* measurements will allow for model validation. The scientific issues include thermal evolution, buffer (bentonite) resaturation processes, backfill effects, pore water pressure evolution in the near-field, swelling pressure evolution of the bentonite, water input from rock to EBS (involving characterization of rock saturation surrounding the EBS), and possible chemical issues, with model development and validation, and confidence building as one of the major objectives.

The schedule of the experimental work, with a planned heating start not before 2014, makes it possible for modeling teams associated with Task B to start with the HE-E Heater Test (Task B1) before focusing on the EBS Experiment (Task B2). Also, a blind prediction and validation approach can be adopted—so that the predicted THMC behavior of the EBS system can be compared in real time with measured data, and therefore provide support and suggestions for improved design and execution of data acquisition and analysis.

The EBS Experiment will be carried out at a depth of 350 m in sedimentary rock in the Horonobe URL (Figure 3-10). An experimental drift will be backfilled with bentonite material after the installation of the EBS into a test hole is complete (Figure 3-11). The experimental area will then be isolated by a mechanical plug. Specifics of the monitoring data and the detailed layout of sensors are still under discussion.

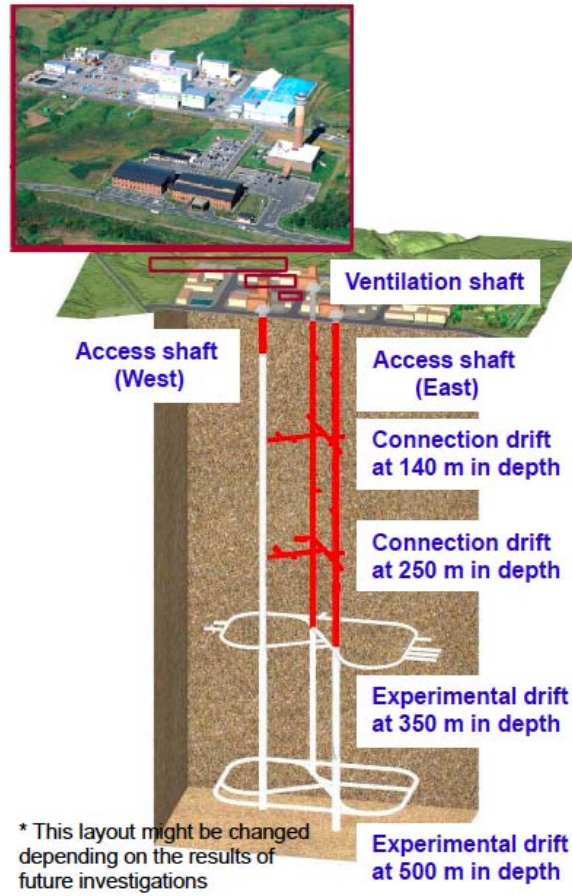

Figure 3-10. Planned design of Horonobe URL (from Sugita and Nakama, 2012)

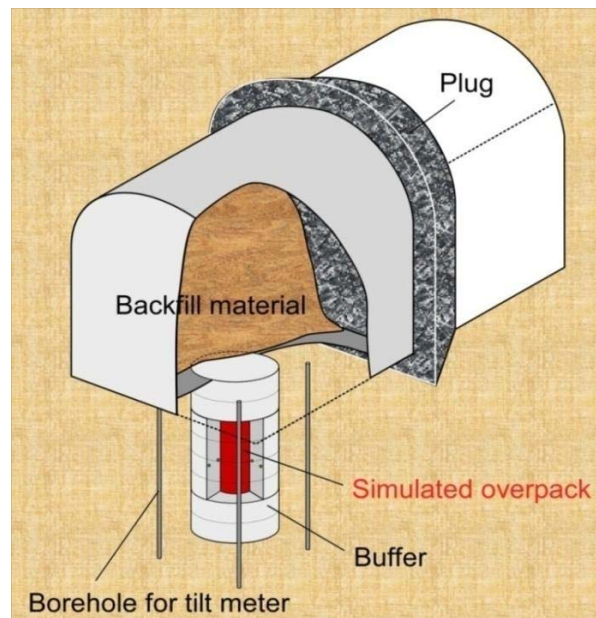

Figure 3-11. Planned design of EBS Experiment at Horonobe URL (from Sugita and Nakama, 2012)

3.1.6 Task C1: THMC Processes in Single Fractures (Focus: NBS)

Many of the proposed sites for nuclear waste repositories are naturally fractured, and the macroscopic permeability is controlled by the transmissivities of the individual fractures. These may be altered by the dissolution and precipitation of minerals, a process strongly influenced by temperature, and by the stresses acting within the asperities at which the fracture faces are in contact. This process constitutes a truly thermo-hydro-mechanical-chemical (THMC) coupled system.

Task C1 uses data from single-fracture-flow laboratory experiments to model such THMC processes, in particular looking at the linkage of thermal stresses mediating chemical effects, and conversely of chemical potentials mediating mechanical behavior (e.g., pressure solution), and how any of these processes affects flow behavior. This task requires fully coupled THMC model capabilities, which only recently have become available and still require thorough validation. Early laboratory experiments available to target such THMC behavior have been conducted on single rock fractures in novaculite (a form of microcrystalline or cryptocrystalline quartz) (Figure 3-12) (Polak et al., 2003; Yasuhara et al., 2004; Yasuhara et al., 2006). These experiments involved reactive flow-through compression and shear tests conducted on single natural-fracture specimens under different temperature, stress, and chemical conditions. The experiments were constrained by concurrent monitoring of stress/strain, influent and effluent flows/chemical reactants, and by intermittent nondestructive imaging by x-ray CT. More recently, similar experiments have been conducted on granite and tuff fractures (Yasuhara et al., 2011; Zimmerman, 2012). The data sets from these experiments can be used for validation of THMC models with direct CM coupling between chemical reaction and strain.

Task C1 aims at modeling, in a fully coupled manner the THMC processes in rock fractures based on a subset of the following existing laboratory experiments:

- A single rock fracture experiment in a heated novaculite performed at Penn State University (USA) considering coupled THMC processes;
- A heated *in situ* block experiment considering coupled TM processes;
- A recent lab experiment on time-dependent fracture aperture evolution in a heated granite (Yasuhara et al., 2011); and
- A lab experiment on coupled HMC processes of granite rock fractures conducted at CAS during the most recent DECOVALEX phase.

The main scientific issues considered are:

- Development of the computational codes and numerical models for modeling the coupled THMC processes of single rock fractures;
- Validation, modification, and improvements of the existing mathematical and numerical models and codes to include pressure-solution as a coupled chemical-mechanical mechanism under non-isothermal fluid-flow conditions;
- Defining simple synthetic cases to evaluate model/code discrepancies; and
- Development of fracture-network models under non-isothermal THM conditions.

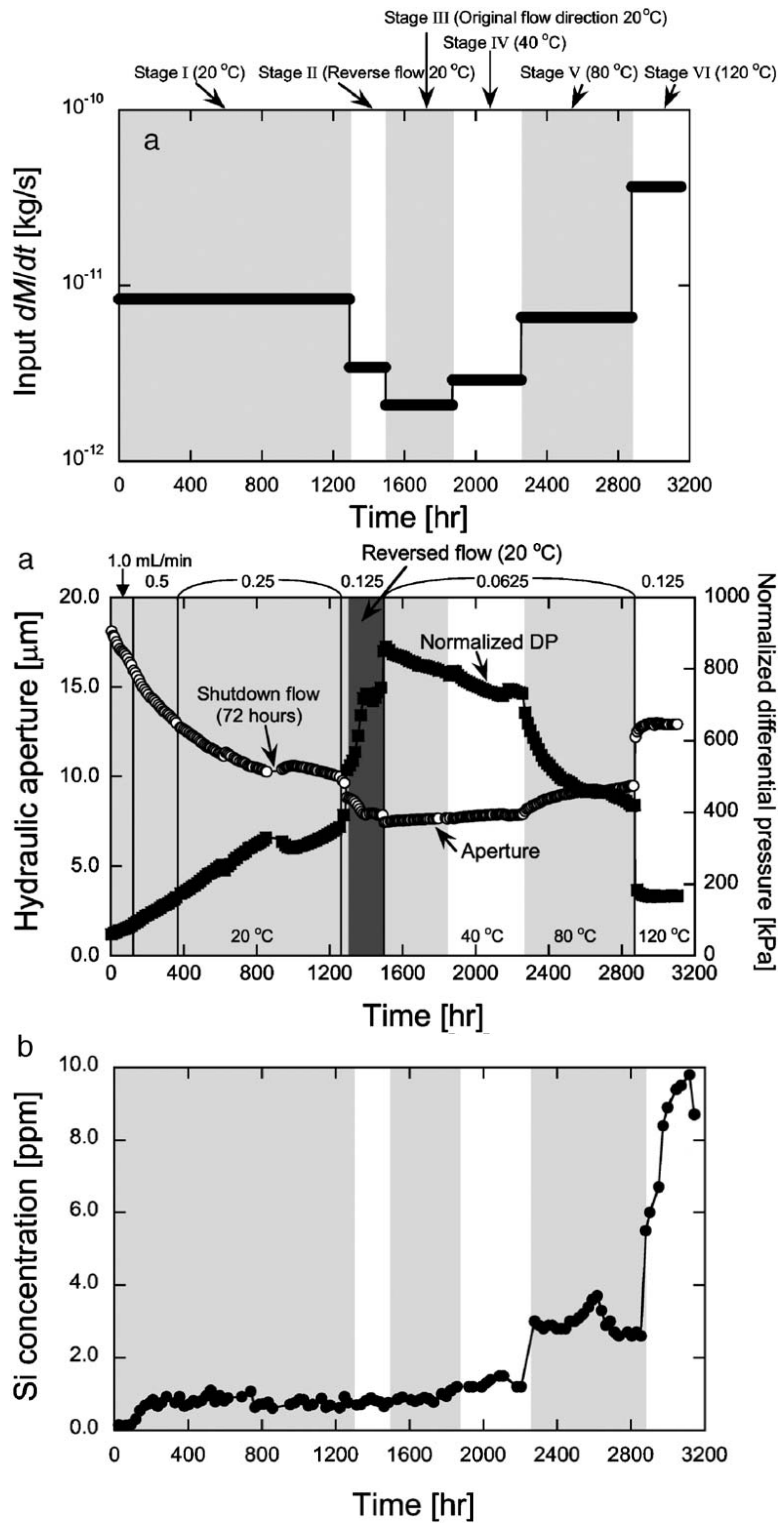

Figure 3-12. THMC behavior effects in a single fracture exposed to different external temperatures and varying stress conditions (from Yasuhara et al., 2006)

3.1.7 Task C2: Bedrichov Tunnel Experiment, Czech Republic (Focus: NBS)

The Bedrichov tunnel is an existing tunnel of 2,600 m length located in the Northern Czech Republic. The tunnel hosts a water pipe, but was recently made available for geologic studies. NAWRA (the Radioactive Waste Management Authority of the Czech Republic) and associated university researchers use the tunnel as a preliminary underground laboratory to study the suitability of the Bohemian granitic massif as a host rock for a radioactive waste repository (Figure 3-13). The site was already selected as a test case for flow models in the previous DECOVALEX phase, and since then, data collection and interpretation have progressed gradually.

The new modeling test case for DECOVALEX–2015 aims at better understanding and predicting flow patterns and tracer transport behavior within the fractured rock, between the ground surface (about 120 m above the tunnel axis) and the tunnel, including the zone around the tunnel where mechanical damage has occurred. Measured data include tunnel-water inflow patterns and rates (vs. infiltration at ground surface), water temperature, and water chemistry, the latter including chemical composition of major elements, pH, and several natural isotopes as tracers. Discrete fracture representations of the fractured granite surrounding the tunnel have been built based on fracture mapping in the tunnel and electrical resistivity profiles (Figure 3-14). Modeling will be performed for water inflow, isotope tracer speed/mixing, water and rock chemistry, temperature, pH value, for isotope tracers, and for reactive transport processes. Measurements of stress and displacement of large fractures are conducted as well, and may be brought into the modeling test case. A comprehensive database has already been established, containing the available data on site geology, fracture mapping (inside the tunnel), resistivity profiles, water inflow, water chemistry, stable isotope sampling and results, and fracture displacements.

The main scientific issues considered in this test case are:

- Hydrogeological characterization of the test site;
- Stress measurements and interpretation of results at the site scale;
- Groundwater flow and reactive tracer transport (kinetics) at the intermediate scale, with measurements and numerical modeling, considering discontinuity and heterogeneity issues;
- Borehole stability;
- Impact of uncertainty (with respect to fracture system geometry and hydro-mechanical behavior) on water flow and tracer transport.

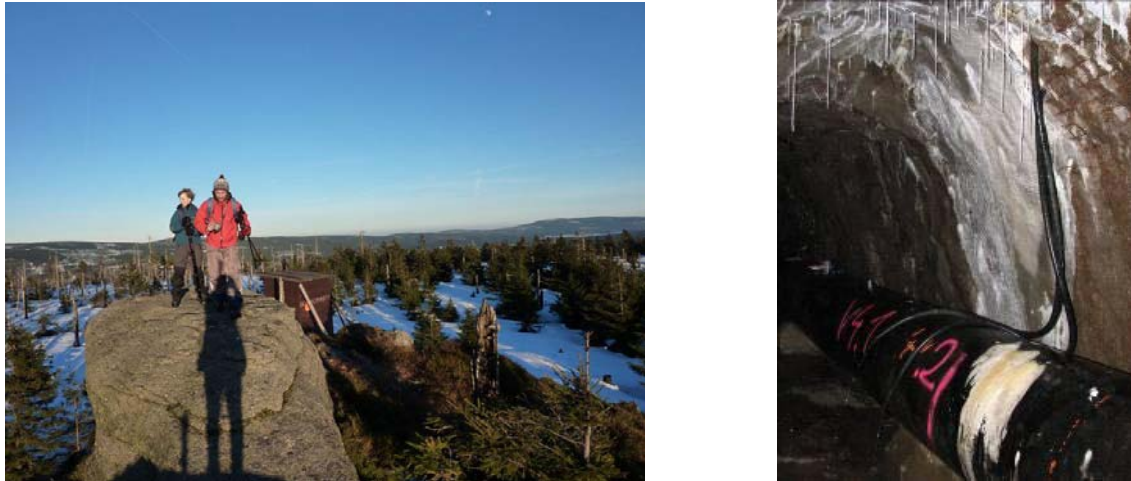

Figure 3-13. Bohemian granitic massif in Czech Republic and water inflow evidence in the Bedrichov Tunnel (from Hokr and Slovak, 2011)

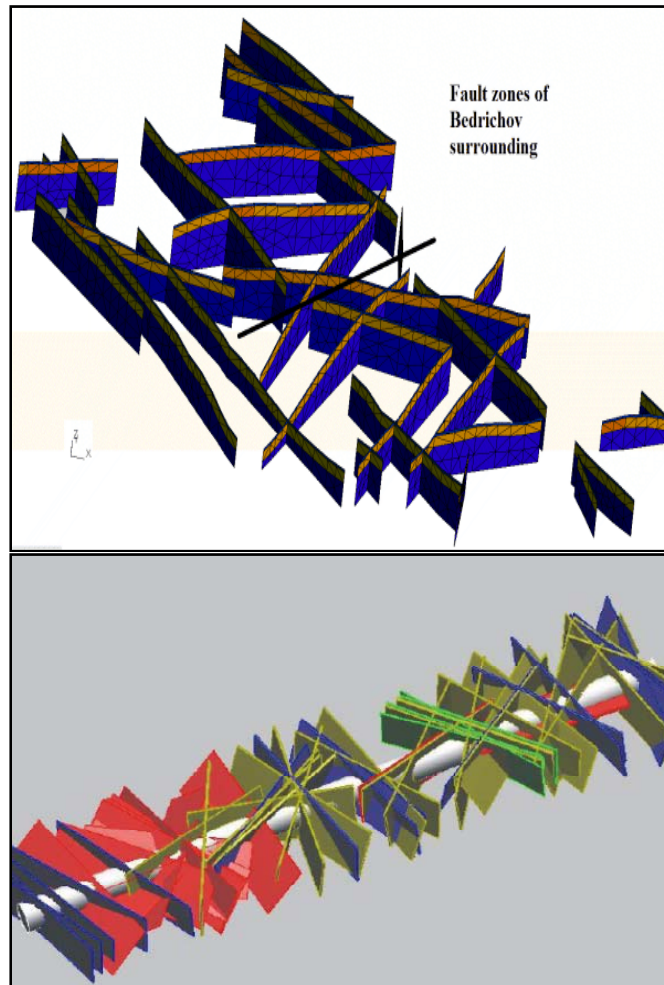

Figure 3-14. Bedrichov Tunnel Experiment : Fault and fracture models at site (top) and tunnel (bottom) scale (Hokr and Slovak, 2011)

3.1.8 DECOVALEX Summary

Benefits of Participation:

- Access to **four to six** sets of experimental data from **different** URLs and **different** host rock environments
- Opportunities for **modeling and analysis of existing data** in collaboration with other modeling groups (typically less direct interaction with the project teams that run or interpret the experiments)
- **No opportunity** for influencing, proposing, or conducting own experiments. (However, there is the opportunity to suggest modeling test cases of interest to DOE.)

Status of Participation:

DOE has formally joined the DECOVALEX project for the current phase, DECOVALEX-2015. A small annual membership fee is paid that covers the cost of administrative and technical matters. DECOVALEX-2015 started in spring 2012 with a kick-off workshop held in Berkeley, and will run for four years until end of 2015. Researchers affiliated with UFDC have started active modeling participation in two DECOVALEX tasks, namely Task B1 and Task C (see Section 5.2).

Contact Information:

DOE Contact:

Jay Jones, DOE-NE (contracts)

Mark Tynan, DOE-NE (R&D)

UFDC Contact:

Jens Birkholzer, LBNL

DECOVALEX Contact:

John Hudson, Chairman of DECOVALEX-2015, Imperial College, Great Britain

Lanru Jing, DECOVALEX Secretariat, KTH, Sweden

3.2 Mont Terri Project

3.2.1 Introduction to the Mont Terri Project

The Mont Terri Project is an international research project for the hydrogeological, geochemical, and geotechnical characterization of a clay/shale formation suitable for geologic disposal of radioactive waste (Zuidema, 2007; Bossart and Thury, 2007). The project, which was officially initiated in 1996, utilizes an underground rock laboratory, which lies north of the town of St-Ursanne in Northwestern Switzerland and is located at a depth of ~300 m below the surface in argillaceous claystone (Opalinus Clay). The rock laboratory is located in and beside the security gallery (initially the reconnaissance gallery) of the Mont Terri motorway tunnel, which was opened to traffic at the end of 1998. The rock laboratory consists mainly of eight small niches along the security gallery, excavated in 1996, the Gallery 98 and 5 lateral niches, excavated in

1997/98, a gallery for the EZ-A experiment, excavated in 2003, the Gallery 04 and 4 lateral niches, excavated in 2004, and lastly, the Gallery 08 and side galleries for the Mine-by Test and FE Heater Test, excavated in 2008 (Figure 3-15).

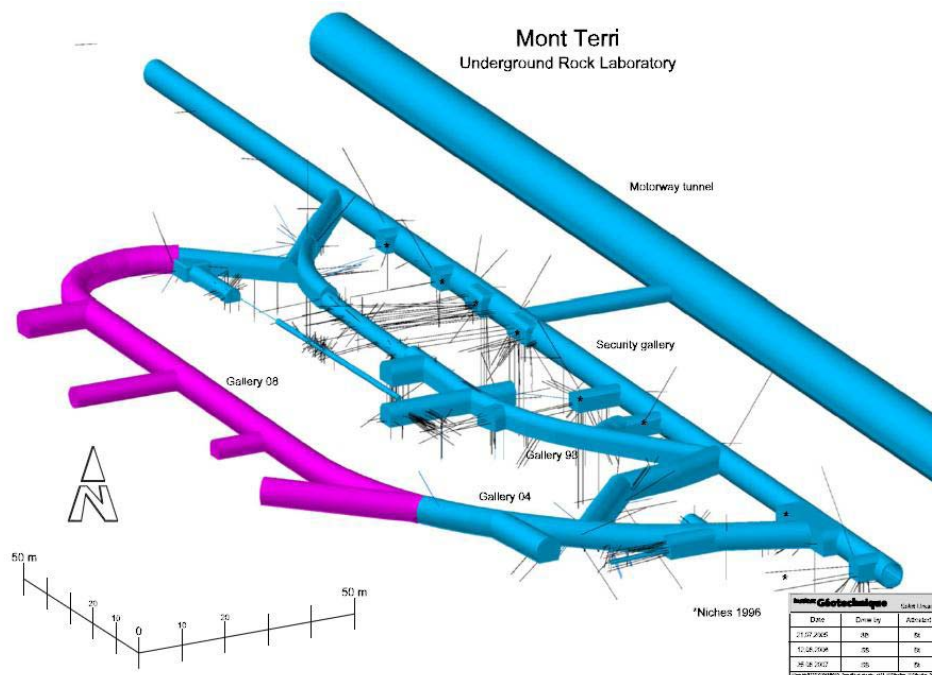

Figure 3-15. 3D schematic of the Mont Terri URL with side galleries and drifts. Pink area shows newest gallery drilled for Mine-by Test and FE Heater Test (Bossart, 2012).

The Mont Terri Project essentially operates as a collaborative program providing open access to an existing URL. The research program consists of a series of individual experiments and is divided into annual project phases, running from July 1 in one year to June 30 the next year. The Swiss geological survey Swisstopo helps with the operation and maintenance of the rock laboratory, and provides the operational management and experimental support. The research-partner organizations fund the experiments and their evaluations. Partner organizations can select and conduct experiments and participate in experiments conducted by others, and they have access to all project results from past and ongoing efforts, which are available in reports and publications and a project-owned web-based database. Planning, steering, and financing is the responsibility of all partners participating in the experiment. (Larger field experiments are therefore often conducted by more than one organization.) In Phase 17 (from July 1, 2011 through June 30, 2012), there were 14 project partners from eight countries, namely from Switzerland (Swisstopo, ENSI, NAGRA), Belgium (SCK/CEN), France (ANDRA, IRSN), Germany (BGR, GRS), Japan (OBAYASHI, JAEA, CRIEPI), Spain (ENRESA), Canada (NWMO), and the U.S. (Chevron). Over the years, these organizations have provided substantial financial investments, and additional sponsorship has been contributed by the European Community, and by the Swiss Federal Office for Science and Education. It is not surprising, therefore, that the Mont Terri Project has been very successful, and a wide range of experimental studies on clay/shale behavior (including backfill/buffer behavior) have been and are being conducted.

DOE leadership realized in 2011 that participation of DOE as a partner in the Mont Terri Project would allow unlimited access to an operating underground rock laboratory in a claystone environment. DOE membership would provide UFDC researchers with relevant field data and project results from all past Mont Terri phases. More importantly, UFDC researchers would be able to work collaboratively with international scientists on ongoing and future experimental studies, which include all design, characterization, modeling, and interpretation aspects related to field experiments. In the long term, UFDC researchers would also be able to propose and eventually conduct their own experiments at the Mont Terri URL. This type of international collaboration goes beyond the mostly modeling focus of DECOVALEX, and may be the most fruitful approach to active international R&D.

To evaluate the benefits and requirements of becoming an official partner in the Mont Terri Project, DOE sent a letter of interest to the Director of the Mont Terri Project and started negotiations about a formal membership in October 2011. UFDC representatives participated in steering committee meetings in November 2011 (held at the URL site in Saint Ursanne in Switzerland) and March 2012 (held in San Ramon, USA), as well as in the annual technical meeting in February 2012 (held at the URL site in Saint Ursanne in Switzerland). It turned out that several of the past and ongoing experiments were highly relevant to UFDC's R&D objectives, and that the membership conditions were acceptable to DOE. A decision was made in early 2012 that DOE would formally apply for partnership in the Mont Terri Project. On January 27, 2012, a letter was sent to the Mont Terri Project Director confirming DOE's intent to become a partner. Shortly thereafter, all existing Mont Terri Project partners unanimously accepted DOE as a new partner organization, starting with the upcoming Phase 18 (July 1, 2012 through June 30, 2013).

One of the membership conditions for new Mont Terri partners is a commitment to invest 500K Swiss Francs into ongoing experiments over a period of three years. It was decided, however, that forty percent of the total financial involvement can be contributed as an in-kind contribution provided by DOE researchers (i.e., by having UFDC researchers conduct work related to ongoing Mont Terri experiments). Specifically, the in-kind contribution of DOE is the participation of Lawrence Berkeley National Laboratory (LBNL) researchers in the design and prediction modeling of the FE Heater Test (described below in more detail), a long-term (>10 years), full-scale test that will serve as an ultimate validation and demonstration test for emplacement of heat-producing waste in Opalinus Clay, at realistic temporal and spatial scales.

Figures 3-16 and 3-17 show an overview of current experiments conducted at the Mont Terri URL (status June 2012). The timeline in Figure 3-16 places these experiments in the context of relevance to different phases in the lifetime of a repository: (1) Experiments related to initial conditions and repository construction, (2) Experiments related to buffer emplacement and monitoring, (3) Experiments related to post-closure of repository: Pore-pressure evolution, self-sealing and long-term deformations, (4) Experiments related to chemical dissolution, precipitation, and microbial processes, (5) Experiments related to liner alteration, iron corrosion, iron-bentonite interaction, and gas production, and (6) Experiments related to radionuclide transport. In terms of the experimental objective, one may distinguish between three categories: (a) Experiments to provide a better understanding of performance-relevant processes during the lifetime of a generic clay repository (e.g., EDZ, thermal effects, gas generation and transport, RN

transport, etc.), (b) Experiments to better characterize the site-specific conditions at Mont Terri (e.g., host rock properties, *in situ* stresses, *in situ* geochemistry, etc.), and (c) Experiments testing and improving characterization and monitoring technologies.

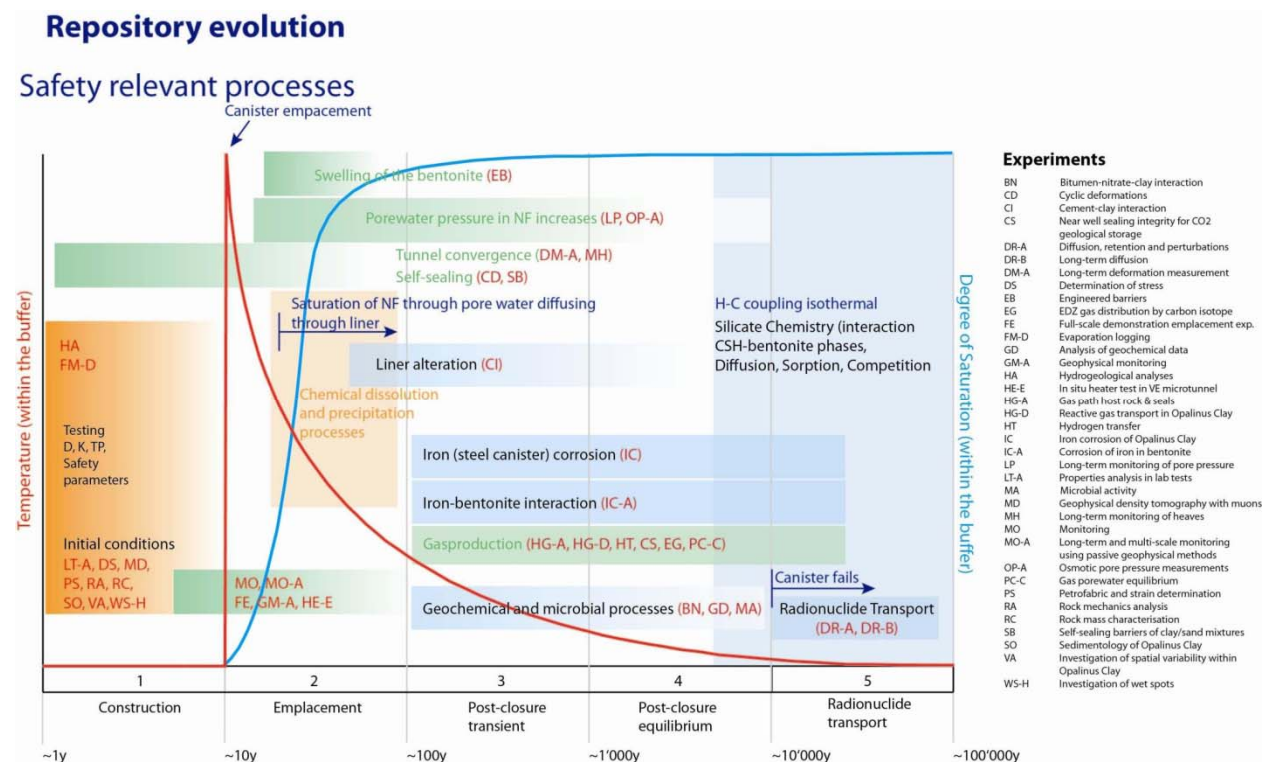

Figure 3-16. List of main Mont Terri URL experiments conducted during Phase 17 (July 2011 through June 2012), displayed with respect to relevancy during different repository stages (Bossart, 2012).

Most experiments are long-running tests that have started before or with Phase 17 (July 2011 through June 2012), have carried on into the ongoing Phase 18, and will continue into future project phases. Almost all experiments include substantial laboratory and modeling tasks, in addition to the actual field components of the project. In addition to the FE Heater Test, there are several ongoing experiments of interest to UFDC; the most relevant are further described below: FE Heater Test, Mine-by Test, CI Cement-Clay Interaction Experiment, HG-A Experiment, and DR-A Diffusion, Retention, and Perturbation Experiment. In addition, there is the HE-E Heater Test at Mont Terri, which is used as Task B1 of the current DECOVALEX-2015 phase, and which was previously introduced in Section 3.1.4.

It is worth describing in more detail how the collaborative Mont Terri project operates and how the process of planning and initiating new experiments works. Once a year, in the Technical Meeting held in late winter, partner organizations may propose in brief presentations any new work that they would like to undertake in the upcoming Mont Terri project phase(s) (as mentioned before, project phases always run from July 1 through June 30th). The proposing partners will present the technical scope and merit of the proposed work and will give a rough

estimate of the cost. Then, they will invite other partner organizations to consider joining the new task. In some cases, that could mean a direct financial contribution to the cost of the experiment; in other cases, they may invite partners to conduct monitoring or modeling analysis complementing their proposal. They will then write a short project description prior to the next Mont Terri Steering Committee Meeting (which is typically held a few months after the Technical Meeting) where ongoing and new experiments are selected. The experimental program for the next project phase is then finalized, including the financial contributions of each partner, in a second Steering Committee Meeting held just before the start of the new phase. This process repeats itself every year.

For DOE, there is thus a clear path forward at Mont Terri if, in the future, UFDC had an interest in proposing its own experiments. Partners can be found if the proposed work aligns well with the interest of other Mont Terri organizations. It is important to note in this context that the existing infrastructure at Mont Terri makes developing and conducting experiments very easy, even if the proposing partner is located far away from the URL. Swisstopo can handle a lot of the organizational details if needed, and there is a long list of experienced contractors that are available to conduct the actual experimental work.

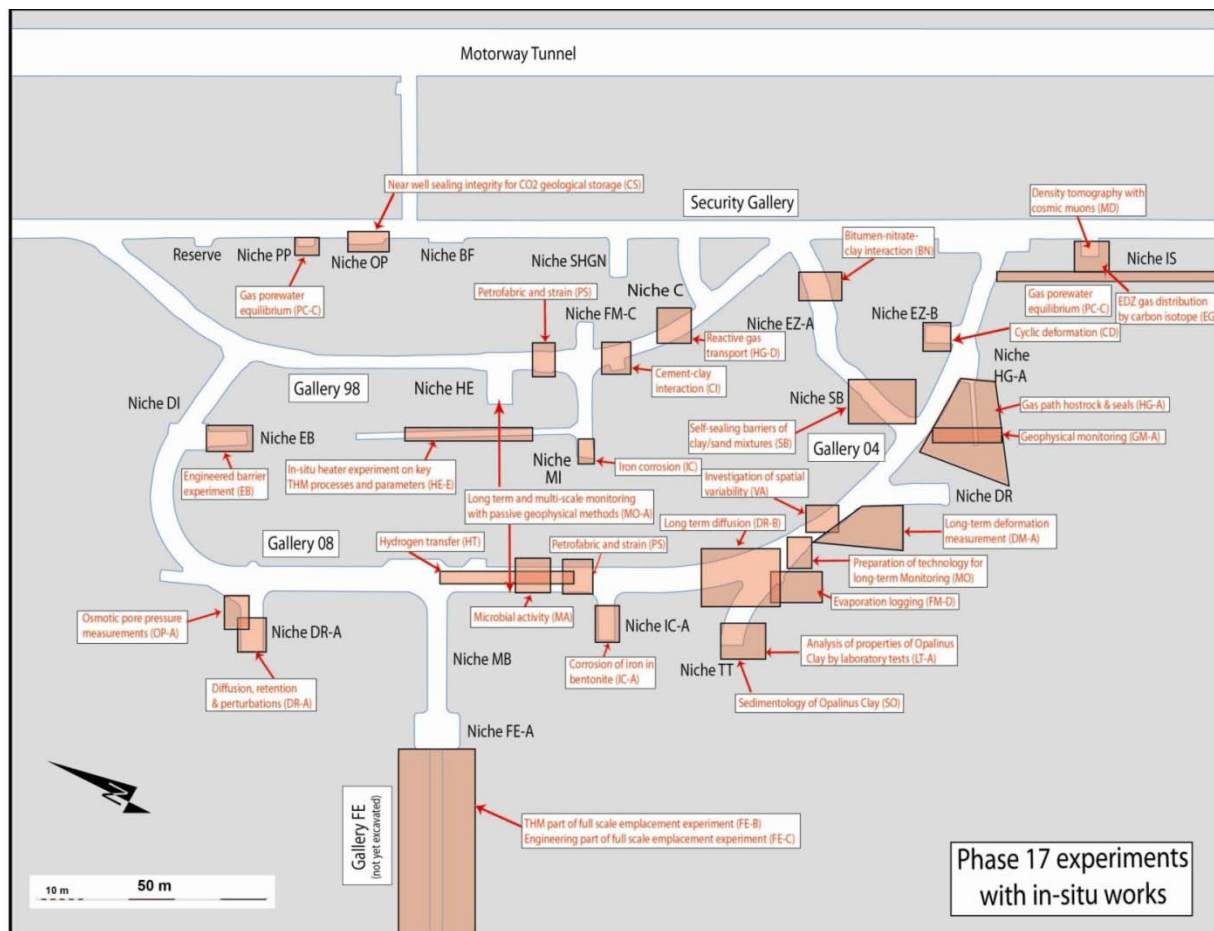

Figure 3-17. Plan view of the Mont Terri URL with main experiments conducted during Phase 17 (July 2011 through June 2012) (Bossart, 2012).

3.2.2 FE Heater Test (Focus: both NBS and EBS)

Because of its potential relevance to UFDC’s NBS and EBS areas, we provide here some further detail on the Full-Scale Emplacement Experiment (FE Heater Test), one of the largest and longest-duration heater tests worldwide. This heater experiment is undertaken by NAGRA as an ultimate test for the performance of geologic disposal in Opalinus Clay, with focus on both EBS components and host-rock behavior. Mont Terri partners collaborating with NAGRA in this experiment are ANDRA, BGR, GRS, NWMO, and, as of July 2012, also DOE (see Section 5.2.1). The FE Heater Test is partially supported by an ongoing European Union Project referred to as LUCOEX (Large Underground Concept Experiments).

The experiment is currently in the design, preparation, and construction stage. Tunnel excavation will be finalized in the fall of 2012, followed by a ventilation and emplacement period, before the heaters are expected to be turned on in early 2014. Predictive models are currently being developed, both for the support of design and instrumentation planning, as well as for later comparison with measured THM effects. As shown in Figures 3-18 and 3-19, the FE Heater Test will be conducted in a side alcove at Mont Terri, excavated along the claystone bedding plane for this purpose, with 50 m length and about 2.8 m diameter. Heating from emplaced waste will be simulated by three heat-producing canisters of 1500 W maximum power. A sophisticated monitoring program is planned, including dense pre-instrumentation of the site for *in situ* characterization, dense instrumentation of bentonite buffer and host rock, and extensive geophysical monitoring (seismic and electric “tomography”). A THM modeling program will be conducted in parallel with the testing and monitoring activities.

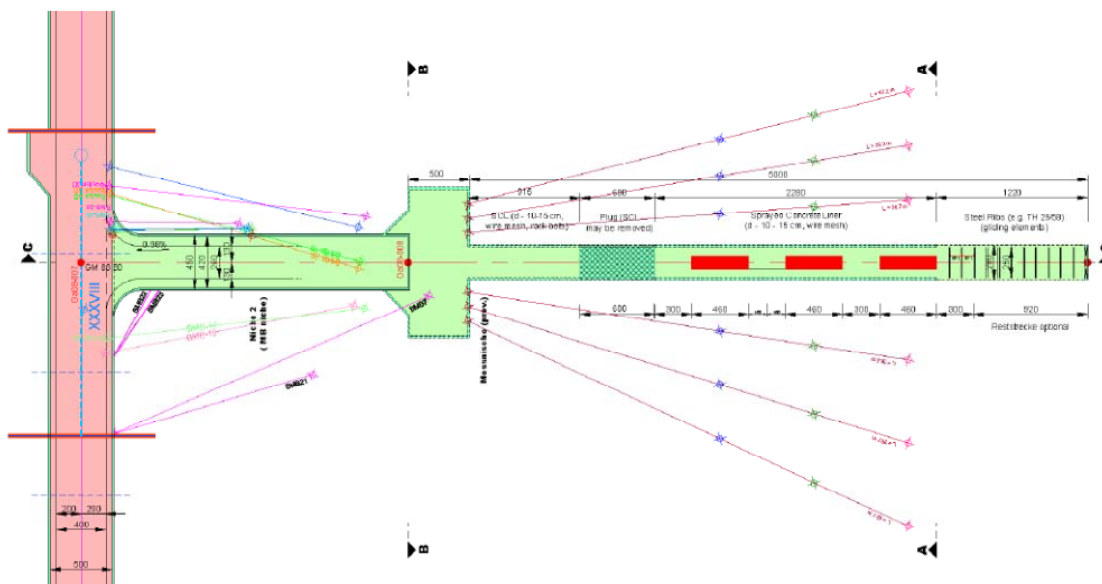

Figure 3-18. FE Heater Test at Mont Terri URL: Plan view of experiment setup and borehole layout (from Garitte, 2010)

The experiment will provide data useful for the validation of THM coupling effects regarding the processes in the host rock while correctly accounting for (and examining) the expected

conditions in the emplacement tunnel (temperature, saturation, and swelling pressure). Due to the 1:1 scale of the experiment, it will be possible to achieve realistic temperature, saturation, and stress gradients. It will also be possible to test backfilling technology with granular bentonite, as well as lining technology with shotcrete, anchors, and steel ribs. Processes examined in the test cover many aspects of repository evolution, such as EDZ creation and desaturation of the EDZ during tunnel excavation and operation (including ventilation for about one year), as well as reconsolidation of the EDZ, resaturation, thermal stresses, and thermal pore-pressure increase after backfilling and heating (heating and monitoring period > 10 years).

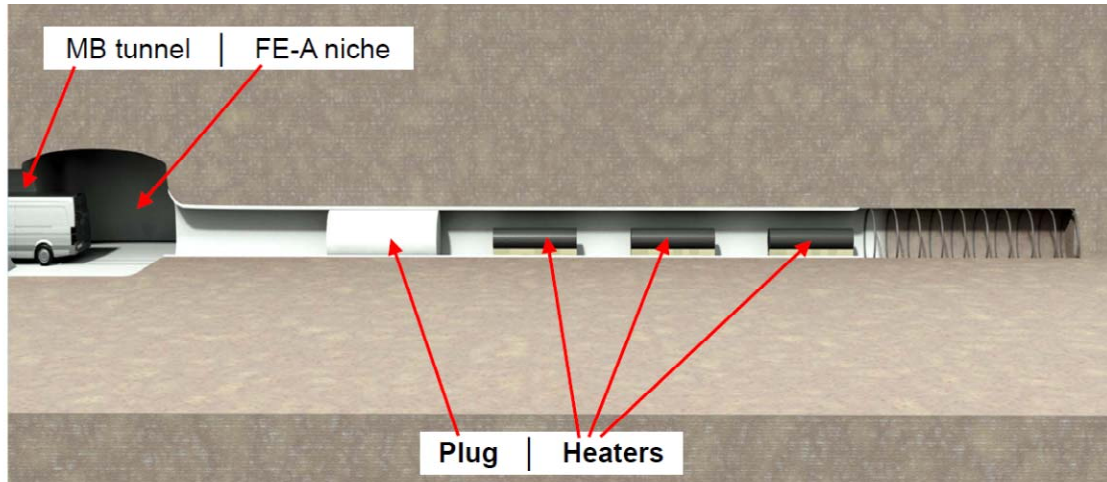

Figure 3-19. FE Heater Test at Mont Terri URL: Side view of experiment setup and heater layout (from Garitte, 2010)

3.2.3 Mine-by Test (Focus: NBS)

The Mine-By Test at the Mont Terri URL, shown in Figure 3-20, involved tunneling through a pre-instrumented region of Opalinus Clay. The test, conducted at full tunnel scale, has been completed recently, and several years of data on EDZ behavior are available for modeling and interpretation. The test allows evaluating the excavation-generated pressure, stress, displacement, and rock-damage response in the argillaceous clay host rock near a mined tunnel, and also provides measurements of related changes in the near-field hydrologic properties. Data available for analysis include stress and convergence measurements, pore-pressure results, and hydrotest results before and after mining. Some of the most interesting observations are related to the fact that pore pressure and deformation signals can be observed several meters before the advancing tunnel face, a response that cannot be easily explained with the existing constitutive relationships. New fractures created in the EDZ show interaction with bedding planes and crosscutting joints. Mine-by leads to a significant increase of hydraulic conductivity by up to four orders of magnitude. Note that the Mine-by Test niche functions as the access gallery to the tunnel sections that host the soon-to-be-conducted FE Heater Test.

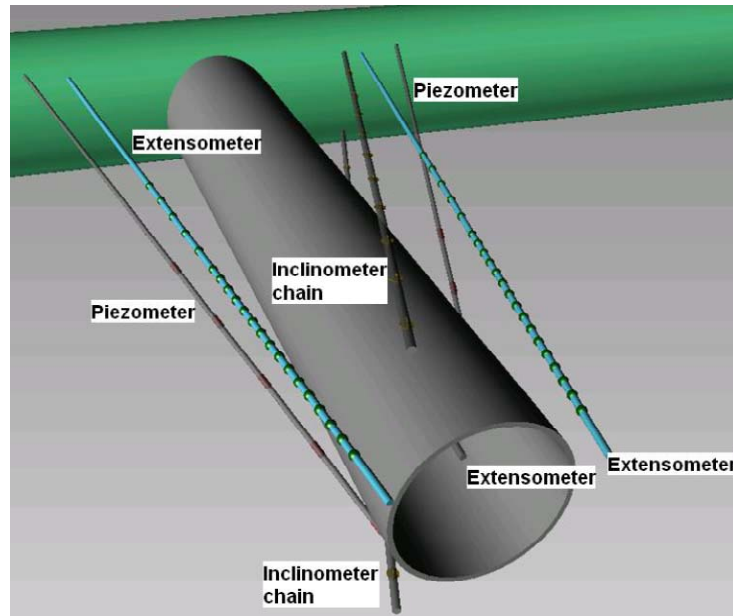

Figure 3-20. Schematic setup of Mine-by Test at Mont Terri showing location of selected boreholes for piezometer, extensometer, and inclinometer data (from Vietor et al., 2011)

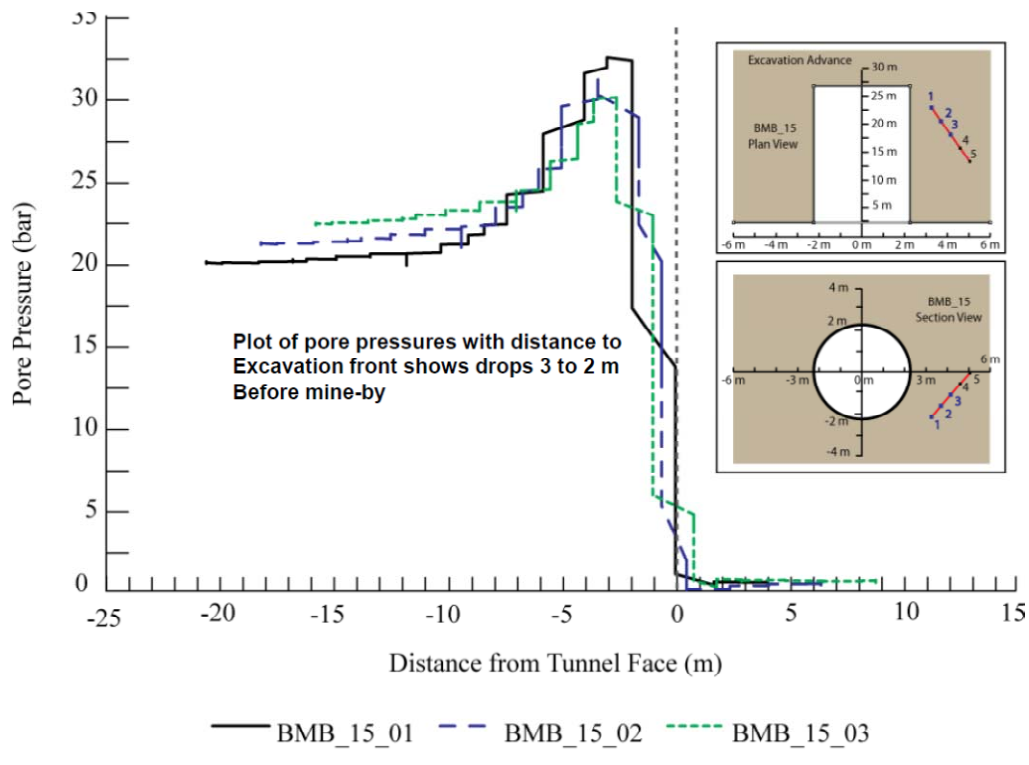

Figure 3-21. Mine-by Test at Mont Terri URL: Measurements of pore pressure relative to distance from advancing excavation front (from Vietor et al., 2011). Pore-pressure signals can be observed several meters before the advancing tunnel face.

3.2.4 CI Cement-Clay Interaction Experiment (Focus: mostly EBS)

The CI is a long-term experiment intended to improve current knowledge regarding the chemical interaction between Opalinus Clay and engineered barrier materials, such as cement and bentonite. Geochemical imbalance at the interfaces between these materials generates chemical gradients that drive diffusive transport of solutes across them. Reactive transport models have predicted that this solute exchange can lead to porosity sealing and porosity opening on two sides near interfaces; however, this may be a slow process. To examine these processes in an *in situ* environment, the CI experiment was implemented in spring 2007 as a maintenance-poor long-term test that would continue over several project phases. Partner organizations currently involved in the CI experiment are ANDRA, CRIEPI, IRSN, NAGRA, OBAYASHI, and SCK/CEN.

Figure 3-22 shows the basic design of the CI experiment. Concrete made of ordinary Portland Cement (OPC) as well as low-pH cements was brought into two boreholes, together with a bentonite segment. To have a measure of the water diffusion in comparison with the spreading of an alkaline plume, ²HHO was added as a conservative tracer. The interfaces were investigated in 2009, and again in 2012, by coring at an angle through the clay/cement/bentonite interfaces (Figure 3-23). Analytical work on the recent sampling campaign is ongoing, using various techniques to characterize the evolution of minerals and porosity at the concrete–clay interface (i.e., μ -XRD / (μ -XAS) synchrotron methods, SEM/TEM, and others) (Figure 3-24). Reactive transport modeling will be conducted during the upcoming Mont Terri phases.

Experimental concept and layout

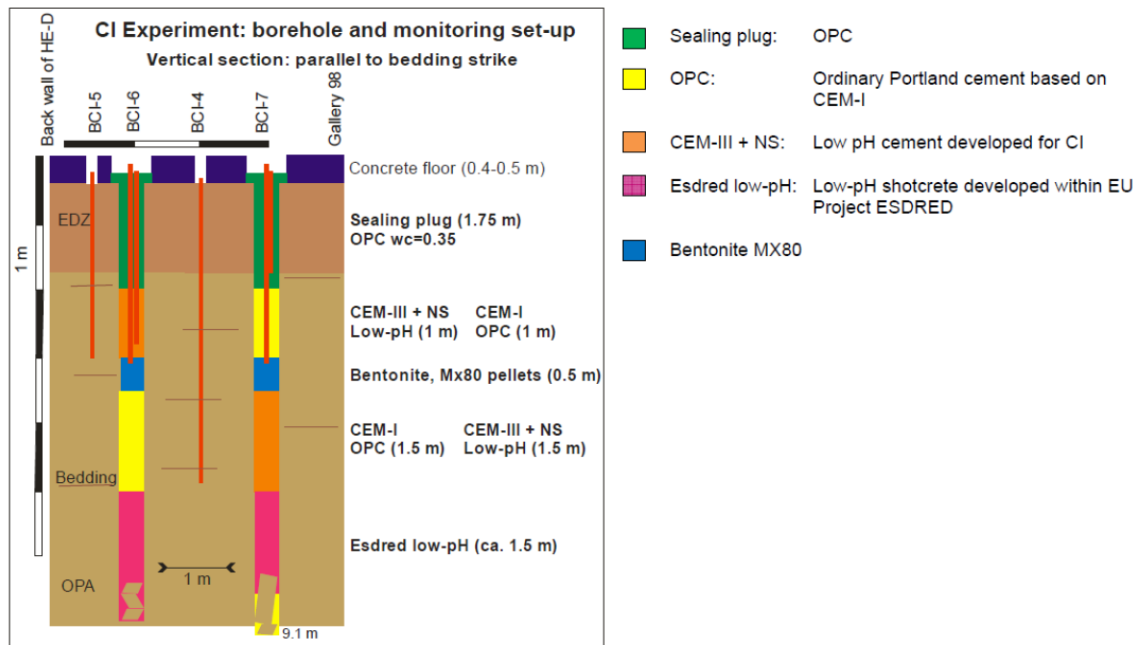

Figure 3-22. Schematic setup of CI Experiment at Mont Terri URL (from Maeder and Schwyn, 2012).

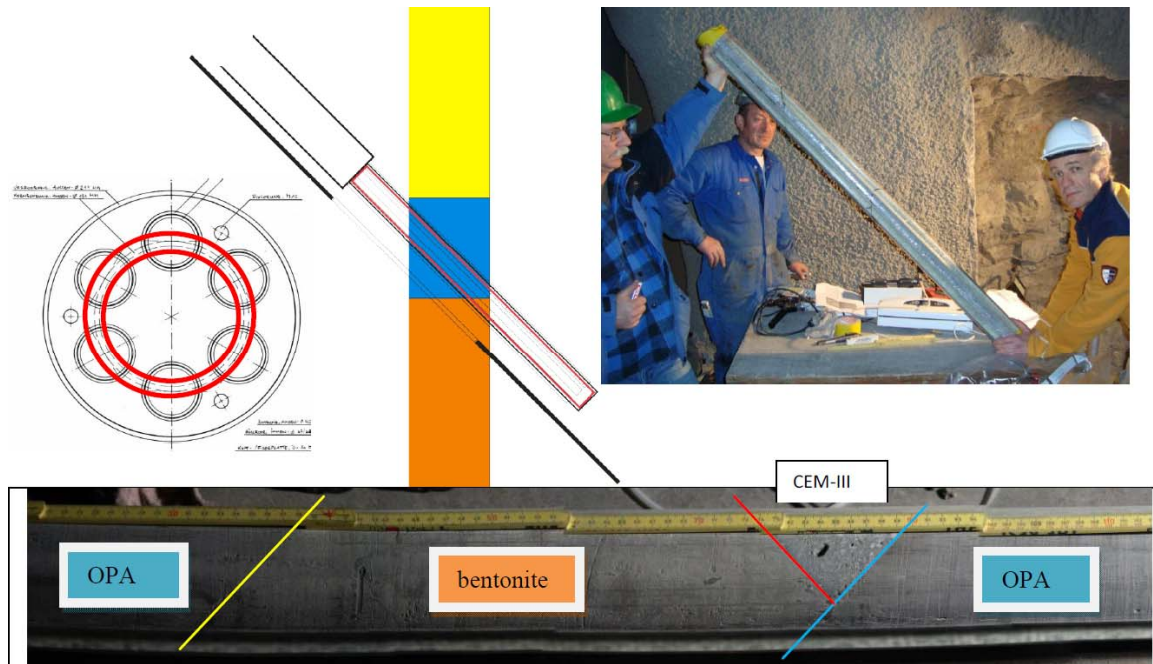

Figure 3-23. CI Experiment at Mont Terri URL: Sampling was conducted in two campaigns by drilling angled boreholes through the cement-bentonite-clay interfaces. The bottom photo shows borehole core with interfaces between Opalinus Clay (OPA), bentonite, and CEM-III (cement) (from Maeder and Schwyn, 2012).

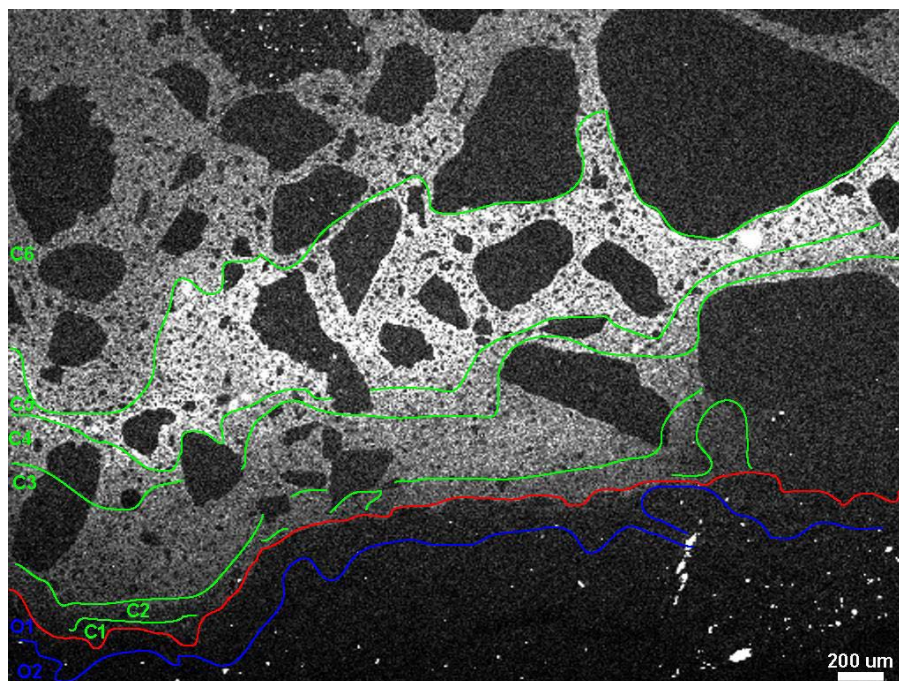

Figure 3-24. CI Experiment at Mont Terri URL: SEM map indicating interface between concrete (top) and Opalinus Clay (bottom) (from Maeder and Schwyn, 2012).

3.2.5 HG-A Experiment (Focus: mostly NBS)

The HG-A Experiment focuses on gas paths through the near-field host rock and specifically along seal sections. The objectives are to assess the potential for gas escape from a sealed disposal tunnel, to investigate the role of the EDZ as an important gas path, to understand the importance of sealing processes along the EDZ, and to determine the rock permeability along the tunnel, through measurements and predictions of fluid and gas flow. Partner organizations currently involved in the HG-A experiment are ANDRA, BGR, NAGRA, and NWMO.

The experiment is conducted in a horizontal micro-tunnel that represents a sealed disposal tunnel section at a scale of 1:2.5 (Figures 3-25 and 3-26). After characterizing the hydraulics, stress conditions, and EDZ extent in the near-field of the open micro-tunnel, the tunnel was backfilled, sealed, and then artificially resaturated. Starting in 2006, several long-term hydraulic and gas-injection tests were conducted to determine "macro-permeability" before, during, and after the gas-injection phase. Gas injection was conducted by pressurization of the deep micro-tunnel section with nitrogen gas and monitoring of pressure build-up in the sealed disposal tunnel section. Hydraulic testing of the sealed tunnel subsequent to the gas-injection phase was conducted to determine possible alteration of the barrier function of the Opalinus Clay. Results obtained so far confirm that the EDZ serves as a preferential flow path along a seal section, and that it carries the gas efficiently, but in a localized manner, at moderate gas pressures.

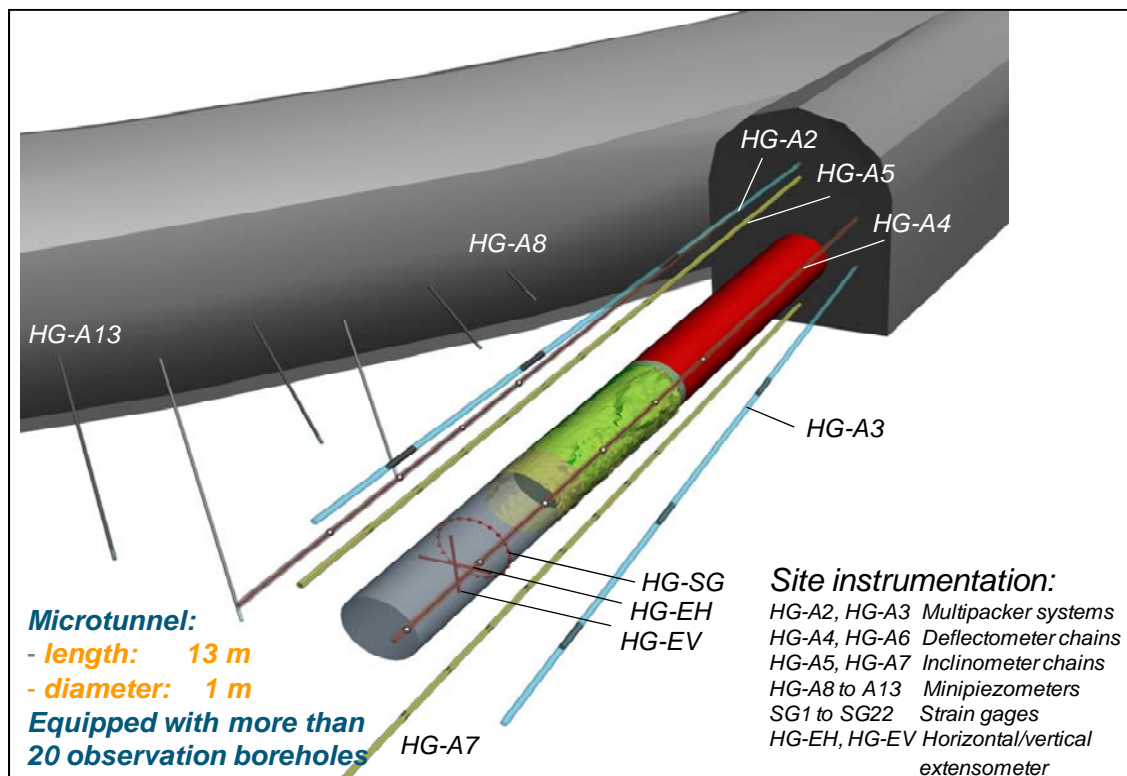

Figure 3-25. Schematic setup of HG-A Experiment at Mont Terri URL (from Marschall et al., 2012).

Further experiments are planned for the current and future experiment phases, for example a new gas-injection test with increased injection rate followed by a seal test, and seismic tomography will be tested for visualizing gas flow along the seal section. Also, additional modeling of gas transport will be conducted with continuum and discrete fracture models (e.g., Figure 3.27).



Figure 3-26. HG-A Experiment at Mont Terri URL: Installation of packer system (from Marschall et al., 2012).

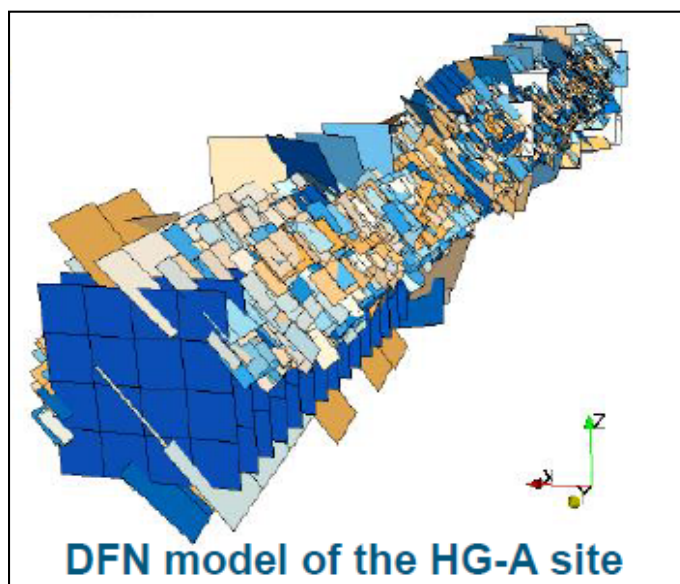

Figure 3-27. HG-A Experiment at Mont Terri URL: Discrete fracture model of EDZ (from Marschall et al., 2012).

3.2.6 DR-A Diffusion, Retention and Perturbation Experiment (Focus: NBS)

The ongoing DR-A Experiment is based on a successfully tested design from previous diffusion experiments (DI, DI-B, DR, DI-A etc.). As shown in Figure 3-28, a tracer pulse is added to circulate artificial pore water through the Opalinus Clay. The diffusion and retention of the different tracers in the pulse is investigated (water, cations and anions, conservative and sorbing); the measurements will allow for the detailed description of processes such as anion exclusion and sorption of cations. One novel aspect of the DR-A Experiment is that solutions are used that are not in equilibrium with the host rock: mineral reactions are therefore induced in the rock, and tracer response to different solution chemistries and altered clay mineralogies can be examined. The aim behind inducing disturbances is to test the predictive capabilities of the reactive transport models currently being used by different disposal programs. Partner organizations currently involved in the DR-A experiment are NAGRA and NWMO, and recently also DOE (see Section 5.2.6).

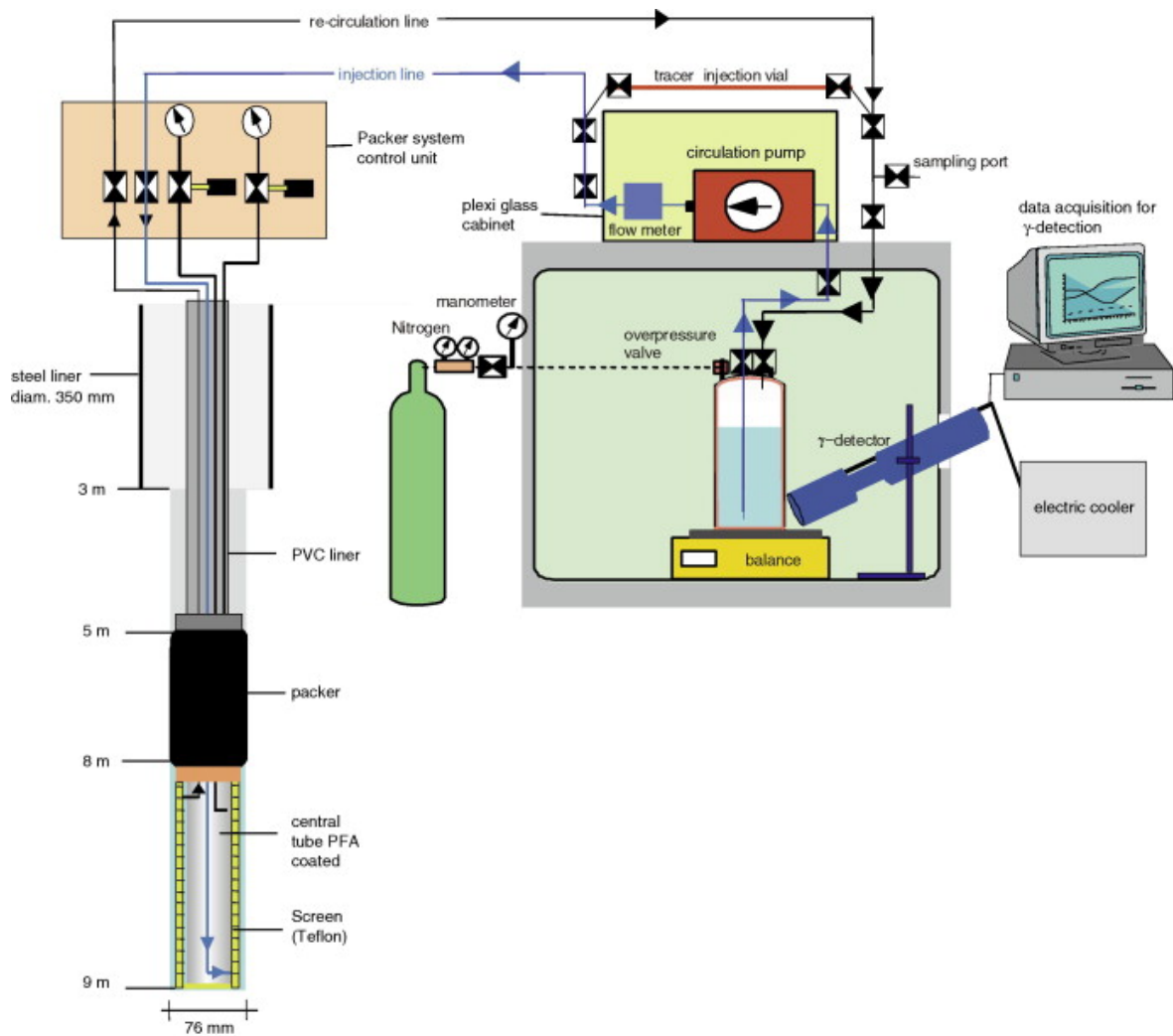

Figure 3-28. Layout of the DI-A Diffusion Experiment at Mont Terri URL, showing main features of the down-hole and surface equipment (from Wersin et al., 2004; 2008).

The currently conducted or planned perturbations of the pore-water chemistry in the DR-A Experiment include changing the ionic strength of the circulating solution, using a high-pH solution, or changing Eh, all of which can affect the transport and sorption behavior of non-reactive and reactive tracers. For example, a higher ionic strength is likely to affect sorption directly, but also could potentially affect the transport of very weakly sorbing anions that are partly excluded by the electrical double layer (EDL). Ionic strength has a direct effect on the volume of “EDL porosity” through its control on the width of the diffuse layer. Different tracer responses will be correlated to different solution chemistries, changes in occupancies on the cation exchange sites, and changes in mineralogies.

3.2.7 Mont Terri Summary

Benefits of Participation:

- Access to experimental data from **one URL in clay/shale host rock**, with **many past, ongoing and future experiments** addressing various FEPs
- Opportunity to **participate directly in international research groups that conduct, analyze, and model** experiments (more direct involvement than DECOVALEX)
- Opportunity for participating in and steering ongoing or planned experiments as well as **conducting own experiments**

Status of Participation:

Effective July 1, 2012, DOE has formally joined the Mont Terri Project as a partner organization. A substantial part of DOE’s partnership fee is provided as an in-kind contribution provided by DOE researchers (i.e., by having UFDC researchers conduct work related to ongoing Mont Terri experiments). Specifically, the in-kind contribution of DOE is participation of LBNL researchers in the design and prediction modeling of the FE Heater Test. In addition to the FE Heater Test, UFDC researchers are participating, or considering participation, in the Mine-by Test, the HE-E Heater Test, the CI Experiment, the HG-A Experiment, and the DR-A Diffusion Experiment (Section 5.2).

Contact Information:

DOE Contact:

Jay Jones, DOE-NE (contracts)

Prasad Nair, DOE-NE (R&D)

UFDC Contact:

Jens Birkholzer, LBNL

Mont Terri Project Contact:

Paul Bossart, Director, Swisstopo, Switzerland

Christophe Nussbaum, Project Manager, Swisstopo, Switzerland

3.3 Colloid Formation and Migration Project

3.3.1 Introduction to the CFM Project

The Colloid Formation and Migration (CFM) Project is an international research project for the investigation of colloid formation/bentonite erosion, colloid migration, and colloid-associated radionuclide transport, relevant to both NBS and EBS areas of UFDC. This collaborative project is one of several experimental R&D projects associated with the Grimsel Test Site (GTS) in the Swiss Alps, a URL situated in sparsely fractured crystalline host rock. Colloid-related R&D comprises *in situ* migration experiments conducted between boreholes in a fracture shear zone; these are complemented by laboratory and modeling studies. Current CFM project partners are from Germany (FZK/BMWi), Japan (JAEA, CRIEPI), Sweden (SKB), South Korea (KAERI), Finland (POSIVA), and Switzerland (NAGRA). Other contributors are from: Finland (University of Helsinki), Germany (GRS), Spain (CIEMAT), Switzerland (PSI).

The main R&D objectives, relevant to both NBS and EBS issues, are as follows:

- To examine colloid generation rates and mechanisms at the Engineered Barrier System (EBS)–host rock boundary under *in situ* conditions,
- To study the long-term geochemical behavior (mobility, mineralization, colloid formation, etc.) of radionuclides at the EBS–host rock interface,
- To evaluate the long-distance migration behavior of radionuclides and colloids in water-conducting features in a repository-relevant flow system (i.e., with a very low flow rate/water flux),
- To examine reversibility of radionuclide uptake onto colloids,
- To gain experience in long-term monitoring of radionuclide/colloid propagation near a repository.

The CFM project was preceded by the Colloid and Radionuclide Retardation (CRR) project, conducted at the Grimsel Test Site from 1997 to 2003. Twenty-seven field tracer tests were conducted during the CRR, including seven that involved short-lived radionuclides, one involving a suite of radionuclides that included isotopes of U, Np, Am, and Pu, and one involving a suite of radionuclides (including Cs, Sr, Tc, U, Np, Am, and Pu isotopes) injected with bentonite colloids. Colloid-facilitated radionuclide transport was quantified by comparing the breakthrough curves of the radionuclides in the latter two tests (with and without the colloids). Similar tests with and without colloids were also conducted using nonradioactive homologues of actinides (e.g., stable isotopes of Th, Hf, and Tb). All of the CRR tests were conducted as weak-dipole tests between boreholes completed in a fracture shear zone (the MI shear zone), with the tests involving radionuclides being conducted between boreholes separated by 2.2 m. Tracer residence times in all tests were no more than a few hours.

The CFM project was initiated soon after the Grimsel Test Site transitioned to Phase VI testing in 2004. While similar in many respects to the CRR project, the CFM project aimed to improve or expand upon CRR in two key areas: (1) increase tracer residence times in the fracture shear zone to allow interrogation of processes that may not be observed over the very short time scales of the CRR tests (e.g., colloid filtration, radionuclide desorption from colloids), and (2) directly evaluate the performance of bentonite backfill with respect to swelling, erosion, and colloid generation, by emplacing a bentonite plug into a borehole completed in the fracture shear zone.

To accomplish these objectives, a “tunnel packer” system was installed to seal off the entire access tunnel where it was intersected by the shear zone (Figures 3-29 and 3-30). With this packer system, the flow rate from the shear zone into the tunnel could be throttled back from a natural rate of ~700 mL/min to any desired value, and the water from the shear zone could be collected in a controlled manner. Boreholes penetrating the shear zone could then be used as injection boreholes for tracer tests or for emplacement of the bentonite plug, with the tunnel packer effectively serving as an extraction location.

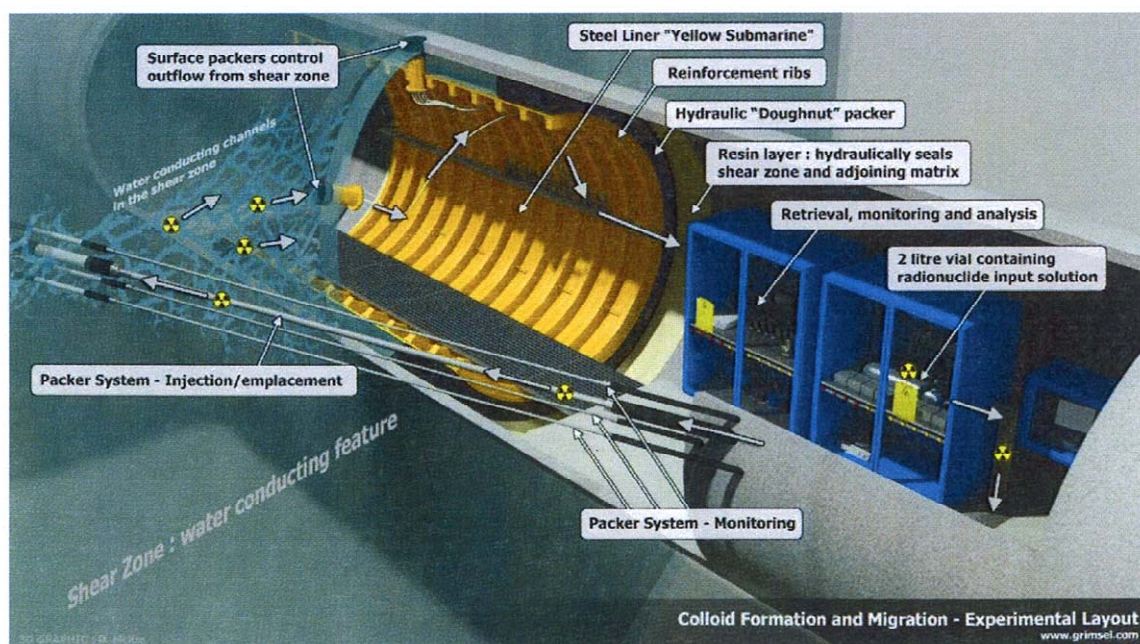

Figure 3-29. Schematic illustration of the CFM field test bed at Grimsel Test Site (from Reimus, 2012).

Seven conservative (nonsorbing) tracer tests were conducted in late 2006 through 2007 at various shear zone flow rates using different boreholes as injection holes to test the tunnel packer system and to evaluate tracer residence times that could be achieved. Tracer transport pathways in these tests and in all the CRR tests are depicted in Figure 3-31, which shows the locations of several boreholes relative to the main tunnel within the MI shear zone. Borehole CFM 06.002, drilled in 2006 for the CFM project, was established as the primary injection borehole to be used in subsequent tracer testing involving colloids, homologues, and radionuclides. In 2008, a tracer test was conducted in which a bentonite colloid solution with homologues pre-sorbed onto the colloids was injected into CFM 06.002. This test was followed immediately with a conservative tracer test in the same configuration. Based on lessons learned from these tests, a series of five more tests were conducted in 2009 and 2010. Three of these included only conservative tracers, and two included bentonite colloids and homologues in addition to conservative tracers.

Recent activities of the CFM Project include (1) a tracer test involving the injection of a radionuclide-colloid cocktail into injection interval CFM 06.002i2 in the shear zone, conducted in February and March 2012, to evaluate the transport of bentonite colloids and radionuclides from the source to the extraction point at the tunnel wall; and (2) planning of an upcoming test involving the emplacement of a radionuclide-doped bentonite plug into the same injection

interval to evaluate the swelling and erosion of the bentonite and subsequent transport. These two migration experiments, which constitute the culmination of the CFM project during Phase VI testing at Grimsel, are very relevant to UFDC’s R&D objectives and are further described in Sections 3.3.2 and 3.3.3 below.



Figure 3-30. CFM field test bed at Grimsel Test Site: Tunnel packer system used to isolate the MI shear zone (from <http://www.grimsel.com/gts-phase-vi/cfm-section/cfm-site-preparation>). Small disks with tubing issuing from them (inside yellow packer) are “surface packers” that seal the tunnel wall and collect water from inflow points. Tunnel diameter is 3.5 meters.

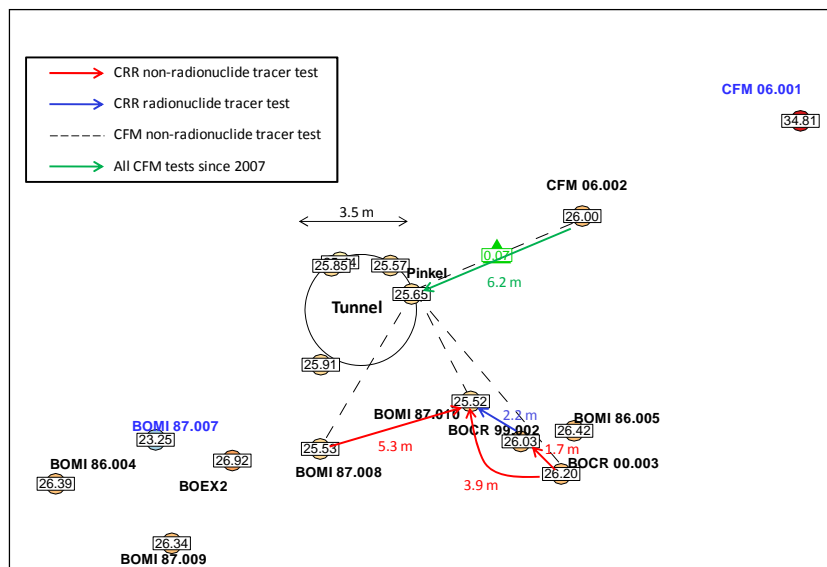

Figure 3-31. CFM field test bed at Grimsel Test Site: Tracer transport pathways and flow distances in the MI shear zone in all tracer tests (2001-present).

In addition to the field testing activities being conducted at the Grimsel Test Site, the CFM project includes many complementary activities aimed at helping achieve the R&D objectives listed at the beginning of this section. These activities include:

- Bentonite swelling and erosion experiments in various laboratory configurations, including artificial fractures, to better understand the processes of swelling and erosion that will occur in the bentonite-plug field experiment
- Laboratory sorption and desorption experiments of radionuclides and homologues onto both bentonite colloids and Grimsel fracture fill material
- Ternary sorption/desorption experiments involving the competitive sorption and desorption of radionuclides/homologues in the presence of both colloids and fracture fill material
- Colloid-facilitated radionuclide transport experiments in both crushed rock columns and in fractures in the laboratory.
- Laboratory efforts to improve detection and quantification methods for colloid analyses in field experiments, including possibly labeling the bentonite with a rare element that does not affect the behavior of the bentonite
- Development of a bentonite swelling/erosion model
- Interpretive modeling of the laboratory experiments and the field tracer tests

Similar to the Mont Terri Project discussed above, DOE reviewed (in FY11) the benefit of becoming a formal partner of the Colloid Formation and Migration Project. Formal partnership would give DOE and affiliated National Laboratories easier access to all experimental data generated by CFM. More importantly, it would allow for UFDC researchers to work collaboratively with international scientists in ongoing experimental and modeling studies, and it would involve them in the planning of new experimental studies to be conducted in the future. Like the Mont Terri Project, this type of international collaboration goes beyond the mostly modeling focus of DECOVALEX. In contrast to both the DECOVALEX project and the Mont Terri project, which comprise a range of experiments covering a wide spectrum of relevant R&D issues, the CFM has a relatively narrow focus, i.e., colloid-facilitated radionuclide migration. DOE made a decision in early 2012 to formally apply for partnership in the CFM Project. After several administrative and contractual issues had been resolved in the meantime, DOE is now in the process of sending a final letter to CFM confirming that it will join as an official partner. This partnership requires a “membership contribution” of approximately 85K Swiss Francs per year.

3.3.2 Colloid-Facilitated Radionuclide Tracer Test (Focus: NBS)

In February and March 2012, a new colloid-facilitated radionuclide tracer test, designated Test 12-02 (second test in 2012), was conducted in a fracture shear zone at Grimsel. The colloids were derived from FEBEX bentonite, which is mined in Spain and is being considered as a potential waste package backfill material for a Spanish nuclear waste repository. The radionuclides were presorbed onto the colloids to varying degrees, dictated by their sorption to the colloids (probably ~100% sorbed for Pu and Am, ~50% sorbed for U and Np, somewhere in between for fission products Cs and Sr). The tracer cocktail was injected into injection interval CFM 06.002i2 at a target flow rate of ~0.35 mL/min, while water was being continuously

extracted at a rate of 25 ml/min from the Pinkel surface packer at the tunnel wall ~6.1 m from the injection interval (Figure 3-29). The test was initiated by introducing the tracer cocktail into a flow loop that circulated through the injection interval at a relatively high rate to keep the interval well mixed while maintaining a near-constant net injection flow rate into the shear zone. The volume of the vessel containing the tracer cocktail was 2.25 L, and the volume of the injection flow loop was 1.0 L, so the entire injection circuit volume was 3.25 L after the tracer vessel was plumbed into the system. This arrangement resulted in an exponentially decaying source term in the shear zone as the tracers were slowly bled out of the injection circuit. Two previous colloid-facilitated transport tests were conducted in this configuration, but they involved nonradioactive homologues, not radionuclides. Figure 3-32 shows preliminary measurements from the tracer test, depicting the normalized concentrations of tracers (concentrations divided by injection mass) in the water extracted from the Pinkel surface packer as a function of time.

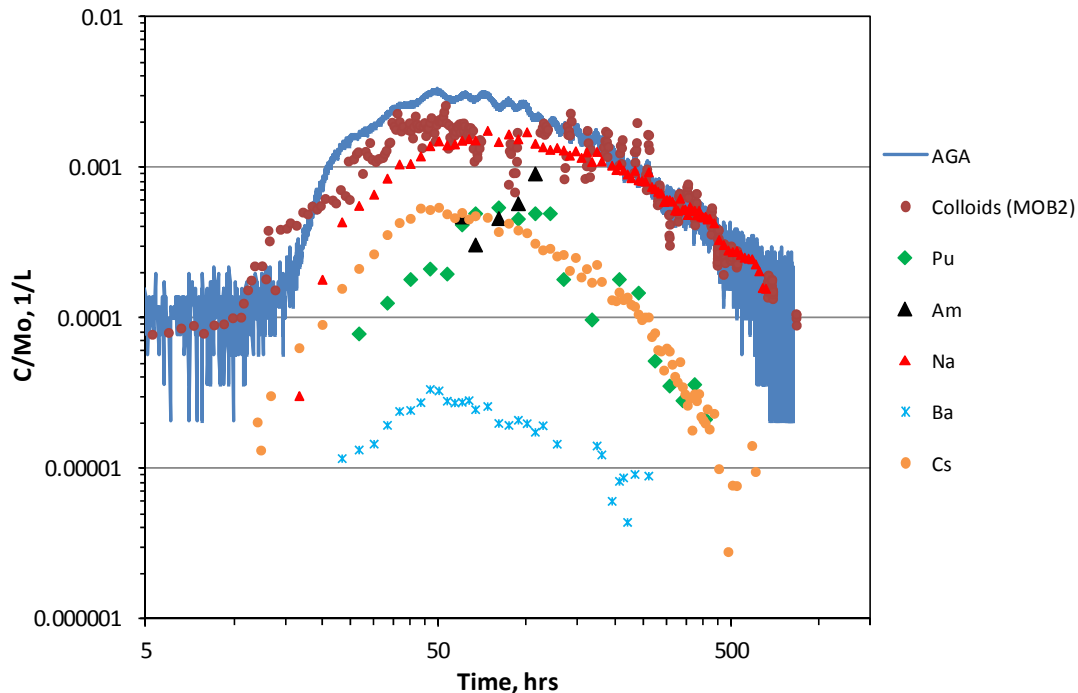

Figure 3-32. Colloid-Facilitated Radionuclide Tracer Test at Grimsel Test Site: Normalized breakthrough curves of all tracers in CFM Tracer Test 12-02 (from Reimus, 2012).

3.3.3 Radionuclide-Doped Bentonite Plug Transport Experiment (Focus: both NBS and EBS)

The next experiment at CFM will involve a bentonite plug (FEBEX backfill material) doped with a suite of radionuclides and emplaced into the CFM 06.002 injection interval used in previous tracer tests (planned for 2013). The exact method for doping the bentonite is still being worked out, but it will probably involve generating doped “pills” that are inserted into small holes drilled into the main bentonite plug at the depth of the fracture zone. Emplacement of the bentonite plug will be followed by long-term monitoring (over several years) of both colloids and radionuclides.

Many of the same radionuclides will be used as in the test described above, but different isotopes will allow the observations from the two tests to be distinguished. The bentonite will be allowed to swell into the fracture zone and erode under the influence of the flow field, while samples are collected at the tunnel wall. The new small boreholes will be instrumented for sampling at very low rates to provide an early indication of swelling and radionuclide release. At the conclusion of the test, these boreholes will be filled with a resin to stabilize the rock mass, and a large-diameter overcore of the entire injection interval. While the primary purpose of this overcoring procedure is to recover the majority of the radionuclide inventory remaining at the source location at the conclusion of the test, this procedure will also enable detailed post-mortem characterizations of bentonite swelling into the fracture shear zone and determination of radionuclide dispositions in the emplacement borehole and shear zone at the end of the test.

3.3.4 Colloid Formation and Migration Summary

Benefits of Participation:

- Access to experimental data from a **suite of past, ongoing and future experiments** on colloid-facilitated migration at Grimsel, more narrow focus than other initiatives (Note that CFM membership does not provide access to other experiments at Grimsel, such as FEBEX, see Section 4.2)
- Opportunity to **participate directly in international research groups that conduct, analyze, and model** migration experiments (more direct involvement than DECOVALEX)
- Opportunity for participating in and steering ongoing or planned experiments as well as **conducting own experiments**

Status of Participation:

DOE has decided to seek membership in the CFM project and has cleared all administrative hurdles to do so. Formal membership is imminent. UFDC researchers are involved in the interpretation and analysis of Test 12-02 and also plan to participate in the upcoming Radionuclide-Doped Bentonite Plug Transport Experiment (Section 5.2).

Contact Information:

DOE Contact:

Jay Jones, DOE-NE (contracts)

Prasad Nair, DOE-NE (R&D)

UFDC Contact:

Jens Birkholzer (LBNL)

Paul Reimus (LANL)

CFM Contact:

Ingo Blechschmidt, Head of Grimsel Test Site, NAGRA, Switzerland

3.4 SKB Task Forces

Another interesting option for international collaboration is to formally join SKB's task forces. SKB, the Swedish Nuclear Fuel and Waste Management Company, has been organizing task forces as a forum for international organizations to interact in the area of conceptual and numerical modeling of performance-relevant processes in natural and engineered systems. The Swedish program, which has always been very active in engaging international partners, welcomes formal participation of DOE scientists in its task forces. SKB has also indicated that DOE engagement in selected URL projects outside of the task force agenda would be welcome.

SKB has two task forces, one for Groundwater Flow and Transport initiated in 1992 (GWFTS Task Force), another for engineered barrier systems initiated in 2004 (EBS Task Force). The GWFTS Task Force is led by Björn Gylling of SKB. The EBS Task Force has two parts, one for THM processes (led by Antonio Gens from UPC in Spain), the other for THC processes (led by Urs Maeder of University of Bern). Different modeling tasks are being addressed collaboratively, often involving experiments carried out at SKB's Äspö Hard Rock Laboratory (HRL) situated in crystalline rock near Oskarshamn in Sweden. The Äspö HRL consists of a main tunnel that descends in two spiral turns to a depth of 460 m, where various tests have been and are being performed in several side galleries and niches (Figure 3-33).

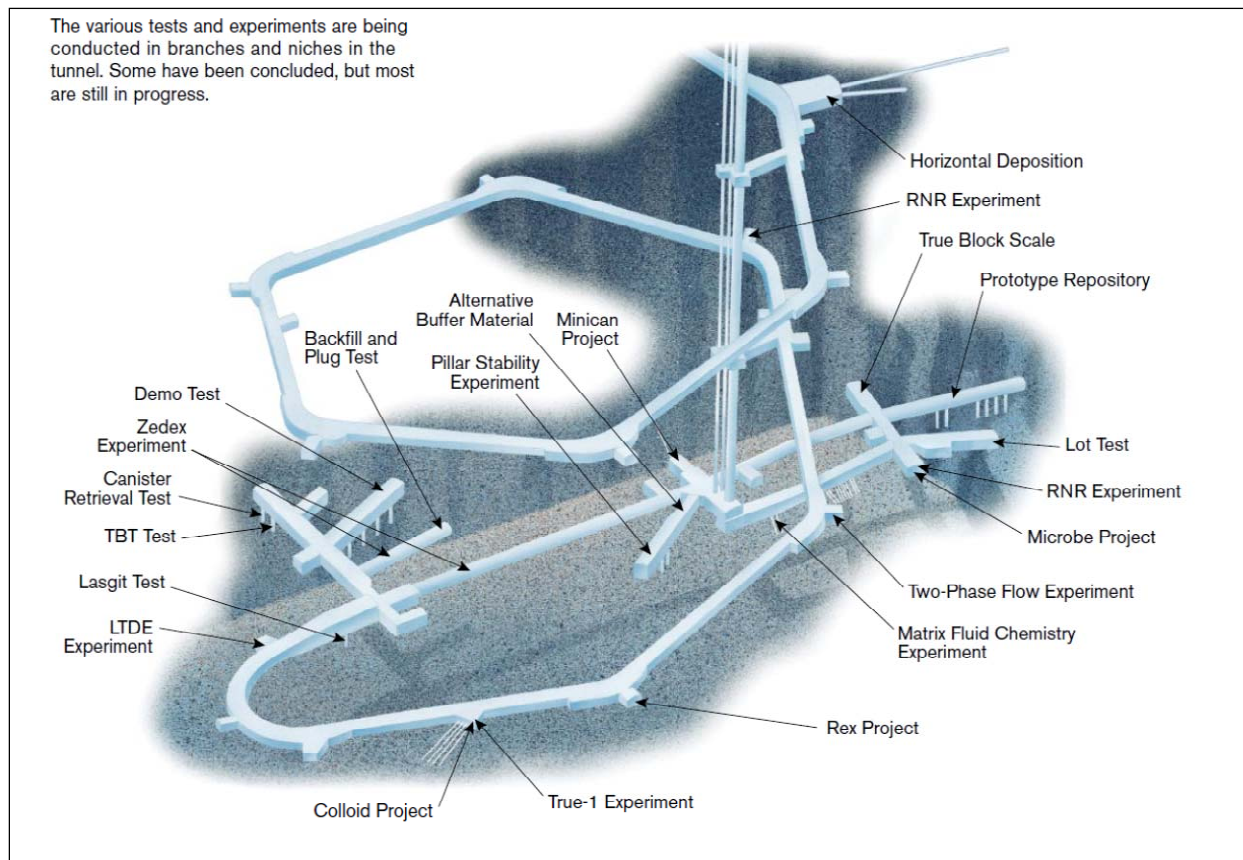

Figure 3-33. Layout of Äspö HRL and location of main experiments

The participating organizations in the GWFTS and EBS Task Forces are SKB, Posiva Oy, CRIEPI, JAEA, NAGRA, FZK/BMWi, NDA, NWMO, and RAWRA. Each participating organization is represented by a delegate; the modeling work is performed by modeling groups associated with these organizations (not unlike the DECOVALEX framework). The task forces meet regularly about once to twice a year. Task force members interact closely with the principal investigators responsible for carrying out experiments at Äspö HRL. Much emphasis is put on building of confidence in the approaches and methods in use for modeling of groundwater flow and migration, as well as coupled THM and THC process, in order to demonstrate their use for performance and safety assessments. Prominent modeling tasks conducted currently are (see more information in Sections 3.4.1 through 3.4.3 below):

GWFTS Task Force:

- Modeling of the Bentonite Rock Interaction Experiment (BRIE) at Äspö HRL (jointly with EBS Task Force)
- Modeling of the Long Term Diffusion Experiment at Äspö HRL

EBS Task Force:

- Modeling of the Bentonite Rock Interaction Experiment (BRIE) at Äspö HRL (jointly with GWFTS Task Force)
- Modeling of one of the two outer deposition holes in the Prototype Repository at Äspö HRL

In the past year, DOE has interacted with SKB representatives to evaluate the condition and benefits of joining one or both task forces. A UFDC representative participated in the GWFTS Task Force meeting in April 24-25, 2012, in Oskarshamn in Sweden. DOE also is considering sending a representative to a joint meeting of the GWFTS and EBS Task Forces to be held in Lund, Sweden, November 27-29, 2012. A decision as to whether DOE would seek formal membership in a task force has not yet been made.

3.4.1 Bentonite Rock Interaction Experiment (BRIE) (Focus: Both NBS and EBS)

The main objective of the ongoing BRIE experiment is to enhance the understanding of the hydraulic interaction between the fractured crystalline rock at Äspö HRL and the unsaturated bentonite used as backfill (SKB, 2011b). The setup is aligned with the Swedish concept of emplacing canisters into vertical deposition holes that are subsequently backfilled (Figures 3-34 and 3-35). The experiment is subdivided into two main parts: the first part describing the selection and characterization of a test site and two central boreholes, the second part handling the installation and extraction of the bentonite buffer. Initial characterization will result in a deterministic description of the fracture network at a small scale (10 m). This includes all identified fractures (DFN) and the water-bearing part of the fractures (Hydro-DFN). BRIE has its focus on the common boundary at the thin interface between the bentonite clay and the water-bearing fractures in the near-field host rock, and as mentioned above, is the focus of a joint modeling effort by the Task Force on Groundwater Flow and Transport and the Task Force on Engineered Barrier Systems.

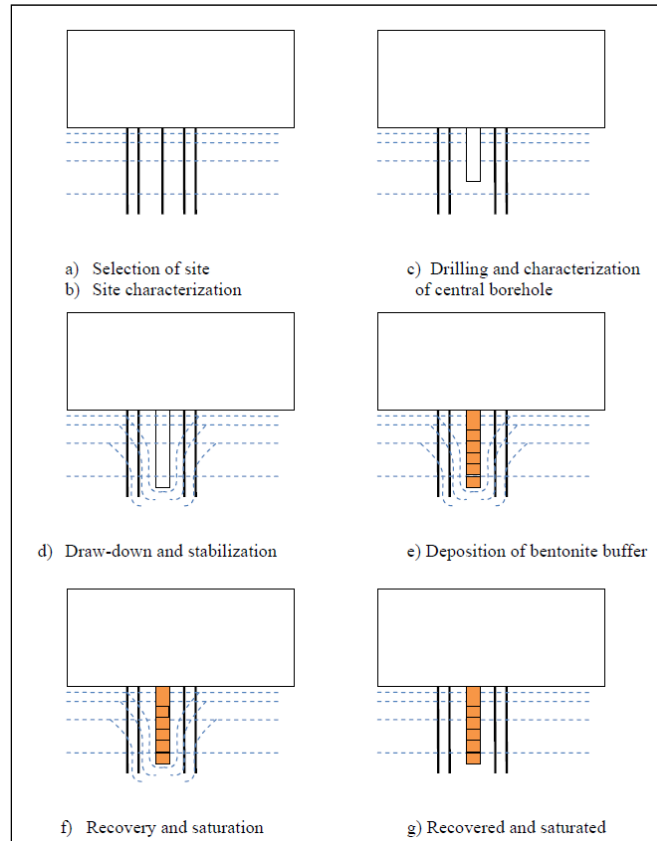

Figure 3-34. Schematic stages of the BRIE Experiment at Äspö HRL (Bockgård et al., 2012)



Figure 3-35. BRIE Experiment at Äspö HRL: The test niche and five boreholes (distance 1.5 m) used for initial characterization and selection of BRIE site (SKB, 2011b)

3.4.2 Long-Term Diffusion Sorption Experiment (LTDE-SD) (Focus: NBS)

The Long-Term Diffusion Sorption Experiment, completed in 2010, is under consideration as a new modeling task in the GWFTS Task Force. The experiment examines diffusion and sorption processes in both matrix rock and a typical conductive fracture identified in a pilot borehole. A telescoped large-diameter borehole was drilled sub-parallel to the pilot borehole in such a way that it intercepts the identified fracture some 10 m from the tunnel wall, and with an approximate separation of 0.3 m between the circumferences of the two boreholes (Figure 3-36). A cocktail of non-sorbing and sorbing tracers was circulated between the boreholes in packed-off sections for a period of 6 ½ months, after which the borehole was overcored and the extracted rock analyzed for tracer penetration and fixation. The specific objectives of LTDE-SD were to:

- Obtain data on sorption properties and processes of individual radionuclides on natural fracture surfaces and internal surfaces in the rock matrix.
- Investigate the magnitude and extent of diffusion into matrix rock from a natural fracture *in situ* under natural rock stress conditions and hydraulic pressure and groundwater chemical conditions.
- Compare laboratory-derived diffusion constants and sorption coefficients for the investigated rock fracture system with the sorption behavior observed *in situ* under natural conditions, and to evaluate whether laboratory-scale sorption results are representative also for larger scales.

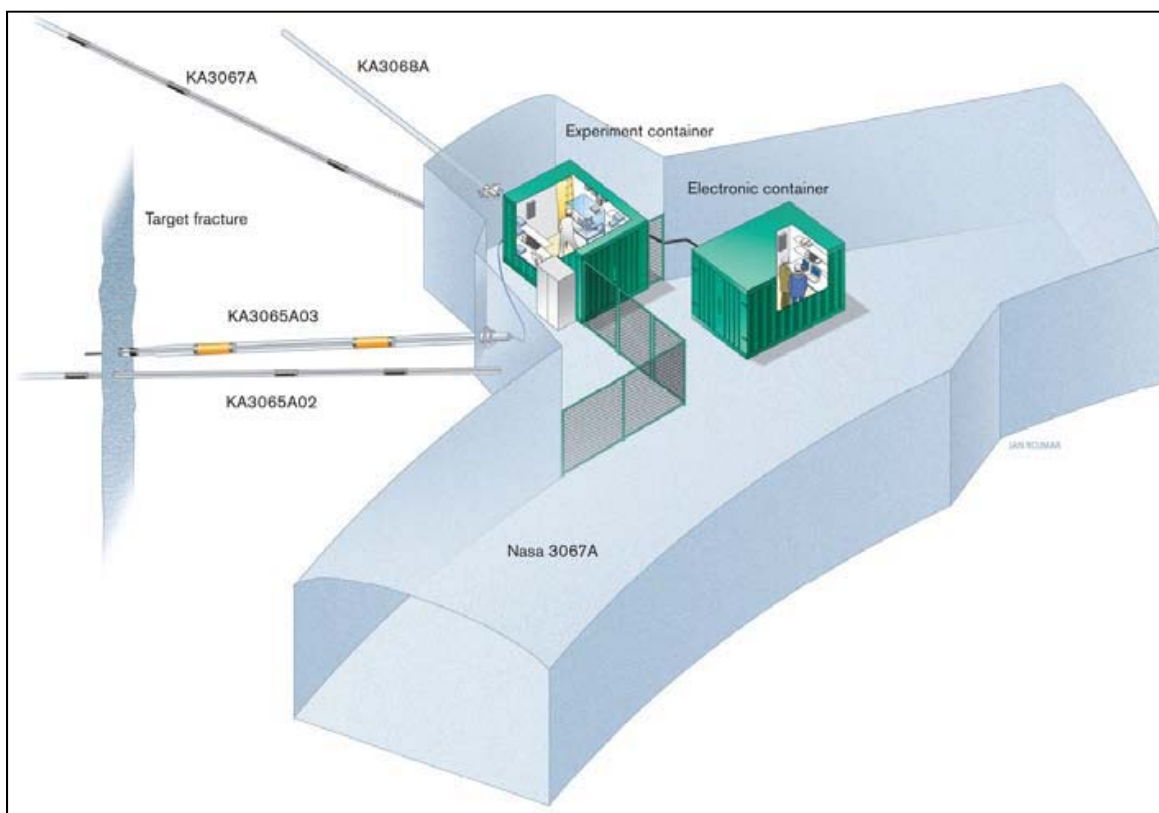

Figure 3-36. Schematic setup of LTDE-SD at Äspö HRL (SKB, 2011a)

3.4.3 Prototype Repository (Focus: Mostly EBS, also NBS)

In 2000, SKB started planning and installation of a so-called Prototype Repository as a full-scale demonstration of the integrated function of the repository, and a reference for testing predictive models concerning individual components as well as the complete repository system. The test area is located in the innermost section of the TBM-tunnel at the -450 m level. The layout involves a total of six deposition holes, four in an inner and two in an outer section- see Figure 3-37. Canisters with dimension and weight according to the current plans for the final repository and with heaters to simulate the thermal energy output from the spent nuclear fuel have been positioned in the holes and surrounded by bentonite buffer. The deposition holes were placed with a center distance of 6 m. This distance was evaluated considering the thermal diffusivity of the rock mass and the maximum acceptable temperature of the buffer. The deposition tunnel was backfilled with a mixture of bentonite and crushed rock (30/70). A massive concrete plug, designed to withstand full water and swelling pressures, separates the test area from the open tunnel system, and a second plug separates the two sections. This layout provides two more or less independent test sections. The monitoring system is comprised of a dense network of sensors for temperature, total pressure, pore-water pressure, relative humidity and resistivity, as well as some rock mechanical measurements. The heaters of the inner section were turned on in 2001, those in the outer section in 2004. This was followed by several years of monitoring, offering a very valuable data set of early-stage, full-scale repository evolution.

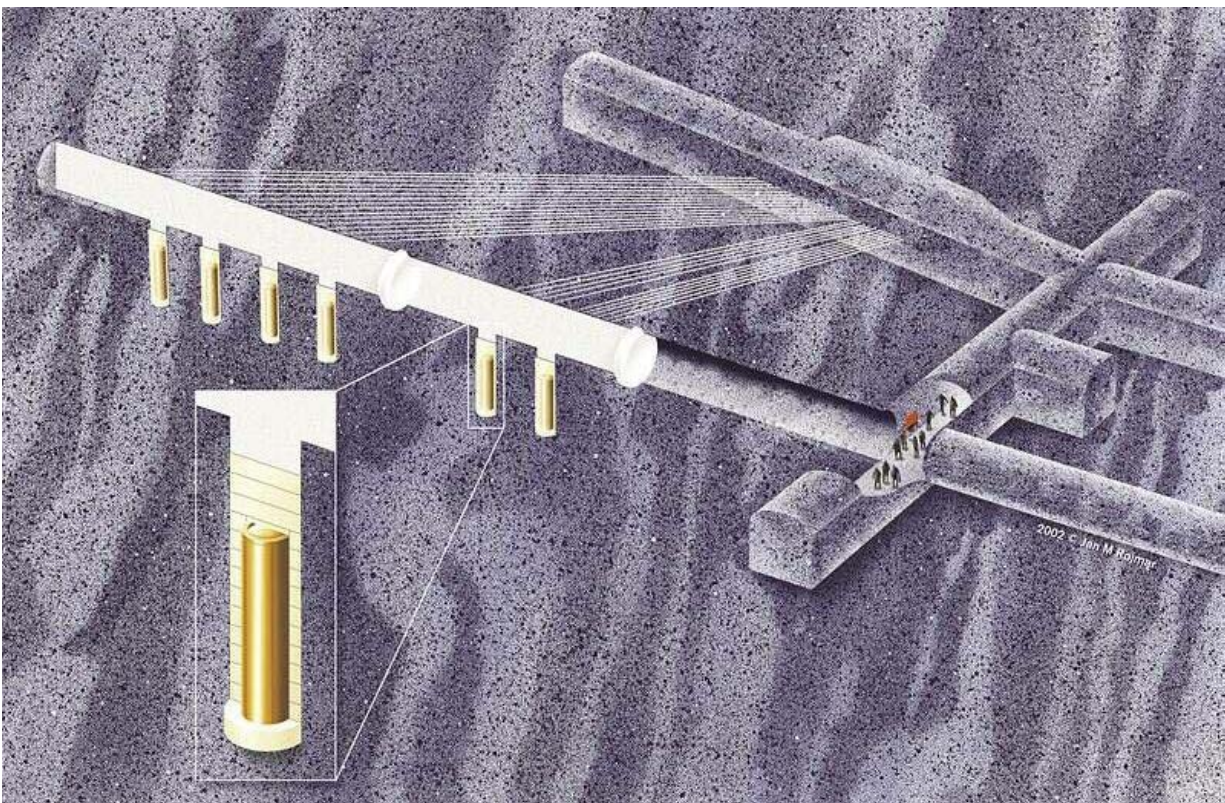

Figure 3-37. Schematic layout of Prototype Repository at Äspö HRL (SKB, 2011a, 2011b)

In 2011, SKB excavated the outer section of the Prototype Repository while extensive samplings were performed. Approximately 1,000 samples on the backfill and about 3,000 samples on the buffer were taken to determine water content and density. The two canisters were lifted up and transported to SKB's Canister Laboratory in Oskarshamn for additional investigations. The main objectives of dismantling the outer section were to (1) investigate the density and water saturation of the buffer and backfill, (2) investigate the interface between buffer – backfill and between backfill – rock surfaces, after 7 years of wetting, (3) measure and examine the canisters (positions, mechanical stress, corrosion), (4) investigate the bedrock after dismantling, (5) study biological and chemical activities in the buffer and backfill, and (6) study possible changes of the buffer material caused by temperature and saturation processes. The observations made in one of the excavated deposition holes (Figure 3-38) are the focus of one modeling task of the EBS Task Force, the objective being to verify the THM processes occurring during heating and resaturation, and validation against the post-mortem analysis.

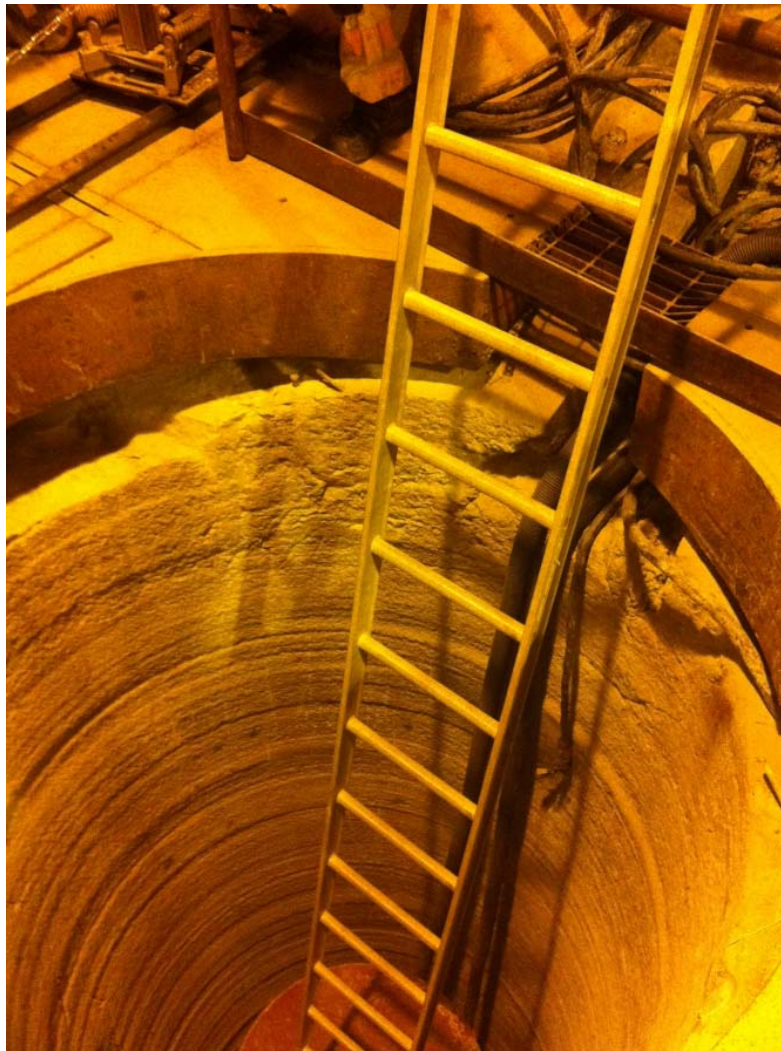

Figure 3-38. Prototype Repository at Äspö HRL: Photo of excavated deposition hole

3.4.4 Large-Scale Gas Injection Test (LASGIT) (Focus: Mostly EBS)

This ongoing field experiment, which has been in operation for over five years, evaluates gas flow processes (related to the potential for gas generation from canister corrosion) in an unsaturated bentonite embedded in fractured crystalline rock. Current knowledge pertaining to gas flow in a compact saturated bentonite is based on small-scale laboratory studies; the LASGIT tests are designed to address specific issues relating to gas migration and its long-term effect on the hydro-mechanical performance of the buffer clay, the question of heterogeneity and tortuosity of flow paths and the possible generation of new flow paths, and the complex coupling between gas, stress, and pore-water pressure at different scales (Figure 3-39). The main organization conducting the experiment is SKB (Sweden), together with the British Geological Survey (BGS). The LASGIT experiment was initially proposed as a modeling test case for DECOVALEX-2015, but is not under consideration anymore. It is also not currently under consideration in the two task forces; however, if DOE had a vital interest in this experiment, SKB and BGS may be open to collaboration with or participation of UFDC scientists.

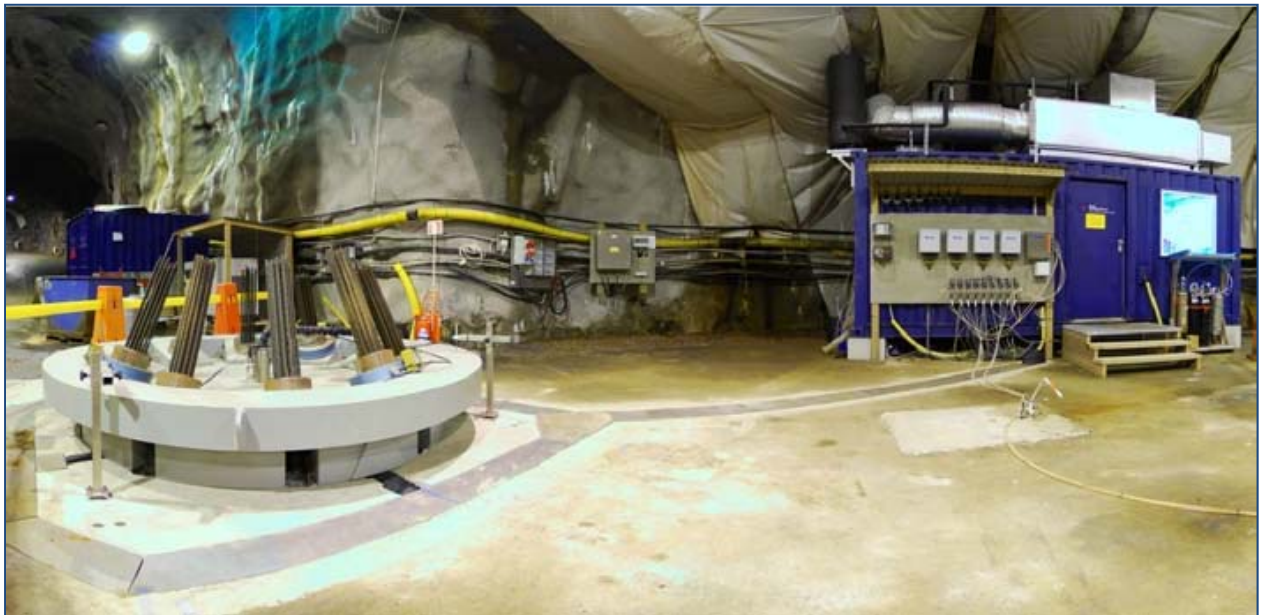

Figure 3-39. LASGIT Experiment at Äspö HRL (from Cuss, 2010)

3.4.5 SKB Task Force Summary

Benefits of Participation:

- Access to **several** sets of experimental data from **one** URL in crystalline rock
- Opportunity to perform **modeling and analysis of existing data** in collaboration with other modeling groups (typically less direct interaction with the project teams that run or interpret the experiments)
- **No opportunity** for influencing, proposing, or conducting own experiments

Status of Participation:

DOE has made inquiries about benefits and conditions of participation, and has sent a representative to a GWFTS Task Force meeting, but no decision has been made as of yet about whether to seek formal membership.

Contact Information:

DOE Contact:

Jay Jones, DOE-NE (contracts)

Prasad Nair, DOE-NE (R&D)

UFD Contact:

Jens Birkholzer, LBNL

Scott Painter, LANL

SKB Contact:

Anders Sjöland, Executive Secretary, Technical-Scientific Council, SKB, Sweden

Björn Gylling, Secretary of GWFTS Task Force, SKB, Sweden

Antonio Gens, EBS Task Force for THM, from UPC, Spain

Urs Maeder, EBS Task Force for THC, University of Bern, Switzerland

3.5 Overview of International Cooperative Initiatives and Participating Countries

Table 3-2 provides a quick overview of the four international cooperative initiatives discussed above, and lists the international waste disposal organizations currently participating in those, sorted by country. The table demonstrates the high level of cooperation between nuclear nations. Note that many European nations also collaborate closely in European Union projects (e.g., TIMODAZ, FORGE, LUCOEX).

Table 3-2. Participation of International Programs in Cooperative Initiatives Related to URLs: Status 2012

Nuclear Nation	Organizations	DECOVALEX	Mont Terri	CFM	SKB Task Forces
Belgium	SCK-CEN		x		
Canada	NWMO		x		x
Czech Republic	RAWRA	X			x
China	CAS	x			
France	ANDRA IRSN	X	x x		
Finland	POSIVA OY	(x)		x	x
Germany	BGR GRS FZK/BMWi	x	x x	x	x x x
Great Britain	NDA	X			x
Japan	JAEA CRIEPI Obayashi	X	x x	x x	x x
Korea	KAERI	x		x	x
Spain	ENRESA		x		
Sweden	SKB	(x)		x	X
Switzerland	NAGRA ENSI		X x	X	x
United States	DOE NRC	x x	x	x	

Note: Capital bold X denotes program that leads a field experiment or serves as POC.

4. BILATERAL COLLABORATION OPPORTUNITIES

Access to data from international field experiments and participation of UFDC researchers in collaborative field studies may also be facilitated via direct informal or semi-formal agreements between national laboratories and international partners. Several UFDC scientists have close relationships with their international counterparts, resulting from workshops and symposia meetings, or from collaboration outside of UFDC's scope. International disposal programs are aware of the technical capabilities of UFDC scientists and are generally quite open to including them in their ongoing research teams. This may or may not require MoUs or other types of bilateral agreements.

Note that DOE's Office of Civilian Radioactive Waste Management (OCRWM) had been the DOE sponsor for several MoUs. With OCRWM dismantled as an organization and its responsibilities transferred to DOE's Office of Nuclear Energy, the question arises if these MoUs are still legally active. Examples of such historical MoUs include agreements with Belgium's ONDRAF, Finland's Posiva Oy, Japan's NUMO and JAEA, Sweden's SKB, and Switzerland's NAGRA.

Below is a short list of selected major (soon-to-start or planned) field experiments conducted by international disposal programs that are open to national laboratory participation, without requiring "membership fees" or other long-term commitments on behalf of DOE. This list will be amended and updated as new opportunities arise.

4.1 Experiments at HADES URL in Mol, Belgium

The HADES (High Activity Disposal Experimental Site) URL is located in a secured area belonging to one of Belgium's nuclear power plants, which also hosts other nuclear research facilities. HADES is essentially a several-hundred-meter-long tunnel in the soft Boom Clay rock formation, accessible by two shafts located at each end (Figure 4-1). The tunnels were drilled in stages, starting with a first section in 1982, followed by additions in 1987 and 2001. Each of these sections was secured with different types of ground support, reflecting increased knowledge about the structural behavior of the host rock. Most interesting to DOE's program is probably the upcoming PRACLAY heater experiment, and to a lesser degree ongoing clay diffusion experiments, both of which are discussed in more detail below. The Belgium organizations involved in conducting and interpreting these experiments (SCK-CEN, EIG Euridice, ONDRAF/NIRAS) have long-standing relationships with DOE/UFDC scientists; they are open to participation of UFDC research groups and have already invited researchers to provide THM modeling expertise to the PRACLAY project team.

4.1.1 PRACLAY Test (Focus: mostly NBS, some EBS)

The PRACLAY Heater Test is a full-scale validation and confirmation experiment to be conducted at the HADES URL, excavated at 223 m depth in Boom Clay, a tertiary clay formation in Mol, Belgium. The heater test, which will begin in late 2012 or early 2013, will involve heating a 30 m gallery section for 10 years with many monitoring sensors (Figures 4-2, 4-3, and 4-4), for the purpose of investigating the thermo-hydro-mechanical (THM) behavior of

near-field plastic clay under the most “mechanically critical” conditions that may occur around a repository (Van Marcke and Bastiaens, 2010). For plastic clay under the influence of temperature change, these are undrained conditions, which then generate a higher pore-pressure increase and a higher possibility of near-field damage. For this objective, a hydraulic seal has been installed at the intersection between the planned heated and unheated sections of the gallery. This installation makes up the Seal Test, which was initiated in 2010, and allows for testing the functionality of the hydraulic seal under heated repository conditions.

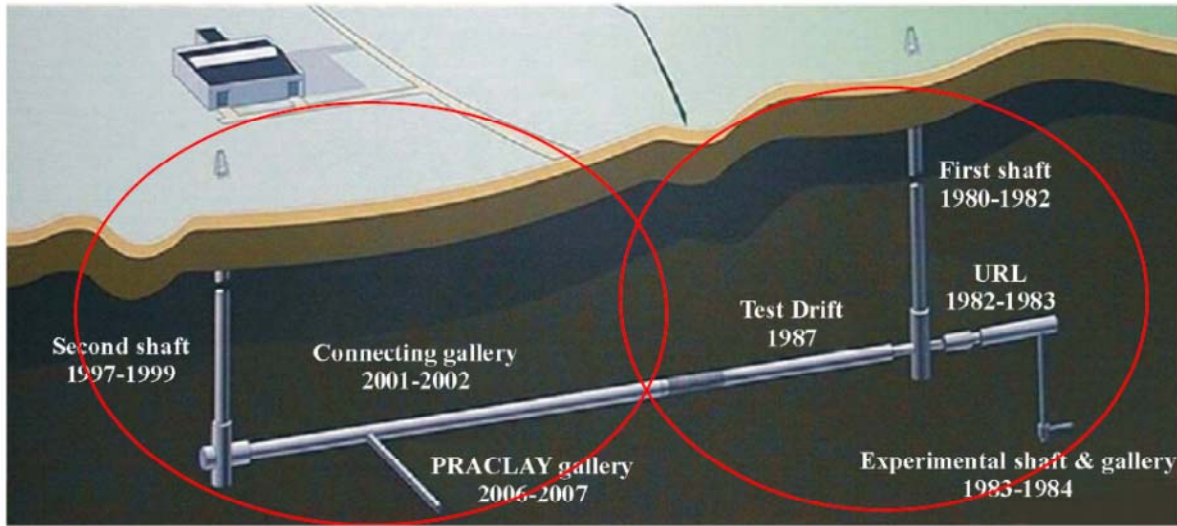

Figure 4-1. Layout of the HADES URL in Mol, Belgium (from Li, 2011)

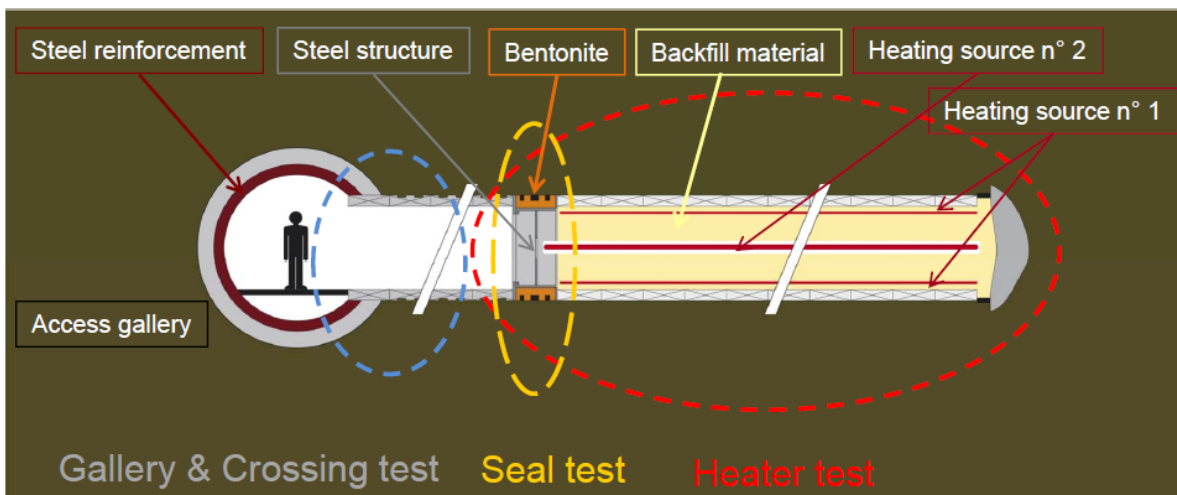

Figure 4-2. Layout of the PRACLAY *In Situ* Experiment at HADES URL (from Li, 2011)

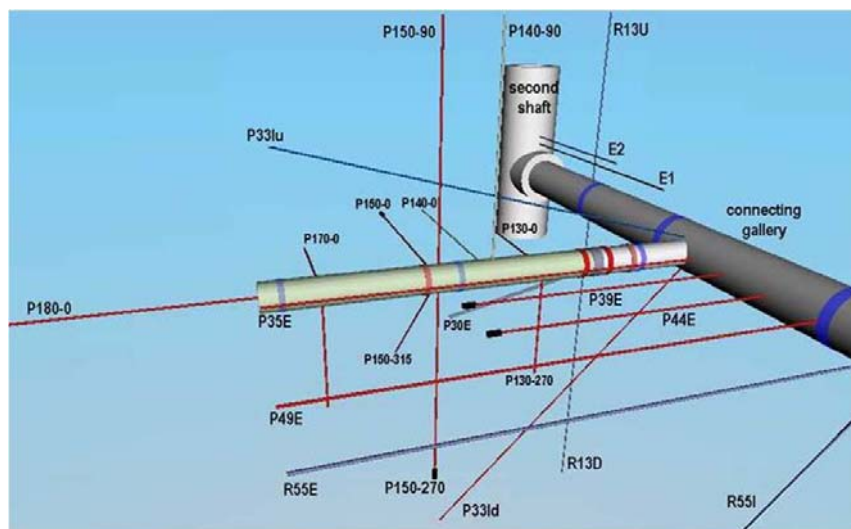

Figure 4-3. PRACLAY *In Situ* Experiment at HADES URL: Configuration of boreholes for pressure, stress, displacement, and water chemistry measurements (from Li, 2011)

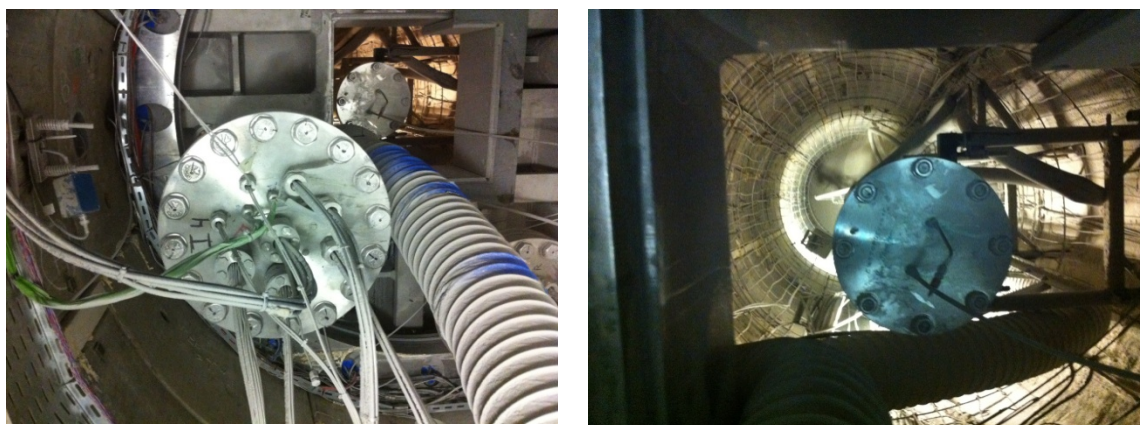

Figure 4-4. PRACLAY *In Situ* Experiment at HADES URL: Photo on left shows hydraulic seal from the outside, with an access hole to the right which soon will be closed. Photo on right was taken from access hole into the heater gallery section, which is currently being backfilled.

4.1.2 Radionuclide Migration Experiments (Focus: NBS)

The Belgium waste management program has been conducting a suite of long-term radionuclide migration *in situ* experiments in dense clays at their HADES URL near Mol. Two of these experiments, named CP1 (Figure 4-5) and Tribicarb-3D, have been ongoing for 23 and 16 years, respectively, and offer valuable data on the slow diffusion-controlled migration of radionuclides in clay rock. Because of their duration, they offer unique test cases for model and process validation. Recently, two other ongoing large-scale migration experiments were initiated at HADES. The TRANCOM test involves colloid transport with C-14 labeled humic substances.

The RESEAL shaft seal experiment investigates transport of iodine-125 through the disturbed zone and the interface between Boom Clay and bentonite.

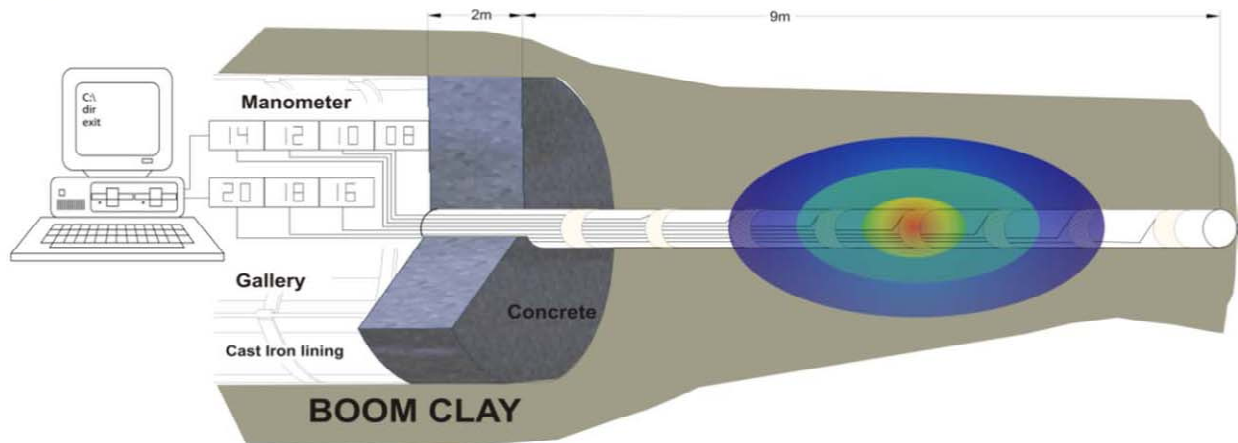

Figure 4-5. Schematic of CP1 Diffusion Experiment at HADES URL (from Maes et al., 2011)

4.2 Experiments at Grimsel Test Site, Switzerland

Besides the Colloid Formation and Migration Project (Section 3.3), other collaborative projects being conducted at the Grimsel Test Site (GTS) might be of interest to DOE/UFDC; for example, the ongoing Full-scale Engineered Barriers (FEBEX) experiment and Gas-Permeable Seal Test (GAST) experiments (further described below). As mentioned before, the Grimsel Test Site is a URL situated in sparsely fractured crystalline host rock in the Swiss Alps (Figure 4-6). NAGRA, which manages the GTS activities, has expressed that it would be open for UFDC scientists to participate in aspects of these experiments, without requiring formal project partnership and without asking for a “membership” fee. Also worth considering may be other GTS projects (that are not further explained in this report), such the (1) the Long-Term Cement Studies (LCS) project (Focus: EBS), which has the overall aim to increase understanding of the cement leachate interaction effects in the repository near field and geosphere, the (2) the Long-Term Diffusion (LTD) project (Focus: NBS), which has the overall aim to provide quantitative information on matrix diffusion of radionuclides in fractured rock under *in situ* conditions over long time scales, and (3) the experiments on gas production and migration conducted within the European Union project FORGE (Fate of Repository Gases). The possibility of participation, and the conditions of being involved in these latter three projects, requires further clarification.

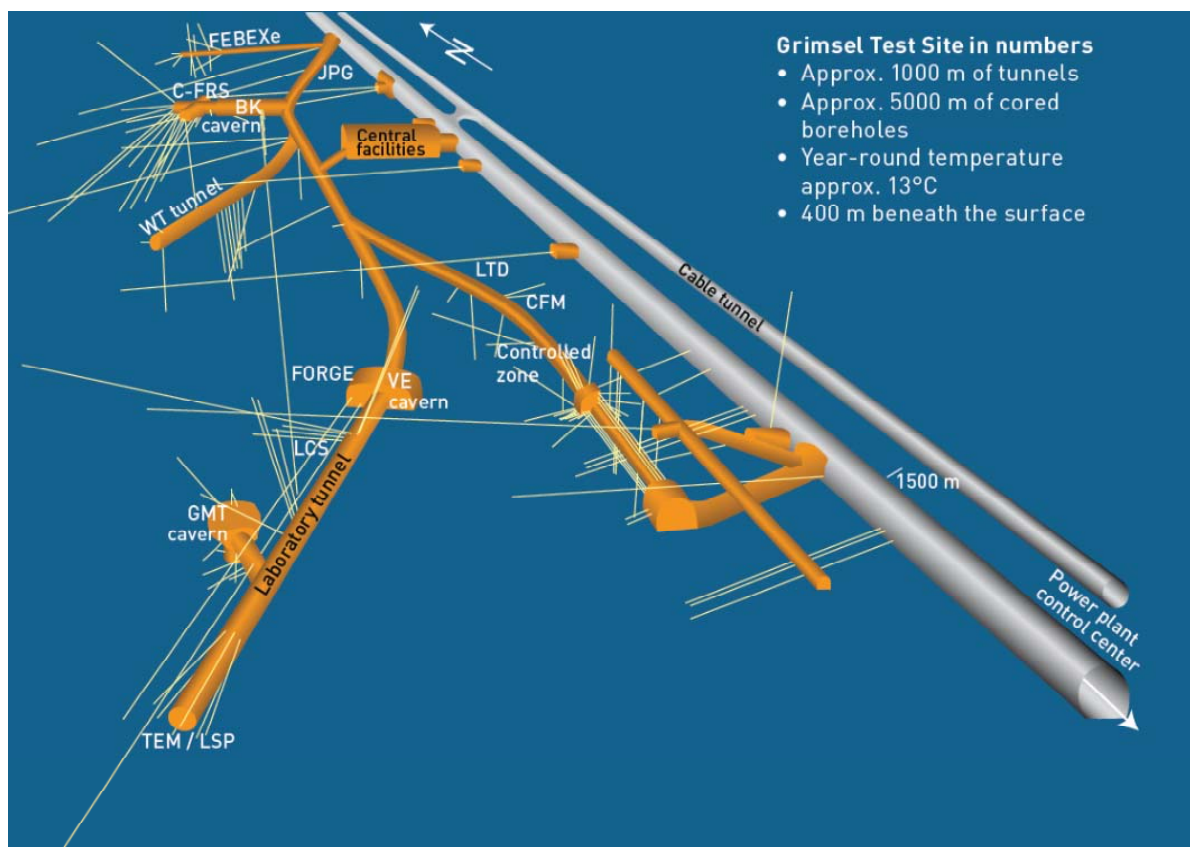

Figure 4-6. 3D view of layout of the Grimsel Test Site in Switzerland (NAGRA, 2010).

4.2.1 Full-Scale Engineered Barriers Experiment (FEBEX) (Focus: Mostly EBS)

FEBEX is a full-scale Engineered Barrier System (EBS) test performed under natural conditions (Figures 4-7 and 4-8). The overall objective is to evaluate the long-term performance of the EBS and, to a lesser degree, the near-field crystalline rock, with emphasis on the thermal evolution and resaturation of bentonite backfill surrounding a heated waste package. With heating started in 1997, the FEBEX experiment is the longest running full-scale heater experiment in the world, providing a unique data set for the transient behavior of a heated repository. A fixed temperature of 100°C has been maintained at the heater/bentonite contact during this time, while the bentonite buffer has been slowly hydrating with the water naturally coming from the rock. A total of 632 sensors of diverse types were installed in the clay barrier, the rock mass, the heaters and the service zone to measure the following variables: temperature, humidity, total pressure, displacement, and pore-pressure.

Partial dismantling of the *in situ* test was carried out during 2002, after five years of heating. One of the two heaters was removed and the materials recovered (bentonite, metals, instruments, etc.) have been analyzed to investigate the different types of processes undergone, while the second heater continued. The samples recovered from this first heater experiment provide valuable information on the long-term condition of heated EBS materials. The second heater has been kept in operation; excavation of the second heater is planned, but a date has not been set at the time of writing this report.

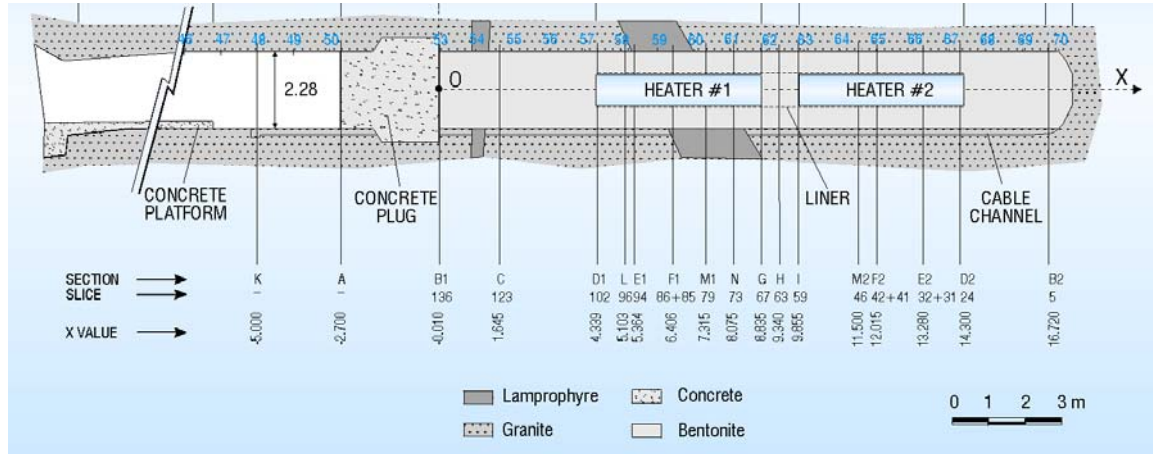

Figure 4-7. Schematic cross section of the FEBEX Test at Grimsel Test Site (based on Birkholzer et al., 2012).



Figure 4-8. FEBEX Test at Grimsel Test Site: Photos taken during the construction phase of the FEBEX test.

4.2.2 Gas-Permeable Seal Test (GAST) (Focus: EBS)

The objective of the ongoing GAST experiment is to demonstrate the construction and performance of repository seals and plugs, and to improve the understanding and the base datasets for reliably predicting water and gas transport through these sealing systems. The experiment will test a specific design option called “engineered gas transport system (EGTS)” (Figure 4-9), which involves specially designed backfill and sealing materials such as high-porosity mortars or sand/bentonite (S/B) mixtures. The reason to develop these special designs is to enable increased gas- transport capacity (to mitigate pressure buildup from gas generation) within the backfilled underground structures, without compromising the radionuclide retention capacity of the engineered barrier system. The main objectives of the Gas-Permeable Seals Test (GAST) are:

- Demonstration of the effective functioning of gas-permeable seals at realistic scale and with realistic boundary conditions ('proof of concept')
- Validation and, if necessary, improvement of current conceptual models for the re-saturation and gas-invasion processes into S/B seals
- Determination of up-scaled gas/water permeabilities of S/B seals (i.e., two-phase flow parameters for large-scale models)

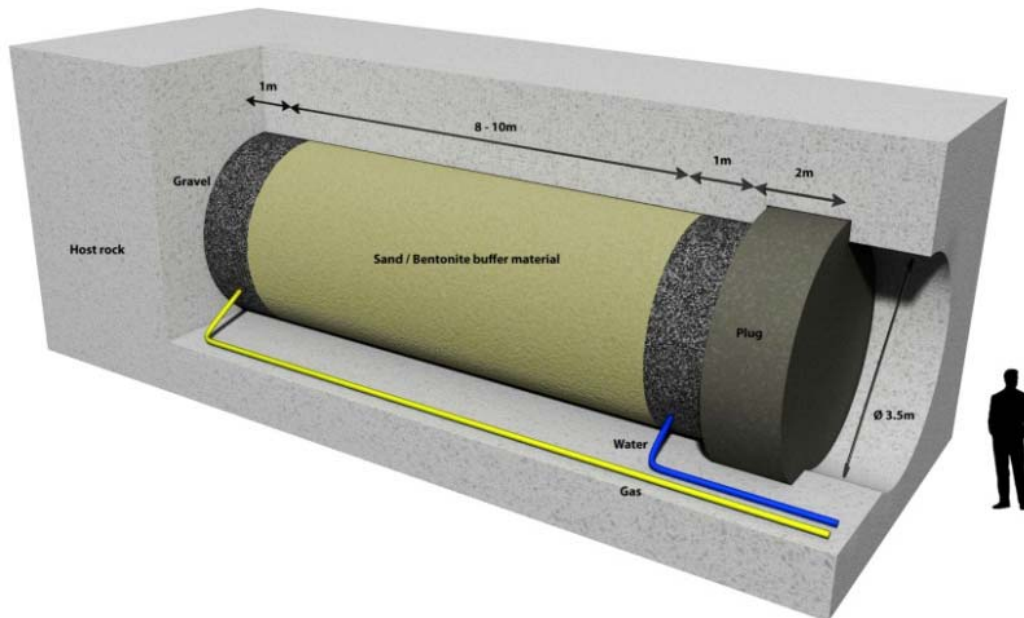

Figure 4-9. GAST Experiment at Grimsel Test Site: Schematic picture of repository seal design with 8-10 m long sand/bentonite plug in between two gravel packs and a concrete plug for reinforcement (from <http://www.grimsel.com/gts-phase-vi/gast/gast-introduction>).

4.3 Experiments at KURT URL, Korea

KURT is a generic underground research laboratory hosted by a shallow tunnel in a granite host rock, located in a mountainous area near Daejeon, Republic of Korea. KURT stands for KAERI Underground Research Tunnel, with KAERI being the Korea Atomic Energy Research Institute. Using KURT, KAERI intends to obtain information on the geological environment and the behavior and performance of engineered barriers under repository conditions. KURT has a total length of 255 m with a 180 m long access tunnel and two research modules with a total length of 75 m. The maximum depth of the tunnel is 90 m from the peak of a mountain. The horseshoe shape tunnel is 6 m wide and 6 m high (Figure 4-10). The tunnel construction at KURT started in March 2005 and was completed in November 2006.

Compared to other URLs, including those discussed in Section 3 and Section 4 above, KURT is a relatively new facility that is just starting to ramp up. Currently, KAERI has planned or is in the process of conducting the following tests: (1) geological investigations, (2) solute migration experiments, (2) EDZ characterization, (3) borehole heater tests, (4) long-term monitoring, (5)

tracer tests, and (6) redox chemistry tests. KAERI is also in the process of expanding the research modules to include a major fracture zone for flow and tracer testing. More evaluation is needed to understand whether close collaboration with KAERI on above ongoing or future experiments at KURT offers R&D benefits that other URLs with more mature testing history do not provide. On the positive side, the geology of the site is well characterized, and the tunnel and borehole facilities are well developed. More importantly, KAERI is very open for collaboration and is looking for new ideas and experimental designs for future tests, which makes it possible for UFDC to push for specific experiments.

The KURT site offers one unique feature with regards to deep borehole disposal R&D. The site hosts an existing deep (1 km) borehole in granitic bedrock, which provides a unique site for testing and developing deep-borehole disposal concepts. The deep borehole is suitable for *in situ* hydrological and geochemical testing and related technique development. KAERI is also interested in the deep borehole disposal concept, which could offer further collaboration opportunities.

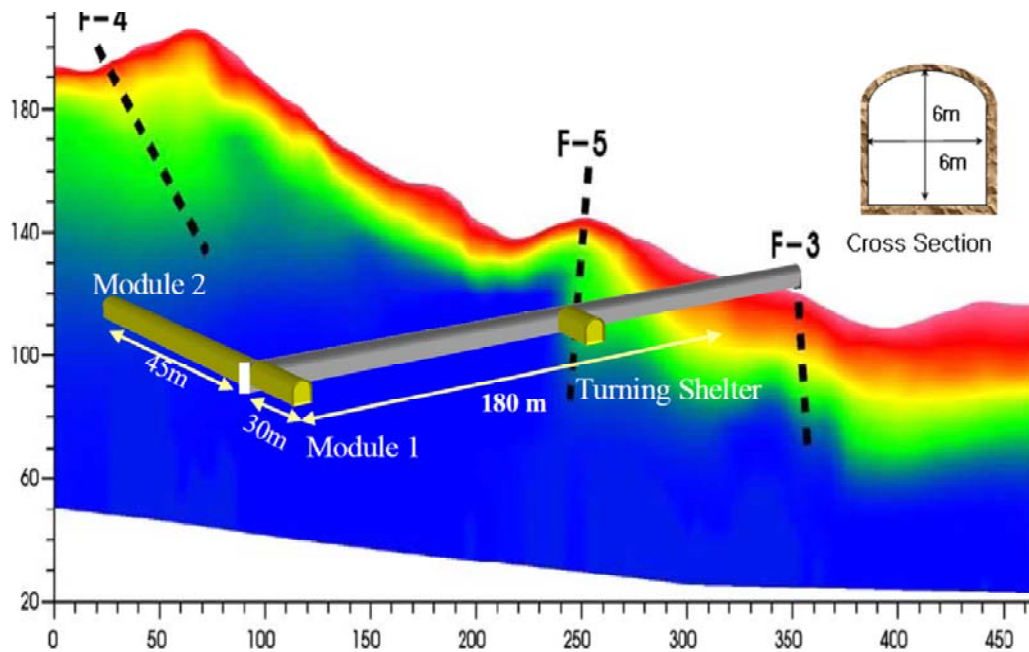

Figure 4-10. Layout of the KURT URL in Daejeon, Korea (KAERI, 2011)

A formal commitment to collaboration on the management of nuclear fuel was recently established between the United States and the Republic of Korea (ROK). The agreement, named Joint Fuel Cycle Studies (JFCS) between the US Department of Energy, the ROK Ministry of Education, Science & Technology, and the ROK Ministry of Knowledge Economy, focuses mainly on three areas (electrochemical recycling, safeguards, and fuel cycle alternatives), but could likely be expanded to disposal system R&D.

4.4 Other URL Opportunities

There are potential collaboration opportunities related to other international URLs (see Table 2-1). For example, opportunities for active collaborative R&D with Japan may not only exist at the Horonobe site (see Section 3.1.5), but also at this nation's second URL at the Mizunami Underground Research Laboratory, which resides in crystalline rock (Figure 4-11). Japan and the United States entertain close collaboration in issues related to nuclear energy under the JNEAP (Joint U.S.–Japan Nuclear Energy Action Plan) agreement. JNEAP has a Waste Management Working Group that used to meet in regular intervals to discuss joint R&D on, among other topics, waste disposal issues. However, no meetings have been scheduled since the last working group meeting in August 2010, due to the refocusing of the Japanese program after the Fukushima incident.

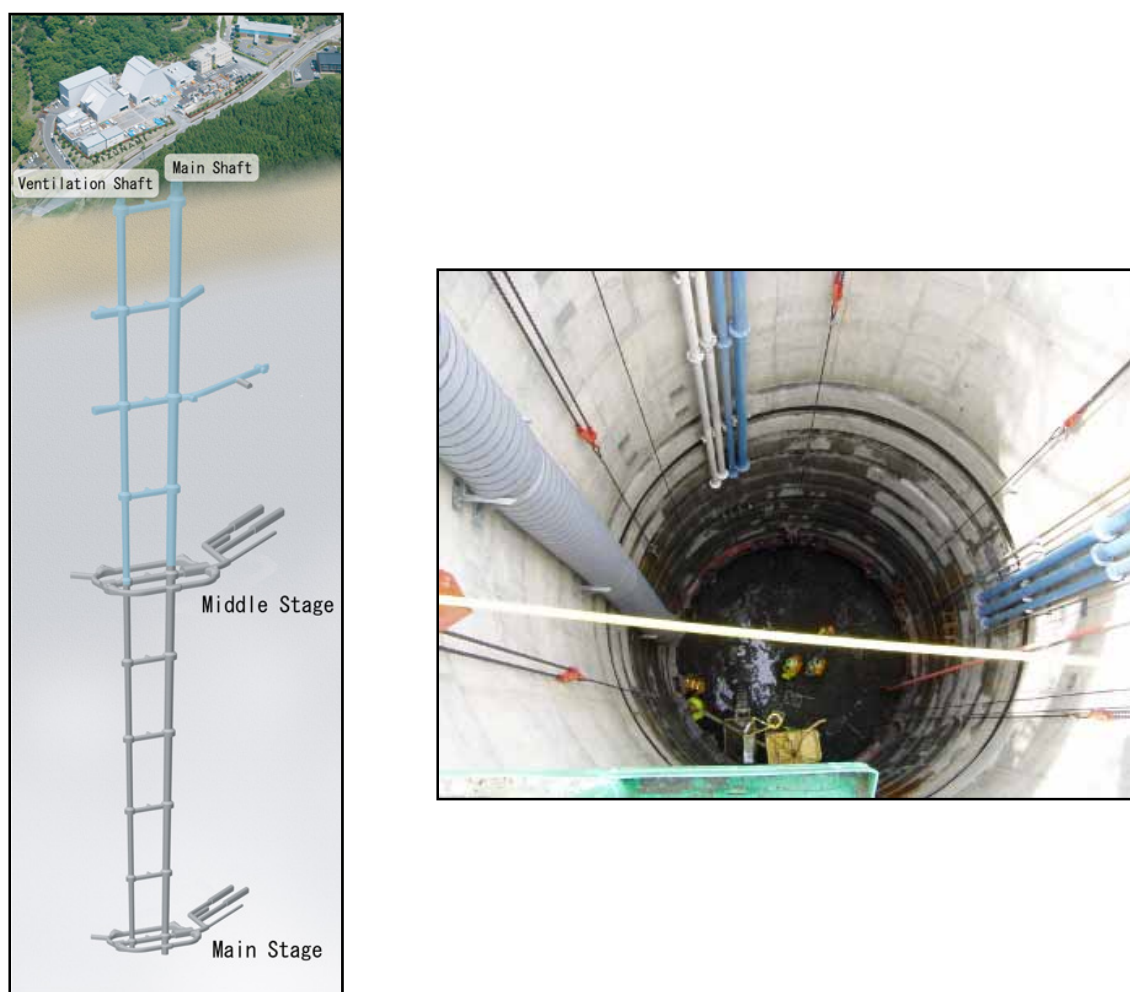

Figure 4-11. Layout of the Mizunami Underground Research Laboratory in Japan, and photo of tunnel shaft construction (from http://www.jaea.go.jp/04/tono/miu_e/)

DOE scientists and their German colleagues in academia and other research laboratories collaborate closely on various R&D issues related to disposal of radionuclide waste in salt. A

MoU was recently signed between DOE and the German Federal Ministry of Economics and Technology (BMWi) to cooperate in the field of geologic disposal of radioactive wastes (MoU date: November 2011). The focus of cooperation activities is disposal of waste in salt formations. A US-German Salt Repository workshop was held November 9 and 10, 2011, in Peine, Germany, to explore collaboration opportunities. Both countries intend to advance salt repository science together in a number of areas, such as TM(H) modeling, reconsolidation of salt, safety case strategy, and seal design.

Regarding an underground research laboratory in salt, Germany started in 1979 to conduct exploration work at the Gorleben salt dome to evaluate its suitability for waste disposal (Figure 4-12). A moratorium on further exploration at the Gorleben site was imposed in 2000, mainly due to political controversy. While the moratorium has recently been lifted, R&D activities at Gorleben have not yet resumed, and it is questionable whether and when further underground testing at this URL might be conducted, and whether active R&D participation of U.S. scientists in experimental work at Gorleben would offer benefits to UFDC.



Figure 4-12. View of one of the underground tunnels at Gorleben site at the 840 m level (from BMWi, 2008)

There are also the two URLs near Onkalo in Finland (crystalline) and near Bure in France (clay/shale). The Onkalo URL in Finland is located at a site chosen to potentially host a repository. Thus it is not only an underground research laboratory, but also an underground characterization facility. It is being constructed in crystalline bedrock to the anticipated repository depth of 430–440 m. Construction began in 2004 and is ongoing, but actual underground tests were already started in 2007. Figure 4-13 shows the layout of the URL, with an access tunnel and three shafts. The access tunnel takes the form of a spiral on an approximately 1 in 10 incline downward, and it has reached the technical facilities level at about 437 m. The three shafts consist of one personnel shaft and two ventilation shafts; they have reached a depth of about 290 m. Details may be found in Posiva (2011) and Aalto et al. (2009).

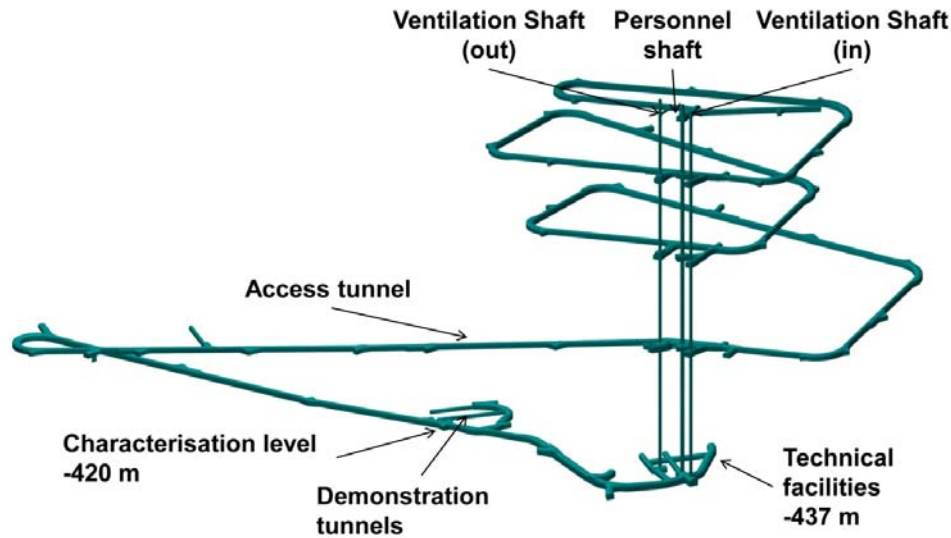

Figure 4-13. Layout of the Onkalo URL in Finland (from Äikäs, 2011)

The major underground disposal research facility in France is ANDRA’s LSMHM URL sited at Bure in the Meuse district. Like the Onkalo URL in Finland, the Bure site is a location that could potentially host a repository. R&D at Bure aims at studying the feasibility of the reversible geological disposal of high-level and long-lived intermediate-level radioactive waste in the Callovo-Oxfordian clay formation. This facility was licensed in August 1999, and its construction (access shafts, basic drift network with underground ventilation) was finalized in 2006. More drifts and niches are due to be excavated in future years, for ongoing geological surveys and experimental programs, or engineering technological demonstrations.

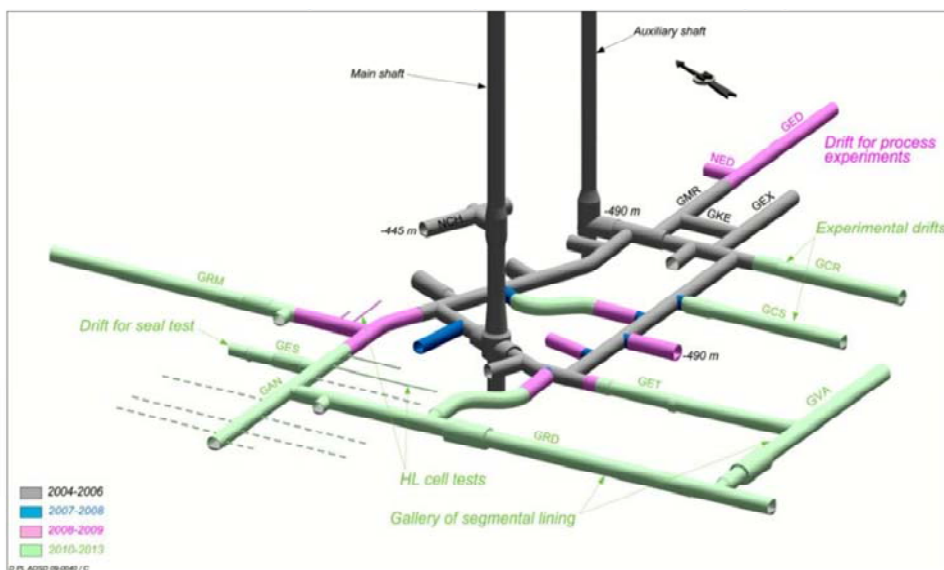

Figure 4-14. Layout of the LSMHM URL at Bure, France (from Lebon, 2011)

As mentioned above, both the Onkalo URL and the LSMHM URL are site-specific URLs at locations expected to eventually host a repository. The organizations for waste emplacement in Finland and France, Posiva Oy and ANDRA, respectively, may thus be less inclined to open their URLs to international researchers than owners of generic URLs. Further work will be needed to explore these opportunities.

5. OVERVIEW OF INTERNATIONAL DISPOSAL RESEARCH INVOLVING UFDC RESEARCHERS

5.1 Selection of R&D Tasks with Active International Collaboration

As discussed in Sections 3 and 4, DOE joined three multinational and multipartner initiatives that promote active international collaboration with specific focus on URL field experiments and related data: the DECOVALEX project, the Mont Terri Project, and the Colloid Formation and Migration Project. UFDC researchers were thus brought into a position that allows participation in planning, conducting, and interpreting the many past and ongoing field experiments associated with these three initiatives, and they can do so in close collaborative partnership with international scientists. DOE also reached out to—and explored options of collaboration with—individual international disposal programs, such as SKB, SCK-CEN, NAGRA, Kaeri, and others.

With many collaboration opportunities available to UFDC, the campaign in FY12 started a planning exercise to identify the most relevant and promising ones, and to select and develop a set of activities that align with current goals, priorities, and funding plans of the UFDC. In a general sense, the benefits of international collaboration are obvious: UFDC can gain substantial value from the knowledge, data, and modeling capabilities that international partners have developed over decades of research. However, the benefit of international collaboration needs to be evaluated in the context of the open R&D issues that can be addressed through collaborative scientific activities. Open R&D issues with respect to NBS behavior are summarized in previous progress reports (e.g., *Natural System Evaluation and Tool Development – FY10 Progress Report, August 2010* [Wang, 2010]); specific R&D issues related to clay/shale host rock are discussed, for example, in Tsang et al. (2011). EBS-related R&D items have also been considered in previous progress reports (e.g., Jove-Colon et al., 2010). All R&D gaps identified in these reports have been evaluated in consideration of their importance to the safety case in a roadmap exercise (*Used Fuel Disposition Campaign Disposal Research and Development Roadmap, FCRD-USED-2011-000065 Rev 0, March 2011; Tables 7 and 8; [Nutt, 2011]*).

A summary table was developed to provide a basis for planning and selection of international activities. Table 5-1 below is an updated version of this summary table; it lists the most relevant ongoing or planned field experiments conducted in international URLs, provides information on how UFDC participation can be achieved, which UFDC work packages would be the main benefactor (generally either the Engineered barrier System, EBS, or Natural Barrier System, EBS), the key FEPs addressed (including a link to roadmap and FEPs importance ranking; using the *Used Fuel Disposition Campaign Disposal Research and Development Roadmap, FCRD-USED-2011-000065 Rev 0, March 2011* [Nutt, 2011]), and finally information on the experimental schedules.

Table 5-1. Participation of International Programs in Cooperative Initiatives Related to URLs: Status 2012. The FEP ranking is based on Tables 7 and 8 in Nutt (2011). Table entries are sorted by URL.

URL	Relevant Ongoing or Planned Experiments (Selected)	Cooperation Mode	Main Focus	FEPs Ranking	Test Period
Mont Terri, Switzerland (Opalinus Clay)	FE: Full-scale heater test demonstration experiment	Via Mont Terri Project	Both EBS and NBS NBS: Many aspects of near-field shale repository evolution, such as EDZ creation, desaturation and resaturation, thermal effects, pore-pressure increase after backfilling and heating EBS: Performance of EBS backfilling and lining technology	Geosphere FEPS (for shale): 2.2.01: Excavation Disturbed Zone (EDZ) >> High (Shale) 2.2.07: Mechanical Processes >> Medium (Shale) 2.2.08: Hydrologic Processes >> Medium (Shale) 2.2.11: Thermal Processes >> Medium (Shale) Engineered System FEPS: Buffer/Backfill materials 2.1.04.01: Buffer/Backfill >> High 2.1.07.02, .03, .04, .09: Mechanical Processes >> Medium 2.1.08.03, .07, .08: Hydrological Processes >> Medium 2.1.11.04: Thermal Processes >> Medium Engineered System FEPS: Seal/liner materials 2.1.05.01: Seals >> Medium 2.1.07.02, .08, .09: Mechanical Processes >> Medium 2.1.08.04, .05, .07, .08, .09: Hydrological Processes >> Low	Test is in preparation and design phase; heating to start in 2014
Mont Terri, Switzerland	HE-H: Half-scale heater test in VE test section (VE = Ventilation Experiment)	Via DECOVALEX or Mont Terri Project	Mostly EBS EBS: Non-isothermal resaturation behavior in bentonite backfill NBS: Interaction of near-field shale rock with EBS components	Geosphere (for shale): 2.2.01: Excavation Disturbed Zone (EDZ) >> High (Shale) 2.2.07: Mechanical Processes >> Medium (Shale) 2.2.08: Hydrologic Processes >> Medium (Shale) 2.2.11: Thermal Processes >> Medium (Shale) 2.2.09: Chemical Processes - Transport >> Medium-High Engineered System FEPS: Buffer/Backfill materials 2.1.04.01: Buffer/Backfill >> High 2.1.07.02, .03, .04, .09: Mechanical Processes >> Medium 2.1.08.03, .07, .08: Hydrological Processes >> Medium 2.1.11.04: Thermal Processes >> Medium	Heating phase: June 2011 through 2014
Mont Terri, Switzerland	MB: Mine-by Test for full-scale HM validation	Via Mont Terri Project	NBS Excavation-generated response in the argillaceous clay host rock near a mined tunnel, including changes in the near-field hydrologic properties	Geosphere FEPS (for shale): 2.2.01: Excavation Disturbed Zone (EDZ) >> High (Shale) 2.2.07: Mechanical Processes >> Medium (Shale) 2.2.08: Hydrologic Processes >> Medium (Shale)	2008 – 2009, but interpretative analysis of results ongoing

URL	Relevant Ongoing or Planned Experiments (Selected)	Cooperation Mode	Main Focus	FEPs Ranking	Test Period
Mont Terri, Switzerland	CI: Cement clay interaction	Via Mont Terri Project	Mostly EBS Investigation of interaction between cement, bentonite and Opalinus Clay. Chemical processes at interfaces are evaluated.	Engineered System FEPs: Buffer/Backfill materials 2.1.04.01: Buffer/Backfill >> High 2.1.09.01, .04, .07, .09, .13: Chemical Processes - Chemistry >> Medium Engineered System FEPs: Seal/liner materials 2.1.05.01: Seals >> Medium 2.1.09.01, .04, .07, .09, .13: Chemical Processes - Chemistry >> Medium	Started in 2007. Sampling and modeling is ongoing.
Mont Terri, Switzerland	HG-A: Gas path host rock and seals	Via Mont Terri Project	Mostly NBS Investigation of EDZ as preferential flow path for gases generated from corrosion	Geosphere FEPs (for shale): 2.2.01: Excavation Disturbed Zone (EDZ) >> High (Shale) 2.2.08: Hydrologic Processes >> Medium (Shale) 2.2.12: Gas sources and effects >> Low	Ongoing since 2006 in various stages with hydraulic and gas injection tests
Mont Terri, Switzerland	DR-A: Diffusion, retention and perturbations	Via Mont Terri Project	NBS Long-term diffusion behavior of sorbing and non-sorbing radionuclides in clay	Geosphere FEPs (for shale) 2.2.05: Flow and Transport Pathways >> Medium (Shale) 2.2.08: Hydrologic Processes >> Medium (Shale) 2.2.09: Chemical Processes - Transport >> Medium (Shale)	Ongoing since early 2011
Grimsel Test Site, Switzerland	CFM: RN tracer test	Via CFM	NBS Transport behavior of a tracer/radionuclide "cocktail" in a shear zone. Test includes conservative tracers, weakly sorbing solutes, strongly sorbing solutes and bentonite colloids	Geosphere FEPs (for crystalline rock) 2.2.05: Flow and Transport Pathways >> Medium (Crystalline) 2.2.08: Hydrologic Processes >> Low (Crystalline) 2.2.09: Chemical Processes - Transport >> Medium (Crystalline)	February through March 2012.
Grimsel Test Site, Switzerland	CFM: RN-Doped Plug Experiment	Via CFM	NBS: Similar to above test, but this time involving at radionuclide-doped bentonite plug which erodes and induces colloid-facilitated transport	Geosphere FEPs (for crystalline rock) 2.2.05: Flow and Transport Pathways >> Medium (Crystalline) 2.2.08: Hydrologic Processes >> Low (Crystalline) 2.2.09: Chemical Processes - Transport >> Medium (Crystalline) Engineered System FEPs: Buffer/backfill materials 2.1.04.01: Buffer/Backfill >> High 2.1.09.51-59, .61: Chemical Processes -Transport >> Low to Medium	Planned for 2013

URL	Relevant Ongoing or Planned Experiments (Selected)	Cooperation Mode	Main Focus	FEPs Ranking	Test Period
Grimsel Test Site, Switzerland	FEBEX: Full-scale heater test	Via NAGRA	Mostly EBS Long-term performance of the bentonite backfill and, to a lesser degree, the near-field crystalline rock, with emphasis on the thermal evolution and resaturation of bentonite backfill surrounding a heated waste package	Engineered System FEPs: Buffer/Backfill materials 2.1.04.01: Buffer/Backfill >> High 2.1.07.02, .03, .04, .09: Mechanical Processes >> Medium 2.1.08.03, .07, .08: Hydrological Processes >> Medium 2.1.11.04: Thermal Processes >> Medium Geosphere FEPs (for crystalline rock) 2.2.01: Excavation Disturbed Zone (EDZ) >> Medium (Crystalline) 2.2.07: Mechanical Processes >> Low (Crystalline) 2.2.08: Hydrologic Processes >> Low (Crystalline) 2.2.11: Thermal Processes >> Low (Crystalline)	Ongoing since 1997
Grimsel Test Site, Switzerland	GAST: Gas permeable seal experiment	Maybe, via MoU with NAGRA	EBS Demonstrate the performance of repository seals and to improve the understanding of water and gas transport through these sealing systems. The experiment involves specially designed backfill and sealing materials such as high porosity mortars or sand/bentonite (S/B) mixtures.	Engineered System FEPs: Buffer/Backfill materials 2.1.04.01: Buffer/Backfill >> High 2.1.08.03, .07, .08: Hydrological Processes >> Medium 2.1.12.01, .02, .03: Gas sources and effects >> Medium	2010 - 2015 (gas injection starting soon)
Äspö Hard Rock Laboratory, Sweden	BRIE: Bentonite rock interaction experiment	Via SKB Task Forces	Both NBS and EBS Understand the exchange of water and potential bentonite erosion at the interface between backfill and flowing fractures	Engineered System FEPs: Buffer/Backfill materials 2.1.04.01: Buffer/Backfill >> High 2.1.08.03, .07, .08: Hydrological Processes >> Medium Geosphere FEPs (for crystalline rock) 2.2.05: Flow and Transport Pathways >> Medium (Crystalline) 2.2.08: Hydrologic Processes >>Low (Crystalline)	Ongoing
Äspö Hard Rock Laboratory, Sweden	LTDE-SD: Long-term sorption diffusion experiment	Via SKB Task Forces	NBS Diffusion and sorption in a conducting fracture and adjacent matrix (sorbing and non-sorbing tracers)	Geosphere FEPs (for crystalline rock) 2.2.05: Flow and Transport Pathways >> Medium (Crystalline) 2.2.08: Hydrologic Processes >>Low (Crystalline) 2.2.09: Chemical Processes - Transport >> Medium (Crystalline)	Completed in 2010 with 6 months test duration

URL	Relevant Ongoing or Planned Experiments (Selected)	Cooperation Mode	Main Focus	FEPs Ranking	Test Period
Åspö Hard Rock Laboratory, Sweden	Prototype Repository: full-scale prototype tunnels with six deposition holes	Via SKB Task Forces	Mostly EBS, also NBS Demonstration of the integrated function of the repository and a full-scale reference for test of predictive models concerning individual components as well as the complete repository system. Includes heaters and backfill.	Geosphere FEPS (for shale): 2.2.01: Excavation Disturbed Zone (EDZ) >> High (Shale) 2.2.07: Mechanical Processes >> Medium (Shale) 2.2.08: Hydrologic Processes >> Medium (Shale) 2.2.11: Thermal Processes >> Medium (Shale) Engineered System FEPS: Buffer/Backfill materials 2.1.04.01: Buffer/Backfill >> High 2.1.07.02, .03, .04, .09: Mechanical Processes >> Medium 2.1.08.03, .07, .08: Hydrological Processes >> Medium 2.1.11.04: Thermal Processes >> Medium	Since 2001. Outer test section opened and retrieved in 2011.
Åspö Hard Rock Laboratory, Sweden	LASGIT: Large-scale gas injection experiment	Maybe, via MoU with SKB	Mostly EBS Evaluate gas flow processes in unsaturated bentonite embedded in fractured crystalline rock; address long-term effect on the hydro-mechanical performance of the buffer clay	Engineered System FEPS: Buffer/Backfill materials 2.1.04.01: Buffer/Backfill >> High 2.1.08.03, .07, .08: Hydrological Processes >> Medium 2.1.12.01, .02, .03: Gas sources and effects >> Medium	Since 2005
Tournemire, France	SEALEX: Long-time sealing experiment for different materials	Via DECOVALEX	Mostly EBS Long-term isothermal HM(C) behavior and hydraulic performance of swelling clay-based seals	Engineered System FEPS: Seal/liner materials 2.1.05.01: Buffer/Backfill >> Medium 2.1.07.02, .08, .09: Mechanical Processes >> Medium 2.1.08.04, .05, .07, .08, .09: Hydrological Processes >> Medium (Flow through seals) 2.1.09.01, .03, .09, .13: Chemical Processes - Chemistry >> Medium	2011 - 2015
Bedrichov Tunnel, Czech Republic	Flow patterns and tracer transport in fractured granite	Via DECOVALEX	NBS Flow patterns and tracer transport behavior within fractured crystalline rock	Geosphere (for crystalline rock): 2.2.02: Host Rock Properties >> High (Crystalline) 2.2.05: Flow and Transport Pathways >> Medium (crystalline) 2.2.08: Hydrologic Processes >> Medium (Crystalline)	Hydrogeologic characterization completed, tracer test planned
Horonobe URL, Japan	EBS experiment: Vertical heater and buffer test (planned)	Via DECOVALEX	Mostly EBS EBS: Non-isothermal resaturation behavior in bentonite backfill NBS: Interaction of near-field shale rock with EBS components	Geosphere (for shale): 2.2.01: Excavation Disturbed Zone (EDZ) >> High (Shale) 2.2.07: Mechanical Processes >> Medium (Shale) 2.2.08: Hydrologic Processes >> Medium (Shale) 2.2.11: Thermal Processes >> Medium (Shale) Engineered System FEPS: Buffer/Backfill materials 2.1.04.01: Buffer/Backfill >> High 2.1.07.02, .03, .04, .09: Mechanical Processes >> Medium 2.1.08.03, .07, .08: Hydrological Processes >> Medium 2.1.11.04: Thermal Processes >> Medium	Start of heating phase in 2014 at the earliest

URL	Relevant Ongoing or Planned Experiments (Selected)	Cooperation Mode	Main Focus	FEPs Ranking	Test Period
HADES URL, Belgium	PRACLAY: Full-scale seal and heater experiment	Via Bilateral with SCK-CEN	Mostly NBS Many aspects of near-field boom clay repository evolution, such as EDZ creation, desaturation and resaturation, thermal effects, pore-pressure increase after backfilling and heating	Geosphere FEPS (for shale): 2.2.01: Excavation Disturbed Zone (EDZ) >> High (Shale) 2.2.07: Mechanical Processes >> Medium (Shale) 2.2.08: Hydrologic Processes >> Medium (Shale) 2.2.11: Thermal Processes >> Medium (Shale)	Heating phase to start once seal has resaturated, probably late 2012 or early 2013
HADES URL, Belgium	RN Migration: Long-running RN diffusion tests	Via Bilateral with SCK-CEN	NBS Diffusion-controlled migration of radionuclides in clay rocks	Geosphere FEPS (for shale) 2.2.05: Flow and Transport Pathways >> Medium (Shale) 2.2.09: Chemical Processes - Transport >> Medium (Shale)	Ongoing since more than two decades
KURT URL, Korea	Experiments planned on solute migration, EDZ, borehole heater tests, long-term monitoring, tracer tests, redox chemistry tests, deep borehole disposal	Via MoU with KAERI	NBS and EBS: Characterization of host rock properties (e.g., EDZ); Solute and fluid transport; Thermal studies; Redox chemistry of deep seated fluids; Resistivity studies with depth	Geosphere FEPS (for borehole): 2.2.01: Excavation Disturbed Zone (EDZ) >> High (Borehole) 2.2.07: Mechanical Processes >> Low (Borehole) 2.2.08: Hydrologic Processes >> Medium (Borehole) 2.2.11: Thermal Processes >> Medium (Borehole) 2.2.09: Chemical Processes - Chemistry >> Medium-High (Borehole) 2.2.09: Chemical Processes - Transport >> Medium-High (Borehole) 2.2.02: Host Rock (properties) >> High (Borehole) 2.2.05: Flow and Transport Pathways >> Medium (Borehole) Engineered System FEPS: Buffer/Backfill materials 2.1.04.01: Buffer/Backfill >> High 2.1.07.02, .03, .04, .09: Mechanical Processes >> Medium 2.1.08.03, .07, .08: Hydrological Processes >> Medium 2.1.11.04: Thermal Processes >> Medium 2.1.09: Chemical Processes - Chemistry >> High (Radionuclide speciation/solubility) 2.1.09: Chemical Processes - Transport >> Medium 2.1.12: Gas Sources and Effects >> Medium Engineered System FEPS: Seal/liner materials 2.1.05.01: Seals >> Medium 2.1.11.04: Thermal Processes >> Medium 2.1.07.02, .08, .09: Mechanical Processes >> Medium 2.1.08.04, .05, .07, .08, .09: Hydrological Processes >> Medium (Flow through seals) 2.1.09: Chemical Processes - Chemistry >> High (Radionuclide speciation/solubility)	KURT is a relatively new facility, and experimental program is still in planning stages. Schedules not clear yet.

Three workshops were held in FY11 and FY12 to inform the DOE leadership and UFDC scientists about international opportunities, and align UFDC work package activities with international initiatives. The first workshop was a session held in conjunction with the UFDC Working Group Meeting in Las Vegas, July 12-14, 2011, at this point mostly for informative purposes. The second workshop, held in Las Vegas on April 11, 2012, was a full-day meeting to review the current and planned work scope within UFDC work packages for possible leveraging with the international programs, and to develop a set of activities that align with goals, priorities, and funded plans of the UFD program. A third workshop was a session held in conjunction with the UFDC Working Group Meeting in Las Vegas, May 15-17, 2012, to inform UFDC researchers about the outcome from the full-day planning workshop. Table 5-2 summarizes the current selection of UFDC work-package activities related to relevant ongoing or planned experiments in international URLs. This selection is based on relevance of experimental work relative to FEPs ranking and takes into account budget considerations. That several activities are not currently selected as UFDC work package activities does not mean that they might not be chosen in the future.

5.2 Brief Status of Work Package Activities Related to International Collaboration Initiatives

Here we give brief descriptions and status updates on the ongoing or planned international collaboration activities described in Table 5-2. Since most of these activities have only very recently been initiated, the progress is mainly that work planning has been conducted, and preliminary analysis and/or model development has occurred. Significantly more progress can be expected by the end of FY13.

5.2.1 THM Modeling of FE Heater Test at Mont Terri (LBNL)

As part of its participation in the Mont Terri Project, DOE has committed to provide modeling support to the FE Heater Test (Section 3.2.2). LBNL is one of four international modeling teams conducting THM simulations for the design of the heater test and the evaluation of monitoring data. To determine the objective, step, and schedule for the THM modeling program, a modeling kick-off meeting was held at Mont Terri on February 9, 2012, followed by a telecom webinar on May 24, 2012. Modeling teams will start with design predictions for the FE Heater Test, in which each modeling team develops its conceptual models and material properties using available literature (papers and reports) on lab experiments and previous Mont Terri *in situ* tests. Later, this will be complemented with a restricted benchmark test for code comparison, in which properties and model geometry are defined by NAGRA. The final phase is then the model evaluation, interpretation, and validation phase using measured data from the FE Heater Test. Currently, LBNL is working on the preliminary design predictions for the FE Heater Test, using the TOUGH-FLAC software; the results are to be presented at the next FE modeling group meeting to be held in Germany in November 2012. Details are provided in Section 4 of the *Report on Modeling Coupled Processes in the Near Field of a Clay Repository*, FCRD-UFD-2012-000223, August 2012 [Liu et al., 2012]).

Table 5-2. Current or Planned Work Package Activities with International Collaboration and Focus on URL Experiments (sorted by URL)

URL	Relevant Ongoing or Planned Experiments (Selected)	Cooperation Mode	UFDC Participation
Mont Terri, Switzerland (Opalinus Clay)	<ul style="list-style-type: none"> FE: Full-scale heater test demonstration experiment HE: Half-scale heater test in VE test section MB: Mine-by experiment CI: Cement clay interaction HG-A: Gas path host rock and seals DR-A: Diffusion, retention and perturbations 	<ul style="list-style-type: none"> Mont Terri Project DECOVALEX Mont Terri Project Mont Terri Project Mont Terri Project Mont Terri Project 	<ul style="list-style-type: none"> Yes, LBNL Yes, LBNL Yes, LBNL Planned, SNL Planned, LBNL Yes, LBNL
Grimsel Test Site, Switzerland (Granite)	<ul style="list-style-type: none"> CFM: RN tracer test and RN-Doped Plug Experiment FEBEX: full-scale heater test (long-running) GAST: Gas permeable seal experiment 	<ul style="list-style-type: none"> CFM Maybe, MoU NAGRA Maybe, MoU NAGRA 	<ul style="list-style-type: none"> Yes, LANL Planned, LLNL Not currently planned Not currently planned
Äspö Hard Rock Laboratory, Sweden (Granite)	<ul style="list-style-type: none"> BRIE: Bentonite rock interaction experiment Prototype Repository: full-scale prototype tunnels LTDE: Long-term sorption diffusion experiment LASGIT: Large-scale gas injection experiment 	<ul style="list-style-type: none"> SKB Task Forces SKB Task Forces SKB Task Forces Maybe, MoU SKB 	<ul style="list-style-type: none"> Maybe, LANL Not currently planned Not currently planned Not currently planned
Tournemire, France (Argillite)	<ul style="list-style-type: none"> SEALEX: Long-time sealing experiment for different materials 	<ul style="list-style-type: none"> DECOVALEX 	<ul style="list-style-type: none"> Not currently planned
Bedrichov Tunnel, Czech Republic (Granite)	<ul style="list-style-type: none"> Flow patterns and tracer transport in fractured granite 	<ul style="list-style-type: none"> DECOVALEX 	<ul style="list-style-type: none"> Yes, SNL
Horonobe URL, Japan (Sedimentary rock)	<ul style="list-style-type: none"> EBS experiment: Vertical heater and buffer test (planned) 	<ul style="list-style-type: none"> DECOVALEX 	<ul style="list-style-type: none"> Not currently planned
HADES URL, Belgium (Boom Clay)	<ul style="list-style-type: none"> PRACLAY: Full-scale seal and heater experiment RN Migration: Long-running RN diffusion tests 	<ul style="list-style-type: none"> Bilateral SCK CEN Bilateral SCK CEN 	<ul style="list-style-type: none"> Not currently planned Not currently planned
KURT URL, Korea (Crystalline rock)	<ul style="list-style-type: none"> Experiments planned on solute migration, EDZ, borehole heater tests, long-term monitoring, tracer and redox chemistry tests, deep borehole disposal 	<ul style="list-style-type: none"> MoU KAERI 	<ul style="list-style-type: none"> Maybe, SNL

LBNL’s model simulations of the FE experiment are carried out using the TOUGH-FLAC software (Rutqvist et al., 2002; 2011), which links the TOUGH2 multiphase flow and heat transport simulator (Pruess et al., 2011) with the FLAC3D geomechanical simulator (ITASCA, 2009). The TOUGH-FLAC simulator has in recent years been extended and applied to issues related to nuclear waste disposal in clay host rocks and bentonite backfilled tunnels (Rutqvist et al., 2011; 2012a). Major improvements include implementation of the Barcelona Basic model (BBM), for the mechanical behavior of unsaturated soils and applied to modeling of bentonite backfill behavior (Alonso et al., 1990). Application of this simulator to the FE Heater Test constitutes a valuable validation example with realistic temperature, saturation, and stress gradients, due to the 1:1 experimental scale. As described in Liu et al. (2012), the numerical model used for the design simulation phase has been finalized (Figure 5-1), and preliminary simulations have been conducted, including a sensitivity study comparing a TH and a THM application as well as variation of some key model parameters. Processes simulated over the next few years (with results compared to measured data) cover all aspects of early-phase repository evolution, such as EDZ creation and desaturation of the EDZ during tunnel excavation and operation (including ventilation for about one year), as well as reconsolidation of the EDZ, resaturation, thermal stresses, and thermal pore-pressure increase after backfilling and heating (heating and monitoring period > 10 years).

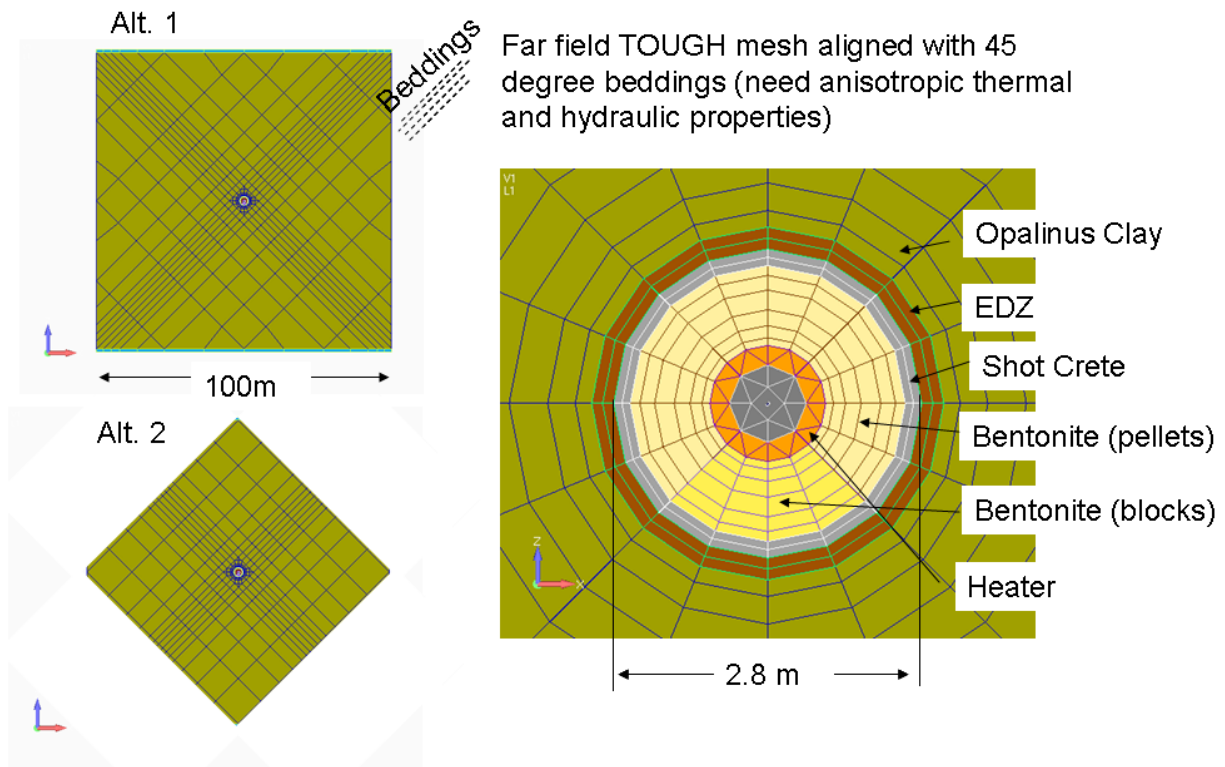

Figure 5-1. TOUGH-FLAC numerical grids used in design simulations for FE Heater Test at Mont Terri URL (from Liu et al., 2012).

5.2.2 THM Modeling of HE-E Heater Test at Mont Terri (LBNL)

As part of its participation in the DECOVALEX project, DOE has tasked LBNL to be one of the modeling teams working on Task B1, the HE-E Heater Test at Mont Terri (Section 3.1.4). With this experiment ongoing for a few more years and soon arriving at peak design temperature, the task leads decided to conduct the modeling task in three steps of increasing complexity: (1) the study of THM processes in the host rock, using data from an earlier borehole heater test; (2) the study of THM processes in the buffer materials, using data from laboratory experiments, and (3) the study of the ongoing HE-E experiment considering the host rock as well as the buffer material, initially as a predictive exercise, then as an interpretative effort with comparison to monitoring data (Garitte and Gens, 2012). Regarding the HE-H experiment, the main objective is to test model capabilities addressing the evolution of EBS components in the early post-closure period, with emphasis on thermal evolution, resaturation, and evolution of swelling pressure in bentonite backfill.

The first step—study of THM processes in the host rock—is based on an earlier *in situ* heater test conducted in a borehole at Mont Terri, referred to as HE-D Heater Test (Figure 5-2). This experiment was run in 2004-2005, for a heating period of 340 days. The temperature field was measured in the heating borehole (about 16 temperature sensors) and in the rock mass (about 23 temperature sensors). The associated pore-water pressure and strain response of the rock mass was monitored in 11 piezometers and 2 extensometers (containing about ten strain measurement intervals each). This test is described by Wilevau (2005), and all related data are public. Modeling THM behavior of the HE-D Heater Test allows initial model comparison and validation without the complicating THM interaction between the Opalinus Clay host rock and the bentonite backfill. LBNL has recently received the task description for Task B1 (Garitte and Gens, 2012) and started with preliminary model setup.

5.2.3 HM Modeling of Mine-by Test at Mont Terri (LBNL)

Constitutive relationships refer to relationships among hydraulic, mechanical, thermal, and mechanical properties. The stress–strain relationship is the most fundamental part of constitutive relationships for geomechanical models. Hooke's law has been generally used to describe this stress–strain relationship for elastic mechanical processes. However, Hooke's law assumes a constant proportionality between stress and strain, an assumption that has been challenged in many studies because relevant mechanical properties are stress-dependent (Liu et al., 2012). To incorporate this stress dependency, Liu et al. (2009) developed a modification of Hooke's law referred to as the “Two-Part Hooke's Model” or “TPHM”, as opposed to the standard “Single-part Hooke's Model” or “SPHM.” Liu et al. (2009) argued that different varieties of Hooke's law should be applied within regions of the rock having significantly different stress–strain behavior, and that a rock body could be conceptualized into two distinct parts. These two parts are called a “hard part,” which undergoes only small deformation, and a “soft part,” which undergoes large deformation. This approach permits the derivation of constitutive relationships between stress and a variety of mechanical and/or hydraulic rock properties.

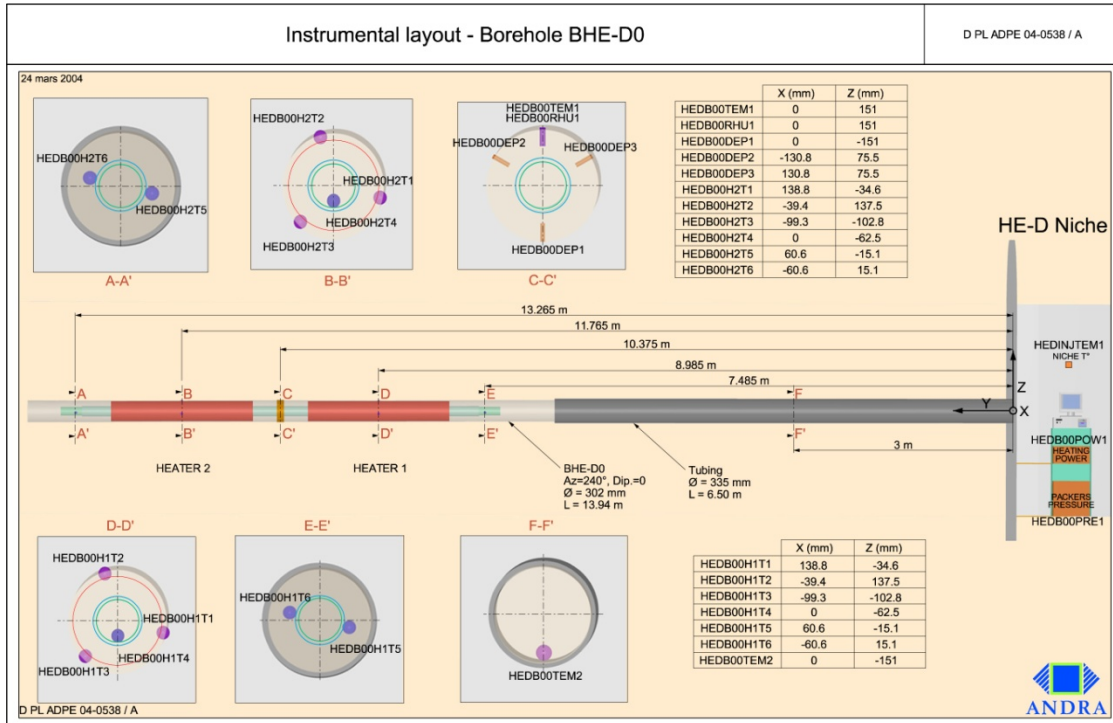

Figure 5-2. Layout of the heater borehole of the HE-D Heater Test at Mont Terri URL (from Garitte and Gens, 2012).

In FY12, LBNL implemented the TPHM into the TOUGH-FLAC code, and started testing the usefulness and validity of the new constitutive relationship by the comparison with field observations of HM behavior at Mont Terri. The first step was to conduct 2D simulations of tunnel displacement and EDZ evolution using an earlier mine-by experiment, known as the ED-B tunnel, conducted in 1997 and 1998. The second step to be performed in FY13 will be a full 3D model comparison with the three-dimensional HM response observed during the recent Mine-by Test at Mont Terri (Section 3.2.3). Figures 5-3 and 5-4 show sample results of the 2D simulations using the TPHM. The first figure is a comparison of the displacement magnitude at different locations around the tunnel, between the measurements in the field and the TPHM as well as SPHM, respectively. It is evident that the TPHM model results are significantly different from those obtained from traditional (SPHM) approaches and agree very well with the field observations.

Figure 5-4 shows results from EDZ damage simulations using the TPHM. A fine-grid numerical approach, based on an explicit incorporation of small-scale heterogeneity of mechanical properties, was used to simulate the fracturing process in a rock mass as a function of time. The failure results shown in Figure 5-4 are in qualitative agreement with the conceptual model of EDZ fractures at Mont Terri, such as steeply inclined unloading joints and shear fractures on both side walls of a mined tunnel in Opalinus Clay (as shown in Figure 5-5). More details on the TPHM and its application to Mont Terri field data are provided in Section 2 of the *Report on Modeling Coupled Processes in the Near Field of a Clay Repository*, FCRD-UFD-2012- 000223, August 2012 [Liu et al., 2012]]. Here, we intend merely to illustrate the great value that

international field data of this type have in testing/validating new modeling capabilities developed within the UFDC.

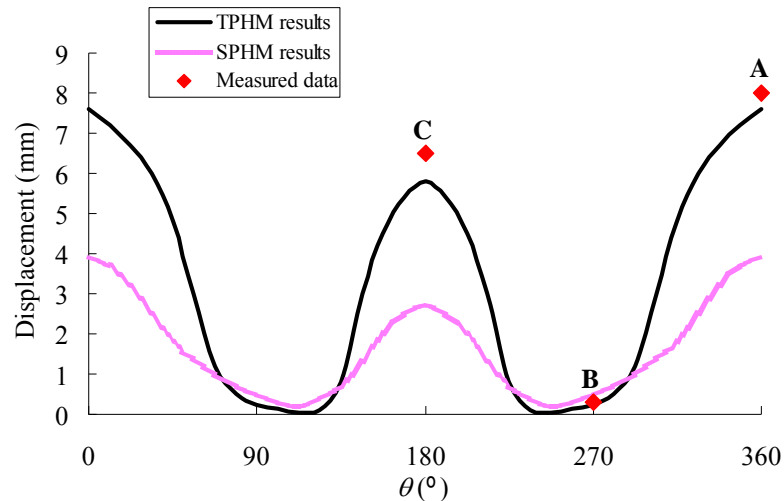

Figure 5-3. Displacement variation (magnitude) at points around the ED-B Tunnel at Mont Terri (from Liu et al., 2012).

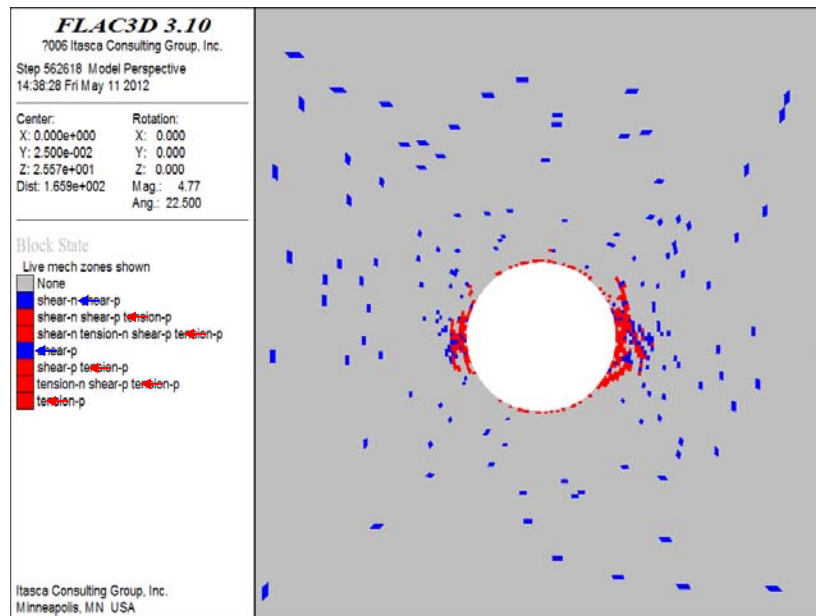

Figure 5-4. Failure type in the EDZ surrounding the ED-B Tunnel at Mont Terri simulated by TPHM (tension failure marked by RED color and shear failure marked by BLUE color) (from Liu et al., 2012).

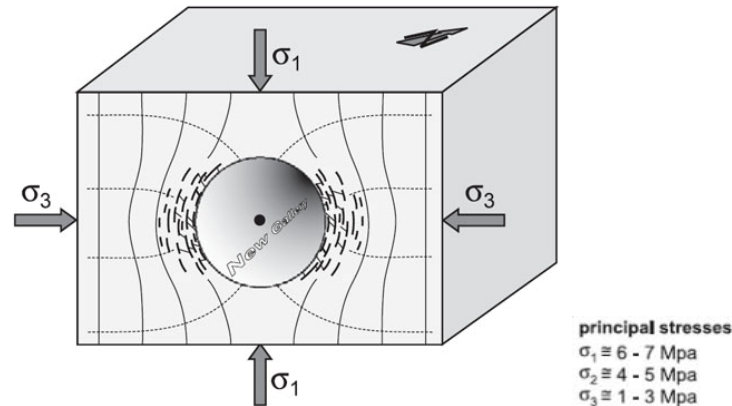

Figure 5-5. Conceptual model of the EDZ in the tunnel walls at Mont Terri URL induced by stress redistribution after excavation (from Bossart et al., 2004).

5.2.4 Thermodynamic Modeling of the CI Experiment at Mont Terri (SNL)

Scientists at SNL have tentative plans to get involved in the interpretation and modeling analysis of results from the current sampling campaign at the CI Cement-Clay Interaction Experiment. As mentioned in Section 3.2.4, this test involves bentonite and cement plugs within a clay host rock and monitors, via drilling campaigns, the *in situ* chemical interactions between clay-cement, clay-bentonite, and bentonite-cement interfaces. The ongoing drilling and sampling campaign will end during early FY13 and will be followed by an interpretation/modeling phase. SNL is planning to contribute to the modeling aspects of interactions with cementitious materials, probably starting in late FY13 or early FY14. Possible tasks are: (1) thermodynamic database evaluation and development, (2) evaluation of tools and methods for thermodynamic modeling of cement and fluid interactions, and (3) evaluation of clay thermodynamic data and modeling of hydration phenomena.

5.2.5 DFN Modeling of the HG-A Experiment at Mont Terri (LBNL)

To more accurately characterize and model EDZ evolution and its impact on flow and transport, LBNL is developing a new three-dimensional discrete fracture network (plus matrix) capability that also accounts for fracture initiation and propagation processes. The geomechanical and fracture-damage processes are simulated using the Rigid-Body-Spring-Network (RBSN) numerical method. The RBSN is further linked with TOUGH2 to compute coupled THM processes. Numerical grid generation for both the RBSN method and TOUGH2 is based on a Voronoi gridding method. The advantages of this DFN generation method include: (1) straightforward representation of existing fractures and matrix blocks, (2) simple activation and connection of new discrete fractures, (3) automated treatment of discrete fracture intersections, (4) capability to control mesh gradation (node density), and (5) straightforward extension to 3D geometry (see example in Figure 5-6). Further details on this method are provided in Section 3 of the *Report on Modeling Coupled Processes in the Near Field of a Clay Repository*, FCRD-UFD-2012-000223, August 2012 [Liu et al., 2012]).

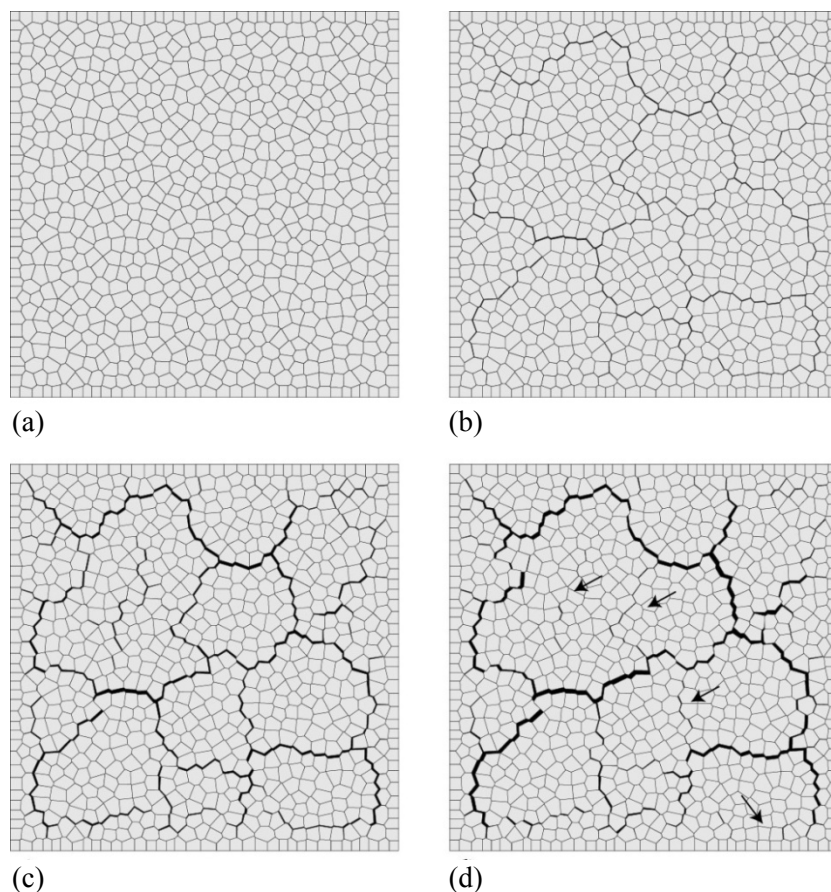

Figure 5-6. Example simulations with RBSN method and discrete fracture network tool.

Evolution of shrinkage cracking in a plan view of a 3D claystone slab: (a) initial configuration; (b) early stage; (c) intermediate stage; and (d) late stage (from Liu et al., 2012). At the late stage, when the fracture developments are stabilized, some of the fractures tend to seal and larger patches are eventually formed. The arrows in the figure indicate the location of the sealing behavior that occurred.

In FY13, LBNL will start testing its new capabilities using data from the ongoing HG-A experiment at Mont Terri (Section 3.2.5). This experiment examines gas paths through the near-field host rock affected by the evolution of the damage zone. Several hydraulic and gas injection tests have been conducted, and a detailed discrete fracture mapping study was performed (see Figure 3-27). The test is therefore a valuable testbed for discrete fracture and THM modeling capabilities.

5.2.6 Diffusion-Reaction Modeling of the DR-A Experiment at Mont Terri, (LBNL)

In compacted bentonite and clay-rich rocks, the negatively charged clay particles are balanced by a cation-enriched double layer. While anions are likely to be excluded from this layer completely at very high degrees of compaction, their concentration is decreased in the double layer even at

lower degrees of compaction, and the tortuosity of the compacted clay with respect to chloride changes as well. Both of these contribute to slower diffusive transport rates of ions through compacted clay-rich materials (Bourg et al., 2003; Bourg et al., 2006; Leroy et al., 2006; Gonçalves et al., 2007), an effect that becomes increasingly important as the compaction increases. For realistic performance predictions of radionuclide transport in the EBS and near-field rock, it is important to develop rigorous and yet practically useful approaches to modeling such diffusive processes.

LBNL has been pursuing two separate but related approaches to modeling ion diffusion through compacted clays. The first makes use of a Donnan equilibrium approach, in which a mean electrostatic potential is defined for the electrical double layer that balances the fixed negative charge of the clays. The second approach involves the use of the Nernst-Planck and Poisson-Boltzmann equation, which resolves the electrical potential as a function of distance from the charged clay surfaces. A recent improvement of these methods now allows dynamic calculation of the width and the composition of the electrical double layer (or micro) porosity as a function of ionic strength (and other geochemical properties). Further details on this method are provided in Section 3 of the *Investigation of Reactive Transport and Coupled THM Processes in EBS: FY12 Report*, FCRD-UFD-2012- 000125, May 2012 [Rutqvist et al., 2012b]). The new diffusive transport modeling capabilities are currently being applied to the DR-A Diffusion, Retention and Perturbation Experiment at Mont Terri (see Section 3.2.6). One of the geochemical perturbations investigated in this test is a dynamic change in ionic strength, providing an extremely valuable set of validation experiments. Initial work is described in Steefel and Soler (2012).

5.2.7 Interpretative Analysis of Colloid Migration and Radionuclide Transport for CFM Experiments (LANL)

As part of their UFDC work scope, LANL researchers have been working on improved understanding of and predictive capability for colloid migration and colloid-associated radionuclide transport (Arnold et al., 2011; Kersting et al., 2012). In FY12, this work has expanded to quantitative interpretation of radionuclide and colloid breakthrough curves from the recent colloid-facilitated tracer Test 12-02 conducted as part of the CFM Project (see Section 3.3.2). The interpretation of breakthrough curves in Test 12-02 was conducted using the semi-analytical RELAP (REactive transport LAPlace transform) model (Reimus et al., 2003) as well as a more sophisticated 2D numerical model (Reimus, 2012). Figure 5-7 shows sample results for the model fit to the breakthrough curve for ^{137}Cs . The figure also shows the respective contributions of solute versus colloid transport to the overall predicted radionuclide breakthrough curve. In the case of for ^{137}Cs , the majority of the breakthrough is predicted to be associated with colloids. Overall, the colloid breakthrough curve of Test 12-02 is consistent with weak and reversible filtration of the colloids, and the dispersion of the colloids in the shear zone appears to be slightly greater than that of the solutes.

In the future, LANL will perform similar interpretative analysis of the upcoming radionuclide-doped bentonite plug experiment at CFM (see Section 3.3.3). LANL may also conduct colloid-facilitated uranium laboratory transport experiments to complement the field work conducted at CFM. In addition, LLNL plans to focus on Pu interaction with clay to support the CFM Project. In FY13, LLNL will conduct batch experiments on Pu interaction with and desorption from bentonite at temperatures of 25 and 80 °C.

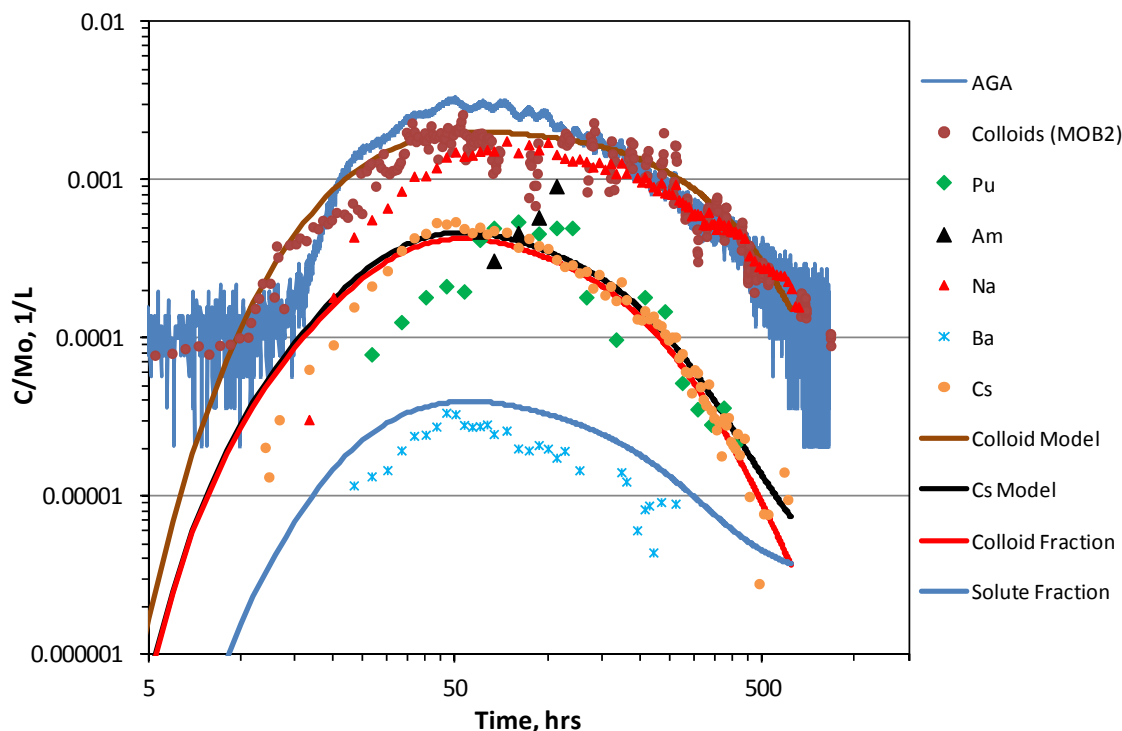

Figure 5-7. Colloid-Facilitated Radionuclide Tracer Test at Grimsel Test Site: Numerical model matches to the ^{137}Cs and colloid breakthrough curves (Reimus, 2012).

5.2.8 DFN Modeling of BRIE Experiment at Äspö Hard Rock Laboratory (LANL)

Researchers at LANL have been developing novel discrete fracture network approaches for modeling flow and transport in the near- and far-field domains of sparsely fractured crystalline formations (e.g., Section 2 in Wang et al., 2011). For FY13, there are tentative plans to apply these capabilities to the ongoing BRIE Experiment at Äspö Hard Rock Laboratory, where the water-bearing fractures have been mapped and their interaction with the bentonite backfill in a vertical deposition hole is being measured. This could possibly be done in collaboration with the SKB Task Forces.

5.2.9 Using Environmental Tracers to Estimated Fracture Network Properties: Application to the Bedrichov Tunnel Experiment (SNL)

As part of DOE's participation in the DECOVALEX project, SNL scientists participate in the interpretation and modeling of Task C2, which is the Bedrichov Tunnel Experiment in the Czech Republic (see Section 3.1.7). The specific focus of SNL's work is the use of environmental tracer data to help characterize fracture network properties (Gardner, 2012). The high resolution groundwater discharge data along with measurements of tritium and stable isotope data collected at the Bedrichov Tunnel provide a unique data set against which to test and calibrate numerical models of groundwater flow and solute transport in fractured media. The expectation is that

environmental tracers can provide valuable information for constraining parameters controlling flow and transport and making better predictions of contaminant transport in fractured network systems.

In FY12, SNL developed a high-performance numerical framework for the simulation of multiple environmental tracers and the estimation of groundwater system parameters using environmental tracer data. For this purpose, the DAKOTA optimization code, for parameter estimation and uncertainty analysis, was coupled to the PFloTran massively parallel flow and transport code used as the forward simulator (Gardner, 2012). Beginning in FY13, this new numerical framework will be applied to the Bedrichov Tunnel modeling test case of DECOVALEX-2015.

5.2.10 Work Plan for R&D Cooperation with KAERI at KURT (SNL)

As part of ongoing collaboration between DOE and KAERI, researchers at SNL have recently developed a work plan proposal with cooperative R&D action items surrounding KAERI's underground research tunnel near Daejeon, Korea (see Section 4.3). As reported in Wang (2012), the work plan proposal identifies potential R&D items that could be pursued over the next few years and provides a tentative schedule. A subset of these items related to planned or possible future tests at KURT is given below:

- Testing *in situ* measurement equipment for characterization of deep geologic conditions in a deep borehole
- Streaming potential (SP) experiments to quantify the correlation between SP signal and ground-water flow in a fractured rock (including the chemical effect on SP Signal)
- Tracer tests in fractured geologic media, validation of discrete fracture network model using KURT geological data, and investigation of the effect of a stagnant zone on solute transport in a fracture (Lab Test)
- Modeling of redox chemistry at KURT

More detail is provided in Wang (2012).

Table 5-3. Summary of FY12 Work Packages Activities with International Collaboration and Focus on URL Experiments

Work Package Activity	Status	Research Organization	Milestone
THM Modeling of FE Heater Test at Mont Terri	Preliminary design predictions for FE Heater Test finalized and shared with other modeling teams.	LBNL	Section 4 in Liu et al. (2012)
THM Modeling of HE-E Heater Test at Mont Terri	Step 1 simulations for DECOVALEX Task were initiated in late FY12 (THM modeling of borehole heater test).	LBNL	Not reported in FY12 milestone
HM Modeling of Mine-by Test at Mont Terri	Substantial work conducted in FY12 to test new constitutive model for stress-strain relationship in comparison with Mont Terri data (displacement, EDZ behavior, etc.).	LBNL	Section 2 in Liu et al. (2012)
Thermodynamic Modeling of CI Experiment at Mont Terri	Tentative modeling plan developed for possible start in late FY12 or early FY13.	SNL	Not reported in FY12 milestone
DFN Modeling of HG-A Experiment at Mont Terri	No work performed in FY12.	LBNL	Not reported in FY12 milestone
Diffusion-Reaction Modeling of DR-A Experiment at Mont Terri	Modeling work started to apply new modeling capabilities (for electrical double layer effects on diffusion) to results from DR-A Experiment. Initial simulations completed.	LBNL	Reported in Steefel and Soler (2012)
Interpretative Analysis of Colloid Migration and Radionuclide Transport for CFM Experiments	Substantial work conducted in FY12 to interpret via semi-analytical and numerical modeling the observed breakthrough curves from tracer Test 12-02.	LANL	Reported in Reimus (2012)
Laboratory Tests in Support of CFM Interpretation	In FY13, LLNL plans to conduct batch experiments on plutonium interaction with and desorption from bentonite at temperatures of 25 and 80 °C.	LLNL	Not reported in FY12 milestone.
DFN Modeling of BRIE Experiment at Äspö Hard Rock Laboratory	No work performed in FY12.	LANL	Not reported in FY12 milestone
Using Environmental Tracers to Estimated Fracture Network Properties: Application to the Bedrichov Tunnel Experiment	High-performance numerical framework developed for the simulation of multiple environmental tracers (coupling of DAKOTA optimization code with flow and transport code PFLOTRAN).	SNL	Reported in Gardner (2012)
Work Plan for R&D Cooperation with KAERI at KURT	Potential R&D items for collaboration with KAERI were selected and future actions/schedules defined.	SNL	Reported in Wang (2012)

6. SUMMARY

Active collaboration with international programs, initiatives, or projects is considered very beneficial to UFDC's disposal research program, providing access to the decades of experience that some international programs have gained in various disposal options and geologic environments. The first part of this report discusses different opportunities for active international collaboration, with focus on both NBS and EBS aspects and those opportunities that provide access to field data (and respective interpretation/modeling) and/or allow participation in ongoing field experiments. Section 3 contains a summary of currently existing international opportunities resulting from DOE's formal "membership" in international collaborative initiatives, such as the DECOVALEX Project, the Mont Terri Project, and the Colloid Formations and Migration Project. Additional cooperation possibilities are discussed in Section 4; these comprise international disposal programs that may be open to DOE participation without formal "membership" or long-term commitment.

With many collaboration opportunities available to UFDC, the campaign in FY12 started a planning exercise to identify the most relevant and promising opportunities, and to select and initiate a set of activities that align with current goals, priorities, and funded plans of the UFDC. In a general sense, the benefit of international collaboration is obvious; UFDC can gain substantial value from the knowledge, data, and modeling capabilities that international partners have developed over decades of research. However, the benefit of international collaboration needs to be evaluated in the context of the open R&D issues that can be addressed through collaborative scientific activities. Section 5.1 describes the planning process that led to the selection of cooperative R&D activities, while Section 5.2 gives a brief description of objective, status, and future plan of each R&D activity. Overall, DOE/UFDC has in a very short time frame developed a balanced set of international research collaborations, and has recently initiated several relevant cooperative R&D activities that have great potential for substantial technical advances.

7. ACKNOWLEDGEMENTS

Funding for this work was provided by the Used Fuel Disposition Campaign, Office of Nuclear Energy, of the U.S. Department of Energy under Contract Number DE-AC02-05CH11231 with Berkeley Lab.

8. REFERENCES

- Aalto, P., Aaltonen, I., Ahokas, H., Andersson, J., Hakala, M., Hellä, P., Hudson, J.A., Johansson, E., Kemppainen, K., Koskinen, L., Laaksoharju, M., Lahti, M., Lindgren, S., Mustonen, A., Pedersen, K., Pitkänen, P., Poteri, A., Snellman, M., Ylä-Mella, M. (2009) *Programme for Repository Host Rock Characterization in ONKALO (ReRoc)*, Posiva Oy Working Report 2009-31.
- Äikäs, T. (2011) *Towards Implementation*, Presentation given at the HADES Workshop, “30 Years of Underground Research Laboratory”, May 23-25, 2011, Antwerp, Belgium.
- Alonso E. E., Gens A., Josa A. (1990) *A Constitutive Model for Partially Saturated Soils*, Géotechnique, 40(3): 405-430.
- Arnold, B. A., Reimus, P. W., James, S. C. (2011) *Flow and Transport in Saturated Media: FY2011 Status Report*, Prepared for U.S. Department of Energy Used Fuel Disposition Campaign, FCRD-USED-2011-000311, Sandia National Laboratories and Los Alamos National Laboratory.
- Barnichon J. D. (2011) *IRSN proposal - the SEALEX In Situ Tests*, Presentation given at 7th DECOVALEX 2011 Workshop, April 2011, Helsinki, Finland.
- Barnichon J. D., Millard, A. (2012) *Task A: the SEALEX In Situ Experiments*, Presentation given at 1st DECOVALEX 2015 Workshop, April 2012, Berkeley, CA.
- Birkholzer, J.T. (2011) *Disposal R&D in the Used Fuel Disposition Campaign: A Discussion of Opportunities for Active International Collaboration*, Prepared for U.S. Department of Energy Used Fuel Disposition Campaign, FCRD-USED-2011-000225, Lawrence Berkeley National Laboratory.
- Birkholzer, J.T., Houseworth, J., Tsang, C.-F. (2012) *Geologic Disposal of High-Level Radioactive Waste – Status, Key Issues, and Trends*, published online in Annual Review of Environment and Resources, 37:4.1–4.28, DOI: 10.1146/annurev-environ-090611-143314.
- Bourg, I.C., Bourg, A.C.M., Sposito, G. (2003) *Modeling Diffusion and Adsorption in Compacted Bentonite: a Critical Review*, J. Contam. Hydrol. 61, 293–302.
- Bourg, I.C., Sposito, G., Bourg, A.C.M. (2006) *Tracer Diffusion in Compacted, Water-Saturated Bentonite*, Clays Clay Miner. 54, 363–374.
- BMWi (2008) *Final Disposal of High-level Radioactive Waste in Germany – The Gorleben Repository Project*, Federal Ministry of Economics and Technology (BMWi), Germany, October, 2008.
- Bockgård, N., Vidstrand, P., Åkesson, M. (2012) *Task 8, Modeling the interaction between engineered and natural barriers - An assessment of a fractured bedrock description in the wetting process of bentonite at deposition tunnel scale*, Task Description for GWFTS Task Force, SKB, Internal Report.
- Bossart, P., Trick, T., Meier, P.M., Mayor, J.-C. (2004) *Structural and Hydrogeological Characterisation of the Excavation-Disturbed Zone in the Opalinus Clay (Mont Terri Project, Switzerland)*, Applied Clay Science, 26, 429– 448.

- Bossart, P., Thury, M. (2007) *Research in the Mont Terri Rock laboratory: Quo vadis?*, Physics and Chemistry of the Earth, Parts A/B/C, 32(1-7), pp. 19-31.
- Bossart, P. (2012) *Welcome to Technical Meeting 8-9 February 2012*, Presentation given at the Mont Terri Technical Meeting TM-30, February 8 and 9, 2012, Saint Ursanne, Switzerland.
- Cuss, R. (2010) *Large Scale Gas Injection Test (LASGIT): Progress to May 2010*, Presentation given at 6th DECOVALEX 2011 Workshop, October 2010, Wuhan, China.
- Gardner, P. (2012) *DECOVALEX 2012 – Using Environmental Tracers to Estimate Fracture Network Properties: Bedrichov Tunnel, Czech Republic*, Prepared for U.S. Department of Energy Used Fuel Disposition Campaign, FCRD-UFD-2011-000229, Sandia National Laboratories.
- Garitte B. (2010) *New In Situ Experiments at Mont Terri*, Presentation given at 6th DECOVALEX 2011 Workshop, October 2010, Wuhan, China.
- Garitte B. and several others (2011) *HE-E experiment - In Situ Heater Test*, Presentation given at 7th DECOVALEX 2011 Workshop, April 2011, Helsinki, Finland.
- Garitte, B., Gens, A. (2012) *DECOVALEX-2015: Description of Task B1, THM Processes in Argillaceous Rocks and the Engineered Barrier*, DECOVALEX Task Description Report, Modeling Step 1, August 2012.
- Gaus, I. and several others (2012) *HE-E Experiment in the VE test Section – EBS Behavior Immediately After Repository Closure in a Clay Host Rock*, Presentation given at the Mont Terri Technical Meeting TM-30, February 8 and 9, 2012, Saint Ursanne, Switzerland.
- Gonçalvès, J., Rousseau-Gueutin, P., Revil, A. (2007) *Introducing Inter-acting Diffuse layers in TLM Calculations: A Reappraisal of the Influence on the Swelling Pressure and the Osmotic Efficiency of Compacted Bentonites*, Journal of Colloid Interface Science 316, 92-99.
- Hokr M., Slovak J. (2011) *Bedrichov Tunnel Test Case Proposal for DECOVALEX 2015*, Presentation given at 7th DECOVALEX 2011 Workshop, April 2011, Helsinki, Finland.
- ITASCA (2009) *FLAC3D V4.0, Fast Lagrangian Analysis of Continua in 3 Dimensions, User's Guide*, Itasca Consulting Group, Minneapolis, Minnesota.
- Jing L., Hudson J.A. (2011) *Technical Descriptions of the Three Tasks Proposed for the Next Phase of the DECOVALEX Project (2012–2015)*, Internal DECOVALEX Report, December 15, 2011.
- Jove-Colon, C.F., Caporuscio, F.A., Levy, S.S., Xu, H., Blink, J.A., Halsey, W.G., Buscheck, T., Sutton, M., Serrano de Caro, M.A., Wolery, T.J., Liu, H.H., Birkholzer, J.T., Steefel, C.I., Rutqvist, J., Tsang, C.F., Sonnenthal, E. (2010), *Disposal Systems Evaluations and Tool Development - Engineered Barrier System (EBS) Evaluation*, Prepared for U.S. Department of Energy Used Fuel Disposition Campaign, U.S. DOE Used Fuel Disposition Campaign, September 2010.
- KAERI (2011) *KURT – KAERI Underground Research Tunnel*, Brochure, Korea Atomic Energy Research Institute, Division of Radioactive Waste Technology Development.
- Kersting, A., Zavarin, M., Zhao, P., Dai, Z. Carroll, S., Wang, Y., Miller, A., James, S., Reimus, P., Zheng, L., Li, L., Rutqvist, J., Liu, H.-H., Birkholzer, J. (2012) *Radionuclide Interaction*

- and Transport in Representative Geologic Media*, Prepared for U.S. Department of Energy Used Fuel Disposition Campaign, FCRD-UFD-2012-000154, Sandia National Laboratories.
- Lebon, P. (2011) *Large-scale Experiment at Bure*, Presentation given at the HADES Workshop, “30 Years of Underground Research Laboratory”, May 23-25, 2011, Antwerp, Belgium.
- Leroy, P., Revil, A., Coelho, D. (2006) *Diffusion of Ionic Species in Bentonite*, J. Colloid Interface Sci. 296 (1), 248–255.
- Li X. (2011) *Design and Status of the PRACLAY Seal and Heater Test*, Presentation given at the HADES Workshop, “30 Years of Underground Research Laboratory”, May 23-25, 2011, Antwerp, Belgium.
- Liu H.H., Rutqvist J., Berryman J.C. (2009) *On the Relationship Between Stress and Elastic Strain for Porous and Fractured Rock*, International Journal of Rock Mechanics & Mining Sciences 46, 289–296.
- Liu, H.-H., Houseworth, J., Rutqvist, J., Li, L., Asahina, D., Chen, F., Birkholzer, J. (2012) *Report on Modeling Coupled Processes in the Near Field of a Clay Repository*, Prepared for U.S. Department of Energy Used Fuel Disposition Campaign, FCRD-UFD-2012-000223, Lawrence Berkeley National Laboratory.
- Maeder, U., Schwyn, B. (2012) *CI Experiment: Cement-Clay-Interaction*, Presentation given at the Mont Terri Technical Meeting TM-30, February 8 and 9, 2012, Saint Ursanne, Switzerland.
- Maes N., Weetjens E., Aertsen M., Govaerts J., Van Ravestyn L. (2011) *Added Value and Lessons Learned from In Situ Experiments – Radionuclide Migration*, Presentation given at the HADES Workshop, “30 Years of Underground Research Laboratory”, May 23-25, 2011, Antwerp, Belgium.
- Marschall, P. and several others (2012) *Gaspath Through Host Rock and Along Seal Sections (HG-A)*, Presentation given at the Mont Terri Technical Meeting TM-30, February 8 and 9, 2012, Saint Ursanne, Switzerland.
- NAGRA (2010) *Grimsel Test Site – Research on Safe Geologic Disposal of Radioactive Waste*, Brochure in Recognition of 25 Years of Research at Grimsel Test Site, NAGRA, July 2010.
- Nutt M. (2010) *Used Fuel Disposition Campaign International Activities Implementation Plan*, Prepared for U.S. Department of Energy Used Fuel Disposition Campaign, FCRD-USED-2011-000016 REV 0, Argonne National Laboratory.
- Nutt M. (2011) *Used Fuel Disposition Campaign Disposal Research and Development Roadmap*, Prepared for U.S. Department of Energy Used Fuel Disposition Campaign, FCRD-USED-2011-000065 REV0, Argonne National Laboratory.
- Pruess K., Oldenburg C. M., Moridis G. (2011) *TOUGH2 User’s Guide, Version 2.1*, LBNL-43134(revised), Lawrence Berkeley National Laboratory, Berkeley, California.
- Posiva, (2011) *Olkiluoto Site Description 2011*, Posiva Oy, Report POSIVA 2011.
- Polak A., Elsworth D., Yasuhara H., Grader A. S., Halleck P. M. (2003) *Permeability Reduction of a Natural Fracture Under Net Dissolution by Hydrothermal Fluids*, Geophys. Res. Lett., 30(20), 2020.

- Reimus, P. W., Pohll, G., Mihevc, T., Chapman, J., Papelis, L., Lyles, B., Kosinski, S., Niswonger, R., Sanders, P. (2003) *Testing and Parameterizing a Conceptual Model for Radionuclide Transport in a Fractured Granite Using Multiple Tracers in a Forced-Gradient Test*, Water Resour. Res., 39(12), p. 1350, doi:10.1029/2002WR001597.
- Reimus, P. (2012) *Preliminary Interpretation of a Radionuclide and Colloid Tracer Test in a Granodiorite Shear Zone at the Grimsel Test Site, Switzerland*, Prepared for U.S. Department of Energy Used Fuel Disposition Campaign.
- Rejeb A., Cabrera J. (2006) *Time-dependent evolution of the excavation damaged zone in the argillaceous Tournemire Site (France)*, Proceedings “GeoProc 2006,” Invited lecture in the 2nd International Conference on Coupled THMC Processes in Geosystems and Engineering, May 22-25 2006, Nanjing, China, pp. 65-74.
- Rutqvist J., Min, K.-B. (2011) *THMC Modeling of Rock Fractures*, Presentation given at 7th DECOVALEX 2011 Workshop, April 2011, Helsinki, Finland.
- Rutqvist, J., Wu, Y.-S., Tsang, C.-F., Bodvarsson, G. (2002) *A Modeling Approach for Analysis of Coupled Multiphase Fluid Flow, Heat Transfer, and Deformation in Fractured Porous Rock*, Int. J. of Rock Mechanics & Mining Sciences, 39, 429–442.
- Rutqvist, J., Ijiri, Y., Yamamoto, H. (2011) *Implementation of the Barcelona Basic Model into TOUGH–FLAC for Simulations of the Geomechanical Behavior of Unsaturated Soils*, Computers & Geosciences 37, 751–762.
- Rutqvist J., Zheng L., Chen F., Liu H.-H., Jens Birkholzer J. (2012a) *Modeling of Coupled Geomechanical and Geochemical Processes Associated with Bentonite-Backfilled Repository Tunnels in Clay Formations*, Submitted to Journal of Rock Mechanics and Rock Engineering, April 2012.
- Rutqvist, J., Steefel, C.I., Davis, J., Bourg, I., Tinnacher, R., Galindez, J., Holmboe, M., Birkholzer, J., Liu, H.-H. (2012b) *Investigation of Reactive Transport and Coupled THM Processes in EBS: FY12 Report*, Prepared for U.S. Department of Energy Used Fuel Disposition Campaign, FCRD-UFD-2012- 000125, Lawrence Berkeley National Laboratory.
- SKB (2011a), *Äspö Hard Rock Laboratory Annual Report 2010*, SKB Technical Report TR-11-10, February 2011.
- SKB (2011b), *Äspö Hard Rock Laboratory Planning Report for 2011*, SKB International Progress Report IPR-10-19, February 2011.
- Steefel, C.I., Soler, J. (2012) *Status of Diffusion-Reaction Modeling of the DR-A Field Experiment at Mont Terri, Switzerland*, Prepared for U.S. Department of Energy Used Fuel Disposition Campaign, FCRD-UFD-2012-000240, Lawrence Berkeley National Laboratory.
- Sugita, Y., Nakama, S. (2012) *Task B: EBS Horonobe Experiment*, Presentation given at 1st DECOVALEX 2015 Workshop, April 2012, Berkeley, CA.
- Tsang C.-F., Stephansson O., Jing L., Kautsky F. (2009) *DECOVALEX Project: from 1992 to 2007*, Environmental Geology, 57, 1221–1237, 2009.
- Tsang C.-F., Barnichon J. D., Birkholzer J. T., Li X. L., Liu H. H., Sillen X., Vietor T. (2011) *A Review of Coupled Thermo-Hydro-Mechanical Processes in the Near-field of a High-Level Radioactive Waste Repository in a Clay Formation*, International Journal of Rock Mechanics and Mining Sciences, 49, pp. 31-44.

- Van Marcke P., Bastiaens W. (2010) *Construction of the PRACLAY Experimental Gallery at the Hades URF*, Clay in Natural and Engineered Barriers for Radioactive Waste Confinement, 4th International Meeting, March, 2010, Nantes, France.
- Vietor T., Polster M., Garitte B., Martin, D. (2011) *Mine-by Test in the Mont Terri Rock Laboratory – MB Experiment*, Presentation given at 7th DECOVALEX 2011 Workshop, April 2011, Helsinki, Finland.
- UFD (2012) *Office of Used Nuclear Fuel Disposition International Program – Strategic Plan*, April 2012, U.S. Department of Energy.
- Wang Y. (editor) (2010) *Natural System Evaluation and Tool Development – FY10 Progress Report*, Prepared for U.S. Department of Energy Used Fuel Disposition Campaign, August 2010, Sandia National Laboratories.
- Wang, Y., Simpson, M., Painter, S., Liu, H.-H., Kersting, A. 2011. *Natural System Evaluation and Tool Development – FY10 Progress Report*, Prepared for U.S. Department of Energy Used Fuel Disposition Campaign, FCRD-UFD-2011-000223, Sandia National Laboratories.
- Wang, Y. (2012) *Work Plan for UFD R&D Tests at KAERI Underground Research Tunnel (KURT) Site*, Prepared for U.S. Department of Energy Used Fuel Disposition Campaign, FCRD-UFD-2011-000212, Sandia National Laboratories.
- Wersin, P., Van Loon, L.R., Soler, J.M., Yllera, A., Eikenberg, J., Gimmi, Th., Hernán, P., Boisson, J.-Y. (2004) *Long-term Diffusion Experiment at Mont Terri: First Results from Field and Laboratory Data*, Applied Clay Science, Vol. 26, 123-135.
- Wersin, P., Soler, J.M., Van Loon, L., Eikenberg, J., Baeyens, B., Grolimund, D., Gimmi, T., Dewonck, S. (2008) *Diffusion of HTO, Br⁻, I, Cs⁺, ⁸⁵Sr²⁺ and ⁶⁰Co²⁺ in a Clay Formation: Results and Modeling from an In Situ Experiment in Opalinus Clay*, Applied Geochemistry, 23, 678-691.
- Wileveau Y. (2005) *THM Behavior of Host Rock (HE-D Experiment): Progress Report September 2003 – October 2004*, Mont Terri Technical Report TR2005-03.
- Yasuhara H., Elsworth D., Polak A. (2004) *The Evolution of Permeability in a Natural Fracture: Significant Role of Pressure Solution*, J. Geophys. Res., Vol. 109.
- Yasuhara, H., Polak, A., Mitani, Y., Grader, A., Halleck, P., Elsworth, D. (2006) *Evolution of Fracture Permeability Through Fluid-Rock Reaction Under Hydrothermal Conditions*, Earth Planet. Sci. Lett. 244: 186–200.
- Yasuhara, H., Kinoshita, N., Ohfuji, H., Lee, D.S., Nakashima, S., Kishida, K. (2011) *Temporal Alteration of Fracture Permeability in Granite Under Hydrothermal Conditions and its Interpretation by Coupled Chemo-Mechanical Model*, Appl. Geochem. 26: 2074–2088.
- Zimmerman, R. (2012) *Task C1: Coupled THMC Processes in Rock Fractures*, Presentation given at 1st DECOVALEX 2015 Workshop, April 2012, Berkeley, CA.
- Zuidema P. (2007) *Advancements in Deep Geological Disposal of Radioactive Waste through International Cooperation: The Role of Underground Laboratories – Mont Terri Project*, Proceedings of the 10 Year Anniversary Workshop, pp 69-71, Rep. Swiss Geol. Surv. 2.