

Plugging America into Clean Energy



U. S. Department of Energy
Future Needs of the Electricity Grid



DOE Grid Tech Team
15 November 2011

The Grid Tech Team

The Grid Tech Team (GTT), with DOE-wide representation, is responsible for leadership within and outside DOE on grid modernization through strategic thinking and improved communication, coordination, and collaboration.

DOE REPRESENTATION

- Office of Science (**SC**)
- Office of Electricity Delivery & Energy Reliability (**OE**)
- Office of Energy Efficiency & Renewable Energy (**EERE**)
- Advanced Research Projects Agency – Energy (**ARPA-E**)
- Chief Financial Office (**CFO**)
- DOE Senior Management (**S1**)

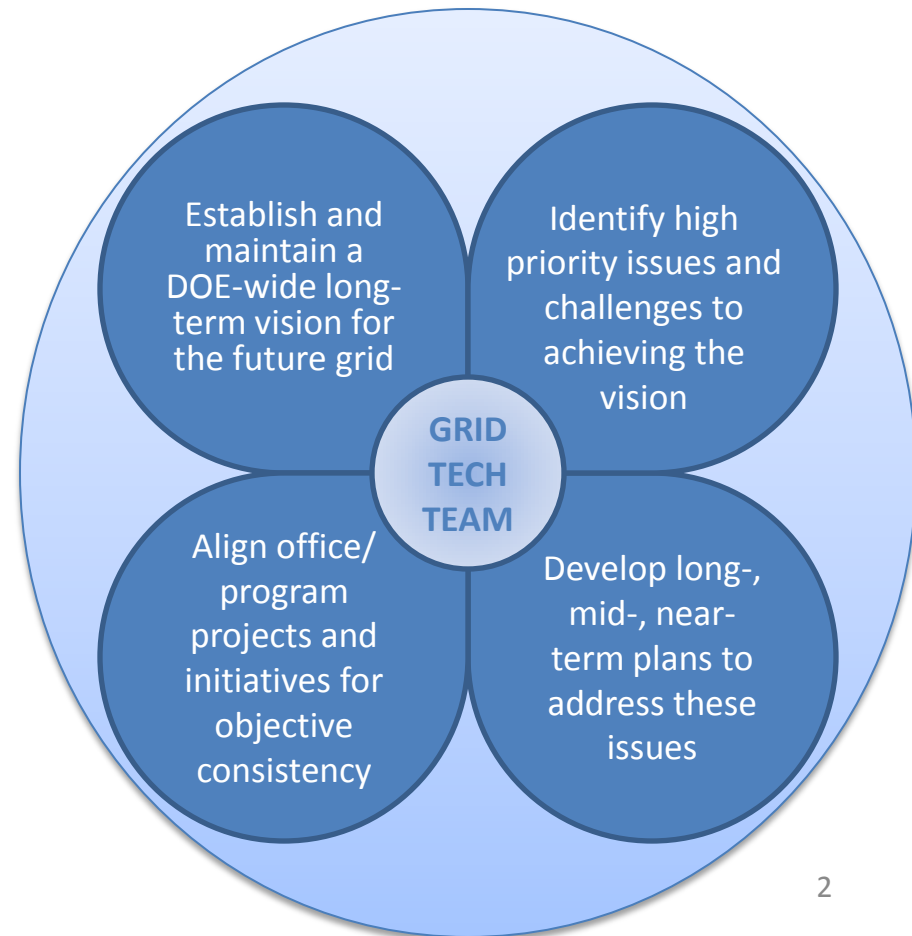

The Evolution of a National Vision

July 2003

Think Locally,
Regionally and Nationally

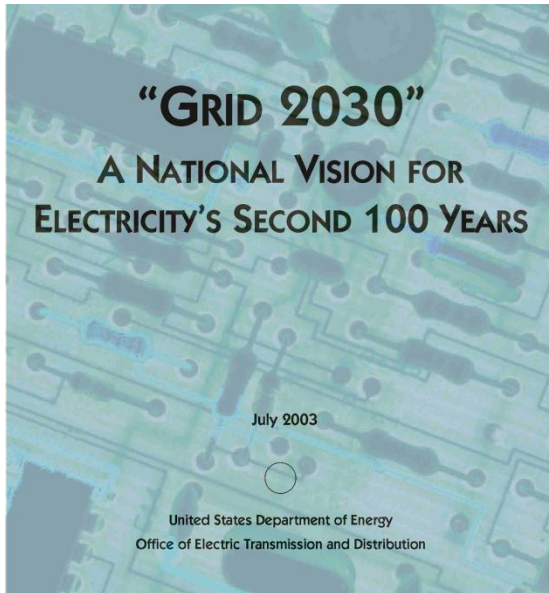

“National leadership is needed to create a shared vision of the future and to build effective public-private partnerships for getting there.”

Changing Supply Mix

- Requires additional transmission
- Requires control/communications

Demand Transformation

- Expanding Digital Economy
- Power quality needs
- Demand growth

Complexity of Grid

- Expanding footprint
- Overlay of markets
- Operating “closer to the edge”

Infrastructure Vulnerability

- Interdependencies of electric and energy systems

INCREASING DRIVERS

Moving Forward

Enabling an Electricity Services Economy

“Electricity as a Service”

- Access to clean energy generation and options
- Delivery of desired power quality when it is wanted
- Customer participation into electricity markets (demand response)
- Customer flexibility to use new technologies (electric vehicles, distributed generation, energy management system, etc.)
- Dynamic protection, privacy, and cyber security
- ...

Grid 2030 Roadmap (2003)

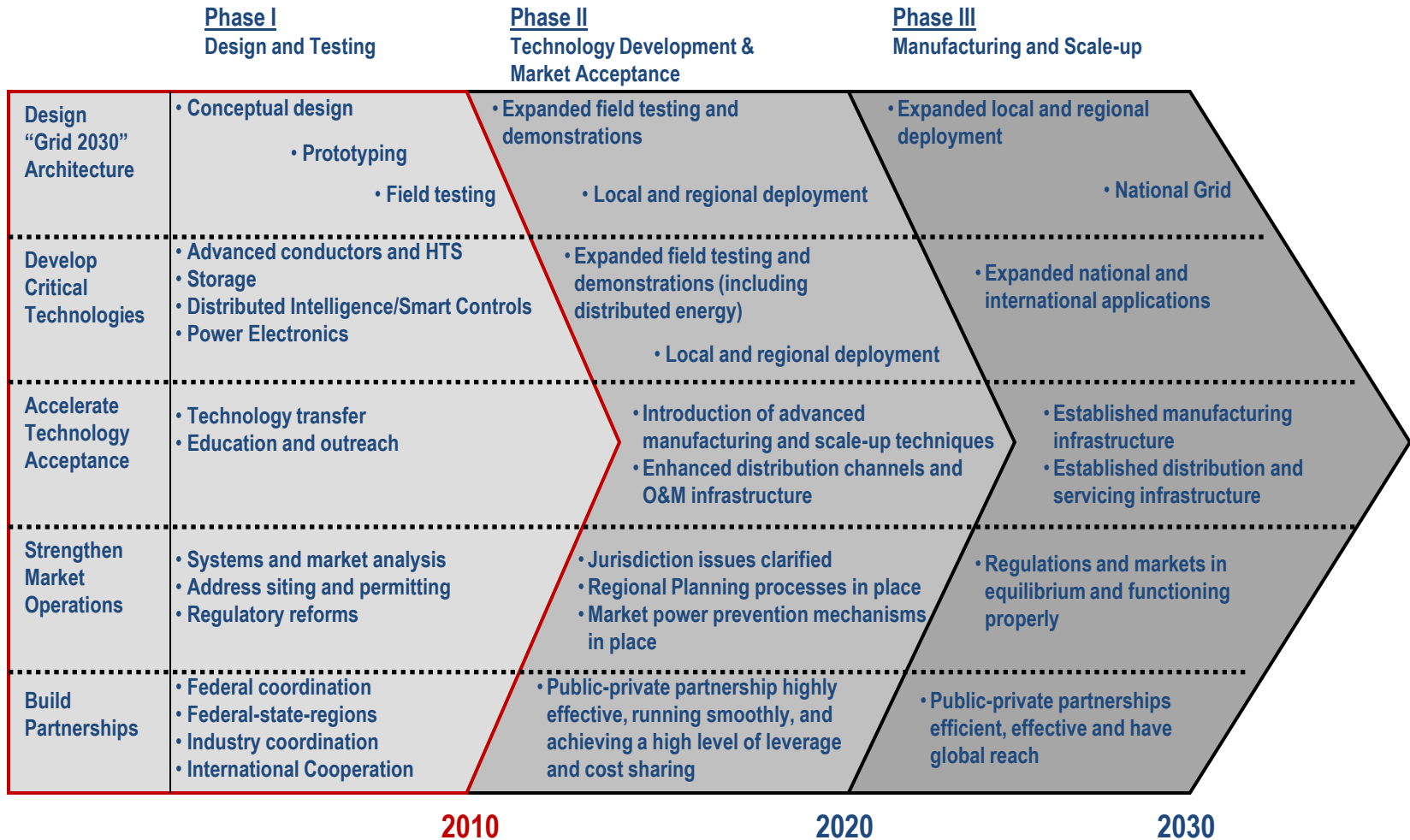

Adapted from US DOE Office of Electric Transmission and Distribution, "National Electric Delivery Technologies Roadmap: Transforming the Grid to Revolutionize Electric Power in North America", January 2004 (available at http://energy.gov/sites/prod/files/oeprod/DocumentsandMedia/ER_2-9-4.pdf).

Grid Investment Drivers over Time

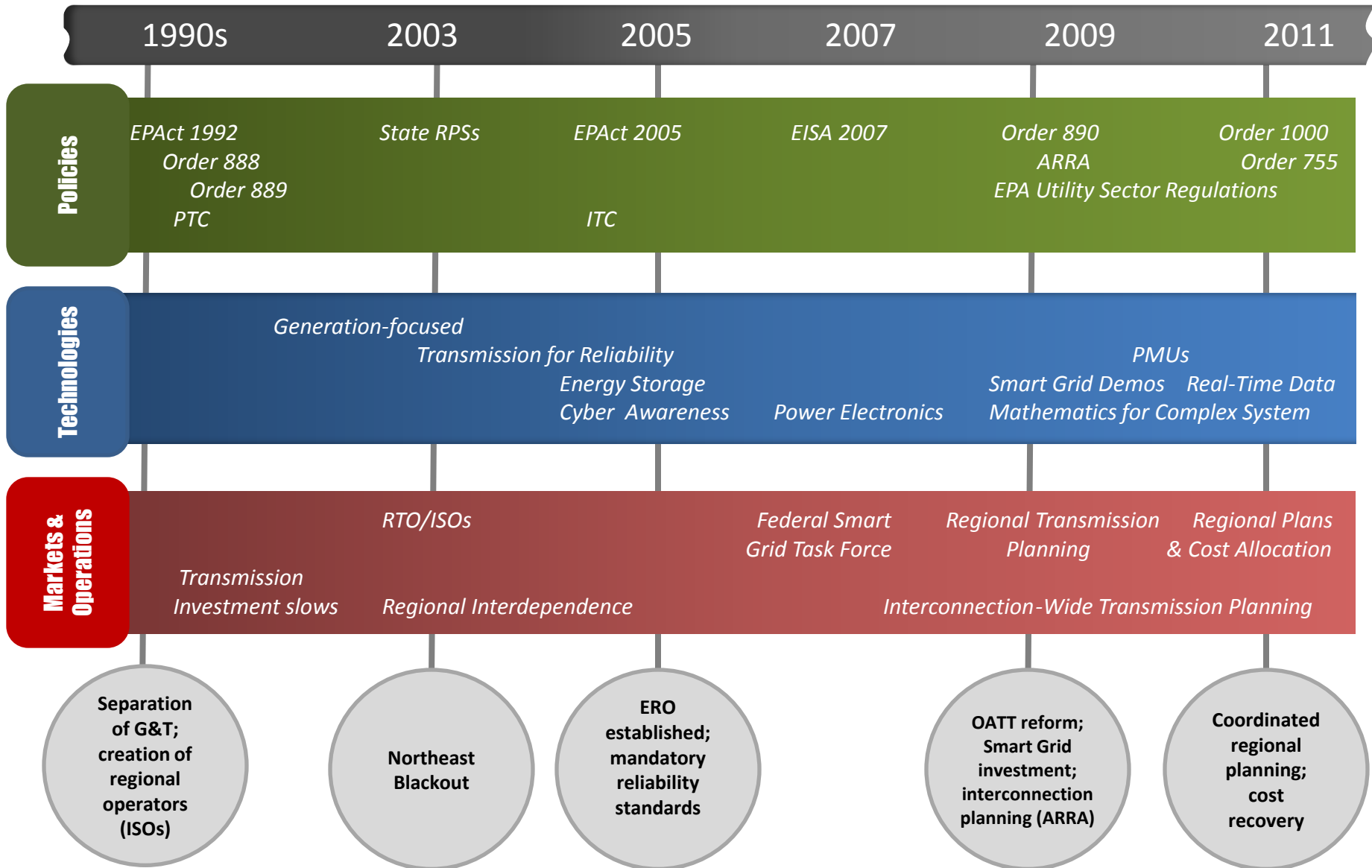

Changes to the Grid require an intricate balance of technologies, markets, and policies

DOE's Clean Energy Goals:

- By 2035, 80% of America's electricity will come from clean energy sources
- Put 1 million electric vehicles on the road by 2015
- Energy related GHG emissions will reduce 17% by 2020 and 83% by 2050

Targeted Outcomes for the Grid:

- Enable better understanding and control of our electric grid by installing more than 1000 synchrophasor measurement units by 2013.
- Deploy more than 26 million smart meters in American homes and businesses by 2013.
- Reduce utility-scale energy storage costs 30% by 2015.

- *Policies drive markets which drives technologies*
- *When finding solutions to grid challenges, all aspects need to be considered simultaneously*

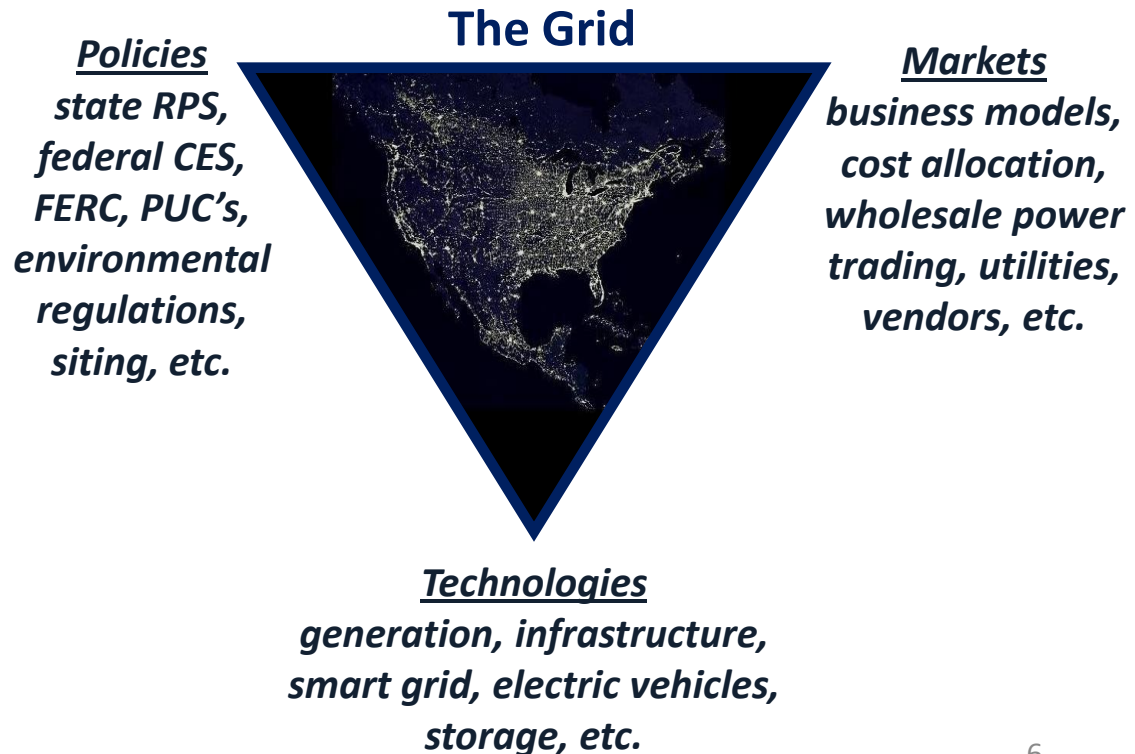

Vision for the Grid of the future will need to address multiple goals

Enable a *seamless*, cost-effective electricity system, from generation to end use, capable of meeting the clean energy demands and capacity requirements of this century, while allowing consumer participation and electricity use as desired:

- ✓ Significant scale-up of Clean Energy (*80% by 2035*)
- ✓ Allows 100% customer participation and choice (including distributed generation, demand-side management, electrification of transportation, and energy efficiency)
- ✓ A 100% *holistically* designed system (including AC-DC hybrid configurations)
- ✓ Global competitiveness and leadership
- ✓ A reliable, secure, and resilient Grid

Moving Forward: Targets & Direction

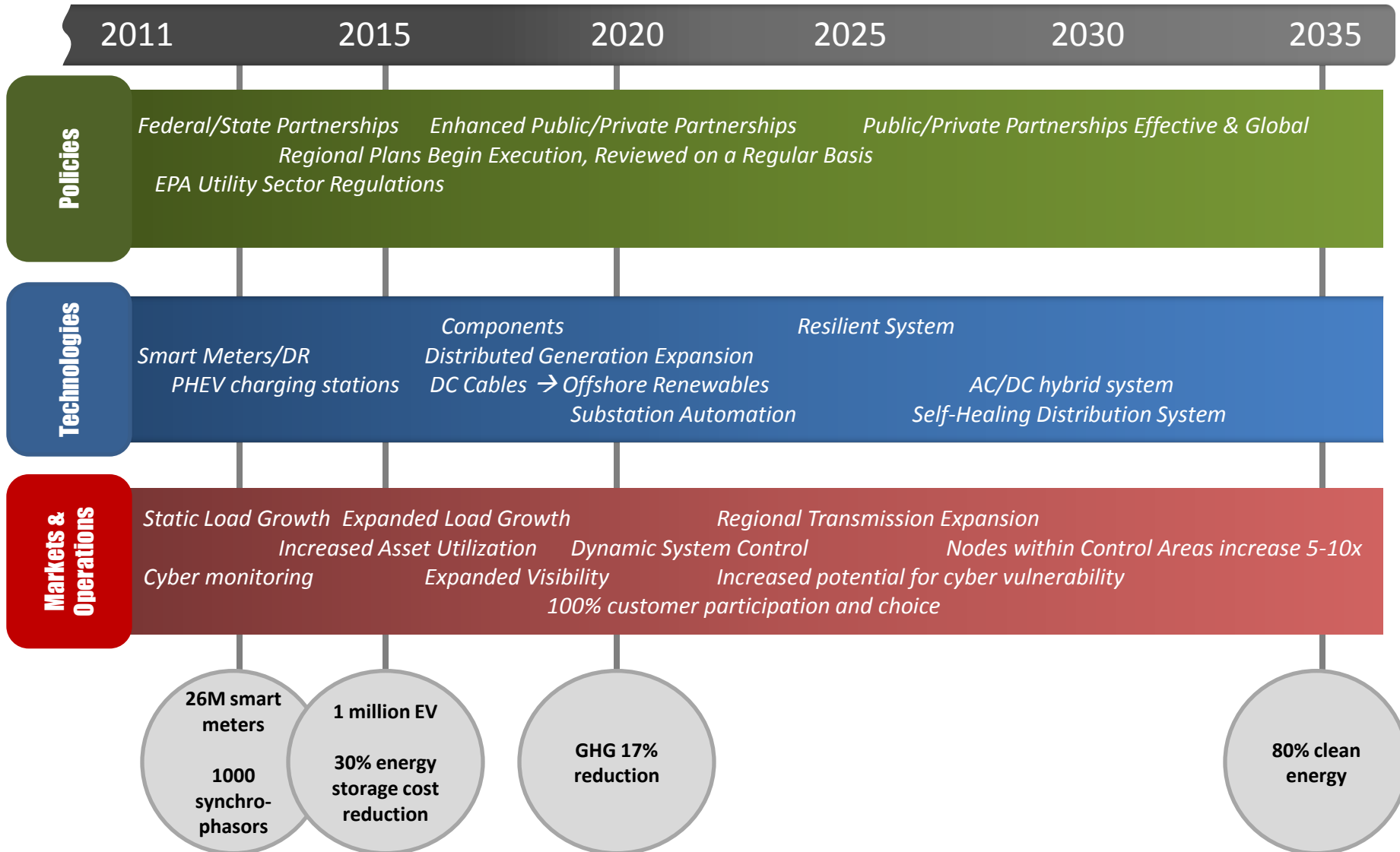

Priority Needs and Focus

Grid Tech Team Space

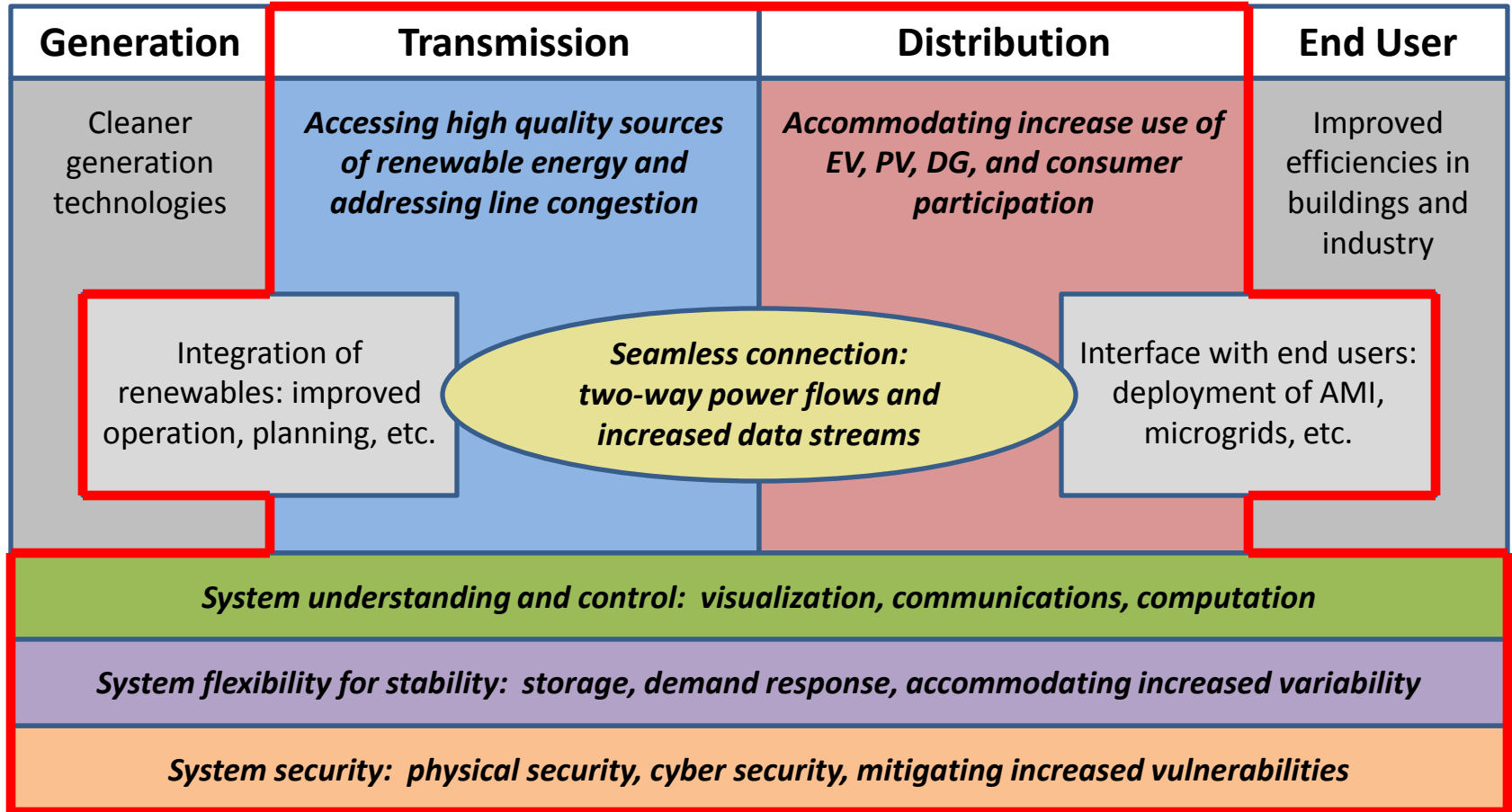

There are institutional issues/solutions that must be considered in conjunction with these technology needs

The Grid Tech Team Approach

- Let's look at what we've done
- Let's look at where we want to be
- Let's figure out how to get there, together...

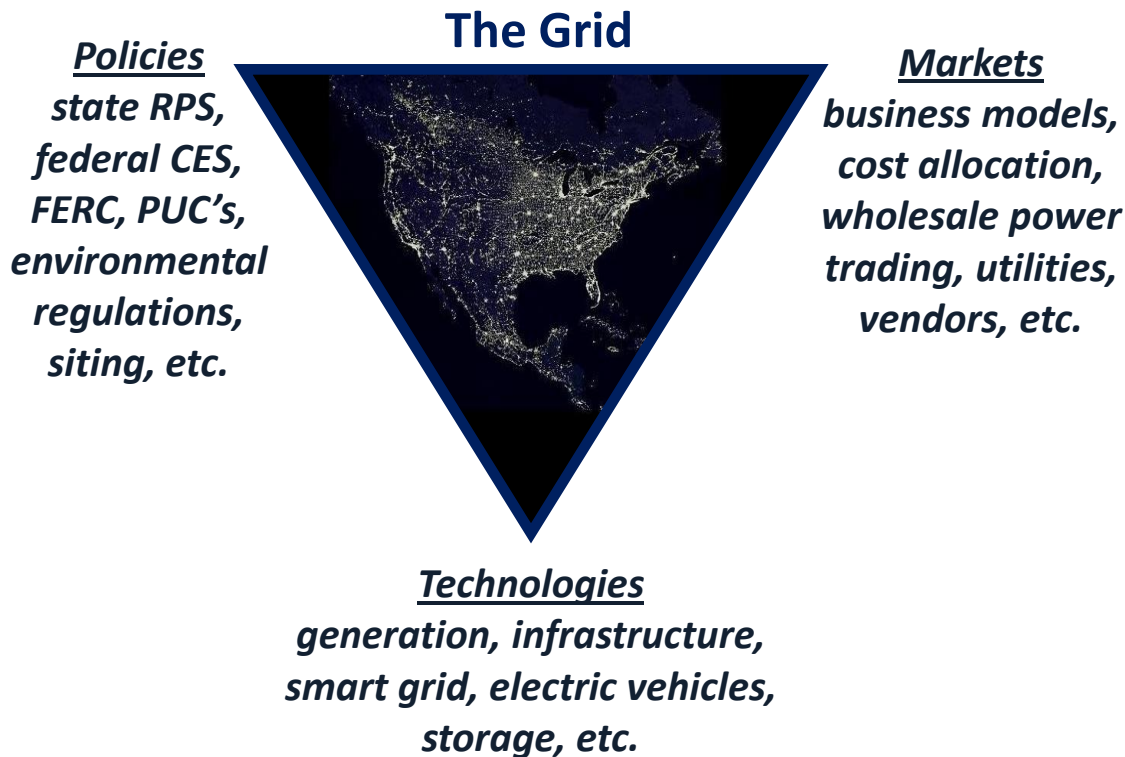

A role for DOE...

- Renewables Integration
- Smart Grid
- Advanced Modeling
- Cyber Security
- Energy Storage
- PE/Materials
- Institutional & Market Analysis

Other areas?

Renewables Integration

SC · OE · EERE · ARPA-E

What's the challenge?

- Variable renewables and their impacts on planning and operations
- Impact of renewables on the distribution system
- Delivery from resource locations to load (transmission)

Where are we today?

- U.S. penetration less than 5% of total generation, and predominantly at transmission level
- Some BAs with up to 10% capacity from variable sources; 50% at distribution
- Some European countries already at much higher penetration levels

Need for coordination?

- Regional transmission planning
- New algorithms to support advanced modeling; Dynamic analysis
- Tool development (situational awareness, forecasting, storage)
- Higher penetration integration studies
- Market design analysis

Where are we going?

- Increasing penetration rate of variable generation - 20%... 40%... 80%?
- Seamlessly integrated DG, EVs, DR
- Resource-focused planning

Renewables Integration

Overview of DOE Activities

- Integration studies
- Power system modeling tools
- Transmission utilization analysis
- Active power controls development
- Reserves analysis
- Testing and demonstration
- Codes and standards development
- Reliability impacts analysis
- Forecasting improvement

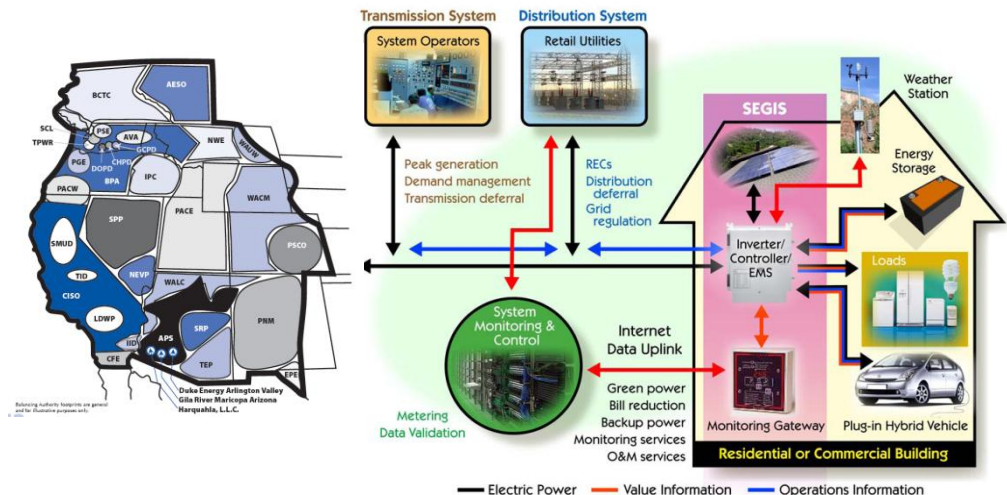
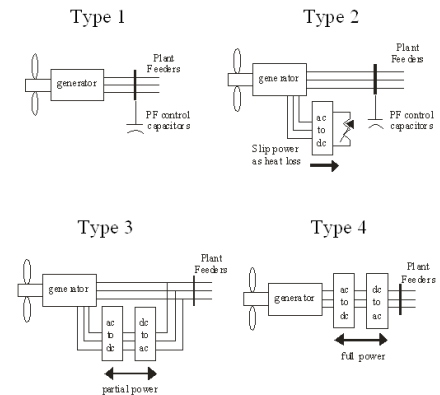
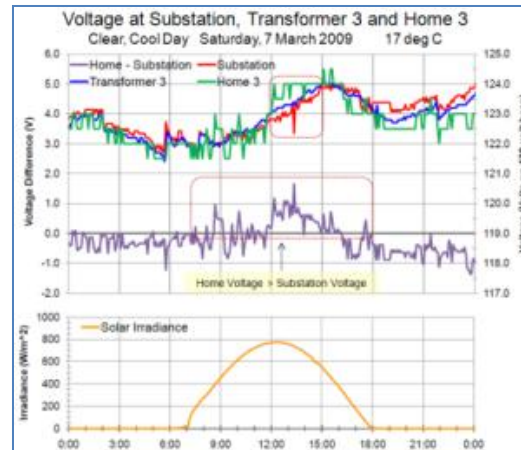

Renewables Integration

Specific Coordinated Examples

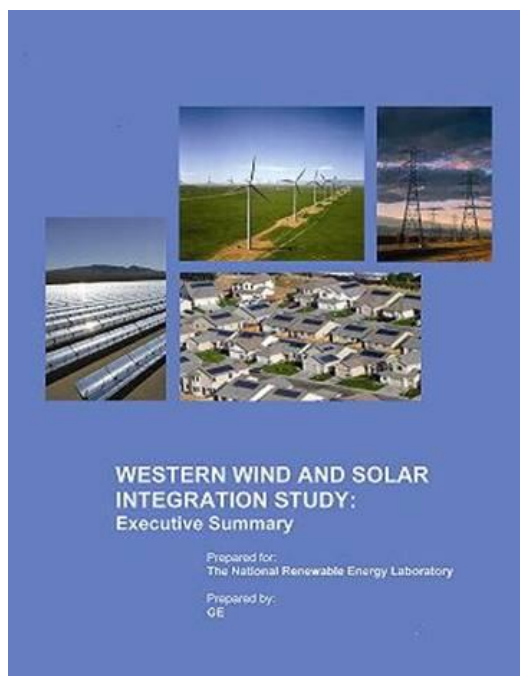

- **Western Wind and Solar Integration Study-Phase 2 (EERE, OE)**
- **Eastern Renewable Generation Integration Study (EERE, OE)**
- **Solar Energy Grid Integration Systems (SEGIS) and Solar Agile Delivery of Electrical Power Technology (ADEPT) (EERE, ARPA-E)**
- **WECC VGS Balancing Area Analysis (EERE, OE)**
- **Renewable Integration Model (RIM) development (OE, EERE)**

Renewables Integration

Future Opportunities for Coordination

Leverage GTT activities through the use of improved:

- DC converter technology
- Power system modeling
- PMU data

- Is DOE investing in the right activities to support the integration of clean energy sources into the grid?
- What gaps exist that DOE is not working on?
- How can the GTT work to better address the technical gaps that have been identified?

Smart Grid

SC · OE · EERE · ARPA-E

What's the challenge?

- Implement two way communication to inform consumers and grid operators
- Integrate PEVs, DER and DR while better managing load
- Improve electric system efficiency and reliability

Where are we today?

- Recovery Act funded SGIG, SGDP, and NIST Interoperability standards, creating large-scale demonstrations/deployments
- Increasing penetration of intermittent renewables and DR into T&D, emerging PEVs with aggressive penetration targets

Need for coordination?

- Protection coordination of multiple DER operations
- R&D in power electronics, energy storage, smart PEV charging, and system integration
- Multi-objective microgrid development
- Hybrid AC/DC structure

Where are we going?

- Distribution automation
- Expanded integration of DER/DR/PEV
- Cost-effective microgrid development
- Integrated T&D modeling and analysis
- NIST/IEEE standards implementation
- Business case development

Smart Grid

Overview of DOE Activities

- **ARRA**

- Smart Grid Investment Grant (SGIG)
- Smart Grid Demonstration Projects (SGDP)
- Workforce Training

- **Smart Grid R&D**

- Standards (NIST, IEEE)
- Technology Development
- DER Models

- **Energy Efficiency programs**

- Demand response
- Energy efficiency integration
- State Technical Assistance

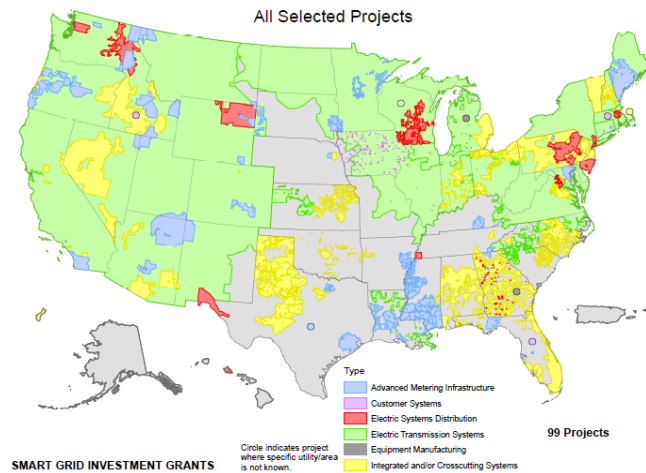
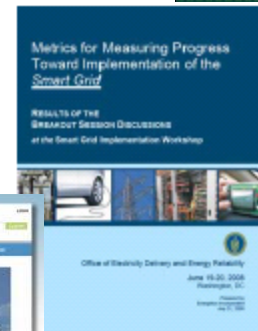
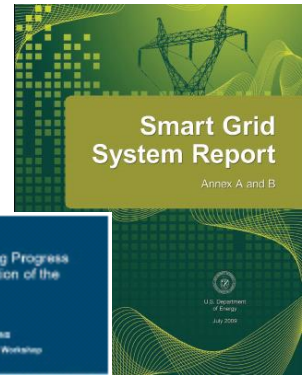

SMART GRID INVESTMENT GRANTS

Smart Grid

Specific Coordinated Examples

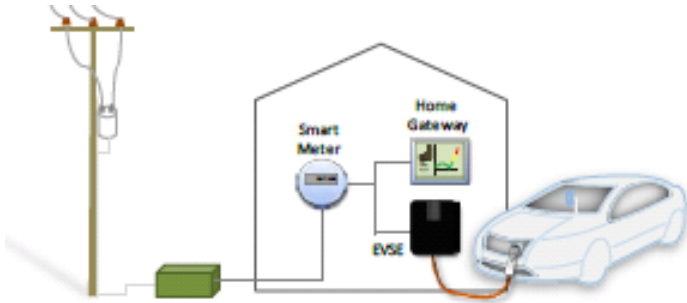
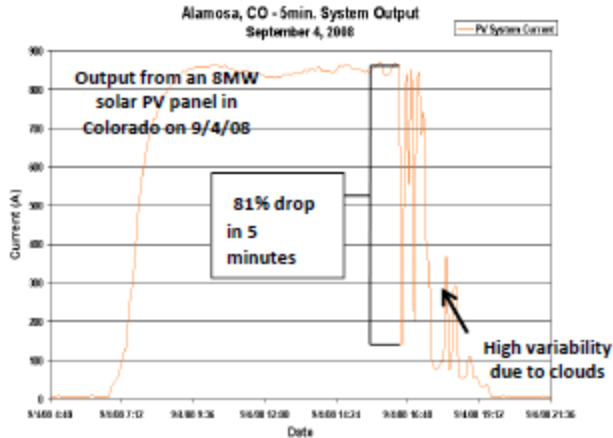

- **Smart Grid Task Force**, a federal task force coordinating SG activities (EERE, OE)
- **Western Renewable Energy Zones** initiative, integration of renewables modeling (EERE, OE)
- **Grid Interaction Tech Team***, which coordinates PEV adoption through public-private partnerships (EERE, OE)
- **Consumer Engagement**, participation of building/industrial loads in ancillary services (EERE, OE)
- **GRIDS, ADEPT, GENI** (ARPA-E, OE)

* The Grid Interaction Tech Team (GITT) addresses connectivity between light duty plug-in vehicles, the charging infrastructure and the electric power grid

Smart Grid

Future Opportunities for Coordination

- ❑ **Support Technologies:** Develop and bring to market power electronics and energy storage for smart grid applications
- ❑ **Standards:** Set and evaluate cyber and integration standards
- ❑ **PEVs:** Develop, demonstrate and deploy smart charging of PEVs
- ❑ **Pilots:** Develop and pilot the future grid concepts
- ❑ **Planning/Development:** Develop and demonstrate smart energy communities or cities, with integration of grid, water, transportation, building, and sustainable fuel infrastructures

- How can DOE leverage its current work to move smart grid forward?
- What research is needed to advance smart grid?
- How can the GTT work to better coordinate smart grid research and development?
- Where are the gaps that require coordination within DOE?

Advanced Modeling

SC · OE · EERE · ARPA-E

What's the challenge?

- Future generation resource mix unknown and load profiles uncertain
- Breadth and depth of “smart grid” data (data overwhelm); vulnerabilities continually emerging
- Boundary seams (planning, modeling, and operations) critical for effective integration with legacy systems

Where are we today?

- Real-time system monitoring by operators is supported by offline engineering analysis (high latency)
- Operator trying to make control decisions, especially quickly during a disturbance, based on incomplete data
- Inconsistencies in planning and operations assumptions/models

Need for coordination?

- Strategic modeling approach for the holistic understanding and design of a complex system of grid systems
- New algorithms, techniques, and computational approaches
- Validation and verification of tools, techniques and models on actual power system problems (and data)

Where are we going?

- New models, planning, and operational tools that are well integrated and used by industry for real-time system control
- Improved flexibility and reliability through better system understanding
- Address a variety of market structures; increased engagement (services and roles)

Advanced Modeling

Overview of DOE Activities



- **Basic Research**
 - multi-scale modeling, optimization, stochastic simulations, uncertainty quantification, large-scale data analysis and data management, and visualization
- **Transformational energy research**
 - innovative control software and control architectures
- **Applied research**
 - accelerate performance and enhance predictability of power systems operational tools; development of new software platforms and capabilities using time-synchronized data, e.g. phasors; reliability modeling in support of regional and interconnection planning
 - development of non-proprietary models of wind generators and inverter technologies for use in transmission planning/interconnection studies
 - use of stochastic simulations for generation dispatch

Advanced Modeling

Specific Coordinated Examples

- **Improved Power System Operations Using Advanced Stochastic Optimization**
 - Parallel algorithms and software for solving stochastic optimization problems (SC)
 - New commitment/dispatch/ pricing formulation and models that uses probabilistic inputs to account for uncertainty (ARPA-E, SC, OE)
 - Real-time tools and platforms for balancing demand-side flexibility and supply-side variability (OE, EERE, ARPA-E)
 - Renewable integration model (RIM) for multi-timescale power-flow analysis (OE, EERE)
- **Fusing Models and Data for a Dynamic Paradigm of Power Grid Operations**
 - Calibrated real-time dynamic model (SC)
 - Look-ahead dynamic simulation (OE)
 - Dynamic contingency analysis (OE, ARPA-E)

- **Exploring Power Systems Models using Nonlinear Optimization Techniques**
 - New toolkit for solving nonlinear optimization problems (SC)
 - Modular suite of test problems using either DC or AC (linear or nonlinear) transmission models (OE)
 - Explore effect of AC & DC models for transmission switching (OE, ARPA-E)

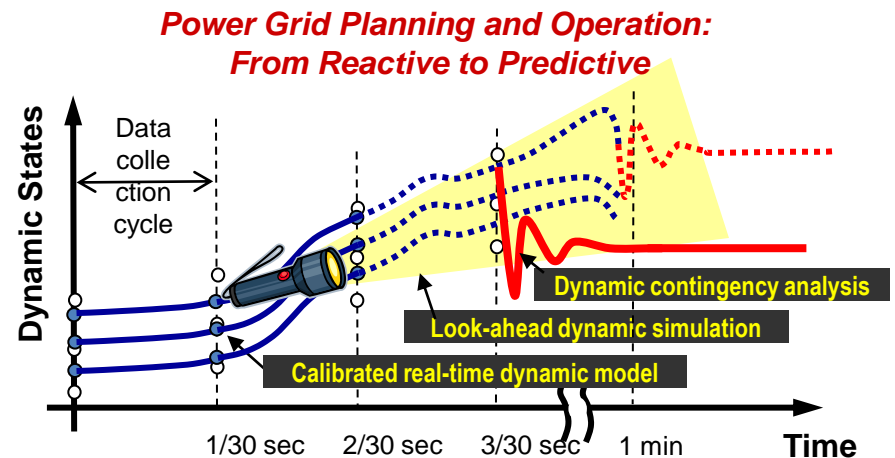

Advanced Modeling

Future Opportunities for Coordination

- ❑ **Accelerate Performance:** improving grid resilience to fast time scale phenomena that drive cascading network failures and blackouts
- ❑ **Enable Predictive Capability:** real-time measurements and improved models to represent the operational attributes of the electric system, enabling better prediction of system behavior and thus reducing margins and equipment redundancies needed to cover uncertainties
- ❑ **Integrate Modeling Platforms (across the system):** capturing the interactions and interdependencies that will allow development (and validation) of new control techniques and technologies

- What characteristics are necessary for new model (or operator tool) development for the future electric grid?
- How can this community work together to facilitate the availability of data for model validation and verification?
- How do we foster a community of mathematic, computational, and power systems expertise to address these technical challenges?

Cyber Security

S1 · OE

What's the challenge?

- Reliable energy delivery depends on cyber-security in the modernized energy sector's complex communication architectures that transmit real-time data and information for operations
- Increasingly sophisticated cyber-threats directly target the energy sector

Where are we today?

- Cyber-resilience of energy delivery systems varies across the Nation
- Some entities have sophisticated capabilities to detect, prevent and respond to cyber-incidents
- Some entities are at the beginning stages of establishing cyber-resilience

Need for coordination?

- All energy sector stakeholders, public and private sector, must actively engage
- Accelerate frontier cyber-research into real-world energy sector operations
- Stay ahead of emerging threats, vulnerabilities and consequences
- Interoperable cyber security standards

Where are we going?

- Resilient energy delivery systems are designed, installed, operated and maintained to survive a cyber incident while sustaining critical functions.

Cyber Security

Overview of DOE Activities

ROADMAP STRATEGY

- **Build a Culture of Security**
 - Cyber security practices are reflexive and expected among all energy sector stakeholders
- **Assess and Monitor Risk**
 - Continuous security state monitoring of all energy delivery system architecture levels and across cyber-physical domains is widely adopted by energy sector asset owners and operators
- **Develop and Implement New Protective Measures to Reduce Risk**
 - Next-generation energy delivery system architectures provide “defense in depth” and employ components that are interoperable, extensible, and able to continue operating in a degraded condition during a cyber incident
- **Manage Incidents**
 - Energy sector stakeholders are able to mitigate a cyber incident as it unfolds, quickly return to normal operations, and derive lessons learned from incidents and changes in the energy delivery systems environment
- **Sustain Security Improvements**
 - Collaboration between industry, academia, and government maintains cybersecurity advances

Cyber Security

Future Opportunities for Coordination

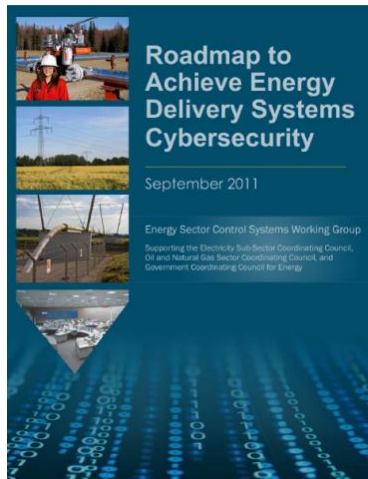

- ❑ Energy Sector's synthesis of critical control system security challenges, R&D needs, and implementation milestones
- ❑ Provides strategic framework to
 - align activities to sector needs
 - coordinate public and private programs; success requires partnership from the start
 - stimulate investments in control systems security

- How can communication (and collaboration) amongst energy sector stakeholders be improved?
- What are some innovative approaches to partnerships? Do the nature of the partnerships (or stakeholders themselves) change as the power system evolves?
- This is a continually evolving activity that does not need to be reactive; how can we position ourselves to anticipate and protect?

Energy Storage

SC · OE · EERE · ARPA-E

What's the challenge?

- Costs of energy storage systems
 - Cost/Benefit ratio too low
- Lack of data for projects
 - Questions about reliability
- Utilities are generally conservative
- Regulatory treatment of energy storage

Where are we today?

- Energy storage is utilized in the grid primarily for diurnal energy storage (primarily pumped hydroelectric plants)
- 16 ARRA demonstration projects
- New technology being developed – advanced batteries, flow batteries, flywheels

Need for coordination?

- Building effective public–private partnerships to achieve RD&D goals
- Complementary approaches needed to accelerate breakthroughs
 - Basic electrochemistry
 - Device development
 - Bench and field testing of systems

Where are we going?

- Reduce grid storage costs 30% by 2015
- Develop multiple commercial technologies for multiple applications
- Develop new materials and technologies to revolutionize energy storage
- Develop value proposition for storage applications

Energy Storage

Overview of DOE Activities

- **Research**

- Create the next generation of storage technology options based on advanced and nano-formed materials

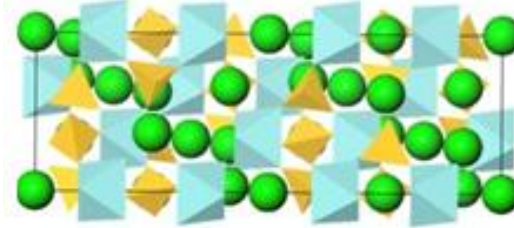

- **Demonstration/Deployment**

- Test and demonstrate Energy Storage system technologies



- **System Analysis**

- Model and simulate energy storage systems to guide development and deployment

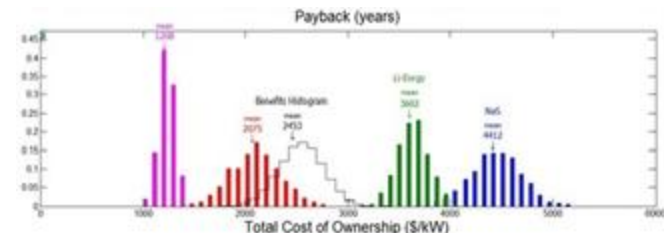

Energy Storage

Specific Coordinated Examples

- **A123 Systems' nano-structured cathode material for battery applications**
 - Office of Science sponsored basic research
 - BES SBIR grant
 - EERE grant
 - OE-supported demonstration project
- **Evaluation of storage to complement renewable generation**
 - Grid Level Integration (OE)
 - Residential PV (EERE)
- **Development of new energy storage technology prototype device**
 - High-risk investments (ARPA-E)
 - Testing & device development (OE)
- **Economic analysis**
 - Grid Benefits (OE)
 - Wind Integration (EERE)
- **Joint Peer Reviews (OE, ARPA-E, SC)**
- **Working with private companies & universities to increase performance (OE, ARPA-E)**
 - ARPA-E working with Boeing on development of alternative low-cost material to reduce overall flywheel system cost
 - CRADA with East Penn Mfg. to establish mechanisms of PbC battery performance enhancement
- **BES exploration of new electrochemical processes & concepts; fundamental materials research (SC)**
- **Deployment projects (ARPA-E, OE, EERE)**
 - PNM Prosperity Energy Storage Project – Integrated PV + PbC Storage
 - Analysis of storage and renewable on the grid

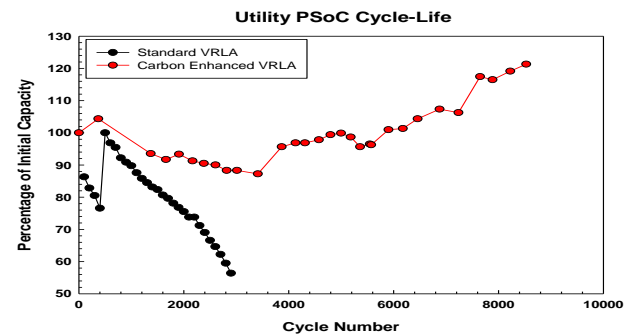
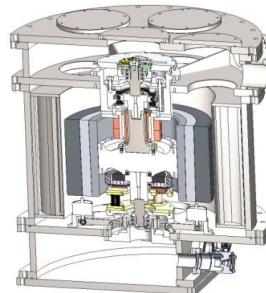

Energy Storage

Future Opportunities for Coordination

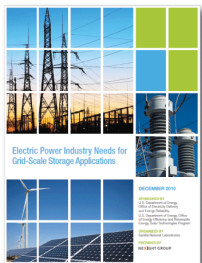

Utility Needs

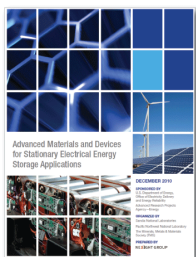

Materials Requirements

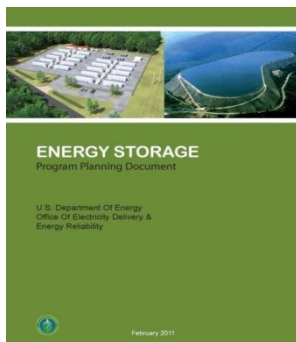

Storage Program Plan

- Collaborate with SBIR, EFRCs, and through university solicitations, to mine sources of new ideas
- Initiate efforts in discovering new materials and chemistries to lead new energy storage technologies
- Analyze current demonstration projects
- Deploy new demonstration projects
- Assess new, promising technologies
- Scale up production capacity
- Battery/Storage Hub
- Grid/Storage Analytical Studies

- What analysis should we do to support industry?
- What balance of research, device development, and field testing is appropriate?
- How can we work more closely with industry to bring energy storage to deployment?

Power Electronics/Materials

SC · OE · EERE · ARPA-E

What's the challenge?

- Increased need for energy conversion and power flow control
- Capabilities for efficient, long-distance or off-shore energy transfers
- Materials, devices, and systems that can handle high power and extreme operating conditions

Where are we today?

- Use of HVDC and FACTS devices is very expensive
- The material backbone of the electricity delivery system hasn't changed
- R&D in wide band gap semiconductors have shown improved performance over silicon

Need for coordination?

- Understanding fundamental material properties and novel functionalities
- Reducing the costs of wide band gap semiconductors and the associated devices and systems
- Identifying new applications for novel materials

Where are we going?

- High-performance, cost-effective power electronic systems
- Materials for self-healing, embedded sensing, and dynamic reconfigurations
- Enhanced material properties for insulators, conductors, magnetics, etc.

Power Electronics/Materials

Overview of DOE Activities

- **Use-Inspired Basic Materials Research**

- Wide band gap semiconductors
- Insulators for power cables
- New materials and composites for conductors
- Simulations and defect analyses

- **Applied Materials Research**

- Aluminum conductor composite reinforced overhead cables
- Advanced solid-state (SiC, GaN) switches for power electronics applications
- Next-gen magnetics and conductors for improved generators and electric motors

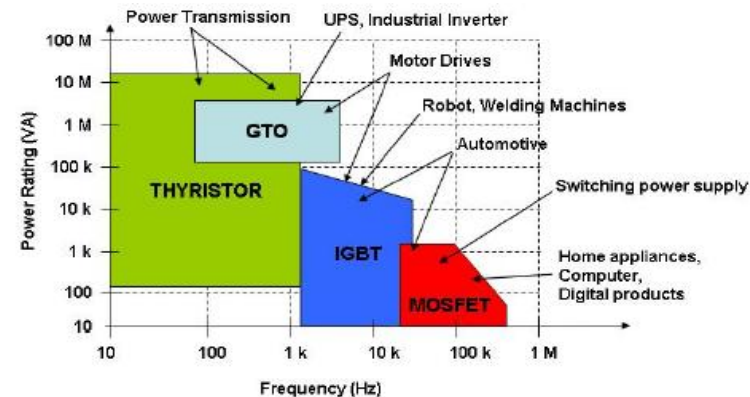
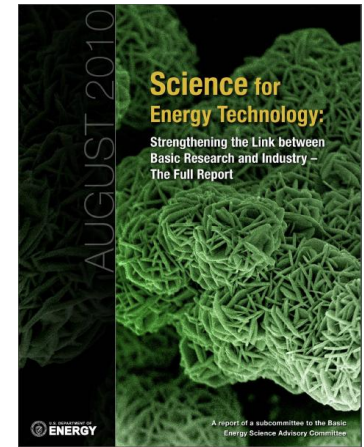
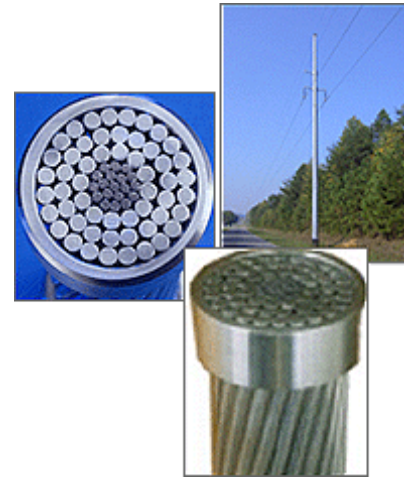

Power Electronics/Materials

Specific Coordinated Examples



- **High Temperature Superconductors (HTS)**
 - Basic materials research (SC)
 - Development of HTS underground cables (OE, SC)
 - Field testing (OE)
- **Inverters for grid applications**
 - Solar BOS cost reduction (ARPA-E, EERE)
 - EV charging (EERE)
 - Power electronic devices R&D (OE, ARPA-E)
- **Transformative Technologies**
 - Joint GENI peer-review (SC, OE, ARPA-E, EERE)

Power Electronics/Materials

Future Opportunities for Coordination

- ❑ Enhance public-private partnerships for the development of:
 - Solid state transformers and cost-effective power converters
 - HVDC circuit breakers
 - Next generation cables and conductors
 - Advanced materials with self-healing for improved resiliency and embedded sensing
- ❑ Demonstration, testing, and analysis of new technologies and material properties

- How will planning and operations change if HVDC and FACTS devices become significantly cheaper?
- Will power electronics be a critical asset to manage a more asynchronous grid with higher penetrations of variable renewables?
- What functionalities or material properties are desired for the future grid?
- How can DOE better connect the applied offices with the Office of Science?

Institutional & Market Analysis

S1 · OE · EERE · SC

What's the challenge?

- Existing markets, business models, and institutions need to evolve to meet needs raised by new and emerging technologies
- Additional and ongoing coordination needed among government agencies and stakeholders at many geographic levels

Where are we today?

- Increasing focus on collaborative regional and interconnection-wide planning
- Improved coordination among Federal agencies for renewables development and transmission expansion

Need for coordination?

- Federal and state agencies, NGOs need to participate in grid planning
- Regional cooperation on resource development, market issues and transmission expansion
- Grid operations will require even more intensive coordination in near-real-time

Where are we going?

- Seamless, reliable, and efficient markets that allow for interstate transmission, access to distant generation resources, and also allow participation by DG, DR, storage, and other non-traditional technologies
- Increased stakeholder outreach

Institutional & Market Analysis

Overview of Key DOE Activities

- **Support for States and Regions:** interconnection planning, grants, partnerships
- **Expand Transmission:**
 - leverage PMA’s transmission networks through support for selected new projects
 - improve federal process for review of pending projects (Interagency Rapid Response Team /Transmission)
- **Analyses:** identify needed infrastructure in the U.S.; identify high-impact transmission expansion opportunities within PMA footprints; triennial congestion studies; state of electricity markets

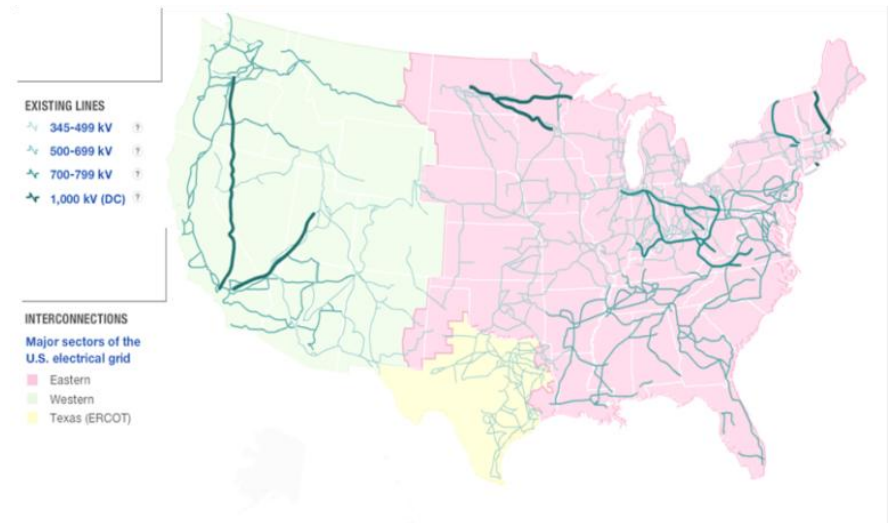

Institutional & Market Analysis

Specific Examples of Coordinated Efforts

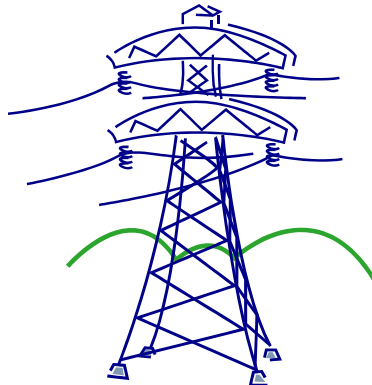
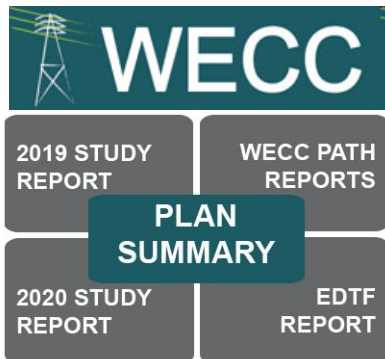

- **Interagency Rapid Response Team for Transmission** (S1, OE, EERE, other federal agencies)
- **State Energy Efficiency Action Network** (OE, EERE)
- **Hawaii Clean Energy Initiative** (OE, EERE)
- **Siting on Federal and Tribal Lands** (OE, EERE, S1)
- **Interconnection-Wide Transmission Planning** (OE, EERE, S1, other federal agencies)
- **Transmission Reliability Program** (OE, SC)

Institutional & Market Analysis

Future Opportunities for Coordination

- ❑ **Planning and Coordination:** Seek maximum benefits from FERC Order 1000, which requires regional and subregional groups to do open and collaborative long-term grid planning. Planners must take into account non-wires alternatives, state/local policies, and consult with neighboring planners about new lines crossing shared borders. Strong participation by states, federal agencies, and NGOs will be crucial to success.
- ❑ **Analyses and Tools:** assess new markets, business models, revenue streams, and policies; support development of new analytic techniques and tools; evaluate balance of AC and DC within T&D; quantify T&D investments and benefits
- ❑ **Education and Outreach:** expanded technical assistance to States and other stakeholders on market implications, regulations, and operations

- What institutional barriers and issues will be most critical as new grid technologies emerge and transform grid operations?
- What roles should DOE take on to address these barriers and through what mechanisms?

Grid Tech Team Actions

- Continue the dialogue towards a National Public-Private Vision of the Future Grid
 - *November 2011*: Grid Tech Team vetting meeting
 - *December 2011*: PSERC meeting
 - *January 2012*: Webinar (tentative)
 - *February 2012*: National Electricity Forum meeting
- Follow-up Discussion - mechanism?
- Next Steps:
 - Develop National Vision document
 - Develop Strategy for Coordinated DOE Grid Activities/Priorities

The Grid Tech Team

Lauren Azar (S1) ♦ Gilbert Bindewald (OE) ♦ Charlton Clark (EERE) ♦ James Davenport (SC) ♦ Jennifer Downes-Angus (CFO) ♦ Imre Gyuk (OE) ♦ Mark Johnson (ARPA-E) ♦ Sandy Landsberg (SC) ♦ Kevin Lynn (EERE) ♦ David Meyer (OE) ♦ William Parks (OE) ♦ Rajeev Ram (ARPA-E)

The Future Grid

what should it look like

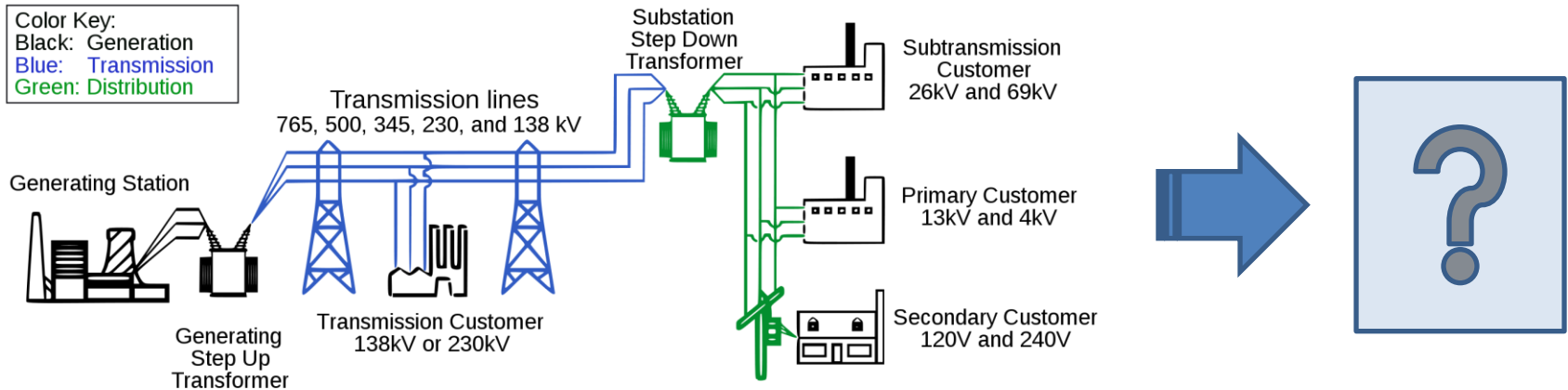

It should be capable of:

- Enabling informed participation of customers
- Accommodating all generation and storage options
- Enabling new products, services, and markets
- Providing the power quality for a range of needs
- Optimizing asset utilization and operating efficiency
- Providing resiliency to disturbances, attacks, and natural disasters

How do we get there?

- Grid components and subcomponents
- Materials innovations
- System integration and distributed technologies
- Grid energy storage and demand response
- Analysis, standards and model development
- Planning, Policy and other non-technical support (e.g., markets, regulations, environmental considerations)

What's the role of industry?